

209-090

DGUV Information 209-090

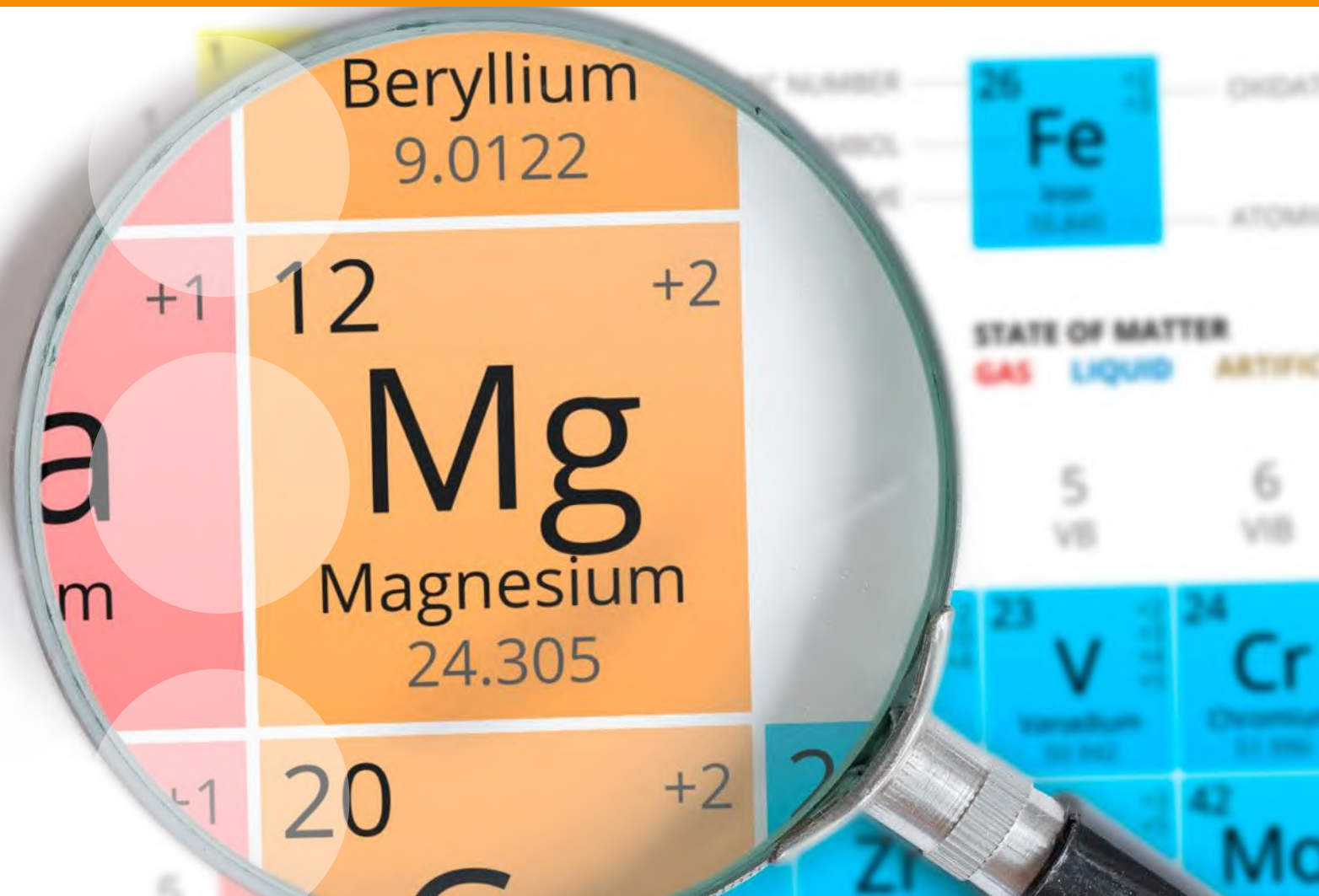

Activities relating to Magnesium

kommmit**mensch** is the national campaign of the German Social Accident Insurance (DGUV).
Its purpose is to support companies and educational institutions in developing a culture of prevention in which all action is underpinned by safety and health. Further information at www.kommmitmensch.de

Legal information

Published by:

Deutsche Gesetzliche
Unfallversicherung e.V. (DGUV)

Glinkastraße 40
10117 Berlin
Telefon: +49 30 13001-0 (switchboard)
Fax: +49 30 13001-9876
E-mail: info@dguv.de
Internet: www.dguv.de

Subcommittee Machinery, Robotics and Automation of Expert Committee
Woodworking and Metalworking of DGUV

Date of issue: June 2020

The present DGUV Information is the translation of the German edition
(issued June 2018). No liability is accepted for translation errors.

DGUV Information 209-090

Obtainable from: your accident insurance institution or at
www.dguv.de/publikationen

Activities relating to Magnesium

Contents and keywords

	page		page
Introduction	5	Annex 1	
		Checklists for instruction topics for activities relating to magnesium	41
1 Magnesium-related hazards	6	Annex 2	
1.1 Chips	6	Operating instructions	44
1.2 Dust	7	Annex 3	
1.3 Sludge	7	Cleaning and maintenance schedules	52
1.4 Molten metals	7	Annex 4	
1.5 Blasting	8	Bibliography	53
1.6 Casting	9	Picture credits	55
1.6.1 Sand casting	9		
1.6.2 Die casting	9		
2 Processes and protective measures	10		
2.1 Metal cutting machines: machine tools (e. g. machining centres, turning, milling, drilling and grinding machines)	10		
2.1.1 Dry processing, single-part production (except for grinding machines)	10		
2.1.2 Dry processing in serial production and grinding, brushing, polishing	10		
2.1.3 Machining with water-miscible metalworking fluids	12		
2.1.4 Machining with non water-miscible MWF	14		
2.1.4.1 Conventional wet processing	14		
2.1.4.2 Minimum quantity lubrication (MQL)	17		
2.1.5 Machining with hand-held grinding machines	19		
2.2 Molten metals	20		
2.3 Die casting	25		
2.4 Sand casting	26		
2.5 Further casting processes	27		
2.6 Blasting	27		
3 Personal protective equipment/ work clothes	29		
4 Instruction	33		
5 Fire protection and First Aid	34		
6 Storage of magnesium chips and magnesium residues	36		
7 Operating instructions	38		
8 Identification of applied substances and magnesium	39		

Introduction

Magnesium components are mainly used in the lightweight construction, e. g. in the automotive industry. The advantages of magnesium which are characterized by its low specific density are of particular relevance in this sector. Activities relating to magnesium, however, include significant fire and explosion hazards which require the provision of adequate protective measures.

The present DGUV Information is addressed to employers who produce or machine magnesium components. It describes protective measures against fire and explosion hazards and provides guidance for the use of suitable personal protective equipment.

Furthermore, it supports employers in the required coordination with the manufacturer when purchasing machines for machining magnesium materials or magnesium alloys with a magnesium content of > 80 wt % (weight percent) (see DIN EN 12421 and EN 1753).

This brochure provides guidance which can also be taken into account by the manufacturer when placing a machine

on the market in order to meet the requirements of the Machinery Directive in terms of fire and explosion protection (see MD Annex 1 No. 1.5.6 and 1.5.7). For the time being, there is no specific standard available which is applicable to machines intended for the machining of magnesium materials.

The products mentioned and shown in the present DGUV Information are merely examples. Their citation in this DGUV Information does not represent a recommendation. Other suitable products are available on the market as well.

1 Magnesium-related hazards

Magnesium has the property to oxidize with atmospheric oxygen. Oxidation is an exothermic chemical process, i. e. a reaction which releases heat.



Figure 1 Burning magnesium residues

1.1 Chips

Magnesium chips are produced during metal cutting with geometrically defined cutting edges including their dust fragments.

Particles of a mean diameter of $> 500 \mu\text{m}$ are referred to as chips. These particles are not considered to be explosive when whirled up.

Magnesium flash consists of fine magnesium plates generated during die casting.

Chips are produced during dry processing of magnesium workpieces. They may ignite at high temperatures or due to friction heat.

During metal-cutting machining with water-miscible metalworking fluids (wet processing), hydrogen generation may lead to oxyhydrogen gas. In the presence of an ignition source (e. g. sparks), a hazard of explosion arises. Water-miscible metalworking fluids easily react with magnesium due to their “alkaline (basic)” properties (frequently pH value ~ 9), thereby forming hydrogen.



Figure 2 Residues from dry processing (magnesium dusts and chips)

Chips that are wetted with water-miscible metalworking fluids also tend to self-ignite. This may result in a fire or, in the worst case, in an explosion.

During metal-cutting machining with nonwater-miscible metalworking fluids (neat cutting oils), high temperatures at the machining point may cause an oil fire. The hazard is particularly high if an insufficient quantity of MWF is supplied.

A strong atomization of the metalworking fluid may result in a flashover and a subsequent fire due to oil mist formation.

As a result of the oil fire, the magnesium chips or residues may be in danger to be ignited.

1.2 Dust

If large quantities of magnesium dusts are generated during machining (e. g. during grinding), fire and, in addition, a dust explosion have to be expected. A fire develops if accumulated dust ignites. Even if low quantities of whirled up dusts ignite, an explosion hazard is caused. Particles with a mean diameter of $< 500 \mu\text{m}$ are referred to as dust. These particles are considered to be explosive when being whirled up.

The dust particles constitute a large surface. Even a reaction with the water in the humid air may release such an amount of hydrogen that an explosive mixture develops.

If work clothes are soiled by magnesium dust or magnesium chips, employees are exposed to an increased fire hazard.

1.3 Sludge

Magnesium sludge consists of magnesium dusts or particles bound with water or hydrous wetting agents.

Sludge which is generated during machining with water-miscible metalworking fluids (e. g. during grinding), tend to self-ignite due to the low particle size. On reaction with water, gaseous hydrogen is generated in addition and an explosive mixture may develop. The same applies to watery sludge which is generated during wet separation, e. g. during blasting work.

Fine magnesium particles particularly tend to self-heat on reaction with water/humidity. This exothermic reaction releases heat which can finally lead to self-ignition. In practice, violent reactions including fires and oxyhydrogen explosions mainly occur during storage of large sludge quantities in barrels and tippers.

Even fine magnesium particles which have been separated, e. g. through filter fleece, can provoke self-ignition in conjunction with humidity/water.

1.4 Molten metals

Molten magnesium burns at the surface in the presence of atmospheric oxygen.

This is prevented by covering the molten bath surface with protective gas. Depending on the protective gas used, different hazards may result.

The concurrence of molten metal and humidity leads to an increase of the water volume due to the high temperatures. The generated water vapour induces a strong pressure increase and the ejection of the molten metal. As a consequence, the metal ignites at very high temperatures (up to $3000 \text{ }^\circ\text{C}$) which causes a "thermolysis" of the water, i. e. a split-up into hydrogen and oxygen. Due to the subsequent oxyhydrogen reaction, an explosion takes place.

During the melting process, a granular slag is formed on the surface of the molten magnesium. It is also called dross and consists of oxidized metal residues. The dross mainly deposits on the molten bath surface, but also in

the floor area and at the crucible walls. During the skimming of dross, the magnesium residues adhering to the dross may ignite when coming into contact with air and emit smoke (magnesium oxide).

The dross removed during the skimming of the magnesium baths tends to violent reactions in conjunction with water. If the dross has been quenched with salt after skimming, it is especially important that it does not come into contact with water when cooled down. Otherwise, heating up to self-ignition might occur.

When opening the crucible covers, caking of dross or rust/scale might drop from the crucible wall into the molten metal. This might produce a thermite reaction, leading to possible explosions.

The dross deposits at the crucible walls and in the floor area have an isolating effect. In conjunction with the heating rods on the outside of the crucible, local thermal overheating may occur with the consequence of a crucible rupture.

When pulling temperature sensors, stirring motors, metal pumps, pouring containers etc. out of the molten metal, a high fire risk with smoke generation arises. This is due to the adhering molten magnesium which starts to burn as soon as it comes into contact with atmospheric oxygen.



Figure 3 Thermolysis reaction of water (approx. 50 ml) added to molten magnesium

1.5 Blasting

The dust particles which are generated during blasting constitute a large surface area and may lead to a fire hazard and the formation of a hazardous explosive atmosphere. A fire occurs if deposited dust ignites. The ignition of even small quantities of whirled up dust causes an explosion hazard.

Due to the high explosion risk and the simultaneous occurrence of ignition sources during machining, the generated dusts are usually led to a wet scrubber and separated. This induces a reaction of magnesium particles with water and the formation of such an amount of hydrogen gas that an explosive mixture may develop.

led to accidents with burns to the operating personnel. Furthermore, reactions with moisture and atmospheric oxygen led to fires which damaged system parts (e. g. hydraulic hoses, electric lines).

Due to hairline cracks in the die parts or defective cooling hoses, cooling water may enter into the closed die. As a result of the “shot”, the liquid magnesium is abruptly brought into contact with water which inevitably leads to a violent explosion.

Flash with a large surface is highly flammable and, on contact with moisture (e. g. water based release agents), may lead to fire or even to hydrogen generation including explosion hazards.

1.6 Casting

1.6.1 Sand casting

Moisture in the sand, the core or the coating may lead to an abrupt vaporization of water due to the heat of the molten metal. As a result of this physical explosion, molten magnesium may be ejected.

If the mold is insufficiently degased, (inadequate arrangement of risers or improper feeder) a sudden ejection of molten metal (thermal stroke) is possible.

1.6.2 Die casting

Material deposits at the die halves in the form of thin flash consist of emerged cooled down magnesium alloy. It can be found at the closing edges of the die and the workpiece. These cavings/cast iron residues may lead to leakiness of the die (see DGUV Rule 109-608 “Branche Gießereien”, Clause 3.14 “Gießbetrieb Druckgießerei”).

The thin flash (e. g. in the deburring area) represents an increased fire load due to the large surface and high flammability.

The unexpected ejection of liquid magnesium as a result of material deposits (e. g. at the closing edges of the die halves or in the area of the filling chamber has already

2 Processes and protective measures

This clause describes specific protective measures for the individual processes and machines. Metal cutting machines are divided into machines with a geometrically defined cutting edge (e. g. lathes) and machines with a geometrically undefined cutting edge (e. g. grinding machines). In addition, a distinction is made between single-part production and series production due to the different framework conditions.

2.1 Metal cutting machines: machine tools (e. g. machining centres, turning, milling, drilling and grinding machines)

2.1.1 Dry processing, single-part production (except for grinding machines)

During dry processing in single-part production, highly flammable chips have to be considered as a significant hazard.

The chips must be easy to remove in order to keep the fire load low in the machine area. Provisions for chip removal have to be specified in the cleaning schedule. Machining centres have to be thoroughly cleaned from other materials (especially ferrous materials) before machining.

Blowing off the chips in the interior of the machine by a compressed air pistol is generally not permitted due to the danger of whirling up the chips and must therefore be avoided.

The machine area and the surroundings of the machine have to be kept dry.

Ignition sources in the work area must be avoided. For this reason, for example tools are also checked for their condition and especially for wear. Furthermore, the working area has to be kept free from further ignition sources and marked with the prohibition sign P003 (no open flame; fire, open ignition source and smoking prohibited – source: ASR A1.3). The prohibition of open flames, fire, open ignition source and smoking must be implemented (safety marking according to ASR A1.3)

2.1.2 Dry processing in serial production and grinding, brushing, polishing

During dry processing in serial production as well as during **grinding, brushing and polishing** of magnesium components, dusts may, in addition to the chips, increasingly occur as significant hazard (hazard of a dust explosion).

The protective measures for dry processing in single-piece production apply to series production as well.

Besides the above mentioned measures, the following additional measures are required due to the generated dusts.

- The dusts must be easy to remove so that no larger quantities can accumulate in the machine area. Provisions for dust and chip removal have to be specified in the cleaning schedule.
- Generally, chips and dusts as well as magnesium waste have to be removed from the working area as fast as possible. For this reason, the (rather small) chip containers have to be cleaned regularly.



Figure 4 Burning magnesium in the chip container

- Removing dust from the interior of the machine by blowing off with a compressed air pistol has to be excluded due to the danger of whirling up the dusts. Cleaning the work clothes from dusts with compressed air must be prohibited. (TRGS 500).

Extractions, extraction systems as well as vacuum cleaners for cleaning have to be suitable and approved for magnesium dust with regard to fire and explosion hazards. (see clause “intended use” in the operating instructions of the relevant products).

This applies in particular to the

- flow rate (min 20 m/s),
- monitoring of the minimum air-flow rate,
- prevention of dust deposits,
- capture of dusts.

Generally, all systems, e. g. for grinding and brushing magnesium, are extracted via wet scrubbers. The extracted air flow is permanently running during machining and is monitored (flow rate: $v > 20$ m/s). The wet scrubber is equipped with vents so that unavoidably generated hydrogen can escape and cannot accumulate.

A continuous potential equalization (earthing from the grinding booth up to the wet scrubber including lightning protection according to EN 60204-1) is another precondition.

Depending on the risk assessment, in practice, e. g. in case of large chip accumulations, a fire detection system is installed in the interior of the machine. Outside the machine, an additional manual fire detection device (manual actuation) is installed. The signal is normally transmitted to the factory fire brigade or a central control station.

To enable access to manual fire suppression or elimination of the source of fire, interlocking guards with guard locking, e. g. with sealed emergency unlocking, are installed at access doors.



Figure 5 Interlocking guard with guard locking/position switch with emergency unlocking by Bowden cable

Note

If a fire is to be suppressed manually, the machine door must only be opened by specifically instructed personnel or by the fire brigade. Whirling up due to application of the extinguishing agent must be strictly avoided (risk of dust explosion).

For information on instructions, see DGV Leaflet **Fachbereich AKTUELL** FBHM-043 “Brand an Werkzeugmaschinen – Was ist zu beachten?” (English version: “Fire on machine tools – What has to be considered?”)

Furthermore, regular maintenance and cleaning of the system must be ensured. The cleaning in the machine surroundings has to be specified in a cleaning schedule as well.

The capture of the magnesium containing dust deposits must only be carried out with approved industrial vacuum cleaners, if necessary with hydrogen venting. In case of moistened dusts, the free flow of generated hydrogen has to be ensured. Industrial vacuum cleaners without internal ignition sources are suitable (e. g. identification type plate: type 22, EPL Dc [1]). The dust containers should be emptied on every workday. Cleaning intervals and methods have to be documented in a cleaning schedule. For information on industrial vacuum cleaners and dust extractors, see DGV Information 209-084 Industriestaubsauger und Entstauber”.

Dusts and chips adhering to the work clothes represent a particular hazard. These dusts can be easily ignited and lead to a very fast and violent fire propagation with very high temperatures, if clothes are on fire.

In order to minimize the adherence of magnesium dusts during activities (e. g. deburring workpieces), suitable protective clothing with a smooth surface without pockets have to be worn (e. g. flame-resistant rubber or leather apron with smooth surface, see also Clause 3 Personal protective equipment).

Clause 6 describes the collection and storage of dry chips and dusts.

2.1.3 Machining with water-miscible metalworking fluids

Chips, hydrogen formation and deposits related to metalworking fluids present the hazards which have to be taken into account when machining with water-miscible metalworking fluids (MWF).

Protective measures

Chips have to be easy to remove in order to keep the fire load low in the machine area. They should be flushed by large quantities of water-miscible metalworking fluids (flush cleaning).

The entire machine interior should be provided with additional flushing nozzles to remove chips and avoid chip accumulation. For manual cleaning and removal of chips in the interior of the machine, an additional flushing hose with emulsion has proved to be useful.

A sufficient quantity of metalworking fluid at the machining point (flush cleaning) has to be ensured, e. g. by monitoring the MWF supply by pressure controls or flow monitors (for information on the design of the MWF circuits, see VDI 3035). This avoids “dry running” and the accumulation of chips.

Generally, MWF with additives (inhibitors) should be used, which largely minimize hydrogen formation.

In the course of machining, contents may be discharged; therefore, regular inspection and maintenance of the metalworking fluids is necessary, preferably in close cooperation with the MWF manufacturer.



Note

Generally, water-miscible metalworking fluids have to be regularly (e.g. weekly) monitored according to DGUV Rule 109-003 “Tätigkeiten mit Kühlschmierstoffen” (for pH-value, concentration, nitrite, see Clause 7 Inspection, Maintenance).

It is furthermore recommended to control the water hardness regularly to counteract an increase at an early stage and thus avoid massive deposits.

The reaction of magnesium with the MWF may lead to problems due to the formation of solid magnesium soaps and an increase of water hardness (hardening, salting). These deposits (crusts and layers as hard as glass) may lead to clogging of the pump and circuit systems and thus considerably impair the MWF supply.

A regular cleaning of the emulsion from magnesium particles is necessary. This can be achieved by filtering, e. g. by means of a filter fleece/pressure belt filter. Thus, “salting” by the solvation of magnesium ions can be minimized/delayed.

The filter fleeces covered with moistened, fine magnesium particles constitute a reactive fire load and must therefore be regularly removed from the working area and stored in suitable containers (e. g. non-combustible, closed with vent).

For eliminating the emulsion mist which is generated in the interior of the machine and to avoid accumulation of gaseous oxygen, an extraction system has to be provided.

The precondition for the start of the machine is an active extraction system maintaining the minimum volume flow/extracted air flow specified by the machine manufacturer (control e. g. by means of pressure or flow controls).

If the required extraction rate is not achieved or in case of failure, a signal has to be indicated by an automatic warning device or the machine must be stopped. After machining has been finished, the overrun of the extraction system has to be ensured.

Water accumulations have to be avoided even at a standstill of the machine and the extraction system. This requires the provision of vents in the top area inside the machine as well as in the extraction system (if possible at the highest point).

It has proven useful to design the top surfaces with an upward slope towards the opening. Large cavities in the machine foundation and in the enclosures have to be equipped with vents in order to prevent water accumulation.

Depending on the risk assessment, in practice, for example, if there is a hazard of increased chip accumulation, a fire detection unit in the interior of a machine and an additional manual fire detection device (for manual activation) outside the machine are installed. The signal is

normally transmitted to the factory fire brigade or a central control station.

To enable access to manual fire suppression or to eliminate the source of fire, interlocking guards with guard locking, e.g. with sealed emergency unlocking are installed.



Note

If a fire is to be suppressed manually, the machine door must only be opened by specifically instructed personnel or by the fire brigade. For guidance on instruction, see DGUV Leaflet **Fachbereich AKTUELL** FBHM-043 “Brand an Werkzeugmaschinen – Was ist zu beachten?” (English version: “Fire on machine tools – What has to be considered?”)

Furthermore, an effective ventilation in the hall area has to be ensured.

It has to be taken care that the moistened sludge conveyed from the interior of the machine is removed and conveyed to a container of limited volume.

In order to keep the quantity of moistened chips on a low level (reactive fire load), non-combustible chip containers with vents are required for emerging hydrogen.

If possible, the transfer of large quantities of chips from the machine directly to briquetting has proven to be useful. Attention should be paid to a low residual moisture content.

The work area, the machines and the chip container have to be marked with warning signs (see Clause 8 “Marking ...”). The prohibition of open flames; fire, open ignition sources and smoking must be implemented (safety marking according to ASR A1.3).

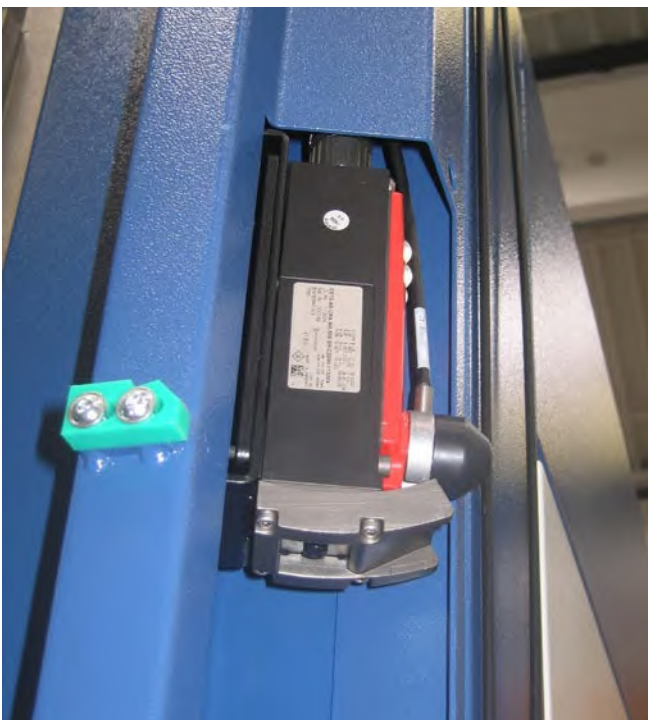

Figure 6 Interlocking guard with guard locking/position switch with emergency unlocking by Bowden cable



Figure 7 Briquetted chips

2.1.4 Machining with non water-miscible MWF (neat cutting oil)

2.1.4.1 Conventional wet processing

As for all conventional processings of materials with non water-miscible metalworking fluids (neat oil), the machining process leads to an atomization (MWF/air mixture) in the interior of the machine.

There is a risk of ignition of the MWF/air mixture in the work area due to hot surfaces or sparks. This may result in flashovers.

Fires in the interior of the machine (e. g. fire of the oil or of oil wetted chips) and flame ejections (e. g. from gaps, housing doors, loading and unloading openings) into the machine surrounding are the consequence.

In the further course of the fire, a fire may spread into the interior of the machine as a result of the ignition of oil-soaked magnesium chips. In the worst case, a secondary light-metal fire of the magnesium chips may develop.

Protective measures:

By selecting low-emission metalworking fluids, the formation of aerosols and vapours at the workplace can be reduced. Low-emission metalworking fluids are characterized by the following properties: (see DGUV Rule 109-003 “Tätigkeiten mit Kühlschmierstoffen”, DGUV Information 209-026 “Brand- und Explosionsschutz an Werkzeugmaschinen” (English version: DGUV Information 209-027 “Machine Tool Fire and Explosion Prevention and Protection”), VDI 3802, sheet 2-03/2012 “Air conditioning systems for factories – Capture of air pollutants at machine tools removing material”):

- formulated on the basis of low-evaporation mineral oils or synthetic esters or special liquids (e. g. polyalphaolefins),
- addition of anti-mist additives.

Tendency	Viscosity grade acc. to DIN ISO 3448	Viscosity at 40°C acc. to DIN 51562	Flashpoint acc. to DIN EN ISO 2592 (CoC)	Evaporation losses at 250°C acc. to DIN 51581-1, 2 (Noack procedure)	Examples of machining processes
Decreasing fire and explosion hazard	ISO VG 5	4,14 – 5,06 mm ² /s	> 120°C	< 85%	Honing, reaming
	ISO VG 7	6,12 – 7,48 mm ² /s	> 145°C	< 80%	Grinding, deep hole drilling
	ISO VG 10	9 – 11 mm ² /s	> 155°C	< 60 %	Turning, milling
	ISO VG 15	13,5 – 16,5 mm ² /s	> 190°C	< 25%	Drilling
	ISO VG 22	19,8 – 24,2 mm ² /s	> 200°C	< 15%	Threading
	ISO VG 32	28,8 – 35,2 mm ² /s	> 210°C	< 13%	Thread rolling
	ISO VG 46	41,4 – 50,6 mm ² /s	> 220°C	< 11%	Broaching

Table 1 Characteristics of combustible non-water miscible metalworking fluids (Source: DGUV Information 209-026 “Brand- und Explosionsschutz an Werkzeugmaschinen” (English version: DGUV Information 209-027 “Machine Tool Fire and Explosion Prevention and Protection”))



Figure 8 Shut-off valve for air, extinguishing nozzle and flow sensor

It is principally recommended to select the MWF with the lowest vaporization losses and the highest flash point. If a viscosity range (viscosity index) is predetermined for a machining process, the MWF with the highest possible viscosity should be selected. See DGUV Information 209-026 “Brand- und Explosionsschutz an Werkzeugmaschinen” (English version: DGUV Information 209-027 “Machine Tool Fire and Explosion Prevention and Protection”).

A sufficient MWF quantity at the machining point (flood lubrication) has to be ensured (for general information on the design of MWF circuits, see VDI 3035), e. g. by monitoring the MWF supply by means of pressure controls or flow monitors.

An extraction system has to be provided in order to remove the developing oil mist in the interior of the machine. The precondition for the start of the machine is an operating extraction system which maintains the minimum volume flow/extracted air flow specified by the machine manufacturer (control e. g. by means of a pressure or flow control/sensor).

If the required extraction rate is not achieved or in case of failure, an indication is given by an automatic warning device and the machine shuts down.

In case the machine’s housing/enclosure is not sufficiently resistant, a pressure relief device has to be provided, preferably in the cover of the machine tool.

It should direct the flames and hot combustion gases which are generated as a result of an ignition into areas where they do not present a hazard to the operating personnel.

It is intended to ensure pressure relief due to a flashover of oil aerosols as directly as possible. Thus hazards to the machine personnel by ejecting flames would be reduced.

If the operation of a machine tool involves a high risk of fire and hazards of subsequent metal fires, integrated fire detection and fire suppression systems will have to be provided (see DIN EN ISO 19353).

The requirements for integrated fire detection and fire suppression systems as well as for the type of extinguishing agent also represent a decisive part of the safety concept. A fire which develops inside a machine must on no account spread over to the magnesium chips since this would cause a metal fire which is hard to control.

Therefore, increased requirements for a safe fire detection are specified, for example by means of monitoring with several combined fire sensors (flame and heat sensors). Furthermore, fire suppression should proceed fast in order to prevent the fire from spreading over to the magnesium chips. The inert gas argon has proved to be a suitable extinguishing agent.

If CO₂ is intended to be used as fire extinguishing agent for the oil fire, it is **essential** to ensure within the frame of a case-by-case analysis that a fire within the machine can in no way spread over to the magnesium chips.

It has to be ensured that magnesium chips cannot accumulate in the interior of the machine, e. g. by means of sufficient flushing devices.

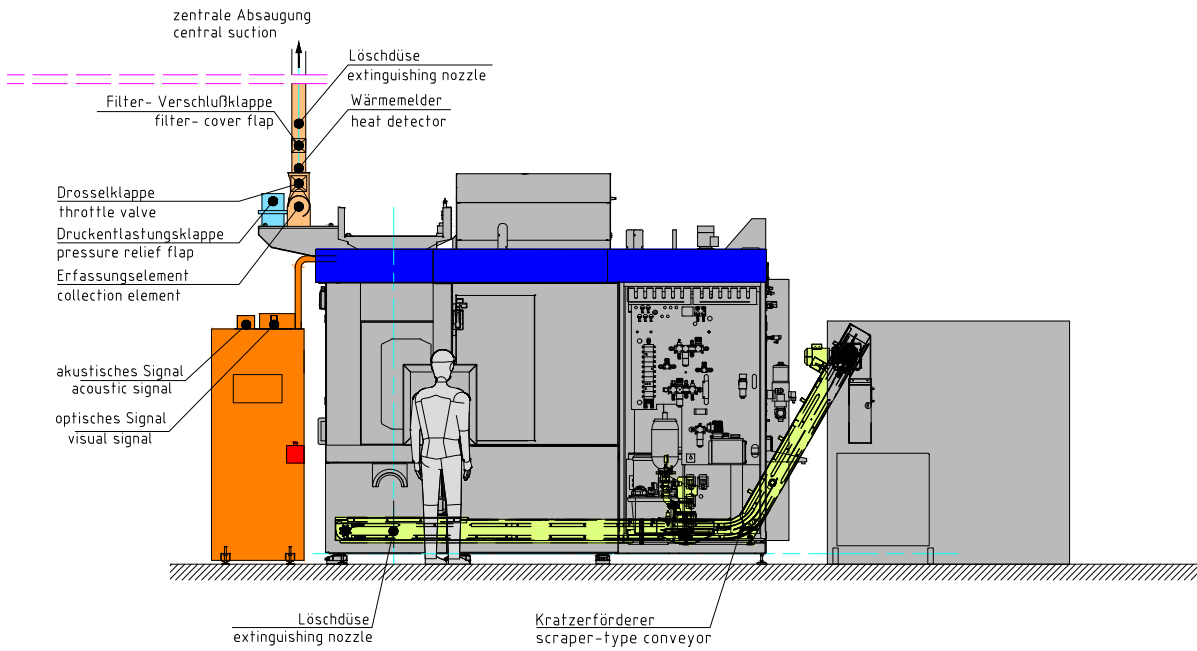

Figure 9 Schematic diagram; protection concept for neat oil machining (non water-miscible MWF), machining centre for automatic loading and unloading of workpieces

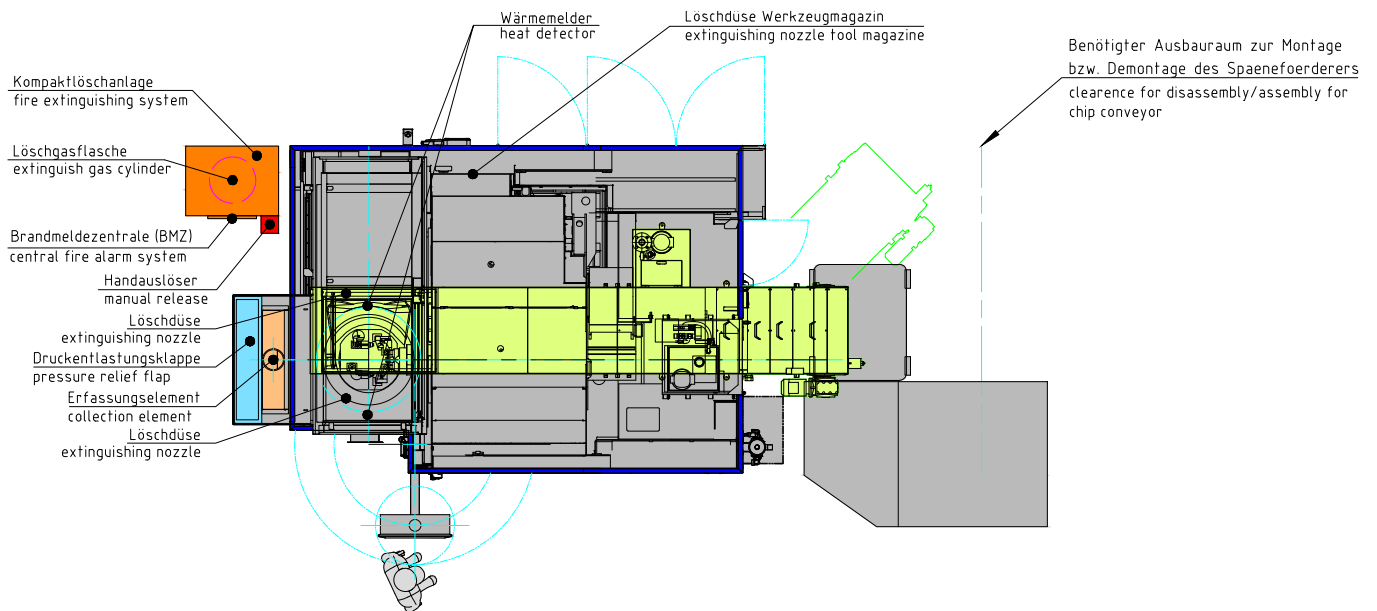

Figure 10 Schematic diagram; protection concept for neat oil machining (non water-miscible MWF), machining centre for automatic loading and unloading of workpieces; top view



Figure 11 Extinguishing nozzle and heat detector/temperature sensor in the interior of the machine

To reduce the fire hazard, as few combustible materials as possible should be present inside the machine tool and in the vicinity of the workplace. Chips have to be removed from the interior of the machine, e. g. by chip conveyor and flush cleaning. Chip containers have to be emptied regularly and on demand (preferably at least once per day).

The work area has to be kept free from further ignition sources and marked with the prohibition sign P003 (no open flame; fire, open ignition source and smoking prohibited - source: ASR A1.3) (see Clause 8 Marking). The prohibition of open flames, fire, open ignition sources and smoking must be implemented (safety marking according to ASR A1.3).

2.1.4.2 Minimum quantity lubrication (MQL)

Minimum quantity lubrication (MQL) is a total-loss lubrication method. The lubricant is either sprayed onto the tool via nozzles from outside (external feed) or from inside through the tool (internal feed). In industrial series production, the internal feed is mainly applied.

In contrast to conventional “wet processing”, minimum quantity lubrication requires an average of not more than 50 ml lubricant per process hour and tool for the machining process. In exceptional cases, however, the process may be supplied with more than 150 ml/h lubricant for a short period of time (see DGUV Information 209-024 “Minimalmengenschmierung in der spanenden Fertigung”, (English version: DGUV Information 209-025 “Minimum Quantity Lubrication for Machining Operations”)).

Malfunctions (e. g. incorrect movements, tool crash, blunt tool) can cause sparks. As a result, the oil in the oil-soaked chip accumulations/chip residues may ignite and might then cause a fire in the interior of the machine or the immediate vicinity.

In the further course of the fire, a secondary metal fire can be caused by ignition of the magnesium chips/residues.

Protective measures:

For fault-free, low-emission metal machining when using minimum quantity lubrication, lubricants with very good lubricity and a high thermal rating are best.

In industrial manufacturing, synthetic ester oils and fatty alcohols with favourable vaporisation behaviour and a high flash point are used (DGUV Information 209-024 “Minimalmengenschmierung in der spanenden Fertigung”, (English version: DGUV Information 209-025 “Minimum Quantity Lubrication for Machining Operations”)).

The following guide values have proven to be useful for selecting a low-emission lubricant.

Viscosity at 40 °C DIN 51562 Part 1	Flashpoint CoC DIN EN ISO 2592	Evaporation losses at 250 °C DIN 51581 Part 1
> 10 mm ² /s	> 150 °C	< 65%

Table 2 Guide values for selecting a low-emission lubricant (source: IFA workbook “Measuring hazardous substances”, category 6)

To reduce the risk of fire, the use of lubricants with a flash point of at least 150 °C and a high viscosity (> 10 mm²/min at 40 °C) is recommended.

Within the framework of a research project, the effects of ignition incidents during minimum quantity lubrication on the risk of fire and explosion were investigated under practical conditions (see DGUV Leaflet Fachbereich AKTUELL FBHM-088 “Minimalmengenschmierung – Risiko von Bränden und Explosionen”).

If the following two key points are observed, MQL machining with lubricant quantities up to

1000 ml per processing hour and per m³ workspace/machine interior (~ approx. 15 ml per minute per m³ workspace/machine interior)

is possible without the hazard of an aerosol-air-mixture ignition.

1. Use of low-emission MQL lubricants

For application in machine tools, the use of low-emission MQL lubricants with the properties mentioned in table 2 according to DGUV Information 209-024 “Minimale Mengenschmierung in der spanenden Fertigung” (English version: DGUV Information 209-025 “Minimum Quantity Lubrication for Machining Operations”) is recommended.

It is strongly advised against using low boiling liquids such as ethanol.

2. Extraction with continuous volume flow and monitoring

The extraction volume flow should be set high enough so that there is a slight negative pressure as well as an inward flow inside the machine to prevent emissions escaping from the enclosure.

An extraction volume flow of 400–600 m³/h per m³ machine room has proven its value in industry. Information on the optimal setting is included in VDI 3802 sheet 2 and VDI 2262 sheet 4.

Generally, an extraction system has to be provided for the efficient disposal of the oil mists produced inside the machine.

The chips in the machine tool should be removed, e. g. by continuous discharge via chip conveyors.

Chip accumulations can be reduced by a particular design inside the work space of the machine (e. g. by workroom panelling that is steeply inclined, smooth surfaces (e. g. made of stainless steel)).

Depending on the risk assessment, in practice a fire detection system and an additional manual fire alarm system outside the machine (manual release) are installed,



Figure 12 Interlocking guard with guard locking/position switch with emergency unlocking at the protection door magazine maintenance

for example, if a large amount of chips has accumulated inside the machine. The signal is usually forwarded to the works fire brigade or a central control centre. To enable access for manual suppression or removal of the source of fire, access doors are provided with interlocking guards with guard locking, e. g. with sealed emergency unlocking.

Note

If manual fire suppression is required in the event of a fire, the machine door may only be opened by specially instructed personnel or by the fire brigade. Any whirling up due to the use of the extinguishing agent must be prevented (hazard of dust explosion).

For useful information on instruction, see DGUV Leaflet Fachbereich AKTUELL FBHM-043 “Brand an Werkzeugmaschinen – Was ist zu beachten?” (English version: “Fire on machine tools – What has to be considered?”) Furthermore, regular maintenance and cleaning of the system has to be ensured. The intervals have to be specified in a cleaning schedule (e. g. Sample cleaning schedule, see Annex 2 of DGUV Information 209-024

“Minimalmengenschmierung in der spanenden Fertigung”, (English version: DGUV Information 209-025 “Minimum Quantity Lubrication for Machining Operations”).

2.1.5 Machining with hand-held grinding machines

When grinding, brushing and deburring magnesium components, ignitable magnesium dusts and fine chips are produced. Magnesium dusts are highly flammable and explosive in air in a whirled-up state.

Deposited dusts in the work area represent a fire hazard. Maximum caution is required if there is a risk of dusts and chips adhering to the work clothes. Adhering dusts are very easy to ignite and, in the event of a clothing fire, lead to an extremely rapid and violent fire spreading with extremely high temperatures.

Flammable sparks are often the cause of clothing fires. The sparks can be created by unintentional contact of hand-held machining tools (e.g. putting down the overrunning hand grinder) with spark-generating metallic parts (e.g. tool storage, linings, frame parts, extraction hoods, etc.).

Protective measures

The dry grinding dusts produced must be extracted as close as possible to the machining point. In addition, an extraction system especially suitable for magnesium dust must be used at the workplace (see description of suitability for magnesium dust in the Chapter “Intended use” in the Operating Instructions for the products concerned. Requirements for extraction systems for dry magnesium dust, see Clause 2.1.2).

In practice, workplaces for grinding magnesium (e.g. consisting of work table, work surface and edge extraction as well as hand-held grinding machines) are usually extracted by means of wet scrubbers. The extraction system runs permanently during processing and the extracted air volume flow is continuously monitored (flow velocity: $v > 20$ m/s). The wet scrubber has vents, so that inevitably generated hydrogen escapes and cannot accumulate. A continuous equipotential equalization (earthing from the grinding booth to the wet scrubber incl. lightning protection) is also a prerequisite.

Furthermore, it is required to wear additional suitable protective clothing with a smooth surface without pockets (e.g. flame-resistant rubber or leather apron with a smooth surface). Thus, the adhesion of magnesium dust to the work clothes is minimized. Clothing made of knitted fiber and fleece materials is absolutely unsuitable.

Ignition sources, e.g. grinding sparks from sparking tools, must be excluded from the work area. In the direct vicinity of the work area, metal parts (frame parts, extraction hoods etc.) should therefore be made of “non-sparking” material (e.g. aluminium or copper) if possible. Only the use of compressed-air operated tools is permitted; electrical grinding devices, such as angle grinders, are excluded.

Dusts which are not collected by the extraction system must be removed by regular cleaning of the work area. When doing so, avoid whirling up the dust with compressed air. For this purpose, suitable industrial vacuum cleaners without internal ignition sources (e.g. identification plate type 22, EPL Dc) and, if necessary, with hydrogen venting should be used; the dust collection containers should be emptied every working day. Cleaning intervals and methods must be documented in a cleaning schedule. For information on industrial vacuum cleaners and dust extractors, see DGUV Information 209-084 “Industriestaubsauger und Entstauber”.

The work area must be marked with the prohibition sign “Open flames, fire, open ignition sources and smoking prohibited”.

Extinguishing agents of fire class D for metal fires shall be kept available. Under no circumstances may water be used to extinguish the fire!

See DGUV Leaflet **Fachbereich AKTUELL** FBHM-051 “Trockenschleifen von Magnesium”.



Figure 13 Fire of molten magnesium



Figure 14 Ejection of molten metal on contact with water, approx. 50 ml

2.2 Molten metals

Molten magnesium has a viscosity comparable to that of water in the casting temperature range and ignites spontaneously on contact with atmospheric oxygen. Technical magnesium alloys melt at temperatures in the range of approx. 420 °C to 650 °C (self-ignition from approx. 400 °C, most alloys melt from 530 °C).

Without covering agents or protective gases, the molten metal ignites in the air and immediately burns on the surface with a strong development of white smoke and bright white light.

The resulting harmful smoke consists of magnesium oxide with a particle size of < 10 µm. This smoke should not be inhaled and falls within the scope of the workplace limit for the alveolar dust fraction (TRGS 900).

A distinctive feature of magnesium fire is the glaringly bright and, due to the heat radiation in the infrared range, blinding flame. In addition, UV/IR and visible portions of radiation in the flame can occur. Unprotected viewing can cause damage to the eyes (e. g. cataract). A visor, for example with gold coating, should be used.

When the molten metal comes into contact with moisture, water or even rust etc., a violent reaction takes place, in the course of which molten metal is ejected. This can lead to subsequent fires, causing personal injury or damage to property. It is therefore essential to prevent contact of the molten metal with water and moisture!

The high combustion temperatures of magnesium of up to 3000 °C result in a splitting into oxygen and hydrogen (thermolysis) when water is added. This can lead to an explosive oxyhydrogen gas reaction with potentially fatal consequences.



Figure 15 Ingot casting/production of ingots

Activities/protective measures

Inserting ingots

When ingots are inserted, any ingress of moisture must be prevented. The ingots must be dried to avoid adhering moisture, for example by preheating stations (temperature and minimum time as specified by the manufacturer). Careful insertion of the magnesium ingots by hand or through a sluice into the metal bath (e. g. through a sliding duct, suitable baskets) protects the crucible from damage.

Gassing/protective gases

When opening crucible flaps and inserting ingots, sensors, pumps and similar, there is always the risk of atmospheric oxygen and traces of moisture ingressing the system.

In order to prevent this, protective gas is applied at overpressure. Any disturbance of the molten bath and the associated access of air should be kept as short as possible. Otherwise, turbulences might be caused by convection, so that air can enter and displace the protective gas.

The magnesium oxidizes at the surface of the molten metal with the oxygen in the air to form magnesium oxide. The magnesium oxide is unstable (oxygen diffuses), has a smaller volume than the molten magnesium and thus causes the layer above the molten metal to break up again and again. Accordingly, spontaneous combustion at the surface may occur. To prevent that from happening, a protective gas is applied to the surface of the molten metal. Different gases can be used for this purpose. Currently used protective gas atmospheres consist of the following gases, for example: R 134a or SO₂ (a few percent) mixed with absolutely dry air or pure nitrogen.

Skimming/crucible cleaning

During melting or holding, even under protective gas, granular slag is formed on the bath surface of magnesium crucibles through oxidation. This so-called dross forms a heterogeneous mass which must be regularly removed (skimming).



Figure 16 Dross container made of steel ...



Figure 17 ... with tight-fitting cover



Figure 18 Container for skimming tools, open



Figure 19 Container for skimming tools, closed



Figure 20 Foundry clothing worn on the oven platform during skimming (flame-resistant silver clothing, respiratory protection if required, gold-plated visor)

The molten magnesium adhering when the dross is removed ignites very quickly in the air outside the crucible, producing smoke. Therefore, the molten magnesium and the tool should be placed in a completely dry, non-combustible suitable container (e. g. made of steel) with a tightly closing lid, in which the fire is quickly extinguished. Alternatively, the fire can also be extinguished by covering it with a special melting salt.

The tools used to clean the crucible should also be stored in suitable containers or kept clean and dry to prevent the residues adhering to them from igniting.

Dross from non-soluble oxides of the alloy components occurs primarily on the the molten bath surface, but also at the bottom and walls of the crucible. It must also be removed or “pulled” regularly. Dross/scale deposits must also be removed at regular intervals from the side walls and the bottom of the crucible.

The removal of dross from the surface or of oxides from the crucible may only be carried out under the following conditions.

- Suitable protective clothing is worn (e. g. flame-resistant “silver clothing”, if necessary, respiratory protection, gold-coated visor). See Section 3 “Personal protective equipment”.
- Preheated tools, specially designed for the operating conditions are used. The tools must be made of solid material, be dry and free from rust, nickel and impurities.
- It must be prevented that, when opening the crucible flaps, possible caking from oxides generated during the melting process fall into the molten metal in larger lumps (danger of thermite reaction $\text{Mg}/\text{Fe}_2\text{O}_3$). A possible protective measure is the regular inspection and cleaning.

The deposits at the bottom and walls of the crucible (bottom slag) must be removed at regular intervals, as overheating can occur in these areas and lead to crucible rupture.

Extraction (pull out) and cleaning of the pump

A fire caused by adhering molten metal can also occur when metal pumps, stirrer motors or temperature probes are pulled out. Such fires can also be extinguished by covering them with thick layers of silicate-free mineral wool on the basis of magnesium and calcium oxide. As soon as no more oxygen reaches such a manageable fire and the magnesium solidifies, the flames are extinguished.

If the pump or the pouring container is pulled out, there is a risk of ignition of the adhering, partly liquid, magnesium. Therefore, the components should be placed quickly in a steel container with cover.

In practice, the component is covered with suitable covering/extinguishing agents (e. g. ceramic fiber wool/dry sand/hollow glass granulate (silicon dioxide)) and the cover of the container is closed in order to extinguish the flames. In addition, suitable extinguishing agents of fire class D should be available in sufficient quantities for these activities.

Melting furnace/crucible

When using protective gases containing fluorine, a coating of the inside of the crucible at liquid level with nickel-free chromium steel to increase corrosion resistance has proven to be advantageous.

Linings in the crucible area must be made of refractory material, free from silicates and iron oxide, since molten magnesium can react with these oxides. The brick lining/collecting tray should preferably be made of steel or of a material with a high alumina content.

A temperature setting as uniform as possible and monitoring with several temperature sensors in the different sections of a crucible to avoid major variations is required. In addition, the liquid level of the crucible must be monitored with level probes. The liquid level should be kept constant so that especially the upper edge area of the crucible is not overstressed.

A routine monitoring of the crucible wall thickness by ultrasonic or other non-destructive methods must be carried out as well as a visual inspection of the walls for cracks and deformation. According to previous experience, the service life of the crucibles is about 4-6 years, depending on the quality. However, this must be examined on a case-by-case basis. If the wall thickness is reduced, the specifications of the crucible or furnace manufacturer must be observed. In general, regular inspection intervals are to be determined by the user taking into account the manufacturer's information.

When using R134a as a protective gas, attention must be paid to the corrosive effect of hydrofluoric acid (HF) that inevitably forms in the area of the metal surface on the crucible edge. Regular inspection of the wall thickness of the crucible and its structural condition is also necessary.

Mechanical overstressing of the crucible by an excessively violent insertion of the ingots into the molten magnesium should be avoided. Slow insertion and melting of the ingots should be preferred.



Figure 21 Die casting system

It should be possible to separately disconnect the supply of the melting furnace with electrical energy, gas and hydraulic fluid outside the hazard zone. In an emergency, the supply of protective gas must be maintained. For this reason, casting cells generally need their own emergency power supply.

a hot-chamber die casting

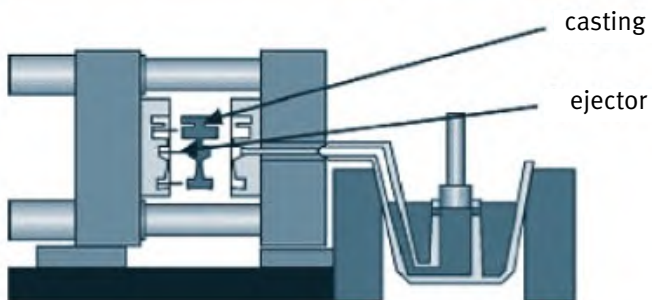
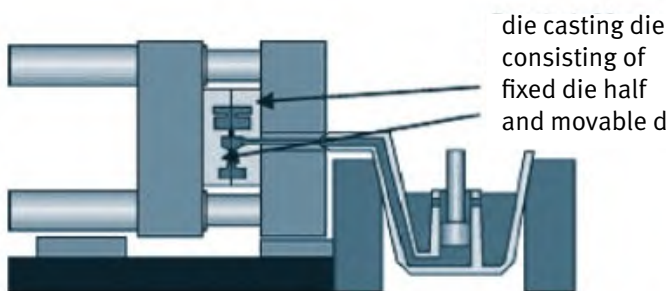
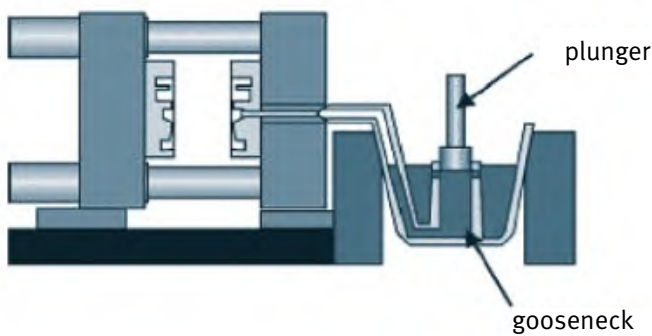

b cold-chamber die casting

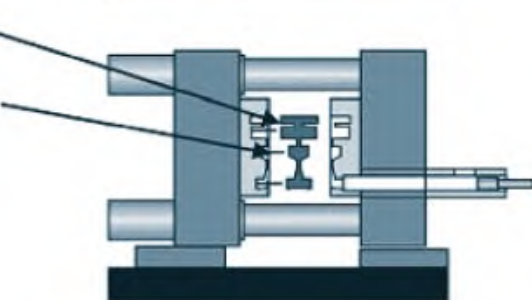
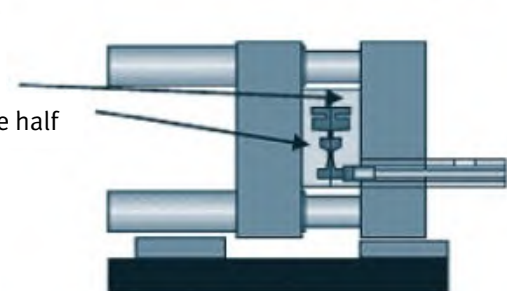
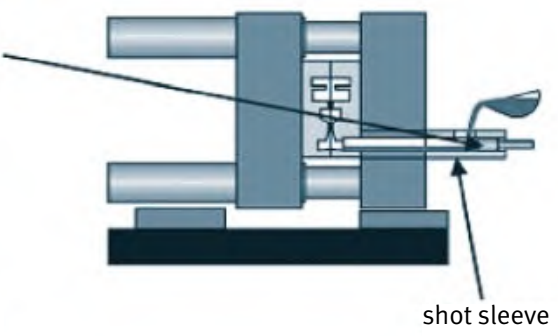

Figure 22 Schematic representation of the course of the die casting process:
 (a) hot chamber die casting machine, (b) cold chamber die casting machine

2.3 Die casting

A die casting machine for magnesium alloys is divided into two subunits. A distinction is made between the melting and holding area, in which the magnesium is melted, and the actual die casting area, in which the liquid material is pressed from a shot sleeve into the closed die halves at very high pressures (DIN EN 869). Furthermore, additional devices, for example removal and spraying devices, are involved in the process.

The two relevant processes for non-ferrous metals are the hot chamber and the cold chamber die casting processes. In the hot chamber die casting process, the actual chamber is continuously and directly connected with the liquid metal in the melting furnace through the casting nozzle.

In contrast, in the cold chamber die casting process, the molten metal is supplied from the melting furnace via a supply pipe or other dosing systems into the actual shot sleeve and pressed into the closed die halves with the plunger under high pressures.

Hazards and protective measures

A particularly critical area in hot chamber die casting is the connection of the heated casting nozzle to the actual die casting part of the system. Deposits in this area may easily lead to leaks.

Protective measures should include guards, such as covers, and regular maintenance/control of critical points.

Even in cold chamber die casting, several accidents due to the ejection of molten metal occurred at a comparable position. The heated transfer pipes between melting furnace and filling chamber must be repaired at regular intervals, as they can become clogged over time.

Therefore, when dismantling the transfer pipes, it must be ensured that there is no contact with any liquid magnesium that may still be present. Depending on the feed system, the magnesium can be under slightly increased pressure and spurt out when the pipe is removed.

In both processes, it is possible that material adheres between the die halves in the form of thin “flash” consisting of cold molten magnesium that has been pressed out.

The caking can cause leaks in the die. It is therefore important to ensure that these residues are removed as completely as possible when applying the release agent.

The thin flash produced falls into the lower part of the machine and, due to its large surface area, is highly flammable. In addition, the resulting magnesium flash material is moist due to the contact with aqueous mold release agents and hydrogen formation must be taken into account.

In order to reduce the fire load, the deposits must be regularly removed. This is most easily done by using pull-out collecting plates, which are mounted below the mold area.

Accumulations/residues of flash, lubricants, water or hydraulic fluids below the die must be removed regularly (maintenance cleaning schedule).

When liquid and immediately burning molten magnesium is ejected, secondary fires or injuries to the operating personnel may occur. Therefore, protective devices, for example sheet metal covers, according to DIN EN 869 must be available, especially at the parting line of the die casting die as well as in the area between the shot sleeve and the plunger.

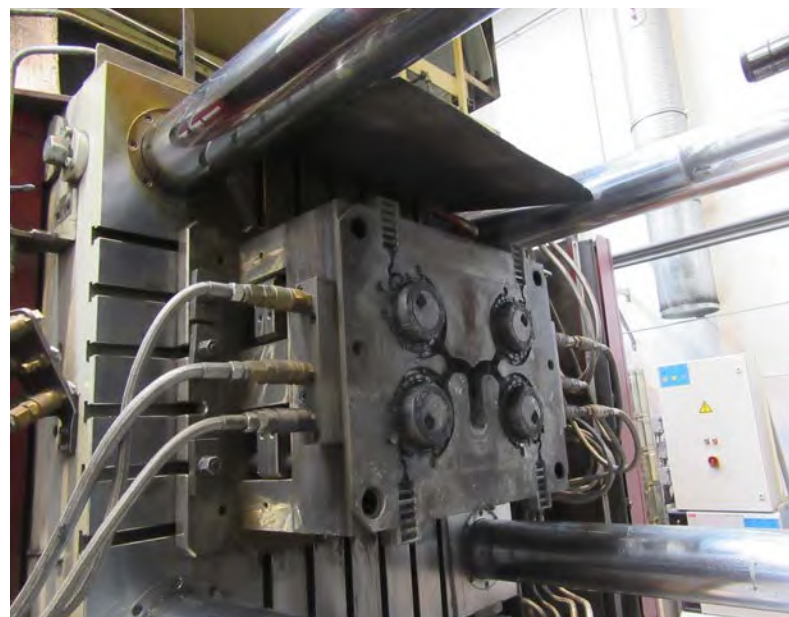

Figure 23 Die halves

If fixed guards are not sufficient, interlocking guards must be provided (see DIN EN 869, e.g. Clauses 5.11 and 5.13).

Cracks in the usually tempered die or in hoses can have dramatic consequences if water enters the die and comes into contact with the molten magnesium. It is therefore advisable to monitor the cooling circuits of the dies for example with flow monitors or pressure controls. If it is technically possible, water should be replaced by oil which is hard to ignite as cooling medium in the die.



Figure 24 Barrels with vents



Figure 25 Barrels with vents

Generally applicable safety regulations for activities with release agents (e.g. suitable release agents must be applied sparingly; after application of the release agent, the water must be completely evaporated, leaking water must not accumulate in the base frame due to a possible fire hazard, ...) must also be taken into account when processing magnesium.

Disposal/storage

The magnesium flash material produced is moist due to contact with the usually aqueous mold release agents and must be treated in a similar way as chips wetted with metalworking fluid emulsion. The material (flash) must be stored separately in closed, labelled barrels with ventilation in protected areas outside the casting hall until it is treated or carried away for recycling.

2.4 Sand casting

The casting of magnesium in sand (sand casting process) is a rare process in the prototype and small batch production. Hazards arise from the liquid molten metal (approx. 700° C). In addition, hazards to the skin and the respiratory tract exist due to contact with the molding material (e.g. phenol formaldehyde resins) and with the quartz sand used during molding, unpacking and cleaning. In addition, pyrolysis products from the molding material used are produced by the casting process.

In the special method of magnesium sand casting, the suppression of an advanced fire with sand can lead to a hazardous thermite reaction (silicothermal reaction). The magnesium extracts the oxygen from the sand (SiO_2) which results in a violent fire ignition.

Special protective measures

- Only completely water-free systems are suitable as molding auxiliaries and binders (dried core sand and phenolic resin, cold box cores); bentonite or furan resin bonded sand is unsuitable. It is recommended to add an inerting agent, for example potassium tetrafluoroborate (KBF_4). A reprocessing of the molding sand is usually not possible.

- Store sand and pour-off molds in a dry place.
- Flood the mold with protective gas (argon), remove the protective gas supply shortly before pouring.
- Observe the arrangement and keep clear of air pipes.
- Only use preheated casting tools (150°C, stainless and dry)
- For melting with approx. 400 °C or more, flood the crucible with protective gas, and constantly monitor the metal.
- When transferring the liquid magnesium, ensure flooding with protective gas, if possible.
- Excess of protective gas leads to deposits in the crucible and on the bath surface, which can burn in contact with ambient air.
- Do not slosh when moving the cast metal.
- Pour quickly; the metal quickly loses temperature.
- In case of incipient burning, powder the feeder and the sprue with sulfur or add molten salt.
- Keep extinguishing agent (fire class D) ready.

2.5 Further casting processes

Cast rolling for the production of magnesium sheets and magnesium strips, for example with a strip thickness of approx. 5 mm, is a rather rarely used process. A casting-rolling system usually consists of a melting furnace, a molten metal outlet forming a gap (tip) as well as a rolling and cooling unit.

The emerging liquid molten metal, which has a temperature of approx. 700 °C, is suddenly “quenched” to approx. 250 °C by means of two cooled rollers. Protective gas is supplied at the point of exit of the molten metal to protect the area against atmospheric oxygen. When handling the molten metal, the measures described in clause 2.2 shall be observed.

2.6 Blasting

The dust particles generated during blasting have a large surface area and, in addition to the risk of fire, can also lead to the formation of a hazardous explosive atmosphere. A fire occurs when deposited dust ignites. The ignition of even small quantities of whirled-up dust involves an explosion hazard.

Due to the high risk of explosion, the resulting dusts are passed through a wet scrubber and precipitated. This leads to a reaction of the magnesium particles with water which generates such an amount of hydrogen gas that the formation of an explosive mixture is possible. This is particularly critical if there is an insufficient quantity of water in the separator tank.

If the work clothes are soiled by dust, the employees are exposed to an increased risk of fire.



Figure 26 Wet scrubber

Protective measures

Copper-free aluminium or zinc wire grain or granulate or corundum (inerting effect with corundum content > 50 % of the blasting dust) should preferably be used as blasting medium.

Steel and cast iron should not be used as blasting media because of sparking and the increased risk of corrosion due to iron abrasion adhering to the magnesium parts. Iron oxides are also less suitable as blasting agents (e. g. ferrosate) due to the danger of aluminothermic reactions.

Basically, systems for blasting magnesium are extracted by means of a wet scrubber. The extracted air flow is permanently monitored during processing (pressure or flow meter: velocity extraction volume flow > 20 m/s). The piping must be equipped with inspection openings to allow for regular inspection and cleaning.

The wet scrubber has to be provided with vents so that any hydrogen produced can escape and cannot accumulate.

A continuous potential equalization (grounding from the blasting cabinet to the wet scrubber including lightning protection) must also be observed.

Cleaning in the vicinity of the blasting system must also be specified in a cleaning schedule. Magnesium-containing dust deposits may only be collected by approved industrial vacuum cleaners. For this purpose, suitable industrial vacuum cleaners without internal ignition sources (e. g. identification on the type plate: Type 22, EPL Dc [1]) and possibly with hydrogen venting must be used. The dust collection containers should be emptied every working day. Cleaning intervals and methods are to be documented in a cleaning schedule. For information on industrial vacuum cleaners and dust extractors, see DGUV Information 209-084 "Industriestaubsauger und Entstauber".

The extinguishing gases carbon dioxide or nitrogen must not be used when extinguishing magnesium fires at blasting systems. In general, the extinguishing gas should not be applied at high pressure in order to avoid whirling up the dust. The extinguishing gas or powder is applied gently.



Figure 27 Sludge tipper for magnesium deposits from wet scrubber

3 Personal protective equipment/ work clothes

The choice of personal protective equipment depends on the respective activities and the operational conditions. A distinction is essentially made between the area of melting/casting and the area of machining of magnesium workpieces.

There is a risk that magnesium dust adhering to clothing can easily ignite. Therefore, protective clothing worn during machining of magnesium must never be used in areas with molten magnesium. A change of protective clothing is therefore necessary.

If the clothing soiled with magnesium dust has to be cleaned, it is essential to observe the washing instructions given by the clothing manufacturer.

Personal Protective Equipment (PPE), machining area

The main hazard during machining, especially during dry grinding, is the accumulation of magnesium dusts and chips on protective work clothes. These particles adhering to the protective work clothes are highly flammable. For this reason, a clothing fire containing magnesium can spread very quickly and extremely violently.

Therefore, suitable protective clothing with a smooth surface without pockets (e.g. rubber or leather apron) must be worn. The quantity of magnesium dust adhering to the work clothes can thus be minimized.

In general, clothing should be cleaned regularly to remove adhering magnesium residues.



Attention

Under no circumstances may clothing be blown off with compressed air or worn during activities involving fire hazards (welding)!

Personal Protective Equipment (PPE), melting/ casting area

In the melting/casting area, the following personal protective equipment is worn, depending on the risk assessment:

- foundry clothing (protective clothing and underwear according to DIN EN ISO 11612)
- foundry helmet
- foot protection
- gloves

and, according to the risk assessment, also

- safety goggles with side protection
- ear protection
- respiratory protection

In areas with direct contact with molten metal (e.g. skimming on the furnace platform, cleaning of pumps, manual casting, ...)

- foundry clothing (protective clothing, underwear and aluminised foundry coat for direct contact with molten metal according to DIN EN ISO 11612),
 - head and face protection (e.g. foundry helmet with visor, neck guard, hood),
 - foot protection, possibly gaiters,
 - foundry gloves
- have to be worn in addition.



Figure 28 Protective oven suit

Foundry clothing

The selection of protective clothing against heat and flames when handling molten metals is carried out in accordance with DIN EN ISO 11612. In addition, DIN EN ISO 9185 (formerly DIN EN 373) assesses the material resistance to liquid metal splashes and DIN EN ISO 15025 (formerly DIN EN 532) assesses the fire behavior of protective clothing.

When handling molten magnesium (e.g. skimming, molten metal treatment, furnace cleaning, etc.), particular attention must be paid to the drip off properties of the molten metal and the low flammability of the fabric. A textile material has good drip off properties, if molten magnesium does not remain adhered.



Figure 29 Burnt unsuitable protective clothing

The above mentioned requirements are divided into classes in DIN EN ISO 11612:

- **A** Flaming of materials and seams (DIN EN ISO 15025)
- **B** Protection against convective heat (DIN EN ISO 9151)
- **C** Protection against radiant heat (ISO 6942 method B)
- **D** Protection against molten aluminum (DIN EN ISO 9185)
- **E** Protection against molten iron (DIN EN ISO 9185)
- **F** Contact heat (ISO 12127-1)

For foundries, classes D and E are of particular importance. For protection against molten magnesium, it is recommended to wear clothing of class D3, based on the protection against molten aluminium.

The manufacturer must provide appropriate proof of the suitability of the clothing. As a rule, this is done by means of pouring tests in accordance with DIN EN ISO 9185 with the magnesium alloy used.



Figure 30 Pouring tests



Figure 31 Pouring tests

The performance of the pouring tests is also described in DGUV Information 212-013 “Hitzeschutzkleidung” (“Heat protection clothing”) in Section 4.3. It also contains further information on heat protection clothing.

In contrast to the aluminized foundry coat, the underwear/work clothes may have pockets. However, these must have flaps (e.g. pocket flaps) that are at least 20 mm wider than the pocket opening (10 mm on each side). This prevents ingress of molten magnesium and dust (roof tile principle).

Note

Company logos and reflective strips, the names of employees or companies that are subsequently attached can lead to a reduction of the protective function of the protective clothing.

If a subsequent attachment is necessary, it should only be done in consultation with the manufacturer of the personal protective equipment. This ensures that the emblems are attached at an uncritical position (roof tile principle still ensured).

The material used for the foundry coat is a flame-resistant fabric metallised with aluminium (“silver clothing”). The metallization protects against the radiant heat of the molten metal during a metal fire.

Objects such as lighters, smartphones and torches must not be carried in trouser or jacket pockets near the molten mass. There is a risk of explosive molten metal ejection if the objects fall into the molten metal.



Figure 32 Molten metal ejection in case of a lithium ion accumulator (smartphone, torch)



Figure 33 Helmet and face shield; here: hood with air supply

Foundry helmet and face shield

Requirements for industrial helmets are defined in DIN EN 397. In general, thermoset helmets with textile fibre reinforcement (unpainted or painted) as well as thermoset helmets without textile fibre reinforcement based on polycarbonate are used in foundry areas in case of hazards caused by splashes of molten metal and/or by use at very high temperatures above 150 °C).

The face shield shall be designed to provide adequate protection against metal splashes, flames and, if necessary, optical radiation (UV/IR radiation portion) (e. g. gold-plated visor).

Foot protection

In a foundry environment, foot protection includes safety shoes and gaiters.

To ensure that the shoes offer sufficient protection against penetration of metal splashes, they must be at least ankle high. In addition, they should be designed in such a way that they can be taken off quickly (quick release fastener). Furthermore, at least protection class S2 must be ensured. The requirements for the material correspond to those for protective clothing (low flammability, drip off properties).

Foundry gloves

If there is a risk of hand burns, suitable protective gloves have to be worn that insulate against the effects of heat. In areas with a risk of ejection of molten metal, gloves must be worn which consist of the same aluminized material as the foundry coat, for example.

Requirements are dealt with in DIN EN 407 “Protective gloves against thermal risks (heat and/or fire)”.

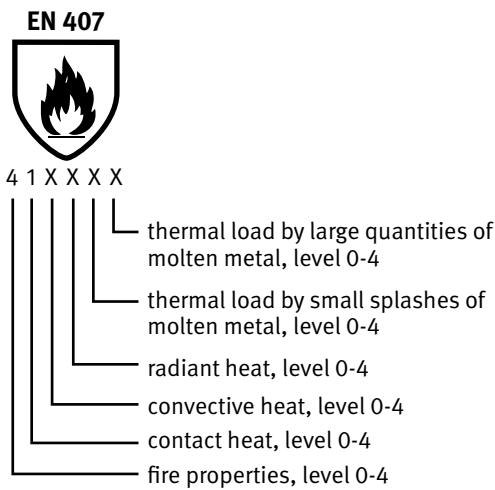

Figure 34 Example of the labeling of heat protection gloves according to EN 407

Underwear

Special attention should also be paid to the fabric of the underwear. Synthetic fibres can melt quickly on the skin and, in the worst case, have to be surgically removed. In the risk assessment, it must be determined and specified for each individual case which underwear should be worn.

It is generally recommended to choose underwear that does not contain any synthetic fibers.



Note

Clothing with finished fabrics releases more unpleasant gases when exposed to heat than clothing with inherently flame-retardant fabrics. For finished fabrics, attention must also be paid to the maximum number of washing cycles for which the certified protection is guaranteed.

Respiratory protection

The selection and use of respiratory protective devices is described in detail in DGUV Rule 112-190 “Benutzung von Atemschutzgeräten”.

In case of high dust exposure, for example during the regular dressing process, the use of a separately ventilated airstream helmet has proven its worth.



Figure 35 Helmet and face shield; here hood with air supply



Note

Respiratory protection for Mg work should not be used for other activities, for example when grinding steel. There is a risk that Mg particles in the filter suddenly ignite due to sparks from other activities.

4 Instruction

General

According to DGUV Regulation 1 “Principles of Prevention”, instruction must be given before starting work and at least once a year. This obligation is laid down, for example, in accident prevention regulations, the Ordinance on Hazardous Substances and the Industrial Safety and Health Ordinance.

The contents of the instruction and the participants must be documented. The integration of practical exercises, especially fire-fighting exercises, rapid removal of PPE, has proved to be very useful. The instruction should be based on the contents of procedural operating instructions.

Activities relating to magnesium

In the following, the main focus is on organisational and behavior-based measures.

Inappropriate behavior can cause severe personal injury and property damage. For this reason, employees must be familiar with the topics listed in the checklists (see Annex 1), have a high level of safety awareness and observe the corresponding protective measures. Due to the hazards involved in activities relating to magnesium, magnesium processing areas should be separated from other areas, as far as possible. Access to these areas should only be granted to employees who have been specially instructed.

Special caution is required during maintenance and the employment of external companies, as in most cases, the maintenance personnel or the personnel of external companies do not work with magnesium on a daily basis. Accordingly, these personnel have to be instructed in advance specially on the hazards, the protective measures and the behavior in the event of malfunction.

As part of the instruction, comprehensive information on the characteristics and hazards of magnesium and its fire and explosion behavior is absolutely essential (see also Clause 1 “Magnesium-related hazards”).

This knowledge can be imparted in the course of a regularly conducted practical fire-fighting exercise. The use of the correct extinguishing agent, its storage location and the appropriate PPE and protective clothing against magnesium fires should be discussed. Under these conditions, the instructed employees can then extinguish small incipient fires on their own.

DGUV Leaflet **Fachbereich AKTUELL** FBHM-043: “Brand an Werkzeugmaschinen – Was ist zu beachten?” (English title: “Fire on machine tools – What has to be considered?”) provides guidance on instruction concerning the adequate behaviour in case of a machine tool fire.

Annex I contains a checklist of instructional topics that are important for activities relating to magnesium.



Notification

Employers should inform the responsible accident insurance institution before starting work with magnesium for the first time. In addition to the accident insurance institution, the responsible fire protection office should be informed as well.

5 Fire protection and First Aid

Machines: Fire protection

Since the European Machinery Directive (2006/42/EC) came into force, the manufacturer of machinery is obliged to take into account possible fire and explosion hazards arising from his/her machine as part of his/her risk assessment (MD Annex I, 1.5.6.). The operating instructions describe protective measures against fire and explosion hazards. The clause “Intended use” specifies the suitability for processing magnesium materials.

Machines which were placed on the market before the Machinery Directive entered into force in 1995 (old machines), are considered to be work equipment within the meaning of the Betriebssicherheitsverordnung (Industrial Safety Ordinance). In this case, the user must initially check whether the machine is suitable for machining magnesium materials within the scope of the intended use, and if the necessary protective measures against fire and explosion hazards are observed.

Requirements and protective measures against fire and explosion hazards for various machines and systems are described in Clause 2.

Fire-extinguishing agents

Due to the high combustion temperatures of magnesium of up to 3,000 °C and its reactivity with water (formation of oxyhydrogen gas), only special fire-extinguishing agents are suitable. In general, most fire-extinguishing agents for extinguishing magnesium fires are classified into fire class D (metal fires).

Therefore, the following fire-extinguishing agents are suitable for extinguishing burning magnesium:

- fire-extinguishing powder of fire class D
- dry magnesium covering salts
- dry and rustproof grey cast iron chips
- dry sand or dry cement
- special extinguishing agents with proven extinguishing effectiveness

Argon as a fire-extinguishing gas is only suitable for use in restricted, confined spaces (containers, technical installations), if an extinguishing concentration of the gas (< 4 % of residual oxygen content) is maintained for a sufficient period of time. An effect can only be achieved if the heavy inert gas argon forms a persistent insulating layer against the atmospheric oxygen.

Magnesium fires must not be extinguished with water or with common fire-extinguishing agents such as carbon dioxide or nitrogen, as burning magnesium reacts with them.

The following agents are not suitable for extinguishing burning magnesium:

- extinguishing powder of fire classes A, B and C
- water and water-containing substances
- carbon dioxide
- nitrogen

Instruction of employees

As part of the instruction, comprehensive information on the characteristics and hazards of magnesium and its fire behavior is absolutely essential.

This knowledge can be imparted in the course of a regularly conducted practical fire-fighting exercise. The use of the correct extinguishing agent, its storage location and the appropriate PPE and protective clothing against magnesium fires should be discussed. Under these conditions, the instructed employees can then extinguish small incipient fires on their own.

In general, the fire brigade must be informed in the event of a fire.

For useful information for instruction, see DGUV Leaflet **Fachbereich AKTUELL** FBHM-043 “Brand an Werkzeugmaschinen – Was ist zu beachten?” (English version: “Fire on machine tools – What has to be considered?”)

Notification of the fire brigade

Before starting work with magnesium, it is essential to inform the local fire brigade or the works fire brigade. It is reasonable to include the fire brigade in the preparation of a fire protection concept as well as the selection and quantity of suitable fire-extinguishing agents. The performance of regular fire-fighting exercises also increases safety.

It is also advisable to invite the local fire brigade to the exercises in order to introduce them to the localities in the event of an emergency. A fire brigade must also know the internal locations of the fire-extinguishing agents and the individual fire compartments.

Structural fire protection

If magnesium is machined or processed for the first time or if an existing hall is converted to magnesium machining, the existing fire protection concept must be adapted to the additional fire hazards. Additional fire protection measures may be required (see notes on construction equipment, DIN 4102, DIN EN 13501).

For example, sufficient fire-extinguishing agents of fire class D have to be provided in addition.

When converting an existing hall, it may be necessary to reconsider and modify the fire protection measures, for example a sprinkler system. The fire brigade can provide support.

First Aid

The organization of first aid in the company is one of the basic obligations of employers. First aid includes all measures that are necessary in the event of accidents, acute illness, poisoning and other emergencies until the arrival of the rescue service or a doctor. This includes, for example: securing the accident site, rescuing casualties from acute danger, initiating an emergency call, carrying out lifesaving emergency measures and caring for affected persons.

The “Small First Aid Box” according to DIN 13157 and the “Large First Aid Box” according to DIN 13169 cover the basic requirements for first aid material.

Additional materials may be required due to company-specific hazards.

Depending on the number of employees working in the company, a sufficient number of first aiders must be available. This task can be carried out by all employees. Prerequisite is the successful training in a first aid course and participation in regular refresher courses every two years (first aid training).

Working with magnesium chips involves a risk of injury from cuts, which can lead to protracted inflammations.

On the other hand, there is an increased risk of burns on contact with molten metal, crucibles and hot workpieces etc. in the casting area.

First aid measures are also described in the activity-related operating instructions, e. g. for the application areas of magnesium die casting, machining of magnesium, melting and molten metal treatment (see Annex).

6 Storage of magnesium chips and magnesium residues

The fire load caused by magnesium chips and other magnesium residues (e. g. dross, sludge, dust etc ...) in the working area must be kept low. A regular removal into storage areas which are outside the production area must be ensured.

In general, magnesium chips and residues come under the Ordinance on Hazardous Substances and must therefore be separated from other residual materials and fire loads.

The storage area and the containers used have to be properly marked in accordance with the Ordinance on Hazardous Substances.

Care must be taken to ensure that the moist chips which are conveyed out of the machine are fed directly into a collection container with limited volume or, in case of a high quantity, are directly conveyed to briquetting. It is recommended not to exceed a residual moisture content of the briquettes of 3 %.

When storing magnesium sludge in barrels or tippers, it has to be ensured that they do not overheat (hazard of exothermic reaction) and are not exposed to direct sunlight.

One possibility is to completely cover the contents of the barrels with water. The resulting reaction heat can cause a relatively strong evaporation. The barrels must be regularly checked and refilled with water, if necessary. The loss of water can lead to “boiling over”.

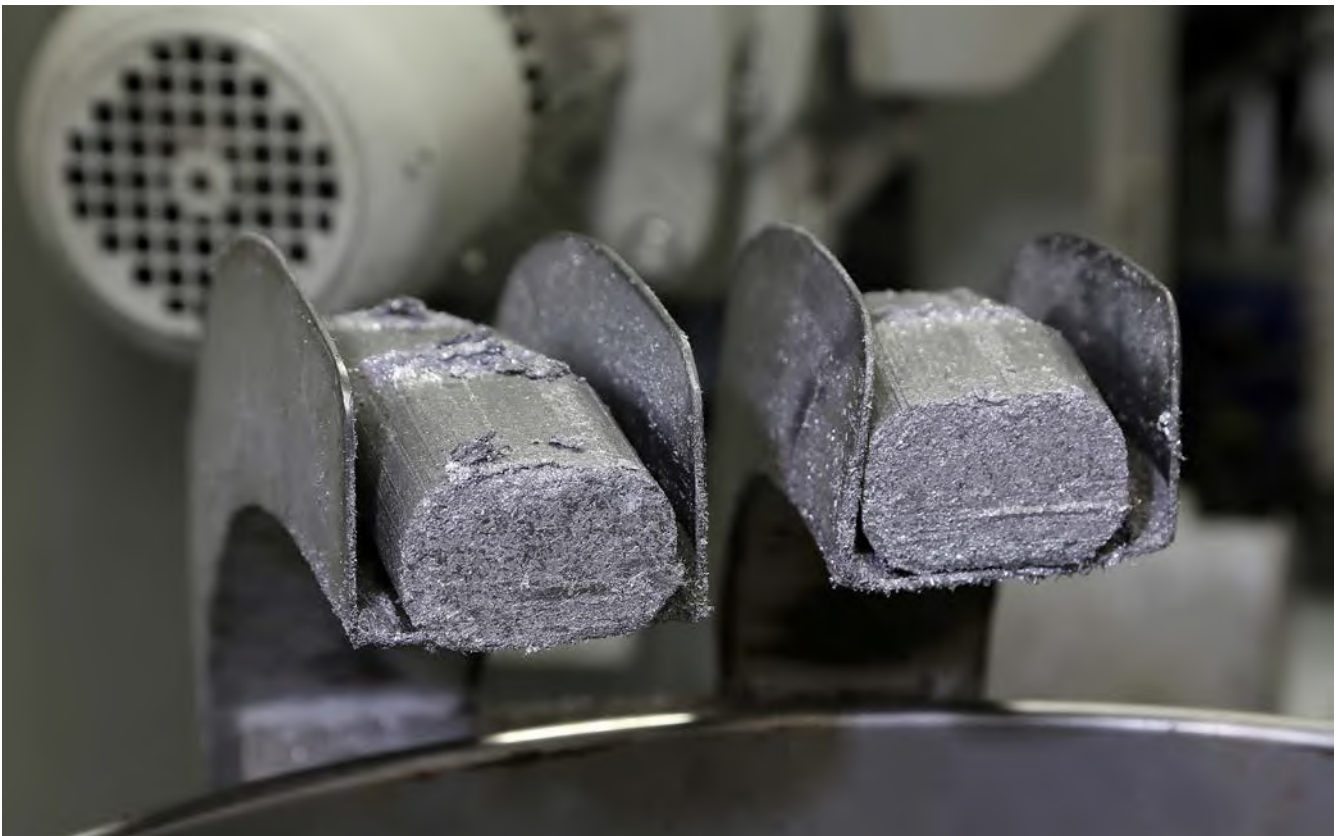

Figure 36 Briquetting system



Figure 37 Barrels with vents

Requirements for storage areas

Enough quantities of suitable extinguishing agent must also be available in storage areas.

A good ventilation must be ensured.

The storage areas have to be kept free from ignition sources (smoking ban, no sparking work, no battery charging points, etc.).

Dry and slightly oil-containing magnesium chips and dusts (e.g. minimum quantity lubrication) should be stored and transported in tightly sealed, non-combustible containers, for example steel barrels.

Dry storage protected from weather effects is required, as the ingress of moisture can lead to the formation of hydrogen or self-ignition.

For the storage and transport of moist magnesium chips and dusts which are wetted or soiled with water-mixed metalworking fluid, closed containers have to be provided, which are designed in such a way that released hydrogen can escape safely, for example with a vent in the cover area.

For the storage and transport of magnesium sludge, uncovered containers must be available from which released hydrogen can safely escape.

The containers must consist of suitable materials and marked in accordance with the Ordinance on Hazardous Substances.

Abrasive sludge, filter material covered with magnesium particles and dross should be stored outdoors, outside the production facility. The storage area must be roofed and protected against rain and lightning.

Magnesium should be stored

- protected from weather effects and strong sunlight,
- at a sufficient distance from buildings and
- in non-combustible containers with lid/cover.

Storage areas must be

- kept free from other combustible materials (wood, cardboard, etc ...),
- protected against unauthorized access and
- adequately marked.

7 Operating instructions

Operating instructions are addressed by the employer to the employees. The operating instructions govern the behavior at the factory premises to avoid accident and health hazards. They serve as a basis for instruction; see § 4 (1) of DGUV Regulation 1 “Principles of Prevention”.

Operating instructions must be drawn up taking into account, among other things, the operating instructions supplied by the manufacturers. This applies especially for the use of:

- machinery for the machining and processing of magnesium
- machinery for melting and casting magnesium
- melting, holding and pouring furnaces for magnesium

In general, operating instructions should provide material-related information, taking into account the following aspects:

- work area, workplace, activity
- hazards to both humans and the environment
- protective measures and rules of behaviour
- behavior in case of danger
- first aid
- proper disposal

(See § 14 of the Hazardous Substances Ordinance and Technical Rules for Hazardous Substances “Operating Instructions and Instruction according to § 20 GefStoffV” (TRGS 555)).

Besides information specific to magnesium, other safety-related information has to be included in addition, especially with regard to

- commissioning,
 - cleaning, maintenance and servicing,
 - the behavior in case of faults and tests
- and
- the behaviour in case of magnesium fires.

Operating instructions have to be drawn up in a comprehensible form and language so that they can be understood and followed by the employees. This can, for example, mean that operating instructions have to be written in the native language of the employees.

The operating instructions have to be made public in the factory. They can, for example, be published by a notice (notice board) in the factory or by issuing them to the employees.

The employees have to observe the operating instructions.

See also DGUV regulation 1 “Principles of prevention”.

Annex II includes templates/examples of operating instructions.

8 Identification of applied substances and magnesium

According to § 3a of the Workplace Ordinance in conjunction with figure 1.3 of the Annex, health and safety markings have to be used if the risks to safety and health can not otherwise be avoided or sufficiently minimized. The Technical Rule ASR A1.3 “Safety and Health Protection Signage” specifies the requirements for safety and health protection signage at workplaces. Accordingly, signs have to comply with this rule.

The following markings are frequently used especially for magnesium.

Outdoor rooms and storage locations with flammable areas must be marked at suitable positions, especially at the accesses, with the prohibition sign P003 “No open flame; fire, open ignition source and smoking prohibited”. Potentially explosive areas must be additionally marked with the warning sign D-W021 “Warning of explosive atmosphere”.



Outdoor rooms and storage locations where magnesium chips and dusts are stored have to be marked with the prohibition sign D-P006 “No unauthorized entry” at the entrances.



The prohibition on the use of water as a fire extinguishing agent has to be indicated by the prohibition sign P011 “Do not extinguish with water”.



Places, where fire extinguishing equipment and extinguishing agents are located have to be clearly and permanently marked with the fire protection symbol F001 “Fire extinguisher” or F004 “Collection of fire fighting equipment”.



Example of marking dry magnesium chips:

	<p>Magnesium chips</p> <p>Information on special hazards:</p> <ul style="list-style-type: none"> – highly inflammable – reacts with water to form highly inflammable gases <p>Safety advice:</p> <ul style="list-style-type: none"> – Keep container dry and tightly closed – Keep away from ignition sources – do not smoke – Do not inhale gas/smoke/vapour/aerosol – For extinguishing with fire extinguisher, use fire class D (metal fires). Do not use water. – Only use containers with pressure relief valve <p>Waste producer:</p>
<div style="border: 1px solid black; padding: 5px; width: fit-content; margin: 0 auto;">Hazard</div>	
<p>UN 1869</p>	

Further marking requirements can be found in the safety data sheet.

As an example, the information for magnesium chips are listed here:

Signal word “hazard”

Hazard statements – H-phrases:

H228: Flammable solid

H261: In contact with water releases flammable gas

Precautionary statements - P-phrases:

P210: Keep away from heat, hot surfaces, sparks, open flames and other ignition sources. No smoking.

P370+P378: In case of fire: Use metal fire powder for extinction.

P402+P404: Store in a dry place. Store in a closed container.

Transportation regulations

UN-number: 1869

Designation of hazardous material: Magnesium chips

Class: 4.1 (flammable solids)

Hazard identification number: 40

Packing group: III (material with low hazard)

Hazard label: 4.1



Tunnel restriction code: E

Annex 1

Checklists for instruction topics for activities relating to magnesium

Activities relating to magnesium

Activities relating to magnesium	Complied with	Not complied with
Do the employees know that magnesium can form elementary oxygen and hydrogen on contact with water and that this can provoke an oxyhydrogen reaction with violent explosions?		
Has the extreme heat development (hot flame of 3000°C) of a magnesium fire been discussed?		
Has the self-ignition potential of magnesium been discussed?		
Do the employees know that magnesium in a molten state reacts not only with moisture and atmospheric oxygen, but also with other substances? The contact with rust (Fe ₂ O ₃), for example, may lead to a thermite reaction with heat generation and subsequent fire.		
Has the ban on smoking and open flames been imposed on activities involving magnesium?		
Has it been mentioned that only specially trained persons are allowed to handle magnesium?		
Has the maintenance personnel been instructed on magnesium?		
Have third parties, such as personnel of external companies, visitors, suppliers, interns been instructed on magnesium?		
Has a ban on access to magnesium-processing areas been imposed on third parties?		
Has the external company's personnel been able to present all the necessary documents?		
Have the employees been informed about the places where they can learn about the hazards of magnesium?		
Have employees been informed on the special contact person for magnesium in the company?		
Have the employees been informed on the place where the operating instructions are located?		
Do employees know that magnesium particles can adhere to clothing during the deburring, brushing or grinding process of magnesium components? To prevent this, it is recommended to wear protective clothing with a smooth surface (e. g. rubber apron).		
Do employees – including the external company personnel – know the hazard they are exposed to when blowing off their work clothes with compressed air? In addition to the oxygen accumulated on the clothing and the adhering Mg dust particles from the processing of magnesium only an ignition source is necessary to trigger the fire. Open fires, hot surfaces and sparking tools can, for example, serve as ignition sources.		
Do the employees know that they should also change their work clothes accordingly when changing the work area (e. g. between steel and magnesium processing)?		
Do the employees know that they have to follow the washing instructions of the clothing manufacturer if they clean clothing soiled with magnesium.		
Do the employees know that synthetic fibre underwear can melt on the skin when exposed to heat and has to be surgically removed at the worst? Do they know the relevant company's clothing requirements?		
Are employees aware of the hazards (e. g. environmentally harmful, oxygen displacing or toxic properties) posed by the protective gas?		
Do the employees know about the occupational health precautions?		

Personal protective equipment

Personal protective equipment	Complied with	Not complied with
Do the employees know what kind of personal protective equipment they have to wear?		
Has the provision of PPE been agreed upon with external companies and temporary staff?		
Are there any differences in the individual areas of magnesium processing and machining with regard to personal protective equipment?		
Are the employees familiar with the handling and care of PPE?		
Have the employees practiced the correct use and the quick removal and “ejection” of PPE in an emergency when working in the immediate vicinity of the molten magnesium (e.g. working on melting furnaces, furnace platforms)?		

Assemblies and machines

Assemblies and machines	Complied with	Not complied with
Do the employees know that regular cleaning and maintenance are important and necessary for the proper functioning of the assemblies and extraction systems – especially with regard to the risk of fire and explosion?		
Do the employees know the relevant cleaning and maintenance schedules (e.g. for the extraction systems, but also for CNC machining centres, chip presses)?		
Do the employees know that cleaning and maintenance work has to be documented in the relevant plans and how it should be done?		
Do the employees know that chip accumulations should be avoided during machining with machine tools?		
Do employees make sure that they only use regularly inspected assemblies and machinery?		

In case of emergency











In case of emergency	Complied with	Not complied with
Do the employees – including the external company personnel – know that in the event of a fire, magnesium must not be extinguished with water or foam, nitrogen or carbon dioxide extinguishers, as otherwise the fire can be further intensified?		
Do the employees/external company personnel know that they best choose powder extinguishers of fire class D as extinguishing agent?		
Do the employees – including the external company personnel – know that in an emergency or in special cases cement, dry sand or grey cast iron chips can also be used to cover and thus contain the source of fire?		
Are the employees –including the external company personnel – aware of the fact that a magnesium fire can generally be extinguished only by removing oxygen (< 4 % oxygen content)?		
Do the employees – including the external company personnel – know the markings/labels of the extinguishers and are they able to distinguish between them?		
Do the employees – including the external company personnel – know the locations of the various extinguishers?		
Have the employees taken part in an extinguishing exercise of a magnesium fire in order to get to know and assess the behaviour of magnesium? In addition to extinguishing a fire with a powder extinguisher, has there been an extinguishing exercise carried out on a dummy (doll)?		
Do the employees know the necessary first aid measures for emergencies?		
Do the employees – including the external company personnel – know who to contact in an emergency and how to start the first aid chain?		
In the case of large company premises, is ensured that the rescue service is guided directly to the accident site without delay? Is the “guide” known and instructed?		



Storage and transport

Storage and transport	Complied with	Not complied with
Do the employees know that magnesium waste (e. g. chips, sludge, dust, dross) has to be stored separately in suitable containers (dry and protected from moisture)?		
Do employees know that closed containers have to offer the possibility of generated hydrogen to escape (e. g. vents)?		
Do employees know that large quantities of magnesium should be divided into smaller quantities and stored separately in a dry place (reducing the fire load)?		
Do the employees know that the chips produced are to be dried (residual moisture content < 3%) and, if possible, pressed into briquettes?		









Annex 2





Operating instructions







Operating instructions No. 0015 28.11.2017	SAMPLE – OPERATING INSTRUCTIONS	As at: Date Signature:
Scope and tasks		
SCOPE		
Melting and molten metal treatment of magnesium alloys		
HAZARDS FOR HUMANS AND ENVIRONMENT		
 HAZARD	<ul style="list-style-type: none"> • Risk of burns on contact with molten metal, crucible, hot workpieces, etc. • If magnesium alloys are heated in air up to their melting point, they ignite and burn with a glaringly bright flame. • If protective gas is applied, the maximum permissible concentration has to be reliably kept. • If water is used to extinguish a magnesium fire, explosive hydrogen gas develops. Danger of explosion! 	
PROTECTIVE MEASURES AND RULES OF BEHAVIOUR		
  	<ul style="list-style-type: none"> • Ingots must be stored in a dry place. All ingots and the return material must be preheated to a temperature of approx. _____°C (> 100°C) before use in the melting furnace in order to eliminate moisture. Do not use soiled ingots. • When working with liquid magnesium, the face must be protected against metal splashes. • In addition, wear the prescribed personal protective equipment: aluminized flame-resistant protective clothing, protective goggles, protective gloves, foundry boots. • Only dry and preheated equipment may come into contact with the molten metal. • Molten material, e. g. from skimming, must only be placed in dry, preheated steel containers with lids. • Rust and scale must not come into contact with liquid material. 	  
RULES OF BEHAVIOR IN CASE OF FAILURES		
	<ul style="list-style-type: none"> • Water must never be used to extinguish magnesium fires. • For extinguishing a magnesium fire, fire extinguishers of fire class D (metal fire powder extinguishers), extinguishing sand or dry sand can be used. • Extinguishing agents for fire classes A, B and C must not be used with magnesium, as they can even promote combustion. Water, foam extinguishing agents, carbon dioxide (CO₂), ABC and BC powders are not permitted. 	
BEHAVIOR IN CASE OF ACCIDENTS, FIRST AID		
	<ul style="list-style-type: none"> • Switch off machine/system. • Rescue injured people. • Provide First Aid. • Notify accident, internal emergency call: • Take care of your own safety when attempting to extinguish a fire. 	
MAINTENANCE, DISPOSAL		
	<ul style="list-style-type: none"> • Dross must not come into contact with water. Store dry. • Salt-containing dross has to be stored in suitable containers. • Used crucibles are recycled as steel scrap. 	











Operating instructions No 00 08.12.2017	SAMPLE – OPERATING INSTRUCTIONS Scope and tasks	As at: Date Signed on:	
SCOPE			
Working on magnesium die casting machines (DCM)			
HAZARDS FOR HUMANS AND ENVIRONMENT			
	<ul style="list-style-type: none"> • Hazards to health and safety by crushing and shearing points • Initiation of unexpected movements due to faults in parts of the control system • Noise • Ejection of metal • Increased concentrations of carbon dioxide, sulphur dioxide, tetrafluorethane • Increased fire risk – metal fires and subsequent fires 		
PROTECTIVE MEASURES AND RULES OF BEHAVIOUR			
	<ul style="list-style-type: none"> • When entering the magnesium area, the specific PPE provisions have to be observed. This also applies to visitors. • Restricted access provisions for hazard zone “oven” have to be observed. • The machine operator has to check all safety devices for proper functioning at the beginning of each work shift. • Before starting work on clamped tools or repair work on the die casting machine, the machine must be switched off via the main switch. The main switch has to be secured by a padlock against restart by all people working on the machine. • Before the DCM is restarted, the responsible employees have to ensure that <ul style="list-style-type: none"> – all safeguards are properly closed, – no persons are present in the traversing range of machine parts, tool and piston. • The machine must also be switched off via the main switch during set-up work (e.g. mold installation, piston rod and ejector installation), as far as the work permits. • Magnesium ingots have to be dried and preheated before use. • Smoking is forbidden. • Carrying foreign objects (mobile phones, torches, ...) in the protective clothing when entering the furnace is prohibited (hazard of deflagration when foreign objects fall into the molten metal). • Metal fires must only be extinguished with fire extinguishers of class D (metal fire) and extinguishing salt. For subsequent fires, (cable, lines, oil, ...) ABC extinguishers have to be used. • For every work on the furnace, the protective clothing provided for this purpose (according to PPE specification MG smelter) has to be worn. • Ignition sources within a radius of 5 meters around open containers with chips and dust are prohibited. • Waste has to be kept separately in accordance with the signs. • Waste containers must always be covered. • Full waste containers have to be removed from the machine immediately. • The working areas have to be kept clean and dry. No accumulation of water (e.g. in the dross container or in the drip tray). • The work surroundings must always be kept clean. No magnesium dust, magnesium residues etc. in the area around the furnace, in particular in the area of the cleaning flaps. 		



	<ul style="list-style-type: none"> • The drip trays under the piston and the casting plant must be cleaned regularly from oil, magnesium residues etc. • The following rules of behaviour apply during furnace cleaning (bottom sludge removal, molten bath surface cleaning): <ul style="list-style-type: none"> – Cleaning must only be carried out by specially trained magnesium smelters if a second person is within sight and calling distance at the same time. – Cleaning must only be carried out with the machine at a standstill. – Only dry, heated and specially designed tools for cleaning the furnace must be used. – Cleaning must only be carried out when the furnace is not being charged. – Cleaning work on the furnace must only be carried out if the furnace temperature does not exceed 720°C (or critical temperature of molten MG). • The furnace flaps must be kept closed during operation. • Only <u>one</u> furnace flap may be opened at a time for cleaning. • If chemical reactions are detected in the furnace (e. g. burning melt), the furnace flap has to be closed immediately and the danger zone has to be left. 	
RULES OF BEHAVIOUR IN CASE OF FAILURE AND HAZARD		
	<p>All employees must immediately report any damage, defects, malfunctions, irregularities in the operation of the die casting machine and the furnace to their superiors (and enter them in the shift report). If there is a fault that impairs safety, the system must be shut down immediately. Work may only continue after the fault has been eliminated. If liquids or objects enter the molten metal unexpectedly, the entire personnel must immediately move away from the furnace. There is a danger to life due to deflagrations in the molten metal.</p>	
BEHAVIOUR IN CASE OF ACCIDENTS – FIRST AID		
	<ul style="list-style-type: none"> • Keep calm. • Notify accident (phone ____). • Instruct rescue team. • Provide First Aid. • Notify accident to superiors. • In case of gas alarm (CO₂, N₂, natural gas), the hazard zone has to be left. • In case of fires, actuate manual fire alarm device (media such as oil, water, air are isolated). • Think of you own safety when attempting to extinguish a fire. 	
MAINTENANCE, DISPOSAL		
	<ul style="list-style-type: none"> • Die casting machines are regularly checked annually for proper condition by a competent person (inspections according to BetrSichV). The competent person has to be informed before the first use or after repair. 	

Number: G1-00 Status: Date Workplace/Place of activity: Sample area	Operating instructions according to GefStoffV	Company: Sample Ltd. Signature:
1. NAME OF HAZARDOUS SUBSTANCE		
Magnesium, chips and sludge applies to: machining of magnesium parts		
2. HAZARDS FOR HUMANS AND ENVIRONMENT		
 HAZARD	<ul style="list-style-type: none"> • Fire hazard due to ignition of fine chips because of electrostatic discharge, sparking tools, contact with electrical conductors (current), electrical discharges (e.g. lightning), open fire, embers or hot surfaces. • Explosion hazard: <ul style="list-style-type: none"> – Reacts with water, acids, alkalis to form hydrogen. – Reacts with strong oxidizing agents, halogenated hydrocarbons (chloroform, dichloromethane), metal oxides (iron oxide/rust, copper oxide) under violent heat generation. In case of uncontrolled reaction danger of explosion arises. – Dusts < 0.5 mm are explosive in sufficient concentration. • Risk of injury: Magnesium chips can lead to protracted injuries (inflammations). 	
3. PROTECTIVE MEASURES AND RULES OF BEHAVIOUR		
  	<ul style="list-style-type: none"> • Only authorised persons are allowed to carry out work after having been instructed. • There is an absolute ban on fire and smoking at processing machines and in storage rooms. Work involving a risk of fire or ignition must be reported (Permit No. xxxx). • Spilled water must be removed immediately (binding agent, wet vacuum cleaner of the department). • Ensure sharp tools and optimum cutting speed (Mg permissible) on assemblies! • During machining, flush cooling has to be applied so that the chips are sufficiently cooled. Surface temperatures must be below 300°C. • When using compressed air, whirling-up of dust and chip spreading must be absolutely avoided. • Fire protection equipment must only be deactivated on the provision of alternative measures. • Do not use open sockets or electrical devices in potentially explosive areas (e.g. when hydrogen, mist or vapours of combustible, non-water-miscible metalworking fluids or magnesium dust are produced in relevant concentrations). Explosion-proof design test and earthing test. • In areas where there is a risk of fire, i.e. in areas where there is a risk of explosion and within a radius of 3 m around the sources and outlets of hydrogen, Mg dust, Mg chips, as well as during their storage: Surface temperatures must be below the ignition temperature/glow temperature of the dust/chips and that of any explosive atmosphere present. Open heating systems are not permitted. No open sockets/electrical devices. • Use of PPE: protective gloves (mechanical hazards, possibly hazardous substances), protective goggles (chips), conductive protective shoes. Clothing which has been exposed to magnesium (dust, chips etc.) must not be worn for any further work (e.g. welding, milling, handling flammable substances) – hazard of a dust fire. • Alternating/simultaneous machining of Mg and sparking materials (especially ferrous materials) is not permitted without prior thorough cleaning of the equipment. Chips on the floor outside the assemblies must also be collected. • Working areas must be cleaned of dust and chips regularly, at least every working day. Use mechanical cleaning aids or an approved, marked vacuum cleaner. 	   

4. BEHAVIOUR IN CASE OF HAZARD		
	<ul style="list-style-type: none"> • In case of fire, do not use water but suitable extinguishing agents (metal fire powder – class D, cement or dry sand). • In the event of fire, dangerous combustion gases and vapours may be produced. • Clear the area. Warn other workers. • After spillage: Absorb dry. Avoid dust. Initiate disposal. • In case of emergency ☎:112/110 Fire brigade/police call for help. 	
5. FIRST AID		
	<p>In case of burns, cool and rinse with plenty of water.</p> <p>After eye contact: Immediately rinse extensively with water (at least 10 minutes) with eyelids open, protecting the uninjured eye. After skin contact: Change contaminated clothing if necessary.</p> <p>First aiders:</p>	
6. PROPER DISPOSAL		
	<p>Storage of dusts and chips in lockable (overpressure compensation), non-combustible containers with sufficient hazardous material identification. Separate collection regulation! Do not mix with other fractions! Risk of spontaneous combustion.</p>	
	Contact person:	

Number: xyxy Status: Date Workplace/place of activity: Sample area	Operating instructions according to GefStoffV	Company: Sample Ltd.
1. NAME OF HAZARDOUS SUBSTANCE		
Magnesium, grinding dusts Applies to: Dry grinding of magnesium components		
2. HAZARDS FOR HUMANS AND ENVIRONMENT		
 HAZARD	H 228 Flammable solid H 251 Self-heating; may catch fire H 261 In contact with water releases flammable gases	
3. PROTECTIVE MEASURES AND RULES OF BEHAVIOUR		
	<ul style="list-style-type: none"> • The cleanliness at the workplace has top priority when handling magnesium. • Keep a suitable extinguishing agent (e. g. metal fire powder, fire class D) ready in case of fire. • Extract grinding dust as close as possible to the point of origin and feed it to the wet scrubber. • Blowing off dust is not permitted. • Avoid the whirling up of dust during cleaning processes. • Wear suitable smooth protective clothing (rubber or leather apron) and safety goggles during work. • Clean or change clothes contaminated with Mg dust. • Open flames, fire, open sources of ignition and smoking are prohibited. • Avoid sparking. • Clean the workplace regularly and vacuum up deposited dust (at least B1 – industrial vacuum cleaner). 	 
4. BEHAVIOUR IN CASE OF HAZARD		
	<ul style="list-style-type: none"> • In case of fire, use suitable extinguishing agents (e. g. metal fire powder fire class D). • Never extinguish the magnesium fire with water. • In the event of fire, dangerous combustion gases and smoke may be generated. • In case of emergency ☎: 112/110 call fire brigade/police for help. 	
5. FIRST AID		
	<ul style="list-style-type: none"> • In case of burns, cool and rinse with plenty of water. • After eye contact: Rinse with water for at least 10 minutes with eyelid open. Consult an ophthalmologist, if necessary. • First-aider: _____ Accident physician: _____ 	
6. PROPER DISPOSAL		
	<ul style="list-style-type: none"> • Collection of dusts and sludge separately in marked and non-combustible containers. • Store moist sludge in containers with ventilation outside the working area. • Caution: Observe the danger of spontaneous combustion with moist sludge! 	
Date: Next inspection date:	Signature: Management	

Number: M3-00 State: Date Workplace/place of activity: Sample area	Operating instructions	Company: Sample Ltd. Signature:
1. SCOPE		
Mechanical processing and storage of magnesium materials and waste		
2. HAZARDS FOR HUMANS AND ENVIRONMENT		
 HAZARD	<p>Failure to comply with the provisions of the operating instructions may lead to the risk of serious injuries or death.</p> <ul style="list-style-type: none"> • Fire hazard due to ignition of (dust or) fine chips because of electrostatic discharge, sparking tools, contact with electrical conductors (current), electrical discharges (e.g. lightning), open fire, embers or hot surfaces. • Explosion hazard: a) by reaction with water and formation of oxyhydrogen gas b) Dusts < 0.5 mm are explosive in sufficient concentration. • Risk of injury: Magnesium chips can lead to protracted injuries (inflammations). 	 
3. PROTECTIVE MEASURES AND RULES OF BEHAVIOR		
  	<ul style="list-style-type: none"> • Only authorized persons are allowed to carry out work after having been instructed. • There is an absolute ban on fire and smoking at the processing machine and in storage rooms. • Work involving a risk of fire or ignition must be reported (Permit xy). • Use hearing protection in noisy areas! • Ensure sharp tools and optimum cutting speed (Mg permissible) on assemblies! • During machining, flush cleaning has to be applied so that the chips are sufficiently cooled. Surface temperatures must be below 300 °C. • When using compressed air: whirling-up of dust and chip spreading must be absolutely avoided. • Fire protection equipment must only be deactivated on the provision of alternative measures. • Prevent potentially explosive areas. (They occur, for example, when hydrogen is present, when mist/vapours of combustible, non-water-miscible metalworking fluids are formed, when Mg dusts are generated). No open sockets/electrical devices. Explosion-proof design test and earthing test. • In areas where there is a risk of fire, i.e. in areas where there is a risk of explosion and within a radius of 3 m around the sources and outlets of hydrogen, Mg dust and Mg chips, as well as during their storage: Surface temperatures must be below the ignition temperature/glow temperature of the dust/chips and that of any explosive atmosphere present. Open heating systems are not permitted. No open sockets/electrical devices. • Storage of dusts and chips in lockable (overpressure compensation) non-combustible containers with sufficient hazardous material identification. Separate collection bid! Do not mix with other fractions! Risk of spontaneous combustion. • Clothing which has been exposed to magnesium (dust, chips, etc.) must not be worn for any further work (e.g. welding, milling, handling flammable substances) – hazard of a dust fire! • Alternating/simultaneous machining of Mg and sparking materials (especially ferrous materials) is not permitted without prior thorough cleaning of the equipment. Chips on the floor outside the assemblies must also be collected. • Working areas must be cleaned of dust and chips regularly, at least every working day. Use mechanical cleaning aids or an approved, marked vacuum cleaner. 	   

4. BEHAVIOUR IN CASE OF FAILURES		
	<ul style="list-style-type: none"> • Remove spilled water immediately (binding agent, wet vacuum cleaner of the department). • Do not extinguish burning magnesium with water! Use type D powder extinguishers or sand on site. 	
5. FIRST AID		
	<p>Emergency call/fire brigade: Phone: _____ or 112 Ambulance:</p> <ul style="list-style-type: none"> • Rescue injured or endangered persons from danger area. • Provide first aid and initiate an emergency call. • Warn other employees and attempt to extinguish the fire, taking own safety into account. 	
6. MAINTENANCE AND DISPOSAL		
	<ul style="list-style-type: none"> • For questions regarding disposal, contact the person in charge. Phone: Observe waste manual! 	

Annex 3

Cleaning and maintenance schedules

Cleaning schedule taken from DGUV Information 209-024

Company:	Cleaning schedule	No.:
		Date:
Work area: Workplace: Machine no.:		
Cleaning of pollution and accumulations inside the machine tool		
1. Purpose:	Cleaning inside the machine (metal dust and oil deposits) according to the maintenance and cleaning intervals.	
2. Application:	For machine tools operated with minimum quantity lubrication.	
2.1 Slightly polluted systems:	Execution with an interruption in production (end of shift).	
2.1.1 Cleaning agent:	Cloth or brush	
2.1.2 Execution:	a) Remove chip accumulations and swarf on horizontal surfaces and projecting parts. b) Remove moist residues and deposits on the inner walls of the machine and have the chip conveyor carry them away. c) Check extraction point of the machine. Clean chip screens (prevent clogging).	
2.2 Medium-to-heavy pollution of systems:	Execution with an interruption in production.	
2.2.1 Cleaning agent:	Cleaning with low pressure devices (pressure: 3 to 7.5 bar).	
2.2.2 Execution:	Clean off deposits on surface of machine interior with water jet and lance. Possibly add a cleaning emulsion to improve cleaning and add corrosion protection (read supplier information).	
2.3 Heavily polluted systems (stubborn soiling, caking):	Execution with an interruption in production.	
2.3.1 Cleaning agent:	Jet cleaning with dry ice	
2.3.2 Execution:	Use compressed air to shoot frozen CO ₂ pellets the size of rice grains onto the surface to be cleaned. Dislodge the brittle layer of pollution from the surface. Remove the pollution with the chip conveyor. Important: – Very noisy; wear ear protection. – Work only with protective clothing/protective suit. – Do no work in small, poorly ventilated spaces: Danger of CO ₂ accumulation!	
Name:	Signature:	

Annex 4

Bibliography

In the following, the pertinent regulations, rules and information which are to be observed are listed:

1. Acts, Ordinances

Reference:

Book shops and Internet

e. g. ▶ www.gesetze-im-internet.de

- **Produktsicherheitsgesetz (ProdSG) (German)**
Product Safety Act
- **Neunte Verordnung zum Produktsicherheitsgesetz (Maschinenverordnung – 9.ProdSV)**
9th Ordinance to the Product Safety Act

2. Regulations and Information for Occupational Health and Safety

Reference:

To be obtained from your responsible insurer.

For addresses see ▶ www.dguv.de/publikationen

- **DGUV Regulation 1 “Principles of prevention”**

Rules

- DGUV Rule 109-003 “Tätigkeiten mit Kühlschmierstoffen”
- DGUV Rule 112-190 “Benutzung von Atemschutzgeräten”

Informationen

- DGUV Information 209-024 “Minimalmengenschmierung in der spanenden Fertigung”
- DGUV Information 209-025 “Minimum quantity lubrication for machining operations”
- DGUV Information 209-026 “Brand- und Explosionsschutz an Werkzeugmaschinen beim Einsatz brennbarer Kühlschmierstoffe”
- DGUV Information 209-027 “Machine tool fire and explosion, prevention and protection”
- DGUV Information 209-084 “Industriestaubsauger und Entstauber”
- DGUV Information 212-013 “Hitzeschutzkleidung”
- Fachbereich AKTUELL FBHM-043 “Brand an Werkzeugmaschinen – Was ist zu beachten?” English version: “Fire on machine tools – What has to be considered?”
- Fachbereich AKTUELL FBHM-051 “Trockenschleifen von Magnesium – Was ist zu beachten?” Ausgabe 11/2010

- Fachbereich AKTUELL FBHM-088 “Minimalmengenschmierung (MMS) – Risiko von Bränden und Explosionen” Ausgabe 02/2017

3. Standards/VDI-regulations

Reference:

Beuth-Verlag GmbH, Burggrafenstraße 6, 10787 Berlin or VDE-Verlag, Bismarckstraße 33, 10625 Berlin

- **9th Ordinance** to the Product Safety Act – Machinery Directive 2006/42/EC of the European Parliament and the Council on machinery
- **DIN EN 397:2013-04**
“Industrial safety helmets”
- **DIN EN 407:2004-11**
“Protective gloves against thermal risks (heat and/or fire)”
- **DIN EN 869:2009-12**
“Safety of machinery – Safety requirements for pressure metal diecasting units”
- **DIN EN 1753:1997-08**
“Magnesium and magnesium alloys – Magnesium alloy ingots and castings”
- **DIN EN 12421: 2017-05:**
“Magnesium and magnesium alloys – Unalloyed magnesium”
- **DIN EN 13501-1:2019-05**
“Fire classification of construction products and building elements – Part 1: Classification using data from reaction to fire tests”
- **DIN EN 60079-0:2019-09**
“Explosive atmospheres – Part 0: Equipment – General requirements”
- **DIN EN 60204-1:2007-06 (2019-06)**
“Safety of machinery – Electrical equipment of machines –Part 1: General requirements”
- **DIN ISO 3448:2010-02**
Industrial liquid lubricants - ISO viscosity classification (ISO 3448:1992)
- **DIN EN ISO 2592:2018**
Petroleum and related products - Determination of flash and fire points - Cleveland open cup method
- **DIN EN ISO 6942:2002-09**
“Protective clothing – Protection against heat and fire – Method of test: Evaluation of materials and material assemblies when exposed to a source of radiant heat.”

- **DIN EN ISO 9151:2017-05**
“Protective clothing against heat and flame – Determination of heat transmission on exposure to flame” (ISO 9151:2016, Corrected version 2017-04-01)
- **DIN EN ISO 9185:2007-09**
“Protective clothing – Assessment of resistance of materials to molten metal splash (ISO 9185:2007)”
- **DIN EN ISO 12127-1:2016-05**
“Protective clothing – Clothing to protect against heat and flame - Minimum performance requirements”
- **DIN EN ISO 15025:2017-04**
“Protective clothing – Protection against flame – Method of test for limited flame spread”
- **DIN EN ISO 19353:2016-07**
“Safety of machinery – Fire prevention and fire protection”
- **DIN 4102-1:1998-05**
“Fire behaviour of building materials and building components – Part 1: Building materials; concepts, requirements and tests”
- **DIN 51562-1:1999**
Viscometry – Measurement of kinematic viscosity by means of the Ubbelohde viscometer
- **DIN 51581-1:2011-09**
Testing of petroleum products - Determination of evaporation loss – Part 1: Noack test
- **DIN 51581-2:1997-05**
Testing of petroleum products - Determination of evaporation loss – Part 2: Gas chromatographic method
- **DIN 13157:2009-11**
“First aid material – First aid box C”
- **DIN 13169:2009-11**
“First aid material – First aid box E”
- **VDI 2262 Blatt 4: 2006-13**
“Workplace air – Reduction of exposure to air pollutants – Capture of air pollutants”
- **VDI 3035:2008-05**
“Design of machine tools, production lines and peripheral equipment for the use of metalworking fluids”
- **VDI 3802 Blatt 2:2012-03**
“Air conditioning systems for factories – Capture of air pollutants at machine tools removing material”

Technical rules

- Technische Regeln für Arbeitsstätten
Technical Rules for Workplaces
– ASR A1.3 “Sicherheits- und Gesundheitsschutzkennzeichnung”, 07:2017
- Technische Regeln für Gefahrstoffe
Technical Rules for Hazardous Substances
– TRGS 500 “Schutzmaßnahmen”, 05:2008
– TRGS 555 “Betriebsanweisung und Information der Beschäftigten”, 02/2017
– TRGS 900 “Arbeitsplatzgrenzwerte”, 01/2006, zuletzt geändert und ergänzt 01/2018

Further sources/references:

- IFA workbook “Measuring hazardous substances”, category 6

Picture credits

Front cover:		©vchalup - stock.adobe.com
Figure 1,	Page 6	Minimax Fire Solutions International GmbH
Figure 2,	Page 7	Joyson Safety Systems Aschaffenburg GmbH
Figure 3,	Page 8	DMP Multimediaagentur, Stefan Schipke
Figure 4,	Page 10	Joyson Safety Systems Aschaffenburg GmbH
Figure 5,	Page 11	Grob-Werke GmbH & Co. KG
Figure 6,	Page 13	Grob-Werke GmbH & Co. KG
Figure 7,	Page 14	Andreas Stihl AG & Co. KG
Figure 8,	Page 15	Grob-Werke GmbH & Co. KG
Figure 9,	Page 16	Grob-Werke GmbH & Co. KG
Figure 10,	Page 16	Grob-Werke GmbH & Co. KG
Figure 11,	Page 17	Grob-Werke GmbH & Co. KG
Figure 12,	Page 18	Grob-Werke GmbH & Co. KG
Figure 13,	Page 20	DMP Multimediaagentur, Stefan Schipke
Figure 14,	Page 20	DMP Multimediaagentur, Stefan Schipke
Figure 15,	Page 21	Andreas Stihl AG & Co. KG
Figure 16,	Page 21	KSM CASTINGS GROUP GMBH
Figure 17,	Page 21	KSM CASTINGS GROUP GMBH
Figure 18,	Page 22	Druck- und Spritzgusswerk Hettich GmbH & Co. KG
Figure 19,	Page 22	Druck- und Spritzgusswerk Hettich GmbH & Co. KG
Figure 20,	Page 22	Jutec Hitzeschutz und Isoliertechnik GmbH
Figure 21,	Page 24	Druck- und Spritzgusswerk Hettich GmbH & Co. KG
Figure 22,	Page 24	BDG – Bundesverband der deutschen Gie.erei-Industrie
Figure 23,	Page 25	Joyson Safety Systems Aschaffenburg GmbH
Figure 24,	Page 26	Joyson Safety Systems Aschaffenburg GmbH
Figure 25,	Page 26	Joyson Safety Systems Aschaffenburg GmbH
Figure 26,	Page 27	Druck- und Spritzgusswerk Hettich GmbH & Co. KG
Figure 27,	Page 28	Druck- und Spritzgusswerk Hettich GmbH & Co. KG
Figure 28,	Page 29	Jutec Hitzeschutz und Isoliertechnik GmbH
Figure 29,	Page 30	DMP Multimediaagentur, Stefan Schipke
Figure 30,	Page 30	DMP Multimediaagentur, Stefan Schipke
Figure 31,	Page 30	DMP Multimediaagentur, Stefan Schipke
Figure 32,	Page 31	DMP Multimediaagentur, Stefan Schipke
Figure 33,	Page 31	Jutec Hitzeschutz und Isoliertechnik GmbH
Figure 34,	Page 32	EN 407
Figure 35,	Page 32	Jutec Hitzeschutz und Isoliertechnik GmbH
Figure 36,	Page 36	Andreas Stihl AG & Co. KG
Figure 37,	Page 37	Joyson Safety Systems Aschaffenburg GmbH

Deutsche Gesetzliche
Unfallversicherung e.V. (DGUV)

Glinkastraße 40
10117 Berlin
Tel.: 030 288763800
Fax: 030 288763808
E-Mail: info@dguv.de
Internet: www.dguv.de