

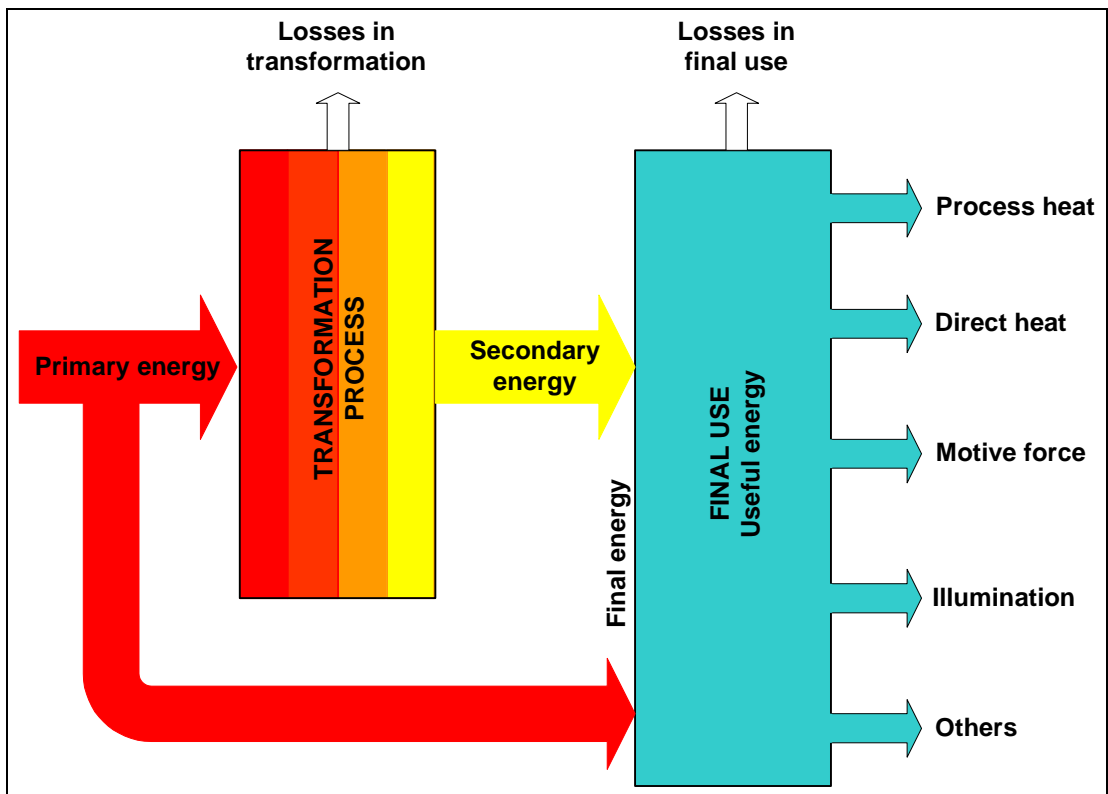

Reference Document on Best Available Techniques for

Energy Efficiency

February 2009



This document is one from the series of documents listed below:

Reference Document on Best Available Techniques . . .	Code
Large Combustion Plants	LCP
Mineral Oil and Gas Refineries	REF
Production of Iron and Steel	I&S
Ferrous Metals Processing Industry	FMP
Non Ferrous Metals Industries	NFM
Smitheries and Foundries Industry	SF
Surface Treatment of Metals and Plastics	STM
Cement, Lime and Magnesium Oxide Manufacturing Industries	CLM
Glass Manufacturing Industry	GLS
Ceramic Manufacturing Industry	CER
Large Volume Organic Chemical Industry	LVOC
Manufacture of Organic Fine Chemicals	OFC
Production of Polymers	POL
Chlor-Alkali Manufacturing Industry	CAK
Large Volume Inorganic Chemicals – Ammonia, Acids and Fertilisers Industries	LVIC-AAF
Large Volume Inorganic Chemicals – Solid and Others industry	LVIC-S
Production of Speciality Inorganic Chemicals	SIC
Common Waste Water and Waste Gas Treatment/Management Systems in the Chemical Sector	CWW
Waste Treatments Industries	WT
Waste Incineration	WI
Management of Tailings and Waste-Rock in Mining Activities	MTWR
Pulp and Paper Industry	PP
Textiles Industry	TXT
Tanning of Hides and Skins	TAN
Slaughterhouses and Animals By-products Industries	SA
Food, Drink and Milk Industries	FDM
Intensive Rearing of Poultry and Pigs	IRPP
Surface Treatment Using Organic Solvents	STS
Industrial Cooling Systems	ICS
Emissions from Storage	EFS
<i>Energy Efficiency</i>	<i>ENE</i>
Reference Documents on ...	
General Principles of Monitoring	MON
Economics and Cross-Media Effects	ECM

Electronic versions of draft and finalised documents are publicly available and can be downloaded from <http://eippcb.jrc.ec.europa.eu/>.

EXECUTIVE SUMMARY

This BAT (Best Available Techniques) Reference Document (BREF) reflects an information exchange on best available techniques, associated monitoring and developments in them, carried out under Article 17(2) of Directive 2008/1/EC (IPPC Directive). This executive summary describes the main findings, and provides a summary of the principal BAT conclusions. It should be read in conjunction with the preface, which explains this document's objectives; how it is intended to be used and legal terms. It can be read and understood as a standalone document but, as a summary, it does not present all the complexities of this full document. It is therefore not intended as a substitute for this full document as a tool in BAT decision making.

Energy efficiency (ENE)

Energy is a priority issue within the European Union (EU), for three related reasons:

- climate change: the burning of fossil fuels to release energy is the major anthropogenic source of greenhouse gases
- the continuing large scale use of irreplaceable fossil fuels, and the need to achieve sustainability
- security of supply: the EU imports over 50% of its energy fuel supplies, and this is expected to rise to more than 70% in the next 20 to 30 years.

There are therefore many important high level policy statements addressing these issues, such as:

'We intend jointly to lead the way in energy policy and climate protection and make our contribution to averting the global threat of climate change.' Berlin Declaration (Council of Ministers, 50th anniversary of the Treaty of Rome, Berlin, 25 March 2007).

Increased efficiency in the use of energy is the quickest, most effective and most cost-effective way to tackle these issues. There are legal instruments and other tools for implementing energy efficiency and this document has been prepared taking account of these other initiatives.

Mandate of the work

This document was specifically mandated by a special request from the Commission Communication on the implementation of the European Climate Change Programme (COM (2001)580 final) E CCP concerning energy efficiency in industrial installations. The E CCP asked that effective implementation of the energy efficiency provisions of the IPPC Directive are promoted and that a special horizontal BREF (BAT reference document) addressing generic energy efficiency techniques should be prepared.

Scope of this document

The IPPC Directive requires that all installations are operated in such a way that energy is used efficiently, and one of the issues to be taken into account in determining BAT for a process is its energy efficiency. For activities prescribed in the Emissions Trading Scheme Directive (Council Directive 2003/87/EC), Member States may choose not to impose requirements relating to energy efficiency in respect of combustion units or other units emitting carbon dioxide on the site. However, in such cases, energy efficiency requirements still apply to all other associated activities on the site.

This document therefore contains guidance and conclusions on techniques for energy efficiency that are considered to be compatible with BAT in a generic sense for all installations covered by the IPPC Directive. This document also gives references to BREFs where particular techniques for energy efficiency have already been discussed in detail, and can be applied to other sectors. In particular:

- the LCP BREF discusses energy efficiency relating to combustion and points out that these techniques may be applied to combustion plants with a capacity below 50 MW
- the ICS BREF discusses industrial cooling systems.

This document does not:

- include information specific to processes and activities in sectors covered by other BREFs
- derive sector-specific BAT.

However, a summary of sector-specific BAT for energy efficiency from other BREFs can be found for information in the EIPPCB workspace [283, EIPPCB].

This document was prepared in response to the request to promote the energy efficiency provisions of the IPPC Directive. It takes the efficient use of energy as the first priority, and therefore does not discuss renewable or sustainable energy resources, which are addressed elsewhere. However, it is important to note that the use of sustainable energy sources and/or 'wasted' or surplus heat may be more sustainable than using primary fuels, even if the energy efficiency in use is lower.

Structure and contents of this document

Energy efficiency is a horizontal issue in IPPC permitting, and as noted in the BREF outline and guide, this document does not completely follow the normal structure. In particular, because of the wide diversity of industries and activities addressed, there is no section dealing with consumptions and emissions. There are some guideline values for potential energy savings given for some techniques to consider for BAT, and a large number of examples are included in the annexes, to help users identify the most effective techniques to achieve energy efficiency in a specific situation.

Chapter 1 gives some background information on industrial energy consumption and energy efficiency issues in IPPC. It then gives a non-expert introduction to key issues such as: economics and cross-media issues, terms used in energy efficiency (such as energy, heat, work, power) and the important laws of thermodynamics: in particular, the first law states that energy can neither be created nor destroyed (it is transformed from one form to another): this means that energy can be accounted for in a process or installation, enabling efficiencies to be calculated. The second law shows that no energy transformation can result in 100 % useful work, and there are always some losses as low grade heat or energy; therefore, no process or machine can be 100 % efficient. The chapter then discusses energy efficiency indicators, the importance and problems of defining the energy efficiency and the boundaries of the systems and units they relate to. The chapter also demonstrates the need to optimise energy efficiency for systems and installations, and not at a component level.

Chapter 2 considers techniques to achieve ENE that can be applied at an installation level. It starts with discussing energy efficiency management systems (ENEMS), then discusses techniques which support the implementation of an ENEMS. These include: the importance of planning actions and investments in an integrated way to continuously minimise the environmental impact of an installation, the consideration of the installation and its systems as a whole, using energy efficiency design and selecting energy efficient process technologies for new and upgraded installations, increasing ENE by increasing process integration, and refreshing the ENEMS periodically. Other techniques supporting the ENEMS are maintaining sufficient staff expertise, communication of ENE issues, effective process control and

maintenance, monitoring and measuring energy usage, energy auditing, analytical tools such as pinch, exergy and enthalpy analyses and thermoeconomics, and monitoring and benchmarking ENE levels for installations and processes.

Chapter 3 considers techniques for energy efficiency in systems, processes and equipment using energy such as: combustion, steam, heat recovery, cogeneration, electrical power supplies, electric motor-driven subsystems, pumping systems, heating, air conditioning and ventilation, lighting, and drying and separation. When combustion is an important part of an IPPC process (such as melting furnaces), the techniques used are discussed in the appropriate vertical BREFs.

Best available techniques

The BAT chapter (Chapter 4) identifies those techniques considered to be BAT at a European level, based on the information in Chapters 2 and 3. The following text is a summary of this BAT chapter, and the full chapter remains the definitive text for BAT conclusions.

No associated energy savings or efficiency values could be derived and/or agreed for this horizontal document. Process-specific BAT for energy efficiency and associated energy consumption levels are given in the appropriate sector-specific (vertical) BREFs. BAT for a specific installation is therefore a combination of the specific BAT in the relevant sector BREFs, specific BAT for associated activities that may be found in other vertical BREFs (such as the LCP BREF for combustion and steam), and the generic BAT presented in this document.

The purpose of the IPPC Directive is to achieve integrated prevention and control of pollution, leading to a high level of protection of the environment as a whole, including the energy efficiency and the prudent use of natural resources. The IPPC Directive provides for a permitting system for specified industrial installations, requiring both operators and regulators to take an integrated, overall view of the potential of an installation to consume and pollute. The overall aim of such an integrated approach must be to improve the design and construction, management and control of industrial processes so as to ensure a high level of protection for the environment as a whole. Central to this approach is the general principle given in Article 3 that operators should take all appropriate preventative measures against pollution, in particular through the application of '**best available techniques**', enabling them to improve their environmental performance including energy efficiency.

Annex IV of the IPPC Directive contains a list of 'considerations to be taken into account generally or in specific cases when determining best available techniques bearing in mind the likely costs and benefits of a measure and the principles of precaution and prevention'. These considerations include the information published by the Commission to comply with Article 17(2) (BAT reference documents, or BREFs).

Competent authorities responsible for issuing permits are required to take account of the general principles set out in Article 3 when determining the conditions of the permit. These conditions must include emission limit values, supplemented or replaced, where appropriate, by equivalent parameters or technical measures. According to Article 9(4) of the Directive:

(without prejudice to Article 10 on best available techniques and environmental quality standards, compliance with environmental quality standards), the emission limit values, equivalent parameters and technical measures shall be based on the best available techniques, without prescribing the use of any technique or specific technology, but taking into account the technical characteristics of the installation concerned, its geographical location and the local environmental conditions. In all circumstances, the conditions of the permit shall include provisions on the minimisation of long-distance or transboundary pollution and must ensure a high level of protection for the environment as a whole.

Member States have the obligation, according to Article 11 of the Directive, to ensure that competent authorities follow or are informed of developments in best available techniques.

The information provided in this document is intended to be used as an input to the determination of BAT for energy efficiency in specific cases. When determining BAT and setting BAT-based permit conditions, account should always be taken of the overall goal to achieve a high level of protection for the environment as a whole including energy efficiency.

The BAT chapter (Chapter 4) presents the techniques that are considered to be compatible with BAT in a general sense. The purpose is to provide general indications about energy efficiency techniques that can be considered as an appropriate reference point to assist in the determination of BAT-based permit conditions or for the establishment of general binding rules under Article 9(8). It should be stressed, however, that this document does not propose energy efficiency values for permits. It is foreseen that new installations can be designed to perform at or even better than the general BAT levels presented here. It is also considered that existing installations could move towards the general BAT levels or do better, subject to the technical and economic applicability of the techniques in each case. In the case of existing installations, the economic and technical viability of upgrading them also needs to be taken into account.

The techniques presented in this BAT chapter will not necessarily be appropriate for all installations. On the other hand, the obligation to ensure a high level of environmental protection including the minimisation of long-distance or transboundary pollution implies that permit conditions cannot be set on the basis of purely local considerations. It is therefore of the utmost importance that the information contained in this document is fully taken into account by permitting authorities.

It is important to bear in mind the importance of energy efficiency. However, *'even the single objective of ensuring a high level of protection for the environment as a whole will often involve making trade-off judgements between different types of environmental impact, and these judgements will often be influenced by local considerations'*. As a consequence:

- it may not be possible to maximise the energy efficiencies of all activities and/or systems in the installation at the same time
- it may not be possible to both maximise the total energy efficiency and minimise other consumptions and emissions (e.g. it may not be possible to reduce emissions such as those to air without using energy)
- the energy efficiency of one or more systems may be de-optimised to achieve the overall maximum efficiency for an installation
- it is necessary to keep the balance between maximising energy efficiency and other factors, such as product quality, the stability of the process, etc.
- the use of sustainable energy sources and/or 'wasted' or surplus heat may be more sustainable than using primary fuels, even if the energy efficiency in use is lower.

Energy efficiency techniques are therefore proposed as 'optimising energy efficiency'

The horizontal approach to energy efficiency in all IPPC sectors is based on the premise that energy is used in all installations, and that common systems and equipment occur in many IPPC sectors. Generic options for energy efficiency can therefore be identified independently of a specific activity. On this basis, BAT can be derived that embrace the most effective measures to achieve a high level of energy efficiency as a whole. Because this is a horizontal BREF, BAT need to be determined more broadly than for a vertical BREF, such as considering the interaction of processes, units and systems within a site.

Process-specific BAT for energy efficiency and associated energy consumption levels are given in the appropriate 'vertical' sector BREFs. As the first series of the BREFs has been completed, these have been broadly summarised in [283, EIPPCB].

Neither the BAT Chapter (Chapter 4), nor Chapters 2 and 3 give exhaustive lists of techniques which may be considered, and therefore other techniques may exist or may be developed which may be equally valid within the framework of IPPC and BAT.

The implementation of BAT in new or significantly upgraded plants or processes is not usually a problem. In most cases, it makes economic sense to optimise energy efficiency. Within an existing installation, the implementation of BAT is not generally so easy, because of the existing infrastructure and local circumstances: the economic and technical viability of upgrading these installations needs to be taken into account. In Chapters 2 and 3, the applicability of the techniques is considered, and this is summarised for each BAT in Chapter 4.

Nevertheless, this document does not generally distinguish between new and existing installations. Such a distinction would not encourage the operators of industrial sites to move towards adopting BAT. There is generally a payback associated with energy efficiency measures and due to the high importance attached to energy efficiency, many policy implementation measures, including financial incentives, are available. Some of these are referred to in the annexes.

Some techniques are very desirable, and often implemented, but may require the availability and cooperation of a third party (e.g. cogeneration), which is not considered in the IPPC Directive. It should be noted that the cooperation and agreement of third parties may not be within the control of an operator, and therefore may not be within the scope of an IPPC permit.

General BAT for achieving energy efficiency at an installation level

A key element to deliver energy efficiency at a n installation level is a formal management approach. The other BAT applied at a site level support the management of energy efficiency, and give more detail of techniques needed to achieve this. These techniques are applicable to all installations. The scope (e.g. level of detail, frequency of optimisation, systems to be considered at any one time) and techniques used depend on the scale and complexity of the installation, and the energy requirements of the component systems.

Energy efficiency management

- BAT is to implement and adhere to an energy efficiency management system (ENEMS) that incorporates, as appropriate to the local circumstances, the following features:
 - commitment of top management
 - definition of an energy efficiency policy for the installation by top management
 - planning and establishing objectives and targets
 - implementation and operation of procedures paying particular attention to:
 - staff's structure and responsibilities; training, awareness and competence; communication; employee involvement; documentation; efficient control of processes; maintenance programmes; emergency preparedness and response; safeguarding compliance with energy efficiency related legislation and agreements (where such agreements exist)
 - benchmarking
 - checking performance and taking corrective action paying particular attention to:
 - monitoring and measurement; corrective and preventive action; maintenance of records; independent (where practicable) internal auditing to determine whether or not the ENEMS conforms to planned arrangements and has been properly implemented and maintained
 - review of the ENEMS and its continuing suitability, adequacy and effectiveness by top management
 - when designing a new unit, taking into account the environmental impact from the eventual decommissioning
 - development of energy efficient technologies and to follow developments in energy efficiency techniques.

An ENEMS may optionally include the following steps:

- preparation and publication (with or without external validation) of a regular energy efficiency statement, allowing for year-by-year comparison against objectives and targets
- having the management system and audit procedure examined and validated externally
- implementation and adherence to a nationally or internationally accepted voluntary management system for energy efficiency.

Continuous environmental improvement

- BAT is to continuously minimise the environmental impact of an installation by planning actions and investments on an integrated basis and for the short, medium and long term, considering the cost benefits and cross-media effects.

This is applicable to all installations. 'Continuously' means the actions are repeated over time, i.e. all planning and investment decisions should consider the overall long term aim to reduce the environmental impacts of the operation. Improvement may be step-wise, and not linear, and needs to take account of the cross-media effects, such as increased energy usage to reduce air pollutants. Environmental impacts can never be reduced to zero, and there will be times when there is little or no cost-benefit to further actions. However, over time, the viability may also change.

Identification of energy efficiency aspects of an installation and opportunities for energy saving

- BAT is to identify the aspects of an installation that influence energy efficiency by carrying out an audit. It is important that an audit is coherent with a systems approach.

This is applicable to all existing installations and prior to planning upgrades or rebuilds. An audit may be external or internal.

- When carrying out an audit, BAT is to ensure that an audit identifies the following aspects:
 - energy use and type in the installation and its component systems and processes
 - energy-using equipment, and the type and quantity of energy used in the installation
 - possibilities to minimise energy use, such as:
 - controlling/reducing operating times, e.g. switching off when not in use
 - ensuring insulation is optimised
 - optimising utilities, associated systems and processes (see BAT for energy-using systems)
 - possibilities to use alternative sources or use of energy that is more efficient, in particular energy surplus from other processes and/or systems
 - possibilities to apply energy surplus to other processes and/or systems
 - possibilities to upgrade heat quality.
- BAT is to use appropriate tools or methodologies to assist with identifying and quantifying energy optimisation, such as:
 - energy models, databases and balances
 - a technique such as pinch methodology, exergy or enthalpy analysis or thermoeconomics
 - estimates and calculations.

The choice of the appropriate tools depends on the sector and complexity of the site, and is discussed in the relevant sections.

- BAT is to identify opportunities to optimise energy recovery within the installation, between systems within the installation and/or with a third party (or parties).

This BAT depends on the existence of a suitable use for the surplus heat of the type and quantity that may be recovered.

A systems approach to energy management

- BAT is to optimise energy efficiency by taking a systems approach to energy management in the installation. Systems to be considered for optimising as a whole are, for example:
 - process units (see sector BREFs)
 - heating systems such as:
 - steam
 - hot water
 - cooling and vacuum (see the ICS BREF)
 - motor driven systems such as:
 - compressed air
 - pumping
 - lighting
 - drying, separation and concentration.

Establishing and reviewing energy efficiency objectives and indicators

- BAT is to establish energy efficiency indicators by carrying out all of the following:
 - identifying suitable energy efficiency indicators for the installation, and where necessary, individual processes, systems and/or units, and measure their change over time or after the implementation of energy efficiency measures
 - identifying and recording appropriate boundaries associated with the indicators
 - identifying and recording factors that can cause variation in the energy efficiency of the relevant processes, systems and/or units.

Secondary or final energies are usually used for monitoring ongoing situations. In some cases, more than one secondary or final energy indicator may be used for each process (e.g. both steam and electricity). When deciding on the use (or change) in energy vectors and utilities, the indicator may also be the secondary or final energy. However, other indicators such as primary energy or carbon balance may be used to take account of the efficiency of production of any secondary energy vector and its cross-media effects, depending on local circumstances.

Benchmarking

- BAT is to carry out systematic and regular comparisons with sector, national or regional benchmarks, where validated data are available.

The period between benchmarking is sector-specific and is usually several years, as benchmark data rarely change rapidly or significantly in a short time period.

Energy efficient design (EED)

- BAT is to optimise energy efficiency when planning a new installation, unit or system or a significant upgrade by considering all of the following:
 - energy efficient design (EED) should be initiated at the early stages of the conceptual design/basic design phase, even though the planned investments may not be well-defined, and should be taken into account in the tendering process
 - the development and/or selection of energy efficient technologies
 - additional data collection may need to be carried out as part of the design project or separately to supplement the existing data or fill gaps in knowledge
 - the EED work should be carried out by an energy expert
 - the initial mapping of energy consumption should also address which parties in the project organisations influence the future energy consumption and optimise the EED of the future plant with them. For example, the staff in the existing installation who may be responsible for specifying operational parameters.

Where relevant in-house expertise on energy efficiency is not available (e.g. non-energy intensive industries), external ENE expertise should be sought.

Increased process integration

- BAT is to seek to optimise the use of energy between more than one process or system within the installation or with a third party.

Maintaining the impetus of energy efficiency initiatives

- BAT is to maintain the impetus of the energy efficiency programme by using a variety of techniques, such as:
 - implementing a specific energy management system
 - accounting for energy based on real (metered) values, which places the obligation and credit for energy efficiency on the user/bill payer
 - the creation of financial profit centres for energy efficiency
 - benchmarking
 - a fresh look at existing management systems
 - using techniques to manage organisational change.

Techniques such as the first three are applied according to the data in the relevant sections. Techniques such as the last three should be applied far enough apart for the progress of the ENE programme to be assessed, i.e. several years.

Maintaining expertise

- BAT is to maintain expertise in energy efficiency and energy-using systems by using techniques such as:
 - recruitment of skilled staff and/or training of staff. Training can be delivered by in-house staff, by external experts, by formal courses or by self-study/development
 - taking staff off-line periodically to perform fixed term/specific investigations (in their original installation or in others)
 - sharing in-house resources between sites
 - use of appropriately skilled consultants for fixed term investigations
 - outsourcing specialist systems and/or functions.

Effective control of processes

- BAT is to ensure that the effective control of processes is implemented by techniques such as:
 - having systems in place to ensure that procedures are known, understood and complied with
 - ensuring that the key performance parameters are identified, optimised for energy efficiency and monitored
 - documenting or recording these parameters.

Maintenance

- BAT is to carry out maintenance at installations to optimise energy efficiency by applying all of the following:
 - clearly allocating responsibility for the planning and execution of maintenance
 - establishing a structured programme for maintenance based on technical descriptions of the equipment, norms, etc. as well as any equipment failures and consequences. Some maintenance activities may be best scheduled for plant shutdown periods
 - supporting the maintenance programme by appropriate record keeping systems and diagnostic testing
 - identifying from routine maintenance, breakdowns and/or abnormalities, possible losses in energy efficiency, or where energy efficiency could be improved
 - identifying leaks, broken equipment, worn bearings, etc. that affect or control energy usage, and rectifying them at the earliest opportunity.

Carrying out repairs promptly has to be balanced with maintaining the product quality and process stability, as well as with health and safety issues.

Monitoring and measurement

- BAT is to establish and maintain documented procedures to monitor and measure, on a regular basis, the key characteristics of operations and activities that can have a significant impact on energy efficiency. Some suitable techniques are given in this document.

Best available techniques for achieving energy efficiency in energy-using systems, processes, activities or equipment

The general BAT, above, identify the importance of seeing the installation as a whole, and assessing the needs and purposes of the various systems, their associated energies and their interactions. They also include:

- analysing and benchmarking the system and its performance
- planning actions and investments to optimise energy efficiency considering the cost-benefits and cross-media effects
- for new systems, optimising energy efficiency in the design of the installation, unit or system and in the selection of processes
- for existing systems, optimising the energy efficiency of the system through its operation and management, including regular monitoring and maintenance.

The following BAT therefore assume that these general BAT are also applied to the systems listed below, as part of their optimisation. **BAT for ENE for the commonly found associated activities, systems and processes in IPPC installations can be summarised as:**

- BAT is to optimise:
 - combustion
 - steam systems

by using relevant techniques such as:

- those specific to sectors given in vertical BREFs
- those given in the LCP BREF and this (ENE) document.
- BAT is to optimise the following, using techniques such as those described in this document:
 - compressed air systems
 - pumping systems
 - heating, ventilation and air conditioning (HVAC) systems
 - lighting
 - drying, concentration and separation processes. For these processes, it is also BAT to seek opportunities to use mechanical separation in conjunction with thermal processes.

Other BAT for systems, processes or activities are:

Heat recovery

- BAT is to maintain the efficiency of heat exchangers by both:
 - monitoring the efficiency periodically
 - preventing or removing fouling.

Techniques for cooling and associated BAT can be found in the ICS BREF, where the primary BAT is to seek to use surplus heat, rather than dissipate it through cooling. Where cooling is required, the advantages of free cooling (using ambient air) should be considered.

Cogeneration

- BAT is to seek possibilities for cogeneration, inside and/or outside the installation (with a third party).

In many cases, public authorities (at local, regional or national level) have facilitated such arrangements or are the third party.

Electrical power supply

- BAT is to increase the power factor according to the requirements of the local electricity distributor by using techniques such as those described in this document, according to applicability
- BAT is to check the power supply for harmonics and apply filters if required
- BAT is to optimise the power supply efficiency by using techniques described in this document, according to applicability.

Electric motor driven sub-systems

Replacement by electrically efficient motors (EEMs) and variable speed drives (VSDs) is one of the easiest measures when considering energy efficiency. However, this should be done in the context of considering the whole system the motor sits in, otherwise there are risks of:

- losing the potential benefits of optimising the use and size of the systems, and subsequently optimising the motor drive requirements
- losing energy if a VSD is applied in the wrong context.
- BAT is to optimise electric motors in the following order:
 - optimise the entire system the motor(s) is part of (e.g. cooling system)
 - then optimise the motor(s) in the system according to the newly-determined load requirements, by applying one or more of the techniques described, according to applicability
 - when the energy-using systems have been optimised, then optimise the remaining (non-optimised) motors according to the techniques described and criteria such as:
 - i) prioritising the remaining motors running more than 2000 hrs per year for replacement with EEMs
 - ii) electric motors driving a variable load operating at less than 50 % of capacity more than 20 % of their operating time and operating for more than 2000 hours a year should be considered for equipping with variable speed drives.

Degree of consensus

A high degree of consensus was achieved. No split view was recorded.

Research and technical development

The EC is launching and supporting, through its RTD programmes, a series of projects dealing with clean technologies, emerging effluent treatment and recycling technologies and management strategies. Potentially these projects could provide a useful contribution to future BREF reviews. Readers are therefore invited to inform the EIPPCB of any research results which are relevant to the scope of this document (see also the preface of this document).

PREFACE

1. Status of this document

Unless otherwise stated, references to “the Directive” in this document means the Council Directive 2008/1/EC on integrated pollution prevention and control. As the Directive applies without prejudice to Community provisions on health and safety at the workplace, so does this document.

This document forms part of a series presenting the results of an exchange of information between EU Member States and industries concerned on best available techniques (BAT), associated monitoring, and developments in them. It is published by the European Commission pursuant to Article 17(2) of the IPPC Directive, and must therefore be taken into account in accordance with Annex IV to the Directive when determining “best available techniques”.

2. Mandate of the work

This document was specifically mandated by a special request from the Commission Communication on the implementation of the European Climate Change Programme (COM(2001)580 final) ECCP concerning energy efficiency in industrial installations. The ECCP asked that effective implementation of the energy efficiency provisions of the IPPC Directive be promoted and that a special horizontal BREF (BAT reference document) addressing generic energy efficiency techniques should be prepared.

3. Relevant legal obligations of the IPPC Directive and the definition of BAT

In order to help the reader understand the legal context in which this document has been drafted, some of the most relevant provisions of the IPPC Directive are described in this Preface, including the definition of the term ‘best available techniques’. This description is inevitably incomplete and is given for information only. It has no legal value and does not in any way alter or prejudice the actual provisions of the Directive.

The purpose of the Directive is to achieve integrated prevention and control of pollution arising from the activities listed in its Annex I, leading to a high level of protection of the environment as a whole including energy efficiency and the prudent management of natural resources. The legal basis of the Directive relates to environmental protection. Its implementation should also take account of other Community objectives such as the competitiveness of the Community’s industry and the decoupling of growth from energy consumption thereby contributing to sustainable development. The Scope gives further information on the legal basis of energy efficiency in the Directive.

More specifically, the Directive provides for a permitting system for certain categories of industrial installations requiring both operators and regulators to take an integrated, overall view of the potential of the installation to consume and pollute. The overall aim of such an integrated approach must be to improve the design, construction, management and control of industrial processes so as to ensure a high level of protection for the environment as a whole. Central to this approach is the general principle given in Article 3 that operators should take all appropriate preventative measures against pollution, in particular through the application of best available techniques, enabling them to improve their environmental performance including energy efficiency.

The term “best available techniques” is defined in Article 2(12) of the Directive as “the most effective and advanced stage in the development of activities and their methods of operation which indicate the practical suitability of particular techniques for providing in principle the basis for emission limit values designed to prevent and, where that is not practicable, generally to reduce emissions and the impact on the environment as a whole.” Article 2(12) goes on to clarify further this definition as follows:

“techniques” includes both the technology used and the way in which the installation is designed, built, maintained, operated and decommissioned;

“available” techniques are those developed on a scale which allows implementation in the relevant industrial sector, under economically and technically viable conditions, taking into consideration the costs and advantages, whether or not the techniques are used or produced inside the Member State in question, as long as they are reasonably accessible to the operator;

“best” means most effective in achieving a high general level of protection of the environment as a whole.

Furthermore, Annex IV to the Directive contains a list of “considerations to be taken into account generally or in specific cases when determining best available techniques bearing in mind the likely costs and benefits of a measure and the principles of precaution and prevention”. These considerations include the information published by the Commission pursuant to Article 17(2).

Competent authorities responsible for issuing permits are required to take account of the general principles set out in Article 3 when determining the conditions of the permit. These conditions must include emission limit values, supplemented or replaced where appropriate by equivalent parameters or technical measures. According to Article 9(4) of the Directive:

(without prejudice to compliance with environmental quality standards), the emission limit values, equivalent parameters and technical measures shall be based on the best available techniques, without prescribing the use of any technique or specific technology, but taking into account the technical characteristics of the installation concerned, its geographical location and the local environmental conditions. In all circumstances, the conditions of the permit shall include provisions on the minimisation of long-distance or transboundary pollution and must ensure a high level of protection for the environment as a whole.

Member States have the obligation, according to Article 11 of the Directive, to ensure that competent authorities follow or are informed of developments in best available techniques.

4. Objective of this document

This document gives general advice how to implement the requirements of the Directive set out in (3) above.

Article 17(2) of the Directive requires the Commission to organise ‘an exchange of information between Member States and the industries concerned on best available techniques, associated monitoring and developments in them’, and to publish the results of the exchange.

The purpose of the information exchange is given in recital 27 of the Directive, which states that ‘the development and exchange of information at Community level about best available techniques will help to redress the technological imbalances in the Community, will promote the worldwide dissemination of limit values and techniques used in the Community and will help the Member States in the efficient implementation of this Directive.’

The Commission (Environment DG) established an information exchange forum (IEF) to assist the work under Article 17(2) and a number of technical working groups have been established under the umbrella of the IEF. Both IEF and the technical working groups include representation from Member States and industry as required in Article 17(2).

The aim of this series of documents is to reflect accurately the exchange of information which has taken place as required by Article 17(2) and to provide reference information for the permitting authority to take into account when determining permit conditions. By providing relevant information concerning best available techniques, these documents should act as valuable tools to drive environmental performance including energy efficiency.

5. Information sources

This document represents a summary of information collected from a number of sources, in particular, through the expertise of the groups established to assist the Commission in its work, and verified by the Commission services. The work of the contributors and the expert groups is gratefully acknowledged.

6. How to understand and use this document

The information provided in this document is intended to be used as an input to the determination of BAT for energy efficiency in specific cases. When determining BAT and setting BAT-based permit conditions, account should always be taken of the overall goal to achieve a high level of protection for the environment as a whole including energy efficiency.

The rest of this section describes the type of information that is provided in each chapter of this document.

Chapter 1 provides an introduction to terms and concepts in energy and thermodynamics. It describes definitions of energy efficiency for industry, how to develop and define indicators to monitor energy efficiency, and the importance of defining boundaries for installations, and component systems and/or units.

Chapters 2 and 3 describe in more detail the energy efficiency techniques that are found in more than one industry sector and that are considered to be most relevant for determining BAT and BAT-based permit conditions:

- Chapter 2 describes techniques to be considered at the level of the entire installation
- Chapter 3 describes techniques to be considered for specific systems, processes, activities and equipment that use significant energy and are commonly found within installations.

This information includes some idea of the energy efficiency that can be achieved, the costs and the cross-media issues associated with the technique, and the extent to which the technique is applicable to the range of installations requiring IPPC permits, for example new, existing, large or small installations.

Chapter 4 presents the techniques that are considered to be compatible with BAT in a general sense. The purpose is to provide general indications about energy efficiency techniques that can be considered as an appropriate reference point to assist in the determination of BAT-based permit conditions or for the establishment of general binding rules under Article 9(8). It should be stressed, however, that this document does not propose energy efficiency values for permits. The determination of appropriate permit conditions will involve taking account of local, site-specific factors such as the technical characteristics of the installation concerned, its geographical location and the local environmental conditions. In the case of existing installations, the economic and technical viability of upgrading them also needs to be taken into

Preface

account. Even the single objective of ensuring a high level of protection for the environment as a whole will often involve making trade-off judgements between different types of environmental impact, and these judgements will often be influenced by local considerations.

Although an attempt is made to address some of these issues, it is not possible for them to be considered fully in this document. The techniques presented in Chapter 4 will therefore not necessarily be appropriate for all installations. On the other hand, the obligation to ensure a high level of environmental protection including the minimisation of long-distance or transboundary pollution implies that permit conditions cannot be set on the basis of purely local considerations. It is therefore of the utmost importance that the information contained in this document is fully taken into account by permitting authorities

Since the best available techniques change over time, this document will be reviewed and updated as appropriate. All comments and suggestions should be made to the European IPPC Bureau at the Institute for Prospective Technological Studies at the following address:

Edificio Expo, c/Inca Garcilaso 3, E-41092 Sevilla, Spain

Telephone: +34 95 4488 284

Fax: +34 95 4488 426

e-mail: JRC-IPTS-EIPPCB@ec.europa.eu

Internet: <http://eippcb.jrc.ec.europa.eu/>

Best Available Techniques Reference Document on Energy Efficiency

EXECUTIVE SUMMARY	I
PREFACE	XI
SCOPE	XXV
1 INTRODUCTION AND DEFINITIONS	1
1.1 Introduction	1
1.1.1 Energy in the EU industrial sector	1
1.1.2 The impacts of energy usage	2
1.1.3 The contribution of energy efficiency to reducing global warming impacts and to improving sustainability	3
1.1.4 Energy efficiency and the IPPC Directive	4
1.1.5 Energy efficiency in integrated pollution prevention and control	5
1.1.6 Economic and cross-media issues	6
1.2 Energy and the laws of thermodynamics	7
1.2.1 Energy, heat, power and work	8
1.2.2 Laws of thermodynamics	10
1.2.2.1 The first law of thermodynamics: the conversion of energy	10
1.2.2.2 The second law of thermodynamics: entropy increases	11
1.2.2.3 Exergy balance: combination of first and second laws	13
1.2.2.4 Property diagrams	14
1.2.2.5 Further information	16
1.2.2.6 Identification of irreversibilities	16
1.3 Definitions of indicators for energy efficiency and energy efficiency improvement	17
1.3.1 Energy efficiency and its measurement in the IPPC Directive	17
1.3.2 The efficient and inefficient use of energy	18
1.3.3 Energy efficiency indicators	18
1.3.4 Introduction to the use of indicators	21
1.3.5 The importance of systems and system boundaries	22
1.3.6 Other important related terms	23
1.3.6.1 Primary energy, secondary energy and final energy	23
1.3.6.2 Fuel heating values and efficiency	26
1.3.6.3 Supply side and demand side management	27
1.4 Energy efficiency indicators in industry	27
1.4.1 Introduction: defining indicators and other parameters	27
1.4.2 Energy efficiency in production units	28
1.4.2.1 Example 1. Simple case	28
1.4.2.2 Example 2. Typical case	30
1.4.3 Energy efficiency of a site	33
1.5 Issues to be considered when defining energy efficiency indicators	34
1.5.1 Defining the system boundary	35
1.5.1.1 Conclusions on systems and system boundaries	39
1.5.2 Other important issues to be considered at installation level	40
1.5.2.1 Recording the reporting practices used	40
1.5.2.2 Internal production and use of energy	40
1.5.2.3 Waste and flare recovery	40
1.5.2.4 Load factor (reduction of SEC with increasing production)	42
1.5.2.5 Changes in production techniques and product development	42
1.5.2.6 Energy integration	44
1.5.2.7 Inefficient use of energy contributing to sustainability and/or overall site efficiency	44
1.5.2.8 Heating and cooling of premises	45
1.5.2.9 Regional factors	45
1.5.2.10 Sensible heat	46
1.5.2.11 Further examples	46
2 TECHNIQUES TO CONSIDER TO ACHIEVE ENERGY EFFICIENCY AT AN INSTALLATION LEVEL	47

2.1	Energy efficiency management systems (ENEMS).....	48
2.2	Planning and establishing objectives and targets.....	56
2.2.1	Continuing environmental improvement and cross-media issues.....	56
2.2.2	A systems approach to energy management.....	59
2.3	Energy efficient design (EED).....	60
2.3.1	Selection of process technology.....	66
2.4	Increased process integration.....	68
2.5	Maintaining the impetus of energy efficiency initiatives.....	69
2.6	Maintaining expertise – human resources.....	71
2.7	Communication.....	73
2.7.1	Sankey diagrams.....	75
2.8	Effective control of processes.....	76
2.8.1	Process control systems.....	76
2.8.2	Quality management (control, assurance) systems.....	79
2.9	Maintenance.....	82
2.10	Monitoring and measurement.....	83
2.10.1	Indirect measurement techniques.....	84
2.10.2	Estimates and calculation.....	84
2.10.3	Metering and advanced metering systems.....	86
2.10.4	Low pressure drop flow measurement in pipework.....	87
2.11	Energy audits and energy diagnosis.....	89
2.12	Pinch methodology.....	94
2.13	Enthalpy and exergy analysis.....	100
2.14	Thermoeconomics.....	102
2.15	Energy models.....	104
2.15.1	Energy models, databases and balances.....	104
2.15.2	Optimisation and management of utilities using models.....	107
2.16	Benchmarking.....	110
2.17	Other tools.....	113
3	TECHNIQUES TO CONSIDER TO ACHIEVE ENERGY EFFICIENCY IN ENERGY- USING SYSTEMS, PROCESSES, OR ACTIVITIES.....	115
3.1	Combustion.....	116
3.1.1	Reduction of the flue-gas temperature.....	122
3.1.1.1	Installing an air or water preheater.....	123
3.1.2	Recuperative and regenerative burners.....	126
3.1.3	Reducing the mass flow of the flue-gases by reducing the excess air.....	128
3.1.4	Burner regulation and control.....	129
3.1.5	Fuel choice.....	130
3.1.6	Oxy-firing (oxyfuel).....	131
3.1.7	Reducing heat losses by insulation.....	132
3.1.8	Reducing losses through furnace openings.....	133
3.2	Steam systems.....	134
3.2.1	General features of steam.....	134
3.2.2	Overview of measures to improve steam system performance.....	137
3.2.3	Throttling devices and the use of backpressure turbines.....	139
3.2.4	Operating and control techniques.....	141
3.2.5	Preheating feed-water (including the use of economisers).....	143
3.2.6	Prevention and removal of scale deposits on heat transfer surfaces.....	145
3.2.7	Minimising blowdown from the boiler.....	147
3.2.8	Optimising deaerator vent rate.....	149
3.2.9	Minimising boiler short cycle losses.....	150
3.2.10	Optimising steam distribution systems.....	151
3.2.11	Insulation on steam pipes and condensate return pipes.....	152
3.2.11.1	Installation of removable insulating pads or valves and fittings.....	153
3.2.12	Implementing a control and repair programme for steam traps.....	155
3.2.13	Collecting and returning condensate to the boiler for re-use.....	158
3.2.14	Re-use of flash steam.....	159
3.2.15	Recovering energy from boiler blowdown.....	162
3.3	Heat recovery and cooling.....	163
3.3.1	Heat exchangers.....	164
3.3.1.1	Monitoring and maintenance of heat exchangers.....	167
3.3.2	Heat pumps (including mechanical vapour recompression, MVR).....	167

3.3.3	Chillers and cooling systems.....	174
3.4	Cogeneration.....	176
3.4.1	Different types of cogeneration.....	176
3.4.2	Trigeneration.....	184
3.4.3	District cooling.....	187
3.5	Electrical power supply.....	190
3.5.1	Power factor correction.....	190
3.5.2	Harmonics.....	192
3.5.3	Optimising supply.....	193
3.5.4	Energy efficient management of transformers.....	194
3.6	Electric motor driven sub-systems.....	196
3.6.1	Energy efficient motors (EEMs).....	200
3.6.2	Proper motor sizing.....	201
3.6.3	Variable speed drives.....	202
3.6.4	Transmission losses.....	203
3.6.5	Motor repair.....	203
3.6.6	Rewinding.....	203
3.6.7	Achieved environmental benefits, Cross media effects, Applicability, and other considerations for electric motor ENE techniques.....	204
3.7	Compressed air systems (CAS).....	206
3.7.1	System design.....	212
3.7.2	Variable speed drives (VSD).....	214
3.7.3	High efficiency motors (HEM).....	216
3.7.4	CAS master control systems.....	216
3.7.5	Heat recovery.....	220
3.7.6	Reducing compressed air system leaks.....	221
3.7.7	Filter maintenance.....	223
3.7.8	Feeding the compressor(s) with cool outside air.....	224
3.7.9	Optimising the pressure level.....	226
3.7.10	Storage of compressed air near high-fluctuating uses.....	228
3.8	Pumping systems.....	228
3.8.1	Inventory and assessment of pumping systems.....	229
3.8.2	Pump selection.....	230
3.8.3	Pipework system.....	232
3.8.4	Maintenance.....	232
3.8.5	Pumping system control and regulation.....	233
3.8.6	Motor and transmission.....	234
3.8.7	Achieved environmental, Cross media effects, Applicability and other considerations for ENE techniques in pumping systems.....	234
3.9	Heating, ventilation and air conditioning (HVAC) systems.....	235
3.9.1	Space heating and cooling.....	236
3.9.2	Ventilation.....	238
3.9.2.1	Design optimisation of a new or upgraded ventilation system.....	239
3.9.2.2	Improving an existing ventilation system within an installation.....	242
3.9.3	Free cooling.....	244
3.10	Lighting.....	246
3.11	Drying, separation and concentration processes.....	250
3.11.1	Selecting the optimum technology or combination of technologies.....	251
3.11.2	Mechanical processes.....	254
3.11.3	Thermal drying techniques.....	255
3.11.3.1	Calculation of energy requirements and efficiency.....	255
3.11.3.2	Direct heating.....	257
3.11.3.3	Indirect heating.....	258
3.11.3.4	Superheated steam.....	259
3.11.3.5	Heat recovery in drying processes.....	260
3.11.3.6	Mechanical vapour recompression or heat pumps with evaporation.....	261
3.11.3.7	Optimisation of the insulation of the drying system.....	262
3.11.4	Radiant energies.....	263
3.11.5	Computer-aided process control/process automation in thermal drying processes.....	265
4	BEST AVAILABLE TECHNIQUES.....	267
4.1	Introduction.....	267
4.2	Best available techniques for achieving energy efficiency at an installation level.....	273

4.2.1	Energy efficiency management	273
4.2.2	Planning and establishing objectives and targets.....	274
4.2.2.1	Continuous environmental improvement.....	274
4.2.2.2	Identification of energy efficiency aspects of an installation and opportunities for energy savings	275
4.2.2.3	A systems approach to energy management.....	276
4.2.2.4	Establishing and reviewing energy efficiency objectives and indicators.....	277
4.2.2.5	Benchmarking.....	278
4.2.3	Energy efficient design (EED).....	278
4.2.4	Increased process integration.....	279
4.2.5	Maintaining the impetus of energy efficiency initiatives	279
4.2.6	Maintaining expertise	280
4.2.7	Effective control of processes.....	280
4.2.8	Maintenance	281
4.2.9	Monitoring and measurement.....	281
4.3	Best available techniques for achieving energy efficiency in energy-using systems, processes, activities or equipment.....	282
4.3.1	Combustion	282
3.1.3	Reducing the mass flow of the flue-gases by reducing the excess air	283
4.3.2	Steam systems	285
4.3.3	Heat recovery.....	287
4.3.4	Cogeneration.....	288
4.3.5	Electrical power supply	288
4.3.6	Electric motor driven sub-systems.....	289
4.3.7	Compressed air systems (CAS)	291
4.3.8	Pumping systems	291
4.3.9	Heating, ventilation and air conditioning (HVAC) systems.....	293
4.3.10	Lighting	295
4.3.11	Drying, separation and concentration processes.....	295
5	EMERGING TECHNIQUES FOR ENERGY EFFICIENCY.....	297
5.1	Flameless combustion (flameless oxidation).....	297
5.2	Compressed air energy storage.....	301
6	CONCLUDING REMARKS.....	303
6.1	Timing and progress of the work.....	303
6.2	Sources of information	303
6.3	Degree of consensus	304
6.4	Gaps and overlaps in knowledge and recommendations for future information gathering and research.....	305
6.4.1	Gaps and overlaps in data.....	305
6.4.2	Specific operational data	307
6.4.3	Research issues and further work	307
6.5	Review of this document	308
	REFERENCES	309
	GLOSSARY	319
7	ANNEXES.....	329
7.1	Energy and the laws of thermodynamics	329
7.1.1	General principles.....	329
7.1.1.1	Characterisation of systems and processes	329
7.1.1.2	Forms of energy storage and transfer.....	330
7.1.1.2.1	Energy storage	330
7.1.1.2.2	Energy transfer.....	330
7.1.2	First and second law of thermodynamics	331
7.1.2.1	The first law of thermodynamics: energy balance	331
7.1.2.1.1	Energy balance for a closed system.....	331
7.1.2.1.2	Energy balance for open systems.....	332
7.1.2.1.3	First law efficiencies: thermal efficiency and coefficient of performance...332	
7.1.2.2	The second law of thermodynamics: entropy	333
7.1.2.2.1	Entropy	333
7.1.2.2.2	Entropy balance for closed systems	333
7.1.2.3	Entropy balance for an open system	334

7.1.2.4	Exergy analysis	334
7.1.2.4.1	Exergy	334
7.1.2.4.2	Exergy balances.....	335
7.1.2.4.3	Second law efficiency: Exergetic efficiency	335
7.1.3	Property diagrams, tables, databanks and computer programs	336
7.1.3.1	Property diagrams	336
7.1.3.2	Property tables, databanks and simulation programs	336
7.1.3.3	Identification of inefficiencies	337
7.1.4	Nomenclature	337
7.1.4.1	Bibliography.....	338
7.2	Case studies of thermodynamic irreversibilities.....	339
7.2.1	Case 1. Throttling devices.....	339
7.2.2	Case 2. Heat exchangers	341
7.2.3	Case 3. Mixing processes.....	343
7.3	Example of the application of energy efficiency.....	347
7.3.1	Ethylene cracker.....	347
7.3.2	Vinyl acetate monomer (VAM) production.....	348
7.3.3	A hot rolling mill in a steel works.....	349
7.4	Examples of implementation of energy efficiency management systems.....	352
7.5	Example of energy efficient core processes	354
7.6	Example of maintaining the impetus of energy efficiency initiatives: operational excellence	357
7.7	Monitoring and metering.....	358
7.7.1	Quantitative measurements – metering	358
7.7.2	Model-based utilities – optimisation and management.....	358
7.7.3	Energy models, databases and balances.....	359
7.8	Other tools used for auditing tools and supporting other techniques used at a site level	363
7.8.1	Auditing and energy management tools.....	363
7.8.2	Measurement and verification protocol.....	364
7.9	Benchmarking	364
7.9.1	Mineral oil refineries.....	364
7.9.2	Austrian Energy Agency.....	366
7.9.3	Scheme for SMEs in Norway.....	366
7.9.4	Benchmarking covenants in the Netherlands	366
7.9.5	Glass industry benchmarking.....	367
7.9.6	Allocation of energy/CO ₂ emissions between different products in a complex process with successive steps.....	368
7.10	Chapter 3 examples	369
7.10.1	Steam	369
7.10.2	Waste heat recovery	376
7.10.3	Cogeneration	380
7.10.4	Trigeneration.....	381
7.11	Demand management.....	382
7.12	Energy Service Company (ESCO).....	383
7.12.1	Technical facilities management.....	385
7.12.2	Final energy supply services (also referred to as installation contracting).....	386
7.13	European Commission website and Member State National Energy Efficiency Actions Plans (NEEAPs).....	387
7.14	EU Emissions trading scheme (ETS).....	388
7.15	Transport systems optimisation.....	390
7.15.1	Energy audit for transport chains	390
7.15.2	Road transport energy management.....	391
7.15.3	Improving packaging to optimise transport use	395
7.16	European energy mix	396
7.17	Electrical power factor correction	398

List of figures

Figure 1.1: Percentage of EU primary energy demand used by process industries	1
Figure 1.2: Increasing atmospheric GHG concentrations since 1750 as ppm CO ₂ equivalents showing various scenarios	2
Figure 1.3: Chemical industry energy usage 1975 – 2003	3
Figure 1.4: Thermodynamic system	10
Figure 1.5: Pressure – temperature (phase) diagram	15
Figure 1.6: Definition of primary, secondary and final energies	23
Figure 1.7: Energy vectors in a simple production unit	28
Figure 1.8: Energy vectors in a production unit	30
Figure 1.9: Inputs and outputs of a site	33
Figure 1.10: System boundary – old electric motor	35
Figure 1.11: System boundary – new electric motor	36
Figure 1.12: System boundary – new electric motor and old pump	36
Figure 1.13: System boundary – new electric motor and new pump	37
Figure 1.14: New electric motor and new pump with constant output	37
Figure 1.15: New electric motor, new pump and old heat exchanger	38
Figure 1.16: New electric motor, new pump and two heat exchangers	39
Figure 1.17: Energy consumption depending on outdoor temperature	45
Figure 2.1: Continuous improvement of an energy efficiency management system	48
Figure 2.2: Example of possible variation of energy use over time	57
Figure 2.3: Examples of total costs of ownership for typical industrial equipment (over 10 year lifetime)	60
Figure 2.4: Saving potentials and investments in design phase as compared to operational phase	60
Figure 2.5: Areas to be addressed in the design phase rather than the operational phase	61
Figure 2.6: Recommended organisation including an energy expert in the planning and design of new facilities	64
Figure 2.7: Sankey diagram: fuel and losses in a typical factory	75
Figure 2.8: Structure of an advanced metering system	86
Figure 2.9: The properties of energy audit models	89
Figure 2.10: Scheme for a comprehensive-type energy audit	94
Figure 2.11: Two hot streams	95
Figure 2.12: Hot composite curve	95
Figure 2.13: Composite curves showing the pinch and energy targets	96
Figure 2.14: Schematic representation of the systems above and below the pinch	96
Figure 2.15: Heat transfer across the pinch from heat sink to heat source	97
Figure 2.16: Energy savings identified by pinch methodology	99
Figure 2.17: Power factor of a device depending on the load factor	105
Figure 3.1: Energy balance of a combustion installation	120
Figure 3.2.: Scheme of a combustion system with an air preheater	124
Figure 3.3. Working principle for regenerative burners	127
Figure 3.4: Different regions of combustion	127
Figure 3.5: Typical steam generation and distribution system	136
Figure 3.6: Modern control system optimising boiler usage	142
Figure 3.7: Feed-water preheating	143
Figure 3.8: Diagram of a compression heat pump	168
Figure 3.9: Diagram of an absorption heat pump	170
Figure 3.10: Simple MVR installation	171
Figure 3.11: COP versus temperature lift for a typical MVR system	171
Figure 3.12: Backpressure plant	177
Figure 3.13: Extraction condensing plant	178
Figure 3.14: Gas turbine heat recovery boiler	178
Figure 3.15: Combined cycle power plant	179
Figure 3.16: Internal combustion or reciprocating engine	180
Figure 3.17: Comparison between efficiency of a condensing power and a combined heat and power plant	182
Figure 3.18: Trigeneration compared to separate energy production for a major airport	185
Figure 3.19: Trigeneration enables optimised plant operation throughout the year	186
Figure 3.20: District cooling in the winter by free cooling technology	188
Figure 3.21: District cooling by absorption technology in the summer	188

Figure 3.22: Reactive and apparent power	191
Figure 3.23: Diagram of a transformer	194
Figure 3.24: Relationship between losses in iron, in copper, in efficiency, and in load factor	195
Figure 3.25: Conventional and energy efficient pumping system schemes	197
Figure 3.26: A compressor motor with a rated output of 24 MW	199
Figure 3.27: Energy efficiency of three phase AC induction motors	201
Figure 3.28: Efficiency vs. load for an electric motor	202
Figure 3.29: Cost of a new motor compared with rewinding	204
Figure 3.30: Lifetime costs of an electric motor	205
Figure 3.31: Typical components of a compressed air system (CAS).....	209
Figure 3.32: Types of compressors	210
Figure 3.33: Different demand profiles	211
Figure 3.34: Different kinds of compressor control	226
Figure 3.35: Peak efficiency flow vs. head, power and efficiency.....	230
Figure 3.36: Pump capacity vs. head.....	231
Figure 3.37: Pump head versus flowrate	232
Figure 3.38: Example of energy consumption for two pumping regulation systems for a rotodynamic pump	234
Figure 3.39: Typical life cycle costs for a medium sized industrial pump	235
Figure 3.40: Scheme of an HVAC system	236
Figure 3.41: Ventilation system	238
Figure 3.42: Flow diagram to optimise energy use in ventilation systems.....	239
Figure 3.43: Possible scheme for the implementation of free cooling	244
Figure 3.44: Energy consumption of some separation processes	253
Figure 3.45: Bandwidths for the specific secondary energy consumption of different types of dryer when vaporising water	256
Figure 4.1: Relationships between BAT for Energy efficiency	272
Figure 5.1: Working principle for regenerative burners	297
Figure 5.2: The net heat output results according to test furnaces of both conventional and HiTAC burners	298
Figure 5.3: Flameless combustion conditions	299
Figure 7.1: Temperature-entropy diagram	336
Figure 7.2: Steam throttling process.....	339
Figure 7.3: T-S and h-S diagrams for the steam throttling process of the example	340
Figure 7.4: Counterflow heat exchanger	341
Figure 7.5: Reheating process of a steam flow.....	342
Figure 7.6: T-s and h-s diagrams for the steam reheating process of the example.....	342
Figure 7.7: I_i/RT_0 versus molar fraction of one component in the mixture	344
Figure 7.8: Mixing chamber of two flows.....	345
Figure 7.9: T-s diagram for the mixing process of the example.....	346
Figure 7.10: Inputs and outputs for a vinyl acetate monomer (VAM) plant	348
Figure 7.11: Flow chart of a rolling mill	349
Figure 7.12: Specific energy consumption in a rolling mill	350
Figure 7.13: Changes in specific energy consumption in a rolling mill	351
Figure 7.14: Process scheme of Eurallumina alumina refinery	376
Figure 7.15: Operative cycle of heaters.....	377
Figure 7.16: Heat recovery system connected to the district heating system	379
Figure 7.17: Reactive and apparent power explanation	398

List of tables

Table 1.1: Indicative low and high heating values for various fuels.....	27
Table 2.1: The information breakdown for systems and techniques described in Chapters 2 and 3.....	47
Table 2.2: Example of activities during the energy efficient design of a new industrial site.....	62
Table 2.3: Achieved savings and investments in five pilot projects for EED.....	63
Table 2.4: EUREM pilot project: savings per participant.....	73
Table 2.5: Examples of pressure drop caused by different metering systems.....	88
Table 2.6: Pinch methodology: some examples of applications and savings	99
Table 2.7: Business process drivers for using a utilities optimiser	109
Table 3.1: The information breakdown for systems and techniques described in Chapters 2 and 3.....	115
Table 3.2: Overview of combustion techniques contributing to energy efficiency in LCP and ENE BREFs	119
Table 3.3: Calculation of the Siegert coefficient for different types of fuel	125
Table 3.4: Possible savings in combustion air preheating	126
Table 3.5: Energy used to generate steam in several industries.....	134
Table 3.6: Common energy efficiency techniques for industrial steam systems	139
Table 3.7: Based on natural gas fuel, 15 % excess air and a final stack temperature of 120 °C Adapted from [123, US_DOE].....	145
Table 3.8: Differences in heat transfer.....	146
Table 3.9: Energy content of blowdown.....	148
Table 3.10: Heat loss per 30 m of uninsulated steam line	153
Table 3.11: Approximate energy savings in Watts from installing removable insulated valve covers.....	154
Table 3.12: Leaking steam trap discharge rate	155
Table 3.13: Various operating phases of steam traps.....	156
Table 3.14: Operating factors for steam losses in steam traps.....	156
Table 3.15: Load factor for steam losses	157
Table 3.16: Percentage of total energy present in the condensate at atmospheric pressure and in the flash steam	160
Table 3.17: Recovered energy from blowdown losses	162
Table 3.18: Examples of process requirements and BAT in the ICS BREF.....	175
Table 3.19: Examples of site characteristics and BAT in the ICS BREF	175
Table 3.20: List of cogeneration technologies and default power to heat ratios.....	176
Table 3.21: Estimated industry electricity consumption in the EU-25 in 2002	191
Table 3.22: motor driven sub-system power energy saving measures.....	204
Table 3.23: Energy savings measures in CASs.....	208
Table 3.24: Typical components in a CAS	209
Table 3.25: Example of cost savings	221
Table 3.26: Savings obtained by feeding the compressor with cool outside air	225
Table 3.27: Characteristics and efficiency of different light types	248
Table 3.28: Savings achievable from lighting systems.....	249
Table 3.29: Evaporator types and specific consumptions.....	261
Table 4.1: Combustion system techniques to improve energy efficiency.....	285
Table 4.2: Steam system techniques to improve energy efficiency	287
Table 4.3: Electrical power factor correction techniques to improve energy efficiency.....	289
Table 4.4: Electrical power supply techniques to improve energy efficiency	289
Table 4.5: Electric motor techniques to improve energy efficiency	290
Table 4.6: Compressed air system techniques to improve energy efficiency	291
Table 4.7: Pumping system techniques to improve energy efficiency.....	292
Table 4.8: Heating, ventilation and air conditioning system techniques to improve energy efficiency.....	294
Table 4.9: Lighting system techniques to improve energy efficiency	295
Table 4.10: Drying, separation and concentration system techniques to improve energy efficiency	296
Table 7.1: Some values of the derivatives	344
Table 7.2: Maximum values for mixtures.....	344
Table 7.3: Worldwide acrylamide production capacity 10 ⁵ tonnes/year.....	355
Table 7.4: Comparison of acrylamide processes	355
Table 7.5: Comparison of energy consumption as MJ/kg acrylamide.....	355
Table 7.6: Comparison of CO ₂ production kg CO ₂ /kg acrylamide.....	355
Table 7.7: Energy savings made from an electron beam ink system	356
Table 7.8: A simple electric model.....	359
Table 7.9: Data in a thermal energy model (generators side).....	361

Table 7.10: Data in a thermal energy model (users side)	362
Table 7.11: Operating factors for steam losses in steam traps	373
Table 7.12: Load factor for steam losses.....	373
Table 7.13: Energy recovery potential of a vent condenser for several steam velocities and pipe diameters	374
Table 7.14: Percentage of steam obtained per mass of condensate as a function of both condensate and steam pressures	375
Table 7.15: Technical data for the Barajas Airport's trigeneration plant.....	381
Table 7.16: Advantages and disadvantages of renting CAS equipment.....	385
Table 7.17: Advantages and disadvantages of supplying a CAS via an ESCO.....	386
Table 7.18: Advantages and disadvantages of energy via an ESCO	387
Table 7.19: Average emission factors associated with generating electrical power.....	396
Table 7.20: Average emission factors for steam generation	397

SCOPE

This document together with other BREFs in the series (see list on the reverse of the title page), are intended to cover the energy efficiency issues under the IPPC Directive. Energy efficiency (ENE) is not restricted to any one industry sector mentioned in Annex 1 to the Directive as such, but is a horizontal issue which is required to be taken into account in all cases (as described below). In the Directive there are direct and indirect references to energy and energy efficiency in the following recitals and articles (in the order they appear in the Directive):

- (Recital) 2. Whereas the objectives and principles of the Community's environment policy, as set out in Article 130 r of the Treaty, consist in particular of preventing, reducing and as far as possible eliminating pollution by giving priority to intervention at source and **ensuring prudent management of natural resources**, in compliance with the 'polluter pays' principle and the principle of pollution prevention; (*generally, most energy in Europe is derived from non-renewable natural resources*)
- (Recital) 3. Whereas the Fifth Environmental Action Programme, ... in the resolution of 1 February 1993 on a Community programme of policy and action in relation to the environment and sustainable development (4), accords **priority to integrated pollution control as an important part of the move towards a more sustainable balance between human activity and socio-economic development, on the one hand, and the resources and regenerative capacity of nature, on the other**
- Article 2(2): 'pollution' shall mean the direct or indirect introduction of...vibrations, **heat** or noise which may be harmful to human health or the quality of the environment... (*vibration, heat and noise are all manifestations of energy*)
- Article 3: Member States shall take the necessary measures to provide that the competent authorities ensure that installations are operated in such a way that:
 - (d) **energy is used efficiently**
- Article 6.1: Member States shall take the necessary measures to ensure that an application to the competent authority for a permit includes a description of:
 - the raw and auxiliary materials, other substances **and the energy used in, or generated by**, the installation
- Article 9.1: Member States shall ensure that the permit includes all measures necessary for compliance with the requirements of Articles 3 and 10 (**which includes energy efficiency, see Article 3 above**)
- Annex IV (item 9). One of the issues to be taken into account in determining BAT generally or specifically is the consumption and nature of raw materials (including water) used in the process **and their energy efficiency**.

The IPPC Directive has been amended by Council Directive 2003/87/EC of 13 October 2003 establishing a scheme for greenhouse gas emission allowance trading within the Community (the ETS Directive):

- Article 9(3): For activities listed in Annex 1 to Directive 2003/87/EC Member States may choose **not to impose requirements relating to energy efficiency** in respect of **combustion units or other units emitting carbon dioxide** on the site.

Energy efficiency is a priority issue within the European Union and this document on energy efficiency has links to other Commission policy and legal instruments. The key examples are:

Policy instruments:

- the Berlin Declaration March 2007
- the Energy Efficiency Action Plan October 2007 COM(2006)545 FINAL
- the Green Paper on Energy Efficiency COM(2005)265 final of 22 June 2005
- Commission Communication on the implementation of the European Climate Change Programme (COM(2001)580 final) E CCP concerning energy efficiency in industrial installations (specifically mandating this document, see Preface)
- the Green Paper Towards a European strategy for the security of energy supply (COM(2000) 769 final) of 29 November 2000.

Legal instruments:

- Council Directive 2004/8/EC of 11 February 2004 on the promotion of cogeneration based on a useful heat demand in the internal energy market and amending Directive 92/42/EEC
- Council Directive 2006/32/EC of 5 April 2006 on energy end-use efficiency and energy services and repealing Council Directive 93/76/EEC
- the framework Directive for the setting of eco-design requirements for energy using products, EuP (2005/32/EC)

Other tools for policy implementation:

- action plan for sustainable industrial policy
- an Energy Efficiency Toolkit for SMEs developed in the framework of the EMAS Regulation
- studies and projects under the umbrella Intelligent Energy – Europe and SAVE, which deal with energy efficiency in buildings and industry.

This document also interfaces with the BREFs for specific industry sectors ('vertical BREFs'), in particular the BREF for Large Combustion Plants (LCP), where energy efficiency is a major topic). It also interfaces with the BREFs for industrial cooling systems (ICS) and common waste water and waste gas treatment/management systems in the chemical sector (CWW) ('horizontal' BREFs, applicable to more than one sector).

Energy efficiency in this document

The policy statements place energy policy (including reduction of use) and climate protection (specifically, reducing the impact of combustion gases) among the top priorities of the European Union.

The IPPC Directive has been amended to take account of the Emission Trading Scheme (ETS) Directive¹ (and to include amendments to take account of the Aarhus convention). However, the efficient use of energy remains one of its general principles. In summary, for activities listed in Annex I to Directive 2003/87/EC, Member States may only choose not to impose energy efficiency requirements in respect of combustion units or other units directly emitting carbon dioxide. This flexibility does not apply to units not directly emitting carbon dioxide within the same installation.

This document therefore contains guidance on energy efficiency for all IPPC installations (and their component units).

¹ Directive 2003/87/EC of the European Parliament and of the Council of 13 October 2003 establishing a scheme for greenhouse gas emission trading within the Community and amending Council Directive 2008/1/EC. See Annex 7.14

This guidance in this document may also be useful to operators and industries not within the scope of IPPC.

The IPPC Directive is concerned with the activities defined in its own Annex 1, and those directly associated activities with technical connections. It is not concerned with products. Energy efficiency in this context therefore excludes any consideration of the energy efficiency of products, including where the increased use of energy in the installation may contribute to a more energy efficient product. (For example, where extra energy is used to make a higher strength steel, which may enable less steel to be used in car construction and result in fuel savings). Some good practice measures that can be applied by the operator but are outside of the scope of IPPC permitting are discussed in the annexes (e.g. transport, see Annex 7.15).

The efficient use of energy and the decoupling of energy use from growth is a key aim of sustainability policies. The IPPC Directive considers energy as a resource and requires it to be used efficiently, without specifying the source of the energy. This document therefore discusses energy efficiency in terms of all energy sources and their use within the installation to provide products or services. It does not consider the replacement of primary fuels by secondary fuels or renewable energy sources as an improvement in energy efficiency. The replacement of fossil fuels by other options is an important issue, with benefits such as the net decrease in CO₂ and other greenhouse gas emissions, improved sustainability and security of energy supply, but is dealt with elsewhere. Some specific sector BREFs discuss the use of secondary fuels and wastes as energy sources.

Some references use the term 'energy efficiency management' and others 'energy management'. In this document, (unless stated otherwise) both terms are taken to mean the achievement of the efficient use of physical energy. Both terms can also mean the management of energy costs: normally, reducing the physical quantity of energy used results in reducing costs. However, there are techniques for managing the use of energy (particularly reducing the peak demands) to stay within the lower bands of the suppliers' tariff structure, and reduce costs, without necessarily reducing the overall energy consumption. These techniques are not considered part of energy efficiency as defined in the IPPC Directive.

This document has been elaborated after the first edition of all other BREFs. It is therefore intended that it will serve as a reference on energy efficiency for the revision of the BREFs.

Energy efficiency issues covered by this document

Chapter	Issues
1	Introduction and definitions
1.1	Introduction to energy efficiency in the EU and this document. Economics and cross-media issues (which are covered in more detail in the ECM BREF)
1.2	Terms used in energy efficiency, e.g. energy, work, power and an introduction to the laws of thermodynamics
1.3	Energy efficiency indicators and their use The importance of defining units, systems and boundaries Other related terms, e.g. primary and secondary energies, heating values, etc.
1.4	Using energy efficiency indicators in industry from a top-down, whole site approach and the problems encountered
1.5	Energy efficiency from a bottom-up approach and the problems encountered The importance of a systems approach to improving energy efficiency Important issues related to defining energy efficiency
2	Techniques to consider in achieving energy efficiency at an installation level The importance of taking a strategic view of the whole site, setting targets and planning actions before investing (further) resources in energy-saving activities
2.1	Energy efficiency management through specific or existing management systems
2.2	Planning and establishing objectives and targets through: <ul style="list-style-type: none"> • continuous environmental improvement • consideration of the installation in total and as its component systems

Chapter	Issues
2.3	Considering energy efficiency at the design stage for new or upgraded plant including: <ul style="list-style-type: none"> selecting energy efficient process technologies
2.4	Increasing process integration between processes, systems and plants to increase efficient use of energy and raw materials
2.5	Maintaining the impetus of energy efficiency initiatives over long time periods
2.6	Maintaining sufficient expertise at all levels to deliver energy efficient systems, not just in energy management, but in expert knowledge of the processes and systems
2.7	Communicating energy efficiency initiatives and results, including: <ul style="list-style-type: none"> the use of Sankey diagrams
2.8	Effective control of processes: ensuring that processes are run as efficiently as possible, for greater energy efficiency, minimising off-specification products, etc. using both: <ul style="list-style-type: none"> process control systems quality (statistical) management systems
2.9	The importance of planned maintenance and prompt attention to unscheduled repairs, which waste energy, such as steam and compressed air leaks
2.10	Monitoring and measuring are essential issues, including: <ul style="list-style-type: none"> qualitative techniques quantitative measurements, using direct metering and advanced metering systems applying new generation flow-metering devices using energy models, databases and balances optimising utilities using advanced metering and software controls
2.11	Energy auditing is an essential technique to identify areas of energy usage, possibilities for energy saving, and checking the results of actions taken
2.12	Pinch technology is a useful tool where heating and cooling streams exist in a site, to establish the possibilities of integrating energy exchange
2.13	Exergy and enthalpy analysis are useful tools to assess the possibility of saving energy and whether the surplus energy can be used
2.14	Thermoeconomics combines thermodynamic and economic analyses to understand where energy and raw material savings can be made
2.15	Energy models include: <ul style="list-style-type: none"> the use of models, databases and balances the use of sophisticated modelling to optimise the management of utilities including energy
2.16	Benchmarking is a vital tool in assessing the performance of an installation, process or system, by verifying against external or internal energy usage levels or energy efficient methods
3	Techniques to consider in achieving energy efficiency at a system level, and at a component parts level. This discusses the techniques to consider when optimising systems, and techniques for equipment that has not been optimised as part of a system review
3.1	The main combustion techniques are discussed in the LCP BREF. When combustion is an important part of an IPPC process (such as melting furnaces), the techniques used are discussed in the appropriate vertical BREFs. In this document, key techniques are highlighted, and additional techniques and detail are discussed
3.2 S	team systems
	Heat recovery by using heat exchangers and heat pumps <i>Note: Cooling systems are discussed in the ICS BREF</i>
3.4	The main types of cogeneration are explained, as well as trigeneration and the use of trigeneration in district heating and cooling
3.5	The way electrical power is used in an installation can result in energy inefficiencies in the internal and external supply systems
3.6	Electric motor driven sub-systems are discussed in general, although specific systems are discussed in more detail (see Sections 3.7 and 3.8)
3.7	The use and optimisation of compressed air systems (CAS)
3.8	Pumping systems and their optimisation
3.9	Heating ventilation and air conditioning (HVAC)
3.10 L	ighting and its optimisation
3.11	Drying separation and concentration processes and their optimisation
4	BAT conclusions for energy efficiency techniques
Annexes	Additional data and more detailed examples

The boundary of this document with other BREFs

This document gives:

- horizontal guidance and conclusions on what is considered to be BAT for energy efficiency in a general sense for all the activities in Annex 1 to the IPPC Directive
- references to BREFs where particular techniques for energy efficiency have already been discussed in detail, and can be applied to other sectors. For example:
 - the LCP BREF discusses energy efficiency relating to combustion and points out that these techniques may be applied to combustion plants with a capacity below 50 MW
 - the ICS BREF
- more information on techniques that can be found in other BREFs, where this is thought to be helpful (e.g. the OFC and SIC BREFs already include pinch Methodology).

This document does not:

- include information that is specific to sectors covered by other BREFs. For example:
 - energy efficiency of specific large volume inorganic chemical processes as discussed in the LVIC-S and LVIC-AAF BREFs
 - the energy efficiency of electroplating solutions is discussed in the STM BREF
- derive sector-specific BAT.

However, a summary of sector-specific BAT from other BREFs are included in [283, EIPPCB] for information.

This document provides general guidance, and therefore may also provide information useful to other industries not covered by the IPPC Directive.

How to use this document in conjunction with vertical sector BREFs

The following steps need to be considered in order to ensure that the best use is made of information on (best available) techniques on issues which are covered by both vertical and horizontal BREFs (see Figure 1). Examples are given in relation to ENE:

Step 1: consult information from the relevant vertical sector BREF

Identify appropriate techniques and BAT in the vertical sector BREF, such as for energy efficiency. If there are sufficient data, use the BAT and supporting data in preparing the permit.

Step 2: identify, consult and add information from other relevant vertical BREFs for associated activities on the site

Other vertical BREFs may contain techniques to consider and BAT on activities within an installation which are not covered by the vertical sector BREF.

In particular, for energy efficiency, the LCP (Large Combustion Plant) BREF provides information and BAT on combustion and the raising and use of steam.

The expert information on techniques in vertical BREFs may be applied in other sectors, such as where a sector is covered by more than one BREF (e.g. chemicals, surface treatment), or the operator wishes to seek additional information and techniques.

Step 3: identify, consult and add information from relevant horizontal BREFs

To ensure expert generic data are used to assist the implementation of BAT in the specific vertical sector, consult also the horizontal BREFs². The installation may have systems or activities not discussed in the vertical BREF.

For example, the Energy Efficiency BREF contains BAT and techniques to consider for:

- energy management, such as management systems, audit, training, monitoring, control and maintenance
- the main energy-using systems in many installations, such as steam, heat recovery, cogeneration, electrical power supply, electric motor driven sub-systems, compressed air systems (CAS), pumping systems, HVAC (heating, ventilation and air conditioning), lighting, and drying, separation and concentration systems.

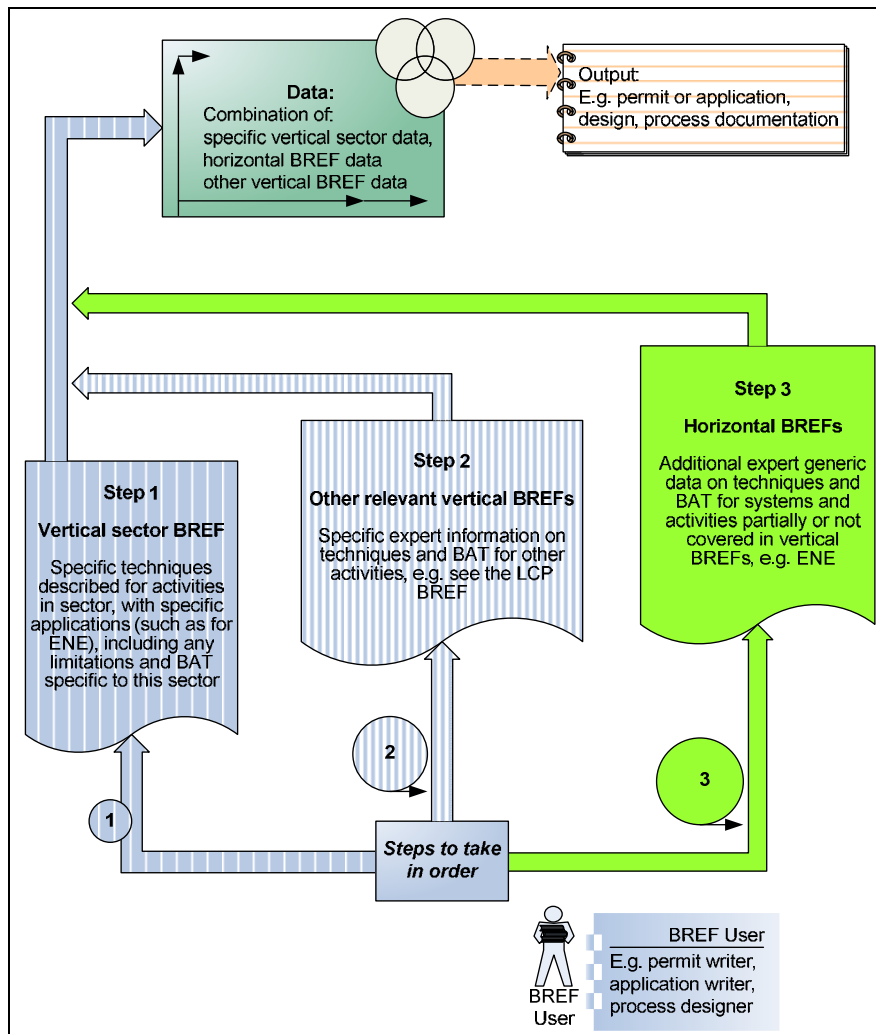

Figure 1: Using vertical sector BREFs with horizontal BREFs

² The so-called horizontal BREFs are: energy efficiency (ENE), cooling (ICS), common waste water/waste gas treatment/management (CWW), economics and cross-media effects (ECM), monitoring (MON), and emissions from storage (EFS)

1 INTRODUCTION AND DEFINITIONS

[3, FEAD and Industry, 2005] [97, Kreith, 1997]

<http://columbia.thefreedictionary.com/energy> [TWG [127, TWG, , 145, EC, 2000]

1.1 Introduction

1.1.1 Energy in the EU industrial sector

'We intend jointly to lead the way in energy policy and climate protection and make our contribution to averting the global threat of climate change.' Berlin Declaration (25 March 2007)

In 2004, industrial energy use in the EU-25 was 319 Mtoe (million tonnes of oil equivalent, 11 004 PJ) or about 28 % of the annual EU final energy use, and 30 % of primary energy demand³.

27 % of primary fuels are used in public thermal (electricity) power stations. The next two most energy intensive users are the iron and steel and chemical industries which consume 19 % and 18 % of industrial energy use respectively. This is followed by glass, pottery and building materials at 13 %, and paper and printing at 11 %. Around 25 % of electricity used by industry is produced by industry itself. Recent figures do not show significant variation year on year (i.e. between 2000 and 2004). Other figures on IPPC industries are given in Figure 1.1.

According to the EPER, the main IPPC emitters account for about 40 % of all European CO₂ emissions, about 70 % of all SO_x emissions and about 25 % of all NO_x emissions [145, EC, 2000, 152, EC, 2003] [251, Eurostat].

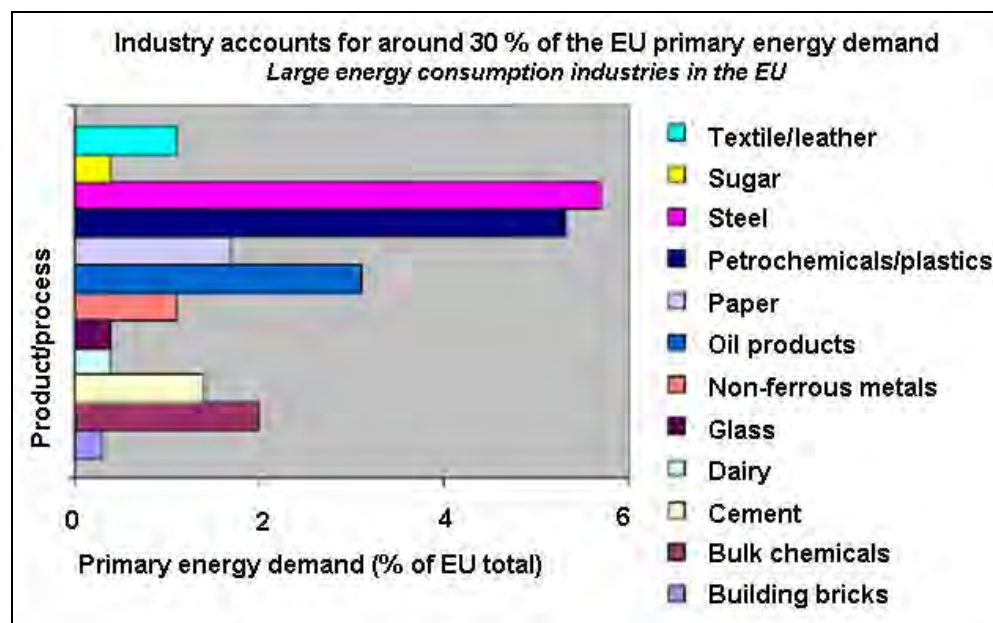

Figure 1.1: Percentage of EU primary energy demand used by process industries
[145, EC, 2000]

³ See Section 1.3.6.1 for a discussion of primary, secondary and final energies

1.1.2 The impacts of energy usage

Global warming

Certain gases contribute to warming in the atmosphere by the absorption of radiation from the Earth's surface, and re-emitting radiation at longer wavelengths. The part of this radiation re-emitted to the atmosphere and the Earth's surface is termed the 'greenhouse effect', due to its warming effect. The major greenhouse gases (GHGs) are water vapour, carbon dioxide (CO₂), methane (CH₄) and ozone (O₃), and, among others, nitrous dioxide (N₂O). This warming process is natural and crucial to the maintenance of the Earth's ecosystem.

However, the atmospheric concentration of carbon dioxide, the main (anthropogenic) greenhouse gas, has increased by 34 % compared with pre-industrial levels as a result of human activities, with an accelerated rise since 1950. Other greenhouse gas concentrations have also risen as a result of human activities. The main sources are CO₂ and nitrogen oxides from the combustion of fossil fuels in industry (including electricity generation), households and transport. (Others are the changes in land uses and agriculture releasing CO₂ and CH₄), and the emission of other man-made GHGs from specific processes and uses).

The current concentrations of CO₂ and CH₄ have not been exceeded during the past 420 000 years and the present N₂O concentration during at least the past 1 000 years. IPCC (2001) baseline projections show that greenhouse gas concentrations are likely to exceed the level of 550 ppm CO₂-equivalent in the next few decades (before 2050), see Figure 1.2 [252, EEA, 2005]. In a 2006 baseline scenario, CO₂ emissions will be almost two and a half times the current level by 2050 [259, IEA, 2006].

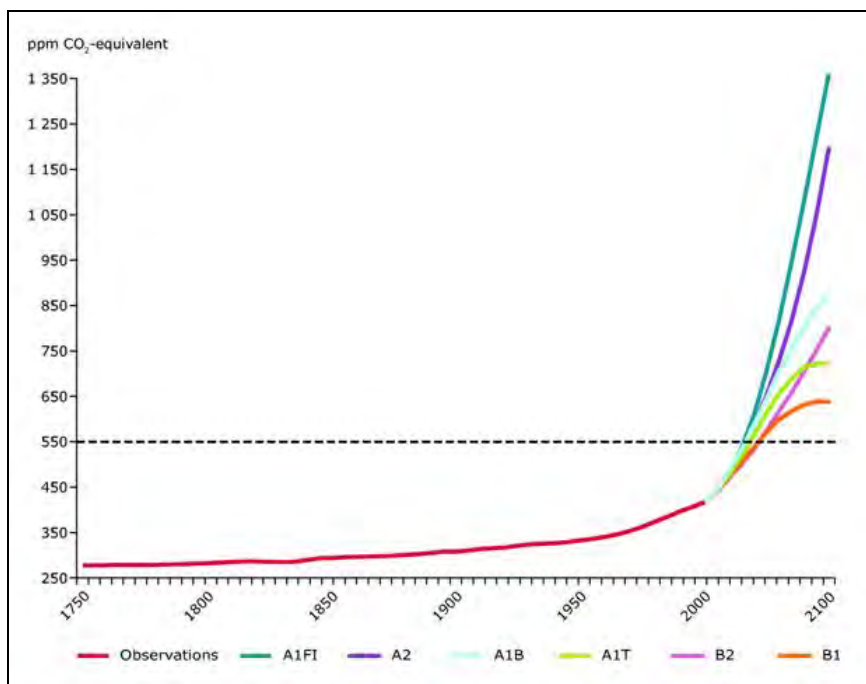

Figure 1.2: Increasing atmospheric GHG concentrations since 1750 as ppm CO₂ equivalents showing various scenarios [252, EEA, 2005]

The effects of the increasing concentration of GHGs and the consequential global warming are now widely acknowledged (various IPCC reports et al) [262, UK_Treasury]. For the EU, whilst detailed information is still limited, projected changes in climate are expected to have wide ranging impacts and economic effects. The overall net economic effects are still largely uncertain, however, there is a strong distributional pattern, with more adverse effects in the Mediterranean and south eastern Europe [252, EEA, 2005].

Dependency on fossil fuels and security of supply

In 2001, the energy structure of the EU remained heavily dependent on fossil fuels (79 % of the gross inland consumption), including a significant proportion of imported oil and gas. The EU imports over 50 % of its energy supplies, and this is expected to rise to more than 70 % in the next 20 – 30 years [145, EC, 2000].

1.1.3 The contribution of energy efficiency to reducing global warming impacts and to improving sustainability

According to numerous studies in 2000 [145, EC, 2000], the EU could save at least 20 % of its present energy consumption in a cost-effective manner, equivalent to EUR 60 000 million per year, or the combined energy consumption of Germany and Finland in 2000 [140, EC, 2005]. This paper also points out that energy savings are without doubt the quickest, most effective and most cost-effective way to reduce greenhouse gas emissions, as well as improving air quality. Energy efficiency is also an important factor in the management of natural resources (in this case, energy sources) and sustainable development, and plays an important role in reducing European dependence on these resources. Such an efficiency initiative, although requiring considerable investments, would make a major contribution to the Lisbon objectives, by creating as many as a million new jobs and increasing competitiveness [145, EC, 2000, 152, EC, 2003]. Accordingly, the EU has announced an Energy Efficiency Action Plan to save up to 20 % of energy throughout the Union (about 39 Mtoe), and 27 % of energy in manufacturing industries by 2020. This would reduce direct costs in the EU by EUR 100 000 million annually by 2020 and save around 780 million tonnes of CO₂ per year [142, EC, 2007].

Many sectors have considerably improved energy efficiency over the past 20 years. Dominant market drivers are productivity, product quality and new markets. EU energy efficiency legislation is recent (see the Preface), although legislation has existed for a longer period in certain Member States. The steps which industry has taken have largely been voluntary and usually driven by cost, but are also in conjunction with EU and MS initiatives (see Preface and Annex 7.13). For example, the EU chemical industry is one of the biggest gas consumers among EU manufacturing industries, and energy represents up to 60 % of the production costs. However, the chemical industry's specific energy consumption has reduced by 55 % from 1975 to 2003.

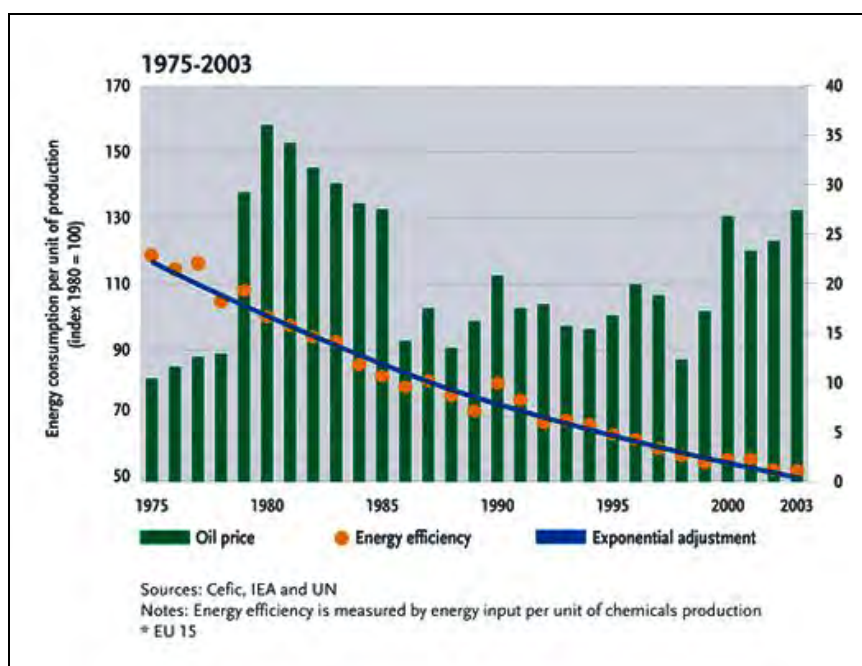

Figure 1.3: Chemical industry energy usage 1975 – 2003

However, the need to sustain energy efficiency improvements is vital. Projections show that energy-related CO₂ emissions can be returned to their 2006 levels by 2050 and the growth of oil demand can be moderated, based on existing technologies, primarily on improved energy efficiency (the others are a shift from fossil fuels for electricity supply and transport). Energy efficiency gains are a first priority for a more sustainable energy future, and are often the cheapest, fastest and most environmentally friendly way to reduce emissions and change increasing energy demands. In scenarios projected in 2006, improved energy efficiency in the buildings, industry and transport sectors leads to between 17 and 33 % lower energy use than in the baseline scenario by 2050. Energy efficiency accounts for between 45 and 53 % of the total CO₂ emissions reduction relative to the baseline by 2050, depending on the scenario. In a scenario in which global efficiency gains relative to the baseline are only 20 % by 2050, global CO₂ emissions increase by more than 20 % compared to the other scenarios [259, IEA, 2006].

1.1.4 Energy efficiency and the IPPC Directive

The legal background to energy efficiency and this document is set out fully in the Preface and the Scope. The permit writer and operator should be aware of what using energy efficiently means, how it can be achieved, measured or assessed and therefore how it may be considered in a permit.

The industrial activities covered by IPPC are listed in Annex 1 to the IPPC Directive. Examples of IPPC production processes/units/sites are:

- a gas powered electricity plant takes in gas as its feedstock (input) and the product of this production process is electricity. The energy used is the energy available within the gas. Low grade heat energy is also generated (as well as the electricity), and this is usually lost in cooling. If it can be used (e.g. in a district heating scheme), then the specific energy efficiency is improved
- a refinery takes in crude oil and transforms this into petrol, diesel, fuel oil and a number of other products. A part of the hydrocarbon processed in the refinery is burned internally to provide the necessary energy for the conversion process. Usually, some electricity also needs to be imported, unless a cogeneration plant is installed within the refinery, in which case the refinery may become a net exporter of electricity
- a steam cracker takes in liquid and gaseous feeds from a refinery and converts these to ethylene and propylene, plus a number of by-products. A part of the energy consumed is generated internally in the process, supplemented by imports of steam, electricity and fuel
- the feeding to the rolling mill in a steelworks consists of a approximately 2 decimetres thick flat steel plates that are rolled out into coil with a thickness of a few millimetres. The rolling mill consists of furnaces, rolling mill equipment, cooling equipment and support systems
- a waste incinerator (in northern Europe) takes 1 50 000 t of waste left after material recycling and biological recovery from a population of 50 0 000. The incinerator can generate 60 000 MWh of electricity a year, and of this, 15 000 MWh/yr are used internally and 45 000 MWh/yr are exported to the grid. This will supply the domestic electrical consumption of 60 000 inhabitants. Where there is also a demand for heat, the incinerator can operate in cogeneration mode (i.e. as a combined heat and power plant, CHP): the high pressure steam is used to generate electricity and the remaining low or medium pressure steam is used for district heating or cooling, or by industry. It is more efficient to generate heat, and when the heat is used outside the installation, the electricity generated is less. If there is sufficient heat demand, the plant can be constructed to supply heat only. The supply and balance of electricity generated and heat produced depend on there being a use for the heat and other contract conditions
- an intensive poultry (broiler) rearing installation has places for 40 000 birds, and rears chicks to the required slaughter weight (in five to eight weeks). The units use energy in feeding and watering systems, lighting, moving manure and bedding and ventilation/heating/cooling. The manure is usually spread on land, but may be used as a

feedstock in a biogas generation plant on- or off-site. The biogas may be used to heat the livestock units

- a publication gravure printing installation has five printing presses with 40 ink units, producing high quality magazines and catalogues. It uses electrical energy for the motors driving the presses, in compressed air and hydraulic systems used in the printing processes, natural gas for drying and steam for regenerating its toluene recovery system (using solvent absorption in the waste treatment system).

All IPPC installations have associated activities and supporting facilities using energy, such as systems for hydraulics, lubricating, compressed air, ventilation, heating, cooling and the constituent pumps, fans, motors, etc. There are also maintenance workshops, staff areas, offices, changing rooms, store areas, etc. which will require heating or cooling, hot water, lighting etc.

1.1.5 Energy efficiency in integrated pollution prevention and control

Energy efficiency techniques are available from a wide variety of sources, and in many languages. This document considers key concepts and techniques in the perspective of *integrated pollution prevention and control* for the whole installation. The information exchange showed that while individual techniques can be applied and may save energy, it is by considering the whole site and its component systems strategically that major energy efficiency improvements can be made. For example, changing the electric motors in a compressed air system may save about 2 % of the energy input, whereas a complete review of the whole system could save up to 37 % (see Section 3.7). Indeed, concentrating on techniques at the constituent (component) part level may be too prescriptive. In some cases, this may prevent or delay decisions which have a greater environmental benefit, by utilising financial and other resources for investments that have not been optimised for energy efficiency.

Equally, in some cases, applying energy efficiency techniques at a component or system level may also maintain or increase cross-media effects (environmental disbenefits). An example would be an installation using organic solvents in surface treatment (coating). Individual components (e.g. motors) may be changed for more energy efficient ones, even the solvent extraction and the waste gas treatment (WGT) system may be optimised to minimise energy usage, but a major environmental gain would be to change part or all of the process to be low solvent or solvent-free (where this is technically applicable). In this case, the actual process may use more energy than the original coating process in drying or curing, but major energy savings would result from no longer requiring an extraction and WGT system. In addition, the overall solvent emissions from the site could be reduced (see Section 2.2.1 and the STS BREF).

Detail of document layout

The details of how this document is laid out are set out in the Scope.

The explanations and terms given in this chapter and other chapters are an introduction to the issues, and relate to IPPC and other industries generally at a non-energy expert level. More extensive scientific information and explanations (as well as the mathematical formulae and derivations) can be found in Annex 7.1 and standard textbooks or references on thermodynamics.

1.1.6 Economic and cross-media issues

Energy is the same as other valuable raw material resources required to run a business – and is not merely an overhead and part of business maintenance. Energy has costs and environmental impacts and needs to be managed well in order to increase the business' profitability and competitiveness, as well as to mitigate the seriousness of these impacts.

Energy efficiency is given a high degree of importance in EU policy (in statements such as the Berlin Declaration, where it is the only environmental issue raised [141, EU, 2007]). In considering the economics and cross-media effects of implementing BAT within an installation, the importance of energy efficiency should be taken into account when considering the requirements of Art 9 (4), i.e. the permit ELVs and equivalent parameters.

The Commission has indicated that it can be expected that process-integrated measures will generally have a positive or more or less neutral impact on the profitability of enterprises⁴. It is inevitable that some BAT will not have a payback, but their societal benefits outweigh the costs incurred, in keeping with the 'polluter pays' principle.

The determination of BAT involves an assessment of the estimated net costs of implementing a technique in relation to the environmental benefits achieved. A second economic test relates to whether the technique can be introduced in the relevant sector under economically viable conditions. This affordability test can only be legitimately applied at a European sector level⁵ [152, EC, 2003].

Energy efficiency has the advantage that measures to reduce the environmental impact usually have a financial payback. Where data have been included in the information exchange, costs are given for individual techniques in the following chapters (or are given in the relevant vertical sector BREFs). The issue often arises of cost-benefit, and the economic efficiency of any technique can provide information for assessing the cost-benefits. In the case of existing installations, the economic and technical viability of upgrading them needs to be taken into account. Even the single objective of ensuring a high level of protection for the environment as a whole will often involve making trade-off judgements between different types of environmental impact, and these judgements will often be influenced by local considerations (as noted in the Preface). For example, in some cases energy consumption may be increased to reduce other environmental impacts as a result of implementing IPPC (for instance, using waste gas treatment to reduce emissions to air).

Economic and cross-media issues are discussed in detail in the ECM BREF, including options for assessing cross-media effects, and for calculating cost-benefits. The following practical examples have been identified in the information exchange and may be helpful:

- in several Member States, a technique is considered to have a viable cost-benefit if it has a return on investment (ROI) of 5 to 7 years, or about 15 % ROI (different figures are used in different MS or regions) [249, TWG, 2007]
- for energy efficiency, many techniques can be assessed for their economic benefit on their lifetime cost. For instance, of the lifetime cost of electrical motors, 2.5 % is the purchase cost, 1.5 % is for maintenance and 96 % is the cost of energy used
- one Member State has published an internationally acclaimed report on the economic importance of mitigating climate change. In seeking to assess the potential costs of damage from climate change, the MS uses the figure of GBP 70/t (EUR 100/t) carbon for 2000, plus GBP 1/t/yr (EUR 1.436/t/yr) annual inflation (GBP 19/t (EUR 27.28/t) CO₂

⁴ COM(2003) 354 final states: 'End-of-pipe' measures often have a negative short term impact on profitability. However, no 'end-of-pipe' measures exist for energy efficiency; the nearest analogy is easy bolt-in replacements, such as motors. These may not achieve the best environmental and/or economic returns. See Section 1.5.1

⁵ 'Sector' should be understood as a relatively high level of disaggregation, e.g. the sector producing chlorine and caustic soda rather than the whole chemical sector.

plus GBP 0.27/t (EUR 0.39/t) annual inflation). (At a conversion rate of 1GBP = 1.436 EUR, 1st April 2006). This figure may be used when comparing the externalities or societal costs of the cross-media effects [262, UK_Treasury, 2006]

http://www.hm-treasury.gov.uk/documents/taxation_work_and_welfare/taxation_and_the_environment/tax_env_GESWP140.cfm

- a recent international report showed that CO₂ levels could be returned to/maintained at current levels using existing technologies including improved energy efficiency. This target was given a price of USD 25 (EUR 20.68) per tonne of CO₂ which would add about USD 0.02 (EUR 0.017) per kWh to the cost of coal-fired electricity and about USD 0.07/litre (EUR 0.058/litre, USD 0.28/gallon) to the cost of petrol. The average cost per tonne CO₂ emissions reduction for the whole technology portfolio, once all technologies are fully commercialised, is less than USD 25 (EUR 20.68). This was less than the level of trading per tonne CO₂ in the opening periods of the EU emissions trading scheme (At a conversion rate of 1USD = 0.827 EUR, April 2006) [259, IEA, 2006]

Calculators used to calculate cost savings

Various software calculators have been developed. They can be useful in assisting with calculations, but they have some disadvantages which must be taken into account if they are used

- they are often based on changing individual pieces of equipment, e.g. motors, pumps, lights, without considering the whole system in which the equipment works. This can lead to a failure to gain the maximum energy efficiencies for the system and the installation (see Sections 1.3.5 and 1.5.1.1)
- some are produced by independent sources, such as government agencies, but some are commercial and may not be wholly independent.

Examples of calculating tools can be found in Section 2.17 and in sites such as:

- http://www.energystar.gov/ia/business/cfo_calculator.xls
- http://www.martindalecenter.com/Calculators1A_4_Util.html

1.2 Energy and the laws of thermodynamics

[2, Valero-Capilla, 2005, 3, FEAD and Industry, 2005, 97, Kreith, 1997, 154, Columbia_Encyclopedia, , 227, TWG]

Energy is a primary entity and is difficult to define easily, as it is most correctly defined in mathematical terms. Colloquially, it is seen as the ability or capacity to do work (this could also be described as producing change or ‘available energy’). Thermodynamics is the study of energy and its transformations and there are key concepts, or laws, of thermodynamics. Some knowledge of the principles of thermodynamics is essential in understanding energy and energy efficiency. This section endeavours to give a relatively simple explanation with minimum reference to the mathematics involved. It is consequently scientifically inaccurate, and a more detailed and more accurate explanation is given in Annex 7.1 [269, Valero, 2007]. More information can also be found in standard textbooks (see Annex 7.1.4.1 for examples).

1.2.1 Energy, heat, power and work

Energy is measured in terms of this change of a ‘system’ from one state to another, measured in the SI system in joules. Energy can take a wide variety of forms and is named after the action (or work achieved by) a specific force. There are six main forms of energy generally used in industry:

(i) **Chemical energy** is the energy that bonds atoms or ions together. In industrial activities, it is stored in carbon-based fuels, and released by a chemical reaction (in this case oxidation, usually by combustion, releasing carbon dioxide). The energy released is usually converted to more usable forms, such as to mechanical energy (e.g. combustion engines), or to thermal energy (e.g. direct process heating).

(ii) **Mechanical energy** is associated with motion (such as the expansion in the cylinders of internal combustion engines), and can be used directly to drive machines, e.g. electrical generators, cars, lorries, etc. It is also widely used to power generators to produce electrical energy. Mechanical energy includes **wave** and **tidal energy**.

(iii) **Thermal energy** is the internal motion of particles of matter. It can be regarded as either the thermodynamic energy (or internal energy), or as a synonym for heat. However, heat is in reality the action of transferring the thermal energy from one system (or object) to another. Thermal energy can be released by chemical reactions such as burning, nuclear reactions, resistance to electric energy (as in electric stoves), or mechanical dissipation (such as friction).

(iv) **Electric energy** is the ability of electric forces to do work during rearrangements of positions of charges (e.g. when electric charge flows in a circuit). It is closely related to **magnetic energy** which is a form of energy present in any electric field or magnetic field (volume containing electromagnetic radiation), and is often associated with movement of an electric charge. Electromagnetic radiation includes **light energies**.

(v) **Gravitational energy** is the work done by gravity. While this can be seen in industry, e.g. in the moving of materials down chutes, its role in energy efficiency is limited to some energy calculations. Lifting and pumping, etc. are carried out by machines using electrical energy.

(vi) **Nuclear energy** is the energy in the nuclei of atoms, which can be released by fission or fusion of the nuclei. Electricity generating stations using nuclear energy are not within the scope of IPPC and nuclear energy is not dealt with in this document. However, electricity generated by nuclear power forms part of the energy mix of Europe, see Annex 7.16.

Potential and kinetic energy

All of the energies listed above are potential energies, where the energy is stored in some way, e.g. in the chemical bonds of a stable substance, in radioactive material. Gravitational potential energy is that energy stored due to the position of an object relative to other objects, e.g. water stored behind a dam. Kinetic energy is energy due to the movement of a body or particles. The classical example is a pendulum, where the maximum potential energy is stored in the pendulum at the top of its arc, and the maximum kinetic energy is when it is moving at the base of the arc. As can be seen from this basic example, the energies change from one form to another. Most of the fundamental interactions of nature can be linked to some kind of potential energy, although some energies cannot be easily classified on this basis, such as light.

Heat, heat transfer and work

Heat (Q) can be defined as energy in transit from one mass to another because of a temperature difference between the two. It accounts for the amount of energy transferred to a closed system during a process by a means other than work. The transfer of energy occurs only in the direction of decreasing temperature. Heat can be transferred in three different ways:

(i) **conduction** is the transfer of energy from the more energetic particles of a substance to the adjacent particles that are less energetic due to interactions between the particles. Conduction can take place in solids, liquids and gases

(ii) **convection** is the energy transfer between a solid surface at a certain temperature and an adjacent moving gas or liquid at another temperature

(iii) **thermal radiation** is emitted by matter as a result of changes in the electronic configurations of the atoms or molecules within it. The energy is transported by electromagnetic waves and it requires no intervening medium to propagate and can even take place in vacuum.

In thermodynamics, **work (W)** is defined as the quantity of energy transferred to (or from) one system from (or to) its surroundings. This is mechanical work (the amount of energy transferred by a force), historically expressed as the raising of a weight to a certain height.

Energy and power

In English texts (US and UK), the terms 'energy' and 'power' are frequently confused and used interchangeably. In physics and engineering, 'energy' and 'power' have different meanings. Power is energy per unit time (the rate of energy transfer to work). The SI unit of power (and radiant flux) is the watt (W), the SI unit of energy, work and quantity of heat is the joule (J): one watt is therefore one joule per second.

The phrases 'flow of power' and 'to consume a quantity of electric power' are both incorrect and should be 'flow of energy' and 'to consume a quantity of electrical energy'.

The joule is not a very large unit for practical measurement, and therefore units commonly used when discussing the energy production or consumption of equipment, systems and installations (and therefore, industrial energy efficiency) are: kilojoules (kJ), megajoules (MJ) or gigajoules (GJ).

Power consumption and output are expressed in terms of watts and again, as this is too small to be used in most industrial practice they are sometimes also expressed in terms of its multiples such the kilowatt (kW), megawatt (MW) and GW (GW)⁶.

It does not generally make sense to discuss the power rating (usage) of a device at '100 watts per hour' since a watt is already a rate of doing work, or a use of energy, of 1 joule of energy per second. As a rate itself, a watt does not need to be followed by a time designation (unless it is to discuss a change in power over time, analogous to an acceleration). The SI derived unit watt-hour (i.e. watt x hour) is also used as a quantity of energy. As the watt and joule are small units not readily usable in industrial energy applications, multiples such as the kilowatt-hour (kWh), megawatt-hour (MWh) and gigawatt-hour (GWh)⁷ are frequently used as units of energy, particularly by energy supply companies and energy users. A kilowatt-hour is the amount of energy equivalent to a power of 1 kilowatt used for 1 hour and $1 \text{ kWh} = 3.6 \text{ MJ}$. The use of kWh rather MJ is probably historic, and particular to the sector and application⁸.

⁶ A Pentium 4 CPU consumes about 82 W. A person working hard physically produces about 500 W. Typical cars produce between 40 to 200 kW mechanical power. A modern diesel-electric locomotive produces about 3MW mechanical power output.

⁷ The gigawatt-hour (GWh), which is 10^6 times larger than kilowatt-hour, is used for measuring the energy output of large power plants, or the energy consumption of large installations. (MWh is often too small unit for that)

⁸ A kilowatt-hour is the amount of energy equivalent to a power of one kilowatt running for one hour.

$$1 \text{ kWh} = 1000 \text{ W} * 3600 \text{ seconds} = 3\,600\,000 \text{ W-seconds} = 3\,600\,000 \text{ J} = 3.6 \text{ MJ}$$

The usual unit used to measure electrical energy is a watt-hour, which is the amount of energy drawn by a one watt load (e.g. a tiny light bulb) in one hour. The kilowatt hour (kWh), which is 1000 times larger than a watt-hour (equates to a single element electric fire), is a useful size for measuring the energy use of households and small businesses and also for the production of energy by small power plants. A typical house uses several hundred kilowatt-hours per month. The megawatt-hour (MWh), which is 1000 times larger than the kilowatt-hour, is used for measuring the energy output of large power plants, or the energy consumption of large installations.

Other terms that are used are megawatt electrical (MW_e), which refers to electrical power, and megawatt thermal (MW_t), which refers to thermal power, and are used to differentiate between the two. These are non-standard SI terms and theoretically not necessary (the International Bureau of Weights and Measures, BIPM, regards them as incorrect), but are used in practice, especially where both types of energy are used and/or produced, such as in electrical power generation and chemical production.

1.2.2 Laws of thermodynamics

As can be seen from Section 1.2.1, one form of energy can be transformed into another with the help of a machine or a device, and the machine can be made to do work (see Annex 7.1.1).

The relationships and concepts of these various energies are defined mathematically according to whether they are 'closed' or 'open' systems. 'Closed' systems allow no exchange of particles with the surroundings, but remain in contact with the surroundings. Heat and work can be exchanged across the boundary (see Figure 1.4).

In reality, industrial systems are 'open'. The properties of the system must also be defined, such as the temperature, pressure and concentration of chemical components, and the changes and rates of change of any of these.

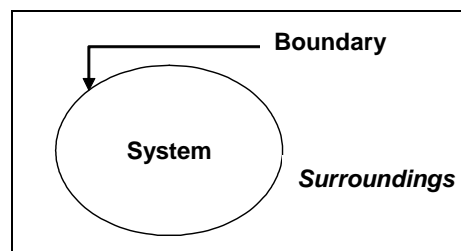

Figure 1.4: Thermodynamic system

1.2.2.1 The first law of thermodynamics: the conversion of energy

This law states that *energy can neither be created nor destroyed*. It can only be transformed. This means that the total flow of energy in a steady-state process⁹ of a defined system must equal the total flow outwards from the system.

Unfortunately, the terms, '*energy production*' or '*energy generation*' (although technically incorrect) are widely used, and appear in this document (as the term '*energy transformation*' is not widely used in industrial applications and appear unusual to some readers). The term '*energy use*' is widely used, as it implies neither creation nor destruction of energy. These terms are generally taken to mean the transformation of one form of energy into other forms of energy or work.

⁹ A steady state process is when the recently observed behaviour of a system does not change, e.g. when the flow of electricity or material in a network is constant (with the same physical parameters such as voltage, pressure, etc).

For a closed system, the first law implies that the change in system energy equals the net energy transfer to the system by means of heat and work. That is:

$$\Delta U = U_2 - U_1 = Q - W \quad (\text{In SI units, this is in joules})$$

Where: U_1 = the internal energy before change

U_2 = the internal energy after change

Q = heat: $Q > 0$ when received by the system

W = work: $W > 0$ when produced by the system

The theory of relativity combines energy and mass, therefore, both energy and matter are conserved, and the flows of energy and matter into and out of a defined system must balance. As mass is only changed into energy in nuclear fusion and fission reactions, this enables energy (and mass) balances to be calculated for reactions and processes. This is the basis of energy audits and balances, see Section 2.11.

Net energy efficiency according to the first law is given by (for the thermal efficiency for a heat engine) the fraction of the heat input converted to net work output:

$$\eta = \frac{W_{net,out}}{Q_{in}}$$

Where: η = efficiency

W = work

Q = heat

It can also be described as:

$$\text{efficiency } \eta = \frac{\text{energy output}}{\text{energy input}} = \frac{\text{work (W)}}{\text{energy (E)}}$$

In SI units, both useful work (W) done by the process and the energy (E) are in joules, so the ratio is dimensionless, between 0 and 1, or as a percentage. (Note this does not apply where steam, heat and electrical power have been expressed in equivalents, as in the WI BREF (or the WFD revision draft) [254, EIPPCB, 2005, 255, EC, et al., 2005].

1.2.2.2 The second law of thermodynamics: entropy increases

The second law states that *the entropy (see below) of a thermodynamically isolated system tends to increase over time.*

For a reversible process of a closed system, the *entropy* can be defined as:

$$\underbrace{S_2 - S_1}_{\text{Entropy change}} = \underbrace{\int_1^2 \left(\frac{\delta Q}{T} \right)}_{\substack{\text{Entropy} \\ \text{transfer} \\ \text{reversible} \\ \text{process}}} \quad (\text{in SI units} = \text{J/K})$$

Where:

S = entropy Q = heat T = temperature

This law describes the quality of a particular amount of energy, and the direction of the universe and all processes. The mathematical term *entropy* can be explained in different ways, which may help the understanding of this concept:

- energy that is dispersed, 'useless', or broken down into 'irretrievable heat' (dispersed into molecular movements or vibrations)
- a measure of the partial loss of the ability of a system to perform work due to the effects of irreversibility
- quantifies the amount of disorder (randomness) between the initial and final states of a system (e.g. the ways the molecules are arranged): i.e. this increases with time. As a consequence, pressure and chemical concentration also flow from the systems of higher pressure or concentration to lower ones, until the systems are at equilibrium.

There are various consequences of this law, some of which may also help to explain this concept¹⁰:

- in any process or activity, there is an inherent tendency towards the loss (or dissipation) of useful energy or work (e.g. through friction)
- heat moves in predictable ways, e.g. flowing from a warmer object to a cooler one
- it is impossible to transfer heat from a cold to a hot system without at the same time converting a certain amount of energy to heat
- work can be totally converted into heat, but not vice versa
- it is impossible for a device working in a cycle to receive heat from a single reservoir (isolated source) and produce a net amount of work: it can only get useful work out of the heat if the heat is, at the same time, transferred from a hot to a cold reservoir (it is not possible to get something out of a system for no thing). This means that a perpetual motion machine cannot exist.

In practical terms, it means no energy transformation can be 100% efficient (note the explanation of lower heat value, below, and see Section 1.3.6.2). However, it also means that a reduction in the increase of entropy in a specified process, such as a chemical reaction, means that it is energetically more efficient.

A system's energy can therefore be seen as the sum of the 'useful' energy and the 'useless' energy.

The *enthalpy* (H) is the useful heat (heat energy) content of a system and is related to the internal energy (U), pressure (P) and volume (V):

$$H = U + PV \quad (\text{in SI units, this is in joules})$$

U is associated with microscopic forms of energy in atoms and molecules.

As a system changes from one state to another, the enthalpy change ΔH is equal to the enthalpy of the products minus the enthalpy of the reactants:

$$\Delta H = H_{\text{final}} - H_{\text{initial}} \quad (\text{in SI units, this is in joules})$$

The final ΔH will be negative if heat is given out (exothermic), and positive if heat is taken in from its surroundings (endothermic). For a reaction in which a compound is formed from its composite elements, the enthalpy change is called the **heat of formation** (or **specific enthalpy change**) of the compound. There are specific enthalpy changes for combustion, hydrogenation, formation, etc.

¹⁰ There are other corollaries of this law, such as the universe is relentlessly becoming more disordered with time.

Physical changes of state, or phase, of matter are also accompanied by enthalpy changes, called **latent heats** or **heats of transformation**. The change associated with the solid-liquid transition is called the heat of fusion and the change associated with the liquid-gas transition is called the heat of vaporisation.

A system's energy change can therefore be seen as the sum of the 'useful' energy and the 'useless' energy. To obtain work, the interaction of two systems is necessary. **Exergy (B)** is the maximum useful work obtained if the system is brought into equilibrium with the environment (e.g. the same temperature, pressure, chemical composition, see Section 1.2.2.4).

The ratio of exergy to energy in a substance can be considered a measure of energy quality. Forms of energy such as kinetic energy, electrical energy and **Gibbs free energy (G)** are 100 % recoverable as work, and therefore have an exergy equal to their energy. However, forms of energy such as radiation and thermal energy cannot be converted completely to work, and have an exergy content less than their energy content. The exact proportion of exergy in a substance depends on the amount of entropy relative to the surrounding environment as determined by the second law of thermodynamics.

Exergy needs the system parameters to be defined (temperature, pressure, chemical composition, entropy, enthalpy) and can be expressed according to which parameters are being held constant. Specific flow exergy (E) of a given stream is calculated as:

$$E = H - H_0 - T_0 (s - s_0), \text{ where the subscript 0 means reference conditions}$$

As a practical illustration of 'useful energy': 300 kg of steam at 400 °C at 40 bar and 6 tonnes of water at 40 °C contains the same amount of energy (assuming the same reference temperature), i.e. 1 GJ. The steam at 40 bar can achieve useful work (such as generating electricity, moving mechanical equipment, heating, etc.) but there is limited use for water at 40 °C. The exergy of the low temperature stream can be raised but this requires the expenditure of energy. For example, heat pumps can be used to increase exergy, but consume energy as work.

1.2.2.3 Exergy balance: combination of first and second laws

The first and second laws can be combined into a form that is useful for conducting analyses of exergy, work potential and second law efficiencies amongst others. This form also provides additional insight into systems, their operation and optimisation, see Section 2.13.

Exergy balance for an open system

The exergy rate balance at constant volume is equal to:

$$\underbrace{\frac{dE_{cv}}{dt}}_{\text{Rate of exergy change}} = \underbrace{\sum_j \left(1 - \frac{T_0}{T_j}\right) \dot{Q}_j - \left(\dot{W}_{cv} - P_0 \frac{dV_{cv}}{dt}\right) + \sum_i \dot{m}_i e_i - \sum_e \dot{m}_e e_e}_{\text{Rate of exergy transfer}} - \underbrace{\dot{I}}_{\text{Rate of exergy destruction}}$$

Where:

E_{cv} = exergy at constant volume
 T = temperature
 t = time

The terms $\dot{m}_i e_i$ and $\dot{m}_e e_e$ = the rates of exergy transfer into and out of the system accompanying mass flow m (m_i to m_e)

\dot{Q}_j = the time rate of heat transfer at the location on the boundary where the instantaneous temperature is T_j

I = rate of exergy destruction, or irreversibility

P = pressure

V = volume

\dot{W}_{cv} = work at constant volume

For a steady flow system, the balance obtained is:

$$0 = \sum_j \left(1 - \frac{T_0}{T_j} \right) \dot{Q}_j - \dot{W}_{cv} + \sum_i \dot{m}_i e_i - \sum_e \dot{m}_e e_e - I$$

Industrial applications

The application of exergy to unit operations in chemical plants was partially responsible for the huge growth of the chemical industry during the twentieth century. During this time it was usually called 'available work'.

One goal of energy and exergy methods in engineering is to compute balances between inputs and outputs in several possible designs before a unit or process is built. After the balances are completed, the engineer will often want to select the most efficient process. However, this is not straightforward (see Section 2.13):

- an energy efficiency or first law efficiency will determine the most efficient process based on losing as little energy as possible relative to energy inputs
- an exergy efficiency or second law efficiency will determine the most efficient process based on losing and destroying as little available work as possible from a given input of available work.

A higher exergy efficiency involves building a more expensive plant, and a balance between capital investment and operating efficiency must be determined.

1.2.2.4 Property diagrams

If the properties of a system are measured (e.g. temperature T , pressure P , concentration, etc) and the system shows no further tendency to change its properties with time, the system can be said to have reached a **state of equilibrium**. The condition of a system in equilibrium can be reproduced in other (similar) systems and can be defined by a set of properties, which are the **functions of state**: this principle is therefore known as the **state postulate**. This implies that the state of a system of one pure substance can be represented in a diagram with two independent properties. The five basic properties of a substance that are usually shown on property diagrams are: pressure (P), temperature (T), specific volume (V), specific enthalpy (H), and specific entropy (S). Quality (X) is shown if a mixture of two (or more) substances is involved. The most commonly encountered property diagrams: pressure-temperature (P - T), pressure-specific volume (P - V), temperature-specific volume (T - V), temperature-entropy (T - S); enthalpy-entropy (H - S); and temperature-enthalpy plots (T - H), which are used in pinch methodology (see Section 2.12): These diagrams are very useful in plotting processes. Additionally, the first three diagrams are helpful for explaining the relationships between the three phases of matter.

Pressure-temperature (phase) diagrams

Phase diagrams show the equilibrium conditions between phases that are thermodynamically distinct.

The P-T diagram (Figure 1.5) for a pure substance shows a series representing *single phase regions* (solid, liquid, gaseous phases), where the phase of the substance is fixed by both the temperature and pressure conditions.

The lines (called *phase boundaries*) represent the regions (or conditions, which are, in this case P and T) where two phases exist in equilibrium. In these areas, pressure and temperature are not independent and only one intensive property (P or T) is required to fix the state of the substance. The sublimation line separates the solid and vapour regions, the vaporisation line separates the liquid and vapour regions and the melting or fusion line separates the solid and liquid regions.

All three lines meet at the *triple point*, where all the phases coexist simultaneously in equilibrium. In this case, there are no independent intensive properties: there is only one pressure and one temperature for a substance at its triple point.

The *critical point* is found at the end of the vaporisation line. At pressures and temperatures above the critical point, the substance is said to be at a supercritical state, where no clear distinction can be made between liquid and vapour phases. This reflects that, at extremely high pressures and temperatures, the liquid and gaseous phases become indistinguishable. For water, this is about 647 K (374 °C) and 22.064 MPa. At this point, a substance on the left of the vaporisation line is said to be at the state of a sub-cooled or compressed liquid; on the right of the same line, the substance is in a superheated-vapour state.

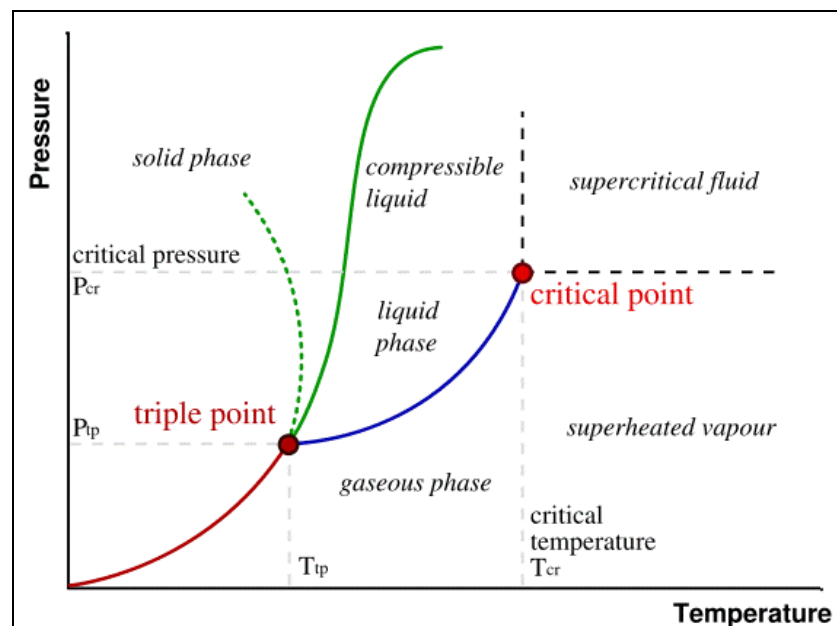

Figure 1.5: Pressure – temperature (phase) diagram
[153, Wikipedia]

1.2.2.5 Further information

Further information can be found in standard text books on thermodynamics, physical chemistry, etc.

A wide range of literature and databases provide information and tables containing the values of the thermodynamic properties of various substances and diagrams of their inter-relationships. These are derived from experimental data. The most frequently listed properties in tables are: specific volume, internal energy, specific enthalpy, specific entropy and specific heat. Property tables can be found in thermodynamic books, on the internet, etc.

As two intensive properties must be known to fix the state in single phase regions, the properties V , U , H and S are listed versus temperature at selected pressures for superheated vapour and compressed liquid. If there are no available data for a compressed liquid, a reasonable approximation is to treat compressed liquid as saturated liquid at the given temperature. This is because the compressed liquid properties depend on temperature more strongly than they do on pressure.

The so-called 'saturation' tables are used for saturated liquid and saturated vapour states. Since in two-phase regions, pressure and temperature are not independent, one of the properties is enough to fix the state. Therefore, in saturation tables, the properties V , U , H and S for saturated liquid and saturated vapour are listed either versus temperature or pressure. In the case of a saturated liquid-vapour mixture, an additional property called quality must be defined. Quality is defined as the vapour mass fraction in a saturated liquid-vapour mixture.

Details of databanks and thermodynamic simulation programs can be found in Annex 7.1.3.2.

1.2.2.6 Identification of irreversibilities

In thermodynamics, a *reversible process* is theoretical (to derive concepts) and in practice all real systems are *irreversible*. This means they cannot be reversed spontaneously; but only by the application of energy (a consequence of the second law). The mechanical, thermal and chemical equilibrium conditions of a thermodynamic system also imply three causes of disequilibrium or irreversibilities (these may be seen as thermodynamic inefficiencies in practice). Changes are caused by driving forces such as temperature; pressure, concentration, etc., as dictated by the second law of thermodynamics. The smaller the driving forces, the larger the required equipment size, for instance, heat exchange surface increases when LMTD (the log mean temperature difference) decreases. The Carnot cycle, which represents the highest efficiency at which heat can be converted in power, is based in principle on zero driving forces and in practice, the efficiencies of the Carnot cycle cannot be achieved in real operations. For a further explanation of the Carnot cycle, see the LCP BREF [125, EIPPCB] or a standard textbook.

Mechanical irreversibilities appear in processes that involve friction and commonly cause pressure changes.

Thermal irreversibilities appear when there is a finite temperature change within the system as, for instance, in every heat exchanger. The heat passes from a warm body to a cold one spontaneously, thereby losing exergy. Again, the larger the temperature change, the larger the loss of exergy and the more irreversible the process.

Chemical irreversibilities are due to a chemical disequilibrium, occurring in mixtures, solutions and chemical reactions. For example, when water and salt are mixed, the exergy of the system is decreased. This exergy loss can be visualised as the amount of work that was previously needed to purify water in order to obtain the salt, e.g. by distillation, ion exchange, membrane filtration, or drying. All atmospheric and water pollution involves chemical irreversibilities. It is very easy to contaminate (mix) but a lot of exergy is needed to clean up.

The thermodynamic analysis of irreversible processes reveals that, in order to obtain a good efficiency and save energy, it is necessary to control and minimise all the mechanical, thermal and chemical irreversibilities appearing in the plant.

Examples of each of these irreversibilities are given in Annex 7.2.

The greater the irreversibilities, the greater the scope for improving the efficiency of an energy system. The causes of poor energy design result from (significant) finite pressure, temperature and/or chemical potential differences, and from decoupling supply and demand. Time also plays an important role in energy efficient systems. Energy systems spontaneously decrease their pressure, temperature and chemical potentials to reach equilibrium with their surroundings. To avoid this, there are two strategies. One is to couple energy donors with energy acceptors immediately (see, for example, Section 3.3). Another is storage, by enclosing a system within rigid walls for pressure, adiabatic walls for temperature, and/or confine the chemical systems into metastable states. In other words, confine the systems into reservoirs that maintain their intensive properties constant with time.

Thermodynamics has a role to play in achieving the best attainable energy efficiency, and is practically applied through:

- energy efficient design, see Section 2.3
- analytical tools such as pinch, exergy and enthalpy analyses, see Sections 2.12 and 2.13
- thermoeconomics, which combines thermodynamic analysis with economics, see Section 2.14.

1.3 Definitions of indicators for energy efficiency and energy efficiency improvement

1.3.1 Energy efficiency and its measurement in the IPPC Directive

[4, Cefic, 2005, 92, Motiva Oy, 2005] [5, Hardell and Fors, 2005]

'Energy efficiency' is a term that is widely used qualitatively as the means to address different objectives, such as policy at national and international level, as well as business objects, principally (as can be seen in the Preface)¹¹:

- reduction of carbon emissions (climate protection)
- enhancement of the security of energy supplies (through sustainable production)
- reduction of costs (improvement in the competitiveness of business).

Initially 'energy efficiency' appears to be simple to understand. However, it is not usually defined where it is used, so *'energy efficiency can mean different things at different times and in different places or circumstances'*. This lack of clarity has been described as *'elusive and variable'*, leading to *'inconsistency and muddle'* and where energy savings need to be presented in quantitative terms, the lack of adequate definitions is *'embarrassing, especially when comparisons are made between major industries or between industry sectors'*. There is no definition of 'energy efficiency' in the IPPC Directive, and this section discusses the issues relating to its definition in the context of an installation and a permit [62, UK_House_of_Lords, 2005, 63, UK_House_of_Lords, 2005].

¹¹ The other major energy efficiency policy is the reduction of fuel poverty (e.g. households that cannot afford to keep warm in winter). This is a societal issue, and is not directly related to industrial energy efficiency and IPPC.

As the IPPC Directive deals with production processes within an installation, the focus of this document is the physical energy efficiency at an installation level. Although relevant when considering resources, the life cycles of products or raw materials are therefore not considered (this is addressed in product policies, see Scope).

Economic efficiency is also discussed in this document, where there are data and/or it is relevant (such as in individual techniques, and see Section 1.5.1). Thermodynamic efficiencies are discussed above, and as relevant in individual techniques.

Energy efficiency may be reduced by measures to improve the environmental impacts of products or by-products, etc. (see Section 1.5.2.5). This is outside of the scope of this document.

1.3.2 The efficient and inefficient use of energy

[227, TWG]

Energy efficiency (and conversely, inefficiency) in installations can be considered in two ways, which can be identified as¹²:

1. The output returned for the energy input. This can never be 100 % because of the laws of thermodynamics, see Section 1.2. Thermodynamic irreversibilities (see Section 1.2.2.6) are the basis of inefficiencies, and include transferring energy by conduction, convection or radiation (thermal irreversibilities). For example, heat transfer does not occur just in the desired direction, i.e. to the process, but also out through reactor or furnace walls, etc. However, the losses can be reduced by various techniques, many of which are discussed later in this document, e.g. the reduction of radiant heat losses from combustion processes.

2. The careful (or effective) use of energy, as and when it is required in the optimum quantities. Inefficiency (or ineffective use) results from the poor matching of energy supply and demand, including poor design, operation and maintenance; running equipment when not needed, such as lighting; running processes at a higher temperature than necessary; the lack of an appropriate storage of energy, etc.

1.3.3 Energy efficiency indicators

[5, Hardell and Fors, 2005]

Energy efficiency is defined in the EuP Directive¹³ [148, EC, 2005] as:

'a ratio between an output of performance, service, goods or energy, and an input of energy'.

This is the amount of energy consumed per unit of product/output, referred to as the 'specific energy consumption' (SEC), and is the definition most commonly used by industry. (Note: the definition below is widely used in the petrochemical and chemical industries, but is called the 'energy intensity factor' (EIF) or 'energy efficiency indicator' (EEI) see below, and Annex 7.9.1).

In its simplest form, the SEC can be defined as:

$$\text{SEC} = \frac{\text{energy used}}{\text{products produced}} = \frac{(\text{energy imported} - \text{energy exported})}{\text{products or outputs produced}} \quad \text{Equation 1.1}$$

¹² In English, only one term exists, i.e. energy efficiency, and the converse, inefficiency, which can cause confusion. Other languages have two separate terms, for efficiency/losses, such as in French: 'rendements/pertes énergétiques' and for careful/careless use: 'efficacités/inefficacités énergétiques'.

¹³ EuP Directive, known as the Energy-using Products Directive 2005/32/EC

SEC is a number with dimensions (GJ/tonne) and can be used for units producing products which are measured in mass units. For energy-generating industries (electrical power generation, waste incineration) it may be more sensible to define an energy efficiency factor defined as equal to energy produced (GJ)/energy imported (GJ). SECs can be expressed as other ratios, such as energy/m² (e.g. in coil coating, car production), energy/employee, etc.

The term 'energy intensity factor' (EIF) is also used (see also the note above, on its use in petrochemical industries). Note that economists usually understand the EIF to be the ratio of the energy used to a financial value, such as business turnover, value added, GDP, etc. e.g.:

$$\text{EIF} = \frac{\text{energy used}}{\text{turnover of installation}} = \text{GJ/EUR turnover} \quad \text{Equation 1.2}$$

However, as the cost of outputs usually rises over time, the EIF can decrease without any increase in physical energy efficiency (unless calculated back to a reference price). The term should therefore be avoided in assessing the physical energy efficiency of an installation.

EIF is also used at the macro level (e.g. European and national) and is expressed as, e.g. GJ per unit of GDP (gross domestic product), which can then be used to measure the energy efficiency of a nation's economy (see the note on economists use of the term, above).

The units used therefore need to be clarified, especially when comparing industries or sectors [158, Szabo, 2007].

It is important to note the difference between primary energies (such as fossil fuels) and secondary energies (or final energies) such as electricity and steam, see Section 1.3.6.1). Ideally, secondary energies should be converted to the primary energy content, and this term then becomes the specific consumption of primary energy. It can be expressed as, e.g. primary energy per tonne of product in MJ/tonne or GJ/tonne [91, CEFIC, 2005]. However, there are advantages and disadvantages to this, which are discussed further in Section 1.3.6.1.

Denominator in specific energy consumption and the energy efficiency index

In the simplest case, the production unit will produce one main product, which can then be used as the divisor in the SEC formula (Equation 1.1). In many cases the situation may be more complex, such as where there may be multiple products in refineries or large chemical plants, where the product mix varies with time, or where there is no obvious product, and the output is a service e.g. in waste management facilities. In cases such as those discussed in Section 1.4 below, other production criteria can be used, such as where:

1. There are a number of equally important products or a number of important co-products. Where appropriate, the sum of these products can be used as the divisor. Otherwise, meaningful process boundaries have to be decided between the energy balance and the products balance:

$$\text{SEC} = \frac{\text{energy used}}{\Sigma \text{ products produced}} = \frac{(\text{energy imported} - \text{energy exported})}{\Sigma \text{ products produced}}$$

2. There are several product streams and the number of raw materials (feedstock) streams are low, the denominator may be the raw material. This is recommended if the energy consumption is determined mainly by the amount of raw material and less by the products (which may happen when the product quality depends on the feedstock). However, using raw material as a denominator does not reflect the loss of (decrease in) energy efficiency when raw material and energy consumption remain the same but production quantities decrease

$$\text{SEC} = \frac{\text{energy used}}{\Sigma \text{ raw material input}} = \frac{(\text{energy imported} - \text{energy exported})}{\Sigma \text{ raw material input}}$$

3. There are several products (or one product with different specifications) manufactured in batches or campaigns. An example is a polymer plant producing different grades of polymer, each one manufactured in turn, and for differing periods, according to market needs. Each grade will have its own energy consumption, usually higher quality grades require more energy input. It may be useful to define a reference energy efficiency for each grade (based on the average energy consumption for that given grade). The relevant specific energy consumption over a specific period could then be defined as:

$$SEC = \frac{\sum_{i=A,B,C} X_i * SEC_{ref,i}}{\frac{\text{Energy used in production unit over period considered}}{\text{Sum of products of A, B and C manufactured during period}}}$$

Where:

X_i = the fraction of grade i on total product produced over the given period
 $SEC_{ref,i}$ = the reference energy efficiency factor for grade i (calculated, for instance, by averaging the energy efficiency indicator over a reference period when only grade i was produced).

4. There is no obvious product, and the output is service e.g. in waste management facilities. In this case, the production criterium related to the energy used is the waste input:

$$SEC = \frac{\text{(energy imported to support the incineration process - energy exported)}}{\text{(tonnes of waste processed)}}$$

Where the waste is predominantly combustible (such as municipal solid waste, MSW), this indicator will be negative as part of the lower heating value (LHV) of the waste incinerated is recovered as energy exported, which will typically be larger than energy imported (if any).

5. Other cases where the energy-to-end-product ratio (or main throughput) is too variable to be useful. Examples are printing installations, where the amount of printed paper input/output does not always relate to the energy use. This is because the amount of printing and drying varies with the amount of ink coverage and the processes used, see the STS BREF.

Defining improvement in energy efficiency

The EuP Directive [147, EC, 2006] defines energy efficiency improvement as an increase in energy end-use efficiency as a result of technological, behavioural and/or economic changes. The types of change that meet these criteria are discussed in Section 1.5 and generic techniques are described in Chapters 2 and 3.

The efficiency improvement can therefore be expressed as [5, Hardell and Fors]:

- obtaining an unchanged output value at a reduced energy consumption level, or
- obtaining an increased output value with unchanged energy consumption, or
- obtaining an output value that, in relative terms, surpasses the increase in energy consumption.

The main purpose of the energy efficiency indicators is to be able to monitor the progress of the energy efficiency of a given production unit and a given production rate over time and to see the impact of energy efficiency improvement measures and projects on the energy performance of the production process/unit. The SEC shows how much energy is used for a given output but one single value is of limited use without other reference data. The energy efficiency indicator (EEI) can be used to show the change in the given time period and is more useful in monitoring the energy efficiency of a system, process or installation. This is defined by dividing a reference SEC (SEC_{ref}) by the SEC of the unit or process being considered. SEC_{ref} may either be a reference number which is generally accepted by the industry sector to which the production process belongs, or it may be the SEC of the production process at a given reference year:

$$EEI = \frac{SEC_{ref}}{SEC} \quad \text{Equation 1.3}$$

The energy efficiency index is a dimensionless number.

Note:

- SEC is a number that decreases with increasing energy efficiency whereas EEI is a number that increases. Energy management therefore targets the lowest possible SEC and the highest possible EEI
- identifying the real energy efficiency in the indicator may require correction of the energy factors.

Timeframe

An appropriate timeframe should be selected (see Section 2.16 and the MON REF). If taken on an hourly basis, the energy efficiency indicator may show large fluctuations for a continuous process and would not be appropriate for a batch process. These fluctuations are smoothed out on longer period bases, such as years or months. However, it should be noted that the variations in a smaller timeframe should be accounted for, as they may identify opportunities for energy savings.

In addition to the two main indicators dealt with here, there are also other indicators and sub-indicators, see Sections 2.10. and 2.16.

1.3.4 Introduction to the use of indicators

In industry, the specific energy consumption (SEC) for a given output (or input) is the most widely used indicator, and will be used widely in this document. The definition looks deceptively simple. However, experience in trying to quantify the concept for monitoring processes shows that a framework is required to better define and measure energy efficiency. There are several complicating factors, such as:

- energy is not always counted in the same way or using the same parameters by different operators or staff
- it is often necessary to look at the energy efficiency of a production process within the energy efficiency of a production site involving several production processes
- the definition does not provide information on whether energy is used or produced efficiently.

To be informative and useful, energy efficiency must be comparable, e.g. to another unit or installation, or over time and for comparison there must be rules or conventions. In the case of comparing energy efficiency, it is especially important to define system boundaries to ensure all users are considered equally.

At its simplest, the definition neither takes a view on how efficiently energy is produced nor how 'waste' energy is used outside the system boundary. These and other issues should be transparent so that it is possible to evaluate improvements in energy efficiency. These issues are discussed in Sections 1.4 and 1.5.

For IPPC, energy efficiency is considered either from the perspective of:

- an installation level, when permitting an installation, where the energy of the following may be considered:
 - the whole installation
 - individual production processes/units and/or systems
- a European level, for an industrial sector or activity when setting ENE values associated with BAT (benchmarks), e.g. in a sectorial BREF.

The specific energy consumption and energy efficiency index (see Section 1.3.3) are examples of energy efficiency indicators. The suitability of different energy efficiency methods and indicators needs to be considered on a sector and process basis, and may need to be considered on a site-by-site basis (see discussion in Benchmarking, Section 2.16). All industrial installations have their individual characteristics. There are differences between raw materials, process technologies, quality of products, mix of products, monitoring methods, etc. The age of the unit can also have a great effect on energy efficiency: new installations usually have better energy efficiency than the old ones [156, Beerkens, 2004, 157, Beerkens R.G.C., 2006]. Taking into account the range of variables affecting the energy efficiency, comparison between different installations by energy efficiency indicators can lead to wrong conclusions, especially when it is difficult (or even impossible) in practice to take into account all the variables in an appropriate manner [127, TWG].

To evaluate energy efficiency it may be helpful to [4, Cefic, 2005]:

- assess the site to establish if a specific energy indicator (SEI) can be established for the whole site
- split the site in production/utility units, if a site SEI cannot be established, or it is helpful in the energy efficiency analysis
- define indicators for each production process and for the site or part of it
- quantify specific energy indicators, record how these are defined, and maintain these, noting any changes over time (such as in products, equipment).

1.3.5 The importance of systems and system boundaries

The best energy efficiency for a site is not always equal to the sum of the optimum energy efficiency of the component parts, where they are all optimised separately. Indeed, if every process would be optimised independent of the other processes on the site, there is a risk that e.g. excess steam will be produced on the site, which will have to be vented. By looking at the integration of units, steam can be balanced and opportunities for using heat sources from one process for heating in another process can result in lower overall site energy consumptions. Synergies can therefore be gained from considering (in the following order):

1. The whole site, and how the various units and/or systems interrelate (e.g. compressors and heating). This may include considering de-optimising the energy efficiency of one or more production processes/units to achieve the optimum energy efficiency of the whole site. The efficient use of processes, units, utilities or associated activities, or even if they are appropriate in their current forms needs to be assessed.
2. Subsequently, optimising the various units and/or systems (e.g. CAS, cooling system, steam system).
3. Finally, optimising the remaining constituent parts (e.g. electric motors, pumps, valves).

To understand the importance of considering the role of systems in energy efficiency, it is crucial to understand how the definition of a system and its boundary will influence the achievement of energy efficiency. This is discussed in Section 1.5.1 and Section 2.2.2.

Furthermore, by extending boundaries outside a company's activities and by integrating industrial energy production and consumption with the needs of the community outside the site, the total energy efficiency could be increased further, e.g. by providing low value energy for heating purposes in the neighbourhood, e.g. in cogeneration, see Section 3.4

1.3.6 Other important related terms

Other terms used may be found in the Glossary, Annex 7.1 or in standard texts.

1.3.6.1 Primary energy, secondary energy and final energy

Primary energy is the energy contained in raw fuels (i.e. natural resources prior to any processing), including combustible wastes and any other forms of energy received by a system as input to the system. The concept is used especially in energy statistics in the course of the compilation of energy balances.

Primary energies are transformed in energy conversion processes to more convenient forms of energy, such as electrical energy, steam and cleaner fuels. In energy statistics, these subsequent forms of energy are called secondary energy. Final energy is the energy as it is received by the users, and may be both the primary and secondary energies (e.g. natural gas as the primary energy and electricity as the secondary energy used in an installation). The relationship is explained in Figure 1.6.

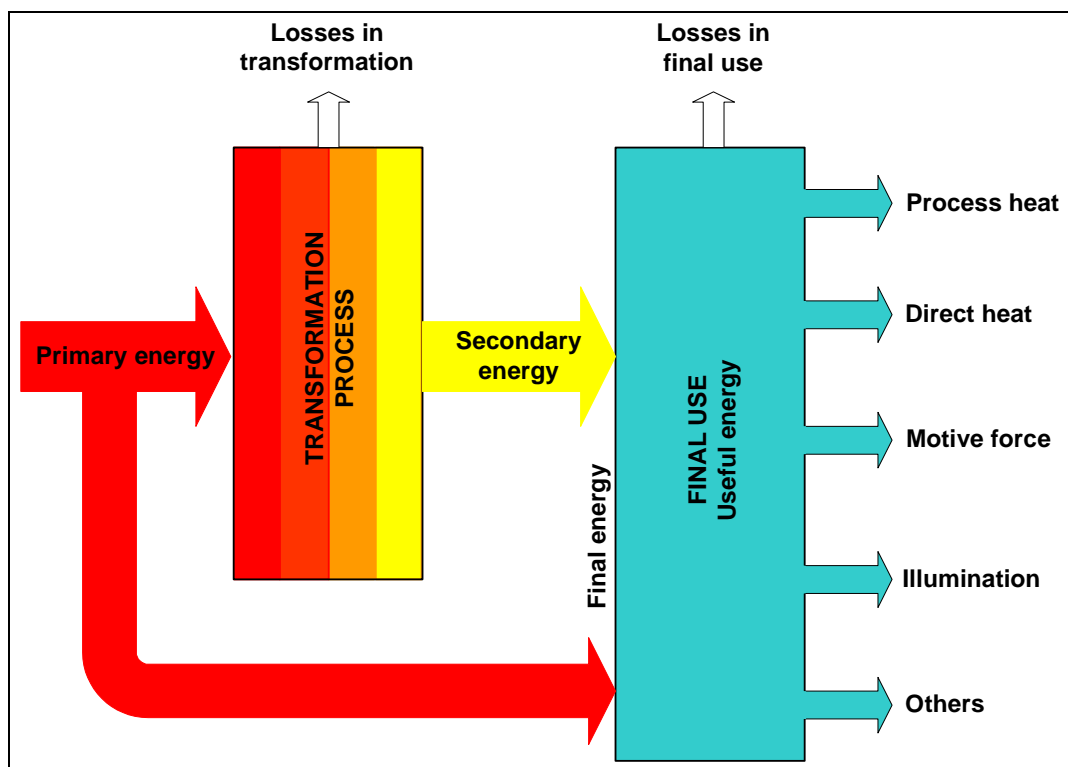

Figure 1.6: Definition of primary, secondary and final energies
[260, TWG, 2008]

The use of primary and secondary energies is illustrated in Section 1.4.2.1. When comparing different energy vectors (e.g. steam and/or heat generated in the installation from raw fuels compared with electricity produced externally and supplied via a national grid), it is important to take account of the inefficiencies in the external energy vector(s). If not, as in the example in Section 1.4.2.1, the external vector can appear significantly more efficient.

Examples of energy vectors that may be supplied from outside the unit or installation are:

- **electricity:** the efficiency varies according to fuel and technology, see [125, EIPPCB]. For conventional steam plants, the efficiency of producing electricity from the primary fuel varies between 36 and 46 %. For combined cycle technology, the efficiency is between 55 and 58 %. With cogeneration (combined heat and power, CHP, see Section 3.4) a total efficiency for electricity and heat can reach 85 % or more. The efficiency for nuclear electricity and renewables is calculated on a different basis
- **steam:** the energetic value of steam may be defined as $\frac{h_s - h_w}{\eta_b}$

where: h_s = enthalpy of steam

h_w = enthalpy of boiler feed-water (after deaeration)

η_b = thermal efficiency of the boiler.

However, this assessment is too restricted. In principle, the following energy inputs should also be included when defining the energy value of steam:

- Steam system, e.g.:
 - heat added to boiler feed-water to bring it to the temperature of the deaerator
 - steam sparged in the deaerator to remove oxygen from the boiler feed-water
- Auxiliaries, e.g.:
 - energy required to pump boiler feed-water to the operating pressure of the boiler
 - energy consumed by the air fan providing forced draft to the boiler.

There are other factors to be taken into account such as commodities, etc. The way to define how the primary energy of steam is defined should be clearly described in the calculation procedure of energy efficiency indicators and in energy benchmarks. It is important that everyone uses the same basis for calculating the primary energy of steam, see Section 3.2.1, where standards are given for calculating boiler efficiencies [249, TWG, 2007, 260, TWG, 2008].

There are other utilities to be considered in a similar way, such as:

- compressed air: see Section 3.7
- hot water
- cooling water: see Section 3.4.3.

Other inputs may not be considered as ‘utilities’ in the conventional sense. However, they may be produced on- or off-site, and/or the use they are put to and the consequent effect on energy usage may be considerable. For example:

- nitrogen: see Section 3.7 on compressed air and the generation of low quality N₂
- oxygen: when used in combustion, it may be claimed to increase the combustion efficiency. However, if the energy used in producing the oxygen is considered, oxy-firing may use the same or more energy than is saved in the combustion process, depending on the furnace, although it has the significant benefit of reducing NO_x, see Section 3.1.6 [156, Beerkens, 2004, 157, Beerkens R.G.C., 2006].

However, calculating energies as primary energy requires time (although this can be readily automated on a spreadsheet for repeat calculations in a defined situation) and is not free of interpretation problems. For example, a new installation equipped with the most energy efficient technologies may be operating in a country whose electricity generation and distribution systems are out-of-date. If the low efficiency of the domestic electric production and distribution systems are taken into account, the energy efficiency indicator of the installation compared to similar installations in other countries may be poor [127, TWG]. Also, different sources of electricity have different efficiencies of generation, and the mix of generation sources vary according to the country. This problem can be overcome by using standard values, such as the European energy mix, see Annex 7.16. However, other indicators such as carbon balance may be used, to take account of the production of the secondary energy vector and the cross-media effects, depending on local circumstances.

From July 1 2004, Directive 2003/54/EC¹⁴ established fuel mix disclosure by the electricity providers. The exact presentation of the data provided are at the discretion of the EU Member States: http://europa.eu/eur-lex/pri/en/oj/dat/2003/l_176/l_17620030715en00370055.pdf

The European Commission's note on implementation can be found at: http://ec.europa.eu/energy/electricity/legislation/doc/notes_for_implementation_2004/labelling_en.pdf

The Directive on the promotion of cogeneration [146, EC, 2004] and the guidelines related to it, explain reference values of electricity and steam production, including correction factors depending on the geographical location. The Directive also explains the methodology for determining the efficiency of the cogeneration process.

There are various other sources of data, such as national fuel mixes: <http://www.berr.gov.uk/energy/policy-strategy/consumer-policy/fuel-mix/page21629.html>

An alternative to returning all energies to primary energy is to calculate the SEC as the key energy vectors, e.g. Section 6.2.2.4, page 338, of the pulp and paper BREF [125, EIPPCB], the total demand for energy (consumption) in the form of heat (steam) and electricity for a non-integrated fine paper mill was reported [276, Agency, 1997] to consume:

- process heat: 8 GJ/t (\approx 2222 kWh/t)
- electricity: 674 kWh/t.

This means that about 3 MWh electricity and steam/tonne product is consumed. When considering the primary energy demand for converting fossil fuels into power a total amount of 4 MWh/t of paper is needed. This assumed a primary energy yield of the electricity generator of 36.75%. In this case, an electricity consumption of 674 kWh/t corresponds to 1852 kWh/t primary energy (e.g. coal).

¹⁴ Directive 2003/54/EC, 26 June 2003, concerning the common rules for the internal market in electricity, repeals Directive 96/92/EC

In general, primary energy can be used:

- for comparison with other units, systems, sites within sectors, etc.
- when auditing to optimise energy efficiency and comparing different energy vectors to specific units or installations (see Sections 1.4.1 and 1.4.2).

Primary energy calculated on a local (or national) basis can be used for site-specific comparisons, e.g.:

- when seeking to understand local (or national) effects, such as comparing installations in different locations within a sector or a company
- when auditing to optimise energy efficiency and comparing different energy vectors to specific units or installations (see Sections 1.4.1 and 1.4.2). For example, when considering changing from a steam turbine to an electric motor, it would be optimal to use the actual electricity efficiency production factor of the country.

Primary energy calculated on a regional basis (e.g. the EU energy mix) for:

- monitoring activities, units, or installations on a regional basis, e.g. industry sector.

Secondary or final energy can be used:

- for monitoring an ongoing defined situation
- calculated on an energy vector basis, for monitoring site and industry sector efficiencies.

In Section 1.4.1, the final (or secondary) energy can be used to compare installations in different countries, and this is the basis for specific energy requirements given in some vertical BREFs (e.g. see the PP BREF). Conversely, primary energy could be used to express the overall efficiencies at national level (e.g. to assess the different efficiencies of industry sectors in different countries).

Note that the Commission (in DG-JRC IPTS Energy) and the Intergovernmental Panel on Climate Change (IPCC) quote both primary and secondary values in their reports for clarity [158, Szabo, 2007].

1.3.6.2 Fuel heating values and efficiency

In Europe, the usable energy content of fuel is typically calculated using the lower heating value (LHV), lower calorific value (LCV) or net calorific value (NCV) of that fuel, i.e. the heat obtained by fuel combustion (oxidation), measured so that the water vapour produced remains gaseous, and is not condensed to liquid water. This is due to the real conditions of a boiler, where water vapour does not cool below its dew point, and the latent heat is not available for making steam.

In the US and elsewhere, the higher heating value (HHV), higher calorific value (HCV) or gross calorific value (GCV) is used, which includes the latent heat for condensing the water vapour, and thus, when using HCVs, the thermodynamic maximum of 100 % cannot be exceeded. The HCV_{dry} is the HCV for a fuel containing no water or water vapour, and the HCV_{wet} is where the fuel contains water moisture.

However, using the LCV (NCV) instead of the HCV as the reference value, a condensing boiler can appear to achieve a 'heating efficiency' of greater than 100 %, which would break the first law of thermodynamics.

It is important to take this into account when comparing data using heating values from the US and Europe. However, where these values are used in ratios such as EEI, the difference may be in both nominator and denominator and will be cancelled out. Some indicative HCVs and LCVs are given in Table 1.1, and the ratio of LCV_{wet} to HCV_{wet} can be seen to vary from 0.968 to 0.767. Note that HCVs/LCVs vary according to source, time, etc.

Fuel	Moisture content (% wet basis)	Hydrogen content (kgH/kg _{fuel})	HCV _{dry} (MJ/kg)	HCV _{wet} (MJ/kg)	LCV _{dry} (MJ/kg)	LCV _{wet} (MJ/kg)	Ratio of LCV _{wet} /HCV _{wet} (dimensionless)
Bituminous coal	2	4.7	29.6	29.028	7.2	8.1	0.968
Natural gas 1 (Ureghoi, Russia)	0		54.65	4.6	49.249	.2	0.901
Natural gas 2 (Kansas, US)	0		47.35	4.6	42.742	.7	0.903
Heavy fuel oil	0.3	10.1	43.143	.04	0.9	40.8	0.949
Light fuel oil	0.01	13.7	46.046	.04	3.0	43.0	0.935
Pine bark non-dried	60.5	9	21.3	8.5	20	6.5	0.767
Pine bark dried	30	5.9	21.3	14.92	0.13	.3	0.890
Natural gas 1: CH ₄ (97.1 vol-%), C ₂ H ₆ (0.8%), C ₃ H ₈ (0.2%), C ₄ H ₁₀ (0.1%), N ₂ (0.9%), CO ₂ (0.1%)							
Natural gas 2: CH ₄ (84.1 vol-%), C ₂ H ₆ (6.7%), C ₃ H ₈ (0.3%), C ₄ H ₁₀ (0.0%), N ₂ (8.3%), CO ₂ (0.7%)							

Table 1.1: Indicative low and high heating values for various fuels
[153, Wikipedia]

1.3.6.3 Supply side and demand side management

Supply side refers to the supply of energy, its transmission and distribution. The strategy and management of the supply of energy outside of the installation is outside of the scope of the IPPC Directive (although the activity of electricity generation is covered as defined in the Directive Annex 1(1.1)). Note that in an installation where electricity or heat is generated in a utility or a associated process, the supply of this energy to another unit or process within the installation may be also referred to as 'supply side'.

Demand side management means managing the energy demand of a site, and a large amount of the literature relating to energy efficiency techniques refers to this issue. However, it is important to note that this has two components: the cost of the energy per unit and the amount of energy units used. It is important to identify the difference between improving the energy efficiency in economic terms and in physical energy terms (this is explained in more detail in Annex 7.11).

1.4 Energy efficiency indicators in industry

1.4.1 Introduction: defining indicators and other parameters

The main aim of the indicators is to assist self-analysis and monitoring, and to assist in comparing the energy efficiency of units, activities or installations. While Equation 1.1 and Equation 1.5 appear simple, there are related issues which must be defined and decided before using the indicators, especially when comparing one production process with another. Issues to define are, for example, process boundaries, system boundaries, energy vectors and how to compare different fuels and fuel sources (and whether they are internal or external sources). Once these factors have been defined for a specific plant or for an inter-site benchmark, they must be adhered to.

This section discusses how to define energy efficiency and indicators for individual industrial production processes/units/sites. It explains what the relevant issues are and how to consider them in order to measure and evaluate the changes in energy efficiency.

There are problems ensuring that the data from separate units or sites are truly comparable, and if so, whether conclusions may be drawn about the economics of a site, that affect confidentiality and competition. These issues and the use of these indicators is discussed in Section 2.16, Benchmarking.

Section 1.3.3 points out that indicators can be based on the most appropriate ratios, according to the process e.g. GJ/tonne, GJ/units produced, energy produced/energy imported (for energy-generating industries), energy/m² (e.g. in coil coating, car production), energy/employees, etc.

1.4.2 Energy efficiency in production units

The following two examples illustrate the concepts of SEC and EEI, and highlight key interpretation issues.

1.4.2.1 Example 1. Simple case

Figure 1.7 shows an example of a simple production unit¹⁵. For simplicity, the process is shown without energy exports and with only one feedstock and one product. The production process makes use of steam, electricity and fuel.

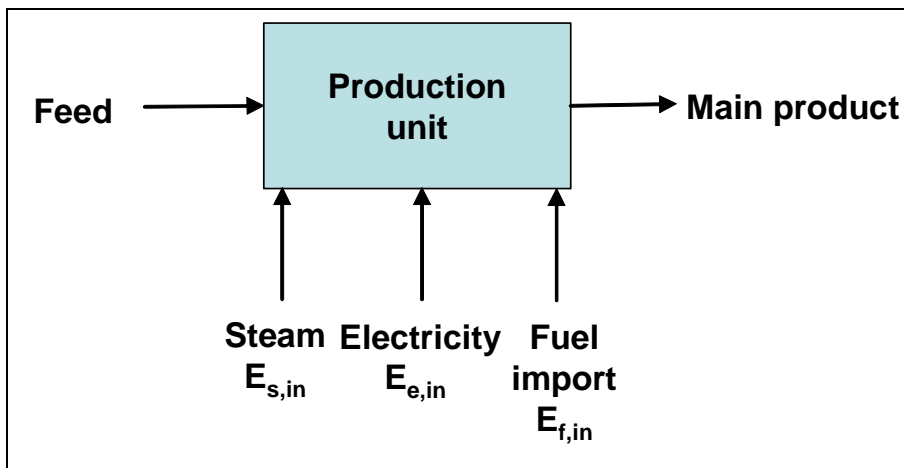

Figure 1.7: Energy vectors in a simple production unit

The SEC of this process is given by:

$$SEC = \frac{E_{s,in} + E_{e,in} + E_{f,in}}{P} \quad \text{Equation 1.4}$$

Where:

$E_{s,in}$ = energy supplied to the process via steam to produce an amount of product P

$E_{e,in}$ = energy supplied to the process via electricity to produce an amount of product P

$E_{f,in}$ = energy supplied to the process via fuel to produce an amount of product P

P = amount of product P

In Equation 1.5, it is essential that the various energy vectors (energy flows) are expressed as **primary energy** and on the same basis (see Section 1.3.6.1). For instance, 1 MWh of electricity requires more energy to be produced than 1 MWh of steam, as electricity is typically generated with an efficiency of 35 - 58 % and steam with an efficiency of 85 - 95 %. The energy use of the different energy vectors in Equation 1.5 therefore needs to be expressed in primary energy. This includes the efficiency to produce that energy vector.

An example of a calculation of energy efficiency: assume that to produce 1 tonne of product P1, the following energy vectors have to be used:

- 0.01 tonne of fuel
- 10 kWh of electricity
- 0.1 tonne of steam.

Assuming the following¹⁵:

- lower calorific value of fuel = 50 GJ/tonne
- efficiency of electricity production = 40 %
- steam is generated from water at 25 °C and the difference between the enthalpy of steam and the enthalpy of water at 25 °C = 2.8 GJ/tonne
- steam is generated with an efficiency of 85 %.

To produce 1 tonne of product P1, the energy consumption is (converting to GJ):

- $E_{f,in} = 0.01 \text{ tonne fuel} \times 50 \text{ GJ/tonne} = 0.50 \text{ GJ}$
- $E_{e,in} = 10 \text{ kWh} \times 0.0036 \text{ GJ/kWh} \times 100/40 = 0.09 \text{ GJ}$ (where 1 kWh = 0.0036 GJ)
- $E_{s,in} = 0.1 \text{ tonne steam} \times 2.8 \text{ GJ/tonne} \times 1/0.85 = 0.33 \text{ GJ}$.

The SEC of this process is then given by:

- $SEC = (0.50 + 0.09 + 0.33) \text{ GJ/tonne} = 0.92 \text{ GJ/tonne}$.

To determine the EEI, assume that this is the reference SEC. Now assume that the plant carries out a number of energy efficiency improvement projects, so that a year later the energy consumption of the production process has become:

- 0.01 tonne of fuel
- 15 kWh of electricity
- 0.05 tonne of steam.

As a result of these energy efficiency improvement projects, the new SEC of the process is:

- $SEC = (0.5 + 0.135 + 0.165) \text{ GJ/tonne} = 0.8$.

The EEI of this process is then:

- $EEI = 0.92/0.8 = 1.15$.

This indicates that the energy efficiency of the production process has increased by 15 %.

¹⁵ The figures are illustrative only, and not intended to be exact. No pressure is given for steam, but it can be assumed to be the same in both parts of the example. An exergy analysis would be more useful, but is beyond this simple example.

It is important to note that the inefficiencies of the production of electricity in this case have been internalised (by using the primary energy: these inefficiencies are actually external to the site). If this is not taken account, the electrical energy input would appear to be 50 % more efficient than it is:

$$\frac{(0.09 - 0.036)}{0.036} = 1.5; \text{ i.e. } 150\%$$

Ignoring the primary energy may lead to, for example, decisions to switch other energy inputs to electricity. However, it would need more complex analysis beyond the scope of this example to determine the amount of useful energy available in the application of sources, such as an exergy analysis.

This example shows it is therefore important to know on what basis the SEC and the EEI are calculated.

It is also important to note the same logic applies to other utilities that may be brought into the unit/process/installation from outside the boundary (rather than produced within the boundary), such as steam, compressed air, N₂, etc (see primary energy, Section 1.3.6.1).

1.4.2.2 Example 2. Typical case

Figure 1.8 deals with a more complicated case, where there is both export of energy and internal recycling of fuel or energy. This case illustrates principles that are applicable to many industries, with appropriate adjustments.

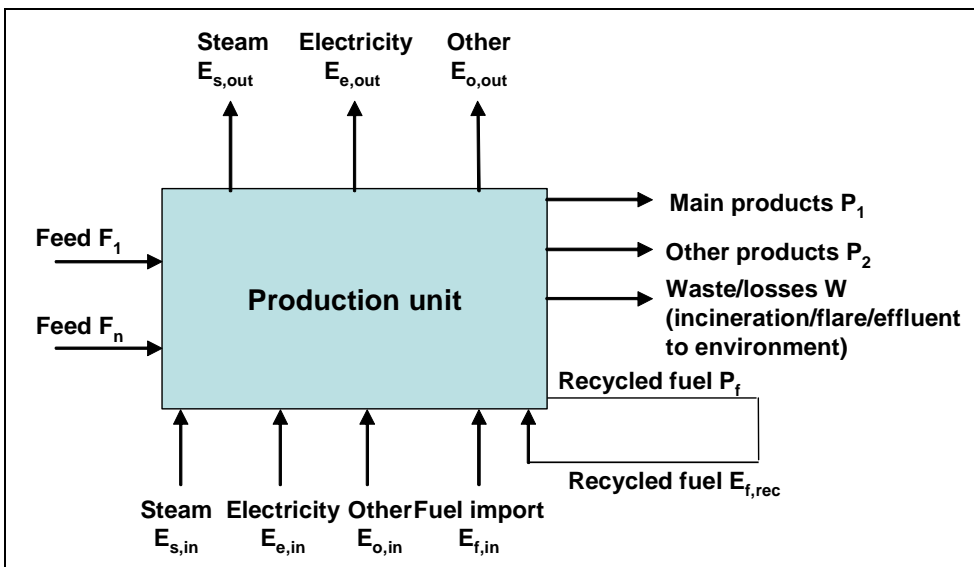

Figure 1.8: Energy vectors in a production unit

$$SEC = \frac{(E_{s,in} + E_{e,in} + (E_{f,in} + E_{f,rec}) + E_{o,in}) - (E_{s,out} + E_{e,out} + E_{o,out})}{P_1} \quad \text{Equation 1.5}$$

This generic formula can be applied to each production process/unit/installation, but its various components have to be adapted to each specific production process/unit/site. The unit of this indicator is (unit of energy)/(unit of mass) usually GJ/t product or MWh/t product. However, there may be multiple products, or one main product and significant by-products.

Some considerations to be taken into account when applying Equation 1.5 are described in the six following points (some are also applicable to Equation 1.5):

1. Feed/product flows (F_{1-n} , P_1)

In Figure 1.8, the mass-flow of the raw materials and products is shown in the horizontal direction. The feeds F_1 to F_n (F_{1-n}) are the different raw materials used to produce the main products P_1 and the by-products. These by-products are split into two fractions: a fraction which is recycled as fuel (P_f) and the remaining by-products (P_2).

Examples of this situation are:

- the ethylene steam crackers in the petrochemical industry, where energy consumption can be expressed in GJ per tonne ethylene, in GJ per tonne olefins (ethylene + propylene) or in GJ per tonne of high value chemicals (olefins + butadiene + benzene + pure hydrogen)
- in the chlor-alkali sector where energy consumptions are usually related to the tonnes of Cl_2 produced (the main product), and where H_2 and NaOH are by-products.

2. Energy vectors (energy flows) (E_{in})

The energy vectors show the different types of energy flows into and out of the unit. The energy imported and the energy which is exported for use elsewhere are shown in the vertical plane in Figure 2.2. The following energy vectors are considered:

- E_s = steam and/or hot water
- E_e = electricity to the process
- E_f = fuel (gas, liquid, solid). A split is made between the externally purchased fuel E_f and the fuel which is internally recycled in the process $E_{f,rec}$. Note, if a fuel is produced as a product for use outside the site, it will be considered as P_1 or P_2 (not as $E_{f,out}$), see point 5, below
- E_o = other: this covers any utility which requires energy to be produced. Examples are hot oil, cooling water, compressed air and N_2 (when processed on-site). This cooling water requires energy to produce it (energy is required to operate the pumps circulating cooling water and the fans on the cooling towers).

It is important that, on the output side, only those energy vectors which are beneficially used in a process or unit in another process are counted. In particular, the energy associated with the cooling of the process by cooling water or air should never be included as the 'energy out' in Equation 1.5. The energy used in supplying different utilities and other associated systems must also be considered: for example, for cooling water (operation of pumps and fans), compressed air, N_2 production, steam tracing, steam to turbines. Other heat losses to the air should also never be counted as useful energy outputs. The appropriate sections in Chapter 3 on these ancillary systems give more data on their efficiencies and losses.

3. Different steam levels (E_s) (and hot water levels)

A production plant could be using more than one type of steam (different pressures and/or temperatures). Each level of steam or water may have to produce its own efficiency factor. Each of these steam levels needs to be included in the term E_s by summing up their exergies [127, TWG]. See steam, in Section 3.2.

Hot water, if used (or produced and used by another production plant), should be treated similarly.

4. Waste material flows (W) and energy losses

Each process will also generate an amount of waste products and energy losses. These waste products can be solids, liquids or gaseous and may be:

- disposed of to landfill (solids only)
- incinerated with or without energy recovery
- used as fuel (P_f)
- recycled.

The relevance of this waste stream will be discussed in more detail in Section 1.5.2.3.

Examples of energy losses found in combustion plants are:

- chimney flue gas
- radiation heat losses through the installation walls
- heat in slag and fly ash
- heat and unoxidised carbon in unburnt materials

5. Fuel or product or waste (E_0 , P_f)

In Figure 1.8, fuel is not shown as an exported energy vector. The reason for this is that fuel (P_1 or P_2 , or it could be considered as E_f) is considered as a product rather than an energy carrier and that the fuel value, which would be attributed to the fuel, is already accounted for in the feed going to the production unit. This convention is standard within refineries and the chemical industry.

Other industries may apply different practices. For instance, in the chlor-alkali industry, some operators count the H_2 (a by-product of the Cl_2 and NaOH produced) as an energy vector, independent of whether this H_2 is subsequently used as a chemical or as a fuel (the H_2 flared is not counted).

It is therefore important to establish the rules for defining energy efficiency specific to a given industrial sector such as feeds, products, energy carriers imported and energy carriers exported. See also waste and flare recovery, Section 1.5.2.3.

6. Measured or estimated

Equation 1.5 assumes that the different energy vectors to the production process are known. However, for a typical production process, some parameters, e.g. the different utility consumptions (e.g. cooling water, nitrogen, steam tracing, steam to a turbine, electricity) are not always measured. Often, only the major individual utility consumptions of the production process are measured in order to control the process (e.g. steam to a reboiler, fuel to a furnace). The total energy consumption is then the sum of many individual contributors, of which some are measured and some are 'estimated'. Rules for estimation must be defined and documented in a transparent way. See Sections 1.5 and 2.10

1.4.3 Energy efficiency of a site

Complex production sites operate more than one production process/units. To define the energy efficiency of a whole site it has to be divided into smaller units, which contain process units and utility units. The energy vectors around a production site can be schematically represented as in Figure 1.9.

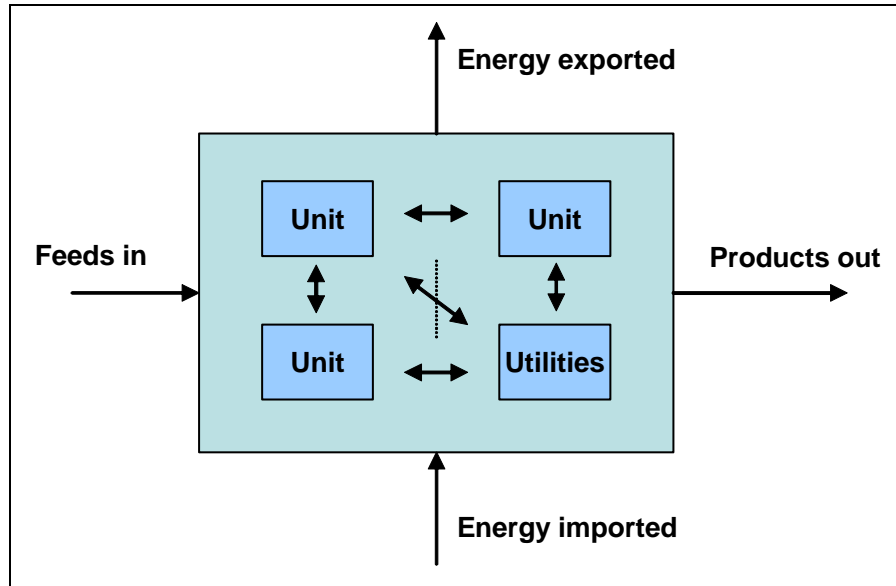

Figure 1.9: Inputs and outputs of a site

A production site may make different types of products, each having its own energy intensity factor. It is therefore not always easy to define a meaningful energy efficiency indicator for a site. The indicator may be expressed as:

$$EEI = \frac{\sum_{i-\text{units}} P_{i,j} * SEC_{refj}}{\text{Energy used by the site over period concerned}}$$

Where: $P_{i,j}$ = the sum of the products from the units
 SEC_{refj} = the reference SEC for the products, j

This is the same formula as mentioned in Section 1.3.3, point (3). The only difference is that in Section 1.3.2, the formula concerned different products made on one product line, whereas in here (in Section 1.4.3), it concerns different products made on different product lines.

Utilities

When dividing the production sites into production units (see Section 2.2.2), the utility centre should be considered in an accountable manner. When the utility centre produces utilities for more than one production unit it is usually considered as a separate (standalone) production unit. Equally, the utility may be supplied by another operator, e.g. see ESCOs, Section 7.12.

The utility section in itself may be divided into several sections: for instance, a part related to the storage and loading/unloading area, a part related to hot utilities (e.g. steam, hot water) and a part related to cold utilities (cooling water, N_2 , compressed air). Section 1.5 discusses the calculation of energy vectors from utilities, in the discussion of primary and secondary energy.

The following equation should always be tested:

$$\text{Energy use by the site} = \sum_{i=\text{units}} SEC_i * P_i + \text{energy used by the utility section}$$

Where:

$$\sum_{i=\text{units}} SEC_i = \text{the sum of the SECs for } i \text{ units}$$

Different aggregation of units in different sites

An example is the case of petrol hydrotreaters in a steam cracker. Petrol is a co-product of a steam cracker (hence is counted in P_2 rather than P_1 in Figure 1.8). Before it can be added to the petrol products, it needs, however, to be hydrotreated to saturate the olefins and diolefins present and to remove the sulphur components. Most operators would treat the petrol hydrotreater as a separate unit of the steam cracker. However, in some sites the petrol hydrotreater is integrated to the cracker so that, for simplicity purposes, it is sometimes included within the cracker system boundary. Not surprisingly, those crackers, which include the petrol hydrotreater in their system boundary, will tend to have higher energy consumptions than those which do not. This, of course, does not imply that their energy efficiency is lower.

It can therefore be seen that for the implementation of energy management within the site, it is essential to:

- divide the site into its production units, including the exact system boundary of these production units (see also Section 1.5, below). The break-up of a site into production units will depend on the complexity of the production site and should be decided in each case by the operator responsible
- clearly define the energy flows in and out of the site and between the different production units (unit boxes in Figure 1.9)
- maintain these defined boundaries unless changes are required or are driven, e.g. by changes to production and/or utilities; or, by moving to a different basis agreed at installation, company or sector level.

This then clearly defines the way in which the energy efficiency of a given production process is calculated.

1.5 Issues to be considered when defining energy efficiency indicators

Section 1.3 discusses how to define energy efficiency and highlights important related issues, such as primary and secondary energy. This section also introduced the concept of energy efficiency for utilities and/or systems. Sections 1.4.2 and 1.4.3 discuss how to develop energy efficiency indicators for a production unit and for a site from a top-down perspective, and both discuss the problems encountered.

In the current section:

- Section 1.5.1 discusses the importance of setting the right system boundaries when optimising energy efficiency. It considers the relative impacts of the energy efficiency of the component parts and systems by taking a bottom-up approach
- Section 1.5.2 discusses further important issues that can be considered by the operator and which should be taken into account in the definition of energy efficiency and indicators.

1.5.1 Defining the system boundary

[5, Hardell and Fors, 2005]

The following examples consider single components, sub-systems and systems, and examine how the improvement in energy efficiency can be assessed. The examples are based on a typical company energy efficiency assessment. The examples show the effect of considering a system for a required utility at too low a level (at the component/constituent part or at the sub-system).

The physical energy efficiency¹⁶ is given in Section 1.2.2.1 and Annex 7.1.1:

$$\text{Energy efficiency } \eta = \frac{\text{energy output}}{\text{energy input}} \text{ (usually expressed as \%)}$$

Where:

work (W) = the amount of useful work done by the component, system or process (in joules)

energy (E) = the quantity of energy (in joules) used by the component, system, process or equipment

$$\text{Improvement (change) in energy efficiency} = \frac{\text{change in energy used}}{\text{original energy usage}}$$

Example: System 1. Electric motor

Old electric motor

A company carried out a survey of existing motor drives. An old motor was found with an electrical power input of 100 kW. The efficiency of the motor was 90 % and, accordingly, the mechanical output power was 90 kW (see Figure 1.10).

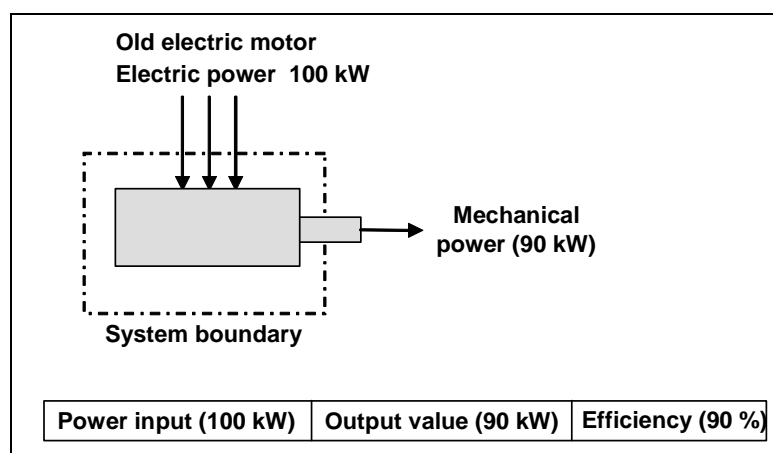

Figure 1.10: System boundary – old electric motor

¹⁶ In English, energy efficiency here means the energy efficiency of a piece of equipment or process (not its careless use). In French, this is 'rendements énergétiques'

New electric motor

To improve the efficiency, the motor was replaced by a high efficiency motor. The effects of this change are shown in Figure 1.11. The electric power needed to produce the same output power, 90 kW, is now 96 kW due to the higher efficiency of the new motor. The energy efficiency improvement is thus 4 kW, or:

$$\text{energy improvement} = 4/100 = 4 \%$$

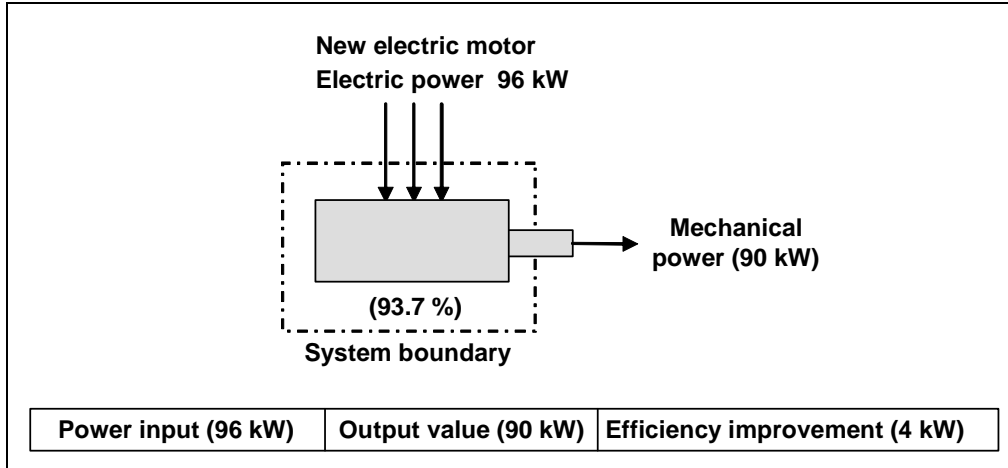

Figure 1.11: System boundary – new electric motor

Example: System 2: Electric motor and pump

As shown in Figure 1.12 an electric motor is used to operate a pump that provides cooling water for a cooling system. The combination of motor and pump is regarded here as one sub-system.

New electric motor and old pump

The output value of this sub-system is the hydraulic power in the form of cooling water flow and pressure. Due to the low efficiency of the pump, the output value is limited to 45 kW.

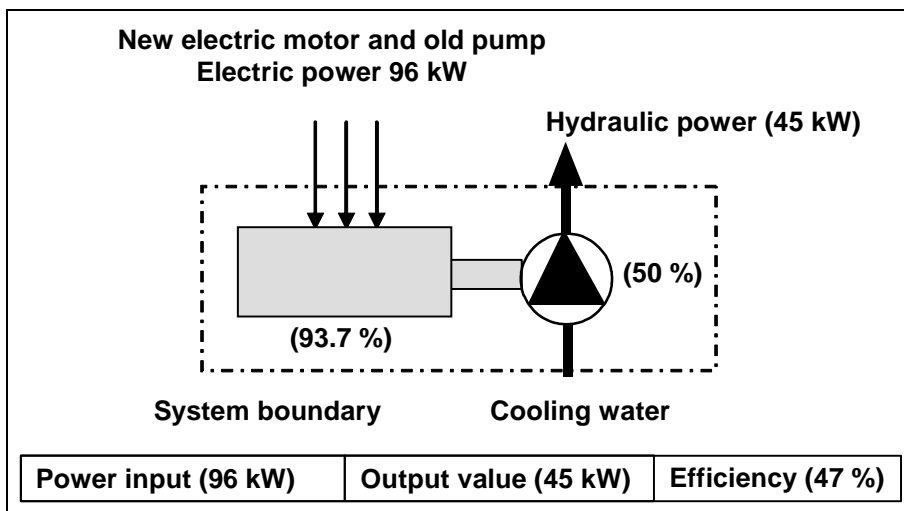

Figure 1.12: System boundary – new electric motor and old pump

New electric motor and new pump

The old pump is replaced by a new one, thereby increasing the pump efficiency from 50 to 80%. The result of the replacement is shown in Figure 1.13.

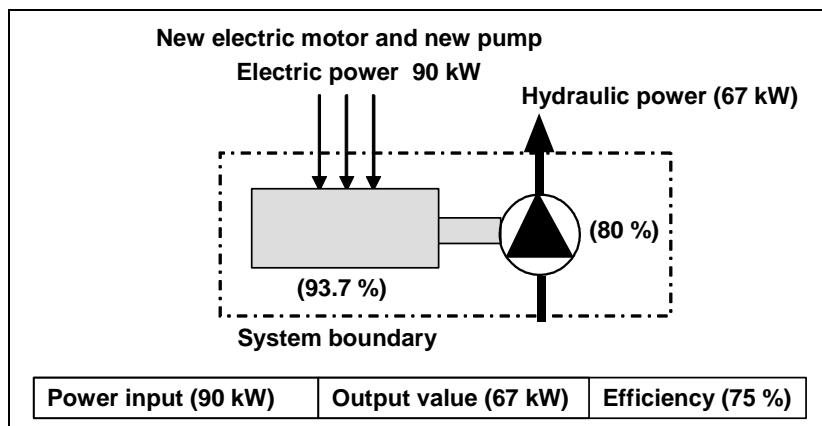

Figure 1.13: System boundary – new electric motor and new pump

The efficiency of the new sub-system is much higher than the previous one. The hydraulic power has increased from 45 to 67 kW. The increase in energy efficiency can be shown as (see Section 1.3.1):

$$\text{EEF} = \frac{\text{efficiency}}{\text{reference efficiency}} = \frac{75}{47} = 1.60 \text{ (i.e. 60 \% improvement in energy efficiency)}$$

Example: System 3. New electric motor and new pump with constant output value

As was indicated in Figure 1.12, the cooling system worked satisfactorily even at a hydraulic power of 45 kW. The benefit of an increase of the hydraulic power by 50% to 67 kW is not clear, and the pumping losses may now have been transferred to a control valve and the piping system. This was not the intended aim of replacing the components by more energy efficient alternatives.

A comprehensive study of the cooling system may have shown that a hydraulic power of 45 kW was sufficient, and in this case, the shaft power can be estimated at $45/0.8 = 56$ kW. The electric power needed to drive the motor would then be about $56/0.937 = 60$ kW.

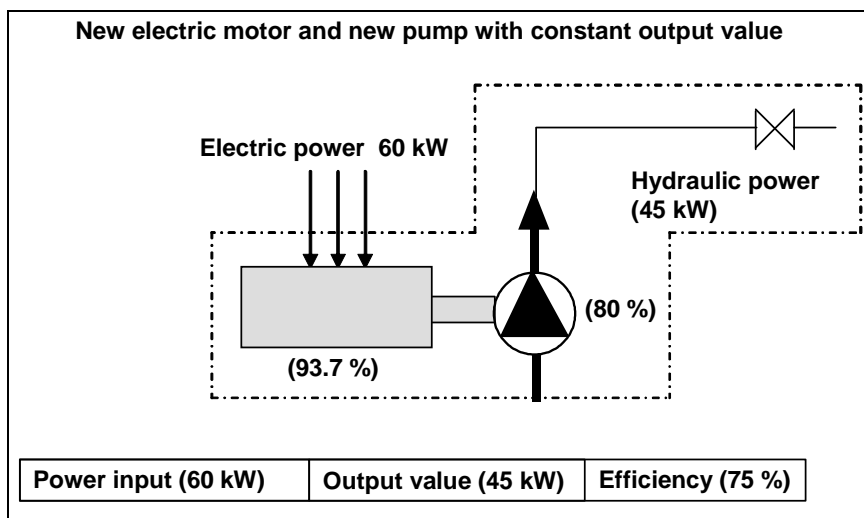

Figure 1.14: New electric motor and new pump with constant output

In this case, the power input was 40 kW lower than before, see Figure 1.10. The efficiency remains at 75 %, but the power consumption from System 1 (old motor and, presumably, old pump) is reduced by 40 %, and from System 2 (new motor, new pump) reduced by 33 %. The assessment could have investigated whether it was possible to reduce the size of both the motor and the pump without harmful effects on the cooling, or to reduce the required hydraulic power to, e.g. 20 kW. This may have reduced the capital money spent on equipment, and also shown an energy efficiency improvement.

Example: System 4. System 3 coupled with an heat exchanger

In Figure 1.15, the system boundary has been extended and the sub-system now includes a new motor, a new pump and an old heat exchanger for the cooling process. The process cooling power is 13 000 kW_{th} (th = thermal).

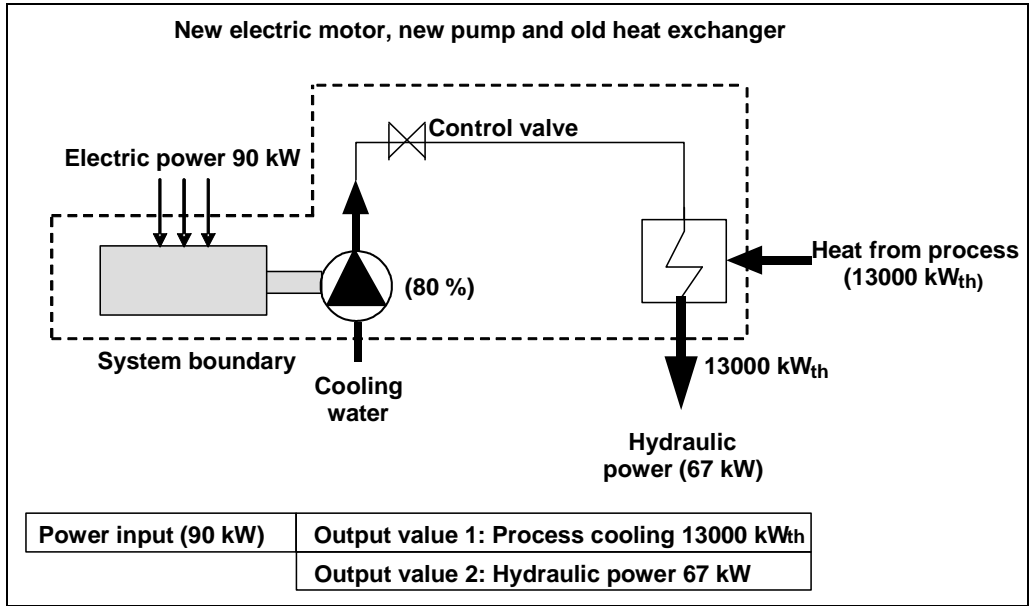

Figure 1.15: New electric motor, new pump and old heat exchanger

The output values are the removal of process heat and hydraulic power due to increased water flow and pressure.

However, in terms of defining this utility system (see Sections 1.3.1 and 1.4.1), the utility service provided is cooling. The system is designed to deliver cooling of 13 000 kW_{th} to a process (or processes). The process heat in this system plays no part, and the output heat is wasted. The efficiency remains as 75 %, as in System 3, if measured on an input/output basis. However, it could be measured on an SEC basis, and the energy required to deliver a specified amount of cooling (see Section 1.3.1):

$$\begin{aligned}
 \text{SEC} &= \frac{\text{energy used}}{\text{products produced}} = \frac{(\text{energy imported} - \text{energy exported})}{\text{products / outputs produced}} = \frac{\text{energy used in cooling system}}{\text{service delivered}} = \\
 &= \frac{90 - 67 \text{ kW}}{13000 \text{ kW}_{\text{th}} \text{ cooling}} = 0.00177 \text{ kW} / \text{kW}_{\text{th}} \text{ cooling} = 1.77 \text{ W} / \text{kW}_{\text{th}} \text{ cooling}
 \end{aligned}$$

If the cooling needs are reduced, e.g. caused by a cutback in production to 8000 kW cooling, then the SEC becomes 2.88 W/kW_{th}. As stated in Section 1.3.1, this is an increase in SEC, and therefore a loss in energy efficiency, i.e. a loss of:

$$\frac{(2.88 - 1.77)}{1.77} = 62 \%$$

Note: this does not address the efficiency of the cooling of the process, only the energy efficiency of the cooling system.

Example: System 5: System 4 with recovery of heat

Due to environmental concerns, a decision was taken by the company to reduce the emissions of carbon and nitrogen dioxides by recovering heat from the cooling water, thereby reducing the use of oil in the heating plant (see Figure 1.16):

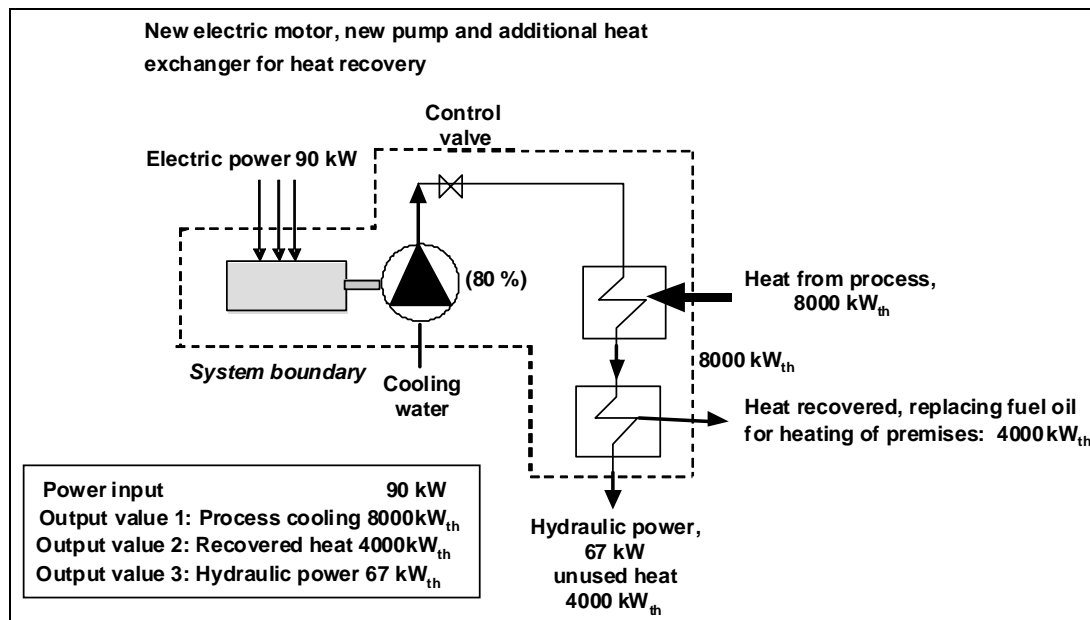

Figure 1.16: New electric motor, new pump and two heat exchangers

A calculation strictly on inputs and outputs to the cooling system shows:

$$\frac{\text{energy used in cooling system}}{\text{service delivered}} = \frac{90 - 67 \text{ kW}}{4000 \text{ kW cooling}}$$

$$= 0.00575 \text{ kW/kW}_{\text{th}} \text{ cooling} = 5.75 \text{ W/kW}_{\text{th}} \text{ cooling.}$$

Compared with calculations on System 4, this is a decrease in efficiency, while the oil-fired heating plant will show an increase in efficiency.

It is evident that the heat recovery arrangement represents an increase in energy efficiency. To estimate the value of the heat recovery in more detail, the oil-fired heating plant also needs to be considered. The value of the reduction of the oil consumption and the decreasing heat recovery from hot flue-gases from the heating plant need to be taken into account.

In this case, like in most others, the sub-systems are interconnected, which means that the energy efficiency of one sub-system often has an influence on the efficiency of another.

1.5.1.1 Conclusions on systems and system boundaries

It is important to consider an installation in terms of its component units/systems. The maximum return on investment may be gained from considering a whole site and its interconnected units/systems (for example, in the STS BREF, see the general BAT 13 and 14, and BAT 81 for the coating of cars). Otherwise, (as seen in Systems 1 and 2 above) changing individual components may lead to investment in incorrectly sized equipment and missing the most effective efficiency savings.

Investigations should be carried out into the need for a given existing system or sub-system, or whether the required service (e.g. cooling, heating) can be achieved in a modified or totally different way to improve energy efficiency.

The units/systems must be:

- defined in terms of boundaries and interactions at the appropriate level
- seen to deliver an identifiable, needed service or product
- assessed in terms of the current or planned need for that product or service (i.e. not for past plans).

The maximum energy efficiency for an installation may mean that the energy efficiency of one or more systems may be de-optimised to achieve the overall maximum efficiency. (This may be in mathematical terms, as efficiencies are gained elsewhere, or other changes may change the factors in the calculations for an individual system. It may not result in more energy usage overall.)

1.5.2 Other important issues to be considered at installation level

1.5.2.1 Recording the reporting practices used

At installation level, one practice (or set of conventions) for reporting should be adopted and maintained. The boundaries for energy efficiency calculations and any changes in boundaries and operational practices should be identified in the internal and external historical database. This will help maintain the interpretation and comparability between different years.

1.5.2.2 Internal production and use of energy

In several processes (e.g. refineries, black liquor in pulp and paper plants) fuel that is produced in the process is consumed internally. It is essential that the energy in this fuel is taken into account when looking at the energy efficiency of a process. Indeed, as shown in Section 2.2.2, refineries would have very low energy consumptions, as about 4 to 8 % of the crude oil input is used internally as liquid and gaseous fuels. In addition, refineries may also import energy resources such as electricity, steam and (occasionally) natural gas. The refinery may be equipped with a cogeneration facility, and may export electricity while increasing the internal fuel consumption. According to Equation 1.1 and Equation 1.3, a refinery equipped with a cogeneration facility could appear as a net energy producer, as it may become a net electricity producer.

Clearly this does not reflect reality, as refineries consume significant amounts of energy. While system boundaries and energy vectors can be chosen to reflect the circumstances at an installation, once defined for a specific plant, these should be adhered to.

1.5.2.3 Waste and flare recovery

Any process generates a quantity of solid, liquid and/or gaseous waste. These wastes may have an energy value which may be recovered internally or externally. The solid and liquid waste may be exported to an external incineration company, the waste gases may be flared. See Section 3.1.5.

Wastes

Example: A waste has previously been exported to an external incinerator company. The production site finds a way to use this waste internally, e.g. as fuel for its boilers or its furnaces and needs to determine whether this improves the energy efficiency of the production unit/site, given that:

- the internal use of this waste reduces the need for external fuels, but the overall energy consumption still stays the same
- on the other hand, the incinerator company may have an installation where the fuel value of that waste is recovered via the production of steam. In this case, the rerouting of the waste stream for use as an internal fuel rather than sending it to an incinerator company may not result in any overall improvement of the energy efficiency when looking at the total picture of the producer plus incinerator company.

Note: the switch from external incineration to internal use may be driven by commercial conditions and not energy efficiency.

See **Overall**, below for conclusions.

Flares

Flare are primarily a safety device for industry and are used to safely vent waste gases on plants such as mineral oil refineries, tanks farms, chemical plants and landfills. Their use as a disposal route for waste gases is usually only a secondary function¹⁷. Well maintained, operated and designed sites will have, under normal operating conditions, a small to negligible flow to flare. Most sites will, however, have a constant small flow to the flare due to, e.g. leaking relief valves and venting due to loading/unloading operations of storage tanks.

Any gas sent to flare is burnt without recovery of the energy contained in the flare gas. It is possible to install a flare gas recovery system, which recovers this small flow and recycles it to the site fuel gas system.

Example: The operator of a production process which previously did not have a flare gas recovery system, decides to install one. This will reduce the external consumption of fuel gas, whereas the overall fuel gas consumption of the process remains the same. The operator needs to determine how this fuel gas recovery system is considered in terms of energy efficiency. This is more important if one production process recovers not only its own flare losses but also the losses to flare of other production processes on the site.

See **Overall**, below for conclusions.

Overall

According to Equation 1.5 in Section 1.4.2.2, no credit is shown directly for recovering waste as fuel. However, where it is recycled internally, it may be used to reduce the value of the fuel import ($E_{f,in}$). Where the energy is recovered at the external incinerator, the case is analogous to the calculation of primary energy (see Section 1.3.1) and may be allowed for in the same manner. Another possibility is to define, for a given process, the reference practice on the amount of waste generated and to what extent it is recycled, and to give an energy credit to those operators who are able to use the waste in a more efficient way than in the reference case. However, the picture may become unrealistically complex, unless significant amounts of wastes containing energy are produced within the installation (proportionate to the energy input of the installation).

¹⁷ An exception may be the drilling of oil, where a flare is indeed used to dispose of the gas which accompanies the oil which is pumped up. For all other industries, especially if there are toxic gases, an incinerator is considered more appropriate than a flare for waste gas treatment. The main advantage of a flare, however, is a much higher turndown ratio than an incinerator.

From the above considerations, it should be clear that it is important to agree on the rules of how to deal with waste when setting up the framework to define the SEC/EEI of a process/unit. Different industrial sectors may have different practices and valorise the internal use of waste in their energy efficiency. It is important that each industrial sector and/or company clearly defines the standard practice applied.

Each industry should also define clearly how to deal with wastes, to allow a fair comparison between competing production processes. At installation level, one practice for reporting should be adopted and maintained. Changes should be identified in the internal and external historical database to maintain the comparability between different years.

1.5.2.4 Load factor (reduction of SEC with increasing production)

The reduction of the specific energy consumption with an increasing production rate is quite normal and is caused by two factors:

- the production equipment will be operating for longer periods when the production rate is high. This means that the idle periods become shorter. Some types of equipment run continuously, even during non-production times. This period will be reduced when the non-production time gets shorter
- there is a base energy consumption that does not depend on the utilisation of production capacity. This consumption is related to the starting up and the maintaining temperature of equipment (without any production, see sensible heat, Section 1.5.2.10), the use of lighting, fans for ventilation, office machines, etc. The heating of the premises is also independent of the production rate but rather on the outdoor temperature, as is shown in Figure 1.17. At higher production rates, these consumptions will be spread over more (tonnes of) products.

To eliminate the influence of the load factor on the real energy efficiency of the site/unit, the operator may use sector/site/unit-specific correction factors. Equally, the base load of the site/unit may be measured, calculated or estimated (e.g. by extrapolating from different production rates). This situation is analogous to financial accounting, and the energy efficiency balances can be qualified in specific cases [127, TWG].

The operator should update the internal and external historical database to maintain the comparability between different years.

1.5.2.5 Changes in production techniques and product development

Changes in production techniques may be implemented, e.g. as a result of technical development, or because of new components or technical systems being available on the market. Obsolete technical systems may need to be replaced and new control systems may need to be introduced to improve the production efficiency. The introduction of such changes of production techniques may also lead to improvements of energy efficiency. Changes in production techniques leading to more efficient energy use will be regarded as measures for energy efficiency improvements. See Sections 2.3 and 2.3.1.

In some cases, new units may need to be added to a production process to meet the market demand, to comply with new product specifications or to comply with environmental requirements. In these cases, the SEC may deteriorate after the new unit has been put into operation, because the new unit requires additional energy. This does not mean that the site is failing in its management of energy.

The operator should update the internal and external historical database to maintain the comparability between different years.

Examples:

- new fuel specifications (for low sulphur diesel and petrol set by the EURO IV regulation) required the adaptation of mineral oil refineries during the years 2000 - 2005. This led to an increase of energy consumption at the refineries
- in the pulp and paper industry, improvements to the fibres used in the process led to a reduction of energy use. At a later date, the quality of the finished product was also improved, which required increased grinding. After these two steps in technical development, the end result was an increase in the total energy use
- a steel company can improve the strength of the delivered steel products; however, the new processes increase energy consumption. The customers can reduce the steel thicknesses in their products by several tens of percentage points. There may be energy gains from the decreased weight of the products e.g. in cars. The energy savings are part of the life cycle assessment of the products, and does not figure in the energy efficiency calculations for an installation (as the IPPC Directive does not include LCA of products).

Changes in the production layout

Changes in the production layout may mean e.g. that unprofitable production lines will be shut down, utility support systems will be changed, and similar lines of business will be merged. Changes in production layout may also be made to achieve energy efficiency improvements.

This may impact on the SEC denominator, and the operator should update their internal and external historical database to maintain the comparability between different years.

Ceasing the manufacturing of a product with high energy input

A company may cease to manufacture a product that requires a high energy input. Both the total and the specific energy consumption will be reduced. This may be claimed to be a measure to improve the energy efficiency although no other measures have been taken.

Again, the operator should update the internal and external historical database to maintain the comparability between different years.

Outsourcing

The supply of a utility is sourced outside of the installation, e.g. the generation and supply of compressed air (see Section 3.7). The energy consumption would be reduced by buying compressed air from an external source. The energy use of the supplier of compressed air will be increased. The change should be dealt with as described in primary energy as discussed in Section 1.3.6.1.

Contracting out of process steps

An operator may consider contracting out a process that is energy intensive, such as heat treatment of metal components. As the operation still has to be carried out, it cannot be regarded as an action for energy efficiency improvements, and should be included in calculations, unless the change is noted in records and the SEC and EEI are amended accordingly. Note: a subcontractor running such a process may be more energy efficient, as there may be more expert knowledge of the process (enabling better process optimisation) and there may be higher throughput, reducing the load factor.

Example: An operator of an installation for the serial construction of cars decides to increase their purchase of components instead of manufacturing such components themselves. The result will be that the total and the specific energy consumption will decrease. This must be taken into account in the updating of energy efficiency indicators and records.

1.5.2.6 Energy integration

Internal power production

Internal power production (electricity or steam) without increasing the use of primary energy sources is a recognised way of improving energy efficiency. This can be optimised by the exchange of energy with adjacent units or installations (or non-industrial users); see Sections 2.4, 2.12, 2.13 and 3.3. System boundaries need to be defined and possible ambiguities settled. The setting of boundaries is discussed in Sections 1.4 and 1.5 above, and calculating primary energies in Section 1.3.6.1.

Use of oxygen in a combustion plant

Oxygen may be used as in a combustion plant to increase combustion efficiency and reduce fuel inputs. It also has a beneficial effect on the energy efficiency by reducing the air mass flow in the flue-gases, and reduced NO_x emissions. However, energy is also used in the production of O₂, either on-site or off-site, and this should be accounted for. This is discussed under primary energy (Section 1.3.6.1), in Section 3.1.6 and in Annex 7.9.5.

Process integration and company disaggregation

Over the last few decades, two trends can be observed:

- the integration of processes
- the disaggregation of companies, especially in the chemicals sector.

The development of sites with a high degree of integration offers considerable economic advantages. In other cases, the market strategy has been to break companies into their component production entities. In both cases, this results in complex sites with many operators present and with the utilities being generated either by one of these operators or even by a third party. It may also result in complex energy flows between the different operators.

In general, these large integrated complexes offer a high potential for an efficient use of energy through integration.

1.5.2.7 Inefficient use of energy contributing to sustainability and/or overall site efficiency

As noted in Sections 1.4 and 1.5, special care is required when defining the system boundaries for energy efficiency for complex sites, such as those described in Section 1.5.2.6, etc. It is emphasised that in the specific examination of individual production processes, certain energy uses might seem inefficient even though they constitute a highly efficient approach within the integrated system of the site. Individual unit, process or system operators not able to operate at the best efficiency may be commercially compensated in order to achieve the most competitive environment for the integrated site as a whole.

Some examples are:

- the use of steam in a drying process appears to be less energy efficient than the direct use of natural gas. However, the low pressure steam comes from a CHP process combined with highly efficient electricity generation (see Sections 3.4 and 3.11.3.2)
- cogeneration plants located at the production site are not always owned by the production site, but may be a joint venture with the local electricity generation company. The steam is owned by the site operator and the electricity is owned by the electricity company. Care should therefore be taken as to how these facilities are accounted for
- electricity is generated and consumed at the same site; however, fewer transmission losses are achieved
- within a highly integrated system, residues containing energy from production processes are returned into the energy cycle. Examples are the return of waste heat steam into the

steam network and the use of hydrogen from the electrolysis process as a fuel substitute gas in the heat and/or electricity generation process or as a chemical (e.g. raw material in hydrogen peroxide production). Other examples are the incineration of production residues in plant boilers, and waste gases burnt as fuels, which have a lower efficiency than using e.g. natural gas (in hydrocarbon gases in a refinery or CO in non-ferrous metals processing). See Section 3.1.6.

Although not within the scope of this document (see Scope), renewable/sustainable energy sources and/or fuels can reduce the overall carbon dioxide emissions to the atmosphere. This can be accounted for by using a carbon balance, see Section 1.3.6.1 and Annex 7.9.6.

1.5.2.8 Heating and cooling of premises

The heating and cooling of premises is an energy use that is strongly dependent on the outdoor temperature, as is shown in Figure 1.17.

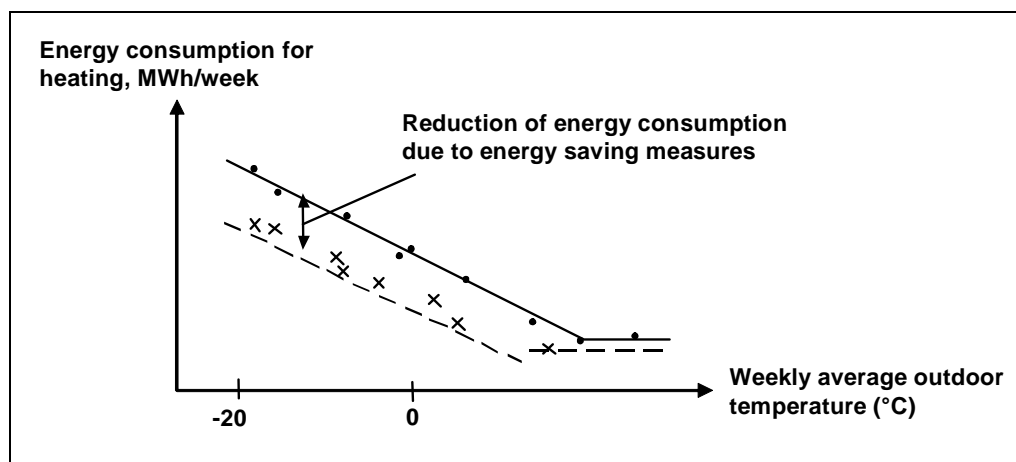

Figure 1.17: Energy consumption depending on outdoor temperature

If measures such as heat recovery from the outlet of ventilation air or improvement of building insulation are taken, the line in Figure 1.17 will move downwards.

The heating and cooling requirements are therefore independent of production throughput and form part of the load factor, see Section 1.5.2.4.

1.5.2.9 Regional factors

Heating and cooling (Section 1.5.2.8, above) are regional factors, generally with heating requirements being greater in northern Europe, and cooling greater in southern Europe. This can affect the production processes, e.g. the need to keep waste at a treatable temperature in waste treatment installations in Finland in winter, and the need to keep food products fresh will require more cooling in southern Europe, etc.

Regional and local climatic variations also have other restrictions on energy efficiency: the efficiency of coal boilers in northern Europe is generally about 38% but in southern Europe 35%, the efficiency of wet cooling systems is affected by the ambient temperature and dew point, etc.

1.5.2.10 Sensible heat

Heat that results in a temperature change is said to be 'sensible' (i.e. that are apparent or can be 'sensed', although this term is falling out of use), see Section 3.1. For example, the heating requirement to bring all plant input from ambient temperature to 104.4 °C in a refinery is called the **sensible heat**.

1.5.2.11 Further examples

Annex 7.3 lists further examples of processes:

- example 1: ethylene cracker
- example 2: vinyl acetate monomer (VAM) production
- example 3: hot rolling mill in a steel works

These processes illustrate the following issues:

- varied and complex sites
- complex energy flows
- multiple products with fuel values
- electrical energy efficiency varying with production
- specific industry-wide E EI (energy efficiency indicator) for refineries, the Solomon Energy Benchmark, in Annex 7.9.1

2 TECHNIQUES TO CONSIDER TO ACHIEVE ENERGY EFFICIENCY AT AN INSTALLATION LEVEL

[9, Bolder, 2003, 89, European Commission, 2004, 91, CEFIC, 2005, 92, Motiva Oy, 2005, 96, Honskus, 2006, 108, Intelligent Energy - Europe, 2005, 127, TWG]

A hierarchical approach has been used for Chapters 2 and 3:

- Chapter 2 describes techniques to be considered at the level of a entire installation with the potential to achieve optimum energy efficiency
- Chapter 3 sets out techniques to be considered at a level below installation: primarily the level of energy-using systems (e.g. compressed air, steam) or activities (e.g. combustion), and subsequently at the lower level for some energy-using component parts or equipment (e.g. motors).

Management systems, process-integrated techniques and specific technical measures are included in the two chapters, but they overlap completely when seeking the optimum results. Many examples of an integrated approach demonstrate all three types of measures. This makes the separation of techniques for description somewhat difficult and arbitrary.

Neither this chapter nor Chapter 3 gives an exhaustive list of techniques and tools, and other techniques may exist or be developed which may be equally valid within the framework of IPPC and BAT. Techniques from this chapter and from Chapter 3 may be used singly or as combinations and are supported by information in Chapter 1 to achieve the objectives of IPPC.

Where possible, a standard structure is used to outline each technique in this chapter and in Chapter 3, as shown in Table 2.1. Note that this structure is also used to describe the systems under consideration, such as (at installation level) energy management, and (at a lower level) compressed air, combustion, etc.

Type of information considered	Type of information included
Description	Short descriptions of energy efficiency techniques presented with figures, pictures, flow sheets, etc. that demonstrate the techniques
Achieved environmental benefits	The main environmental benefits supported by the appropriate measured emission and consumption data. In this document, specifically the increase of energy efficiency, but including any information on reduction of other pollutants and consumption levels
Cross-media effects	Any side-effects and disadvantages affecting the environment caused by implementation of the technique. Details on the environmental problems of the technique in comparison with others
Operational data	Performance data on energy and other consumptions (raw materials and water) and on emissions/wastes. Any other useful information on how to operate, maintain and control the technique, including safety aspects, operational constraints of the technique, output quality, etc.
Applicability	Consideration of the factors involved in applying and retrofitting the technique (e.g. space availability, process specific, other constraints or disadvantages of the technique)
Economics	Information on costs (investment and operation) and related energy savings, EUR kWh (thermal and/or electricity) and other possible savings (e.g. reduced raw material consumption, waste charges) also as related to the capacity of the technique
Driving force for implementation	Reasons (other than the IPPC Directive) for implementation of the technique (e.g. legislation, voluntary commitments, economic reasons)
Examples	Reference to at least one situation where the technique is reported to be used
Reference information	Information that was used in writing the section and that contains more details

Table 2.1: The information breakdown for systems and techniques described in Chapters 2 and 3

2.1 Energy efficiency management systems (ENEMS)

Description

All industrial companies can save energy by applying the same sound management principles and techniques they use elsewhere in the business for key resources such as finance, raw material and labour as well as for environment and health and safety. These management practices include full managerial accountability for energy use. The management of energy consumption and costs eliminates waste and brings cumulative savings over time.

Note that some energy management techniques that secure financial savings do not reduce energy usage (see Section 7.11).

The best environmental performance is usually achieved by the installation of the best technology and its operation in the most effective and efficient manner. This is recognised by the IPPC Directive definition of 'techniques' as *'both the technology used and the way in which the installation is designed, built, maintained, operated and decommissioned'*.

For IPPC installations, an environmental management system (EMS) is a tool that operators can use to address these design, construction, maintenance, operation and decommissioning issues in a systematic, demonstrable way. An EMS includes the organisational structure, responsibilities, practices, procedures, processes and resources for developing, implementing, maintaining, reviewing and monitoring the environmental policy. Environmental management systems are most effective and efficient where they form an inherent part of the overall management and operation of an installation.

Management to achieve energy efficiency similarly requires structured attention to energy with the objective of continuously reducing energy consumption and improving efficiency in production and utilities, and sustaining the achieved improvements at both company and site level. It provides a structure and a basis for the determination of the current energy efficiency, defining possibilities for improvement and ensuring continuous improvement. All effective energy efficiency (and environmental) management standards, programmes and guides contain the notion of continuous improvement meaning that energy management is a process, not a project which eventually comes to an end.

There are various process designs, but most management systems are based on the plan-do-check-act approach (which is widely used in other company management contexts). The cycle is a reiterative dynamic model, where the completion of one cycle flows into the beginning of the next, see Figure 2.1.

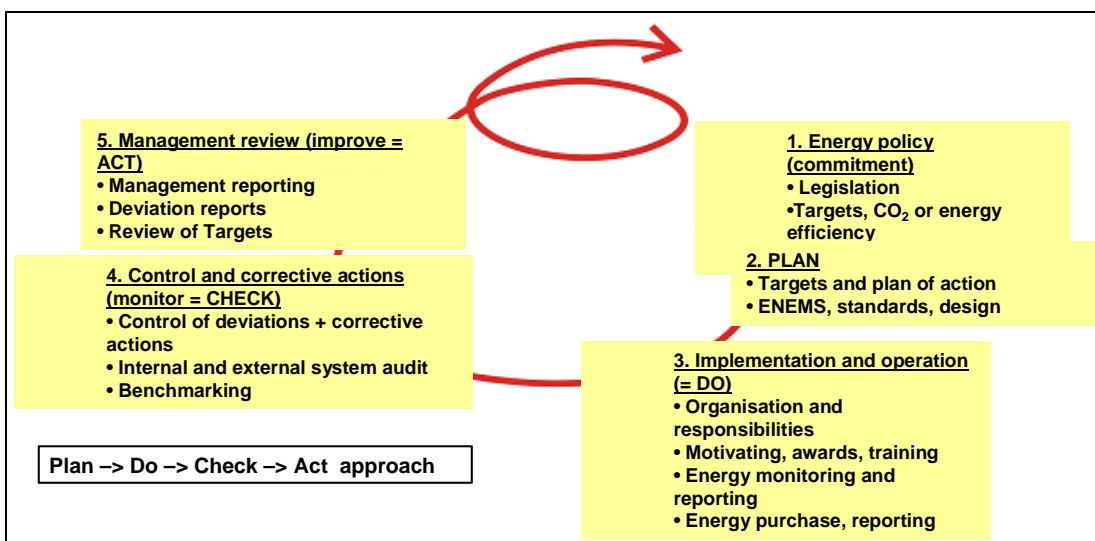

Figure 2.1: Continuous improvement of an energy efficiency management system [92, Motiva Oy, 2005]

The best performance has been associated with energy management systems that show the following: (from Energy management matrix, [107, Good Practice Guide, 2004])

- **energy policy** – energy policy, action plans and regular reviews have the commitments of top management as part of an environmental strategy
- **organising** – energy management fully integrated into management structure. Clear delegation of responsibility for energy consumption
- **motivation** – formal and informal channels of communication regularly used by energy managers and energy staff at all levels
- **information systems** – a comprehensive system sets targets, monitors consumptions, identifies faults, quantifies savings and provides budget tracking
- **marketing** – marketing the value of energy efficiency and the performance of energy management both within and outside the organisation
- **investment** – positive discrimination in favour of 'green' schemes with detailed investment appraisal of all new-build and refurbishment opportunities.

From these sources, it can be seen that an energy efficiency management system (ENEMS) for an IPPC installation should contain the following components:

- a. commitment of top management
- b. definition of an energy efficiency policy
- c. planning and establishing objectives and targets
- d. implementation and operation of procedures
- e. benchmarking
- f. checking and corrective action
- g. management review
- h. preparation of a regular energy efficiency statement
- i. validation by certification body or external ENEMS verifier
- j. design considerations for end-of-life plant decommissioning
- k. development of energy efficient technologies.

These features are explained in greater detail below. Detailed information on components (a) to (k), is given in the Reference information, below. Examples are given in Annex 7.4.

a. Commitment of top management

The commitment of top management is the precondition for successful energy efficiency management. Top management should:

- place energy efficiency high on the company agenda, make it visible and give it credibility
- identify one top manager with responsibility for energy efficiency (this need not be the person responsible for energy, by analogy to quality management systems)
- help create an energy efficiency culture and create the necessary driving forces for implementation
- define a strategy (long term visions) to achieve energy efficiency within integrated pollution prevention and control objectives
- set company targets to achieve these energy efficiency objectives with the IPPC objectives
- define short and medium term concrete actions to achieve the long term vision
- provide the platform to integrate decision-making in order to achieve integrated pollution prevention including energy savings, particularly for when planning new installations or significant upgrading
- guide the company to make investment and purchasing decisions that achieve integrated pollution prevention coupled with energy savings on a continuing basis. Integrated pollution prevention and control is achieved through integrated decision-making and

actions, including the buying of utilities and capital equipment, planning, production, and maintenance as well as environmental management

- define an energy efficiency policy, see (b) below.

b. Definition of an energy efficiency policy

Top management are responsible for defining an energy efficiency policy for an installation and ensuring that it:

- is appropriate to the nature (including local conditions, such as climate), scale and energy use of the activities carried out at the installation
- includes a commitment to energy efficiency
- includes a commitment to comply with all relevant legislation and regulations applicable to energy efficiency, and with other requirements (including energy agreements) to which the organisation subscribes
- provides the framework for setting and reviewing energy efficiency objectives and targets
- is documented and communicated to all employees
- may be made available to the public and all interested parties.

c. Planning and establishing objectives and targets (see Section 2.2)

- procedures to identify the energy efficiency aspects of the installation and to keep this information up-to-date
- procedures to evaluate proposals for new processes, units and equipment, upgrades, rebuilds and replacements in order to identify the energy efficiency aspects and to influence the planning and purchasing to optimise energy efficiency and IPPC
- procedures to identify and have access to legal and other requirements to which the organisation subscribes and that are applicable to the energy efficiency aspects of its activities
- establishing and reviewing documented energy efficiency objectives and targets, taking into consideration the legal and other requirements and the views of interested parties
- establishing and regularly updating an energy efficiency management programme, including designation of responsibility for achieving objectives and targets at each relevant function and level as well as the means and timeframe by which they are to be achieved.

d. Implementation and operation of procedures

It is important to have systems in place to ensure that procedures are known, understood and complied with, therefore effective energy management includes:

(i) structure and responsibility:

- defining, documenting, reporting and communicating roles, responsibilities and authorities, which includes mandating one specific management representative (in addition to a top manager (see (a) above)
- providing resources essential to the implementation and control of the energy management system, including human resources and specialised skills, technology and financial resources

(ii) training, awareness and competence:

- identifying training needs to ensure that all personnel whose work may significantly affect the energy efficiency of the activity have received appropriate training (see Section 2.6)

(iii) communication:

- establishing and maintaining procedures for internal communication between the various levels and functions of the installation. It is particularly important that all individuals and teams that have a role in energy efficiency should have established procedures for maintaining contact, especially those buying energy-using utilities and capital equipment, as well as those responsible for production, maintenance and planning
- establishing procedures that foster a dialogue with external interested parties and procedures for receiving, documenting and, where reasonable, responding to relevant communication from external interested parties (see Section 2.7)

(iv) employee involvement:

- involving employees in the process aimed at achieving a high level of energy efficiency by applying appropriate forms of participation such as the suggestion-book system, project-based group works or environmental committees (see Section 2.7)

(v) documentation:

- establishing and maintaining up-to-date information, in paper or electronic form, to describe the core elements of the management system and their interaction and to provide references to related documentation

(vi) effective control of processes (see Section 2.8):

- adequate control of processes under all modes of operation, i.e. preparation, start-up, routine operation, shutdown and abnormal conditions.
- identifying the key performance indicators for energy efficiency and methods for measuring and controlling these parameters (e.g. flow, pressure, temperature, composition and quantity)
- optimising these parameters for energy efficient operation
- documenting and analysing abnormal operating conditions to identify the root causes and then addressing these to ensure that events do not recur (this can be facilitated by a 'no-blame' culture where the identification of causes is more important than apportioning blame to individuals)

(vii) maintenance (see Section 2.9):

- establishing a structured programme for maintenance based on technical descriptions of the equipment, norms etc. as well as any equipment failures and consequences
- supporting the maintenance programme by appropriate record keeping systems and diagnostic testing
- identifying from routine maintenance, breakdowns and/or abnormalities, possible losses in energy efficiency, or where energy efficiency could be improved
- clearly allocating responsibility for the planning and execution of maintenance

(viii) emergency preparedness and response:

- consider energy usage when recovering or reworking raw materials or products affected by emergency situations.

e. Benchmarking, i.e.:

- carrying out systematic and regular comparisons with sector, national or regional benchmarks (see Section 2.16 for further details).

f. Checking and corrective action, i.e. (see also benchmarking (e) above):

(i) monitoring and measurement (see Section 2.10)

- establishing and maintaining documented procedures to monitor and measure, on a regular basis, the key characteristics of operations and activities that can have a significant impact on energy efficiency, including the recording of information for

tracking performance, relevant operational controls and conformance with the installation's energy efficiency objectives and targets

- establishing and maintaining a documented procedure for periodically evaluating compliance with relevant energy efficiency legislation, regulations and agreements (where such agreements exist)

(ii) corrective and preventive action

- establishing and maintaining procedures for defining responsibility and authority for handling and investigating non-conformance with permit conditions, other legal requirements and commitments as well as objectives and targets, taking action to mitigate any impacts caused and for initiating and completing corrective and preventive action that are appropriate to the magnitude of the problem and commensurate with the energy efficiency impact encountered

(iii) records and reporting

- establishing and maintaining procedures for the identification, maintenance and disposition of flammable, identifiable and traceable energy efficiency records, including training records and the results of audits and reviews
- establishing regular reporting to the identified person(s) on progress towards energy efficiency targets

(iv) energy audit and energy diagnosis (see Section 2.11)

- establishing and maintaining (a) programme(s) and procedures for periodic energy efficiency management system audits that include discussions with personnel, inspection of operating conditions and equipment and reviewing of records and documentation and that results in a written report, to be carried out impartially and objectively by employees (internal audits) or external parties (external audits), covering the audit scope, frequency and methodologies, as well as the responsibilities and requirements for conducting audits and reporting results, in order to determine whether or not the energy efficiency management system conforms to planned arrangements and has been properly implemented and maintained
- completing the audit or audit cycle, as appropriate, depending on the nature, scale and complexity of the activities and the audit, the significance of energy use, associated environmental impacts, the importance and urgency of the problems detected by previous audits and the history of any energy inefficiency or problems – more complex activities with a more significant environmental impact are audited more frequently
- having appropriate mechanisms in place to ensure that the audit results are followed up

(v) periodic evaluation of compliance with legalisation and agreements, etc.

- reviewing compliance with the applicable energy efficiency legislation, the conditions of the environmental permit(s) held by the installation, and any energy efficiency agreements
- documentation of the evaluation.

g. Management review, i.e.:

- reviewing, by top management, at intervals that it determines, the energy efficiency management system, to ensure its continuing suitability, adequacy and effectiveness (see Section 2.5)
- ensuring that the necessary information is collected to allow management to carry out this evaluation
- documentation of the review.

h. Preparation of a regular energy efficiency statement:

- preparing an energy efficiency statement that pays particular attention to the results achieved by the installation against its energy efficiency objectives and targets. It is regularly produced – from once a year to less frequently depending on the significance of energy use, etc. It considers the information needs of relevant interested parties and it is publicly available (e.g. in electronic publications, libraries, etc.), according to Applicability (below).

When producing a statement, the operator may use relevant existing energy efficiency performance indicators, making sure that the indicators chosen:

- give an accurate appraisal of the installation's performance
- are understandable and unambiguous
- allow for year on year comparison to assess the development of the energy efficiency performance of the installation
- allow for comparison with sector, national or regional benchmarks as appropriate
- allow for comparison with regulatory requirements as appropriate.

i. Validation by certification body or external ENEMS verifier:

- having the energy efficiency management system, audit procedure and policy statement examined and validated by an accredited certification body or an external verifier can, if carried out properly, enhance the credibility of the system (see Applicability, below).

j. Design considerations for end-of-life plant decommissioning

- giving consideration to the environmental impact from the eventual decommissioning of the unit at the stage of designing a new plant, as forethought makes decommissioning easier, cleaner and cheaper
- decommissioning poses environmental risks for the contamination of land (and groundwater) and often generates large quantities of solid waste. Preventive techniques are process-specific but general considerations, when selecting energy efficient techniques, may include:
 - avoiding underground structures
 - incorporating features that facilitate dismantling
 - choosing surface finishes that are easily decontaminated
 - using an equipment configuration that minimises trapped chemicals and facilitates drain-down or washing
 - designing flexible, self-contained units that enable phased closure
 - using biodegradable and recyclable materials where possible
 - avoiding the use of hazardous substances, e.g. where substitutes exist (such as in heat exchanging or insulating fluids). Where hazardous materials are used, managing appropriately the risks in use, maintenance and decommissioning.

k. Development of energy efficient technologies:

- energy efficiency should be an inherent feature of any process design activities carried out by the operator, since techniques incorporated at the earliest possible design stage are both more effective and cheaper (see Section 2.3). Giving consideration to the development of energy efficient technologies can for instance occur through R & D activities or studies. As an alternative to internal activities, arrangements can be made to keep abreast with – and where appropriate – commission work by other operators or research institutes active in the relevant field.

Achieved environmental benefits

Implementation of and adherence to an ENEMS focuses the attention of the operator on the energy efficiency performance of the installation. In particular, the maintenance of and compliance with clear operating procedures for both normal and abnormal situations and the associated lines of responsibility should ensure that the installation's permit conditions and other energy efficiency targets and objectives are met at all times.

Energy efficiency management systems typically ensure the continuous improvement of the energy efficiency performance of the installation. The poorer the starting point is, the more significant short-term improvements can be expected. If the installation already has a good overall energy efficiency performance, the system helps the operator to maintain the high performance level.

Cross-media effects

Energy efficiency management techniques should be designed to integrate with other environmental objectives and consider the overall environmental impact, which is consistent with the integrated approach of the IPPC Directive. However, energy efficiency is likely to be one of several objectives to meet, and others (such as the saving of raw materials, improved product quality, reduction of emissions to the environment which may increase energy consumption). This is discussed further in the ECM REF (Reference document on Economics and Cross-media Effects).

Operational data

No specific information reported. See Examples, below.

Applicability

1. Components

The components described above can typically be applied to all IPPC installations. The scope (e.g. level of detail) and nature of the ENEMS (e.g. standardised or non-standardised) will generally be related to the nature, scale and complexity of the installation, and the energy usage, as well as the range of other environmental impacts it may have. For example:

- in small installations, the top manager in Section 2.1(a) and 2.1(d)(i) may be the same person
- the energy policy 2.1(b) may be made public as part of a statement of environmental policy or via a corporate social responsibility report
- other factors such as legislation relating to competition and confidentiality must be taken into account (see section 2.1(h)). Energy efficiency may be made public by the use of indices (e.g. Y % reduction where energy use in year X is 100 %), aggregating the figures of installations on the same site or in the same company (see Section 1.3 and examples in Annex 7.4).

2. Standardised and non-standardised EMSs and/or ENEMSs

Within the European Union, many organisations have decided on a voluntary basis to implement energy management systems. These may be:

- adding specific requirements for energy efficiency to an existing management system, usually (but not exclusively) an EMS (note that ENEMSs described in the bullet below are designed to be consistent with an existing EMS). An EMS may be based on EN ISO 14001:1996 or the EU Eco-management and audit scheme EMAS. EMAS includes the management system requirements of EN ISO 14001, but places additional emphasis on legal compliance, environmental performance and employee involvement; it also requires external verification of the management system and validation of a public environmental statement. In EN ISO 14001 self-declaration is an alternative to external verification. There are also many organisations that have decided to put in place non-standardised EMSs

- using separate energy efficiency management systems (ENEMSs). These may be:
 - energy management based on national standards (such as the Danish DS 2403, the Irish IS 393, the Swedish SS627750, the German VDI Richtlinie No. 46 Energy Management, the Finnish guideline or other guidelines (international standards or guidelines on energy management). A European (CEN) standard is in preparation
 - energy management system on a non-standardised basis and adapted to meet their own needs and management structures.

A review of benchmarking and energy management schemes has found [165, BESS_EIS]:

- *advantages of a standardised system* (e.g. Denmark DS 2403):
 - structured approach, concentrates on energy, easily achieved if ISO or another management system is already in place
 - structure and terminology parallel to ISO 14001 and ISO 9001
 - proved energy savings in Denmark 10 to 15 %
 - energy efficiency becomes an organisational requirement by top management
 - certification issued after approval
 - large companies prefer certified or structured management systems
 - the certification process is valuable, challenging and detailed
 - covers all topics of energy supply, transformation, use, behaviour, technology, people
 - well-documented (ISO 9001 based)
 - can be used in any energy agreements
- *disadvantages:*
 - in itself, only guarantees a minimum energy management level
 - the degree to which companies implement, e.g. DS 2403 varies
 - the focus for the companies is to satisfy the system, not to implement best practice in energy management
 - if no formal documented management system is in place, it will require additional resources and expertise to implement.

Implementation and adherence to an internationally accepted standardised system such as EN ISO 14001:1996 can give higher credibility to the EMS, especially when subject to a properly performed external verification. EMAS provides additional credibility due to the interaction with the public through the environmental statement and the mechanism to ensure compliance with the applicable environmental legislation. However, non-standardised systems can in principle be equally effective provided that they are properly designed and implemented.

3. External verification

Depending on the chosen system, the operator may opt (or not) to have external verification and/or a public energy statement.

4. Making an energy efficiency policy public (see (h), above) may be restricted by confidentiality and competition reasons. While it may act as a driver, it does not in itself increase ENE. The general policy for energy efficiency can be made available to the public in a Corporate Social Responsibility Report, and/or data can be reported as indices, e.g. see Examples, and Annex 7.4.

Economics

It is difficult to accurately determine the costs and economic benefits of introducing and maintaining a good ENEMS. However, it should be remembered that savings (net) contribute directly to gross profit.

See Examples, below.

Driving forces for implementation

Energy efficiency management systems can provide a number of advantages, for example:

- improved insight into the energy efficiency aspects of the company
- improved energy efficiency performance and compliance with energy efficiency measures (voluntary or regulatory)
- improved competitiveness, in particular against a trend of increasing energy prices
- additional opportunities for operational cost reduction and product quality improvement
- improved basis for decision-making
- improved motivation of personnel
- improved company image
- increased attractiveness for employees, customers and investors
- increased trust of regulators, which could lead to reduced regulatory oversight
- facilitates the use of liberalised energy markets, emerging energy services, energy agreements, and energy efficiency incentives (See, e.g. Annexes 7.4, 7.11, 7.12, 7.13 and 7.14).

Examples (see Annex 7.4)

- Outokumpu, Tornio works, Finland [160, Aguado, 2007]
- Aughinish Alumina (AAL), Ireland [161, SEI, 2006]
- Dow Chemical Company [163, Dow, 2005]. Dow achieved the targeted 20 % reduction in energy intensity, down from 13 849 kJ/kg of product to 11 079 kJ/kg, measured as kg of total Dow product mix
- Proved energy savings in Denmark [165, BESS_EIS].

Reference information

[160, Aguado, 2007, 161, SEI, 2006, 163, Dow, 2005]

1. Key environmental standards

(Regulation (EC) No 761/2001 of the European Parliament and of the Council allowing voluntary participation by organisations in a Community eco-management and audit scheme (EMAS), OJ L 114, 24/4/2001, http://europa.eu.int/comm/environment/emas/index_en.htm)

(EN ISO 14001: 1996, <http://www.iso.ch/iso/en/iso9000-14000/iso14000/iso14000index.html>; <http://www.tc207.org>)

2. Energy efficiency standards

- IS 393:2005 Energy management systems (Ireland)
- DS2403 Energy management systems (Denmark)
- SS627750 Energy management systems (Sweden).

2.2 Planning and establishing objectives and targets

2.2.1 Continuing environmental improvement and cross-media issues

Description

An important element of an environmental management system (EMS, which is BAT in all IPPC sectors) is maintaining overall environmental improvement. It is essential that the operator understands what happens to the inputs including energy (understanding the process), and how their consumption leads to emissions. It is equally important, when controlling significant inputs and outputs, to maintain the correct balance between emissions reduction and cross-media effects, such as energy, water and raw materials consumption. This reduces the overall environmental impact of the installation.

In order to achieve an integrated approach to pollution control, it is important to include continuing environmental improvement as a focus in the business planning for an installation. This includes short, medium and long term planning and all the component processes and/or systems of the installation. It should be noted that 'continuing' in this context means the aim of environmental improvement is continuous, and that planning and the consequent actions are repeated over time to achieve this.

All significant consumptions (including energy) and emissions should be managed in a coordinated manner for the short, medium and long term, in conjunction with financial planning and investment cycles, i.e. adapting short term end-of-pipe solutions to emissions may tie the operator to long term higher energy consumption, and postpone investment in more environmentally beneficial solutions (see Examples, below). This will require some consideration of the cross-media issues, and guidance on these and the costing and cost-benefits issues is given in Section 1.1.6 and in more detail in the ECM REF [167, EIPPCB, 2006], and in energy efficient design and other sections (Section 2.2.2, etc.).

The environmental benefits may not be linear, e.g. it may not be possible to achieve 2 % energy savings every year for 10 years. Benefits are likely to be irregular and stepwise, reflecting investment in EN projects, etc. Equally, there may be cross-media effects from other environmental improvements: for example it may be necessary to increase energy consumption to abate an air pollutant. Figure 2.2 shows how energy use may:

- decrease following a first energy audit and subsequent actions
- rise when additional emissions abatement equipment is installed
- decrease again following further actions and investment
- the overall trend for energy use is downwards over time, as the result of longer term planning and investments.

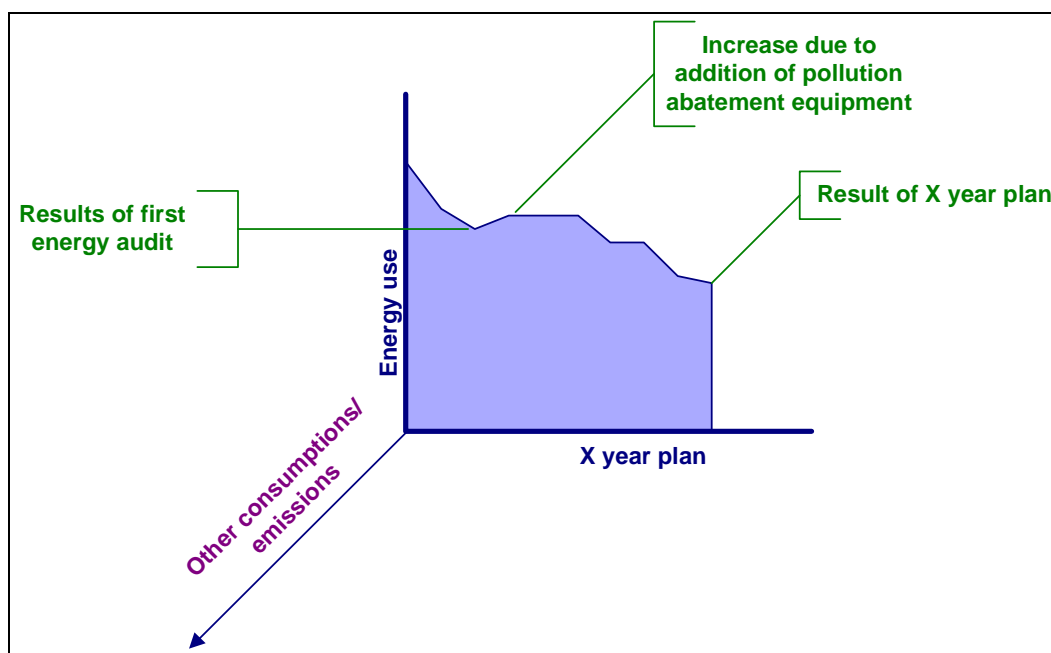

Figure 2.2: Example of possible variation of energy use over time
[256, Tempny, 2007]

Energy efficiency is given a high degree of importance in EU policy (in statements such as the Berlin Declaration, where it is the only environmental issue raised [141, EU, 2007]). When considering the economics and cross-media effects of implementing BAT within an installation, the importance of energy efficiency should be taken into account when considering the requirements of Art 9 (4), i.e. the permit ELVs and equivalent parameters.

Achieved environmental benefits

Long term reduction in consumptions of energy, water and raw materials, and emissions can be achieved. Environmental impacts can never be reduced to zero, and there will be points in time where there is little or no cost-benefit to further actions. However, over a longer period, with changing technology and costs (e.g. energy prices), the viability may also change.

Cross-media effects

A part of the operation's consumptions or emissions may be higher proportionately for a certain period of time until longer term investment is realised.

Operational data

A study in the 1990s has shown that many companies ignore apparently very good returns on energy investments. The conclusion was that most companies made a clear distinction between 'core' and 'non-core' business with little management effort devoted to the latter, unless opportunities survived very high hurdles, such as payback periods of 18 – 24 months. For businesses which are not energy intensive, energy costs were either regarded as 'fixed overheads' or ignored as falling below a 'threshold' share of costs. Also, companies with more significant energy costs did not appear to exploit the available opportunities for 'no regrets' investment [166, DEFRA, 2003].

Applicability

Applicable to all IPPC installations. The extent of this exercise will depend on the installation size, and the number of the variables (also, see Achieved environmental benefits, above). A full cross-media study is carried out rarely.

Economics

Enabling capital investment to be made in an informed manner for the reduction of the overall environmental benefit and the best value for money.

Driving forces for implementation

Cost reduction in the short, medium and long term.

Examples

An example of considering the cross-media effects is given in the ECM REF [167, EIPPCB, 2006].

A theoretical example is a vehicle manufacturer seeking to reduce solvent emissions further. A large step change can be achieved, but this requires replacement of the entire paintshop, which has an operating life of 25 years and a capital cost of about EUR 500 million. The energy consumption of the paintshop is about 38 – 52 % of the entire energy consumption of the plant and in the order of 160 000 – 240 000 MWh (of which 60 % is gas). The amount of raw material used, the application efficiency and the amount of solvents lost may also be affected by the degree of automation. The following require a consideration of the operating and capital costs, as well as the consumptions and emissions, over the payback period of the investment:

- the selection of which type of paint and application system
- the amount of automation
- the amount of waste gas treatment and paint that the system requires
- the operating life of the existing paintshop.

Reference information

[127, TWG, , 141, E U, 2007, 152, E C, 2003, 159, EIPPCB, 2006, 166, DEFRA, 2003, 167, EIPPCB, 2006, 256, Tempany, 2007]

2.2.2 A systems approach to energy management

Description

Work in the SAVE¹⁸ programme has shown that, while there are savings to be gained by optimising individual components (such as motors, pumps or heat exchangers, etc.), the biggest energy efficiency gains are to be made by taking a systems approach, starting with the installation, considering the component units and systems and optimising (a) how these interact, and (b) optimising the system. Only then should any remaining devices be optimised.

This is important for utility systems. Historically, operators have tended to focus on improvements in energy-using processes and other equipment: demandside energy management. However, the amount of energy used on a site can also be reduced by the way the energy is sourced and supplied: supplyside energy management (or utilities management), where there are options, see Section 2.15.2.

Sections 1.3.5 and 1.5.1 discuss the importance of considering the energy efficiency of whole systems and demonstrate how a systems approach can achieve higher energy efficiency gains (this could be considered as a top-down approach).

Achieved environmental benefits

Higher energy savings are achieved at a component level (bottom-up approach). See Examples, below. A systems approach may also reduce waste and waste waters, other emissions, process losses, etc.

Cross-media effects

None.

Operational data

Details are given in the relevant sections, such as:

- Section 2.15.2: Model-based utilities optimisation and management
- Chapter 3 deals predominantly with individual systems.

Applicability

All installations.

Economics

See relevant sections.

Driving force for implementation

- cost
- increased efficiency
- reduced capital investment.

Examples

See relevant sections. For example: A new motor in a CAS or pumping system may save 2 % of the energy input: optimising the whole system may save 30 % or more (depending on the condition of system). See Sections 3.6 and 3.7.

Reference information

[168, PNEUROP, 2007, 169, EC, 1993, 170, EC, 2003, 171, de Smedt P. Petela E., 2006]

¹⁸ SAVE is an EC energy efficiency programme

2.3 Energy efficient design (EED)

Description

In the planning phase of a new plant or installation (or one undergoing major refurbishment), lifetime energy costs of processes, equipment and utility systems should be assessed. Frequently, energy costs can then be seen to be the major part of the total costs of ownership (TCO), or lifetime costs for that plant or installation, as illustrated for typical industrial equipment in Figure 2.3 below.

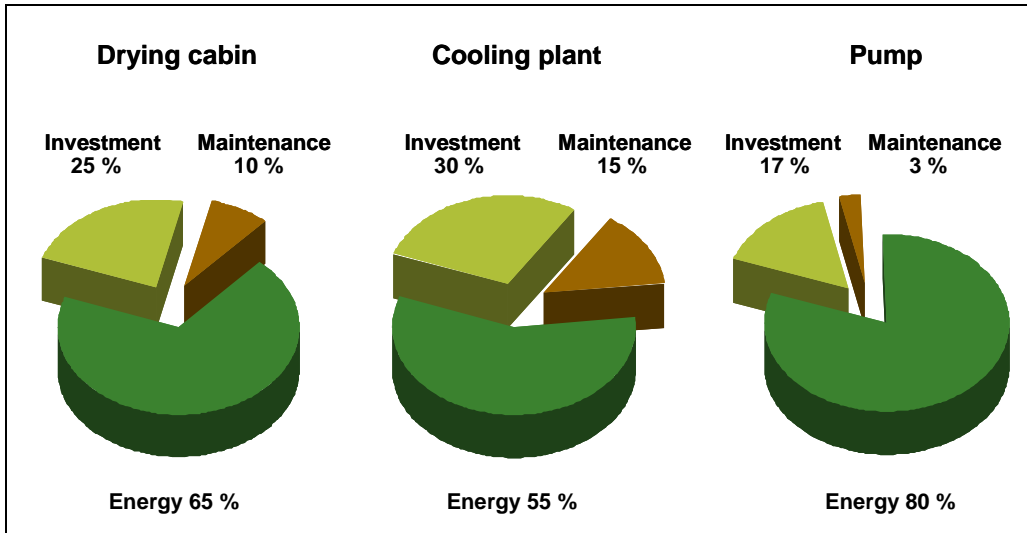

Figure 2.3: Examples of total costs of ownership for typical industrial equipment (over 10 year lifetime)

Experience shows that, if energy efficiency is considered during the planning and design phases of a new plant, saving potentials are higher and the necessary investments to achieve the savings are much lower, compared with optimising a plant in commercial operation. This is illustrated in Figure 2.4 below.

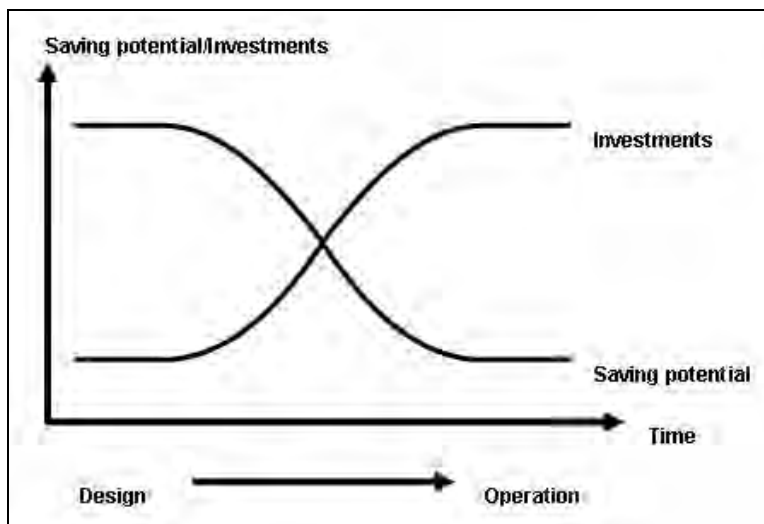

Figure 2.4: Saving potentials and investments in design phase as compared to operational phase

Energy efficient design uses the same technical knowledge and the same activities and methodologies as carrying out energy audits at existing sites. The major difference occurs because areas such as basic design parameters, selection of the process to be used (see Section 2.3.1) and major process equipment, etc., can be addressed in the design phase as illustrated in Figure 2.5 below. This allows the selection of the most energy efficient technologies to be selected. These areas are often impossible or at least very expensive to address in a plant in commercial operation.

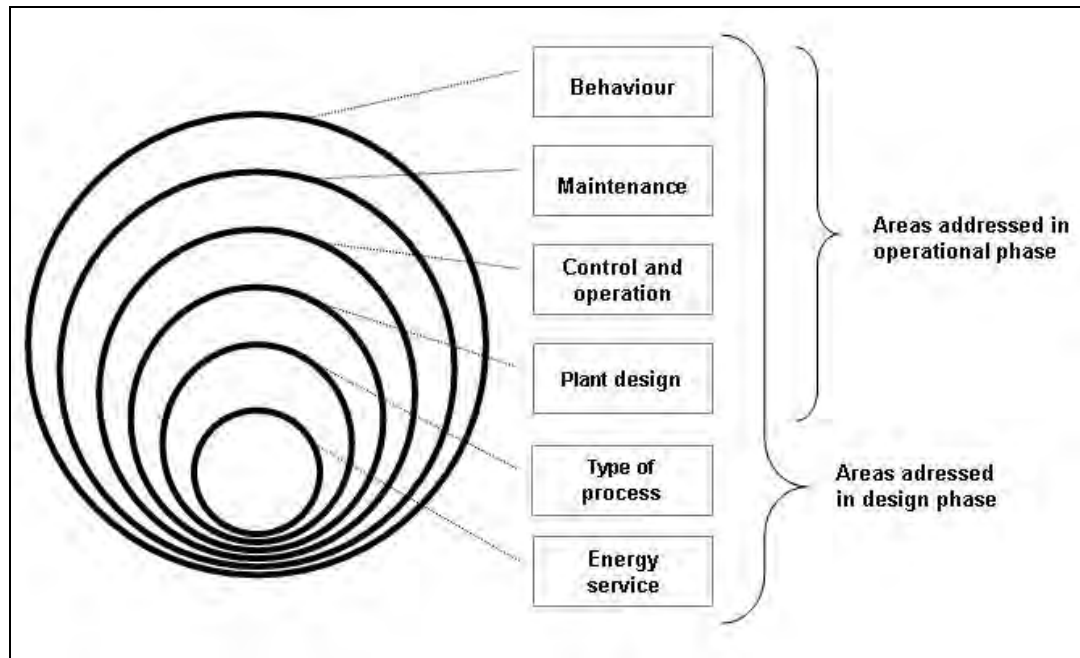

Figure 2.5: Areas to be addressed in the design phase rather than the operational phase

Typical areas where energy services and the real need for energy can be addressed and analysed are the determination of:

- the airflow requirement in planned HVAC installations (heating, ventilation and air conditioning): what can be done to reduce the airflow in the central HVAC systems? (see Section 3.9)
- the low temperature requirement of brine in a cooling system: which processes should be changed or optimised to reduce the cooling load and to raise the brine temperature?
- the heat load in a drying process: which process parameters and plant principles can be changed in order to minimise the heat load? (see Section 3.11)
- the need for steam in a process plant. Could hot water be used so waste heat can be utilised for heating purposes? (see Section 3.2)
- the pressure needed for compressed air: Can the pressure be reduced, or the system split into high and medium pressure systems? (see Section 3.7).

These questions appear simple to answer, but a number of issues must be addressed to clarify savings potentials.

Experience shows that the greatest savings are achieved in new builds and significant upgrades; however, this should not prevent the technique being applied to the planning and design of a retrofit, upgrade or major refurbishment. Pinch methodology can be used to provide answers to some of these questions, where there are both hot and cold streams in a unit or installation (see Section 2.12).

Experience a gain shows that the planning and design process schedules are demanding and frequently run to tight schedules, often to a point where no time (or resource) is available for further analysis of savings potentials. Consequently, the work process of energy efficiency design (EED) should closely follow the planning and design activities as illustrated for a typical construction process in Table 2.2 below.

Construction phase	EED activity
Basic design/ conceptual design	<ul style="list-style-type: none"> enforced data collection regarding energy usage for new facilities assessment of the real energy needs assessment of lifetime energy costs review of basic design parameters influencing energy consumption identification of key persons and parties influencing energy efficiency for new facilities minimisation of energy services introduction of best available technology
Detailed design	<ul style="list-style-type: none"> design of optimal process plants and utility systems assessment of needs for control and instrumentation process integration/heat recovery systems (pinch methodology) minimisation of pressure losses, temperature losses, etc. selection of efficient motors, drives, pumps, etc. supplementary specifications to tendering material regarding energy efficiency
Tendering process	<ul style="list-style-type: none"> ask tenders and manufacturers for more energy efficient solutions quality control of plant designs and specifications in tenders
Construction and erection	<ul style="list-style-type: none"> quality control of specifications for installed equipment as compared to equipment specified in tenders
Commissioning	<ul style="list-style-type: none"> optimisation of processes and utilities according to specifications
Operational phase	<ul style="list-style-type: none"> energy audits energy management

Table 2.2: Example of activities during the energy efficient design of a new industrial site

The 'assessment of real energy needs' is fundamental to EED work and is central to identifying the most attractive areas to address during the later stages of the planning and design process. In theory, this sequence of activities can be used for both the design of complex process plants and in the procurement of simple machines and installations. Major investments being planned and budgeted for should be identified, for example, in a yearly management review, and the need for specific attention for energy efficiency identified.

Achieved environmental benefits

The EED methodology targets the maximum energy savings potential in industry and enables application of energy efficient solutions that may not be feasible in retrofit studies. Implemented savings of 20 – 30 % of total energy consumption have been achieved in a large number of projects. Such savings are significantly more than achieved in energy audits for plants in operation.

Cross-media effects

None anticipated from an integrated design approach.

Operational data

Some examples of results from EED in different industrial sectors are shown in Table 2.3 below.

Company	Savings (EUR/year)	Saving (%)	Investments (EUR)	Payback (years)
<u>Food ingredients:</u> <ul style="list-style-type: none"> • new cooling concepts • change of fermentation process • reduced HVAC in packaging areas • heat recovery from fermentors • new lighting principles 	130000	30	115000	0.8
<u>Sweets:</u> <ul style="list-style-type: none"> • improved control of drying process • optimise cooling circuit • reduced infrared drying of products • reduced compressed air pressure • cheaper heat source (district heating) 	65000	20	50000	0.7
<u>Ready meals:</u> <ul style="list-style-type: none"> • change of heat source for ovens • new freezing technology • new heat recovery concept • optimised NH₃ cooling plant • optimised heat exchangers 	740000	30	1500000	2.1
<u>Plastics:</u> <ul style="list-style-type: none"> • new cooling concept (natural cooling) • heat recovery for building heating • reduced pressure compressed air • reduced HVAC systems 	130000	20	410000	3.2
<u>Abattoir:</u> <ul style="list-style-type: none"> • comprehensive heat recovery • optimised cleaning processes • reduced freezing and cooling load • improved control of cooling processes • use of tallow for heating premises 	2000000	30	5000000	2.5

Table 2.3: Achieved savings and investments in five pilot projects for EED

Compared to traditional energy audits, the total socio-economic cost-benefit ratio for the implemented savings from EED are 3 – 4 times higher.

It is recommended that EED work is carried out in a number of project phases, for example:

- Assessment of energy consumption data and focus areas
- Minimisation of energy service and application of BAT
- Provision of input for plant design, control and instrumentation
- Quality assurance of tenders
- Follow-up.

Each project phase should deliver specific outputs so that the operator can decide which further investigations should be carried out.

In order to achieve the best possible result of the EED work, the following criteria are important:

- even though the planned investments are not well defined in the early stages of the conceptual design/basic design phase, the EED should be initiated at this stage to achieve maximum savings and not to delay the design process
- all energy consumption data and lifetime costs should be calculated or made available in the early stage of the conceptual design/basic design phase. It is very important that all energy consumption data are assessed by the person responsible for the EED. Often, suppliers and manufacturers cannot (or will not) supply data at this stage, so if these data are not available, they must be assessed by other means. Data collection may need to be carried out, as part of the design project or separately
- the EED work should be carried out by an energy expert independent from the design organisation as illustrated in Figure 2.6 below, in particular for non-energy intensive industries (see Applicability)

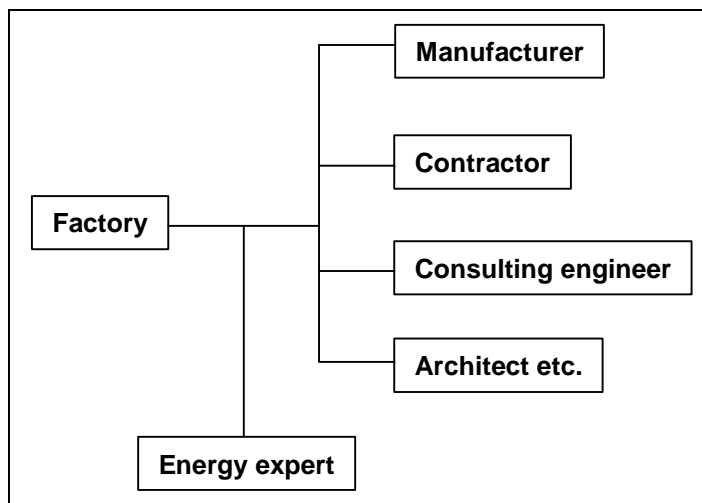

Figure 2.6: Recommended organisation including an energy expert in the planning and design of new facilities

- in addition to end-use consumption, the initial mapping of energy consumptions should also address which parties in the project organisations influence the future energy consumption. As an example, the staff (e.g. operational and technical staff) in the (existing) factory are often responsible for specification of the most important design parameter(s) to optimise a reduction of the energy efficiency of the future plant
- a risk assessment of tenders and other data should clarify which manufacturers will not benefit from optimising energy efficiency of their delivered products for the project. For example, strong price competition often necessitates that manufacturers of plants use cheap components, minimise heat exchangers, etc. which will result in increased lifetime operating costs of the plant
- on the other hand, identifying energy efficiency as a key factor in the tendering process for new plants and installations, or for rebuilds, (and weighting it accordingly) will promote the most energy efficient options(s).

It is important to stress that the EED work is often multi-disciplinary and that the energy expert (independent or internal) should not only be technically capable but should have significant experience in working with complex organisations and with complex technical problems.

Applicability

The application of energy efficient design (EED) has proved to be one of the most cost-efficient and attractive ways to improve energy efficiency in industry as well as in other major energy consuming sectors. EED has been applied successfully in most industrial sectors and savings have been introduced at installation level, in process units and utility systems.

An important barrier against success is that manufacturers (particularly those in non-energy intensive industries) are often conservative or unwilling to change a well-proven standard design and/or to update product guarantees, etc. On the other hand, it is often impossible to determine all the consequences of change, such as to quality and throughput. Certain management systems, such as TQM (total quality management) prevent the manufacturer making changes which may affect product quality.

It is important that the EED work is initiated in the early stages of the conceptual design work and is organised well in order to avoid time delays in the planning and design process.

Even though EED basically will focus on well-known technologies and principles, new technology or more complex solutions are often introduced. This must be considered as a risk seen from the client's perspective.

The energy intensive industries (such as chemicals, refineries, waste incineration, steel making) made the following points regarding the use of an energy efficiency design expert independent to the design organisation:

- energy intensive industries have in-house staff experts in energy efficient design. A major reason for this is competition and the need for confidentiality of the designs and therefore this restricts the use of external experts
- energy efficiency can form part of the tender specifications for equipment manufacturers and suppliers (ENE should form part of the tendering specifications, see risk assessment of tenders, in Operational data, above). Manufacturers may therefore be sensitive to energy efficiency and regularly benchmark their products
- in tendering processes for complex plants and systems where energy use or production are critical, the tenders are usually assessed by energy experts on the customer side.

Economics

The fee for an independent energy expert may be of the magnitude 0.2 to 1 % of the planned investment, depending on the magnitude and character of the energy consumption. It is difficult to assess the cost where EED is carried out by a manufacturer of a process plant installation or by an in-house team.

In many cases, in addition to energy savings, the EED process results in lower investments, as fundamental energy services can be minimised (such as cooling, heating, CAS, etc.).

It has been demonstrated that a well-designed process plant often has a higher capacity than a traditionally designed plant as key equipment, such as heat exchangers, etc. have more capacity in order to minimise energy losses.

Driving force for implementation

The primary drivers for EED are:

- lower operational costs
- application of new technology (an opportunity to implement BAT)
- well-designed plants due to better design practice and data.

There may also be benefits in increased throughput, reduced waste, improved product quality (see Section 2.3.1).

Examples

A number (10) of official Danish pilot projects have been reported, for example:

- a new abattoir at Danish Crown, Horsens, Denmark (www.danishcrown.com). This abattoir is the largest in the EU-25, and the operator had extensive expertise in energy management, as this was a significant operating cost. However, subjecting the initial project design to an external energy efficient design process identified additional lifetime energy savings of over 30 %
- a new ready meal factory at Danpo, Farre, Denmark (www.danpo.dk)
- a new ingredients plant at Chr. Hansen, Avedøre Holme, Denmark (www.chrhansen.com)

Official reports (in Danish) on these projects are available from the Danish Energy Agency (www.ens.dk).

Animal housing design is included in the BAT for energy efficiency in the IRPP BREF [173, EIPPCB, 2003].

- a new potato starch plant, Karup Kartoffelmelfabrik, Denmark (an EU LIFE project).

An EED project carried out externally for a pharmaceutical company in Ireland identified lifetime energy savings of 64 %. Unfortunately, the EED process was started too late to include all the measures, although about half the potential savings were realised.

Reference information

The Organisation of Consulting Engineers (FRI) has carried out a comprehensive study to develop methodologies and guidelines in the area of energy efficient design. This material (in Danish) can be ordered from www.frinet.dk.

The Danish Agreements Scheme has described a number of cases as well as methodologies to be followed by major energy consuming industries (in Danish), see www.end.dk. [172, Maagøe Petersen, 2006]

IRPP BREF, Sections 5.2.4 and Section 5.3.4.

Potato starch project reference: LIFE04ENV/DK/67 [174, EC, 2007]

<http://ec.europa.eu/environment/life/project/Projects/>

2.3.1 Selection of process technology

Description

The selection of an energy efficient process technology is a key part of energy efficiency design which merits highlighting, as the selection of a process technology can usually only be considered for a new build or major upgrade. In many cases, this may be the only opportunity to implement the most effective energy savings options. It is good practice to consider technological developments in the process concerned (see Section 2.1(k)).

It is difficult to generalise about the selection of process technologies across the range of IPPC sectors, so four diverse industries are illustrated below, in Examples.

Broadly, there are various options for changing process technology:

- change the process science
- change the process equipment
- changing both equipment and science.

There may be more than one process step using different technologies, e.g. intermediates may be created which are then subsequently processed further. One or more of these steps may be changed when building a new plant or significantly upgrading. Best results are usually achieved when the whole process is replaced, enabling new routes to the end product to be considered.

Achieved environmental benefits

Dependent on the process: changing the process can deliver significant energy savings, and may also reduce wastes and/or decrease the hazardous content, reduce other emissions such as solvents, etc. See Examples.

Cross-media effects

Dependent on the process. See Examples.

Operational data

Dependent on the process. See Examples.

Applicability

Dependent on the installation. See Examples.

Economics

Dependent on the process. See Examples.

Driving force for implementation

Dependent on the process: this may include cost reduction, higher yields, higher product quality (e.g. stereospecificity), fewer by-products, lower toxicity of wastes, etc.

For catalysts:

- the need for selectivity of products in some cases
- some reactions cannot occur without a catalyst (although a reaction may be feasible from thermodynamic calculations).

Examples

Examples in Annex 7.5 are:

1. The use of catalysis in chemical reactions. Catalysts may lower the activation energy and, depending on the reaction, may reduce the heat energy input required. Catalysts have been used for many years, but research is still active in all areas. Currently, there is major interest in biotechnological approaches (such as biocatalysis), and its role in the production of organic chemicals, pharmaceuticals, biofuels, etc. Annex 7.5, Example 1: The enzymatic production of acrylamide (Mitsubishi Rayon, Japan).
2. The use of radiation cured ink or paint systems in place of conventional solvent-based systems Annex 7.5, Example 2
3. The use of heat recovery with under floor heating systems for housing livestock farming Annex 7.5, Example 3.

A further example is a new potato starch plant, Karup Kartoffelmelfabrik, Denmark (an EU LIFE project).

Reference information

[164, OECD, 2001, 173, EIPPCB, 2003, 175, Saunders_R., 2006]
 Potato starch project reference: LIFE04ENV/DK/67 [174, EC, 2007];
<http://ec.europa.eu/environment/life/project/Projects/>
 [257, Clark, 2006]

2.4 Increased process integration

Description

Intensifying the use of energy and raw materials by optimising their use between more than one process or system.

This is site- and process-specific, but is illustrated in Examples (below).

Achieved environmental benefits

These are one or more of the following:

- improved energy efficiency
- improved material efficiency including raw materials, water (such as cooling water and demineralised water) and other utilities
- reduced emissions to air, soil (e.g. landfill) and water.

Other benefits are site-dependent.

Cross-media effects

None believed to be likely.

Operational data

No information provided.

Applicability

Generally applicable, especially applicable where processes are already interdependent. However, the options for improvement will depend on the particular case.

On an integrated site, it has to be considered that changes in one plant might affect the operating parameters of other plants. This applies also to changes with environmental driving forces.

Driving force for implementation

- cost benefits
- other benefits are site-dependent.

Economics

Cost benefits from savings in energy and other raw materials will be case dependent.

Examples

1. Grande Paroisse, Rouen, France achieved savings in operational costs of more than EUR 1000 000/year. In the example plant (see the LVIC-AAF BREF, Section 1.4.1), the integration of the nitric acid and AN plants has been increased (AN: ammonium nitrate (NH_4NO_3)). The following measures have been realised:

- gaseous (superheated) NH_3 is a common raw material. Both plants can share one NH_3 vapouriser. Operated with process steam from the AN plant
- low pressure steam available in the AN plant can be used to heat the boiler feed-water (BFW) from 43 to about 100 °C through two heat exchangers
- the hot BFW can then also be used to preheat the tail gas of the nitric acid plant
- process condensate from the AN plant is recycled to the absorption column of the nitric acid plant.

This resulted in:

- improved energy efficiency
- less consumption of demineralised water
- lower investment by using a common ammonia vaporiser.

2. New potato starch plant, Karup Kartoffelmelfabrik, Denmark (an EU LIFE project).

Reference information

[154, Columbia_Encyclopedia] [221, Yang W., 25 May 2005,]

Potato starch project reference: LIFE04ENV/DK/67 [174, EC, 2007];

<http://ec.europa.eu/environment/life/project/Projects/>

2.5 Maintaining the impetus of energy efficiency initiatives

Description

Several problems with maintaining the impetus and delivery of energy efficiency programmes have been identified. There is a need to see whether savings in energy efficiency due to adoption of a new technology or technique are sustained over time. No account is taken of 'slippage' through inefficient operation or maintenance of equipment, etc.

Problems identified include (some of the techniques to overcome these problems are described in other sections, noted below):

- the evolution of strategies can be seen in terms of a life cycle, where strategies mature. They need to be reviewed (after sufficient time has passed to enable the efficiency of strategies to be assessed: this may be after several years) to ensure they remain appropriate in terms of the target audience and the intervention method
- energy efficiency indicators may still be under development in some areas (see Section 1.3.3 for details of the difficulties)
- energy efficiency management and promotion is difficult where no proper metering tools exist
- while the ENE of equipment and units can be monitored reasonably well, exact ENE indicators for integrated systems are a problem: many factors contribute the measurement simultaneously and difficulties exist in defining the boundary for measurement (see Sections 1.4 and 1.5)
- energy efficiency is often seen as a fixed cost or overhead, and often with a different budget line (or budget centre) to production
- there is a need for maintenance activity within the strategy to ensure the appropriateness and content of communications, by updating information and monitoring the impact. This can include the use of interactive methods of communication, etc. (see Section 2.7)
- sustaining ENE savings and the maintenance of good practice to the extent of embedding it in the culture (of an installation)
- 'staleness' from a management perspective affects the enthusiasm with which dissemination occurs (see also Sections 2.6 and 2.7)
- training and continuing development at all staff levels (see also Section 2.6)
- technological developments (see Sections 2.2.1, 2.2.2, 2.3, etc.).

Techniques that may add impetus to energy efficiency programmes are:

- implementing a specific energy efficiency management system (see Section 2.1)
- accounting for energy usage based on real (metered) values and not estimates or fixed parts of whole site usage. This places both the onus and credit for energy efficiency on the user/bill payer (see Sections 2.10.3 and 2.15.2)

- creating energy efficiency as a profit centre in the company (as a team or budget centre), so that investments and energy savings (or energy cost reduction) are in the same budget and people responsible for energy efficiency can demonstrate to top management that they create profits to the company. Energy efficiency investments can be demonstrated as equivalent to additional sales of the goods produced (see Examples, below)
- having a fresh look at existing systems, such as using 'operational excellence' (described in Examples, below)
- rewarding the results of the application of best practices or BAT
- using change management techniques (also a feature of 'operational excellence'). It is a natural human trait to resist change unless a benefit can be shown to the person implementing the change. Calculating the benefits of options (online or off-line, e.g. what-if scenarios) that can be demonstrated to be reliable, and communicating them effectively can contribute to motivating the necessary change(s). For an example of data provision, see Section 2.15.2.

Achieved environmental benefits

Operational excellence: maintained or improved impetus to energy efficiency programmes. As it is holistic, it also improves the application of other environmental measures.

Cross-media effects

None.

Operational data

See Description and Examples.

Applicability

The techniques to be considered are dependent on the type and size of the installation. For example:

- an ENEMS is suitable in all cases (see Section 2.1) although, again, the complexity is proportional to the size and type of site
- suitable training can be found for all types of installation (see Section 2.6)
- the cost of independent advice on ENEP programmes, particularly for SMEs, may be subsidised by public authorities in MSs (see Section 2.6)
- operational excellence has been used successfully in large, multi-site companies
- the principles of ENEMS and operational excellence are widely applicable.

Targeting energy efficiency on too narrow a scale may be in conflict with the site efficiency and resulting in sub-optimisation (such as in the techniques listed above, direct metering on a user basis).

Economics

- see Examples. For ENEMS, see Section 2.1.
- for operational excellence, low capital investment, realising significant returns.

Driving force for implementation

Cost saving. As it is holistic, it also improves the application of other production control measures, resulting in reduced waste, and reduced cycle times, etc.

Examples*Operational Excellence*

Operational excellence (also known as OpX), is a holistic approach to the systematic management of safety, health, environment, reliability and efficiency. It integrates operations management methodologies such as lean manufacturing and six sigma with change management to optimise how people, equipment and processes function together. It is associated with statements such as 'the state or condition of superiority in operations and execution of business processes', and 'to achieve world class performance'.

It is the continual refinement of critical operation processes, and focuses on reducing waste and cycle time through a mixture of techniques, such as 5-S methodology, Error-proofing, QFD, SPD, etc.

The steps taken are those identified in ENEMS (see Section 2.1), with an emphasis on:

- determining best practice (the goals that operations teams are striving for in performing a particular process at a level of excellence)
- detailed descriptions of each operational best practice (including changes and improvements)
- identifying the metrics required to measure operation performance levels
- the key skills operational personnel must be able to perform the process.

Key features are making use of in-house expertise, including that from other units (or associated companies), forming ad hoc teams to identify best working practices, work with staff in other non-optimised units, etc.

Examples for ENEMS are given in Annex 7.4.

Creating a budget or profit centre for energy efficiency

An example of demonstrating energy efficiency as a profit centre in a company showed that adding a variable speed driver (VSD) to a large pump was equal to expanding sales by 11 %.

Reference information

[176, Boden_M., 2007, 177, Beacock, 2007, 227, TWG]

2.6 Maintaining expertise – human resources**Description**

This factor is identified in Sections 2.1(d)(i) and (ii). The levels of skilled staff in virtually all European installations have been reduced over recent decades. Existing staff may be required to multi-task and cover a range of tasks and equipment. While this may cover normal operations and retain expertise in some areas, over time it may reduce specialist knowledge of individual systems (e.g. CAS) or specialities, such as energy management, and reduce the staff resource to carry out non-routine work, such as energy audits and follow-up investigations.

Training activity has been identified as an important factor in implementing energy efficiency programmes and embedding energy efficiency in the organisational culture and includes:

- higher and professional education curricula
- training opportunities associated with specific skills and vocational areas, and ad hoc training possibilities across professional, managerial, administrative and technical areas
- continuing development in the energy management area: all managerial staff should have an awareness of energy efficiency, not just the co-opted energy managers.

'Staleness' from a management perspective also influences the enthusiasm with which energy efficiency dissemination occurs and human resource mechanisms can achieve positive changes. These might include rotation, secondments, further training, etc.

In order to deliver energy savings, operators may need additional resources in both staff numbers and skills.

This can be achieved through one or more of several options, such as:

- recruitment and/or training of permanent staff
- taking staff off-line periodically to perform fixed term/specific investigations (in their original installation or in others, see Examples below and Section 2.5)
- sharing in-house resources between sites (see Examples below and Section 2.5)
- use of appropriately skilled consultants for fixed term investigations
- outsourcing specialist systems and/or functions (see Section 7.12).

Training can be delivered by in-house staff, by external experts, by formal courses or by self-study or -development (an individual maintaining and developing their own professional skills). A large amount of information is available in MSs at national and local levels, as well as through the internet (for example, see links and references in this document, and E-learning, below). Data are also provided to various sectors and relevant trade organisations, professional organisations or other MS organisations, e.g. for ENE intensive livestock farming, information may be obtainable from the agricultural ministry.

E-learning for energy management and energy efficiency issues in the industrial sector is still developing. There are a few existing and operational sites throughout the world which offer a comprehensive guide on matters like energy management, energy efficiency, best practices, energy audits, energy benchmarking and checklists. The sites may usually offer training in one or more of these topics, or may be aimed at non-industrial users (e.g. commerce, SMEs, householders). Often data can be found on specific topic areas (e.g. steam, LVAC, intensive pig rearing), rather than searching for generic guidance or learning material on energy savings or efficiency.

A training course leading to the EUREM qualification (European Energy Manager, Production) is a project realised in the framework of the SAVE programme, and after a successful pilot project, the project has been extended.

Achieved environmental benefits

Enables the delivery of energy efficiency.

Cross-media effects

None identified.

Operational data

No data submitted.

Applicability

Applicable at all sites. The amount and type of training will depend on the type of industry and the size and complexity of the installation, and there are options suitable for small installations. It is worth noting that even sites achieving high levels of energy efficiency have benefited from additional resources (see Section 2.5).

Economics

Cost of additional staff or consultants. Some MSs have energy savings initiatives where independent energy efficiency advice and/or investigations are subsidised (see Annex 7.13), particularly for SMEs. See EUREM, in Examples, below.

Driving force for implementation

Unrealised cost savings, even in efficient organisations.

Examples

There are many examples where outside experts are brought in to supplement internal resources, see Reference information, such as Atrium Hospital, Heerleen, NL, Honeywell (see Annex 7.7.2)

The EUREM pilot project trained 54 participants in four countries (DE, AT, UK, and PT). The course comprised about 140 hours of lessons, plus about 60 hours of self-study via the internet and a feasibility study. In Germany (Nuremberg) the course was 6 months' tuition (Fridays and Saturdays every 2 or 3 weeks), and 3 to 4 months project work. Costs depend on the country and facilities available: about EUR 2100 in Germany and EUR 2300 in Austria. (Data given specific to 2005 – 2006). The achievements in ENE from this project are shown in Table 2.4.

Achievement	Planned	Achieved
Energy savings per participant	400 MWh/year	1280 MWh/year
Cost savings per participant	EUR 16000/yr	EUR 73286/yr
Average payback period (on investment required)	-	3.8 years
Average payback (of direct cost of course, based on 230 work days/yr)		33 times training cost (7 working days)

Table 2.4: EUREM pilot project: savings per participant

E-learning

Some free examples are:

- US EPA and DOE joint programme:
 - http://www.energystar.gov/index.cfm?c=business.bus_internet_presentations
- UK resource:
 - <http://www.create.org.uk/>

Others are fee-paying and may be part-funded by national agencies, e.g:

- <http://www.greenmatters.org.uk/>
- <http://www.etctr.com/eetp/home.htm>

Reference information

[161, S EI, 2006, 176, Boden_M., 2007, 179, S tijns, 2005, 180, Ankirchner, 2007, 188, Carbon_Trust_(UK), 2005, 227, TWG] [261, Carbon_Trust_UK, 2005], a t <http://www.thepigsite.com/articles/5/housing-and-environment/1408/energy-use-in-pig-farming>

2.7 Communication

Description

Communication is an important tool in achieving motivation that modern companies can use to assist implementation of many kinds of issues. It is important to inform staff about energy efficiency and systematically support, encourage and motivate them to contribute to energy efficiency by conserving energy, preventing unnecessary consumption, working efficiently (see Sections 2.5 and 2.6). Good practices ensure efficient two-way internal communication about the efforts to achieve energy efficiency and should enable staff to make recommendations and observations, etc. to assist in achieving ENE.

Communication should provide feedback to staff about company (and/or their individual unit) performance and should be used positively to show recognition of achievers. Well structured communication delivers the flow of goal/commitment information as well as the achieved results.

There are various possible means of communication, such as newsletters, newspapers, bulletins, posters, team briefings, specific energy meetings, etc. These may include using existing company communication channels to carry energy efficiency data. The data should include specific energy consumption numbers (daily, weekly, monthly, and/or yearly) over time or in correlation with relevant important parameters, e.g. production rate, weather conditions (see Sections 1.4 and 1.51). These may be combined with success stories in periodically published reports. Graphics are an excellent way to provide information, including various types of charts, giving ENE achievements over time, or by comparing various units within the company or between sites, etc (e.g. see Section 2.2.1).

Communication is important not only between management (seeking to achieve targets) and staff who work to achieve them, but also horizontally between different groups of professionals within a company, e.g. those responsible for energy management, for design, operation, planning and finance (see Section 2.2.1). Section 2.7.1 gives an example of a useful technique for demonstrating energy flows.

Communication is also used to encourage the exchange of information with other companies, to swap best practice ideas, and to pass success stories from one company to another, etc.

Communication and motivation may include:

- involving all staff in an individual company
- involving several companies from the same sector in a working group (energy networking) to exchange experiences has proven to be useful (or within different units within the same company). The companies should all be at the same level of energy management implementation. Networking is especially useful for solving typical difficulties such as defining an energy efficiency indicator or setting up an energy monitoring system. Networking may also introduce an element of competition in energy efficiency and provide a platform for negotiation with potential energy efficient equipment or service suppliers
- making positive effects clearly visible, for example by making awards for best practices, innovation and best achievements.

Achieved environmental benefits

Contributes to energy efficiency.

Cross-media effects

None thought to be likely.

Operational data

In many organisations, there is a large information flow from many different areas, e.g. health and safety, production efficiency, operating practices, financial performance. Many staff complain of 'information overload'. Communication therefore needs to be effective and fresh. Communication techniques may need changing periodically, and data (such as posters) need to be kept up to date.

Applicability

Communication is applicable to all installations. The type and complexity will vary according to the site, e.g. in a small installation, face-to-face briefings presenting data may be suitable; large organisations often produce in-house newspapers.

Economics

Depends on sophistication of approach and existing channels. Can be cheap, and ensuring staff assist in implementing ENE may ensure significant paybacks.

Driving force for implementation

Helps to communicate energy efficiency data and secure cost savings, etc.

Examples

Widely used.

Reference information

[249, TWG, 2007]

2.7.1 Sankey diagrams**Description**

Sankey diagrams are a specific type of flow diagram, in which the width of the arrows shown are proportional to the flow quantity. They are a graphical representation of flows such as energy or material transfers in process systems or between processes.

They visually explain energy and mass flow data (and can be used to show financial flow data), and are particularly useful for communicating data rapidly, especially between staff of different professional backgrounds.

Sankey diagrams assist with communication and motivation of staff (see Section 2.1) and maintain the impetus of energy efficiency initiatives (Section 2.5).

Inexpensive software can assist with manipulating data into diagram format from sources such as spreadsheets.

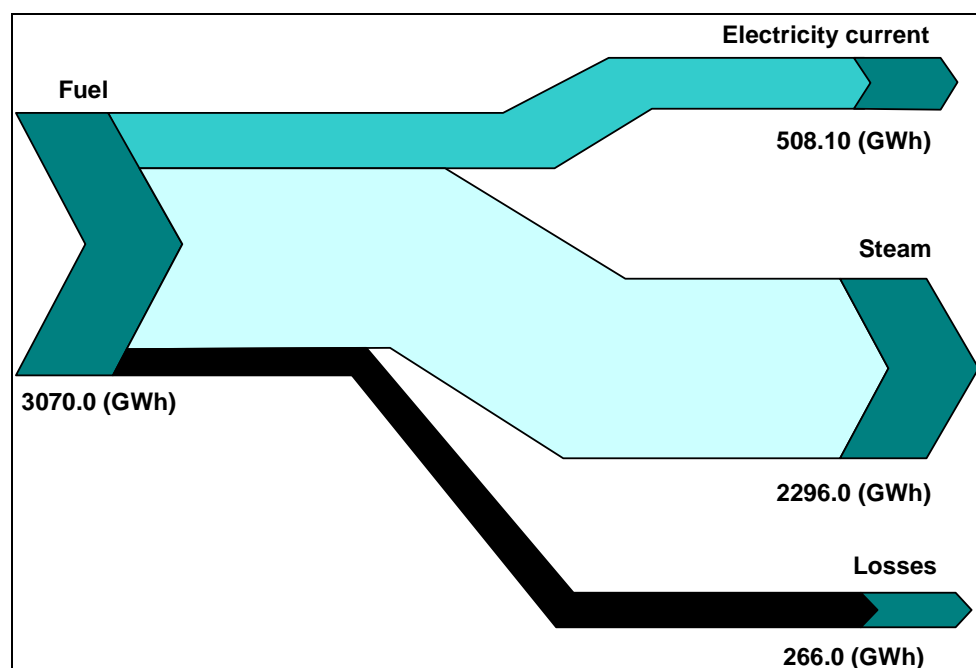

Figure 2.7: Sankey diagram: fuel and losses in a typical factory
[186, UBA_AT]

Achieved environmental benefits

Improves communication of ENE issues.

Cross-media effects

None known.

Operational data

See Description.

Applicability

All installations which need to demonstrate energy flows.

Economics

Low cost.

Driving force for implementation

Helps to communicate energy efficiency data.

Examples

Widely used.

Reference information

A free tool to create Sankey diagrams from MS Excel™ is available at: <http://www.doka.ch/sankey.htm>

[127, TWG, , 153, Wikipedia, , 186, UBA_AT]

2.8 Effective control of processes

2.8.1 Process control systems

Description

For good energy management, a proper process control and utility control system is essential. A control system is part of the overall monitoring (see Sections 2.10 and 2.15).

Automation of a manufacturing facility involves the design and construction of a control system, requiring sensors, instruments, computers and the application of data processing. It is widely recognised that automation of manufacturing processes is important not only to improve product quality and workplace safety, but also to increase the efficiency of the process itself and contribute to energy efficiency.

Efficient process control includes:

- adequate control of processes under all modes of operation, i.e. preparation, start-up, routine operation, shutdown and abnormal conditions
- identifying the key performance indicators and methods for measuring and controlling these parameters (e.g. flow, pressure, temperature, composition and quantity)
- documenting and analysing abnormal operating conditions to identify the root causes and then addressing these to ensure that events do not recur (this can be facilitated by a 'no-blame' culture where the identification of causes is more important than apportioning blame to individuals).

Planning

There are several factors that are considered in the design of a control system. An initial analysis of the particular process system may reveal existing restrictions to the effectiveness of the process, as well as alternative approaches that may achieve similar or better results.

Furthermore, it is necessary to identify the levels of performance in terms of product quality, regulatory requirements and safety in the workplace. The control system must be reliable and user-friendly, i.e. easy to operate and maintain.

Data management and data processing are also factors that must be considered in the design of the control system.

The control system should balance the need for accuracy, consistency and flexibility required to increase the overall efficiency of the manufacturing process against the need to control the costs of production.

If the control system is specified sensibly, the production line will run smoothly. Under-specification or over-specification will inevitably lead to higher operating costs and/or delays in production.

To optimise the performance of a process system:

- the specifications provided for the control system at each step in the process should be accurate and complete, with attention paid to realistic input tolerances
- the engineer responsible for the design of the control system should be familiar with the total process and able to communicate with the equipment manufacturer
- a balance must be established, i.e. ask whether it is necessary to implement sophisticated process control technology or whether a simple solution will suffice.

Modern process control systems refer to a set of techniques that can be used to improve process performance, including energy efficiency. The techniques include:

- conventional and advanced controls
- optimising, scheduling and performance management techniques.

Integrated in the conventional controls are:

- proportional-integral-derivative (PID) control
- dead-time compensation and
- cascade control.

Integrated in the advanced controls are:

- model-based predictive controls (MBPC)
- adaptive controls
- fuzzy controls.

Integrated in the performance management techniques are (see Section 2.8):

- monitoring and targeting
- statistical process controls
- expert systems.

The performance monitoring techniques can be used to demonstrate improved performance, achievement of targets and compliance with environmental regulations, including IPPC permits.

The programmable logic controller (PLC) is the brain of the control system. It is a small, industrialised computer that operates reliably in the environment of a manufacturing facility. Building blocks of a control system are a variety of sensors, intelligent valves, programmable logic controllers and central supervisory control and data acquisition (SCADA) systems.

These components are then linked to a manufacturing process system which allows each function of that system to operate with a high degree of accuracy. Automation – the incorporation of the control system into a process system – effectively reduces the labour involved in the operation of this complex equipment and provides a reliable and consistent performance.

The PLC looks at digital and analogue sensors and switches (the inputs), reads the control program, makes mathematical calculations and, as a result, controls various hardware (the outputs) such as valves, lights relays and servo-motors, all in a time frame of milliseconds.

The PLC is capable of exchanging information with operator interfaces such as human machine interfaces (HMI) and SCADA systems on the factory floor. Data exchange at the business level of the facility (the information services, accounting and scheduling) usually requires interaction with a separate SCADA package.

Data treatment

The operational data are collected and treated by an infrastructure which usually integrates the sensors and instrumentation on the plant, as well as final control elements such as valves and also includes programmable logic controllers, SCADA and distributed control systems. All together these systems can provide timely and usable data to other computing systems as well as to operators/engineers.

Supervisory control and data acquisition systems enable the design engineer to implement data collection and archiving capabilities in a given control system. In addition, the SCADA system allows more complex forms of control to be introduced, e.g. statistical processes (see Section 2.8.2).

SCADA has been an integral part of the design of a control system, providing the user with a ‘real time window’ into the process. A SCADA system can also be designed to provide a user at a remote location with the same access to the particular process as an operator literally ‘standing in front of the equipment’.

Achieved environmental benefits

Reduced energy costs and environmental impact.

Cross-media effects

Small amounts of chemicals used in cleaning; possible loss of pressure in measurement devices (see Section 2.10.4).

Operational data

See Description, above.

Cleaning of measuring devices

The importance of the controls (and their accuracy) which are extensively used in the processing industries and incorporated into process systems cannot be overstated. There are a variety of instruments and measuring devices or sensors, e.g. resistors that are dependent upon temperature, pH probes, conductivity meters, flowmeters, timers, level sensors and alarms, which are in contact with fluids (liquid and gases) used in the process, and require regular cleaning to work effectively and accurately. This may be done manually, on a maintenance schedule, or as automated clean-in-place (CIP) systems.

A fully automated control system must provide variable times for rinse and drain cycles and for the recirculation of the different cleaning solutions. The system must also have the capability of changing the temperature, flowrates, composition and concentration of the cleaning solutions.

The main control unit is usually based upon PLC equipment, often as multiple panels to service operator stations and for valve and on/off termination. The process control system is critical to controlling or minimising hydraulic shock, a common problem in CIP units that can limit the useful life of the unit.

Correct sequencing or ‘pulsing’ is required to clean the valves, lip seals, o-rings and valve seats in the process equipment.

Applicability

Process control systems are applicable in all IPPC industries. They may range from timers, temperature controls, raw material feed controls (e.g. in small intensive farming units) to complex systems in, e.g. food, chemicals, mining and paper.

Economics

Case studies have demonstrated that benefits can be achieved cost effectively. Payback periods of one year or less are typical especially where a modern control and monitoring infrastructure, i.e. distributed control system (DCS) or supervisory control and data acquisition (SCADA) system is already in place. In some cases, payback periods of months or even weeks have been demonstrated.

Driving force for implementation

Increased throughput, improved safety, reduced maintenance/longer plant life, higher, more consistent quality and reduced manpower requirements.

The reduction of process costs and the rapid return of investments (as mentioned above) achieved in several plants contributed significantly to the implementation of these processes in other plants.

Example plants

Widely applied, for example in the industries listed below:

- food, drink and milk: British Sugar, Joshua Tetley, Ipswich, UK
- chemicals: BP Chemicals, Hull, UK; ICI Chemicals and Polymers, Middlesbrough, UK
- ferrous metals: Corus, Port Talbot, UK
- cement and lime: Blue Circle, Westbury, UK
- paper industry: Stora Enso Langerbrugge N.V., Gent, BE; SCA Hygiene Products GmbH, Mannheim, DE; SCA Hygiene Products GmbH, Pernitz, AT
- fluidised bed combustion: Rovaniemi Energy, Rovaniemi and Ahlomens Kraft, Pietarsaari, Finland; E.ON Kemsley, UK.

Reference information

[36, ADENE, 2005] [261, Carbon_Trust_UK, 2005]

2.8.2 Quality management (control, assurance) systems

Description

When a product is scrapped or reworked, the energy used in the original production process is wasted (as well as raw materials, labour and production capacity and other resources). Reworking may use disproportionately more energy (and other resources) than the original production process. Effective process control increases the amount of product(s) meeting production/customers' specifications and reduces the amount of energy wasted.

IPP installations usually involve large scale production and/or high volumes of throughput. Usually the products have to meet specifications for subsequent use. Quality assurance systems (QA) have been developed to ensure this, and are usually based on the PDCA (plan-do-check-act) approach (see Section 2.1).

Originally this was based on testing products, and accepting or rejecting, reworking and scrapping products that have already been through the whole production process. Statistical methods were developed (during the 1940s onwards) to set sampling and testing on a statistical basis to ensure a certain level of compliance with standards, e.g. 95 %, 3.4 failures per million in six sigma.

It was realised that a manufactured product has variation and this variation is affected by various process parameters. Statistical process control (SPC) was developed, and applied to control each parameter, and the final result tends to be a more controlled product. SPC can be very cost efficient, as it usually requires collection and charting data already available, assessing deviation of the process, and applying corrective action to maintain the process within predetermined control parameters (such as temperature, pressure, chemical concentration, colour, etc.).

At the same time, company-wide quality approaches were developed (quality management systems, QMS). These can be defined as a set of policies, processes and procedures required for planning and execution (production/development/service) in the core business area of an organisation. QMS integrates the various internal processes within the organisation and intends to provide a process approach for project execution. QMS enables the organisations to identify, measure, control and improve the various core business processes that will ultimately lead to improved business performance. The models for quality assurance are now defined by the international standards contained in the ISO 9000 series and the defined specifications for quality systems. Environmental management and energy management systems have been developed from the same systems approaches (see Section 2.1).

Achieved environmental benefits

Reduction in rejects and/or reworking which is a waste of the original energy input, and may require greater energy input for reworking (or decreased output from the batch).

Cross-media effects

None known.

Operational data

See Description, above.

Consultants and/or contractors are often used when introducing new quality practices and methodologies as, in some instances, the relevant skill-set and experience might not be available within the organisation. In addition, when new initiatives and improvements are required to bolster the current quality system, or perhaps improve upon the current manufacturing systems, the use of temporary consultants is an option when allocating resources.

The following arguments have been made for and against management systems:

- the parameters measured have to be relevant to achieving the required process or product quality, rather than just parameters that can easily be measured
- statistical methods such as six sigma are effective in what it is intended for, but are narrowly designed to fix an existing process and do not help in developing new products or disruptive technologies. The six sigma definition is also based on arbitrary standards, (it approximates to 3.4 defects per million items), which might work well for certain products/processes, but it might not be suitable for others
- the application of these approaches gain popularity in management circles, then lose it, with a life cycle in the form of a Gaussian distribution (e.g. see quality circles discussed in Examples, below)
- the term total quality management (TQM) created a positive utility, regardless of what managers meant by it. However, it lost this positive aspect and sometimes gained negative associations. Despite this, management concepts such as TQM and re-

engineering leave their traces, without explicit use of their names, as the core ideas can be valuable

- the loss of interest/perceived failure of such systems could be because systems such as ISO 9000 promote specification, control, and procedures rather than understanding and improvement, and can mislead companies into thinking certification means better quality. This may undermine the need for an organisation to set its own quality standards. Total, blind reliance on the specifications of ISO 9000 does not guarantee a successful quality system. The standard may be more prone to failure when a company is interested in certification before quality. This creates the risk of creating a paper system that does not influence the organisation for the better
- certification by an independent auditor is often seen as a problem area and has been criticised as a vehicle to increase consulting services. ISO itself advises that ISO 9000 can be implemented without certification, simply for the quality benefits that can be achieved.

Applicability

Quality management is applicable to all IPPC process industries. The type of system and level of complexity of the applied quality management systems will depend on the individual operation, and may be a customer requirement.

Economics

A common criticism of formal systems such as ISO 9000 is the amount of money, time and paperwork required for registration. Opponents claim that it is only for documentation. Proponents believe that if a company has already documented its quality systems, then most of the paperwork has already been completed.

Driving force for implementation

Proper quality management has been widely acknowledged to improve business, often having a positive effect on investment, market share, sales growth, sales margins, competitive advantage, and avoidance of litigation.

Examples

See Annex 7.4.

Process control engineering (Prozessleittechnik, Bayer AG, Germany, 1980) was developed as a working title covering the measurement, control, and electrical engineering groups. It is a statistics and engineering discipline that deals with architectures, mechanisms, and algorithms for controlling the output of a specific process.

More recent developments include:

- right first time
- six sigma: where the likelihood of an unexpected failure is confined to six standard deviations (where sigma is the standard deviation and equates to 3.4 defects per million)
- measurement systems analysis (MSA)
- failure mode and effects analysis (FMEA)
- advance product quality planning (APQP)
- total quality management (TQM).

Other tools used in SPC include cause and effect diagrams, check sheets, control charts, histograms, pareto charts, chatter diagrams, and stratification.

Another approach (which may be combined with the above) are quality circles. These are small groups of employees from the same work area who voluntarily meet at regular intervals to identify, analyse, and resolve work related problems. Quality circles have the advantage of continuity; the circle remains intact from project to project. These have been used in Japan and innovative companies in Scandinavian countries, although they are reported to no longer be in use.

Reference information

[163, Dow, 2005, 181, Wikipedia, , 182, Wikipedia, , 227, TWG, , 249, TWG, 2007]

Wikipedia gives many references discussing the positive and negative aspects of QA systems. Further information: e.g. American Society for Quality: www.asq.org

2.9 Maintenance

Description

Maintenance of all plants and equipment is essential and forms part of an ENEMS (see Section 2.1(d) (vii).

It is important to keep a maintenance schedule and record of all inspections and maintenance activities. Maintenance activities are given in the individual sections.

Modern preventative maintenance aims to keep the production and related processes usable during their whole operating life. The preventative maintenance programmes were traditionally kept on a card or planning boards, but are now readily managed using computer software. By flagging-up planned maintenance on a daily basis until it is completed, preventative maintenance software can help to ensure that no maintenance jobs are forgotten.

It is important that the software database and equipment file cards with technical data can be easily interfaced with other maintenance (and control) programmes. Such indicators as 'Maintenance in Process Industry' standards are often used for classifying and reporting work and producing supporting reports. The requirements of the ISO 9000 standards for maintenance can assist in specifying software.

Using software facilitates recording problems and producing statistical failure data, and their frequency of occurrence. Simulation tools can help with failure prediction and design of equipment.

Process operators should carry out local good housekeeping measures and help to focus unscheduled maintenance, such as:

- cleaning fouled surfaces and pipes
- ensuring that adjustable equipment is optimised (e.g. in printing presses)
- switching off equipment when not in use or not needed
- identifying and reporting leaks (e.g. compressed air, steam), broken equipment, fractured pipes, etc.
- requesting timely replacement of worn bearings.

Achieved environmental benefits

Energy savings. Reduction in noise (e.g. from worn bearings, escaping steam).

Cross-media effects

None envisaged.

Operational data

Preventative maintenance programmes are installation dependent. Leaks, broken equipment, worn bearings, etc. that affect or control energy usage, should be identified and rectified at the earliest opportunity.

Applicability

Generally applied.

Carrying out repairs promptly has to be balanced (where applicable) with maintaining the product quality and process stability and the health and safety issues of carrying out repairs on the operating plant (which may contain moving equipment, be hot, etc.).

Economics

Installation dependent.

Good housekeeping measures are low cost activities typically paid for from yearly revenue budgets of managers and do not require capital investments.

Driving forces for implementation

Generally accepted to increase plant reliability, reduce breakdown time, increase throughput, assist with higher quality.

Examples

Widely applied in all sectors.

Reference information

Several BREFs, [125, EIPPCB, , 159, EIPPCB, 2006, 254, EIPPCB, 2005, 267, EIPPCB, 2006].

2.10 Monitoring and measurement

Monitoring and measurement are an essential part of checking in an ENEMS (see Section 2.1(f)(i)), a step they are in every ‘plan-do-check-act’ management system. This section discusses some possible techniques to measure, calculate and monitor key characteristics of operation and activities that can have a significant impact on energy efficiency. Section 2.15.1 also discusses the collection of data, databases and automation of the control systems and equipment, particularly several interconnected systems, to optimise their use of energy.

Measurement and monitoring are likely to form part of process control (see Section 2.8) as well as auditing (see Section 2.11). Measurement is important to be able to acquire reliable and traceable information on the issues which influence energy efficiency, both in terms of the amounts (MWh, kg steam, etc.) but also the qualities (temperature, pressure, etc.), according to the vector (steam, hot water, cooling, etc.). For some vectors, it may be equally important to know the parameters of the energy vector in the return circuits or waste discharges (e.g. waste gases, cooling water discharges) to enable energy analyses and balances to be made, etc. (see Examples in Section 2.12).

A key aspect of monitoring and measurement is to enable cost accounting to be based on real energy consumptions, and not on arbitrary or estimated values (which may be out of date). This provides the impetus to change for the improvement of energy efficiency. However, in existing plants it can be difficult to implement new monitoring devices e.g. it may be difficult to find the required long pipe runs to provide low non-turbulence areas for flow measurement. In such cases, or where the energy consumptions of the equipment or activity are proportionately small (relative to the larger system or in stallation they are contained within), estimations or calculations may still be used.

This section does not discuss documentation or other procedures required by any energy efficiency management system.

In addition, material flows are often measured for process control, and these data can be used to establish energy efficiency indicators, etc. (see Section 1.4).

2.10.1 Indirect measurement techniques

Description

Infrared scanning of heavy machinery provides photographic proof of hot spots that cause energy drains and unnecessary stress on moving parts. This may be used as part of an audit.

Critical equipment affecting energy usage, e.g. bearings, capacitors (see Section 3.5.1) and other equipment may have the operating temperature monitored continuously or at regular intervals: when the bearing or capacitance starts to breakdown, the temperature of the casing rises.

Other measurements can be made of other changes in energy losses, such as an increase in noise, etc.

Achieved environmental benefits

Energy saving.

Cross-media effects

None known.

Operational data

See Description, above.

Applicability

Widely used.

Economics

Case dependent.

Driving force for implementation

As part of preventative maintenance:

- avoids unexpected plant shutdown
- enables planned replacement
- extends life of equipment, etc.

Examples

- Widely used, e.g. Aughinish Alumina (AAL), Ireland.
- See Sections 3.2, 3.7, etc.

Reference information

[161, S EI, 2006, 183, Bovankovich, 2007] [55, Best practice programme, 1998, 56, Best practice programme, 1996, 98, Sitny, 2006]

2.10.2 Estimates and calculation

Description

Estimations and calculations of energy consumption can be made for equipment and systems, usually based on manufacturers' or designers' specifications. Often, calculations are based on an easily measured parameter, such as hours-run meters on motors and pumps. However, in such cases, other parameters, such as the load or head and rpm will need to be known (or calculated), as this has a direct effect on the energy consumption. The equipment manufacturer will usually supply this information.

A wide variety of calculators are available on the internet (see Reference information, below, and in specific sections in this documents). These are usually aimed at assessing energy savings for various equipment.

Achieved environmental benefits

Assists in identifying and achieving energy savings.

Cross-media effects

None known.

Operational data

See Description, above.

Applicability

Widely used. The application of calculators should be considered against the possible cost savings of more accurate measuring or metering, even on a temporary basis.

Care should be taken with online calculators:

- their function may be to compare the cost of utilities from different suppliers
- the advice in Section 2.2.2 is important: the whole system the equipment is used in must be considered first, rather than an individual piece of equipment
- the online calculators may be too simplistic, and not take account of loading, head, etc. (see Description, above).

A problem with estimates and calculations is that they may be used repeatedly, year-on-year, and the original basis may become lost, void or unknown. This may lead to expensive errors (See Examples in Annex 7.7.1). The basis of calculations should be reviewed regularly.

Economics

Requires no investment in equipment; however, staff time in performing accurate calculations should be considered, as should the cost-risk from errors.

Driving force for implementation

Cost saving.

Examples

Widely used. For examples of calculators online, see Reference information, below.

Reference information

[270, Tempany, 2008]

The following were found with an internet search for 'industrial energy efficiency, calculators' and have not been validated (note: these sites may change over time or cease to exist):

- calculators online centre. A large list of energy calculators:
http://www.martindalecenter.com/Calculators1A_4_Util.html
- the following site is designed as a guide for plant managers of small to medium sized manufacturing plants to estimate the potential energy and monetary savings of an energy conservation measure:
<http://www.ceere.org/iac/assessment%20tool/index.html>
- energy calculators and benchmarking tools:
<http://energypathfinder.blogspot.com/2007/02/energy-calculators-and-benchmarking.html>
- general business, lighting, equipment, office equipment:
http://www1.eere.energy.gov/femp/procurement/eep_eccalculators.html
- VSD calculators: fans, pumps, hot/chilled water, cooling tower fan:
<http://www.alliantenergy.com/docs/groups/public/documents/pub/p010794.hcsp>

- illumination:
http://www1.eere.energy.gov/femp/procurement/eep_hid_lumen.html
- boilers, HVAC, lighting, VSD:
<http://www.alliantenergy.com/docs/groups/public/documents/pub/p013446.hcsp>
- gigajoule and energy intensity calculator:
<http://oee.nrcan.gc.ca/commercial/technical-info/tools/gigajoule.cfm?attr=20>
- boiler efficiency:
<http://oee.nrcan.gc.ca/industrial/technical-info/tools/boilers/index.cfm?attr=24>
- heat losses, industrial buildings:
<http://www.energyideas.org/default.cfm?o=h,g.ds&c=z,z,2633>

2.10.3 Metering and advanced metering systems

Description

Traditional utility meters simply measure the amount of an energy vector used in an installation, activity, or system. They are used to generate energy bills for industrial installations, and generally are read manually. However, modern technological advances result in cheaper meters, which can be installed without interrupting the energy supply (when installed with split-core current sensors) and require far less space than older meters.

Advanced metering infrastructure (AMI) or advanced metering management (AMM) refers to systems that measure, collect and analyse energy usage, from advanced devices such as electricity meters, gas meters, and/or water meters, through to various communication media on request or on a pre-defined schedule. This infrastructure includes hardware and software, for communications, customer associated systems and meter data management.

Energy account centres are the units at the site where energy usage can be related to a production variable such as throughput (see Section 1.4). An example of a structure of an advanced metering system is shown in Figure 2.8.

An advanced metering system is essential to automated energy management systems, see Sections 2.15 and 2.15.2.

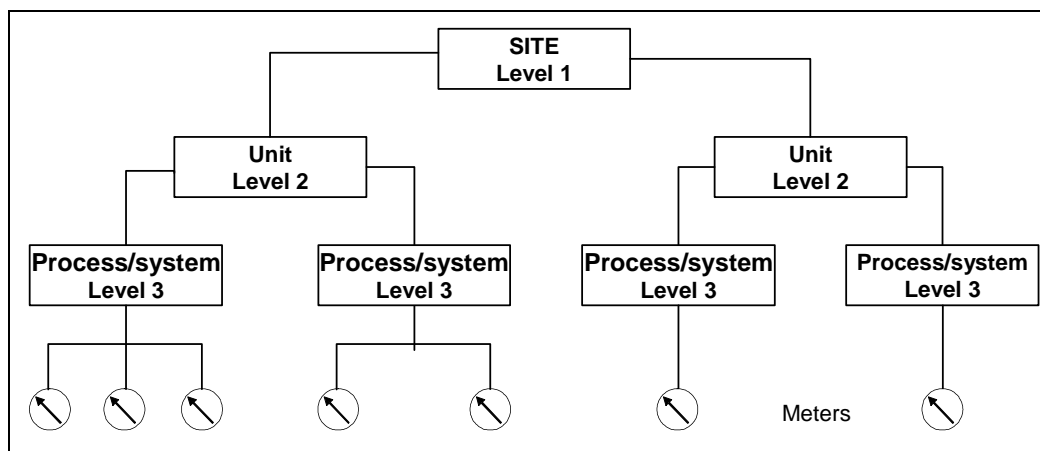

Figure 2.8: Structure of an advanced metering system [98, Sitny, 2006]

Achieved environmental benefits

Better control of energy usage.

Cross-media effects

None.

Operational data

Enables accurate measurement energy usage to energy account centres, within an installation, with specific units and systems.

Applicability

Where there are more than one unit system using energy.

Several studies show a major reason for energy efficiency techniques not being implemented is that individual unit managers are not able to identify and control their own energy costs. They therefore do not benefit from any actions they implement.

Economics

Allocation of costs on a usage basis.

Driving force for implementation

See Economics.

Examples

See Annex 7.7.1.

Reference information

[183, B ovankovich, 2007] S chott glass: [127, T WG] A trium H ospital, H eerleen, NL [179, Stijns, 2005]

2.10.4 Low pressure drop flow measurement in pipework**Description**

Flow measurement is used in fluids such as liquid and gaseous raw materials and products, water (raw water, boiler and process waters, etc), steam, etc. Flows are usually measured by an artificially induced pressure drop across an orifice plate, a venturi or pitot tube, or by an inductive flow meter. Traditionally, this results in a permanent pressure drop, particularly for orifice plates and venture, i.e. loss in energy in the system.

A new generation of flow measurement devices reduce the pressure losses significantly, with increased accuracy.

Ultrasonic metering can be used for liquids that are ultrasonically conductive and have a reasonably well-formed flow (not turbulent). They can be permanent or clamp onto pipework. The latter function is useful to check existing flow meters, check and calibrate pumping systems, etc. As they are non-intrusive, they have no pressure drop. Ultrasonic meters may have an accuracy of 1 - 3 % of a measured value of 0.5 %, with process calibration depending on the application.

Achieved environmental benefits

New generation flow meters and pitot tubes have very high accuracy and reduction potential of pressure losses, with 1 +/- 2 % of the energy loss of a traditional orifice plate, and about 8 % of a traditional pitot tube.

Cross-media effects

None.

Operational data

Base data	Power plant with high pressure steam	Waste incineration with super-heated steam
Q max (t/h)	200	45
T (°C) 545		400
P (bar abs)	255	40
Pipe ID (mm)	157	130.7
Differential pressures in mbar (approximate):		
Orifice plates	2580	1850
Pitot tubes hitherto	1770	595
Pitot tubes new generation	1288	444
Permanent pressure drop in mbar and per measuring system in mbar (approximate):		
Orifice plates	993	914
Pitot tubes hitherto	237	99
Pitot tubes new generation	19.3	7.3
Kinematic energy loss per measuring system in kWh/h (with 100 mbar \approx 67.8 kWh/h) (approximate):		
Orifice plate	673	620
Pitot tubes hitherto	161	67
Pitot tubes new generation	13	5

Table 2.5: Examples of pressure drop caused by different metering systems

Applicability

New installations or significant upgrades.

Care is needed with ultrasonic measurements, to ensure there is minimum turbulence and other effects in the liquid (such as interference from suspended particulates) being measured.

Economics

The cost of a new generation measuring device, including installation is about EUR 10 000. This may vary with numbers installed. Return on investment (ROI) is usually less than one year.

Driving force for implementation

Cost savings. Data accuracy for process control and optimisation potential (see Section 2.6).

Examples

- see Operational data, above
- widely used in all sectors
- other examples are ultrasonic meters (no Operational data supplied) and Poetter sensors.

Reference information

www.flowmeters.f2s.com/article.htm

2.11 Energy audits and energy diagnosis

Description

In general, an audit is an evaluation of a person, organisation, system, process, project or product. Audits are performed to ascertain the validity and reliability of information, and also to provide an assessment of a system's internal control. Traditionally, audits were mainly concerned with assessing financial systems and records. However, auditing is now used to gain other information about the system, including environmental audits [182, Wikipedia]. An audit is based on sampling, and is not an assurance that audit statements are free from error. However, the goal is to minimise any error, hence making information valid and reliable.

The term 'energy audit' is commonly used, and is taken to mean a systematic inspection, survey and analysis of energy flows in a building, process or system with the objective of understanding the energy dynamics of the system under study. Typically, an energy audit is conducted to seek opportunities to reduce the amount of energy input into the system without negatively impacting the output(s).

An energy diagnosis may be a thorough initial audit, or may go wider, and agree a reference frame for the audit: a set methodology, independence and transparency of the audit, the quality and professionalism of the audit, etc. See below [250, ADEME, 2006]

In practice, there are wide ranges of types and complexities of energy audits. Different types of audits may be used in different phases of energy management, and/or differing complexities of situations. Differing scopes, degrees of thoroughness and aims are illustrated in Figure 2.9:

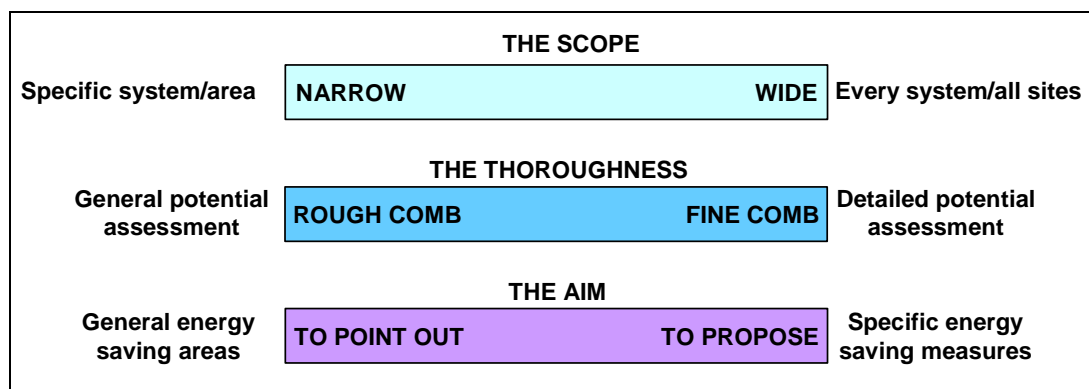

Figure 2.9: The properties of energy audit models [7, Lytras, 2005]

Some tools that may be used to assist or standardise energy auditing are listed in Annex 7.8.

The different energy audit models can be divided into two main types according to their scope:

1. The scanning audit models.
2. The analytical models.

Within these two types, there are different models which may be specified according to their scope and thoroughness. In reality, the audit can be specified to meet the needs of the situation.

Some standards exist, usually within auditing companies or energy saving schemes. The first national standard for energy audits have been created. This standard is an energy diagnosis reference frame which:

- proposes a method to realise an energy diagnosis
- sets out the general principles and objectives of such a mission as objectivity, independence, transparency
- expresses recommendations that are essential to reach a first class service.

For the operator, the advantages of the reference frame are the description of a consensual method, a base facilitating dialogue, a time saving tool, examples of outputs (lists of equipment, balances, unfolding of a monitoring campaign, etc).

A specific type of audit is the investment graded audit, i.e. audits geared to assess the options for investment in energy efficiency. In investment graded audits, one of the key characteristics is the assessment of the error in the energy saving prediction: if a company proposes to invest EUR 1 million in energy efficiency, it should know the risks associated with the predicted savings, and how to minimise those risks (e.g. the uncertainty of error in the calculations, and the uncertainty of the investment).

Similarly to financial audits, energy audits may be carried out by internal or external staff, depending on the aims of the audit, the complexity of the site and the resources available. Some SMEs may not have sufficient in-house experience and staff and use external consultants (particularly if this is made available as part of an initiative, see Annex 7.12). Large energy users may have staff allocated to this work, but may also use either external consultants for additional or one-off audits, or create a temporary team from other departments or sites (see Sections 2.5 and 2.6).

1. The scanning models

The main aim of scanning energy audit models is to point out areas where energy saving possibilities exist (or may exist) and also to point out the most obvious saving measures. Scanning audits do not go deeply into the profitability of the areas pointed out or into the details of the suggested measures. Before any action can be taken, the areas pointed out need to be analysed further.

A scanning audit model is a good choice if large audit volumes need to be achieved in a short time. These types of audits are usually cheap and quick to carry out. A scanning audit may not bring the expected results for an operator, because it does not necessarily bring actual saving measures ready for implementation but usually suggests further analysis of key areas. There are two main examples of scanning model, described below:

- walk-through energy audits
- preliminary energy audits

Walk-through energy audit

A walk-through energy audit is suitable for small and medium sized industrial sites if the production processes are not very complicated in the sense of primary and secondary energy flows, interconnected processes, opportunities for re-using lower levels of heat, etc.

A walk-through energy audit gives an overview of the energy use of the site, points out the most obvious savings and also points out the needs for the next steps (supplementary 'second-phase' audits).

Preliminary energy audit

The scanning energy audit model for large sites is often called the preliminary energy audit. Audits of this type are typically used in the process industry. Although the main aim of the preliminary energy audit is in line with the walk-through energy audit, the size and type of the site requires a different approach.

Most of the work in the preliminary energy audit is in establishing a clear picture of the current total energy consumption, defining the areas of significant energy consumption and often the probable energy saving measures. The reporting also identifies the areas where supplementary 'second-phase' audits are needed and how they should be targeted.

The preliminary energy audit normally needs to be carried out by a team of experts.

Expertise is needed both on the auditing procedure itself as well as on the production process. The preliminary energy audit always requires committed participation from the technical personnel of the site.

2. The analytical models

The analytical energy audit models produce detailed specifications for energy saving measures, providing the audited client with enough information for decision-making. Audits of this type are more expensive, require more work and a longer time schedule but bring concrete suggestions on how to save energy. The operator can see the savings potential and no additional surveys are needed.

The analytical models can be divided into two main types:

- selective energy audits, where the auditor is allowed to choose the main areas of interest
- targeted energy audits, where the operator defines the main areas of interest. These are usually:
 - system-specific energy audits
 - comprehensive energy audits.

Selective energy audit

The selective energy audit looks mainly for major savings and does not pay attention to minor saving measures. This audit model is very cost effective when used by experienced auditors but may, in the worst case, be 'cream skimming'. There is always the risk that when a few significant saving measures are found, the rest will be ignored.

Targeted energy audit

The content of work in the targeted energy audit is specified by detailed guidelines from the operator and this means that most of the systems to be covered by the targeted energy audit are known in advance. The guidelines, set by the operator, may deliberately exclude some areas. The reason for excluding certain areas may be that they are known to be normally non-cost relevant (or more easily dealt with).

The targeted energy audit usually produces a consumption breakdown and includes detailed calculations on energy savings and investments. If the guidelines are adequate, the audit produces a standard report.

From the operator's perspective, there is always a risk if the quality control of a targeted energy audit is neglected: the auditors may be tempted to slowly move towards the selective energy audit, because this model always includes less work.

System-specific energy audit

An example of the targeted energy audit at the simplest and smallest is the system specific energy audit. This type of audit has a tightly limited target (one system, device or process), but the thoroughness of the work is usually very high. The benefit of this audit model is that it is

possible to specify the expertise for the work, which may be better than a more generalist auditor can provide.

The system-specific energy audit produces a detailed description of the system and identifies all savings measures, with options concerning the specific system, and may provide the cost-benefits of the identified options.

A good option is to combine this type of audit with some more comprehensive audit models, e.g. carry out a preliminary energy audit, and subsequently, specific audit(s) of systems where a significant energy savings possibility has been identified.

System-specific energy audits give high savings potentials compared to the energy use of the system. The problem is that when looking at only one part of the site, the 'bigger picture' is missing and a risk of partial optimisation exists. For example, when studying only the energy efficiency of compressed air or cooling systems, heat recovery opportunities cannot be evaluated because there is no knowledge as to where heat could be used in the most efficient way. Energy systems are usually interrelated and seldom independent.

Comprehensive energy audit

A comprehensive energy audit is a targeted energy audit at the 'widest' end of the scale (see Figure 2.10). It covers all energy usage of the site, including mechanical and electrical systems, process supply systems, all energy using processes, etc. Some minor systems may be excluded, where they have little relevance in proportion to the total energy consumption (for example, doors powered by electric motors).

The difference between a comprehensive energy audit and a targeted energy audit is that the targeted energy audit deliberately ignores some areas that are known and specified in advance and the comprehensive energy audit covers virtually all significant energy consumption.

The starting point in a comprehensive energy audit is always an analysis of the detailed breakdown of the total consumption. This type of audit comments on all systems using energy specified at the beginning, regardless of savings being found. It points out all potential saving measures and includes detailed calculations on energy savings and investment costs.

This model also creates a basis for a very standard and detailed reporting which brings some advantages to the operator especially in quality control and monitoring.

Achieved environmental benefits

As an energy audit identifies the main areas, operations and types of energy used in a unit, process or site, the reported findings can be used to identify and prioritise the cost effective energy savings opportunities.

Cross-media effects

None.

Operational data

See Description, above.

Applicability

See Description, above.

The type of energy audit and the frequency of implementation are plant specific. A walk-through energy audit is usually suitable for small installations.

An energy audit could be carried out to initially assess the state of energy efficiency in an installation or system. Subsequently, audits could be carried out after major changes in the installation that could modify energy production and/or consumption, significant changes in the operation parameters, etc. This approach presumes that all energy audits are comprehensive. However, even after periods of no apparent significant change, audits should be carried out from time to time to ensure there is no drift from energy efficient operation.

Alternatively, a preliminary audit could be carried out to identify areas for more intensive auditing, which are scheduled according to factors such as ease of application of ENE techniques, capital requirements, etc. (see Section 2.2.1). An individual system may therefore only be fully audited infrequently, but audits may be carried out regularly within the installation, on differing systems.

Economics

See Description, above.

Driving force for implementation

- cost savings
- adherence to energy saving agreements, etc.

Examples

Widely used. A comprehensive-type energy audit for a given organisation can be carried out according to Figure 2.10.

French national standard: The energy diagnosis reference frame for industry. AFNOR BP X 30 – 120.

Reference information

[7, Lytras, 2005, 31, Despretz, , 40, ADENE, 2005, 92, Motiva Oy, 2005, 165, BESS_EIS, , 227, TWG, , 250, ADEME, 2006]

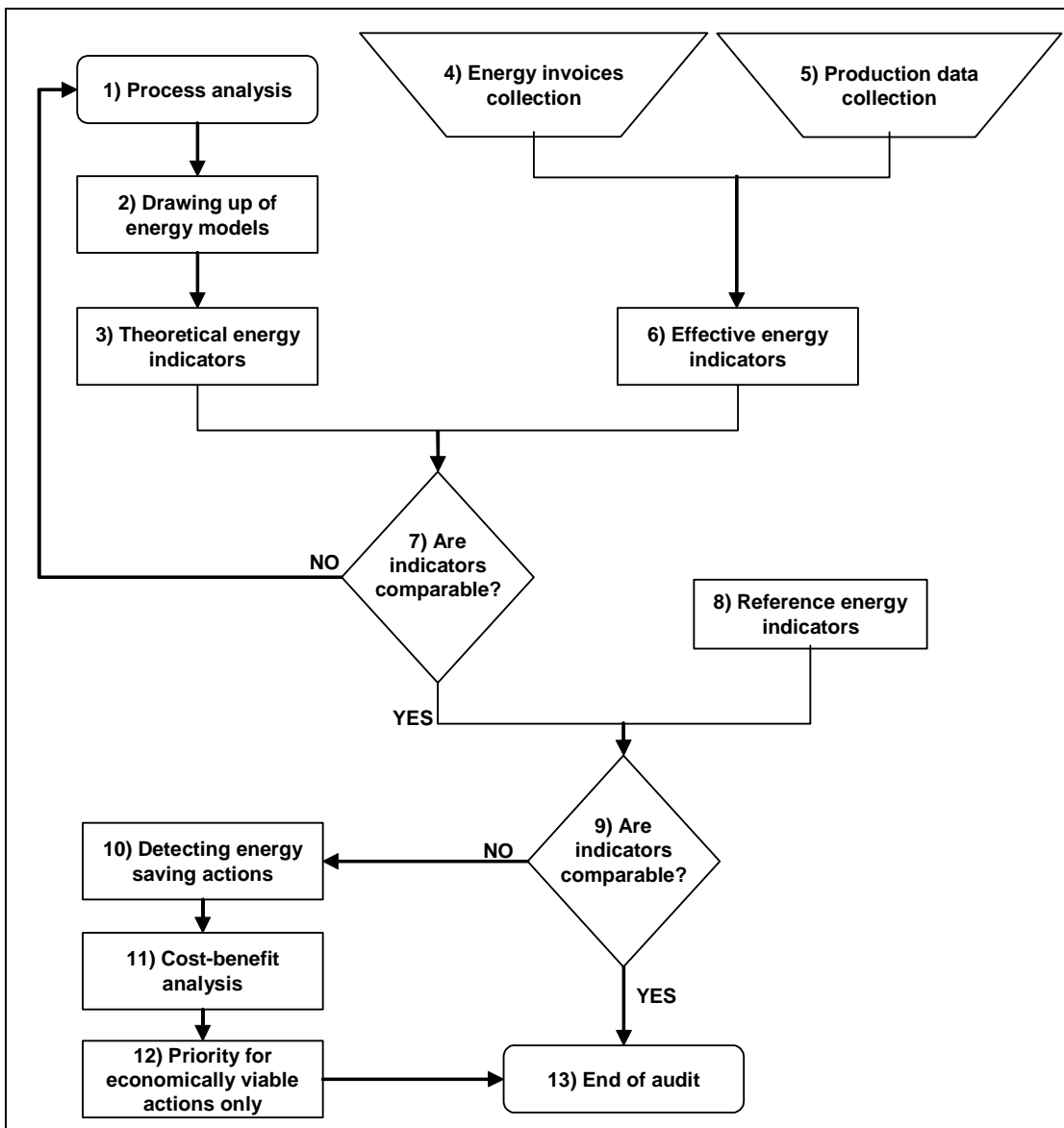

Figure 2.10: Scheme for a comprehensive-type energy audit [11, Franco, 2005]

2.12 Pinch methodology

Description

Pinch methodology is the application of pinch technology. It is a methodology for minimising energy consumption in processes by calculating thermodynamically feasible energy targets and achieving them by optimising heat recovery systems, energy supply methods and process operating conditions. Although it is also known as *process integration* or *energy integration*, these are the outcomes of applying the results of the pinch methodology (e.g. see Section 2.4).

All processes consist of hot and cold streams. A hot stream is defined as one that requires cooling, and a cold stream as one that requires heating. For any process, a single line can be drawn on a temperature-enthalpy plot which represents either all the hot streams or all the cold streams of the process. A single line either representing all the hot streams or all the cold streams is called the hot composite curve or the cold composite curve, respectively. The construction of a composite curve is illustrated in Figure 2.11 where two hot streams are shown on a temperature-enthalpy diagram.

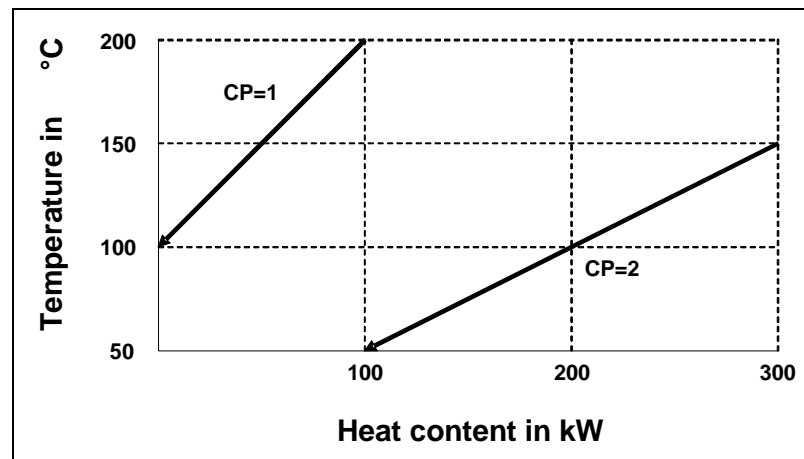

Figure 2.11: Two hot streams

Stream 1 is cooled from 200 to 100 °C. It has a CP (i.e. mass flowrate x specific heat capacity) of 1; therefore, it loses 100 kW of heat. Stream 2 is cooled from 150 to 50 °C. It has a CP of 2; therefore, it loses 200 kW of heat.

The hot composite curve is produced by the simple addition of heat contents over temperature ranges:

- between 200 and 150 °C, only one stream exists and it has a CP of 1. Therefore, the heat loss across that temperature range is 50 kW
- between 150 and 100 °C, two hot streams exist, with a total CP of 3. The total heat loss from 150 to 100 °C is 150 kW. Since the total CP from 150 to 100 °C is greater than the CP from 200 to 150 °C, that portion of the hot composite curve becomes flatter in the second temperature range from 150 to 100 °C
- between 100 and 50 °C, only one stream exists, with a CP of 2. Therefore, the total heat loss is 100 kW.

Figure 2.12 shows the hot composite curve.

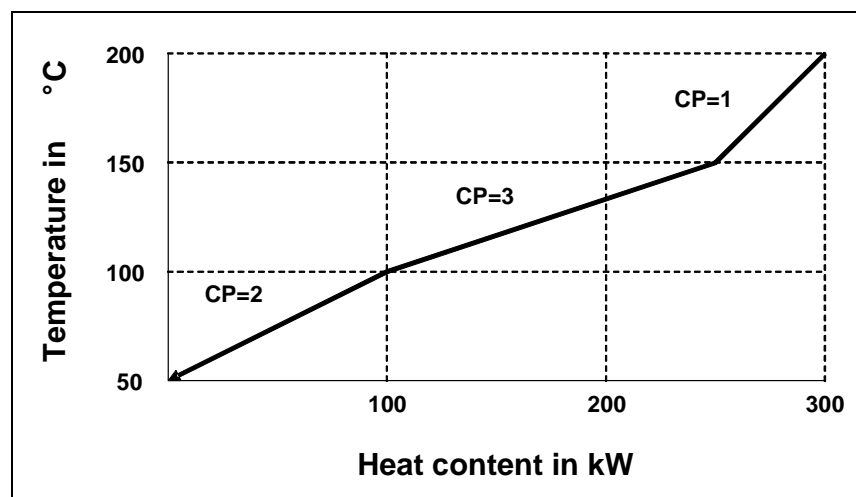

Figure 2.12: Hot composite curve

The cold composite curve is constructed in the same way. In practical applications, the number of streams is generally much greater, but these streams are constructed in exactly the same way.

Figure 2.13 shows the hot and cold composite curves plotted on the same temperature-enthalpy diagram. The diagram represents the total heating and cooling requirements of the process.

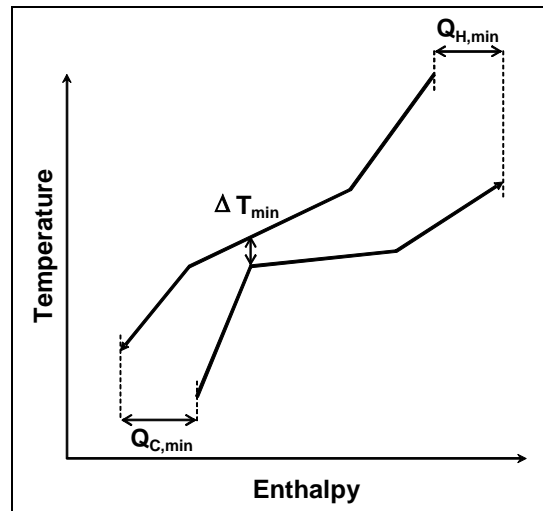

Figure 2.13: Composite curves showing the pinch and energy targets

Along the enthalpy axis, the curves overlap. The hot composite curve can be used to heat up the cold composite curve by process-to-process heat exchange. However, at either end an overhang exists such that the top of the cold composite curve needs an external heat source ($Q_{H,min}$) and the bottom of the hot composite curve needs external cooling ($Q_{C,min}$). These are known as the hot and cold utility targets.

The point at which the curves come closest to touching is known as the pinch. At the pinch, the curves are separated by the minimum approach temperature ΔT_{min} . For that value of ΔT_{min} , the region of overlap shows the maximum possible amount of process-to-process heat-exchange. Furthermore, $Q_{H,min}$ and $Q_{C,min}$ are the minimum utility requirements.

Once the pinch and utility targets of a process have been identified, the three 'golden rules' of the pinch methodology can be applied. The process can be considered as two separate systems (see Figure 2.14), a system above the pinch and a system below the pinch. The system above the pinch needs a positive amount of heat from an external source, so it is a heat sink, whereas the system below the pinch has heat to reject to an external sink and is, therefore, a heat source.

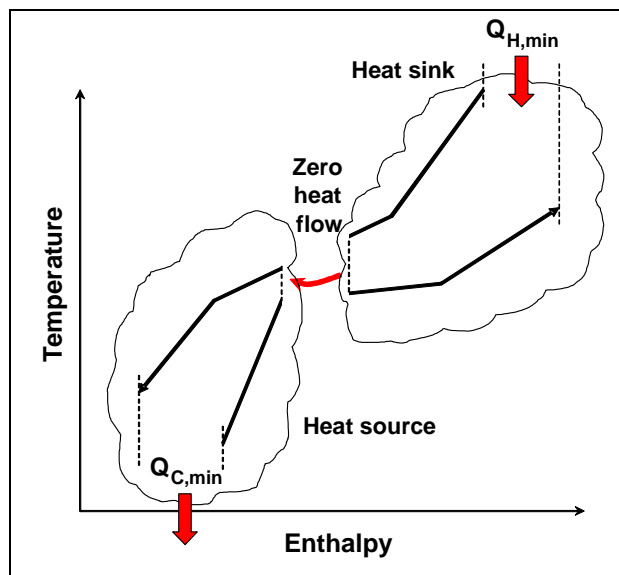

Figure 2.14: Schematic representation of the systems above and below the pinch

The three rules are as follows:

- heat must not be transferred across the pinch
- there must be no outside cooling above the pinch
- there must be no outside heating below the pinch.

If the amount of heat travelling across the pinch is α , then an extra amount (α) of hot utility must be supplied and an extra amount of cold utility α is required (see Figure 2.15). Similarly, any outside cooling of the heat sink and any outside heating of the heat source increases the energy requirements.

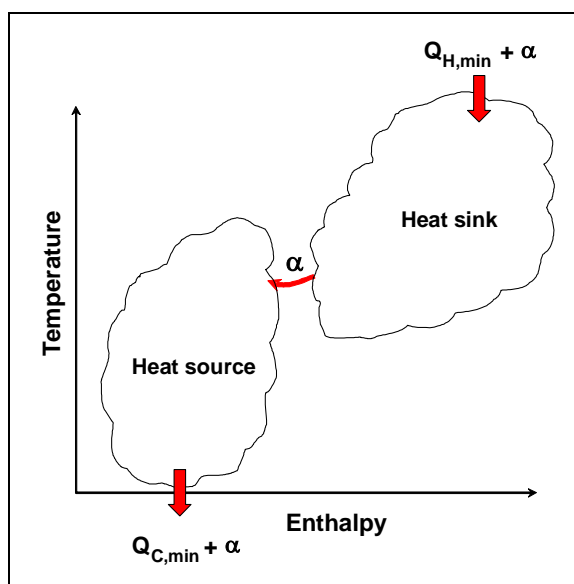

Figure 2.15: Heat transfer across the pinch from heat sink to heat source

Thus:

$$T = A - \alpha \quad \text{Equation 2.1}$$

where:

T = target energy consumption
 A = actual energy consumption
 α = cross-pinch heat flow.

To achieve the energy targets, cross-pinch heat flows must be eliminated.

Achieved environmental benefits

Optimisation of the energy balance on a production site.

Cross-media effects

None believed likely.

Operational data

The key to applying the pinch methodology in non-continuous processes is the data extraction. There are no shortcuts; detailed measurements and timings of all the process streams are essential if cost savings (= energy savings) opportunities are to be found.

Applicability

Pinch methodology can be applied to a wide variety of industries with process streams at different temperature levels. It is used in the design of new plants or units, significant upgrades or detailed investigations of a plant's performance, such as:

- energy analysis of process units
- utility plus heat and electrical power system analysis
- heat exchanger network design and analysis
- total site analysis to optimise process and utility integration
- hydrogen and water system analysis.

The early applications of pinch methodology were in oil refining, petrochemical, and bulk chemical plants, where it showed energy and capital savings. However, recently the methodology has been proved a cross a wide range of processes and industries, including cogeneration, pharmaceuticals, pulp and paper, cement, food, drink and milk (e.g. brewing, coffee making, ice-cream and dairy products), see Examples, below.

Pinch methodology has also been used in various kinds of processes including batch, semi-continuous, and continuous operations incorporating various operating parameters, such as different feedstocks, seasonal demand fluctuations, multiple utilities, quality constraints, and environmental constraints.

Economics

See payback times in Table 2.6.

The pinch methodology is often thought to be expensive and difficult. However, for simple problems calculations can be made manually, or by using software tools (some are available free of charge). Projects can start from about EUR 5000. The data requirements to perform an analysis are very small, and pinch analysis is a basic element in industrial engineering education.

For more complex situations, an experienced team will be needed to cover the pinch analysis, process simulation, cost estimation and plant operation.

Driving force for implementation

Operating and capital cost savings.

When it has been used in existing operations, there have frequently been process benefits, such as improved plant flexibility, debottlenecking, increased capacity and reduced effects of fouling.

Examples

Savings from some applications of pinch methodology ¹ (Costs: USD ² , reported Ullman's, 2000)	
Process description	Savings
Crude oil unit	Savings of c. USD 1.75×10^6 with 1.6 year payback
Large petrochemical complex manufacturing ethylene, butadiene, HDPE, LDPE, and polypropylene	Savings of over USD 7.00×10^6 with paybacks from 12 to 20 months
Tailor-made chemicals, batch process with 30 reactors and over 300 products	Savings of c. USD 0.45×10^6 with paybacks of 3 months to 3 years
Sulphur-based speciality chemicals, batch and continuous	30 % savings to total site energy bill (worth c. USD 0.18×10^6 with paybacks of 9 – 16 months)
Edible oil refinery, batch operation, wide range of feedstocks	Savings of 70 % of process energy equivalent to c. USD 0.79×10^6 with paybacks from 12 to 18 months and debottlenecking equivalent to 15 % increased capacity
Batch processing of dairy products and dried beverages	Savings of 30 % (equivalent to c. USD 0.20×10^6) with paybacks of less than 1 year
Brewery	Savings from 12 to 25 % of energy costs with paybacks from 9 months to 2 years
State-of-the-art whisky distillery	Significant debottlenecking and savings of c. USD 0.35×10^6 with paybacks from 18 months to 2 years
Paper mill	Savings of 8 – 20 % of energy bill with paybacks from 1 to 3 years
Continuous cellulose acetate processing	Savings of c. USD 0.28×10^6 with 1 year payback
Continuous dry cement process	Large energy savings

Notes:
¹ Savings mentioned above are concerned primarily with energy costs. The majority of the companies also benefited from increased throughput and improved process flexibility and operability; the economic value of these benefits is not included in the table above.
² No exchange rate is given as the exact dates of the data and applications are unknown

Table 2.6: Pinch methodology: some examples of applications and savings
 [266, Ullmann's, 2000]

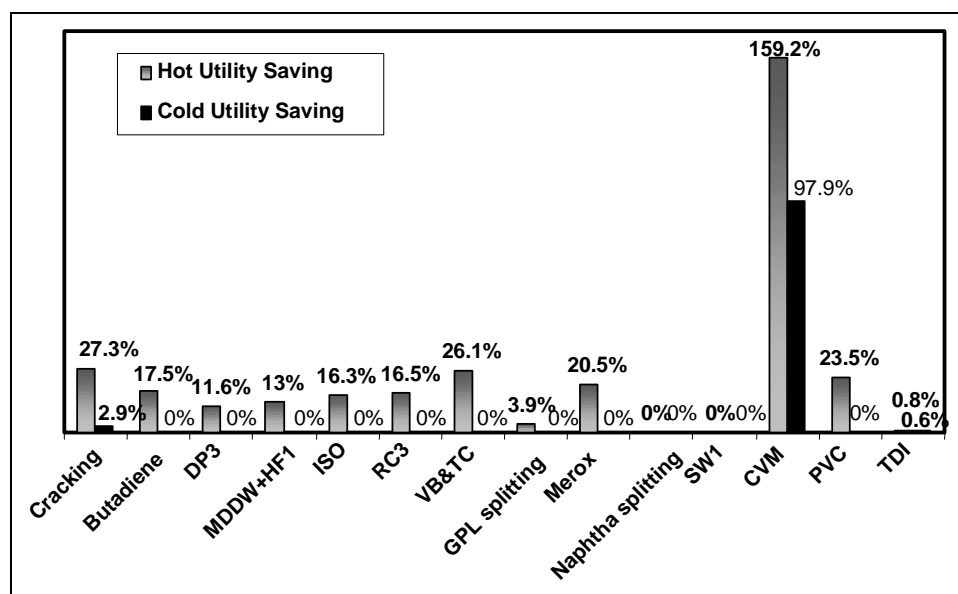

Figure 2.16: Energy savings identified by pinch methodology

Note: acronyms refer to polymer and organic chemical process stages

[51, Pini, 2005]

Reference information

[117, Linnhoff March], [118, KBC], [12, Pini, 2005, 51, Pini, 2005, 67, Marttila, 2005, 119, Neste Jacobs Oy]

Free pinch software: Pinch2.0 from Fraunhofer ISI/Peter Radgen.

It is also a technique considered in other BREFs: OFC, SIC, LVIC-S, REF, etc.

2.13 Enthalpy and exergy analysis

Description

Energy (or enthalpy) analysis and exergy analysis are techniques based on the determination of energy or exergy of the flows of the thermal systems studied and of the energy or exergy balances of the components connected by those flows.

To perform these analyses, the following steps have to be followed:

1. The boundary of the system analysed (the whole plant or a part of it) has to be precisely specified.
2. The whole system has to be disaggregated into several parts, connected by matter and energy flows. The detail of this disaggregation depends on the depth of the analysis required and on available information.
3. Thermodynamic properties defining the flows have to be determined: mass flow, pressure, temperature, composition, shaft power, heat flow, etc. When an actual system is analysed, this information is obtained by measurements. However, when the analysis is performed for an installation to be built, simulation is used.
4. Once all the flows defined have been completely characterised, it is possible to determine their enthalpy and exergy (see Section 1.2.2 and Annex 7.1).
5. The enthalpies and exergies can be used to determine other parameters such as energy losses in the components, irreversibility, efficiencies, and can be demonstrated, e.g. using Sankey (energy) or Grassmann (exergy) diagrams.
6. These balances and analyses can be done in real time at various time intervals and the information about the 'exergy costs', e.g. the amount of exergy resources needed to produce a given flow, may be used to diagnose the deviations of the plant's performance from an agreed reference state.
7. Finally, the relationship between thermodynamics and economics can be readily determined, as the cost of any malfunction or inefficiency of a subsystem in the plant has two components: first, the amount of material resources and second, the money expended to compensate it. The theory explaining the fundamentals of such a technique is named thermoeconomics (see Section 2.14).

As can be seen, energy and exergy analyses can be performed in parallel, and are measured in the same units. However, exergy analysis, although less used and more complex, is more useful because it points directly to where energy can be saved.

Energy is a conservative property: it is neither created nor destroyed, so energy analysis can only take into account energy lost through the system boundary (heat losses, gases to stack, etc.). However, every energy transformation leads to a reduction in energy quality: energy is conserved but its utility always decreases. In this framework, exergy is a measure defined to take into account the quality of energy. Electricity or mechanical work are forms of the highest quality energy, so that their energy and exergy are exactly the same. On the other hand, a mass of water heated 20 degrees above ambient temperature has energy, but its exergy content is negligible. The exergy content measures exactly the maximum convertibility (in energy units) of a given flow into other forms of energy. Exergy is therefore not a conservative property. In every steady state process the exergy of entering flows is always higher than exergy of exiting flows. This difference is called irreversibility, and its quantification through exergy analysis

allows one to detect where energy quality is lost (in other words, where energy can be saved). (These issues are explained in more detail in Annex 7.1).

As an example, consider a boiler used to produce low pressure steam for a given process. If an energy analysis is performed, this boiler can have an energy efficiency as high as 85 %, and it appears to be an efficient device. However, the quality of the energy contained in the steam is low, so that the exergy efficiency of the boiler can be about 25 %. This low figure indicates that there is a big potential of energy savings if the boiler is substituted by, for example, the heat recovery steam generator of a cogeneration system, in which the input hot gases have been used to drive a turbine which captures the high quality energy. Counter-intuitively, the lower the quality of the output, the higher the energy efficiency of the boiler that can be industrially achieved; however the exergy efficiency indicator follows the common sense trend.

Achieved environmental benefits

These analyses enable the determination of where energy and exergy is lost, and where the points are with highest potential to save energy. As exergy is dependent on all the properties defining a given flow, it can also be used to follow where pollutants are produced in the plant, along with the quantities.

Cross-media effects

None believed likely.

Operational data

A key point in the application of these techniques is the availability of information about the flows of the energy system. This information is obtained by measurements in operating plants and by simulation at the design stage. The depth of the analysis is limited by this circumstance.

Applicability

The concept of exergy is used in many situations to locate where natural resources are lost (see the Reference information, below).

The techniques can be applied to any thermal system. A main advantage is that they allows the direct comparison of different plants. Furthermore, exergy analysis provides an absolute reference: the ideal system which is one without irreversibilities.

The analysis can be used to determine the state of a non operating plant, by using available measurements, and to compare these with design values. Besides, it is useful to analyse alternatives and the possibility of improvements at the design stage.

However, the use of exergy in companies is still limited. For example, in the Netherlands, the concept of exergy is used by the engineering departments of the large companies, like Shell, Dow Chemical, Unilever, DSM, AKZO NOBEL, etc. and a number of large engineering firms. Several studies have been performed. These studies lead to the conclusion that exergy analyses give valuable information, but that the analyses take too much time and that there is not enough data with which to compare results. For example, benchmarking on the basis of exergetic efficiencies is not easy, because of the lack of data for comparison. To facilitate the exergy analyses, a commercial program for calculating exergy has been developed. With this program, the exergy of flows can be calculated in proprietary flowsheets, significantly reducing the time to perform exergy analyses. However, the flowsheets are expensive and only a limited number of companies have sufficient use to justify the cost.

Most small and medium sized companies do not use this type of software, because of the high cost, the lack of trained staff and the level of accuracy required for data input to those programs. For these companies, a new method has been devised, and is being developed further.

Economics

Exergy analysis has the reputation of being difficult and expensive. However, if information on flow properties is available (which is a common situation), enthalpy and exergy analysis can be done at low cost. A limited number of tools are available to perform the analysis in connection with a flowsheet package. In this way, the analysis can be performed fast and efficiently. The exergy losses pinpoint the locations where the biggest savings could be achieved (in materials, energy, and therefore money). The cost of an exergy analysis starts at EUR 5000.

Furthermore, for smaller projects the analysis can be done manually. Here, the use of an exergy analysis is very limited. A new method called exergy scan is under development in order to provide a useful tool.

Driving force for implementation

It is a low cost technique which can give value to plant measurements. It also points out clearly the components where energy can potentially be saved. Information obtained in these analyses can be used by other tools such as Sankey diagrams (see Section 2.7.1).

Examples

Energy (or enthalpy) analysis is widely used in the analysis of thermal systems in both design and operation. The use of exergy is not so extensive, although this is increasing. As mentioned above, it has been used by companies such as: Shell, Dow Chemical, Unilever, DSM, AKZO NOBEL, etc. and large engineering firms.

Reference information

[227, TWG]

Information and examples of enthalpy analysis and also exergy analysis can be found in any graduate level book on thermodynamics. For more details on exergy analysis see:

- T. J. KOTAS. Krieger, The Exergy Method of Thermal Plant Analysis, Florida, 1996
- Kotas, T.J., The Exergy Method of thermal and chemical processes, Krieger Publishing Company, Melbourne, USA, 1999
- Szargut J., Morris D.R., Steward F.R., Exergy Analysis of Thermal, Chemical and Metallurgical Processes, Hemisphere, New York, 1988
- Cornelissen, R.L., 1997, Thermodynamics and sustainable development, The use of exergy analysis and the reduction of irreversibility, Ph.D. thesis, University of Twente, <http://www.utwente.nl/webdocs/wb/1/t0000003.pdf>
- Cornelissen, R.L., and Boerema C. 2001, Exergy Scan – the new method for cost effective fuel saving, Proceedings of ECOS 2001, p.p. 725-731, Istanbul.

Tools:

- exergy calculator: <http://www.exergoecology.com/excalc>
- exerCom and exergy scan: more information on both at www.exergie.nl

2.14 Thermoeconomics

Description

Thermoeconomic analysis techniques combine the first and second laws of thermodynamics with cost information conducted at the system level. These techniques help to understand the cost formation process, minimise the overall product costs and assign costs to more than one product produced by the same process.

As noted in Section 1.2, energy is not consumed in processes, but useful energy is degraded to less useful forms. Highly irreversible processes, such as combustion, heat transfer, throttling etc. can only be analysed by an exergy analysis (see Section 2.13). Exergy is a non objective and universal measure of change and can be considered the bridge between thermodynamics and cost accounting methodologies because it relates to intensive properties such as pressure, temperature, energy, etc., which can be measured. An economic analysis can calculate the cost of fuel, investment, operation and maintenance for the installation.

Thus, thermoeconomics assesses the cost of consumed resources, money and system irreversibilities in terms of the overall production process. Thermoeconomics helps to point out how resources may be used more effectively in order to save them. Money costs express the economic effect of inefficiencies and are used to improve the cost effectiveness of production processes. Assessing the cost of the flow streams and processes in a plant helps to understand the process of cost formation, from the input resources to the final products.

Achieved environmental benefits

Principally savings in energy, but also reductions in material usage and wasted or emitted materials.

Cross-media effects

None anticipated from a calculation technique.

Operational data

These analyses can solve problems related to complex energy systems that could not be solved by using conventional energy analyses. Among other applications, thermoeconomics are used for:

- rational price assessments of plant products based on physical criteria
- optimisation of specific process unit variables to minimise the final product cost, i.e. global and local optimisation.
- detection of inefficiencies and calculation of their economic effects in operating plants, i.e. plant operation thermoeconomic diagnosis
- evaluation of various design alternatives or operation decisions and profitability maximization
- energy audits.

Applicability

No data supplied.

Economics

Case dependent.

Driving force for implementation

Cost and materials savings.

Examples

Various electrical power plants (including gasification-combined cycle), refineries, chemical plants, sugar processing plants, combined power and desalination plants, district heating systems, etc.

Reference information

[258, Tsatsaronis and Valero, 1989] [284, Valero, , 285, Valero, 1989]

More information on sites such as: [286, Frangopoulos]

2.15 Energy models

2.15.1 Energy models, databases and balances

Description

Energy models, databases and balances, are useful tools to carry out a complete and in-depth energy analysis and are likely to be part of an analytical or comprehensive energy audit (see Section 2.11). A model is a plan or description designed to show where and how energy is used in an installation, unit or system (e.g. a database). The model therefore seeks to record the technical information about an installation, unit or system. It will record the type of equipment, energy consumption and operating data such as running time. It should be complete enough for the task (but not excessively so), easily accessible to various users in departments such as operations, energy management, maintenance, purchasing, accounts, etc. It may usefully be part of, or linked to a maintenance system, to facilitate record updating, such as motor rewinding, calibration dates, etc. (see Section 2.9).

Where an energy model, database or balance is used, it may be built up based on system boundaries, (see Section 1.5.1), e.g.:

- units (department, production line, etc.)
 - system
 - individual equipment (pumps, motors, etc.)
- utility systems (e.g. compressed air, pumping, vacuum, external lighting, etc.)
 - individual equipment (pumps, motors, etc.).

The auditor (or data gatherer) must take care to ensure the efficiency recorded is the real system efficiency (as described in Section 1.5.1).

As an energy model or database is a strategic tool to carry out an energy audit, it is good practice to validate it before use by performing a balance. The first step is to compare the total amount of energy consumed, as derived from calculations, with the amount consumed as shown by the metered energy supplies. Where the installation is complex, this can be carried out at a unit or system level (see system boundaries, Section 1.5.1 and metering, Section 2.10.3). If the balance between the calculated and the metered consumptions is not achieved, then the data in the model should be rechecked, in particular any estimations, such as load factors and working hours. Where necessary, these should be established with greater accuracy. Another cause of errors is not identifying all the equipment using energy.

Achieved environmental benefits

Enables planning on the basis of knowing where energy is consumed.

Cross-media effects

None thought likely.

Operational data

Electrical energy

For an electric model, database or balance, the following data can be gathered for each electrically powered device, such as motors and drives, pumps, compressors, electric furnaces, etc.

- rated power
- rated efficiency
- load factor
- working hours per year.

Whereas power and efficiency are easy to detect as they are normally labelled on the device itself, the load factor and the hours per year are estimated.

Examples of data gathered for a simple electrical energy model are given in Annex 7.7.3.

When the load factor is estimated to be greater than 50 %, then the load factor itself is approximately equal to:

$$LF = \frac{P_{(eff)} \times \eta}{P_{(rated)}}$$

where:

- LF is the load factor
- $P_{(eff)}$ is the estimated average electric power effectively absorbed by the device during its working hours (kW)
- $P_{(rated)}$ is the rated power (kW)
- η is the rated efficiency of the device (at full load).

If necessary, P_{eff} can be measured using electric power meters.

It must be pointed out that the efficiency and the power factor of a device depend on the load factor according to Figure 2.17, drawn, in this case, for a generic motor.

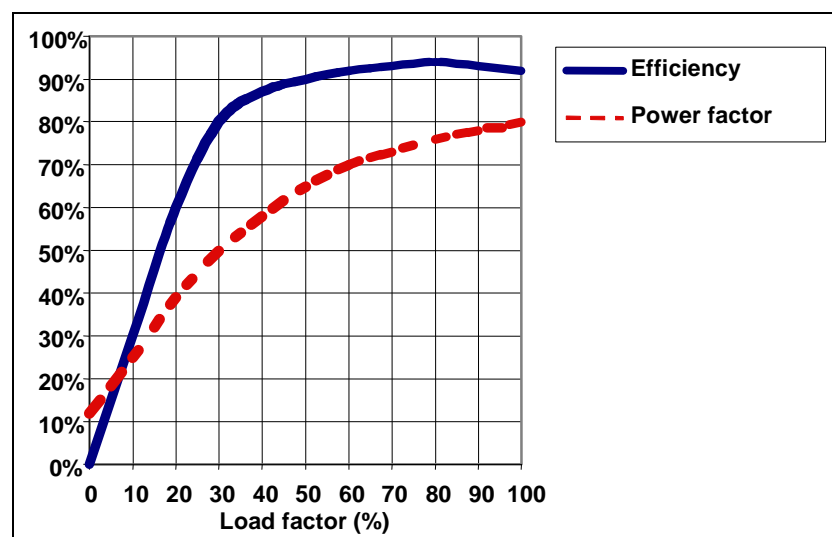

Figure 2.17: Power factor of a device depending on the load factor
[11, Franco, 2005]

Thermal energy

The drawing up of a thermal energy model, database or balance is more complex than an electric model. To have a complete picture of the thermal consumption, two kinds of models (or databases or balances) are compiled: first level and second level.

To compile the first level energy model, it is necessary to take a census of all users of any kind of fuel. For any consumer of fuel (e.g. boilers, furnaces), the following data should be recorded:

- type of fuel supplied in a specific time period, usually in a year
- kind of thermal carrier entering the boiler (e.g. pressurised water): flowrate, temperature, pressure
- condensate: percentage of recovery, temperature, pressure

- boiler body : manufacturer, model, installation year, thermal power, rated efficiency, exchange surface area, number of working hours in a year, body temperature, average load factor
- burner: manufacturer, model, installation year, thermal power
- exhaust: flowrate, temperature, average carbon dioxide content
- kind of thermal carrier leaving the boiler (e.g. steam): temperature, pressure.

Though all such data should be collected, in the first level thermal model ('generators' side) only the major users of energy need to be taken into account (see Table 7.9). It is generally helpful to convert all energies into primary energy or specific energy types used in the industry, for later comparisons (see Section 1.3.6.1).

Second level models ('users' side) are also made by taking a census of all machineries needing thermal energy in any form (hot water, steam, hot air, etc.) except fuel (taken into account in the first level model). For every item of equipment using thermal energy, the following data should be collected:

- type of thermal carrier used
- hours/year of thermal demand
- load factor at which thermal energy is used
- rated thermal power.

An example of how data can be arranged is given in Annex 7.7.3, Table 7.9.

The second level model ('users' side) is useful to verify the match between the heat supplied by the utilities (boilers, heat generators, etc.) and the heat requested by the users.

If this difference is acceptable, then the two models can be considered as validated. If this is not the case, then some recalculation or further investigation is needed.

If the difference between the two amounts is large, this is likely to be due to a high level of losses in the production-distribution-use for different carriers (e.g. steam, hot water, etc.). In this case, actions to improve the energy efficiencies should be taken.

Applicability

The type of model and the detail of information gathered depend on the installation.

An analysis of every piece of energy-consuming equipment is often not feasible or necessary. Electrical energy models are suitable for smaller installations. Process analysis including detailed electrical and thermal power consumption is more appropriate in larger installations.

Priorities can be set to maximise the cost-benefit of the data-gathering, e.g. data on equipment exceeding a certain power consumption, or guidelines such as initially collecting data on the 20 % of equipment that uses 80 % of the power (e.g. steam, electricity), etc. It should be noted that as the model is used, and as ENE is gained, then the remaining equipment can be added, again in a planned manner.

Economics

Site dependent.

Driving force for implementation

Cost savings.

Examples

Examples of energy data sheets and balance calculations are given in Annex 7.7.3.

Reference information

[127, TWG] [11, Franco, 2005]

2.15.2 Optimisation and management of utilities using models**Description**

This brings together techniques such as those described in Sections 2.10.3 to 2.15 and adds software modelling and/or control systems.

For simple installations, the availability of cheaper and easier monitoring, electronic data capture and control, make it easier for operators to gather data, assess process energy needs, and to control processes. This can start with simple timing, on-off switching, temperature and pressure controls, data loggers, etc. and is facilitated by using software models for more sophisticated control.

At the more complex levels, a large installation will have an information management system (manufacturing and execution systems), logging and controlling all the process conditions.

A specific application is in managing the way energy is sourced and supplied (supply side energy management, distribution management or utilities management), see Applicability, below. This uses a software model linked to control systems to optimise and manage the energy utilities (electricity, steam, cooling, etc.).

Achieved environmental benefits

Reduction in energy use and associated emissions. See Examples, below.

Cross-media effects

Usually efficiencies are additive, but in some cases, if the supply/utility distribution side is not considered, then the benefits in reducing demand are not realised, e.g. when steam savings in one process unit simply lead to venting elsewhere if the steam system is not rebalanced.

Operational data

With increasing complexity, optimum and energy efficient operation can be achieved by using the right tools, ranging from simple spreadsheet based simulation tools, or distributed control systems (DCS) programming to more powerful model-based utilities management and optimisation systems (a utilities optimiser) which might be integrated with other manufacturing and execution systems on site.

A utilities optimisation system will be accessed by staff with a variety of backgrounds and objectives (e.g. engineers, operators, plant managers, buyers, accounts staff). The following are important general requirements:

- ease of use: the different users need to access the system and the system needs to have different user interfaces as data integration with other information systems to avoid re-entering data, e.g. such as enterprise resource planning (ERP), production planning, data history
- robust: needs to show consistent and reliable advice to be accepted by users
- close to reality: needs to represent plant reality (costs, equipment, start-up times) without introducing an unmanageable level of detail
- flexible: needs to be flexible so that adjustments in the changing plant environment (e.g. temporary restraints, updating costs) can be done with little effort.

A utilities optimiser should be able to reliably calculate the benefits of options (online or off-line, e.g. 'what-if' scenarios) and contribute to motivating the necessary change(s) (see Section 2.5).

The key requirements for a model-based utilities optimiser are:

- a model of the fuel, steam and electricity generation processes and distribution system. At a minimum, the model must accurately represent:
 - the properties of all fuels, including the lower heating value and composition
 - the thermodynamic properties of all water and steam streams on the facility
 - the performance of all utility equipment over their normal range of operation
- a model of all buy-and-sell contracts that apply to the utilities system
- mixed integer optimisation capability, which enables utility equipment on/off decisions as well as discontinuities in the contract model and/or utilities process model
- online data validation and gross error detection
- open loop
- online optimisation
- the possibility to carry out 'what-if' studies for off-line studies (study impact of projects, study impact of different types of contracts for, e.g. electricity and fuel).

Applicability

Simple control systems are applicable even in small installations. The complexity of the system will increase in proportion to the complexity of the process and the site.

Utilities optimisation and management is applicable on sites where there are multiple types of energy usage (steam, cooling, etc.), and various options for sourcing energy, between these energy carriers and/or including in-house generation (including cogeneration and trigeneration, see Section 3.4).

The key requirements for a model-based utilities optimiser are a model of the fuel, steam and power generation processes and distribution system. As a minimum, the model must accurately represent the properties of all fuels, including the lower heating value and composition. This may be difficult with varied and complex fuels such as municipal waste, which reduces the possibilities of optimising the energy export.

Economics

See Examples.

Driving force for implementation

Cost is a main driver. The cost savings from a reduction in energy use is complicated by (see Section 7.11) the complexity of tariffs in increasingly deregulated utilities markets, electricity and fuel trading, and emissions monitoring, management and trading. Table 2.7 sets out the main business process drivers.

Business process	Main driver (where marked with +)	
	Energy efficiency	Energy cost/ contracts
Demand forecasting: knowledge of the current and predicted future utility demands over given time periods (days, weeks, months, years, depending on process and market variations). Helps minimise: <ul style="list-style-type: none"> the use of hot standby (e.g. boilers) the venting of excess steam the loss of supply due to insufficient standby or control 	+	
Utilities production planning: takes demand profiles and develops an optimised production plan based on the availability of utilities. Can be tactical (24 hrs) or strategic (when to start-up or shut down equipment for maintenance)	+	+
Optimal plant operation (online optimisation): while a plan may be developed in advance (e.g. for every 24 hrs) operations can vary and invalidate this. A utilities optimiser can provide real time advice to operations staff on how to operate the system at the lowest cost based on current demands and prices	+	+
Performance monitoring (utilities equipment): a utilities optimiser can track the performance of individual items and systems. This can be used to optimise maintenance and cleaning schedules, and warn of operating problems	+	
Investment planning: a utilities optimiser can be used to evaluate design options for new equipment and changes to existing equipment in both process systems and the utilities systems, e.g. <ul style="list-style-type: none"> deaerating feed-water heating using process heat choice of drive (motor or steam turbine) or possibly dual process drives to give greater flexibility to balance the steam system improving condensate return changing energy supply (e.g. use of low pressure steam to reduce medium pressure steam use) use of steam to preheat combustion air to furnaces integration with existing steam network in the case of a new unit being built on the site or modification of an existing network where units are closed 	+	+
Emissions monitoring, management and trading: certain gaseous emissions (SO _x and CO ₂) can be directly related to fuels burnt (where the fuel composition and variation are accurately known). NO _x requires predictive models, as its formation depends on fuel, flame temperature, equipment, etc. A utilities optimiser can include emissions prediction and reporting, where the permit requires this (e.g. for ELV compliance). The optimiser can also support decision-making for emissions management and trading by predicting demands and corresponding emissions	+	+
Contract management: (see Section 7.11): an optimiser provides an operator with data to minimise and move peak demands	(+)	+
Tariff evaluation: utilities deregulation has led to a bewildering array of tariff options. Manual calculation and choice is not sufficiently accurate and rapid, and this is automated for large users		+
Electricity and fuel trading: process industries are increasingly investing in co- and trigeneration, with the ability to export energy. This complicates tariff evaluation and an optimiser supports efficient energy trading		+
Cost accounting: a utilities optimiser provides accurate cost allocation in real time and also provides true marginal costs. This can support decision making in varying energy sources		+

Table 2.7: Business process drivers for using a utilities optimiser

Examples

1. Schott AG, DE. See Annex 7.7.1

Costs:

- software: about EUR 50 000
- hardware: about EUR 500/measuring point.

Savings per year:

- peak load lowering at delivery of electricity: about 3 to 5 %
- payback period: about 0.9 to 2 years (dependent on project).

2. Atrium Hospital, Heerleen, NL. See Annex 7.7.2

A real-time utilities management system was installed, with an internal ROI of 49 % (at about EUR 75 000 – 95 000/yr on a variable energy cost of about EUR 1.2 million.

Valero Energy Corporation, Refinery, Houston, Texas, US

A utilities optimiser for a petroleum system was installed in 2002. First year benefits have been identified of EUR 3.06 million, including reduced imports of NG and electricity.

DSM, chemical plant, Geleen, NL

Benefits have been identified as an ROI of >25 %, with 3 to 4 % saving in total site energy costs, resulting from both energy savings and more favourable contract arrangements with suppliers.

Reference information

- general information, Valero and DSM examples: [171, de Smedt P. Petela E., 2006]
- Schott glass:[127, TWG]
- Atrium hospital [179, Stijns, 2005].

2.16 Benchmarking

Description

At its simplest, a benchmark is a reference point. In business, benchmarking is the process used by a firm or organisation to evaluate various aspects of their processes in relation to best practice, usually within their own sector. The process has been described as:

- ‘benchmarking is about making comparisons with other companies and then learning the lessons which those companies each show up’ (The European Benchmarking Code of Conduct)
- ‘benchmarking is the practice of being humble enough to admit that someone else is better at something, and being wise enough to learn how to be as good as them and even better’ (American Productivity and Quality Center).

Benchmarking is a powerful tool to help overcome 'paradigm blindness' (which can be expressed as: 'the way we do it is best, because we've always done it this way'). It can therefore be used to assist continuous improvement and maintaining impetus (see Sections 2.2.1 and 2.5).

Energy benchmarking takes data that have been collected and analysed (see measurement and monitoring and energy audit, in Sections 2.10 and 2.11). Energy efficiency indicators are then established that enable the operator to assess the performance of the installation over time, or with others in the same sector. Sections 1.3, 1.4 and 1.5 discuss the issues relating to establishing and using indicators.

It is important to note that the criteria used in the data collection are traceable, and kept up to date.

Data confidentiality may be important in certain cases (e.g. where energy is a significant part of the cost of production). Therefore, it is essential to take into account the views of the participating companies and sector associations to safeguard the confidentiality of company data and to ensure the user-friendliness of the instruments. Confidentiality can be protected by:

- agreement
- presenting data in a way that protects the confidential data (e.g. presenting data and targets aggregated for several installations or products)
- having data collated by a trusted third party (e.g. trade organisation, government agency).

Benchmarking may also apply to processes and working methods (see also Operational excellence, Section 2.5, and Examples below).

Energy data gathering should be undertaken carefully. Data should be comparable. In some cases, the data may need correction factors (normalisation). For instance, to take account of feedstock, age of equipment, etc. (see glass industry benchmarking, below), and these should be agreed at the appropriate level (e.g. nationally, internationally). Key examples are to ensure that energy is compared on a suitable basis, such as prime energy, on lower calorific values, etc. see Sections 1.3, 1.4 and 1.5.

Assessment can be made on a time-series basis. This:

- illustrates the benefit of a measure (or group of measures) for overall energy consumption (either in-house or to a sector, region, etc.)
- is a simple method which can be applied internally if the required reference data are available, and where it is difficult to establish external benchmarks.

The main disadvantage of the time-series comparison is that the underlying conditions must stay the same to enable an assessment of the energy efficiency.

Assessment can also be made against the theoretical energy or enthalpy demand (see glass industry benchmarking in the Examples, below). These are calculated from the thermal energies, melting energies, kinetic or potential energies, for a process. They:

- are a good approach for initial estimates
- should be relatively easy to use with relevant experience
- should show the distance between actual energy usage and the theoretical demand (this may be coupled to a time-series comparison to help establish the cost-benefit of further measures).

The main disadvantage is that the calculation can never take all the specific characteristics of an operation into account.

Achieved environmental benefits

A powerful tool to assist implementation of energy efficiency measures on an ongoing basis.

Cross-media effects

None known.

Operational data

See Description.

Applicability

Benchmarking can be readily used by any installation, group of companies, installations or trade association. It may also be useful or necessary to benchmark individual units, processes or utilities, such as those discussed in Chapter 3 (see also Sections 1.3, 1.4 and 1.5).

Validated data includes those in vertical sector BREFs, or those verified by a third party.

The period between benchmarkings is sector-specific and usually long (i.e. years), as benchmark data rarely change rapidly or significantly in a short time period.

There are competitiveness issues to be addressed, so confidentiality of the data may need to be addressed. For instance, the results of benchmarking may remain confidential, or it may not be possible to benchmark, e.g. where only one or a small number of plants in the EU or in the world make the same product.

Economics

The main cost may be in the data gathering. However, further costs are incurred in establishing data on a wider basis, and collecting the modelling normalisation data.

Driving force for implementation

Cost savings.

Examples

Details of these benchmarking activities are given in Annex 7.9.

Austrian Energy Agency

The Austrian Energy Agency's (AEA) report 'Energy benchmarking at the company level, company report diary' gives benchmarking factors other than specific energy consumption.

Scheme for SMEs in Norway

Norway has a web-based benchmarking scheme for SMEs.

Benchmarking covenants

In the Netherlands, long-term agreements (covenants) between the government and large companies (consuming over 0.5 PJ/year) are based on benchmarking. A similar scheme operates in Flanders Province, Belgium.

Glass industry benchmarking

The glass industry is investigating several methods to identify the most energy efficient glass-melting operations; and some results have been published:

- best practice methods and applications of energy balances
- determination of the theoretical energy or enthalpy demand and the lowest practical level of energy consumption
- benchmarking of specific consumptions of industrial glass furnaces
- development of new melting and fining techniques.

Allocation of energy/CO₂ emissions between different products in a complex process with successive steps, France

The French starch industry, with consultancy support, has developed a methodology of assessment/allocations of the energy in the starch and derivatives production process. This methodology has been used:

- to allocate energy uses at different processing steps and for different kinds of products
- to allocate CO₂ emissions at different processing steps and for different kinds of products
- to measure improvements in energy use

It can therefore be used as a benchmarking tool.

Reference information

[10, L ayer, 1999, 13, Dijkstra, , 1 08, Intelligent Energy - Europe, 2005, 1 27, TWG, , 156 , Beerkens, 2004, 157, Beerkens R.G.C. , 2006, 163, Dow, 2005, 227, TWG]

2.17 Other tools

Some other tools that may be used at a site level for audit and energy management are listed in Annex 7.8

3 TECHNIQUES TO CONSIDER TO ACHIEVE ENERGY EFFICIENCY IN ENERGY-USING SYSTEMS, PROCESSES, OR ACTIVITIES

A hierarchical approach has been used for Chapters 2 and 3:

- Chapter 2 describes techniques to be considered at the level of a entire installation with the potential to achieve optimum energy efficiency
- Chapter 3 sets out techniques to be considered at a level below installation: primarily the level of energy-using systems (e.g. compressed air, steam) or activities (e.g. combustion), and subsequently at the lower level for some energy-using component parts or equipment (e.g. motors).

Management systems, process-integrated techniques and specific technical measures are included in the two chapters, but these three measures overlap completely when seeking the optimum results. Many examples of an integrated approach demonstrate all three types of measures. This makes the separation of techniques for description somewhat difficult and arbitrary.

Neither this chapter nor Chapter 2 gives an exhaustive list of techniques and tools, and other techniques may exist or be developed which may be equally valid within the framework of IPPC and BAT. Techniques may be used singly or as combinations (both from this chapter and from Chapter 2) and are supported by information given in Chapter 1 to achieve the objectives of IPPC.

Where possible, a standard structure is used to outline each technique in this chapter and in Chapter 2 as shown in Table 3.1. Note that this structure is also used to describe the systems under consideration, such as (at installation level) energy management, and (at a lower level) compressed air, combustion, etc.

Type of information considered	Type of information included
Description	Short descriptions of energy efficiency techniques presented with figures, pictures, flow sheets, etc. that demonstrate the techniques
Achieved environmental benefits	The main environmental benefits supported by the appropriate measured emission and consumption data. In this document, specifically the increase of energy efficiency, but including any information on reduction of other pollutants and consumption levels
Cross-media effects	Any environmental side-effects and disadvantages caused by implementation of the technique. Details on the environmental problems of the technique in comparison with others
Operational data	Performance data on energy and other consumptions (raw materials and water) and on emissions/wastes. Any other useful information on how to operate, maintain and control the technique, including safety aspects, operational constraints of the technique, output quality, etc.
Applicability	Consideration of the factors involved in applying and retrofitting the technique (e.g. space availability, process specific, other constraints or disadvantages of the technique)
Economics	Information on costs (investment and operation) and related energy savings, EUR kWh (thermal and/or electricity) and other possible savings (e.g. reduced raw material consumption, waste charges) also as related to the capacity of the technique
Driving force for implementation	Reasons (other than the IPPC Directive) for implementation of the technique (e.g. legislation, voluntary commitments, economic reasons)
Examples	Reference to at least one situation where the technique is reported to be used
Reference information	Sources of information used in writing the section and/or containing more details

Table 3.1: The information breakdown for systems and techniques described in Chapters 2 and 3

3.1 Combustion

Introduction

Combustion or burning is a complex sequence of exothermic chemical reactions between a fuel and an oxidant accompanied by the production of heat or both heat and light in the form of either a glow or flames.

In a complete combustion reaction, a compound reacts with an oxidising element, and the products are compounds of each element in the fuel with the oxidising element. In reality, combustion processes are never perfect or complete. In flue-gases from the combustion of carbon (coal combustion) or carbon compounds (hydrocarbons, wood, etc.), both unburnt carbon (as soot) and carbon compounds (CO and others) will be present. Also, when air is the oxidant, some nitrogen will be oxidised to various nitrogen oxides (NO_x) with impacts on the environment [122, Wikipedia_Combustion, 2007].

Combustion installations

The combustion installations discussed in this section are heating devices or installations using the combustion of a fuel (including wastes) to generate and transfer heat to a given process. This includes the following applications:

- boilers to produce steam or hot water (see also Section 3.2)
- process heaters, for example to heat up crude oil in distillation units, to achieve steam cracking in petrochemical plants, or steam reforming for the production of hydrogen
- furnaces or units where materials are heated at elevated temperatures to induce a chemical transformation, for example, cement kilns and furnaces for producing metals.

In all of these applications, energy can be managed by control of the process parameters and control on the combustion side. Energy management strategies relative to the process depend on the process itself and are considered in relevant sector BREFs.

Losses in a combustion process

The heat energy resulting from the combustion of fuels is transferred to the working medium. The heat losses can be categorised as [125, EIPPCB]:

- losses via the flue-gas. These depend on the flue-gas temperature, air mix, fuel composition and the level of fouling of the boiler
- losses through unburnt fuel, the chemical energy of that which is not converted. Incomplete combustion causes CO and hydrocarbons to occur in the flue-gas
- losses through conduction and radiation. In steam generation, these mainly depend on the quality of insulation of the steam generator and steam pipes
- losses through unburnt material in the residues, including losses coming from unburnt carbon via the bottom and fly ash from a dry bottom boiler (DBB) and the slag and fly ash from a wet bottom boiler (WBB)
- losses through blowdown in boilers for steam generation.

In addition to the heat losses, the energy consumption needed for the operation of auxiliary machinery (fuel transport equipment, coal mills, pumps and fans, ash removal systems, cleaning of the heating surfaces, etc.) also has to be taken into consideration.

Choice of combustion techniques

Common techniques for energy generation in large combustion plants (>50 MW thermal power) and with different fuels (e.g. biomass and peat, liquid or gaseous fuels) are discussed in detail in the LCP BREF. The LCP BREF states that the information provided is also valid for smaller plants (as a plant of >50 MW thermal power may consist of more than one smaller units).

To assist the reader, an overview of the techniques both in this document and the LCP BREF¹⁹ which contribute to energy efficiency in combustion is shown in Table 3.2. In order to avoid duplicating information, the combustion techniques already covered in the LCP BREF have not been dealt with in this document. The reader's attention is therefore directed to the LCP BREF for further details on those techniques. However, in some cases additional information about techniques already covered by LCP BREF has been included in this document. Note that the LCP BREF classifies the combustion techniques to be considered for the determination of BAT according to the type of fuel used. The applicability of techniques may vary according to the site.

When combustion is an important part of an IPPC process (such as melting furnaces), the techniques used are discussed in the appropriate vertical BREFs.

	Techniques for sectors and associated activities where combustion is not covered by a vertical BREF				
	Techniques in the LCP BREF July 2006 by fuel type and section				Techniques in this document by section
	Coal and lignite	Biomass and peat	Liquid fuels	Gaseous fuels	
Lignite pre-drying	4.4.2				
Coal gasification	4.1.9.1, 4.4.2 and 7.1.2				
Fuel drying		5.1.2, 5.4.2, 5.4.4			
Biomass gasification		5.4.2, 7.1.2			
Bark pressing		5.4.2, 5.4.4			
Expansion turbine to recover the energy content of pressurised gases				7.1.1, 7.1.2, 7.4.1, 7.5.1	
Cogeneration 4.	5.5, 6.1.8	5.3.3, 5.5.4	4.5.5, 6.1.8	7.1.6, 7.5.2	3.4 Cogeneration
Advanced computerised control of combustion conditions for emission reduction and boiler performance	4.2.1, 4.2.1.9, 4.4.3, 4.5.4	5.5.3, 6.	2.1, 6.2.1.1, 6.4.2, 6.5.3.1	7.4.2, 7.5.2	
Use of the heat content of the flue-gas for district heating	4.4.3				
Low excess air	4.4.3, 4.4.6	5.4.7, 6	.4.2, 6.4.5	7.4.3	3.1.3 Reducing the mass flow of the flue-gases by reducing the excess air

¹⁹ Reference relates to LCP BREF July 2006 edition

	Techniques for sectors and associated activities where combustion is not covered by a vertical BREF				
	Techniques in the LCP BREF July 2006 by fuel type and section			Techniques in this document by section	
	Coal and lignite	Biomass and peat	Liquid fuels	Gaseous fuels	
Lowering of exhaust gas temperatures	4.4.3		6.4.2		<p>3.1.1: Reducing the flue-gas temperature by</p> <ul style="list-style-type: none"> dimensioning for the maximum performance plus a calculated safety factor for surcharges increasing heat transfer to the process by increasing either the heat transfer rate, or increasing or improving the heat transfer surfaces heat recovery by combining an additional process (for example, steam generation by using economisers,) to recover the waste heat in the flue-gases installing an air or water preheater (see 3.1.1.1) or preheating the fuel by exchanging heat with flue-gases (see 3.1.1). Note that the process can require air preheating when a high flame temperature is needed (glass, cement, etc.) cleaning of heat transfer surfaces that are progressively covered by ashes or carbonaceous particulates, in order to maintain high heat transfer efficiency. Soot blowers operating periodically may keep the convection zones clean. Cleaning of the heat transfer surfaces in the combustion zone is generally made during inspection and maintenance shutdown, but online cleaning can be applied in some cases (e.g. refinery heaters)
Low CO concentration in the flue-gas	4.4.3		6.4.2		
Heat accumulation			6.4.2	7.4.2	
Cooling tower discharge	4.4.3		6.4.2		
Various techniques for the cooling system (see the ICS BREF)	4.4.3		6.4.2		

	Techniques for sectors and associated activities where combustion is not covered by a vertical BREF				
	Techniques in the LCP BREF July 2006 by fuel type and section				Techniques in this document by section
	Coal and lignite	Biomass and peat	Liquid fuels	Gaseous fuels	
Preheating of fuel gas by using waste heat				7.4.2	3.1.1 Reduction of flue-gas temperature, <ul style="list-style-type: none"> preheating the fuel by exchanging heat with flue-gases (see Section 3.1.1). Note that the process can require air preheating when a high flame temperature is needed (glass, cement, etc.)
Preheating of combustion air				7.4.2	3.1.1 Reduction of flue-gas temperature <ul style="list-style-type: none"> installing an air preheater by exchanging heat with flue-gases (see Section 3.1.1.1). Note that the process can require air preheating when a high flame temperature is needed (glass, cement, etc.)
Recuperative and regenerative burners					3.1.2
Burner regulation and control					3.1.4
Fuel choice					3.1.5
Oxy-firing (oxyfuel)					3.1.6
Reducing heat losses by insulation					3.1.7
Reducing losses through furnace doors					3.1.8
Fluidised bed combustion	4.1.4.2 5.	2.3			

Table 3.2: Overview of combustion techniques contributing to energy efficiency in LCP and ENE BREFs
[236, Fernández-Ramos, 2007]

Steam side issues are fully discussed in Section 3.2 although a partial overlap with this Section cannot be avoided.

General energy balance

The following information is relevant for both flame combustion (using a burner) and combustion in a fluidised bed. It addresses energy management on the combustion side only, from the fuel and air inlets to the flue-gases exhaust at the stack.

The general energy balance of a combustion installation when process temperatures are low, is given in Figure 1.1.

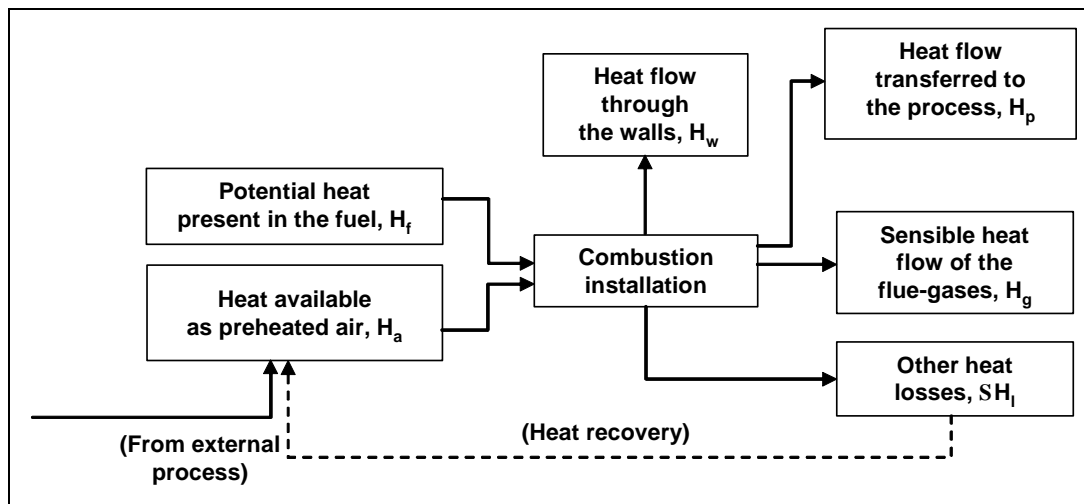

Figure 3.1: Energy balance of a combustion installation
[91, CEFIC, 2005]

Explanation of the different energy flows

The potential heat present in the fuel H_f is based on its mass flowrate and its calorific value (the amount of energy that is liberated by the combustion of a specific mass of fuel). The calorific value is expressed as MJ/kg. The higher or gross heating value (HHV, or higher calorific value HCV) of a fuel is the total heat developed after the products of combustion are cooled to the original fuel temperature. The lower heating value (LHV) is the total heat produced on combustion less the energy in the uncooled products of combustion, including uncondensed water vapour. The LCV of a fuel is typically 5 – 10 % less than the HCV. (For a further explanation and some typical values, see Section 1.3.6.2).

The heat transferred to the process H_p is the energy released by the combustion process of the combustion system. It is made of sensible heat (increase of temperature), latent heat of vaporisation (if the heated fluid is partially or completely vaporised), and chemical heat (if an endothermic chemical reaction occurs).

The waste heat flow of the flue-gases H_g is released to the air and lost. It is based on the flowrate of the flue-gases, its heat capacity, the latent heat of the water formed by combustion and present in the flue-gases and its temperature. The flowrate of flue-gases can be divided into two parts:

- the ‘stoichiometric flow’ of CO_2 and H_2O which results from the combustion reactions and its associated nitrogen (this stoichiometric flow is proportional to H_f) and
- the flow of excess air, which is the amount of air introduced in excess over the stoichiometric one in order to achieve complete combustion. There is a direct relation between air excess and the concentration of oxygen in the flue-gases.

The heat flow through the walls H_w is the energy that is lost to the surrounding air by heat transfer from the furnace/boiler outer surface to the ambient air. Other heat losses are termed altogether as ΣH_l and include:

- unoxidised or partially oxidised residues, such as carbon, CO, etc.
- heat content of the solid residues (ashes).

Basically, the conservation of energy gives:

$$H_f + H_a = H_p + H_g + H_w + \Sigma H_l \quad \text{Equation 3.1}$$

This is a generic balance, which can be adapted case by case by H_a and ΣH_i :

- depending on the configuration, other energy flows may have to be included in the balance. This is the case if other materials are added to or lost from the furnace, for example:
 - hot ashes in coal combustion
 - water injected into the combustion chamber to control emissions
 - the energy content of the combustion air
- this balance assumes that combustion is complete: this is reasonable as long as unburnt components like carbon monoxide or carbonaceous particulates are in small quantities in the flue-gases, which is the case when the installation matches the emission limits²⁰.

The energy efficiency of a combustion installation

Basically, the energy efficiency of a combustion installation is the ratio of the energy released by the combustion process to the energy input by the fuel:

$$\eta = \frac{H_p}{H_f} \quad \text{Equation 3.2}$$

Or combining with Equation 3.1:

$$\eta = 1 - \frac{H_g + H_w}{H_f} \quad \text{Equation 3.3}$$

Both formulas can be used, but it is generally more practical to use Equation 3.3 which shows the amount of lost energies where savings can be obtained. Strategies towards energy efficiency are based on reducing heat flows lost through the walls or in the flue-gases.

An improvement in the energy efficiency of a combustion installation has a benefit in CO₂ emissions if it results in a reduction of the fuel consumption. In this case, the CO₂ is reduced in proportion to the carbon content of the fuel saved. However, the improvement of efficiency may also be used to increase the energy released by the combustion process while keeping the same fuel flowrate (higher H_p for the same H_f in Equation 3.2). This may increase the capacity of the production unit while improving the energy efficiency. In this case, there is a CO₂ specific emissions reduction (referred to the production level) but no CO₂ emissions reduction in absolute value (see Section 1.4.1).

Energy efficiency values and calculations for various combustion processes can be found in sector B REFs and other sources. For example, EN 12952-15 on calculating the energy efficiency of water-tube steam boilers and auxiliary installations, or EN 12953-11 on shell boilers.

²⁰ In a pulverised coal power plant, the unburnt carbon in fly ash, under normal current conditions, is below 5 %.

3.1.1 Reduction of the flue-gas temperature

Description

One option to reduce possible heat losses in a combustion process consists of reducing the temperature of the flue-gases leaving the stack. This can be achieved by:

- dimensioning for the maximum performance plus a calculated safety factor for surcharges
- increasing heat transfer to the process by increasing either the heat transfer rate, (installing turbulators or some other devices which promote the turbulence of fluids exchanging heat), or increasing or improving the heat transfer surfaces
- heat recovery by combining an additional process (for example, steam generation by using economisers, see Section 3.2.5) to recover the waste heat in the flue-gases
- installing an air (or water) preheater or preheating the fuel by exchanging heat with flue-gases (see Section 3.1.1.1). Note that the manufacturing process can require air preheating when a high flame temperature is needed (glass, cement, etc.). Preheated water can be used as boiler feed or in hot water systems (such as district schemes)
- cleaning of heat transfer surfaces that are progressively covered by ashes or carbonaceous particulates, in order to maintain high heat transfer efficiency. Soot blowers operating periodically may keep the convection zones clean. Cleaning of the heat transfer surfaces in the combustion zone is generally made during inspection and maintenance shutdown, but online cleaning can be applied in some cases (e.g. refinery heaters)
- ensuring combustion output matches (and does not exceed) the heat requirements. This can be controlled by lowering the thermal power of the burner by decreasing the flowrate of fuel, e.g. by installing a less powerful nozzle for liquid fuels, or reducing the feed pressure for gaseous fuels.

Achieved environmental benefits

Energy savings.

Cross-media effects

Reducing flue-gas temperatures may be in conflict with air quality in some cases, e.g:

- preheating combustion air leads to a higher flame temperature, with a consequence of an increase of NO_x formation that may lead to levels that are higher than the emissions limit value. Retrofitting an existing combustion installation to preheat the air may be difficult to justify due to space requirements, the installation of extra fans, and the addition of a NO_x removal process if NO_x emissions exceed emission limit values. It should be noted that a NO_x removal process based on ammonia or urea injection induces a potential of ammonia slippage in the flue-gases, which can only be controlled by a costly ammonia sensor and a control loop, and, in case of large load variations, adding a complicated injection system (for example, with two injection ramps at different levels) to inject the NO_x reducing agent in the right temperature zone
- gas cleaning systems, like NO_x or SO_x removal systems, only work in a given temperature range. When they have to be installed to meet the emission limit values, the arrangement of gas cleaning and heat recovery systems becomes more complicated and can be difficult to justify from an economic point of view
- in some cases, the local authorities require a minimum temperature at the stack to ensure proper dispersion of the flue-gases and to prevent plume formation. This practice is often carried out to maintain a good public image. A plume from a plant's stack may suggest to the general public that the plant is causing pollution. The absence of a plume suggests clean operation and under certain weather conditions some plants (e.g. in the case of waste incinerators) reheat the flue-gases with natural gas before they are released from the stack. This is a waste of energy.

Operational data

The lower the flue-gas temperature, the better the energy efficiency. Nevertheless, certain drawbacks can emerge when the flue-gas temperatures are lowered below certain levels. In particular, when running below the acid dew point (a temperature below which the condensation of water and sulphuric acid occurs, typically from 110 to 170 °C, depending essentially on the fuel's sulphur content), damage of metallic surfaces may be induced. Materials which are resistant to corrosion can be used and are available for oil, waste and gas fired units although the acid condensate may require collection and treatment.

Applicability

The strategies above – apart the periodic cleaning – require additional investment and are best applied at the design and construction of the installation. However, retrofitting an existing installation is possible (if space is available).

Some applications may be limited by the difference between the process inlet temperature and the flue-gas exhaust temperature. The quantitative value of the difference is the result of a compromise between the energy recovery and cost of equipment.

Recovery of heat is always dependent on there being a suitable use (see Section 3.3).

See the potential for pollutant formation, in Cross-media effects, above.

Economics

Payback time can be from under five years to as long as to fifty years depending on many parameters, such as the size of the installation, and the temperatures of the flue gases.

Driving force for implementation

Increased process efficiency where there is direct heating (e.g. glass, cement).

Examples

Widely used.

Reference information

[17, Åsblom, 2005, 26, Neisecke, 2003, 122, Wikipedia_Combustion, 2007, 125, EIPPCB]

3.1.1.1 Installing an air or water preheater**Description**

Besides an economiser (Section 3.2.5), an air preheater (air-air heat exchanger) can also be installed. The air preheater or APH heats the air which flows to the burner. This means flue-gases can be cooled down even more, as the air is often at ambient temperature. A higher air temperature improves combustion, and the general efficiency of the boiler will increase. In general for every decrease of 20 °C in flue-gas temperature, a 1 % increase in efficiency can be achieved. A scheme of a combustion system with an air preheater is shown in Figure 3.2.

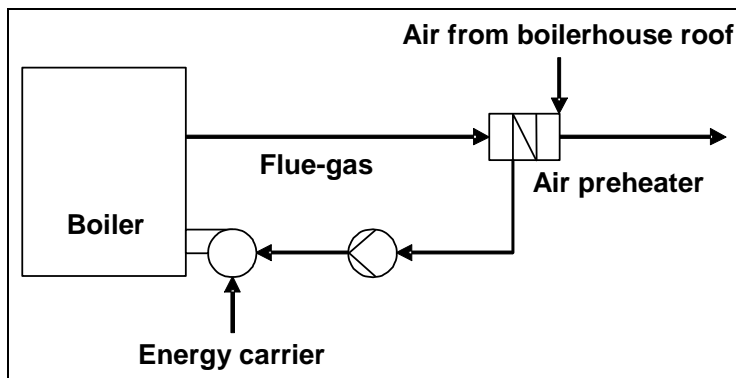

Figure 3.2.: Scheme of a combustion system with an air preheater
[28, Berger, 2005]

A less efficient but simpler way of preheating might be to install the air intake of the burner on the ceiling of the boilerhouse. Generally, the air here is often 10 to 20 °C warmer compared to the outdoor temperature. This might compensate in part for efficiency losses.

Another solution is to draw air for the burner via a double walled exhaust pipe. Flue-gases exit the boiler room via the inner pipe, and air for the burner is drawn via the second layer. This can preheat the air via losses from the flue-gases.

Alternatively, an air-water heat exchanger can be installed

Achieved environmental benefits

In practice, an APH can raise efficiency by 3 to 5 %.

Other benefits of an APH might be:

- that the hot air can be used to dry fuel. This is especially applicable for coal or organic fuel
- that a smaller boiler can be used when taking into account an APH at the design stage
- used to preheat raw materials.

Cross-media effects

There are, however, also some practical disadvantages related to an APH, which often inhibit installation:

- the APH is a gas-gas heat exchanger, and thus takes up a lot of space. The heat exchange is also not as efficient as a gas-water exchange
- a higher drop pressure of the flue-gases means the ventilator of the burner has to provide higher pressure
- the burner must ensure that the system is fed with preheated air. Heated air uses up more volume. This also poses a bigger problem for flame stability
- there may be higher emissions of NO_x due to higher flame temperatures.

Operational data

Feeding the burner with heated air has an impact on the amount of flue-gas losses in the boiler.

The percentage of flue-gas losses is generally determined using the Siegert formula:

$$W_L = \frac{H_g}{H_f} = c \cdot \frac{T_{\text{gas}} - T_{\text{air}}}{\% \text{CO}_2} \quad \text{Equation 3.4}$$

where:

- W_L = the flue-gas losses, in % of the burning value (%)
- c = the Siegert coefficient
- T_{gas} = the flue-gas temperature measured (°C)
- T_{air} = supply air temperature (°C)
- $\% \text{CO}_2$ = measured CO_2 concentration in the flue-gases expressed as a percentage.

The Siegert coefficient depends on the flue-gas temperature, the CO_2 concentration and the type of fuel. The various values can be found in Table 3.3 below:

Type of fuel	Siegert coefficient
Anthracite	$0.6459 + 0.0000220 \times t_{\text{gas}} + 0.00473 \times \text{CO}_2$
Heavy fuel	$0.5374 + 0.0000181 \times t_{\text{gas}} + 0.00717 \times \text{CO}_2$
Petrol	$0.5076 + 0.0000171 \times t_{\text{gas}} + 0.00774 \times \text{CO}_2$
Natural gas (LCV)	$0.385 + 0.00870 \times \text{CO}_2$
Natural gas (HCV)	$0.390 + 0.00860 \times \text{CO}_2$

Table 3.3: Calculation of the Siegert coefficient for different types of fuel
[29, Maes, 2005]

Example: a steam boiler fired with high quality natural gas has the following flue-gas data: $t_{\text{gas}} = 240$ °C and $\text{CO}_2 = 9.8$ %. The air supply is modified and the hotter air near the ceiling of the boiler house is taken in. Previously the air was taken in at outdoor temperature.

The average outdoor temperature is 10 °C, while the average temperature near the ceiling of the boiler house is 30 °C.

The Siegert coefficient in this case is: $0.390 + 0.00860 \times 9.8 = 0.4743$.

Prior to the intervention, the flue-gas loss was:

$$W_R = 0.4743 \times \frac{240 - 10}{9.8} = 11.1 \%$$

After the intervention this becomes:

$$W_R = 0.4743 \times \frac{240 - 30}{9.8} = 10.2 \%$$

This amounts to an increase in efficiency of 0.9 % where this can be achieved simply, e.g. by repositioning air intake.

Applicability

The installation of an air preheater is cost effective for a new boiler. The change in air supply or the installation of the APH often is limited due to technical reasons or fire safety. The fitting of an APH in an existing boiler is often too complex and has a limited efficiency.

Air preheaters are gas-gas heat exchangers, whose designs depend on the range of temperatures. Air preheating is not possible for natural draught burners.

Preheated water can be used as boiler feed or in hot water systems (such as district schemes).

Economics

In practice, the possible savings from combustion air preheating amount to several per cent of the steam volume generated, as shown in Table 3.4. Therefore, the energy savings even in small boilers can be in the range of several GWh per year. For example, with a 15 MW boiler, savings of roughly 2 GWh/yr, some EUR 30 000/yr and about 400 t CO₂/yr can be attained.

	Unit	Value
Energy savings	MWh/yr	Several thousand
CO ₂ reduction	t/yr	Several hundred
Savings in EUR	EUR/yr	Tens of thousands
Annual operating hours	h/yr	8700

Table 3.4: Possible savings in combustion air preheating
[28, Berger, 2005]

Driving force for implementation

Increased energy efficiency of processes.

Examples

Widely used.

Reference information

[29, Maes, 2005], [16, CIPEC, 2002]

3.1.2 Recuperative and regenerative burners

One major problem for industrial furnace heating processes is the energy losses. With conventional technology about 70 % of the heat input is lost through flue-gases at temperatures of a round 1300 °C. Energy savings measures therefore play an important role especially for high temperature processes (temperatures from 400 to 1600 °C).

Description

Recuperative and regenerative burners have thus been developed for direct waste heat recovery through combustion air preheating. A recuperator is a heat exchanger that extracts heat from the furnace waste gases to preheat the incoming combustion air. Compared with cold air combustion systems, recuperators can be expected to achieve energy savings of around 30 %. They will, however, normally only preheat the air to a maximum of 550 – 600 °C. Recuperative burners can be used in high temperature processes (700 – 1100 °C).

Regenerative burners operate in pairs and work on the principle of short term heat storage using ceramic heat regenerators, see Figure 3.3. They recover between 85 – 90 % of the heat from the furnace waste gases; therefore, the incoming combustion air can be preheated to very high temperatures of up to 1000 – 1500 °C below the furnace operating temperature. Application temperatures range from 800 up to 1500 °C. Fuel consumption can be reduced by up to 60 %.

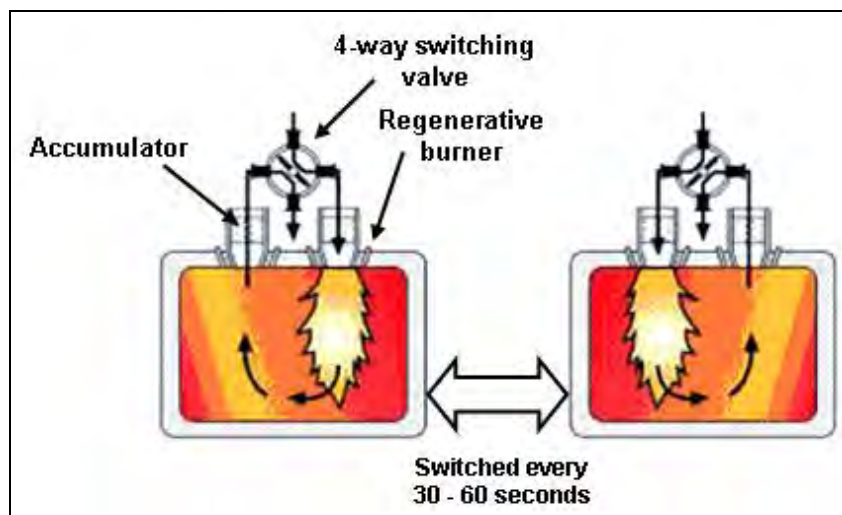

Figure 3.3. Working principle for regenerative burners
[17, Åsbländ, 2005]

Recuperative and regenerative burners (HiTAC technology) are being implemented in a novel combustion mode with homogeneous flame temperature (flameless combustion, see Section 5.1), without the temperature peaks of a conventional flame, in a substantially extended combustion zone. Figure 3.4 shows the different regions of combustion at varying oxygen concentrations and air temperature.

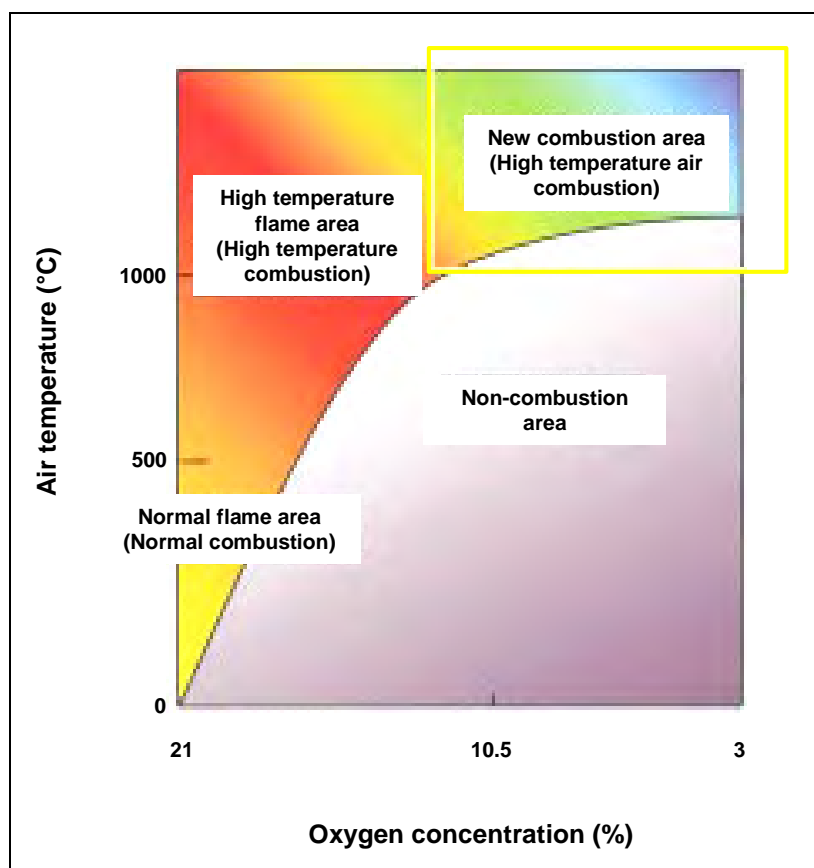

Figure 3.4: Different regions of combustion
[17, Åsbländ, 2005]

Achieved environmental benefits

Energy savings.

Cross-media effects

The important constraint of state-of-the-art recuperative/regenerative burner technology is the conflict between technologies designed to reduce emissions and to focus on energy efficiency. The NO_x formation, for fuels not containing nitrogen, is basically a function of temperature, oxygen concentration, and residence time. Due to high temperatures of the preheated air, and the residence time, conventional flames have high peak temperature which leads to strongly increase NO_x emissions.

Operational data

In the industrial furnace, the combustion air can be obtained at temperatures of 800 – 1350 °C using a high performance heat exchanger. For example, a modern regenerative heat exchanger switched to the high cycle can recover as much as 90 % of the waste heat. Thus, a large energy saving is achieved.

Applicability

Widely used.

Economics

A drawback with these burners is the investment cost. The decreased costs for energy can rather seldom alone compensate the higher investment cost. Therefore, higher productivity in the furnace and lower emissions of nitrogen oxides are important factors to be included in the cost benefit analysis.

Driving force for implementation

Higher productivity in the furnace and lower emissions of nitrogen oxides are important factors.

Example plants

Widely used.

Reference information

[220, Blasiak W., 2004, 221, Yang W., 25 May 2005, 222, Yang W., 2005, 223, Rafidi N., 2005, 224, Mörtberg M., 2005, 225, Rafidi N., June 2005, 226, CADDET, 2003, March]

3.1.3 Reducing the mass flow of the flue-gases by reducing the excess air

Description

Excess air can be minimised by adjusting the air flowrate in proportion to the fuel flowrate. This is greatly assisted by the automated measurement of oxygen content in the flue-gases. Depending on how fast the heat demand of the process fluctuates, excess air can be manually set or automatically controlled. Too low an air level causes extinction of the flame, then re-ignition and backfire causing damage to the installation. For safety reasons, there should therefore always be some excess air present (typically 1 – 2 % for gas and 10 % for liquid fuels).

Achieved environmental benefits

Energy savings.

Cross-media effects

As excess air is reduced, unburnt components like carbonaceous particulates, carbon monoxide and hydrocarbons are formed and may exceed emission limit values. This limits the possibility of energy efficiency gain by reducing excess air. In practice, excess air is adjusted to values where emissions are below the limit value.

Operational data

Reduction of excess air is limited due to the related increase of raw gas temperature; extremely high temperatures can damage the whole system.

Applicability

The minimum excess air that is reachable to maintain emissions within the limit depends on the burner and the process.

Note that the excess air will increase when burning solid wastes. However, waste incinerators are constructed to provide the service of waste combustion, and are optimised to waste as fuel.

Economics

The choice of fuels is often based on cost and may also be influenced by legislation and regulations.

Driving force for implementation

Achieves a higher process temperature, especially when direct firing.

Examples

Some cement and lime and waste-to-energy plants.

Reference information

[91, CEFIC, 2005, 125, EIPPCB][126, EIPPCB]

3.1.4 Burner regulation and control**Description**

Automatic burner regulation and control can be used to control combustion by monitoring and controlling fuel flow, air flow, oxygen levels in the flue-gas and heat demand. See also Sections 2.10, 2.15.2 and 3.1.3.

Achieved environmental benefits

This achieves energy savings by reducing excess air flow and optimising fuel usage to optimise burnout and to supply only the heat required for a process.

It can be used to minimise NO_x formation in the combustion process.

Cross-media effects

None foreseen.

Operational data

There will be an initial set-up stage, with periodic recalibration of the automatic controls.

Applicability

Widely applied.

Economics

Cost effective, and the payback period is site-specific.

Driving force for implementation

Cost savings on fuel use.

Examples

No data submitted.

Reference information

[227, TWG]

3.1.5 Fuel choice

Description

The type of fuel chosen for the combustion process affects the amount of heat energy supplied per unit of fuel used (see Introduction to Section 3.1 and Section 1.3.6.2). The required excess air ratio (see Section 3.1.3) is dependent on the fuel used, and this dependence increases for solids. The choice of fuel is therefore an option for reducing excess air and increasing energy efficiency in the combustion process. Generally, the higher the heat value of the fuel, the more efficient the combustion process.

Achieved environmental benefits

This achieves energy savings by reducing excess air flow and optimising fuel usage. Some fuels produce less pollutants during combustion, depending on source (e.g. natural gas contains very little sulphur to oxidise to SO_x, no metals). There is information on these emissions and benefits in various vertical sector BREFs where fuel choice is known to have a significant effect on emissions.

The choice of using a fuel with a lower heat value may be influenced by other environmental factors, such as (see Section 1.1.3):

- fuel from a sustainable source
- recovery of thermal energy from waste gases, waste liquids or solids used as fuels
- the minimisation of other environmental impacts, e.g. transport.

Cross-media effects

Various emissions are associated with certain fuels, e.g. particulates, SO_x, and metals are associated with coals. There is information on these effects in various vertical sector BREFs where fuel choice is known to have a significant effect on emissions.

Operational data

None given.

Applicability

Widely applied during the selection of a design for a new or upgraded plant.

For existing plants, the choice of fuels will be limited by the combustion plant design (i.e. a coal fire plant may not be readily converted to burn natural gas). It may also be restricted by the core business of the installation, e.g. for a waste incinerator.

The fuel choice may also be influenced by legislation and regulations, including local and transboundary environmental requirements.

Economics

Fuel selection is predominately cost-based.

Driving force for implementation

- combustion process efficiency
- reduction of other pollutants emitted.

Examples

- wastes burnt as a service in waste-to-energy plants (waste incinerators with heat recovery)
- wastes burnt in cement kilns
- waste gases burnt, e.g. hydrocarbon gases in a refinery or CO in non-ferrous metals processing
- biomass heat and/or electrical power plants.

Reference information

[227, TWG]

3.1.6 Oxy-firing (oxyfuel)**Description**

Oxygen is used instead of ambient air and is either extracted from air on the site, or more usually, bought in bulk.

Achieved environmental benefits

Its use has various benefits:

- an increased oxygen content results in a rise in combustion temperature, increasing energy transfer to the process, which helps to reduce the amount of unburnt fuel, thereby increasing energy efficiency while reducing NO_x emissions
- as air is about 80 % nitrogen, the mass flow of gases is reduced accordingly, and hence a reduction in the flue-gas mass flow
- this also results in reduced NO_x emissions, as nitrogen levels at the burners are considerably reduced
- the reduction in flue gas mass flows may also result in smaller waste gas treatment systems and consequent energy demands, e.g. for NO_x where still required, particulates, etc.
- where oxygen is produced on site, the nitrogen separated may be used, e.g. in stirring and/or providing an inert atmosphere in furnaces where reactions can occur in oxidising conditions (such as pyrophoric reactions in non-ferrous metals industries)
- a future benefit may be the reduced quantity of gases (and high concentration of CO₂) which would make the capture and sequestration of CO₂ easier, and possibly less energy-demanding.

Cross-media effects

The energy requirement to concentrate oxygen from the air is considerable, and this should be included in any energy calculations (see Section 1.3.6.1).

Within the glass industry, there is a large diversity in glass melt production capacities, glass types and applied glass furnace types. For several cases, a conversion to oxygen firing (e.g. compared to recuperative furnaces, for relatively small furnaces and for special glass) very often improves the overall energy efficiency (taking into account the primary energy equivalent required to produce the oxygen). However, for other cases the energy consumption for oxygen generation is as high or even higher than the saved energy. This is especially the case when comparing overall energy efficiency of oxygen-fired glass furnaces with end-port fired regenerative glass furnaces for large scale container glass production. However, it is expected that further developments in oxygen-fired glass furnaces will improve their energy efficiency in the near future. Energy savings do not always offset the costs of the oxygen to be purchased.

Operational data

Special safety requirements have to be taken into account for handling oxygen due to the higher risk of explosion with pure oxygen streams than with air streams.

Extra safety precautions may be needed when handling oxygen, as the oxygen pipelines may operate at very low temperatures.

Applicability

Not widely used in all sectors. In the glass sector, producers try to control temperatures in the glass furnace combustion space to levels acceptable for the applied refractory materials and necessary to melt glass of the required quality. A conversion to oxygen firing generally does not mean increased furnace temperatures (refractory or glass temperatures), but may improve heat transfer. In the case of oxygen firing, furnace temperatures need to be more tightly controlled, but are not higher than those in air-fired furnaces (only temperatures of the cores of the flames may be higher).

Economics

The price for bought-in oxygen is high or if self-produced has a high demand on electrical power. The investment in an air separation unit is substantial and will strongly determine the cost effectiveness of firing with oxygen.

Driving force for implementation

Reduced waste gas flows will result in the requirement for smaller waste gas treatment systems, e.g. deNO_x. However, this only applies in new builds, or to places where waste treatment plants are to be installed or replaced.

Examples

Used in the glass and metal refining industries (in Poland, together with the use of nitrogen).

Reference information

[157, Beerkens R.G.C. , 2006]

3.1.7 Reducing heat losses by insulation

Description

The heat losses through the walls of the combustion system are determined by the diameter of the pipe and the thickness of the insulation. An optimum insulation thickness which relates energy consumption with economics should be found in every particular case.

Efficient thermal insulation to keep heat losses through the walls at a minimum is normally achieved at the commissioning stage of the installation. However, insulating material may progressively deteriorate, and must be replaced after inspection following maintenance programmes. Some techniques using infrared imaging are convenient to identify the zones of damaged insulation from outside while the combustion installation is in operation in order to plan repairs during shutdown.

Achieved environmental benefits

Energy savings.

Cross-media effects

Use of insulation material.

Operational data

Regular maintenance and periodical control is important to check the absence of hidden leaks in the system (below the insulations). In negative pressure systems, leakage can cause an increase of the amount of gas in the system and a subsequent demand of electrical power at the fans.

In addition, uninsulated parts of the system may cause injuries to operators where:

- there is a risk of contact
- temperatures exceed 50 °C.

Applicability

All cases.

Economics

Low cost, especially if carried out at shutdown times. Insulation repair can be carried out during campaigns.

Driving force for implementation

Maintaining process temperature.

Examples

Insulation repair is carried out during campaigns in steel and glass industries.

Reference information

[91, CEFIC, 2005]

3.1.8 Reducing losses through furnace openings

Description

Heat losses by radiation can occur via furnace openings for loading/unloading. This is especially significant in furnaces operating above 500 °C. Openings include furnace flues and stacks, peepholes used to visually check the process, doors left partially open to accommodate oversized work, loading and unloading materials and/or fuels, etc.

Achieved environmental benefits

No data submitted.

Cross-media effects

No data submitted.

Operational data

Losses are very apparent when making scans with infrared cameras. By improving design, losses via doors and peepholes can be minimised.

Applicability

No data submitted.

Economics

No data submitted.

Driving force for implementation

No data submitted.

Examples

No data submitted.

Reference information

[127, TWG, , 271, US_DOE, 2004]

3.2 Steam systems

3.2.1 General features of steam

Description

Steam is one of the possible energy carriers in fluid-based heating systems. Other common energy carriers are water and thermal oil. Water can be used where the required temperature(s) do not exceed 100 °C, and pressurised water (to avoid boiling) can be used for temperatures above 100 °C, in some cases even over 180 °C. Thermal oils have a higher boiling point (and have been developed to have longer lifetimes). However, they typically have lower heat capacities and heat transfer coefficients than steam. Steam has various advantages which are described below, including its use in many direct contact applications.

These advantages include low toxicity, safety in use with flammable or explosive materials, ease of transportability, high efficiency, high heat capacity, and low cost with respect to thermal oils. Steam holds a significant amount of energy on a unit mass basis (2300 – 2900 kJ/kg) that can be extracted as mechanical work through a turbine or as heat for process use. Since most of the heat content of the steam is stored as latent heat, large quantities of heat can be transferred efficiently at a constant temperature, which is a useful attribute in many process heating applications (see Section 1.2.2.4). Steam is also discussed in detail in the LCP BREF.

The transition from water to steam conditions requires a large quantity of energy, which is stored in latent form. This makes it possible to achieve a sizeable heat transfer in a small surface area when using steam in comparison with other heating fluids:

- water 4000 W/m² °C
- oil 1500 W/m² °C
- steam > 10000 W/m² °C.

In the two-phase boundary for the water liquid-gas system represented by a straight line in the phase diagram (see Figure 1.5), steam pressure is directly related to temperature. Temperature can be adapted easily by modifying the pressure. Working at high or low pressure has different effects on the installation (see Operational data, below). The steam pressure of the installation thus needs to be carefully considered in order to achieve an optimisation between reliability and energy efficiency.

The many advantages that are available from steam are reflected in the significant amount of this type of energy that industry uses to generate it. For example, in 1994, industry in the EU-15 used about 5988 PJ of steam energy, which represented about 34 % of the total energy used in industrial applications for product output. Some examples of the energy used to generate steam in different industries is shown in Table 3.5.

Industry	Energy to generate steam (PJ)	Percentage of the total energy used by this industry
Pulp and paper	2318	83 %
Chemicals 1957		57 %
Petroleum refining	1449	42 %

Table 3.5: Energy used to generate steam in several industries

Achieved environmental benefits

Steam itself is non-toxic.

Cross-media effects

- generation of steam has the usual emissions from combustion
- where boiler water is treated, there are emissions of chemicals, from the treatment or deionisers
- waste steam or hot condensate can raise temperatures in receiving sewers or waters.

Operational data

A steam system is made up of four distinct components: the generation plant (the boiler), the distribution system (steam network, i.e. steam and condensate return), the consumer or end user (i.e. plant/process using the steam/heat) and the condensate recovery system. Efficient heat production, distribution, operation and maintenance contribute significantly to the reduction of heat losses, as described below:

- generation (see Combustion, Section 3.1): steam is generated in a boiler or a heat recovery system generator by transferring the heat of combustion gases to water. When water absorbs enough heat, it changes phase from liquid to steam. In some boilers, a superheater further increases the energy content of the steam. Under pressure, the steam then flows from the boiler or steam generator and into the distribution system
- distribution: the distribution system carries steam from the boiler or generator to the points of end-use. Many distribution systems have several take-off lines that operate at different pressures. These distribution lines are separated by various types of isolation valves, pressure-regulation valves, and sometimes backpressure turbines. Effective distribution system performance requires a proper steam pressure balance, good condensate drainage, adequate insulation and effective pressure regulation.

Higher pressure steam has the following advantages:

- the saturated steam has a higher temperature
- the volume is smaller, which means the distribution pipes required are smaller
- it is possible to distribute the steam at high pressure and to reduce its pressure prior to application. The steam thus becomes dryer and reliability is higher
- a higher pressure enables a more stable boiling process in the boiler.

Lower pressure systems have the advantages:

- there is less loss of energy at boiler level and in the distribution system
- the amount of remaining energy in the condensate is relatively smaller (see Sections 3.2.14 and 3.2.15)
- leakage losses in the pipe system are lower
- there is a decrease in scale build-up.

Due to the high operating pressure values in steam systems, safety is an extremely important aspect in steam processes. In addition, a steam system is often subject to water hammer or various types of corrosion. As a result, the reliability and lifespan of the different components also strongly depend on the design, the set-up and the maintenance of the installation.

- end-use: there are many different end uses of steam, e.g.:
 - mechanical drive: turbines, pumps, compressors, etc. This is usually for large scale equipment, such as power generation, large compressors, etc.
 - heating: process heating, drying all types of paper products
 - use in chemical reactions: moderation of chemical reactions, fractionation of hydrocarbon components and as a source of hydrogen in steam methane reforming.

Common steam system end-use equipment includes heat exchangers, turbines, fractionating towers, strippers and chemical reaction vessels.

Power generation is discussed in the LCP B REF, cogeneration and trigeneration are discussed in Section 3.4 and 3.4.2 of this document respectively.

In process heating, the steam transfers its latent heat to a process fluid in a heat exchanger. The steam is held in the heat exchanger by a steam trap until it condenses, at which point the trap passes the condensate into the condensate return system. In a turbine, the steam transforms its energy to mechanical work to drive rotating or reciprocating machinery such as pumps, compressors or electrical generators. In fractionating towers, steam facilitates the separation of various components of a process fluid. In stripping applications, steam is used to extract contaminants from a process fluid. Steam is also used as a source of water for certain chemical reactions:

- recovery of condensate: when steam transfers its latent heat to an application, water condenses in the steam system and is returned to the boiler via the condensate return system. First, the condensate is returned to a collection tank from where it is pumped to the deaerator, which strips out oxygen and non-condensable gases. Makeup water and chemicals can be added either in the collection tank or in the deaerator. The boiler feed pumps increase the feed-water pressure to above boiler pressure and inject it into the boiler to complete the cycle
- calculation of efficient steam boilers: the pan-European consensus on calculating the efficiency of certain boilers are given in CEN EN 12952-15:2003 (water tube boilers and auxiliary installations: acceptance tests) and CEN EN 12953-11:2003 (shell boilers: acceptance tests)

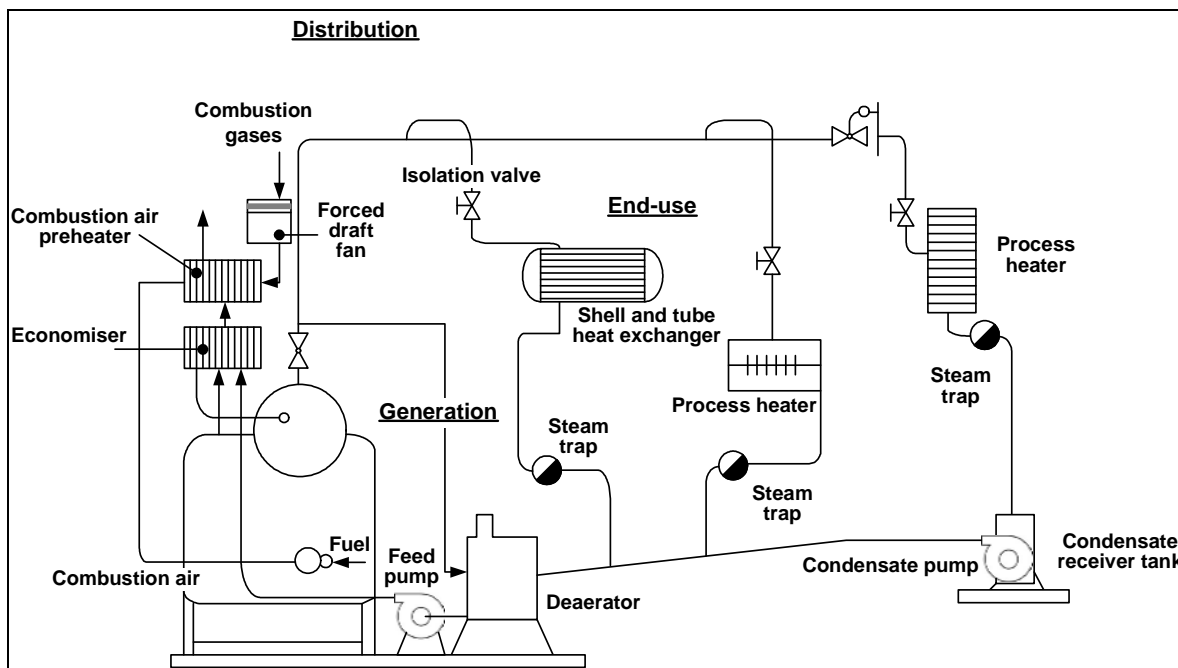

Figure 3.5: Typical steam generation and distribution system [123, US_DOE]

Applicability
Widely used.

Economics

The cost of steam generation is directly influenced by the price of the fuel used; a price advantage in favour of a particular fuel may well outweigh a relatively smaller thermal efficiency penalty associated with that fuel. Nonetheless, for any particular fuel, significant savings can be achieved by improving thermal efficiency (see Combustion, Section 3.1).

Eliminating avoidable energy losses associated with steam generation and its distribution (including the return of condensate) can significantly reduce the steam cost at the point of use.

Potential energy savings for the individual sites may range from less than 1 to 35 %, with an average saving of 7 %.

Driving force for implementation

- the reduction of energy costs, emissions and the rapid return of investment
- use of steam: ease and flexibility of use, low toxicity, high heat delivery for system size.

Examples

Widely used in many IPPC sectors, such as: power generation, all chemical sectors, pulp and paper, food, drink and milk.

Reference information

[32, ADENE, 2005, 33, ADENE, 2005, 123, US_DOE, 125, EIPPCB, 236, Fernández-Ramos, 2007]

3.2.2 Overview of measures to improve steam system performance

Steam systems are described in detail in the LCP BREF. To assist the reader, reference to techniques both in the LCP BREF²¹ are given, as well as to the techniques described here. Common performance opportunities for the generation, distribution and recovery areas of the system are listed in Table 3.6.

²¹ Reference relate to LCP BREF 2006 edition

Techniques for sectors and associated activities where steam systems are not covered by a vertical BREF		
Techniques by section in the ENE BREF		
	Benefits	Section
DESIGN		
Energy efficient design and installation of steam distribution pipework	Optimises energy savings	2.3
Throttling devices and the use of backpressure turbines. (Utilise backpressure turbines instead of PRVs)	Provides a more efficient method of reducing steam pressure for low pressure services	3.2.3
OPERATING AND CONTROL		
Improve operating procedures and boiler controls	Optimises energy savings	3.2.4
Use sequential boiler controls (apply only to sites with more than one boiler)	Optimises energy savings	3.2.4
Install flue-gas isolation dampers (applicable only to sites with more than one boiler)	Optimises energy savings	3.2.4
GENERATION		
Preheating feed-water by using: <ul style="list-style-type: none"> waste heat, e.g. from a process economisers using combustion air deaerated feed-water to heat condensate condensing the steam used for stripping and heating the feed-water to the deaerator via a heat exchanger 	Recovers available heat from exhaust gases and transfers it back into the system by preheating feed-water	3.2.5 3.1.1
Prevention and removal of scale deposits on heat transfer surfaces. (Clean boiler heat transfer surfaces)	Promotes effective heat transfer from the combustion gases to the steam	3.2.6
Minimise boiler blowdown by improving water treatment. Installing automatic total dissolved solids control	Reduces the amount of total dissolved solids in the boiler water, which allows less blowdown and therefore less energy loss	3.2.7
Add/restore boiler refractory	Reduces heat loss from the boiler and restores boiler efficiency	2.10.1 2.9
Optimise deaerator vent rate	Minimises avoidable loss of steam	3.2.8
Minimise boiler short cycling losses	Optimises energy savings	3.2.9
Carrying out boiler maintenance		2.9
DISTRIBUTION		
Optimise steam distribution system (especially to cover the issues below)	2.	9, 3.2.10
Isolate steam from unused lines	Minimises avoidable loss of steam and reduces energy loss from piping and equipment surfaces	3.2.10
Insulation on steam pipes and condensate return pipes. (Ensure that steam system piping, valves, fittings and vessels are well insulated)	Reduces energy loss from piping and equipment surfaces	3.2.11
Implement a control and repair programme for steam traps	Reduces passage of live steam into the condensate system and promotes efficient operation of end-use heat transfer equipment. Minimises avoidable loss of steam	3.2.12
RECOVERY		
Collect and return condensate to the boiler for re-use. (Optimise condensate recovery)	Recovers the thermal energy in the condensate and reduces the amount of makeup water added to the system, saving energy and chemicals treatment	3.2.13
Re-use of flash steam. (Use high pressure condensate to make low pressure steam)	Exploits the available energy in the returning condensate	3.2.14
Recover energy from boiler blowdown	Transfers the available energy in a blowdown stream back into the system, thereby reducing energy loss	3.2.15

Techniques for sectors and associated activities where steam systems are not covered by a vertical BREF				
Techniques by section in the ENE BREF				
	Benefits			Section
Techniques by fuel type and by Section in the LCP BREF July 2006				
	<i>Coal and lignite</i>	<i>Biomass and peat</i>	<i>Liquid fuels</i>	<i>Gaseous fuels</i>
Expansion turbine to recover the energy content of pressurised gases				7.4.1, 7.5.1
Change turbine blades	4.4.3	5.4.4	6.4.2	
Use advanced materials to reach high steam parameters	4.4.3		6.4.2	7.4.2
Supercritical steam parameters	4.4.3, 4.5.5		6.4.2	7.1.4
Double reheat	4.4.3, 4.5.5		6.4.2, 6.5.3.1	7.1.4, 7.4.2, 7.5.2
Regenerative feed-water	4.2.3, 4.4.3	5.4.4	6.4.2	7.4.2
Use of heat content of the flue-gas for district heating	4.4.3			
Heat accumulation			6.4.2	7.4.2
Advanced computerised control of the gas turbine and subsequent recovery boilers				7.4.2

Table 3.6: Common energy efficiency techniques for industrial steam systems
Adapted and combined from [123, US_DOE]

In most cases, steam is generated in an industrial installation by means of a combustion reaction, so some overlap of energy efficiency comprehensive measures applicable to both combustion and steam sections cannot be avoided: these are noted in Table 3.6. The techniques specific to steam are discussed in this section.

To implement any of these measures, it is crucial to have relevant, quantified information and knowledge of fuel usage, steam generation and the steam network. Metering and monitoring steam contributes to the understanding of the process operation, together with a knowledge of how far the operating parameters can be modified and is thus essential to the successful integration of, e.g. heat recovery into a process (see Section 2.10).

3.2.3 Throttling devices and the use of backpressure turbines

Description

Throttling devices are very common in industry and are used to control and reduce pressure mainly through valves. Since the throttling process is isenthalpic (where the enthalpy up and down flows are equal) no energy is lost and according to the first law of thermodynamics, its efficiency is optimal. However, this has an inherent typical mechanical irreversibility which reduces pressure and increases the entropy of the fluid without giving any additional benefit. Consequently, exergy is lost and the fluid (after the pressure drop) is less capable of producing energy, e.g. in a subsequent turbine expansion process.

Therefore, if the aim is to reduce the pressure of a fluid, it is desirable to use isentropic expansions and provide useful work in addition through turbines. If this is not possible, the working pressure should always be as low as possible, to avoid large pressure changes, with associated exergy losses through valves, measuring devices (see Section 2.10.4) or by using compressors or pumps to input additional energy.

A regular practice in industrial installations is to keep the pressure at the inlet of a turbine at the design conditions. This usually implies the use (and abuse) of inlet valves to control the turbine.

According to the second law of thermodynamics, it is better to have variation of the pressure specifications (sliding pressure) and to keep the admission valves completely open.

As a general recommendation, valves should be sized as large as possible. A satisfactory throttling process can be achieved with a pressure drop of 5 – 10 % at maximum flow, instead of 25 – 50 % as has been past practice with valves of too small a size. The pump driving the fluid must be also sized to take account of the variable conditions.

However, a better alternative is to use a backpressure turbine, which almost retains the isentropic conditions and is completely reversible (in thermodynamic terms). The turbine is used to generate electricity.

Achieved environmental benefits

Reduces exergy losses.

Cross-media effects

Increases fuel consumption.

Operational data

See examples in Annex 7.2.

Applicability

Applicable in new or significantly refurbished systems, according to the economics and the following factors:

- the turbine is used to generate electricity or to provide mechanical power to a motor, compressor or fan. Whereas backpressure turbines are the most attractive from a point of view of energy efficiency, the quantity of steam passing through the backpressure turbines should fit with the overall steam balance of the whole site. Use of excessive numbers of backpressure turbines will result in more steam being generated at low pressure levels than can be consumed by the plant/site. This excess steam would then have to be vented, which is not energy efficient. The steam flow from the backpressure turbine also needs to be available for a large percentage of the time, and in a predictable way. An unpredictable or discontinuous source cannot be used reliably (unless, rarely, peaks in supply and demand can be matched)
- backpressure turbines are not useful when the two pressure levels are close together, as the turbines need a high flow and pressure differential. In the steel industry in the blast furnace process, pressure drop turbines are used because of the huge number of gases which flow through the blast furnace.

Economics

Turbines are several orders of magnitude more expensive than control valves. The minimum size to be effective and to be considered before substituting therefore has to be considered with the steam balance. In the case of low mass flows, turbines are not reasonable from an economic point of view. To be economic, the recovered energy should be sufficiently reliable, available for a large percentage of production time and match demand.

Driving force for implementation

Where they can be used, cost savings in the steam supply.

Examples

See Annex 7.2.

Reference information

[6, Cefic, 2005, 123, US_DOE]

3.2.4 Operating and control techniques

Description

Improving operating procedures and boiler controls

A modern control system optimising boiler usage is shown in Figure 3.6 below. This type of control is discussed further in Section 2.15.2.

Using sequential boiler controls

Where a site has more than one boiler, the steam demands should be analysed and the boilers used to optimise energy usage, by reducing short cycling, etc.

Installing flue-gas isolation dampers (applies only to systems where there is two or more boilers with a common chimney).

Achieved environmental benefits

Energy savings.

Cross-media effects

No data submitted.

Operational data

No data submitted.

Applicability

The installation of more than one boiler may be considered to cope with varying demands over the working cycle. The boilers may be of different types, depending on the demand curve, cycle times, etc.

The use of sequential boilers may be limited when high steam availability guarantees are required.

Economics

No data submitted.

Driving force for implementation

No data submitted.

Examples

No data submitted.

Reference information

[123, US_DOE, , 134, Amalfi, 2006, 179, Stijns, 2005]

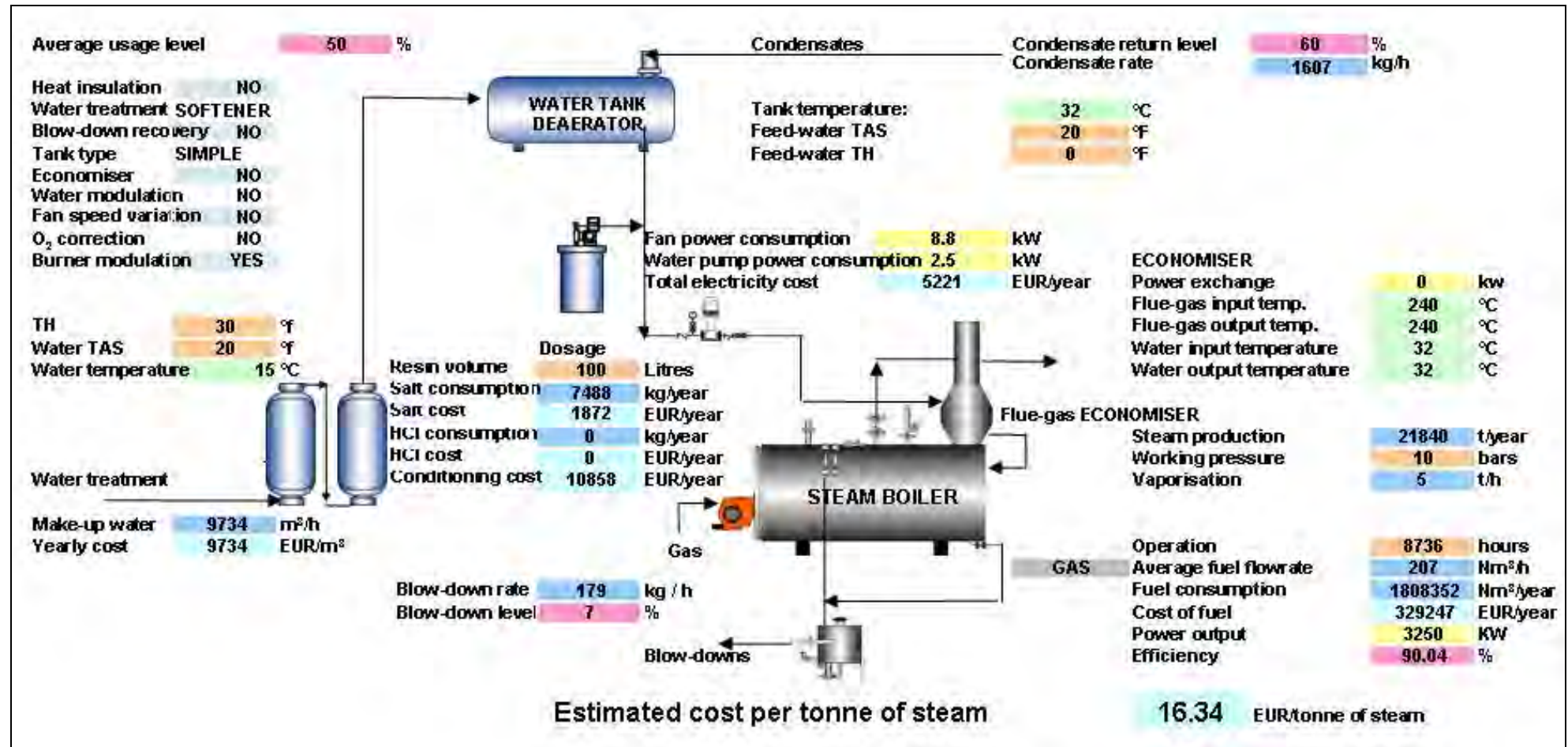

Figure 3.6: Modern control system optimising boiler usage

3.2.5 Preheating feed-water (including the use of economisers)

Description

The water from the deaerator being returned to the boiler generally has a temperature of approximately 105 °C. The water in the boiler at a higher pressure is at a higher temperature. The steam boiler is fed with water to replace system losses and recycle condensate, etc. Heat recovery is possible by preheating the feed-water, thus reducing the steam boiler fuel requirements.

The preheating can be done in four ways:

- using waste heat (e.g. from a process): feed-water can be preheated by available waste heat, e.g. using water/water heat exchangers
- using economisers: an economiser ((1) in Figure 3.7) is a heat exchanger which reduces steam boiler fuel requirements by transferring heat from the flue-gas to the incoming feed-water
- using deaerated feed-water: in addition, the condensate can be preheated with deaerated feed-water before reaching the feed-water container ((2) in Figure 3.7)). The feed-water from the condensate tank ((3) in Figure 3.7)) has a lower temperature than the deaerated feed-water from the feed-water container ((2) Figure 3.7)). Through a heat exchanger, the deaerated feed-water is cooled down further (the heat is transmitted to the feed-water from the condensate tank). As a result, the deaerated feed-water forwarded through the feed-water pump is cooler when it runs through the economiser ((1) in Figure 3.7)). It thus increases its efficiency due to the larger difference in temperature and reduces the flue-gas temperature and flue-gas losses. Overall, this saves live steam, as the feed-water in the feed-water container is warmer and therefore less live steam is necessary for its deaeration

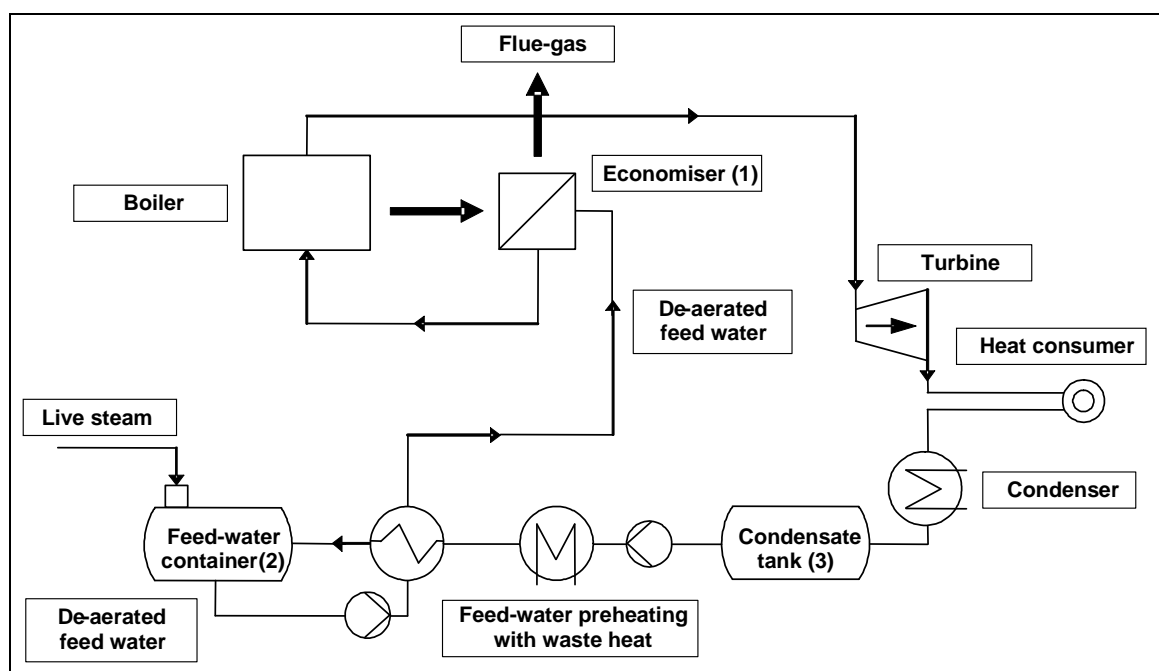

Figure 3.7: Feed-water preheating [28, Berger, 2005]

- installing a heat exchanger in the feed-water stream entering the deaerator and preheating this feed-water by condensing the steam used for stripping (see Section 3.2.8 for details of deaeration).

The overall efficiency can be increased through these measures, that is, less fuel energy input is required for a certain steam output.

Achieved environmental benefits

The energy recovery which can be achieved depends on the temperature of the flue-gases (or that of the main process), the choice of surface and, to a large extent, on the steam pressure.

It is widely accepted that an economiser can increase steam production efficiency by 4 %. The water supply needs to be controlled in order to achieve a continuous use of the economiser.

Cross-media effects

Possible disadvantages of these four possibilities are that more space is required and their availability for industrial facilities decreases with rising complexity.

Operational data

According to the manufacturer's specifications, economisers are commonly available with a rated output of 0.5 MW. Economisers designed with ribbed tubes are used for rated outputs of up to 2 MW, and equipped with finned tubes for outputs of over 2 MW. In the case of outputs over 2 MW, around 80 % of the large water tube boilers delivered are equipped with economisers, as they are even economical when operated in single shifts (at system loads of 60 - 70 %).

The exhaust gas temperature typically exceeds the saturated steam temperature by around 70 °C. The exhaust gas temperature for a standard industrial steam generator is about 180 °C. The lower limit of the flue-gas temperature is the flue-gases' acid dewpoint. The temperature depends on the fuel used and/or the fuel's sulphur content (and is around 160 °C for heavy fuel oil, 130 °C for light fuel oil, 100 °C for natural gas and 110 °C for solid waste). In boilers using heating oil, corrosion will occur more easily and part of the economiser has to be designed to be replaced. If the temperature of the exhaust gas drops significantly below the dewpoint, economisers might lead to corrosion, which usually occurs when there is a significant sulphur content in the fuel.

Unless special steps are taken, soot builds up in stacks below this temperature. As a consequence, economisers are frequently equipped with a bypass controller. This controller diverts a proportion of the exhaust gases around the economiser if the temperature of the gases in the stack drops too low.

Working on the principle that a 20 °C reduction in the temperature of the exhaust gas increases efficiency by around 1 %, this means that, depending on the steam temperature and drop in temperature caused by the heat exchanger, efficiency can improve by up to 6 - 7 %. The temperature of the feed-water to be heated in the economiser is typically increased from 103 to around 140 °C.

Applicability

In some existing plants, feed-water preheating systems can only be integrated with difficulty. In practice, feed-water preheating with deaerated feed-water is applied only rarely.

In high output plants, feed-water preheating through an economiser is standard. In this context, however, it is possible to improve the efficiency of the economiser by up to 1 % by increasing the temperature difference. Using waste heat from other processes is also feasible in most installations. There is also potential to use it in lower output plants.

Economics

The amount of energy savings potential by implementing economiser feed-water preheating depends on several conditions such as local system requirements, condition of the stack or flue-gas quality. The payback for a particular steam distribution system will depend on the operating hours, the actual fuel price and the location.

In practice, the possible savings from feed-water preheating amount to several per cent of the steam volume generated. Therefore, even in small boilers the energy savings can be in the range of several GWh per year. For example, with a 15 MW boiler, savings of roughly 5 GWh/yr, some EUR 60000/yr and about 10 00 tonnes CO₂/yr can be attained. The savings are proportional to the size of the plant, which means that larger plants will see higher savings.

Boiler flue-gases are often rejected to the stack at temperatures of more than 100 to 150 °C higher than the temperature of the generated steam. Generally, boiler efficiency can be increased by 1 % for every 40 °C reduction in the flue-gas temperature. By recovering waste heat, an economiser can often reduce fuel requirements by 5 to 10 % and pay for itself in less than 2 years. Table 3.7 shows examples of the potential for heat recovery.

Approximate recoverable heat from boiler flue-gases				
Initial stack gas Temperature, °C	Recoverable heat, (kW)			
	Boiler thermal output (kW)			
	7322	14640	29290	58550
205	38176	21552		3105
260	67413	47269		5389
315	96719	43807		7644

Table 3.7: Based on natural gas fuel, 15 % excess air and a final stack temperature of 120 °C
Adapted from [123, US_DOE]

Driving force for implementation

Reduction of energy costs and minimisation of CO₂ emissions.

Examples

Widely used.

Reference information

[16, CIPEC, 2002, 26, Neisecke, 2003, 28, Berger, 2005, 29, Maes, 2005, 123, US_DOE]

3.2.6 Prevention and removal of scale deposits on heat transfer surfaces

Description

On generating boilers as well as in heat exchange tubes, a scale deposit might occur on the heat transfer surfaces. This deposit occurs when soluble matter reacts in the boiler water to form a layer of material on the waterside of the boiler exchange tubes.

Scale creates a problem because it typically possesses a thermal conductivity with an order of magnitude less than the corresponding value for bare steel. When a deposit of a certain thickness and given composition is formed on the heat exchange surface, the heat transfer through surfaces is reduced as a function of the scale thickness. Even small deposits might thus serve as a non-effective heat insulator and consequently reduce heat transfer. The result is overheating of boiler tube metal, tube failures and loss of energy efficiency. By removing the deposit, operators can easily save on energy use and on the annual operating costs.

Fuel waste due to boiler scale may be 2 % for water-tube boilers and up to 5 % in fire-tube boilers.

At boiler level, a regular removal of this scale deposit can produce substantial energy savings.

Achieved environmental benefits

Reduced energy losses.

Table 3.8 shows the loss in heat transfer when a scale deposit is formed on the heat exchanging surface:

Scale thickness (mm)	Difference in heat transfer ²² (%)
0.1	1.0
0.3	2.9
0.5	4.7
1	9.0

Table 3.8: Differences in heat transfer
[29, Maes, 2005]

Cross-media effects

By treating feed-water to prevent scale deposits, the use of chemicals may increase.

Operational data

Removing the deposit will require the boiler to be out of use.

There are different ways of removing and preventing deposit formation:

- if pressure is reduced, the temperature will also reduce, which curtails scale deposits. This is one reason why steam pressure should be kept as low as possible (see Section 3.2.1)
- the deposit can be removed during maintenance, both mechanically as well as with acid cleaning
- if scale formation returns too rapidly, the treatment of feed-water needs to be reviewed. A better purification or extra additives may be required.

An indirect indicator of scale or deposit formation is flue-gas temperature. If the flue-gas temperature rises (with boiler load and excess air held constant), the effect is likely to be due to the presence of scale.

Applicability

Whether scale deposits need to be removed can be ascertained by a simple visual inspection during maintenance. As a rule of thumb, maintenance several times per year may be effective for appliances at high pressure (50 bar). For appliances at low pressure (2 bar) annual maintenance is recommended.

It is possible to avoid deposits by improving the water quality (e.g. by switching to soft water or demineralised water). An acid treatment for deposit removal has to be carefully assessed, particularly for high pressure steam boilers.

Economics

Depends on the method used, and other factors, such as raw feed-water chemistry, boiler type, etc. Payback in fuel savings, increased reliability of the steam system and increased operating life of the boiler system (giving savings on lost production time and capital costs) are all achievable.

See examples, in Annex 7.10.1.

Driving force for implementation

Increased reliability of the steam system and increased operating life of the boiler system.

Examples

Widely used.

²² These values were determined for heat transfer in a boiler with steel tubes. The heat transfer is reviewed starting from the flue-gases up to the feed-water. Calculations assume that the composition of the deposit is always the same.

Reference information

[16, CIPEC, 2002, 29, Maes, 2005, 123, US_DOE]

3.2.7 Minimising blowdown from the boiler**Description**

Minimising the blowdown rate can substantially reduce energy losses as the temperature of the blowdown is directly related to that of the steam generated in the boiler.

As water vaporises in the boiler during steam generation, dissolved solids are left behind in the water, which in turn raises the concentration of dissolved solids in the boiler. The suspended solids may form sediments, which degrade heat transfer (see Section 3.2.6). Dissolved solids promote foaming and carryover of boiler water into the steam.

In order to reduce the levels of suspended and total dissolved solids (TDS) to acceptable limits, two procedures are used, automatically or manually in either case:

- bottom blowdown is carried out to allow a good thermal exchange in the boiler. It is usually a manual procedure done for a few seconds every several hours
- surface or skimming blowdown is designed to remove the dissolved solids that concentrate near the liquid surface and it is often a continuous process.

The blowdown of salt residues to drain causes further losses accounting for between one and three per cent of the steam employed. On top of this, further costs may also be incurred for cooling the blowdown residue to the temperature prescribed by regulatory authorities.

In order to reduce the required amount of blowdown, there are several possibilities:

- the recovery of condensate (see Sections 3.2.13 and 3.2.15). This condensate is already purified and thus does not contain any impurities, which will be concentrated inside the boiler. If half of the condensate can be recovered, the blowdown can be reduced by 50 %
- depending on the quality of the feed-water, softeners, decarbonation and demineralisation might be required. Additionally, deaeration of the water and the addition of conditioning products are necessary. The level of blowdown is linked with the level of the more concentrated component present or added to the feed-water. In case of direct feed of the boiler, blowdown rates of 7 to 8 % are possible; this can be reduced to 3 % or less when water is pretreated
- the installation of automated blowdown control systems can also be considered, usually by monitoring conductivity. This can lead to an optimisation between reliability and energy loss. The blowdown rate will be controlled by the most concentrated component knowing the maximum concentration possible in the boiler (TAC max. of the boiler 38 °C; silica 130 mg/l; chloride <600 mg/l). For more details, see EN 12953 – 10
- flashing the blowdown at medium or low pressure is another way to valorise the energy which is available in the blowdown. This technique applies when the site has a steam network with pressures lower than the pressure at which steam is generated. This solution can be energetically more favourable than just exchanging the heat in the blowdown via a heat exchanger (see Sections 3.2.14 and 3.2.15).

Pressure degasification caused by vaporisation also results in further losses of between one and three per cent. CO₂ and oxygen are removed from the fresh water in the process (by applying slight excess pressure at a temperature of 103 °C). This can be minimised by optimising the deaerator vent rate (see Section 3.2.8).

Achieved environmental benefits

The amount of energy depends on the pressure in the boiler. The energy content of the blowdown is represented in Table 3.9 below. The blowdown rate is expressed as a percentage of the total feed-water required. Thus, a 5 % blowdown rate means that 5 % of the boiler feed-water is lost through blowdown and the remaining 95 % is converted to steam. This immediately indicates that savings can be achieved by reducing blowdown frequency.

Energy content of blowdown in kJ/kg of steam produced					
Blowdown rate (% of boiler output)	Boiler operating pressure				
	2 barg	5 barg	10 barg	20 barg	50 barg
1	4.85	9	7.0	8.4	10.8
2	9.61	7	14.0	16.7	21.5
4	19.12	5	27.9	33.5	43.1
6	28.73	2	41.9	50.2	64.6
8	38.34	0	55.8	66.9	86.1
10	47.8	58.7	69.8	83.6	107.7

Table 3.9: Energy content of blowdown
[29, Maes, 2005]

The amount of waste water will also be reduced if blowdown frequency is reduced. The energy or cooling water used for any cooling of this waste water will also be saved.

Cross-media effects

Discharges of treatment chemicals, chemicals used in deioniser regeneration, etc.

Operational data

The optimum blowdown rate is determined by various factors including the quality of the feed-water and the associated water treatment, the proportion of condensates re-used, the type of boiler and the operating conditions (flowrate, working pressure, type of fuel, etc.). Blowdown rates typically range between 4 and 8 % of the amount of fresh water, but this can be as high as 10 % if makeup water has a high content of solids. Blowdown rates for optimised boiler houses should be lower than 4 %. Blowdown rates should be driven by the antifoaming and oxygen scavenger additives in the treated water rather than by dissolved salts.

Applicability

If blowdown is reduced below a critical level, the problems of foaming and scaling may return. The other measures in the description (recovery of condensate, water pre-treatment) may also be used to lower this critical value.

Insufficient blowdown may lead to a degradation of the installation. Excessive blowdown will result in a waste of energy.

A condensate return is usually standard in all cases except where steam is injected into the process. In this case, a reduction of blowdown by condensate return is not feasible.

Economics

Significant savings in energy, chemicals, feed-water and cooling can be achieved, and makes this viable in all cases, see examples detailed in Annex 7.10.1.

Driving force for implementation

- economics
- plant reliability.

Examples

Widely used.

Reference information

[29, Maes, 2005], [16, CIPEC, 2002] [123, US_DOE, , 133, AENOR, 2004]

3.2.8 Optimising deaerator vent rate**Description**

Deaerators are mechanical devices that remove dissolved gases from boiler feed-water. Deaeration protects the steam system from the effects of corrosive gases. It accomplishes this by reducing the concentration of dissolved oxygen and carbon dioxide to a level where corrosion is minimised. A dissolved oxygen level of 5 parts per billion (ppb) or lower is needed to prevent corrosion in most high pressure (>13.79 barg) boilers. While oxygen concentrations of up to 43 ppb may be tolerated in low pressure boilers, equipment life is extended at little or no cost by limiting the oxygen concentration to 5 ppb. Dissolved carbon dioxide is essentially completely removed by the deaerator.

The design of an effective deaeration system depends upon the amount of gases to be removed and the final gas (O₂) concentration desired. This in turn depends upon the ratio of boiler feed-water makeup to returned condensate and the operating pressure of the deaerator.

Deaerators use steam to heat the water to the full saturation temperature corresponding to the steam pressure in the deaerator and to scrub out and carry away dissolved gases. Steam flow may be parallel, cross, or counter to the water flow. The deaerator consists of a deaeration section, a storage tank, and a vent. In the deaeration section, steam bubbles through the water, both heating and agitating it. Steam is cooled by incoming water and condensed at the vent condenser. Non-condensable gases and some steam are released through the vent. However, this should be optimised to provide satisfactory stripping, with minimised steam loss (see Operational data, below).

Sudden increases in free or 'flash' steam can cause a spike in deaerator vessel pressure, resulting in re-oxygenation of the feed-water. A dedicated pressure regulating valve should be provided to maintain the deaerator at a constant pressure.

Achieved environmental benefits

Savings of unnecessary energy loss in steam venting.

Cross-media effects

None reported.

Operational data

Steam provided to the deaerator provides physical stripping action and heats the mixture of returned condensate and boiler feed-water makeup to saturation temperature. Most of the steam will condense, but a small fraction (usually 5 to 14 %) must be vented to accommodate the stripping requirements. Normal design practice is to calculate the steam required for heating, and then make sure that the flow is sufficient for stripping as well. If the condensate return rate is high (>80 %) and the condensate pressure is high compared to the deaerator pressure, then very little steam is needed for heating, and provisions may be made for condensing the surplus flash steam.

The energy in the steam used for stripping may be recovered by condensing this steam and feeding it through a heat exchanger in the feed water stream entering the deaerator (see Section 3.2.5).

Deaerator steam requirements should be re-examined following the retrofit of any steam distribution system, condensate return, or heat recovery energy conservation measures.

Continuous dissolved oxygen monitoring devices can be installed to aid in identifying operating practices that result in poor oxygen removal.

The deaerator is designed to remove oxygen that is dissolved in the entering water, not in the entrained air. Sources of 'free air' include loose piping connections on the suction side of pumps and improper pump packing.

Applicability

Applicable to all sites with deaerators on steam systems. Optimisation is a ongoing maintenance measure.

Economics

No data submitted.

Driving force for implementation

Cost savings in unnecessary venting of steam.

Examples

Widely used.

Reference information

[123, US_DOE]

3.2.9 Minimising boiler short cycle losses

Description

Losses during short cycles occur every time a boiler is switched off for a short period of time. The boiler cycle consists of a purge period, a post-purge, an idle period, a pre-purge and a return to firing. Part of the losses during the purge periods and idle period can be low in modern, well isolated boilers, but can increase rapidly in older boilers with inferior insulation.

Losses due to short term cycles for steam boilers can be magnified if the boilers can generate the required capacity in a very short period of time. This is the case if the installed capacity of the boiler is considerably larger than that generally needed. The steam demand for the process can change over time and should be reassessed periodically (see Section 2.2.2). Total steam demand may have been reduced through energy savings measures. Alternatively, boilers may have been installed with a view to a later expansion, which was never realised.

A first point for attention is the type of boiler in the design phase of the installation. Fire tube boilers have considerably large thermal inertia, and considerable water content. They are equipped to deal with continuous steam demand and to meet large peak loads. Steam generators or water tube boilers in contrast can also deliver steam in larger capacities. Their relatively lower water content makes water pipe boilers more suitable for installations with strongly varying loads.

Short cycling can be avoided by installing multiple boilers with a smaller capacity instead of one boiler with a large capacity. As a result, both flexibility and reliability are increased. An automated control of the generation efficiency and of the marginal costs for steam generation in each boiler can direct a boiler management system. Thus, additional steam demand is provided by the boiler with the lowest marginal cost.

Another option is possible where there is a standby boiler. In this case, the boiler can be kept to temperature by circulating water from the other boiler directly through the standby boiler. This minimises the flue-gas losses for standby. The standby boiler should be well insulated and with a correct air valve for the burner.

Energy savings can be obtained by boiler isolation or boiler replacement.

Achieved environmental benefits

No data submitted.

Cross-media effects

None known.

Operational data

Maintaining a boiler on standby at the right temperature will need a continuous supply of energy throughout the year, which coincides with approximately 8 % of the total capacity of the boiler. The benefits of reliability and energy savings measures have to be determined.

Applicability

The negative impact of short cycling becomes clear when there is low usage of available boiler capacity for instance, less than 25 %. In such cases, it is good practice to review whether to replace the boiler system.

Economics

See examples in Annex 7.10.1.

Driving force for implementation

- cost savings
- better system performance.

Examples

No data submitted.

Reference information

[29, Maes, 2005], [123, US_DOE]

3.2.10 Optimising steam distribution systems

Description

The distribution system transports steam from the boiler to the various end-uses. Although distribution systems may appear to be passive, in reality, these systems regulate the delivery of steam and respond to changing temperatures and pressure requirements. Consequently, proper performance of the distribution system requires careful design practices and effective maintenance. The piping should be properly sized, supported, insulated, and configured with adequate flexibility. Pressure-regulating devices such as pressure-reducing valves and backpressure turbines should be configured to provide a proper steam balance among the different steam headers. Additionally, the distribution system should be configured to allow adequate condensate drainage, which requires adequate drip leg capacity and proper steam trap selection.

Maintenance of the system is important, especially:

- to ensure that traps operate correctly (see Section 3.2.12)
- that insulation is installed and maintained (see Section 3.2.11)
- that leaks are detected and dealt with systematically by planned maintenance. This is assisted by leaks being reported by operators and dealt with promptly. Leaks include air leaks on the suction side of pumps
- checking for and eliminating unused steam lines.

Achieved environmental benefits

Savings in energy from unnecessary losses.

Cross-media effects

No data submitted.

Operational data

Steam piping transports steam from the boiler to the end-uses. Important characteristics of well-designed steam system piping are that it is adequately sized, configured, and supported. The installation of larger pipe diameters may be more expensive, but can create less pressure drop for a given flowrate. Additionally, larger pipe diameters help to reduce the noise associated with steam flow. As such, consideration should be given to the type of environment in which the steam piping will be located when selecting the pipe diameter. Important configuration issues are flexibility and drainage. With respect to flexibility, the piping (especially at equipment connections) needs to accommodate thermal reactions during system startups and shutdowns. Additionally, piping should be equipped with a sufficient number of appropriately sized drip legs to promote effective condensate drainage. Additionally, the piping should be pitched properly to promote the drainage of condensate to these drip lines. Typically, these drainage points experience two different operating conditions, normal operation and startup; both load conditions should be considered at the initial design stage.

Applicability

All steam systems. Adequate sizing of pipework, minimising the number of tight bends, etc. can best be dealt with at the design and installation stages (including significant repairs, changes and upgrading).

Economics

- proper sizing at the design stage has a good payback within the lifetime of the system
- maintenance measures (such as minimising leaks) also exhibit rapid payback.

Driving force for implementation

- cost savings
- health and safety.

Examples

Widely used.

Reference information

[123, US_DOE]

3.2.11 Insulation on steam pipes and condensate return pipes

Description

Steam pipes and condensate return pipes that are not insulated are a constant source of heat loss which is easy to remedy. Insulating all heat surfaces is, in most cases, an easy measure to implement. In addition, localised damage to insulation can be readily repaired. Insulation might have been removed or not replaced during operation maintenance or repairs. Removable insulation covers for valves or other installations may be absent.

Wet or hardened insulation needs to be replaced. The cause of wet insulation can often be found in leaking pipes or tubes. The leaks should be repaired before the insulation is replaced.

Achieved environmental benefits

Table 3.10 shows heat losses from uninsulated steam lines at different steam pressures.

Distribution line diameter (mm)	Approximate heat loss per 30 m of uninsulated steam line (GJ/yr)			
	Steam pressure (barg)			
	1	10	20	40
25 148		301	396	522
50	248 50	6	665	886
100 438		897	1182	1583
200 781		1625	2142	2875
300 1113		2321	3070	4136

Table 3.10: Heat loss per 30 m of uninsulated steam line

Adapted from [123, US_DOE]

A reduction of energy losses through better insulation can also lead to a reduction in the use of water and the related savings on water treatment.

Cross-media effects

Increased use of insulating materials.

Operational data

No data submitted.

Applicability

As a baseline, all piping operating at temperatures above 200 °C and diameters of more than 200 mm should be insulated and good condition of this insulation should be checked on a periodic basis (e.g. prior to turnarounds via IR scans of piping systems). In addition, any surfaces that reach temperatures of higher than 50 °C where there is a risk of staff contact, should be insulated.

Economics

It can give rapid payback, but time depends on energy price, energy losses and insulation costs.

Driving force for implementation

Easy to achieve compared to other techniques. Health and safety.

Examples

Widely applied.

Reference information

[29, Maes, 2005], [16, CIPEC, 2002]

3.2.11.1 Installation of removable insulating pads or valves and fittings**Description**

During maintenance operations, the insulation that covers pipes, valves, and fittings is often damaged or removed and not replaced.

The insulation of the different components in an installation often varies. In a modern boiler, the boiler itself is generally well insulated. On the other hand, the fittings, valves and other connections are usually not as well insulated. Re-usable and removable insulating pads are available for surfaces that emit heat.

Achieved environmental benefits

The efficiency of this technique depends on the specific application, but the heat loss as a result of frequent breaches in insulation is often underestimated.

Table 3.11 summarises energy savings due to the use of insulating valve covers for a range of valve sizes and operating temperatures. These values were calculated using a computer program that meets the requirements of ASTM C 1680 – heat loss and surface temperature calculations. The energy savings are defined as the energy loss between the uninsulated valve and the insulated valve operating at the same temperature.

Approximate energy savings* in Watts from installing removable insulated valve covers (W)							
Operating temperature °C	Valve size (mm)						
	75	100	150	200	255	305	
95	230		315	450	640	840	955
150	495		670	970	1405	1815	2110
205	840		985	1700	2430	3165	3660
260	1305		1800	2635	3805	4950	5770
315	1945		2640	3895	5625	7380	8580

* Based on insulation of a 25 mm thick insulating pad on an ANSI 150-pound class flanged valve with an ambient temperature of 20 °C

Table 3.11: Approximate energy savings in Watts from installing removable insulated valve covers [123, US_DOE]

Proper installation of insulating covers may also reduce the noise.

Cross-media effects

None known.

Operational data

Re-usable insulating pads are commonly used in industrial facilities for insulating flanges, valves, expansion joints, heat exchangers, pumps, turbines, tanks and other irregular surfaces. The pads are flexible and vibration resistant and can be used with equipment that is horizontally or vertically mounted or equipment that is difficult to access.

Applicability

Applicable for any high temperature piping or equipment that should be insulated to reduce heat loss, reduce emissions, and improve safety. As a general rule, any surface that reaches temperatures of greater than 50 °C where there is a risk of human contact should be insulated to protect personnel (see Insulation, Section 3.2.11). Insulating pads can be easily removed for periodic inspection or maintenance, and replaced as needed. Insulating pads can also contain material to act as acoustic barriers to help control noise.

Special care must be taken when insulating steam traps. Different types of steam traps can only operate correctly if limited quantities of steam can condense or if a defined quantity of heat can be emitted (for instance, certain thermostatic and thermodynamic steam traps).

If these steam traps are over-insulated, this might impede their operation. It is therefore necessary to consult with the manufacturer or other expert before insulating.

Economics

It can give rapid payback, but time depends on energy, price and area to be insulated.

Driving force for implementation

- cost saving
- health and safety.

Examples

Widely used.

Reference information

[29, Maes, 2005], [16, CIPEC, 2002, 123, US_DOE]

3.2.12 Implementing a control and repair programme for steam traps**Description**

Leaking steam traps lose significant quantities of steam, which result in large energy losses. Proper maintenance can reduce these losses in an efficient manner. In steam systems where the steam traps have not been inspected in the last three to five years, up to about 30 % of them may have failed allowing steam to escape. In systems with a regularly scheduled maintenance programme, less than 5 % of the total number of traps should be leaking.

There are many different types of steam traps and each type has its own characteristics and preconditions. Checks for escaping steam are based on acoustic, visual, electrical conductivity or thermal checks.

When replacing steam traps, changing to orifice venturi steam traps can be considered. Some studies suggest that under specific conditions, these traps result in lower steam losses and longer lifespans. However, the opinion between experts on the utilisation of orifice venturi steam traps is divided. In any case, this type of steam trap is a continuous leak, so it should only be used for very specific services (e.g. on reboilers, which always operate at a minimum 50 – 70 % of their design duty).

Achieved environmental benefits

Table 3.12 shows the approximate steam losses caused by leaks of several diameters.

Approximate trap orifice diameter (mm)	Approximate steam loss (kg/h)			
	Approximate steam pressure (barg)			
	1	7	10	20
1	0.38	1.5	2.1	-
2	1.56	6.2	16.4	16.4
3	6.24	24.8	34.4	65.8
4	13.95	54.8	77	148
6	24.89	96.2	137	263
8	55.82	151.5	309	591

Table 3.12: Leaking steam trap discharge rate
[123, US_DOE]

Operational data

An annual survey checks all steam traps. The different function categories are shown in Table 3.13.

Abbreviation	Description	Definition
OK	All right	Works as it should
BT	Blow through	Steam is escaping from this steam trap, with maximum steam losses. Needs to be replaced
LK	Leaks	Steam leaks from this steam trap. It needs to be repaired or replaced
RC	Rapid cycle	The cycle of this thermodynamic steam trap is too fast. Must be repaired or replaced
PL	Plugged	The steam trap is closed. No condensate can flow through it. To be replaced
FL	Flooded	This steam trap can no longer deal with the flow of condensate. To be replaced with a trap of the right size
OS	Out of service	This line is out of order
NT	Not tested	The steam trap cannot be reached and was therefore not tested

Table 3.13: Various operating phases of steam traps
[29, Maes, 2005]

The amount of steam lost can be estimated for a steam trap as follows:

$$L_{t,y} = \frac{1}{150} \times FT_{t,y} \times FS_{t,y} \times CV_{t,y} \times h_{t,y} \times \sqrt{P_{in,t}^2 - P_{out,t}^2} \quad \text{Equation 3.5}$$

Where:

- $L_{t,y}$ = the amount of steam that steam trap t is losing in period y (tonne)
- $FT_{t,y}$ = the operating factor of steam trap t during period y
- $FS_{t,y}$ = the load factor of steam trap t during period y
- $CV_{t,y}$ = the flow coefficient of steam trap t during period y
- $h_{t,y}$ = the amount of operating hours of steam trap t during period y
- $P_{in,t}$ = the ingoing pressure of steam trap t (atm)
- $P_{out,t}$ = the outgoing pressure of steam trap t (atm).

The operating factor $FT_{t,y}$ follows from Table 3.14:

	Type	FT
BT	Blow through	1
LK	Leaks 0.	25
RC	Rapid cycle	0.20

Table 3.14: Operating factors for steam losses in steam traps
[29, Maes, 2005]

The load factor takes into account the interaction between steam and condensate. The more condensate that flows through the steam trap, the less space there is to let steam through. The amount of condensate depends on the application as shown in Table 3.15 below:

Application	Load factor
Standard process application	0.9
Drip and tracer steam traps	1.4
Steam flow (no condensate)	2.1

Table 3.15: Load factor for steam losses
[29, Maes, 2005]

Finally the size of the pipe also determines the flow coefficient:

- $CV = 3.43 D^2$
- where D = the radius of the opening (cm).

An example calculation is:

- $FT_{t,yr} = 0.25$
- $FS_{t,yr} = 0.9$ because the amount of steam that passed through the trap is condensed, but correct in comparison with the capacity of the steam trap (see Table 3.15 above)
- $CV_{t,yr} = 7.72$
- $D = 1.5$ cm
- $h_{t,yr} = 6000$ hours per year
- $P_{in,t} = 16$ atm
- $P_{out,t} = 1$ atm.

The steam trap thus loses up to 1110 tonnes of steam per year.

If this occurs in an installation where steam costs EUR 15/tonne, then the final loss would amount to: EUR 16 650 per year.

If the steam totally escapes, rather than just by leaking, costs might rise to up to EUR 66 570 per year.

These losses rapidly justify the setting up of an effective management and control system for all the steam traps in an installation.

Applicability

A programme to track down leaking steam traps and to determine whether steam traps need to be replaced is required for every steam system. Steam traps often have a relatively short lifespan.

The frequency by which steam traps are checked depends on the size of the site, the rate of the steam flow, the operating pressure(s), the number and size of traps, and the age and condition of the system and the traps, as well as any existing planned maintenance. The cost benefit of undertaking major inspections and changing programmes needs to be balanced according to these factors. (Some sites may have 50 traps or fewer, all easily accessible, where others may have 10 000 traps.)

Some sources indicate that equipment with large steam traps (e.g. with steam flows of about 1 tonne of steam an hour or more), especially operating at a high pressure, may be checked annually, and less critical ones on a rolling programme of 25 % of traps every year (i.e. every trap is checked at least once every 4 years). This is comparable to LDAR (leak detection and repair) programmes which are now being required in such installations by many governments. In one example, where trap maintenance was haphazard, up to 20 % of traps were defective. With an annual follow-up, leaks can be reduced to 4 – 5 % of traps. If all traps were checked annually, there will be a slow decrease to about 3 % after 5 years (as older traps are replaced by newer models).

In all cases, when checking steam traps, it is good practice to also check by-pass valves. These are sometimes opened to avoid over-pressure in lines and damage (especially in tracer lines), where the steam trap is not able to evacuate all the condensate, and for operational reasons. It is generally more effective to rectify the original problem, make proper repairs, etc. (which may entail capital expenditure) than operate with poor energy efficiency in the system.

An automated control mechanism can be installed on each type of steam trap. Automatic steam trap controls are particularly applicable for:

- traps with high operating pressures, so any leakage rapidly accrues high energy losses
- traps whose operation is critical to operations and whose blockage will result in damage or production loss.

Economics

The costs for replacement are generally considerably less than the losses as a result of defective operation. Rapid payback, depending on the scale of the leakage. See example above.

Driving force for implementation

- cost
- improved steam system efficiency.

Examples

Widely used.

Reference information

[29, Maes, 2005], [16, CIPEC, 2002]

3.2.13 Collecting and returning condensate to the boiler for re-use

Description

Where heat is applied to a process via a heat exchanger, the steam surrenders energy as latent heat as it condenses to hot water. This water is lost, or (usually) collected and returned to the boiler. Re-using condensate has four objectives:

- re-using the energy contained in the hot condensate
- saving the cost of the (raw) top-up water
- saving the cost of boiler water treatment (the condensate has to be treated)
- saving the cost of waste water discharge (where applicable).

Condensate is collected at atmospheric and negative pressures. The condensate may originate from steam in appliances at a much higher pressure.

Achieved environmental benefits

Where this condensate is returned to atmospheric pressure, flash steam is spontaneously created. This can also be recovered (see Section 3.2.14).

The re-use of condensate also results in a reduction in chemicals for water treatment. The quantity of water used and discharged is also reduced.

Cross-media effects

No data submitted.

Operational data

Deaeration is necessary in the case of negative pressure systems.

Applicability

The technique is not applicable in cases where the recovered condensate is polluted or if the condensate is not recoverable because the steam has been injected into a process.

With respect to new designs, a good practice is to segregate the condensates into potentially polluted and clean condensate streams. Clean condensates are those coming from sources which, in principle, will never be polluted (for instance, coming from reboilers where steam pressure is higher than process pressure, so that in the case of leaking tubes, steam goes into the process rather than process components into the steam side). Potentially polluted condensates are condensates which could be polluted in the case of an incident (e.g. tube rupture on reboilers where process-side pressure is higher than steam-side pressure). Clean condensates can be recovered without further precautions. Potentially polluted condensates can be recovered except in the case of pollution (e.g. leak from a reboiler) which is detected by online monitoring, e.g. TOC meter.

Economics

The recovery of condensate has significant benefits and should be considered in all applicable cases (see Applicability, above), except where the amount of condensate is low (e.g. where steam is added into the process).

Driving force for implementation

No data submitted.

Examples

Generally applied.

Reference information

[29, Maes, 2005], [16, CIPEC, 2002]

3.2.14 Re-use of flash steam**Description**

Flash steam is formed when the condensate at high pressure is expanded. Once the condensate is at a lower pressure, part of the condensate will vaporise again and form flash steam. Flash steam contains both the purified water and a large part of the available energy, which is still present in the condensate.

Energy recovery can be achieved through heat exchange with make-up water. If the blowdown water is brought to a lower pressure in a flash tank beforehand, then steam will be formed at a lower pressure. This flash steam can be moved directly to the degasser and can thus be mixed with the fresh make-up water. The flash steam does not contain any dissolved salts and the steam represents a large portion of the energy in the blowdown.

Flash steam does, however, occupy a much larger volume than condensate. The return pipes must be able to deal with this without pressure increases. Otherwise, the resulting backpressure may hamper the proper functioning of steam traps and other components upstream.

In the boilerhouse, the flash steam, like the condensate, can be used to heat the fresh feed-water in the degasser. Other possibilities include the use of the flash steam for air heating.

Outside the boilerhouse, flash steam can be used to heat components to under 100 °C. In practice, there are steam uses at the pressure of 1 barg. Flash steam can thus be injected into these pipes. Flash steam can also be used to preheat air, etc.

Low pressure process steam requirements are usually met by throttling high pressure steam, but a portion of the process requirements can be achieved at low cost by flashing high pressure condensate. Flashing is particularly attractive when it is not economically feasible to return the high pressure condensate to the boiler.

Achieved environmental benefits

The benefits are case dependent.

At a pressure of 1 bar the condensate has a temperature of 100 °C and an enthalpy of 419 kJ/kg. If the flash steam or the steam post evaporation is recovered, then the total energy content depends on the workload of the installation. The energy component which leaves the steam systems via the condensate is shown in Table 3.16, which also shows the relative quantity of energy in the condensate and in the flash steam. At higher pressures, the flash steam contains the majority of the energy.

Absolute pressure (bar)	In condensate at atmospheric pressure (%)	In condensate + steam post evaporation at boiler pressure (%)	Relative share of the energy which can be recovered in flash steam (%)
1	13.6	6	0.0
2	13.4	7	19.9
3	13.3	7	28.9
5	13.2	5	38.6
8	13.1	3	46.2
10	13.0	25.8	49.4
15	13.0	28.7	54.7
20	12.9	30.9	58.2
25	12.9	32.8	60.6
40	12.9	37.4	65.4

Note: The feed-water for the installation often has an annual average temperature of approximately 15 °C. These figures were calculated based on a situation whereby the supply of water to the installation occurs at 15 °C, or with an enthalpy of 63 kJ/kg

Table 3.16: Percentage of total energy present in the condensate at atmospheric pressure and in the flash steam
[29, Maes, 2005]

Cross-media effects

Where flash steam is produced from pressurised condensate, the temperature (and energy content) of the condensate returning to the boiler is lowered. Where an economiser is fitted, this has the potential advantage that the economiser can then recover more energy from the exhaust stack into the return/feed-water stream, and the boiler efficiency will improve. This is the most energy efficient combination. However, there must be a use for the low pressure (LP) steam from flashing, taking into account that LP steam (from all sources) can only be moved limited distances. In many cases (such as in refineries and chemical plants) there is a surplus of LP steam, and there is often no use for the steam from flashing. In such cases, the best option is to return the condensate to the deaerator, as flashing steam to the atmosphere is a waste of energy. To avoid condensate problems, condensate can be collected locally in a specific unit or activity and pumped back to the deaerator.

The installation of either option depends on the cost-benefit of installing the necessary pipework and other equipment (see Section 1.1.6).

Operational data

The re-use of flash steam is possible in many cases, often for heating to under 100 °C. There are a number of possibilities.

Collection of the flash steam in the condensate pipes. During the lifespan of the installation, various components may be added into the same lines, and the condensate return pipe may become too small for the quantity of condensate to be recovered. In most cases, this condensate is recovered at atmospheric pressure, therefore the major part of the pipe is filled with flash steam. If there is an increase in condensate discharge, the pressure in these pipes may rise to over 1 barg. This can lead to problems upstream and may hamper the proper functioning of the steam traps, etc.

Flash steam can be discharged to a flash tank installed at a suitable point in the return pipe run. The flash steam can then be used for local preheating or heating at less than 100 °C. At the same time, the pressure in the condensate return pipe will be reduced to normal, avoiding the upgrading of the condensate return network.

When reviewing an existing network, an option to be considered is to return the condensate at a lower pressure. This will generate more flash steam and the temperature will also decrease to under 100 °C.

When using steam, for example for heating at less than 100 °C, it is possible that the real pressure in the heating coil, following adjustment, decreases to under 1 bar. This may result in suction of the condensate into the coil, and flooding it. This can be avoided by recovering condensate at low pressure. More flash steam is generated as a result of the low pressure and more energy is recovered from the condensate. The components working at these lower temperatures can be switched to an individual network. However, additional pumps need to be installed to maintain this low pressure and to remove any air leaking into the pipes from the outside.

Applicability

This technique applies when the site has a steam network with pressures lower than the pressure at which steam is generated. Then, re-using flash steam can be exergetically more favourable than just exchanging the heat in the blowdown via a heat exchanger.

In theory, any energy use at a lower temperature can be a possible use for flash steam instead of fresh steam and there will be a range of opportunities on investigation, although implementation is not always easy. It is widely applicable in the petrochemical industry.

Economics

The recovery of flash steam saves on fresh top-up water and its treatment, although the main cost savings are in energy. The recovery of flash steam leads to much greater energy savings than with the simple collection of liquid condensate.

See Examples in Annex 7.10.1.

Driving force for implementation

- cost saving
- use of low pressure steam.

Examples

No data submitted.

Reference information

[29, Maes, 2005, 123, US_DOE]

3.2.15 Recovering energy from boiler blowdown

Description

Energy can be recovered from boiler blowdown by using a heat exchanger to preheat boiler make-up water. Any boiler with continuous blowdown exceeding 4 % of the steam rate is a good candidate for the introduction of blowdown waste heat recovery. Larger energy savings occur with high pressure boilers.

Alternatively, flashing the blowdown at medium or low pressure is another way to valorise the energy which is available (see Section 3.2.14).

Achieved environmental benefits

The potential energy gains from the recovery of heat from the blowdown is shown in Table 3.17:

Recovered energy from blowdown losses, in MJ/h ²³					
Blowdown rate % of boiler output	Operating pressure of the boiler				
	2 barg	5 barg	10 barg	20 barg	50 barg
1	42 52		61	74	95
2	84 103		123	147	190
4	168 207		246	294	379
6	252 310		368	442	569
8	337 413		491	589	758
10	421	516	614	736	948

Table 3.17: Recovered energy from blowdown losses
[29, Maes, 2005]

By reducing the blowdown temperature, it is easier to comply with environmental regulations requiring waste water to be discharged below a certain temperature.

Cross-media effects

None known.

Operational data

See examples, in Annex 7.10.1.

Applicability

See Economics, below.

Economics

The efficiency of such a technique usually results in costs recovery within a few years.

Driving force for implementation

Cost savings.

Examples

See examples, in Annex 7.10.1.

Reference information

[29, Maes, 2005], [16, CIPEC, 2002] [123, US_DOE] CEN EN 12952-15:2003 and CEN EN 12953-11:2003

²³ These quantities have been determined based on a boiler output of 10 t/h, an average temperature of the boiler water of 20 °C, and a recovery efficiency of 88 % of the heat from blowdown.

3.3 Heat recovery and cooling

[16, CIPEC, 2002, 26, Neisecke, 2003, 34, ADENE, 2005, 97, Kreith, 1997]

Heat naturally flows from the higher temperature (heat source) to a lower temperature (heat sink) (see Section 1.2.2.2, second law of thermodynamics). Heat flows from an activity, process or system may be seen by analogy to other emissions to the environment as two types:

1. Fugitive sources, e.g. radiation through furnace openings, hot areas with poor or no insulation, heat dissipated from bearings.
2. Specific flows, e.g.:
 - hot flue-gases
 - exhaust air
 - cooling fluids from cooling systems (e.g. gases, cooling water, thermal oil)
 - hot or cold product or waste product
 - hot or cold water drained to a sewer
 - superheat and condenser heat rejected from refrigeration.

These heat losses are often called 'waste heat', although the term should be 'surplus heat', as heat may be recovered from the specific heat flows for use in another process or system. To assist the reader, the term 'waste/surplus heat' is used in this section.

There are two levels of heat flow exergy (heat 'quality'; see Section 1.2.2.2):

1. Heat from hot streams such as hot flue-gases.
2. Heat from relatively cold streams (such as $<80\text{ }^{\circ}\text{C}$). These are more difficult to valorise, and the exergy of the heat may need to be upgraded.

In simple cases, these can be addressed directly, using techniques described in this section. In the more complex installations with more than one heat source and/or heat sink, heat recovery is best investigated at a site or process level, for example by using tools such as pinch methodology, and applying process-process heat exchange or process integration, (see Sections 2.3, 2.4 and 2.12).

Heat recovery technologies

The most commonly used heat recovery techniques are the following:

- direct usage: heat exchangers make use of heat as it is in the surplus stream (e.g. hot flue-gases, see Section 3.2.5)
- heat pumps upgrade the heat in relatively cold streams so that it can perform more useful work than could be achieved at its present temperature (i.e. an input of high quality energy raises the energy quality of the waste/surplus heat)
- multistage operations such as multi-effect evaporation, steam flashing and combinations of the approaches already mentioned (see Section 3.11.3.6).

Before investigating the possibilities of heat recovery, it is important that the relevant processes are optimised. Optimisation after introducing heat recovery may adversely affect the heat recovery, the recovery system may be found to be oversized, and the cost-benefit will be adversely affected.

Subsequently, it is essential to evaluate the quality and quantity of waste/surplus heat, and then to identify possible uses. Heat recovery is often limited by the quality of the waste heat and the possibilities for use.

It is crucial to have relevant, quantified information and knowledge of the processes from which the heat arises and into which the heat recovery is to be incorporated. The prime reason for difficulty and failure of waste heat recovery is lack of understanding. Errors and omissions are likely to have a more profound effect than, for example, an ill-judged choice of the type of heat exchanger. Apart from thermodynamic errors, it is the physical properties of a waste heat source which can lead to problems with whichever heat exchanger is chosen, if not fully investigated at the outset.

In-depth understanding of the process operation, together with knowledge of how far the operating parameters can be modified, is essential to the successful integration of heat recovery into a process. Detailed measuring and recording of operating data provides an excellent start for planning. This also helps the process engineer to identify savings possible through low cost measures.

The options are:

- using the heat in the process from where it originates (i.e. recirculation, often using heat exchangers, e.g. economisers, see Section 3.2.5)
- using the heat within another system or unit (this option may arise because the waste heat is at an insufficiently high enough temperature). This is of two types:
 - within the installation, in another unit or process
 - in a nother installation (such as s i n i n t e g r a t e d c h e m i c a l f a c i l i t i e s), or in the wider community, such as district heating; see Cogeneration, Section 3.4.

If the waste heat does not have a sufficiently high enough exergy, this can be raised using heat pumps, or a low energy use can be found, such as hot water or space heating in HVAC.

This section therefore discusses cooling (as a significant opportunity for heat recovery), and the two main techniques mentioned: heat exchangers and heat pumps.

3.3.1 Heat exchangers

Description

Direct heat recovery is carried out by heat exchangers. A heat exchanger is a device in which energy is transferred from one fluid or gas to another across a solid surface. They are used to either heat up or cool down processes or systems. Heat transfer happens by both convection and conduction.

Discharge heat at relatively low temperatures such as 70 °C, but can be up to 500 °C can be found in many industrial sectors such as:

- chemicals including polymers
- food and drink
- paper and board
- textiles and fabrics.

In this range of temperatures, the following heat recovery equipment (heat exchangers) can be used depending on the type of fluids involved (i.e. gas-gas, gas-liquid, liquid-liquid) and the specific application:

- rotating regenerator (adiabatic wheel)
- coil
- heat pipe/thermosyphon heat exchanger
- tubular recuperator
- economiser

- condensing economiser
- spray condenser (fluid-heat exchanger)
- shell and tube heat exchanger
- plate heat exchanger
- plate and shell heat exchanger.

At higher temperatures (above 400 °C), in process industries such as in iron, iron and steel, copper, aluminium, glass and ceramics, the following methods are available for recovering waste heat from gases:

- plate exchangers
- shell and tube heat exchangers
- radiation tubes with recuperators
- convection tubes with recuperators
- recuperative burner systems and self-recuperative burners
- static regenerators
- rotary regenerators
- compact ceramic regenerators
- impulse-fired regenerative burners
- radial plate recuperative burners
- integral bed regenerative burners. Fluidised beds are used for severe working conditions, fouling, e.g. in pulp and paper mills
- energy optimising furnace.

Dynamic or scrapped surface heat exchangers are used mainly for heating or cooling with high viscosity products, crystallisation processes, evaporation, and high fouling applications.

One of the widest uses of heat exchangers is for air conditioning, see Section 3.9. These systems use coils (referring to their serpentine internal tubing).

Efficiency

Heat exchangers are designed for specific energy optimised applications. The subsequent operation of heat exchangers under different or variable operating conditions is only possible within certain limits. This will result in changes to the transferred energy, the heat transfer coefficient (U-value) and the pressure drop of the medium.

The heat transfer coefficient and hence transferred power are influenced by the thermal conductivity as well as the surface condition and thickness of the heat transfer material. Suitable mechanical design and choice of materials can increase the efficiency of the heat exchanger. Costs and mechanical stresses also play a major role in the choice of material and structural design.

The power transferred through the heat exchanger is heavily dependent on the heat exchanger surface. The heat exchanger surface area may be increased using ribs (e.g. ribbed tube heat exchangers, lamella heat exchangers). This is particularly useful in attaining low heat transfer coefficients (e.g. gas heat exchangers).

The accumulation of dirt on the heat exchanger surface will diminish the heat transfer. Dirt levels may be reduced by using appropriate materials (very smooth surfaces), structured shapes (e.g. spiral heat exchangers) or changing the operating conditions (e.g. high fluid speeds). Furthermore, heat exchangers may be cleaned or fitted with automatic cleaning systems (dynamic or scrapped surface).

Higher flowrates will increase the heat transfer coefficient. However, increased flowrates will also result in higher pressure drops. High levels of flow turbulence improve heat transfer but result in an increased pressure drop. Turbulence may be generated by using stamped heat exchanger plates or by fitting diverters.

The transferred power is also dependent on the physical state of the fluid (e.g. temperature and pressure). If air is used as the primary medium, it may be humidified prior to entering the heat exchanger. This improves the heat transfer.

Achieved environmental benefits

Energy savings are made by using secondary energy flows.

Cross-media effects

No data submitted.

Applicability

Heat recovery systems are widely used with good results in many industrial sectors and systems, see Description, above. See also Section 3.2.

It is being applied for an increasing number of cases, and many of these can be found outside of the installation, see Cogeneration, Section 3.4, and Annexes 7.10.3 and 7.10.4. Heat recovery is not applicable where there is no demand that matches the production curve.

Economics

Payback time may be as short as six months or as long as 50 years or more. In the Austrian pulp and paper industry, the payback time of the complex and different systems was between one and about three years.

The cost-benefits and payback (amortisation) periods can be calculated, e.g. as shown in the ECM REF.

In some cases, particularly where the heat is used outside the installation, it may be possible to use funding from policy initiatives, see Annex 7.13.

Driving force for implementation

- reduction of energy costs, reduction of emissions and the of ten rapid return of investments
- improved process operation, e.g. reduction of surface contamination (in scrapped surface systems), improvement of existing equipment/flows, reduction in system pressure drop (which increases the potential maximum plant throughput)
- savings in effluent charges.

Examples

- industries cited in the Description, above: chemicals, food and drink, paper and board, textile and fabrics
- in the Austrian pulp and paper industry
- Tait Paper at Inverure, Aberdeenshire, UK.

Reference information

[16, CIPEC, 2002], [26, Neisecke, 2003], [34, ADENE, 2005] [97, Kreith, 1997] [127, TWG]

3.3.1.1 Monitoring and maintenance of heat exchangers

Description

Condition monitoring of heat exchanger tubes may be carried out using eddy current inspection. This is often simulated through computational fluid dynamics (CFD). Infrared photography (see Section 2.10.1) may also be used on the exterior of heat exchangers, to reveal significant temperature variations or hot spots.

Fouling can be a serious problem. Often, cooling waters from rivers, estuaries or a sea is used, and biological debris can enter and build layers. Another problem is scale, which is chemical deposit layers, such as calcium carbonate or magnesium carbonate (see Section 3.2.6). The process being cooled can also deposit scale, such as silica scale in a alumina refineries. See Examples, below).

Achieved environmental benefits

Improved heat exchange for heat recovery.

Cross-media effects

Use of chemicals for removing scale.

Operational data

- plate heat exchangers need to be cleaned periodically, by disassembling, cleaning and re-assembly
- tube heat exchangers can be cleaned by acid cleaning, bullet cleaning or hydrodrilling (the last two may be proprietary techniques)
- the operation and cooling of cooling systems is discussed in the ICS BREF.

Applicability

- applicable to all heat exchanges
- specific techniques are selected on a case-by-case basis.

Economics

Maintaining the heat exchangers to their design specifications optimises payback.

Driving force for implementation

Maintaining production capacity.

Examples

Acid cleaning: Eurallumina, Portovecompany, Italy. See Annex 7.10.2.

Reference information

Infra red: [162, SEI, 2006]

3.3.2 Heat pumps (including mechanical vapour recompression, MVR)

Description

The main purpose for heat pumps is to transform energy from a lower temperature level (low exergy) to a higher level. Heat pumps can transfer heat (not generate heat) from man-made heat sources such as industrial processes, or from natural or artificial heat sources in the surroundings, such as the air, ground or water, for use in domestic, commercial or industrial applications. However, the most common use of heat pumps is in cooling systems, refrigerators, etc. Heat is then transferred in the opposite direction, from the application that is cooled, to the surroundings. Sometimes the excess heat from cooling is used to meet a simultaneous heat demand elsewhere. Heat pumps are used in co- and trigeneration, these are systems that provide both cooling and heating simultaneously, and with varying seasonal demands (see Sections 3.4 and 3.4.2).

In order to transport heat from a heat source to a location where heat is required, external energy is needed to drive the heat pump. The drive can be any type, such as an electric motor, a combustion engine, a turbine or a heat source for adsorption heat pumps.

Compression heat pumps (closed cycle)

The most widely used heat pump is probably the compressor driven pump. It is, for instance, installed in refrigerators, air conditioners, chillers, dehumidifiers, heat pumps for heating with energy from rock, soil, water and air. It is normally driven by an electrical motor but for large installations, steam turbine driven compressors can be used.

Compression heat pumps use a counterclockwise Carnot process (cold steam process) consisting of the phases of evaporation, compression, condensation and expansion in a closed cycle.

Figure 3.8 shows the principle of a compression heat pump. In the evaporator, the circulating working fluid evaporates under low pressure and low temperature, e.g. due to waste heat. Subsequently, the compressor increases the pressure and temperature. The working fluid is liquefied in a condenser and releases the usable heat in this process. The fluid is then forced to expand to a low pressure and as it evaporates, it absorbs heat from the heat source. Thus the energy at low temperature in the heat source (e.g. waste water, flue-gas) has been transformed to a higher temperature level to be used in another process or system.

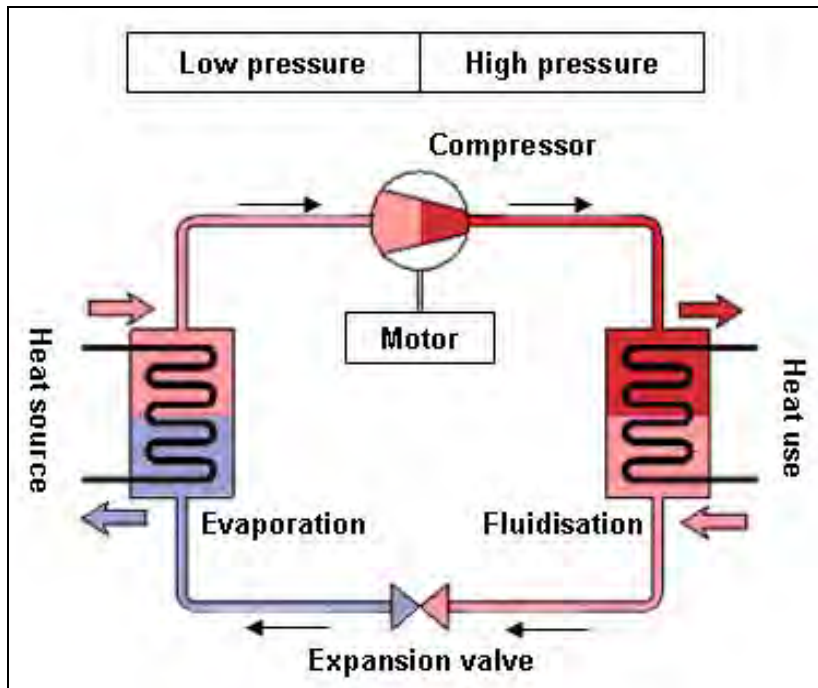

Figure 3.8: Diagram of a compression heat pump
[28, Berger, 2005]

In a compression heat pump, the degree of efficiency is indicated as the coefficient of performance (COP), which indicates the ratio of heat output to energy input, such as electricity to the compressor motor. The necessary energy input is effected in the form of electrical energy input to the compression motor.

The COP of the compression heat pump can be expressed as:

$$COP_r = \frac{Q_c}{Q_h - Q_c} \quad \text{Equation 3.6}$$

$$COP_{hp} = \frac{Q_h}{Q_h - Q_c} \quad \text{Equation 3.7}$$

where:

COP_r and COP_{hp} are the coefficients of performance for refrigeration systems and heat pumps, and the Q_c and Q_h are the heat exchanged with the cold and the hot system.

The Carnot efficiency can be regarded as a constant for moderate variations of the temperatures.

Compression heat pumps can reach a COP of up to 6, meaning that a heat output of 6 kWh can be generated from an input of 1 kWh of electrical energy in the compressor. In waste to energy (W-t-E) installations, the ratio between output heat and compressor power (heat to power ratio) can be about 5.

However, COP is only valid for one single steady-state condition. Therefore, this coefficient is not always adequate to rate the efficiency of a heat pump since a steady-state condition cannot be representative for long periods of time. In practice, only the seasonal overall efficiency (SOE) can properly describe the efficiency of a heat pump. Further, auxiliary energy applied to gain energy from the heat source must be considered when describing a heat pump's energy efficiency.

For a good seasonal overall efficiency, the following requirements should be met:

- good quality of the heat pump itself
- high and constant heat source temperature (surplus heat is better than surrounding air)
- low heat sink (output) temperature
- integration of all components (i.e. heat pump, heat source, heat sink, control, heat distribution) to a whole, optimised system.

Absorption heat pumps

The absorption heat pump is not as widely used, particularly in industrial applications. Like the compressor type it was originally developed for cooling. Commercial heat pumps operate with water in a closed loop through a generator, condenser, evaporator and absorber. Instead of compression, the circulation is maintained by water absorption in a salt solution, normally lithium bromide or ammonia, in the absorber.

Figure 3.9 shows the principle of an absorption heat pump: in an absorption heat pump, the gaseous working fluid (cooling agent) coming from the evaporator is absorbed by a liquid solvent, and heat is generated in the process. This enriched solution is conveyed to the ejector via a pump with an increase in pressure, after which the working fluid (cooling agent) is extracted from the two substance mixture using an external heat supply (e.g. a natural gas burner, liquid petroleum gas (LPG), or waste heat). The absorber/ejector combination has a pressure increasing effect (thermal compressor). The gaseous working substance exits the ejector at a higher pressure and enters the condenser, where it is liquefied and releases usable heat to the process.

The energy input necessary to operate a solvent pump is low compared to that necessary to operate the compressor of a compression heat pump (the energy necessary to pump a liquid is lower than that necessary to compress and transport gas).

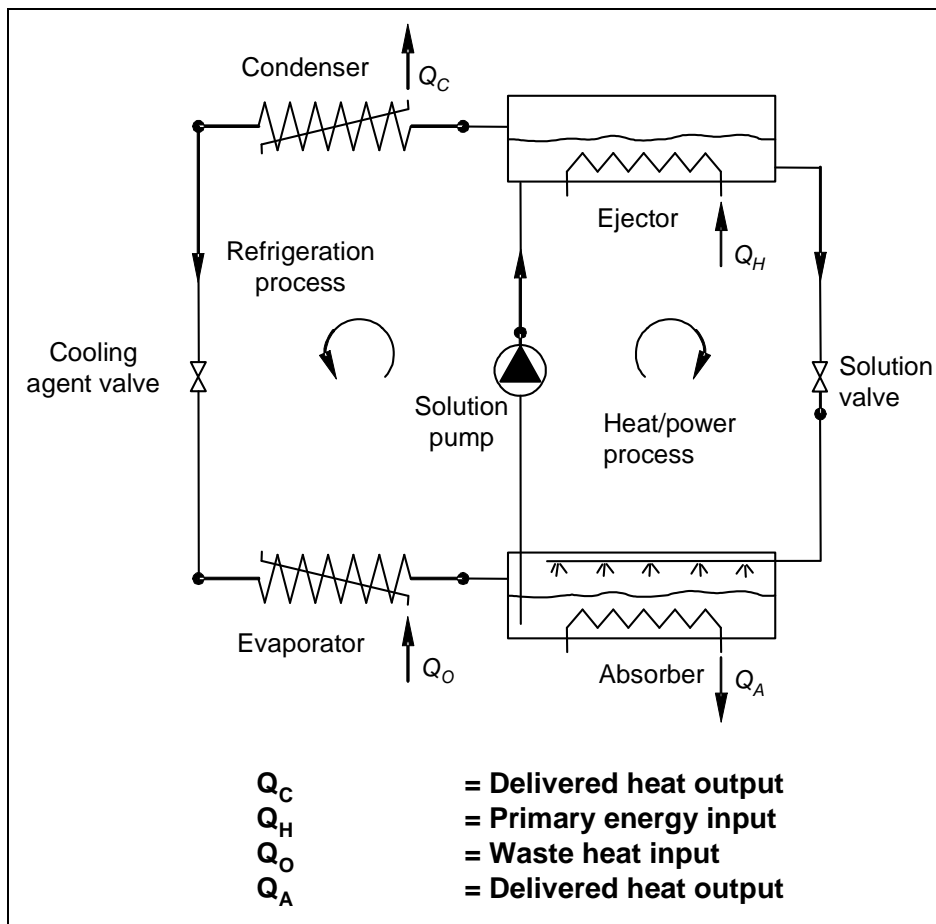

Figure 3.9: Diagram of an absorption heat pump
 [28, Berger, 2005]

In absorption pumps, the degree of efficiency is indicated as the heat efficiency coefficient. It is defined as the ratio of heat output to fuel energy input. If waste heat is used as a heat source in the ejector, the thermal coefficient is used instead of heat efficiency. The thermal coefficient is defined as the ratio of heat output to waste heat input. Modern absorption heat pumps can reach heat efficiency coefficients of up to 1.5. The ratio between output heat and absorber power is normally about 1.6. Current systems with a water/lithium bromide solution as the working substance mixture achieve an output temperature of 100 °C and a temperature lift of 65 °C. The new generation of systems will have higher output temperatures (of up to 260 °C) and higher temperature lifts.

Mechanical vapour recompression (MVR)

MVR is an open or semi-open heat pump (referring to the heat pump system). Low pressure vapour exhaust from industrial processes, such as boilers, evaporators or cookers, is compressed and subsequently condensed giving off heat at a higher temperature, and thereby replacing live steam or other primary energy. The energy to drive the compressor is typically only 5 to 10 % of the heat delivered. A simplified flow sheet for a MVR installation is shown in Figure 3.10.

If the vapour is clean it can be used directly, but with contaminated vapours, an intermediate heat exchanger (reboiler) is necessary. This is a semi-open system.

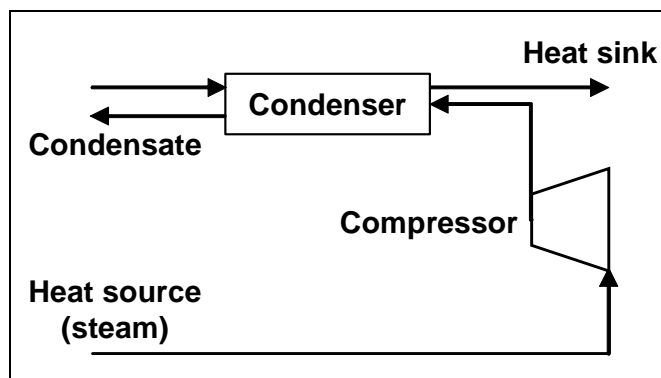

Figure 3.10: Simple MVR installation
[18, Åsbländ, 2005]

In MVR, as one or two heat exchangers are eliminated (the evaporator and/or condenser in other heat pumps) efficiency is generally high. The efficiency is a gain expressed as ‘coefficient of performance’ (COP). It is defined as the ratio of the heat delivered and shaft work to the compressor. In Figure 3.11, typical COP values for MVR installations are plotted versus temperature lift. Normal COP values for MVR installations are in the range 10 – 30.

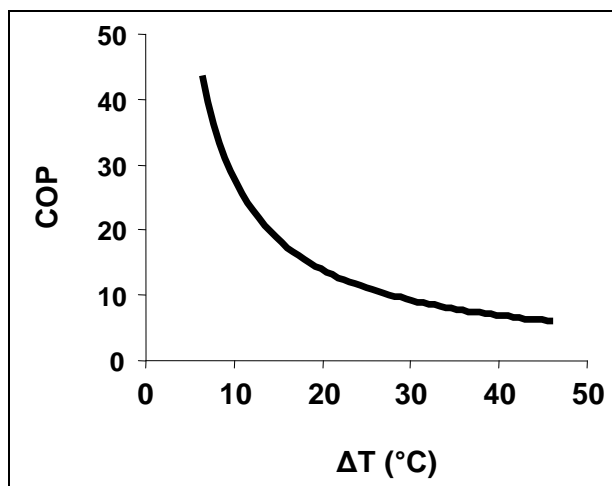

Figure 3.11: COP versus temperature lift for a typical MVR system
[18, Åsbländ, 2005]

The COP for an MVR installation is given by Equation 3.8

$$\text{COP} > \frac{\eta_{\text{boiler}}}{\eta_{\text{power plant}} \eta_{\text{distribution}}} \quad \text{Equation 3.8}$$

In Equation 3.8:

- η_{boiler} is the boiler efficiency in the plant/industry
- $\eta_{\text{power plant}}$ is the efficiency of the power plant generating electricity for the national grid
- $\eta_{\text{distribution}}$ accounts for distribution losses in the electric network.

Thus the COP must be larger than, say, 3 to be energy efficient if the electricity is produced in a condensing power plant. In practice, all MVR installations will have COP values well above that.

Achieved environmental benefits

Heat pumps enable the recovery of low grade heat, with primary energy consumption lower than the energy output (depending on the COP, and if the requirements for an good seasonal overall efficiency are fulfilled). This enables the use of low grade heat in useful applications, such as heating inside in the installation, or in the adjacent community. This results in reducing the use of primary energy and related gas emissions, such as carbon dioxide (CO₂), sulphur dioxide (SO₂) and nitrogen oxides (NO_x) in the specific applications.

The efficiency of any heat pump system is strongly dependent on the required temperature lift from source to sink.

Cross-media effects

Use of refrigerant with environmental impacts (greenhouse gas effect in particular) from leaks or decommissioning compression or absorption heat pumps.

Operational data

See Descriptions of heat pumps above.

Applicability

Compressor systems: typically used working fluids limit the output temperature to 120 °C.

Absorption systems: a water/lithium bromide working fluid pair can achieve an output of 100 °C and a temperature lift of 65 °C. New generation systems have higher output temperatures (up to 260 °C) and higher temperature lifts.

Current MVR systems work with heat source temperatures of 70 – 80 °C and delivery heat of 110 – 150 °C, and in some cases, up to 200 °C. The most common vapour compressed is steam although other process vapours are also used, notably in the petrochemical industry.

The situation in an industry with combined heat and power production is more complicated. For example, with backpressure turbines, the lost work from the turbines must also be considered.

Applicability

Heat pumps are used in cooling equipment and systems (where the heat removed is often dispersed, see Section 3.9). However, this demonstrates the technologies are robust and well developed. The technology is capable of a much wider application for heat recovery.

- space heating
- heating and cooling of process flows
- water heating for washing, sanitation and cleaning
- steam production
- drying/dehumidification
- evaporation
- distillation
- concentration (dehydration).

They are also used in co- and trigeneration systems.

The most common waste heat streams in industry are cooling fluid, effluent, condensate, moisture, and condenser heat from refrigeration plants. Because of the fluctuation in waste heat supply, it may be necessary to use large (insulated) storage tanks to ensure stable operation of the heat pump.

Adsorption heat pumps are applicable for cooling systems in sites where there is a large amount of waste heat.

Most MVR installations are in unit operations such as distillation, evaporation, and drying, but steam production to a steam distribution network is also common.

Relatively few heat pumps are installed in industry for heat recovery and usually realised in the course of planning new facilities and plants, or significant upgrades (see Section 2.3).

Heat pumps are more cost-effective when fuel costs are high. Systems tend to be more complex than fossil fuel fired systems, although the technology is robust.

Economics

The economy depends strongly on the local situation. The amortisation period in industry is 2 years at best. This can be explained on the one hand by the low energy costs, which minimise savings through the use of heat pumps and on the other hand by the high investment costs involved.

The profitability for an MVR installation, besides fuel and electricity prices, depends on installation costs. The installation cost for an installation at Nymölla in Sweden (see Examples below), was about EUR 4.5 million. The Swedish Energy Agency contributed a grant of nearly EUR 1.0 million. At the time of installation, the annual savings amounted to about EUR 1.0 million per year.

Driving force for implementation

- savings of operational energy costs
- an installation could provide the means to increase production without investing in a new boiler if the boiler capacity is a limiting factor.

Examples

- Dävamyren, Umeå, Sweden: compressor driven heat pump in waste to energy plant
- Renova Göteborg, Sweden: absorption driven heat pump
- Borlänge, Halmstad and Tekniska Verken, Linköping, Sweden, W-t-E plants, and biofuel burners, Sweden: MVR heat pumps
- at the StoraEnso sulphite mill in Nymölla, Sweden, a mechanical recompression system was installed in 1999. The heat source is exhaust steam from the pre-evaporation of black liquor. This contaminated steam, at 84 °C, is first condensed in a steam/steam heat exchanger (reboiler) to produce clean steam at a temperature of approximately 5 °C lower and at 0.45 barg pressure. The two-stage compressor raises the pressure to about 1.7 barg and the steam flow from the compressor, after desuperheating with water injection, amounts to 21 t/h. The steam is distributed in a low pressure steam system and used for pre-evaporation, feed-water heating, and district heating. The mechanical compressor is driven by a backpressure turbine. The shaft power is about 2 MW. The operating experience has, after some initial problems, been very good. The MVR reduces the fuel oil consumption in the boilers by about 7000 – 7500 tonnes per year
- MVR has been adapted to small scale installations, where the compressor can be run by a simple electric motor.

Reference information

[21, R VF, 2002], [26, Neisecke, 2003], [28, Berger, 2005] [18, Åsblad, 2005], [114, Caddet Analysis Series No. 28, 2001], [115, Caddet Analysis Series No. 23], [116, IEA Heat Pump Centre]

3.3.3 Chillers and cooling systems

Chillers or cooling systems are widely described in the ICS BREF. These terms are confined to systems to remove waste heat from any medium, using heat exchange with water and/or air to bring down the temperature of that medium towards ambient levels. Some chillers utilise ice or snow as refrigerants. The ICS BREF discusses only part of refrigeration systems, but does not discuss the issue of refrigerants such as ammonia, CO₂, F-gases, CFCs and HCFCs²⁴, etc. Also, direct contact cooling and barometric condensers are not assessed as they are considered to be too process specific.

The following industrial cooling systems or configurations are covered in ICS BREF:

- once-through cooling systems (with or without cooling tower)
- open recirculating cooling systems (wet cooling towers)
- closed circuit cooling systems
 - air-cooled cooling systems
 - closed circuit wet cooling systems
- combined wet/dry (hybrid) cooling systems
 - open hybrid cooling towers
 - closed circuit hybrid towers.

The variety of applications of cooling systems, the techniques and operational practices is enormous, as well as the different thermodynamic characteristics of individual processes. However, the ICS BREF concludes that:

"First, a primary BAT approach is given to the process to be cooled. Cooling of industrial processes can be considered as heat management and is part of the total energy management within a plant. A preventive approach should start with the industrial process requiring heat dissipation and aims to reduce the need for heat discharge in the first place. In fact, discharge of heat is wasting energy and as such is not BAT. Re-use of heat within the process should always be a first step in the evaluation of cooling needs.

Second, the design and the construction of a cooling system are an essential second step, in particular for new installations. So, once the level and amount of waste heat generated by the process is established and no further reduction of waste heat can be achieved, an initial selection of a cooling system can be made in the light of the process requirements". Table 3.18 extracted from the ICS BREF shows some examples of process characteristics and their corresponding primary BAT approach.

²⁴ HCFCs are ozone-depleting substances, in addition to CFCs. Both are being phased out, and alternatives are ammonia, CO₂, F-gases, etc.

Process characteristics	Criteria	Primary BAT approach	Remark	Reference in ICS BREF
Level of dissipated heat high (>60 °C)	Reduce use of water and chemicals and improve overall energy efficiency	(Pre) cooling with dry air	Energy efficiency and size of cooling system are limiting factors	Section 1.1/1.3
Level of dissipated heat medium (25 – 60°C)	Improve overall energy efficiency	Not evident	Site-specific	Section 1.1/1.3
Level of dissipated heat low (<25 °C)	Improve overall energy efficiency	Water cooling	Site selection	Section 1.1/1.3
Low and medium heat level and capacity	Optimum overall energy efficiency with water savings and visible plume reduction	Wet and hybrid cooling system	Dry cooling less suitable due to required space and loss of overall energy efficiency	Section 1.4
Hazardous substances to be cooled involving high environmental risk	Reduction of risk of leakage	Indirect cooling system	Accept an increase in approach	Section 1.4 and Annex VI

Table 3.18: Examples of process requirements and BAT in the ICS BREF

Besides process characteristics, the site itself may impose some limits applicable particularly to new installations as it is presented in Table 3.19.

Characteristics of site	Criteria	Primary BAT approach	Remarks	Reference in ICS BREF
Climate	Required design temperature	Assess variation in wet and dry bulb temperature	With high dry bulb temperature, dry air cooling generally has lower energy efficiency	Section 1.4.3
Space	Restricted surface on-site	(Pre-assembled) roof type constructions	Limits to size and weight of the cooling system	Section 1.4.2
Surface water availability	Restricted availability	Recirculating systems	Wet, dry or hybrid feasible	Section 2.3 and 3.3
Sensitivity of receiving water body for thermal loads	Meet capacity to accommodate thermal load	<ul style="list-style-type: none"> optimise level of heat re-use use recirculating systems site selection (new cooling system) 		Section 1.1
Restricted availability of groundwater	Minimisation of groundwater use	Air cooling if no adequate alternative water source is available	Accept energy penalty	Section 3.3
Coastal area	Large capacity >10 MW _{th}	Once-through systems	Avoid mixing of local thermal plume near intake point, e.g. by deep water extraction below mixing zone using temperature stratification	Sections 1.2.1 and 3.2, Annex XI.3
Specific site requirements	In cases of obligation for plume reduction and reduced tower height	Apply hybrid ²⁵ cooling system	Accept energy penalty	Chapter 2

Table 3.19: Examples of site characteristics and BAT in the ICS BREF

²⁵ Hybrid cooling systems are special mechanical tower designs which allow wet and dry operation to reduce visible plume formation. With the option of operating the systems (in particular small cell-type units) as dry systems during periods of low ambient air temperatures, a reduction in annual water consumption and visible plume formation can be achieved.

The optimisation of a cooling system to reduce its environmental impact is a complex exercise and not an exact mathematical comparison. In other words, combining techniques selected from the BAT tables does not lead to a BAT cooling system. The **final BAT solution will be a site-specific solution**. However, it is believed that, based on experience in industry, conclusions can be drawn on BAT, in quantified terms where possible.

Reference information

[237, Fernández-Ramos, 2007]

3.4 Cogeneration

[65, Nuutila, 2005], [97, Kreith, 1997].

The Directive 2004/8/EC on the promotion of cogeneration, defines cogeneration as ‘*the simultaneous generation in one process of thermal energy and electrical and/or mechanical energy*’. It is also known as ‘combined heat and power’ (CHP). There is significant interest in cogeneration, supported at European Community level by the adoption of Directive 2003/96/EC on energy taxation, which sets out a favourable context for cogeneration (CHP). The Green Paper on energy efficiency highlights losses in electricity generation and transmission, and the recovery of the heat and localised cogeneration as ways of overcoming this.

This section deals with different cogeneration applications describing their suitability in different cases. Applications are now possible which are cost efficient on a small scale.

3.4.1 Different types of cogeneration

Description

Cogeneration plants are those producing combined heat and power. Table 3.20 shows different cogeneration technologies and their default power to heat ratio.

Cogeneration technology	Default power to heat ratio, °C
Combined cycle gas turbines, (gas turbines combined with waste heat recovery boilers and one of the steam turbines mentioned below)	0.95
Steam turbine plants (backpressure)	0.45
Steam condensing extraction turbine (backpressure, uncontrolled extraction condensing turbines and extraction condensing turbines)	0.45
Gas turbines with heat recovery boilers	0.55
Internal combustion engines (Otto or diesel (reciprocating) engines with heat utilisation)	0.75
Microturbines	
Stirling engines	
Fuel cells (with heat utilisation)	
Steam engines	
Organic Rankin cycles	
Other types	

Table 3.20: List of cogeneration technologies and default power to heat ratios

[146, EC, 2004]

The amount of electricity produced is compared to the amount of heat produced and usually expressed as the power to heat ratio. This is under 1 if the amount of electricity produced is less than the amount of heat produced. The power to heat ratio should be based on actual data.

The annual load versus time curve can be used to determine the selection and size of a CHP.

Waste-to-energy plants (W-t-E)

For waste-to-energy plants, both the WI BREF and WFD²⁶ contain equivalent factors and values which can be used for:

- the calculation of energy recovery efficiency (utilisation) coefficients and/or plant efficiency factors
- if different qualities of energy have to be summarised, e.g. for benchmarking.

In this way, different kinds of energy can be evaluated and summarised as an energy mix output of, e.g. heat, steam and electricity. These conversion factors, therefore, allow the comparison of self-produced energy with energy generated externally to W-t-E plants. This assumes an overall European average of 38 % conversion efficiency (see also Annex 7.10.3) for external electrical energy generation in power plants and 91 % in external heating plants. For the use of energy, e.g. in a fuel or as steam, the possible utilisation rate is 100 %. The comparison of different energy measurement units, i.e. MWh, MWhe, MWheh can be taken into account.

Backpressure

The simplest cogeneration power plant is the so-called 'backpressure power plant', where CHP electricity and heat is generated in a steam turbine (see Figure 3.12). The electrical capacity of steam turbine plants working on the backpressure process is usually a few dozen megawatts. The power to heat ratio is normally about 0.3 - 0.5. The power capacity of gas turbine plants is usually slightly smaller than that of steam turbine plants, but the power to heat ratio is often close to 0.5.

The amount of industrial backpressure power depends on the heat consumption of a process and on the properties of high pressure, medium pressure and backpressure steam. The major determining factor of the backpressure steam production is the power to heat ratio.

In a district heating power plant, the steam is condensed in the heat exchangers below the steam turbine and circulated to consumers as hot water. In industrial plants, the steam from a backpressure power plant is fed to the factory where it surrenders its heat. The backpressure is lower in a district heating power plant than in industrial backpressure plants. This explains why the power to heat ratio of industrial backpressure power plants is lower than that of district heating power plants.

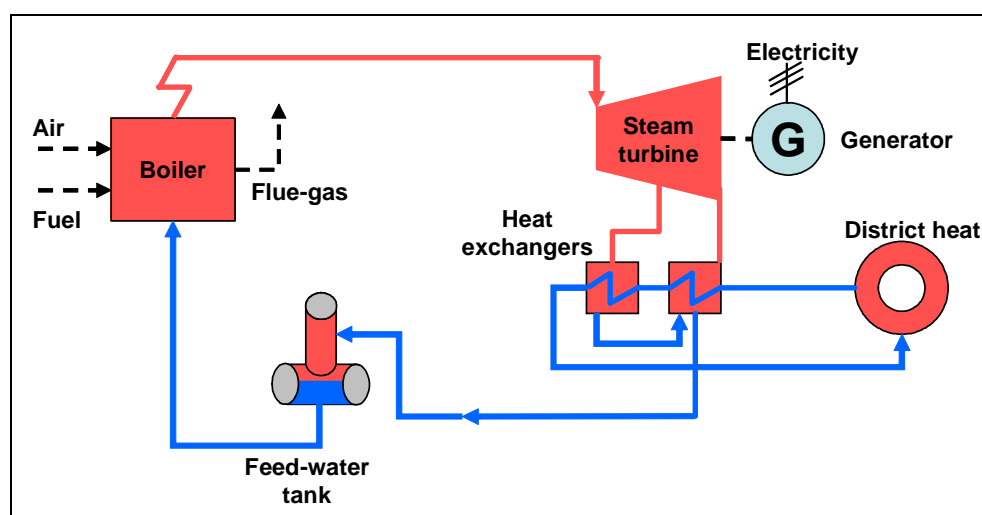

Figure 3.12: Backpressure plant
[65, Nuutila, 2005]

²⁶ Waste Frame Directive

Extraction condensing

A condensing power plant only generates electricity whereas in an extraction condensing power plant some of the steam is extracted from the turbine to generate heat (see Figure 3.13). The steam supply is explained in Section 3.2.

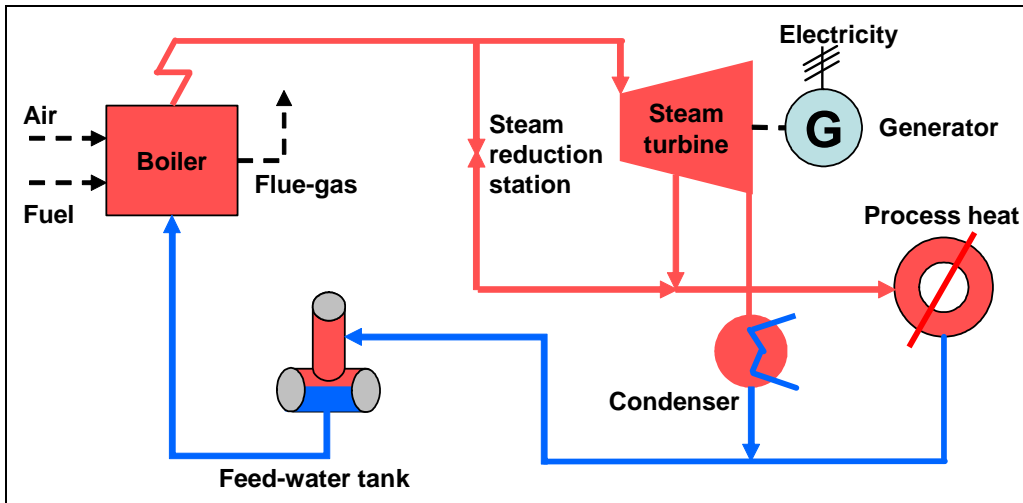

Figure 3.13: Extraction condensing plant
[65, Nuutila, 2005]

Gas turbine heat recovery boiler

In gas turbine heat recovery boiler power plants, heat is generated with the hot flue-gases of the turbine (see Figure 3.14). The fuel used in most cases is natural gas, oil, or a combination of these. Gas turbines can also be fired with gasified solid or liquid fuels.

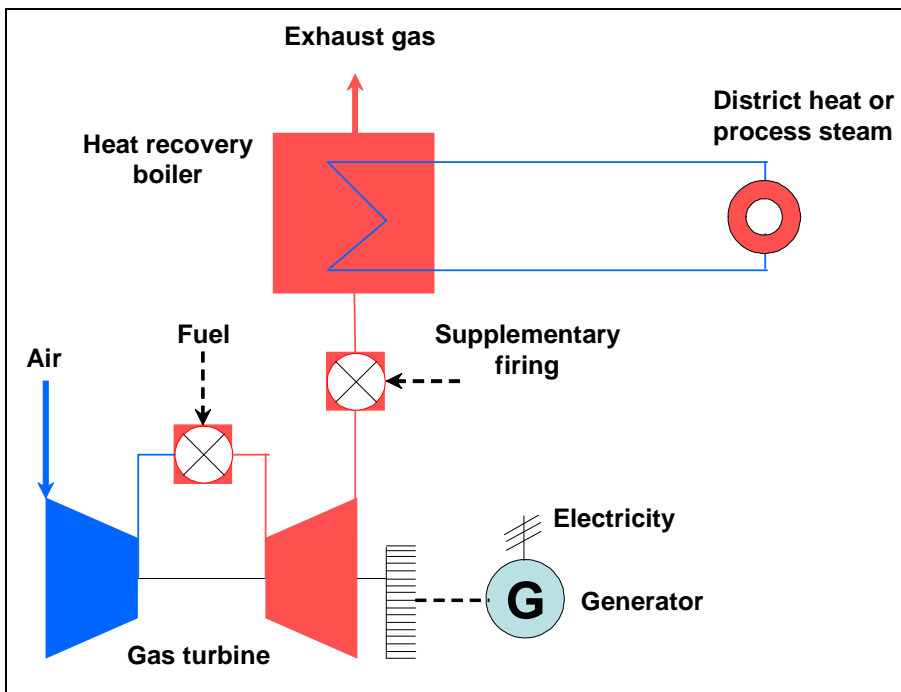

Figure 3.14: Gas turbine heat recovery boiler
[65, Nuutila, 2005]

Combined cycle power plant

A combined cycle power plant consists of one or more gas turbines connected to one or more steam turbines (see Figure 3.15). A combined cycle power plant is often used for combined heat and power production. The heat from the exhaust gases of a gas turbine process is recovered for the steam turbine process. The recovered heat is, in many cases, subsequently converted to more electricity, instead of being used for heating purposes. The benefit of the system is a high power to heat ratio and a high efficiency. The latest development in combustion technology, the gasification of solid fuel, has also been linked with combined cycle plants and cogeneration. The gasification technique will reduce the sulphur and nitric oxide emissions to a considerably lower level than conventional combustion techniques by means of the gas treatment operations downstream of gasification and upstream of the gas turbine combined cycle.

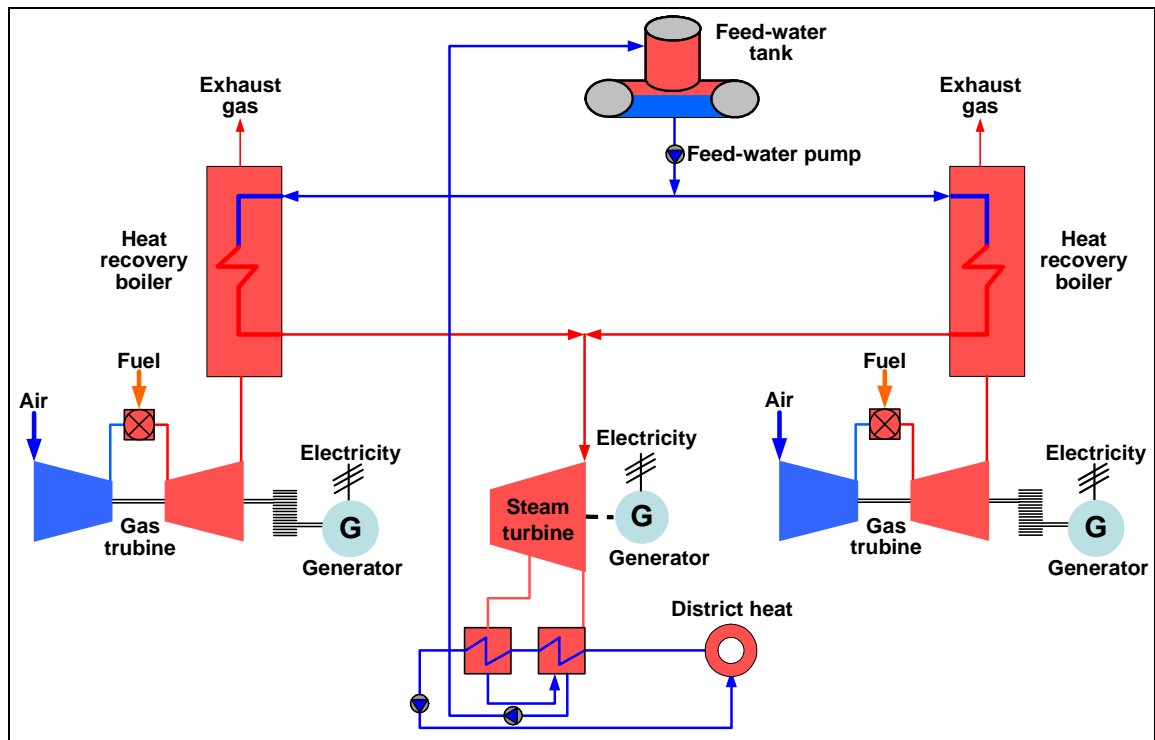

Figure 3.15: Combined cycle power plant
[65, Nuutila, 2005]

Internal combustion engines (reciprocating engines)

In an internal combustion or reciprocating engine, heat can be recovered from lubrication oil and engine cooling water as well as from exhaust gases as shown in Figure 3.16.

Internal combustion engines convert chemically bound energy in fuel to thermal energy by combustion. Thermal expansion of flue-gas takes place in a cylinder, forcing the movement of a piston. The mechanical energy from the piston movement is transferred to the flywheel by the crankshaft and further transformed into electricity by an alternator connected to the flywheel. This direct conversion of the high temperature thermal expansion into mechanical energy and further into electrical energy gives internal combustion engines the highest thermal efficiency (produced electric energy per used fuel unit) among single cycle prime movers, i.e. also the lowest specific CO₂ emissions.

Low speed (<300 rpm) two stroke engines are available up to 80 MW_e unit sizes. Medium speed (300 < n < 1500 rpm) four stroke engines are available up to 20 MW_e unit sizes. Medium speed engines are usually selected for continuous power generation applications. High speed (>1500 rpm) four stroke engines available up to around 3 MW_e are mostly used in peak load applications.

The most used engine types can further be divided into diesel, spark/micro pilot ignited and dual fuel engines. Covering a wide range of fuel alternatives from natural, associated, landfill, mining (coal bed), bio and even pyrolysis gases and liquid biofuels, diesel oil, crude oil, heavy fuel oil, fuel emulsions to refinery residuals.

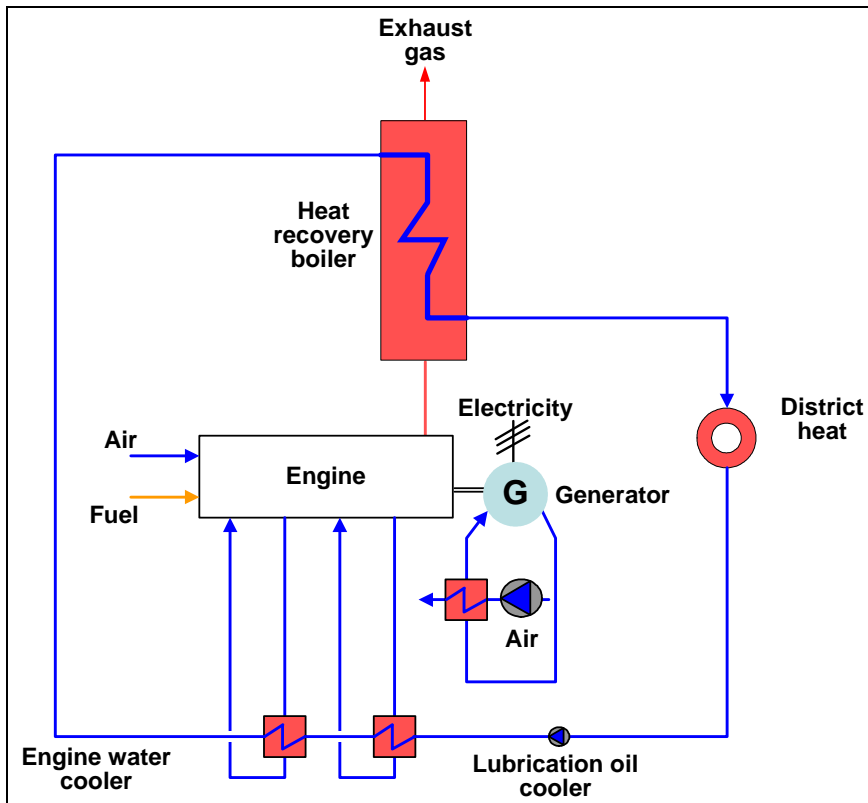

Figure 3.16: Internal combustion or reciprocating engine
[65, Nuutila, 2005]

Stationary engine plants (i.e. not mobile generators) commonly have several engine driven generator sets working in parallel. Multiple engine installations in combination with the ability of engines to maintain high efficiency when operated at part load, gives operation flexibility with optimal matching of different load demands and excellent availability. Cold start up time is short compared to coal-, oil- or gas-fired boiler steam turbine plants or combined cycle gas turbine plant. A running engine has a quick response capability to network and can therefore be utilised to stabilise the grid quickly.

Closed radiator cooling systems are suitable for this technology, keeping the water consumption of stationary engine plants very low.

Their compact design makes engine plants suitable for distributed combined heat and power (CHP) production, close to electricity and heat consumers in urban and industrial areas. Thus, associated energy losses in transformers and transmission lines and heat transfer pipes are reduced. Typical transmission losses associated with central electricity production account, on the average, for 5 to 8 % of the generated electricity, correspondingly the energy losses in municipal district heating networks may be less than 10 %. It should be borne in mind that the highest transmission losses generally occur in low voltage grids and in-house serving connections. On the other hand, electricity production in bigger plants is usually more effective.

The high single cycle efficiency of internal combustion engines together with relatively high exhaust gas and cooling water temperatures makes them ideal for CHP solutions. Typically, about 30 % of the energy released in the combustion of the fuel can be found in the exhaust gas and about 20 % in the cooling water streams. Exhaust gas energy can be recovered by connecting a boiler downstream of the engine, producing steam, hot water or hot oil. Hot exhaust gas can also be used directly or indirectly via heat exchangers, e.g. in drying processes. Cooling water streams can be divided into low and high temperature circuits and the degree of recovery potential is related to the lowest temperature that can be utilised by the heat customer. The whole cooling water energy potential can be recovered in district heating networks with low return temperatures. Engine cooling heat sources in connection with an exhaust gas boiler and an economiser can then result in a fuel (electricity + heat recovery) utilisation of up to 85 % with liquid, and up to 90 % in gas fuel applications.

Heat energy can be delivered to end users as steam (typically up to 20 bar superheated), hot water or hot oil depending on the need of the end user. The heat can also be utilised by an absorption chiller process to produce chilled water.

It is also possible to use absorption heat pumps to transfer energy from the engine low temperature cooling circuit to a higher temperature that can be utilised in district heating networks with high return temperatures. See Section 3.4.3.

Hot and chilled water accumulators can be used to stabilise an imbalance between electricity and heating/cooling demands over shorter periods.

Internal combustion or reciprocating engines typically have fuel efficiencies in the range of 40 – 48 % when producing electricity and fuel efficiencies may come up to 85 – 90 % in combined heat and power cycles when the heat can be effectively used. Flexibility in trigeneration can be improved by using hot water and chilled water storage, and by using the topping-up control capacity offered by compressor chillers or direct-fired auxiliary boilers.

Achieved environmental benefits

There are significant economic and environmental advantages to be gained from CHP production. Combined cycle plants make the maximum use of the fuel's energy by producing both electricity and heat with minimum energy wastage. The plants achieve a fuel efficiency of 80 - 90 %, while, for the conventional steam condensing plants, the efficiencies remain at 35 - 45 % and even for the combined cycle plants below 58 %.

The high efficiency of CHP processes delivers substantial energy and emissions savings. Figure 3.17 shows typical values of a coal-fired CHP plant compared to the process in an individual heat-only boiler and a coal-fired electricity plant, but similar results can also be obtained with other fuels. The numbers in Figure 3.17 are expressed in dimensionless energy units. In this example, separate and CHP units produce the same amount of useful output. However, separate production implies an overall loss of 98 energy units, compared to only 33 in CHP. The fuel efficiency in the separate production is 55 %, while in the case of combined heat and power production, 78 % fuel efficiency is achieved. CHP production thus needs a round 30 % less fuel input to produce the same amount of useful energy. CHP can, therefore, reduce atmospheric emissions by an equivalent amount. However, this will depend on the local energy mix for electricity and/or heat (steam production).

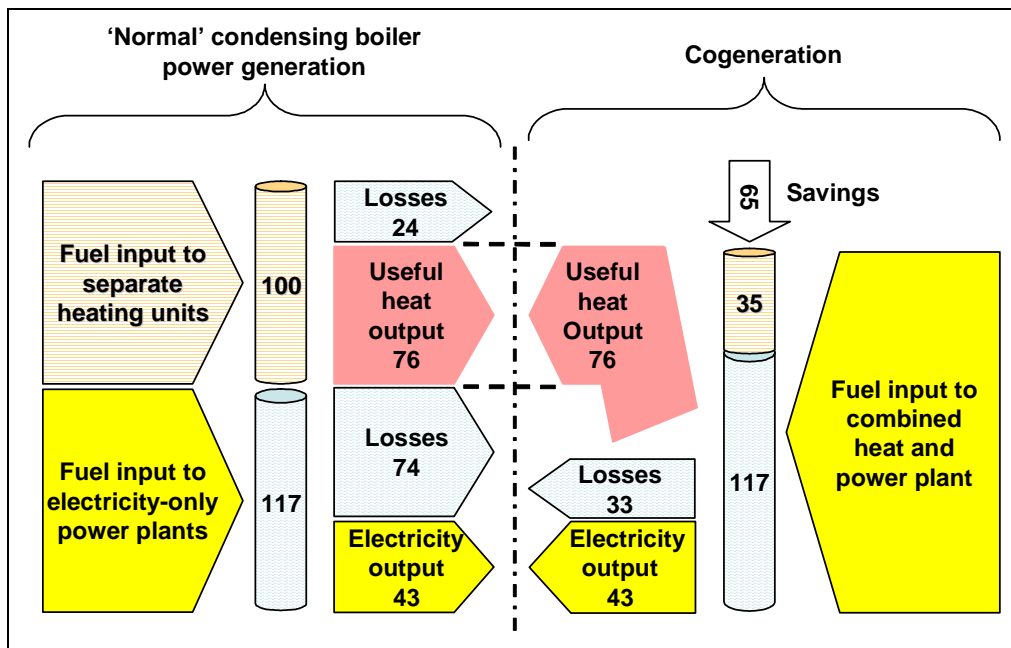

Figure 3.17: Comparison between efficiency of a condensing power and a combined heat and power plant [65, Nuutila, 2005]

As with electricity generation, a wide variety of fuels can be used for cogeneration, e.g. waste, renewable sources such as biomass, and fossil fuels such as coal oil and gas.

Cross-media effects

The electricity production may decrease where a plant is optimised for heat recovery (e.g. in W-t-E plants, see the WI BREF). For example, (using equivalent factors according to WI BREF and WFD) it can be shown that a W-t-E plant with, e.g. 18% electricity production (WFD equivalent 0.468) is congruent with a W-t-E plant with, e.g. 42.5% utilisation of district heat (WFD equivalent 0.468) or a plant with 42.5% (WFD equivalent 0.468) commercial use of steam.

Operational data

See Descriptions of different cogeneration techniques above.

Applicability

The choice of CHP concept is based on a number of factors and even with similar energy requirements, no two sites are the same. The initial selection of a CHP plant is often dictated by the following factors:

- the critical factor is that there is sufficient demand for heat, in terms of quantity, temperature, etc. that can be met using heat from the CHP plant
- the base-load electrical demand of the site, i.e. the level below which the site electrical demand seldom falls
- the demands for heat and power are concurrent
- a convenient fuel price in ratio to the price of electricity
- high annual operation time (preferably more than 4 000 – 5 000 full load hours).

In general, CHP units are applicable to plants having significant heat demands at temperatures within the range of medium or low pressure steam. The evaluation of the cogeneration potential at a site should ensure that no significant heat demand reductions can be expected. Otherwise the cogeneration setup would be designed for a too large heat demand, and the cogeneration unit would operate inefficiently.

In 2007, relatively small scale CHP can be economically feasible (see the Atrium hospital, Annex 7.7 Example 2). The following paragraphs explain which types of CHP are usually suitable in different cases. However, the limiting figures are exemplary only and may depend on local conditions. Usually the electricity can be sold to the national grid as the site demand varies. Utilities modelling, see Section 2.15.2, assists the optimisation of the generation and heat recovery systems, as well as managing the selling and buying of surplus energy.

Choice of CHP type

Steam turbines may be the appropriate choice for sites where:

- the electrical base load is over 3 – 5 MW_e
- there is a low value process steam requirement; and the power to heat demand ratio is greater than 1:4
- cheap, low premium fuel is available
- adequate plot space is available
- high grade process waste heat is available (e.g. from furnaces or incinerators)
- the existing boiler plant is in need of replacement
- the power to heat ratio is to be minimised. In CHP plants, the backpressure level must be minimised and the high pressure level must be maximised in order to maximise the power to heat ratio, especially when renewable fuels are used.

Gas turbines may be suitable if:

- the power to heat ratio is planned to be maximised
- the power demand is continuous, and is over 3 MW_e (smaller gas turbines are at the time of writing just starting to penetrate the market)
- natural gas is available (although this is not a limiting factor)
- there is a high demand for medium/high pressure steam or hot water, particularly at temperatures higher than 500 °C
- demand exists for hot gases at 450 °C or above – the exhaust gas can be diluted with ambient air to cool it, or put through an air heat exchanger. (Also consider using in a combined cycle with a steam turbine).

Internal combustion or reciprocating engines may be suitable for sites where:

- power or processes are cyclical or not continuous
- low pressure steam or medium or low temperature hot water is required
- there is a high power to heat demand ratio
- natural gas is available – gas powered internal combustion engines are preferred
- natural gas is not available – fuel oil or LPG powered diesel engines may be suitable
- the electrical load is less than 1 MW_e – spark ignition (units available from 0.003 to 10 MW_e)
- the electrical load is greater than 1 MW_e – compression ignition (units from 3 to 20 MW_e).

Economics

- the economics depend on the ratio between fuel and electricity price, the price of heat, the load factor and the efficiency
- the economics depend strongly on the long term delivery of heat and electricity
- policy support and market mechanisms have a significant impact, such as the beneficial energy taxation regime, and liberalisation of the energy markets.

Driving force for implementation

Policy support and market mechanisms (see Economics, above).

Examples:

- Äänekoski CHP power plant, Finland
- Rauhalampi CHP power plant, Finland
- used in soda ash plants, see the LVIC-S BREF
- Bindewald Kupfermühle, DE:
 - flour mill: 100000 t wheat and rye/yr
 - malthouse: 35000 t malt/yr
- Dava KVV, Umea CHP W-t-E plant, Sweden
- Sysav, Malmö CHP W-t-E plant, Sweden.

Reference information

[65, Nuutila, 2005], [97, Kreith, 1997] [127, TWG, , 128, EIPPCB, , 140, EC, 2005, 146, EC, 2004]

3.4.2 Trigeneration

Description

Trigeneration is generally understood to mean the simultaneous conversion of a fuel into three useful energy products: electricity, hot water or steam and chilled water. A trigeneration system is actually a cogeneration system (Section 3.4) with an absorption chiller that uses some of the heat to produce chilled water (see Figure 3.18).

Figure 3.18 compares two concepts of chilled water production: compressor chillers using electricity and trigeneration using recovered heat in a lithium bromide absorption chiller. As shown, heat is recovered from both the exhaust gas and the engine high temperature cooling circuit. Flexibility in trigeneration can be improved by using topping-up control capacity offered by compressor chillers or direct-fired auxiliary boilers.

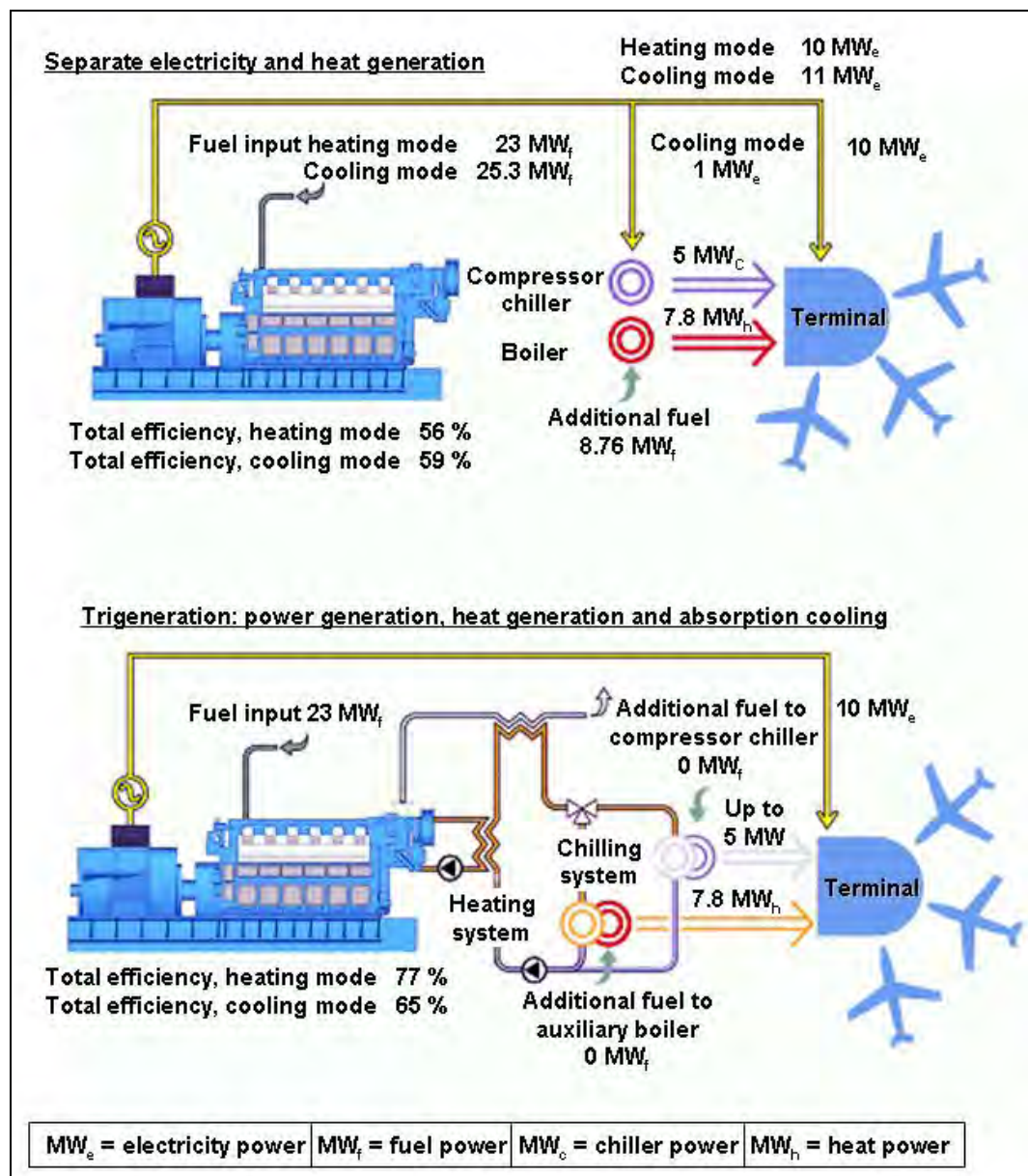

Figure 3.18: Trigeneration compared to separate energy production for a major airport [64, Linde, 2005]

Single-stage lithium bromide absorption chillers are able to use hot water with temperatures as low as 90 °C as the energy source, while two-stage lithium bromide absorption chillers need about 170 °C, which means that they are normally steam-fired. A single-stage lithium bromide absorption chiller producing water at 6 – 8 °C has a coefficient of performance (COP) of about 0.7 and a two-stage chiller has a COP of about 1.2. This means they can produce a chilling capacity corresponding to 0.7 or 1.2 times the heat source capacity.

For an engine-driven CHP plant, single- and two-stage systems can be applied. However, as the engine has residual heat split in exhaust gas and engine cooling, the single stage is more suitable because more heat can be recovered and transferred to the absorption chiller.

Achieved environmental benefits

The main advantage of trigeneration is the achievement of the same output with considerably less fuel input than with separate power and heat generation.

The flexibility of using the recovered heat for heating during one season (winter) and cooling during another season (summer) provides an efficient way of maximising the running hours at high total plant efficiency, benefiting both the owner and the environment – see Figure 3.19.

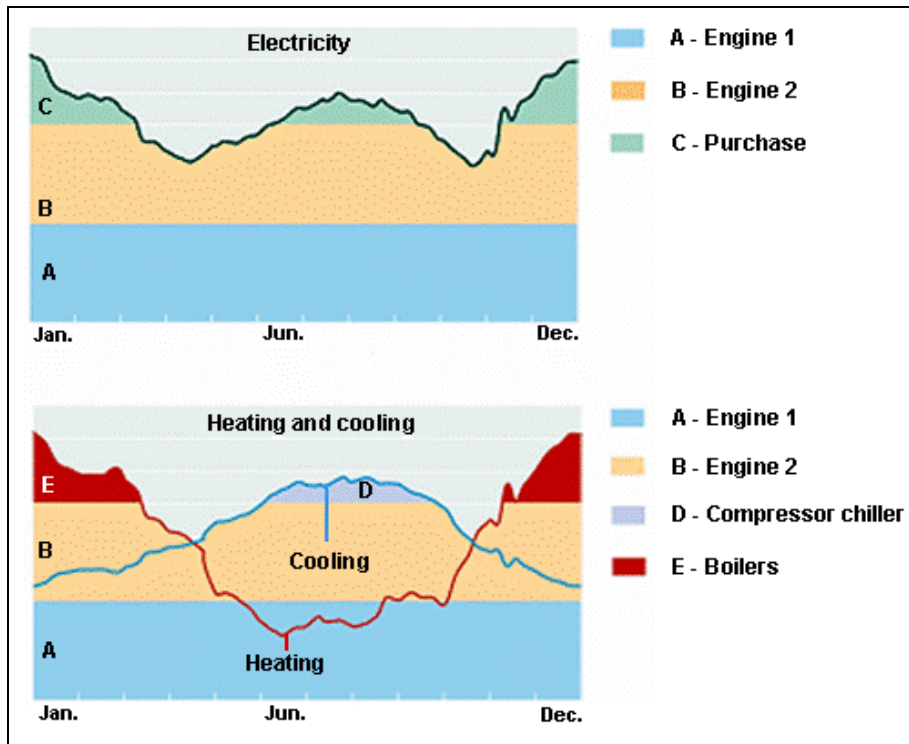

Figure 3.19: Trigeneration enables optimised plant operation throughout the year [64, Linde, 2005]

The running philosophy and control strategy are of importance and should be properly evaluated. The optimal solution is seldom based on a solution where the entire chilled water capacity is produced by absorption chillers. For air conditioning, for instance, most of the annual cooling needs can be met with 70 % of the peak cooling capacity, while the remaining 30 % can be topped up with compressor chillers.

In this way, the total investment cost for the chillers can be minimised.

Cross-media effects

None.

Operational data

No data submitted.

Applicability

Trigeneration and distributed power generation

Since it is more difficult and costly to distribute hot or chilled water than electricity, trigeneration automatically leads to distributed power production since the trigeneration plant needs to be located close to the hot or chilled water consumers.

In order to maximise the fuel efficiency of the plant, the concept is based on the joint need for hot and chilled water. A power plant located close to the hot and chilled water consumer also has lower electricity distribution losses. Trigeneration is cogeneration taken one step further by including a chiller. Clearly there is no advantage to making that extra investment if all the recovered heat can be used effectively during all the plant’s running hours.

However, the extra investment starts to pay off if there are periods when not all the heat can be used, or when no heat demand exists but there is a use for chilled water or air. For example, trigeneration is often used for air conditioning in buildings, for heating during winter and cooling during summer, or for heating in one area and cooling in another area.

Many industrial facilities and public buildings also have such a suitable mix of heating and cooling needs, four examples being breweries, shopping malls, airports and hospitals.

Economics

No data submitted.

Driving force for implementation

Cost savings.

Examples

- Madrid Barajas Airport, ES (see Annex 7.10.4)
- Atrium Hospital, NL (see Annex 7.7).

Reference information

[64, Linde, 2005, 93, Tolonen, 2005]

3.4.3 District cooling

Description

District cooling is another aspect of cogeneration: where cogeneration provides centralised production of heat, which drives on absorption chillers, and the electricity is sold to the grid. Cogeneration can also deliver district cooling (DC) by means of centralised production and distribution of cooling energy. Cooling energy is delivered to customers via chilled water transferred in a separate distribution network.

District cooling can be produced in different ways depending on the season and the outside temperature. In the winter, at least in Nordic countries, cooling can be carried out by cold water from the sea (see Figure 3.20). In the summer, district cooling can be produced by absorption technology (see Figure 3.21 and Section 3.3.2). District cooling is used for air conditioning, for cooling of office and commercial buildings, and for residential buildings.

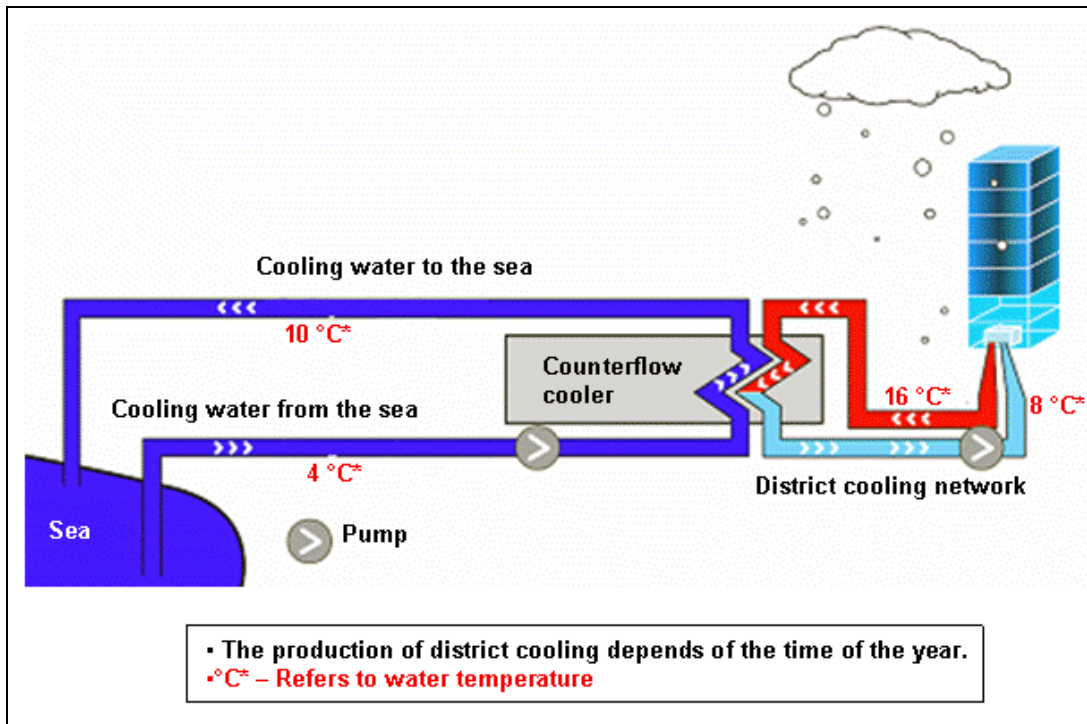

Figure 3.20: District cooling in the winter by free cooling technology [93, Tolonen, 2005]

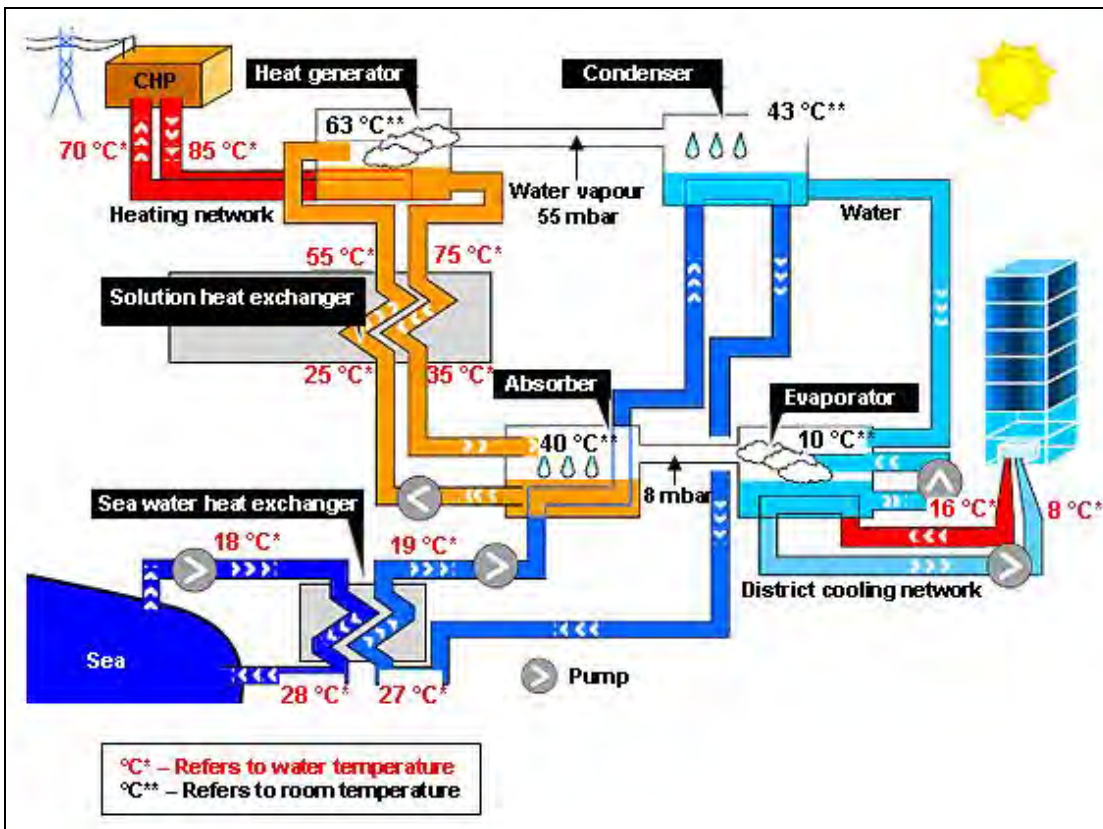

Figure 3.21: District cooling by absorption technology in the summer [93, Tolonen, 2005]

Achieved environmental benefits

Improving the eco-efficiency of district heating (DH) and district cooling (DC) in Helsinki, Finland, has achieved many sustainability goals as shown below:

- greenhouse gas and other emissions, such as nitrogen oxides, sulphur dioxide and particles, have been greatly reduced
- the drop in electricity consumption will also cut down the electricity consumption peaks that building-specific cooling units cause on warm days
- from October until May, all DC energy is renewable, obtained from cold seawater. This represents 30 % of yearly DC consumption
- in the warmer season, absorption chillers use the excess heat of CHP plants which otherwise would be led to the sea. Although the fuel consumption in the CHP plant may increase, the total fuel consumption compared to the situation with separate cooling systems in buildings will decrease
- in DC, harmful noise and the vibration of cooling equipment has been removed
- the space reserved for cooling equipment in buildings is freed for other purposes
- the problem of microbial growth in the water of condensing towers is also avoided
- contrary to the cooling agents used in building-specific compressor cooling, no harmful substances (e.g. CFC and HCFC compounds) evaporate in the processes of DC
- DC improves the aesthetics of cityscape: the production units and pipelines are not visible. The big condensers on the roofs of buildings and multiple coolers in windows will no longer be needed
- the life cycle of the DH and DC systems is much longer than that of building-specific units, e.g. the service life of a cooling plant is double compared to separate units. The technical service life of the main pipelines of DH and DC systems extends over a century.

Cross-media effects

Impacts of installing a distribution system.

Operational data

Reliable.

Applicability

This technique could have wide application. However, this depends on local circumstances.

Economics

Large investments are required for the distribution systems.

Driving force for implementation

No data submitted.

Examples

- Helsinki Energy, Finland
- In Amsterdam, the Netherlands, deep lakes close to facilities provide district cooling.

Reference information

[93, Tolonen, 2005], [120, Helsinki Energy, 2004]

3.5 Electrical power supply

Introduction

Public electrical power is supplied via high voltage grids where the voltage and current vary in sine wave cycles at 50 Hz (in Europe) in three phases at 120 ° intervals. The voltage is high to minimise current losses in transmission. Depending on the equipment used, the voltage is stepped down on entering the site, or close to specific equipment, usually to 440 V for industrial use, and 240 V for offices, etc.

Various factors affect the delivery and the use of energy, including the resistance in the delivery systems, and the effects some equipment and uses have on the supply. Stable voltages and undistorted waveforms are highly desirable in power systems.

The consumption of electrical energy in the EU-25 in 2002, comprised 2 641 TWh plus 195 TWh network losses. The largest consumer sector was industry with 1168 TWh (44 %), followed by households with 717 TWh (27 %), and services with 620 TWh (23 %). These three sectors together accounted for around 94 % of consumption.

3.5.1 Power factor correction

Description

Many electrical devices have inductive loads, such as:

- AC single-phase and 3-phase motors (see Section 3.6)
- variable speed drives (see Section 3.6.3)
- transformers (see Section 3.5.4)
- high intensity discharge lighting (see Section 3.10).

These all require both active electrical power and reactive electrical power. The active electrical power is converted into useful mechanical power, while the reactive electrical power is used to maintain the device's magnetic fields. This reactive electrical power is transferred periodically in both directions between the generator and the load (at the same frequency as the supply). Capacitor banks and buried cables also take reactive energy.

Vector addition of the real (active) electrical power and the reactive electrical power gives the apparent power. Power generation utilities and network operators must make this apparent power available and transmit it. This means that generators, transformers, power lines, switchgear, etc. must be sized for greater power ratings than if the load only drew active electrical power.

Power supply utilities (both on-site and off-site) are faced with extra expenditure for equipment and additional power losses. External suppliers, therefore, make additional charges for reactive power if this exceeds a certain threshold. Usually, a certain target power factor of $\cos \phi$ of between 1.0 and 0.9 (lagging) is specified, at which point the reactive energy requirement is significantly reduced. A simple explanation is given in Annex 7.17.

$$\text{(Electrical) power factor} = \frac{\text{Real power}}{\text{Apparent power}}$$

For example, using the power triangle illustrated in Figure 3.22 below, if:

- real power = 100 kW and apparent power = 142 kVA_r
- then the power factor = 100/142 = 0.70.

This indicates that only 70 % of the current provided by the electrical utility is being used to produce useful work (for a further explanation, see Annex 7.17).

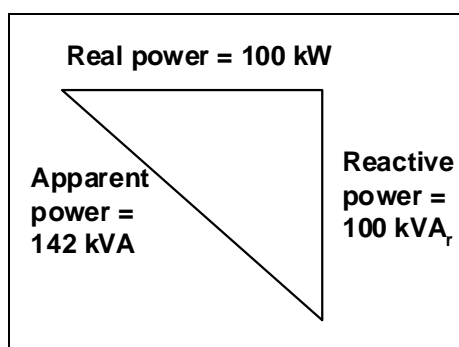

Figure 3.22: Reactive and apparent power

If the power factor is corrected, for example by installing a capacitor at the load, this totally or partially eliminates the reactive power drawn at the power supply company. Power factor correction is at its most effective when it is physically near to the load and uses state-of-the-art technology.

The power factor can change over time so needs to be checked periodically (depending on site and usage, and these checks can be anything from 3 to 10 years apart), as the type of equipment and the supplies listed (above) change over time. Also, as capacitors used to correct the power factor deteriorate with time, these also require periodic testing (most easily carried out by checking if the capacitors are getting warm in operation).

Other measures to take are:

- to minimise operation of idling or lightly loaded motors (see Section 3.6)
- to avoid operation of equipment above its rated voltage
- to replace standard motors as they burn out with energy efficient motors (see Section 3.6)
- even with energy efficient motors, however, the power factor is significantly affected by variations in load. A motor must be operated near its rated capacity to realise the benefits of a high power factor design (see Section 3.6).

Achieved environmental benefits

Energy savings to both the supply side and the consumer.

Table 3.21 below shows the effects of a power factor of 0.95 (lagging) being achieved in EU industry as a whole.

EU-25 industry power factor	Active energy TWh	Cos φ	Reactive energy TVA _r h	Apparent energy TVA _h
Estimated power factor	1168	0.70	1192	1669
Targeted power factor	1168	0.95	384	1229

Table 3.21: Estimated industry electricity consumption in the EU-25 in 2002
[131, ZVEI, , 140, EC, 2005]

Across the EU as a whole, it has been estimated that if a power correction factor for industry was applied, then 31 TWh power could be saved, although part of this potential has been exploited. This is calculated on the basis that the EU-25's total electricity consumption for industry and service sectors in 2002 was 1788 TWh, from which industry used 65 %²⁷.

²⁷ 31 TWh corresponds to over 8 million households, about 2600 wind power generators, about 10 gas-fired power stations, and 2 – 3 nuclear power stations. It also corresponds to more than 12 Mt of CO₂.

In a n installation, it is estimated that if a n operator with a power correction factor of 0.73 corrected the factor to 0.95, they would save 0.6 % of their power usage (0.73 is the estimated figure for industry and services).

Cross-media effects

None reported.

Operational data

An uncorrected power supply will cause power losses in an installation's distribution system. Voltage drops may occur as power losses increase. Excessive drops can cause overheating and premature failure of motors and other inductive equipment.

Applicability

All sites.

Economics

External suppliers may make additional charges for excessive reactive electrical power if the correction factor in the installation is less than 0.95 (see Annex 7.11).

The cost of power correction is low. Some new equipment (e.g. high efficiency motors) addresses power correction.

Driving force for implementation

- power savings both inside the installation and in the external supply grid (where used)
- increase in internal electrical supply system capacity
- improved equipment reliability and reduced downtimes.

Examples

Widely applied.

Reference information

Further information can be found in Annex 7.17)
[130, US_DOE_PowerFactor, , 131, ZVEI]

3.5.2 Harmonics

Description

Certain electrical equipment with non-linear loads causes harmonics in the supply (the addition of the distortions in the sine wave). Examples of non-linear loads are rectifiers, some forms of electric lighting, electric arc furnaces, welding equipment, switched mode power supplies, computers, etc.

Filters can be applied to reduce or eliminate harmonics. The EU has set limits on harmonics as a method of improving the power factor, and there are standards such as EN 61000-3-2 and EN 61000-3-12, requiring switched power supplies to have harmonics filters.

Achieved environmental benefits

Power savings.

Cross-media effects

None reported.

Operational data

Harmonics can cause:

- nuisance tripping of circuit breakers
- malfunctioning of UPS systems and generator systems
- metering problems
- computer malfunctions
- overvoltage problems.

Harmonics cannot be detected by standard ammeters, only by using 'true RMS' meters.

Applicability

All sites should check for equipment causing harmonics.

Economics

Losses due to equipment malfunction.

Driving force for implementation

- improved reliability of equipment
- reduced losses in downtimes
- with harmonics, reduced current in earths
- the safety issues of design grounding being exceeded if harmonics are present.

Examples

Widely used.

Reference information

[132, Wikipedia_Harmonics, , 135, EUROELECTRICS, , 136, CDA]

3.5.3 Optimising supply**Description**

Resistive losses occur in cabling. Equipment with a large power usage should, therefore, be supplied from a high voltage supply as close as possible, e.g. the corresponding transformer should be as close as possible.

Cables to equipment should be oversized to prevent unnecessary resistance and losses as heat. The power supply can be optimised by using high efficiency equipment such as transformers.

Other high efficiency equipment such as motors, is covered in Section 3.6, compressors in Section 3.7, and pumps in Section 3.8.

Achieved environmental benefits

No data submitted.

Cross-media effects

No data submitted.

Operational data

- all large equipment using power should be planned to be adjacent to supply transformers
- cabling should be checked on all sites and oversized where necessary.

Applicability

- improved reliability of equipment
- reduced losses in downtimes
- consider the costs on an operating lifetime basis.

Economics

Savings in equipment downtime and power consumption.

Driving force for implementation

Cost.

Examples

Widely used.

Reference information

[135, EUROELECTRICS, , 230, Association, 2007]

3.5.4 Energy efficient management of transformers

Description

Transformers are devices able to transform the voltage of an electrical supply from one level to another. This is necessary because voltage is normally distributed at a level higher than that used by machinery in industry: higher voltages used in the distribution system reduces energy losses in the distribution lines.

Transformers are static machines made up of a core comprising a number of ferromagnetic plates, with the primary and secondary coils wound around the opposite sides of the core. The transformation rate of the voltages is given by the ratio V_2/V_1 (see Figure 3.23).

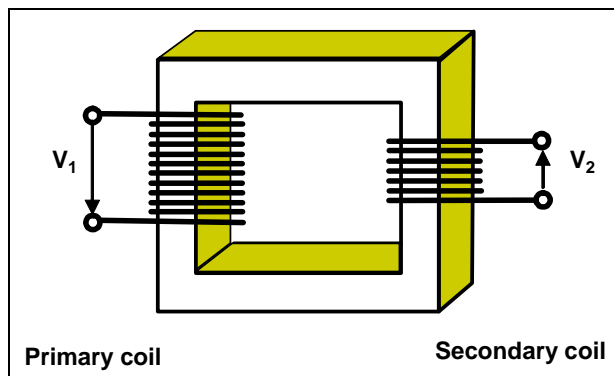

Figure 3.23: Diagram of a transformer

[245, Di Franco, 2008]

If P_1 is the electrical power entering the transformer, P_2 the power exiting and P_L the losses, then the power balance is:

$$P_1 = P_2 + P_L \quad \text{Equation 3.9}$$

and the transformer efficiency can be written as:

$$\eta = \frac{P_2}{P_1} = \frac{P_1 - P_L}{P_1} \quad \text{Equation 3.10}$$

The losses are of two main types: losses in the iron components and losses in copper components. Losses in iron are caused by hysteresis and eddy currents inside ferromagnetic core plates; such losses are proportional to V^2 and are from about 0.2 to 0.5 % of nominal power P_n ($= P_2$). Losses in copper are caused by the Joule effect in copper coil; such losses are proportional to I^2 , and are estimated roughly from 1 to 3 % of nominal power P_n (at 100 % of the load).

Since a transformer works on average with a load factor x lower than 100 %, ($P_{\text{effective}} = x P_n$), it can be demonstrated that the relationship between the transforming efficiency and the load factor follows the curve in Figure 3.24 (for a 250 kVA transformer). In this case, the transformer has a maximum point at a value of about 40 % of the load factor.

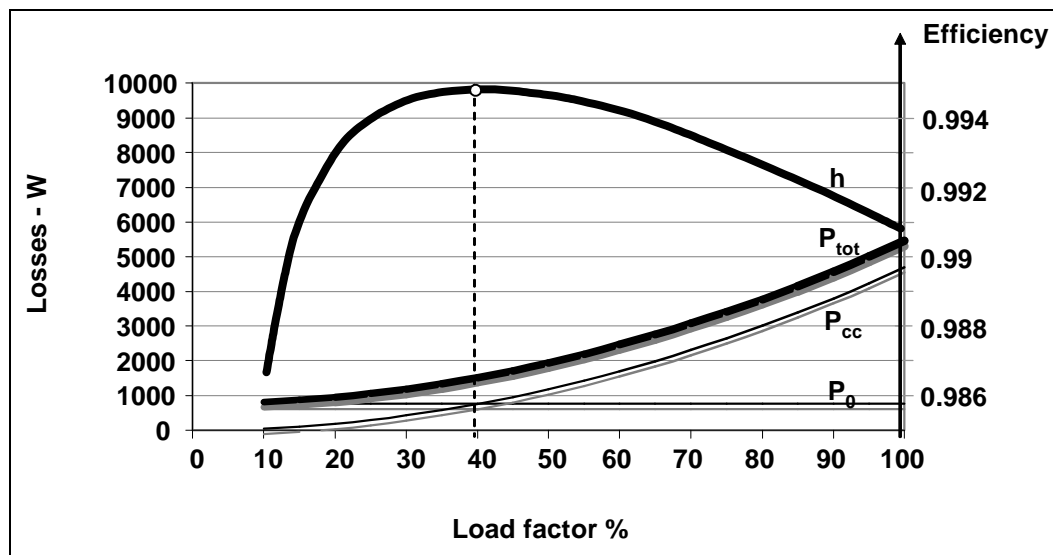

Figure 3.24: Relationship between losses in iron, in copper, in efficiency, and in load factor [245, Di Franco, 2008]

Whatever the power of the transformer is, the relationship between efficiency and load factor always shows a maximum, set normally on average at around 45 % of the nominal load.

Due to this distinctive behaviour, it is possible to evaluate the following options in an electrical power (transformer) substation:

- if the global electric load is lower than 40 - 50 % P_n , it is energy saving to disconnect one or more transformers to load the others closer to the optimal factor
- in the opposite situation (global electric load higher than 75 % P_n), only the installation of additional capacity can be considered
- when repowering or updating the transformer substation, installing *low loss transformers*, that show a reduction of losses from 20 to 60 % is preferred

Achieved environmental benefits

Less consumption of secondary energy resources.

Cross-media effects

None known.

Operational data

Normally in transformer substations there is a surplus of electrical power supply installed, and therefore the average load factor is generally low. Historically, utilities managers maintain this surplus to ensure a continuing power supply in the case of failure of one or more of the transformers.

Applicability

The optimisation criteria are applicable to all transformer rooms. Optimising the loading is estimated to be applicable in 25 % of cases.

The number of new transformer power installed/repowered every year in industry is estimated to be 5 % and low loss transformers can be considered in these new/repowered cases.

Economics

In the case of the installation of low loss transformers with respect to 'normal series' transformers, or in substitution of low efficiency transformers operating at present, payback times are normally short, considering that transformers operate for a high number of hours/year.

Driving force for implementation

Energy and money savings are the driving force for implementation.

Examples

For the refurbishment of a transformer room, foreseeing the installation of four new transformers whose electric power is 200, 315, 500 and 1250 kVA, a payback time of 1.1 years has been estimated.

Reference information

[228, Petrecca, 1992, 229, Di Franco]

3.6 Electric motor driven sub-systems²⁸

Introduction

The energy efficiency in motor driven systems can be assessed by studying the demands of the (production) process and how the driven machines should be operated. This is a systems approach and yields the highest energy efficiency gains (see Sections 1.3.5 and 1.5.1) and is discussed in the relevant sections in this chapter. Savings achieved by a systems approach as a minimum will be those achieved by considering individual components, and can be 30 % or higher (see Section 1.5.1, and, e.g. compressed air systems in Section 3.7).

An electric motor driven sub-system converts electric power into mechanical power. In most industrial applications, the mechanical work is transferred to the driven machine as rotational mechanical power (via a rotating shaft). Electric motors are the prime movers behind most industrial machinery: pumps, fans, compressors, mixers, conveyors, debarking drums, grinders, saws, extruders, centrifuges, presses, rolling mills, etc.

Electrical motors are one of the main energy consumption sources in Europe. Estimates are that motors account for:

- about 68 % of the electricity consumed in industry which amounted to 707 TWh in 1997
- 1/3 of the tertiary electrical consumption.

²⁸ In this document, 'system' is used to refer to a set of connected items or devices which operate together for a specific purpose, e.g. HVAC, CAS. See the discussion on system boundaries. These systems usually include motor sub-systems (or component systems).

Electric motor driven sub-system

This is a sub-system or a train of components consisting of:

- an installation power supply
- a control device, e.g. AC drive (see *electric motor* below)
- an electric motor, usually an induction motor
- a mechanical transmission coupling
- a driven machine, e.g. centrifugal pump.

Figure 3.25 shows schemes of a conventional and an energy efficient pumping system.

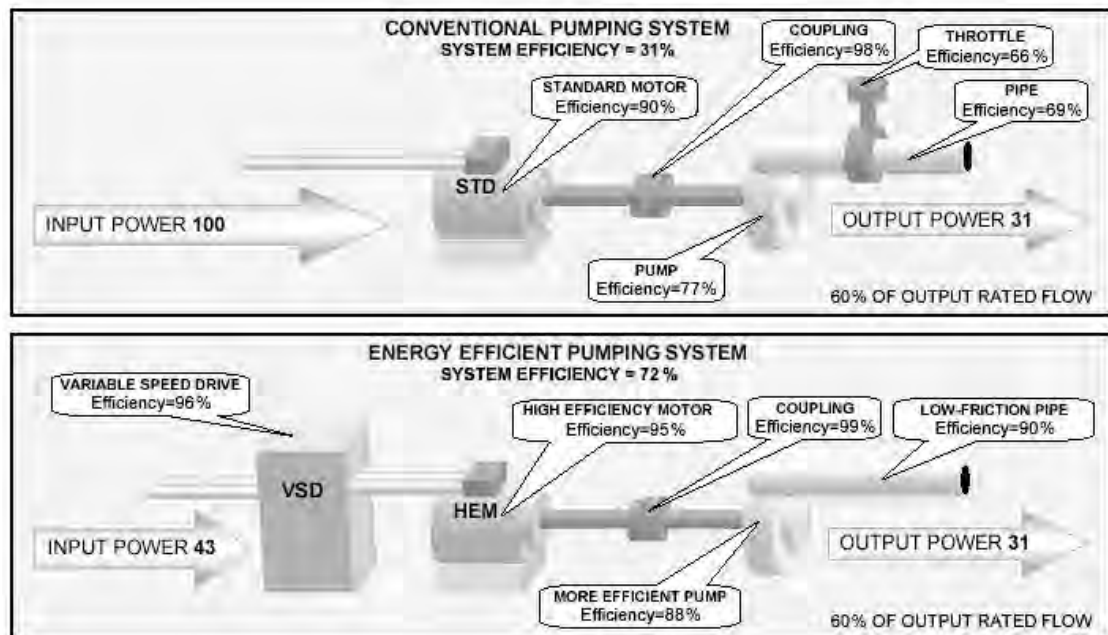

Figure 3.25: Conventional and energy efficient pumping system schemes
[246, ISPRA, 2008]

Driven machine

Also referred to as a load machine, this is the machine that carries out a value-added task related to the ultimate purpose of the industrial plant. The tasks performed can be divided into two main categories as the driven machine can either:

- alter properties in some ways: altering pressure (compressing, pumping), altering physical shape (crushing, wire drawing, rolling metals, etc.). It is the pressure-changing function that is used in larger systems that are described in more detail in this document:
 - pumps (20 %), see Section 3.8
 - fans (18 %), see Section 3.9
 - air compressors (17 %), see Section 3.7
 - cooling compressors (11 %), see Section 3.4.2.
- move or transport material/objects (conveyors, cranes, hoists, winches, etc.):
 - conveyors (4 %) and other uses (30 %).

(where % refers to motor energy used in the EU-15 by system type)

The electricity consumption of motor systems is influenced by many factors such as:

- motor efficiency
- proper sizing
- motor controls: stop/start and speed control
- power supply quality
- mechanical transmission system
- maintenance practices
- the efficiency of end-use device.

In order to benefit from the available savings potential, the users should aim to optimise the whole system that the motor sub-system is part of, before considering the motor section (see Sections 1.4.2 and 1.5.1, and the individual systems sections in this chapter).

Mechanical transmission

Mechanical transmission connects the driven machine and the motor together mechanically. This may be a simple, rigid coupling that connects the shaft ends of the machine and a motor, a gearbox, a chain or belt drive, or a hydraulic coupling. All these types incur additional power losses in the drive system.

Electric motor

Electric motors can be divided into two main groups, DC motors (direct current) and AC motors (alternating current). Both types exist in industry, but the technology trend during the last few decades has strongly been towards AC motors.

The strengths of AC motors are:

- robustness, simple design, low maintenance requirement
- a high efficiency level (especially high power motors)
- relatively cheap in price.

AC induction motors are widely used because of these strengths. However, they operate only at one rotating speed. If the load is not stable, there is a need to change the speed and it can be done most energy efficiently by installing a drive before the motor.

Singly-fed electric motors are the most common type of industrial electric motors. They incorporate a single multiphase winding set that actively participates in the energy conversion process (i.e. singly-fed). Singly-fed electric machines operate under either:

- induction (asynchronous) motors which exhibit a start-up torque (although inefficiently) and can operate as standalone machines. The induction motor technology is well suited to motors of up to several megawatts in power
- synchronous motors which are fundamentally single speed machines. These do not produce useful start-up torques and must have an auxiliary means for start-up and practical operation, such as an electronic controller. Synchronous motors are often built for high power applications, such as compressors in the petrochemical industry.

A DC technology is the 'permanent magnet' (PM), or brushless, synchronous motor, which is suitable for applications that require lower rotating speeds than what is typically achieved using an induction motor. In these slower-speed applications (220 – 600 rpm), such as so-called sectional drives of paper or board machines, a mechanical transmission (gearbox) can often be eliminated using PM motors, which improves the total efficiency of the system.



Figure 3.26: A compressor motor with a rated output of 24 MW
[95, Savolainen, 2005]

The strengths of DC motors have traditionally been ease of electrical control of speed. Also the starting torque is high, which is beneficial in some applications. However, the fast development of power electronic components and control algorithms has improved the position of AC technology so that there is no real performance superiority of DC technology over AC anymore. Modern AC motors and drives outperform their DC counterparts in many respects. In other words; even the most demanding applications, such as controlling the speed and torque of paper machine winders, can be realised with AC motors and drives nowadays.

Control device

In its simplest form, this is a switch or a contactor to connect and disconnect the motor from the mains. This can be operated manually or remotely using a control voltage. Motor protection functions may have been incorporated into these devices, and a motor starter is a switch with safety functions built-in.

A more advanced method to connect a motor to the mains is a ‘soft starter’ (aka: star-delta starter). This device enables moderated start-up of an AC motor, reducing the so-called ‘inrush current’ during starting, thus protecting mechanics and fuses. Without a soft start feature, an AC motor starts up and accelerates vigorously to its rated speed. However, a soft starter is NOT an energy saving device, even though there are some misconceptions and sources claiming this.

The only way the devices above can contribute to energy efficiency is that motors can be switched off when not needed.

‘Real’ motor control devices are able to regulate the output (speed and torque) of electric motors. The operation principle of an AC drive is to convert the frequency of the grid electricity (50 Hz in Europe) to another frequency for the motor in order to be able to change its rotating speed. The control device for AC motors is called the following:

- a 'frequency converter'
- a 'variable speed drive' (VSD)
- an 'adjustable frequency drive' (AFD)
- a combination of them (ASD, VFD) are frequently used to describe the same devices
- 'motor inverter' or just 'inverter' is used by the actual users within industry.

Motor driven systems consume about 65 % of industrial energy in the European Union. The energy savings potential in the EU-15 industries using AC drives is 43 TWh/yr and for improving the efficiency of electric motors themselves, 15 TWh/yr according to EU-15 SAVE studies.

There are at least two different ways to approach the concept of energy efficiency in motor driven systems. One is to look at individual components and their efficiencies, and ensure that only high efficiency equipment is employed. The other is to take a systems approach, as described in the introduction to this section, where overall systems savings may be significantly higher.

3.6.1 Energy efficient motors (EEMs)

Description and operational data

(The information on Achieved environmental benefits, Cross-media effects, Applicability, Economics, Driving forces for implementation, Examples, and Reference information for ENE techniques for electric motors is given in Section 3.6.7).

Energy efficient motors (EEMs) and high efficiency motors (HEMs) offer greater energy efficiency. The additional initial purchase cost may be 20 - 30 % or higher for motors of greater than 20 kW, and may be 50 - 100 % higher for motors under 15 kW, depending on the energy savings category (and therefore the amount of additional steel and copper use) etc. However, energy savings of 2 - 8 % can be achieved for motors of 1 - 15 kW.

As the reduced losses result in a lower temperature rise in the motor, the lifetime of the motor winding insulation, and of the bearings, increases. Therefore, in many cases:

- reliability increases
- downtime and maintenance costs are reduced
- tolerance to thermal stresses increases
- ability to handle overload conditions improves
- resistance to abnormal operating conditions – under and overvoltage, phase unbalance, poorer voltage and current wave shapes (e.g. harmonics), etc. – improves
- power factor improves
- noise is reduced.

A European-wide agreement between the European Committee of Manufacturers of Electrical Machines and Power Electronics (CEMEP) and the European Commission ensures that the efficiency levels of most electric motors manufactured in Europe are clearly displayed. The European motor classification scheme is applicable to motors < 100 kW and basically establishes three efficiency classes, giving motor manufacturers an incentive to introduce higher efficiency models:

- EFF1 (high efficiency motors)
- EFF2 (standard efficiency motors)
- EFF3 (poor efficiency motors).

These efficiency levels apply to 2 and 4 pole three phase AC squirrel cage induction motors, rated for 400 V, 50 Hz, with S1 duty class, with an output of 1.1 to 90 kW, which account for the largest sales volume on the market. Figure 3.27 shows the energy efficiency of the three types of motors as a function of their output.

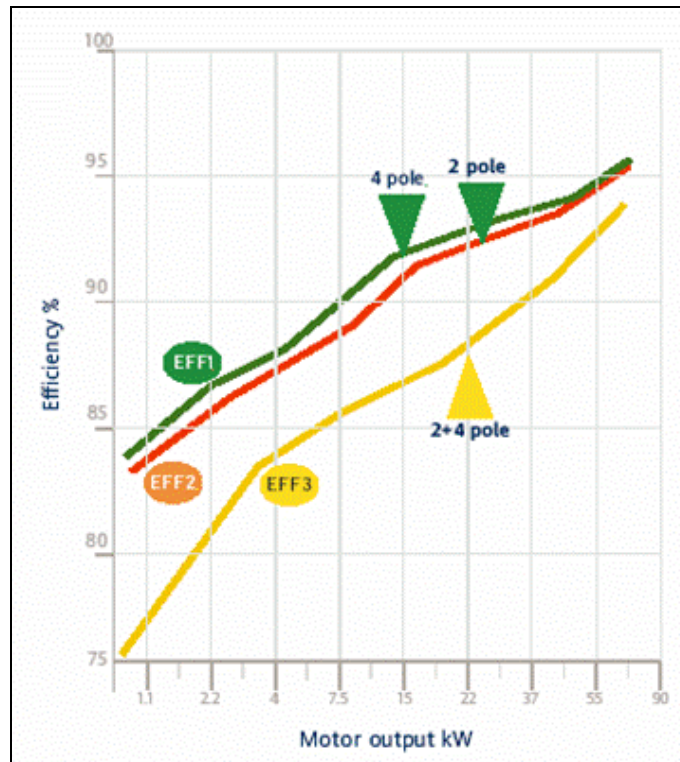

Figure 3.27: Energy efficiency of three phase AC induction motors

The Eco Design (EuP) Directive is likely to eliminate motors in class EFF 3 and EFF 2 by 2011. The International Electrotechnical Commission (IEC) is, at the time of writing, working on the introduction of a new international classification scheme, where the EFF2 and EFF# motors are together at the bottom, and above EFF1 there will be a new premium class.

An appropriate motor choice can be greatly aided through the use of adequate computer software, such as Motor Master Plus²⁹ and EuroDEEM³⁰ proposed by the EU-SAVE PROMOT project.

Appropriate motor solutions may be selected by using the EuroDEEM database³¹, which collates the efficiency of more than 3500 types of motors from 24 manufacturers.

3.6.2 Proper motor sizing

Description and Operational data

(The information on Achieved environmental benefits, Cross-media effects, Applicability, Economics, Driving forces for implementation, Examples, and Reference information for ENE techniques for electric motors is given in Section 3.6.7).

²⁹ Sponsored by US Department of Energy

³⁰ Promoted by the European Commission – DG TREN

³¹ Published by the European Commission

Electrical motors are very often oversized for the real load they have to run. Motors rarely operate at their full-load point. In the European Union, field tests indicate that, on average, motors operate at around 60 % of their rated load.

The maximum efficiency is obtained for the motors of between 60 to 100 % full load. The induction motor efficiency typically peaks near 75 % full load and is relatively flat down to the 50 % load point. Under 40 % full load, an electrical motor does not work at optimised conditions and the efficiency falls very quickly. Motors in the larger size ranges can operate with reasonably high efficiencies at loads down to 30 % of rated load.

Proper sizing:

- improves energy efficiency, by allowing motors to operate at peak efficiency
- may reduce line losses due to low power factors
- may slightly reduce the operating speed, and thus power consumption, of fans and pumps.

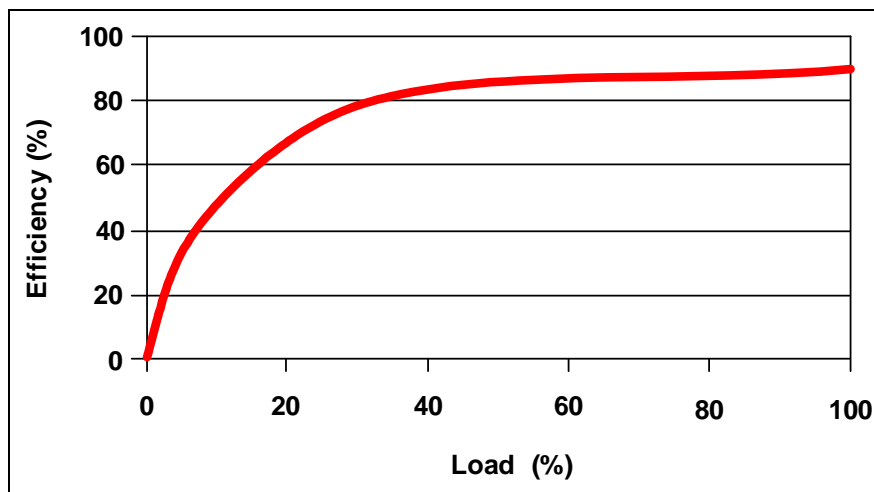

Figure 3.28: Efficiency vs. load for an electric motor

3.6.3 Variable speed drives

Description and Operational data

(The information on Achieved environmental benefits, Cross-media effects, Applicability, Economics, Driving forces for implementation, Examples, and Reference information for ENE techniques for electric motors is given in Section 3.6.7).

The adjustment of the motor speed through the use of variable speed drives (VSDs) can lead to significant energy savings associated to better process control, less wear in the mechanical equipment and less acoustical noise. When loads vary, VSDs can reduce electrical energy consumption particularly in centrifugal pumps, compressors and fan applications – typically in the range of -4 – 50 %. Materials processing applications like centrifugal machines, mills and machine tools, as well as materials handling applications such as winders, conveyors and elevators, can also benefit both in terms of energy consumption and overall performance through the use of VSDs.

The use of VSDs can also lead to other benefits including:

- extending the useful operating range of the driven equipment
- isolating motors from the line, which can reduce motor stress and inefficiency
- accurately synchronising multiple motors
- improving the speed and reliability of response to changing operating conditions.

VSDs are not applicable for all applications, in particular where the load is constant (e.g. fluid bed air input fans, oxidation air compressors, etc.), as the VSD will lose 3 - 4 % of the energy input (rectifying and adjusting the current phase).

3.6.4 Transmission losses

Description and Operational data

(The information on Achieved environmental benefits, Cross-media effects, Applicability, Economics, Driving forces for implementation, Examples, and Reference information for ENE techniques for electric motors is given in Section 3.6.7).

Transmission equipment including shafts, belts, chains, and gears should be properly installed and maintained. The transmission system from the motor to the load is a source of losses. These losses can vary significantly, from 0 to 45 %. When possible, use synchronous belts in place of V-belts. Cogged V-belts are more efficient than conventional V-belts. Helical gears are much more efficient than worm gears. Direct coupling has to be the best possible option (where technically feasible), and V-belts avoided.

3.6.5 Motor repair

Description and Operational data

(The information on Achieved environmental benefits, Cross-media effects, Applicability, Economics, Driving forces for implementation, Examples, and Reference information for ENE techniques for electric motors is given in Section 3.6.7).

Motors above 5 kW can fail and are often repaired several times during their lifetime. Laboratory testing studies confirm that poor motor repair practices reduce motor efficiency of typically between 0.5 and 1 %, and sometimes up to 4 % or even more for old motors.

To choose between repair and replacement, electricity cost/kWh, motor power, average load factors and the number of operating hours per year will all have to be taken into account. Proper attention must be given to the repair process and to the repair company, which should be recognised by the original manufacturer (an energy efficient motor repairer, EEMR).

Typically, replacement of a failed motor through the purchase of a new EEM can be a good option in motors with a large number of operating hours. For example, in a facility with 4000 hours per year of operation, an electricity cost of EUR 0.06/kWh, for motors of between 20 and 130 kW, replacement with an EEM will have a payback time of less than 3 years.

3.6.6 Rewinding

Description and Operational data

(The information on Achieved environmental benefits, Cross-media effects, Applicability, Economics, Driving forces for implementation, Examples, and Reference information for ENE techniques for electric motors is given in Section 3.6.7).

Rewinding a motor is widely carried out in industry. It is cheaper and may be quicker than buying a new motor. However, rewinding a motor can permanently reduce its efficiency by more than 1 %. Proper attention must be given to the repair process and to the repair company, which should be recognised by the original manufacturer (an energy efficient motor repairer, EEMR). The extra cost of a new motor can be quickly compensated by its better energy efficiency, so rewinding may not be economic when considering the life-time cost.

The costs of a new motor compared with rewinding as a function of the power are shown in Figure 3.29.

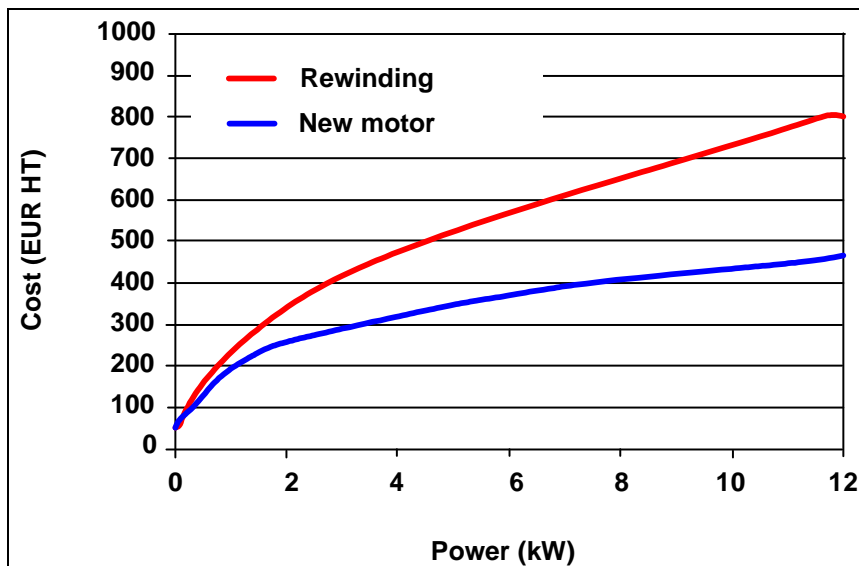

Figure 3.29: Cost of a new motor compared with rewinding

3.6.7 Achieved environmental benefits, Cross media effects, Applicability, and other considerations for electric motor ENE techniques

Achieved environmental benefits

Table 3.22 shows potentially significant energy savings measures which might be applicable to a motor driven sub-system. Although the values in the table are typical, the applicability of the measures will depend on the specific characteristics of the installation.

Motor driven sub-system energy savings measure	Typical savings range (%)
System installation or renewal	
Energy efficient motors (EEM)	2 - 8
Correct sizing	1 - 3
Energy efficient motor repair (EEMR)	0.5 - 2
Variable speed drives (VSD)	-4 - 50
High efficiency transmission/reducers	2 - 10
Power quality control	0.5 - 3
System operation and maintenance	
Lubrication, adjustments, tuning	1 - 5

Table 3.22: motor driven sub-system power energy saving measures

Cross-media effects

Harmonics caused by speed controllers, etc. cause losses in motors and transformers (see Section 3.5.2). An EEM takes more natural resources (copper and steel) for its production.

Applicability

Electric motor drives exist in practically all industrial plants, where electricity is available.

The applicability of particular measures, and the extent to which they might save money, depend upon the size and specific nature of the installation. An assessment of the needs of the entire installation and of the system within it can determine which measures are both applicable and profitable. This should be done by a qualified drive system service provider or by qualified in-house engineering staff. In particular, this is important for VSDs and EEMs, where there is a risk of using more energy, rather than savings. It is necessary to treat new drive application

designs from parts replacement in existing applications. The assessment conclusions will identify the measures which are applicable to a system, and will include an estimate of the savings, the cost of the measure, as well as the payback time.

For instance, EEMs include more material (copper and steel) than motors of a lower efficiency. As a result, an EEM has a higher efficiency but also a lower slip frequency (which results in more rpm) and a higher starting current from the power supply than a motor of standard efficiency. The following examples show cases where using an EEM is not the optimum solution:

- when a HVAC system is working under full load conditions, the replacement of an EEM increases the speed of the ventilators (because of the lower slip) and subsequently increases the torque load. Using an EEM in this case brings about higher energy consumption than by using a motor of standard efficiency. The design should aim not to increase the final rpm
- if the application runs less than 1000 – 2000 hours per year (intermittent drives), the EEM may not produce a significant effect on energy savings (see Economics, below)
- if the application has to start and stop frequently, the savings may be lost because of the higher starting current of the EEM
- if the application runs mainly with a partial load (e.g. pumps) but for long running times, the savings by using EEM are negligible and a VSD will increase the energy savings.

Economics

The price of an EEM motor is about 20 % higher than that of a conventional one. Over its lifetime, approximate costs associated with operating a motor are shown in Figure 3.30:

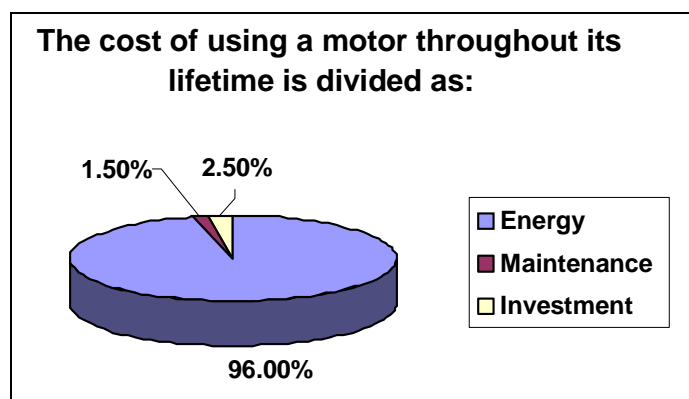

Figure 3.30: Lifetime costs of an electric motor

When buying or repairing a motor, it is really important to consider the energy consumption and to minimise it as follows:

- payback period can be as short as 1 year or less with AC drives
- high efficiency motors need a longer payback on energy savings.

Calculating the payback for this energy efficient technique, e.g. buying a higher efficiency motor compared to rewinding a failed standard motor:

$$\text{Payback (in years)} = \frac{Cost_{HEM} - Cost_{old}}{kW \times H \times Cost_{electricity} \times \left[\frac{1}{\eta_{rewinded}} - \frac{1}{\eta_{HEM}} \right]} \quad \text{Equation 3.11}$$

where:

- cost_{HEM} = cost of the new high efficiency motor
- cost_{old} = cost of rewinding the old motor
- $\text{cost}_{\text{electricity}}$ = cost of electricity
- kW = average power drawn by motor when running.

Driving forces for implementation

- AC drives are often installed in order to improve the machine control
- other factors are important in the selection of motors: e.g. safety, quality and reliability, reactive power, maintenance interval.

Examples

- LKAB (Sweden) – this mining company consumes 1 700 gigawatt hours of electricity a year, 90 per cent of which is used to power 15 000 motors. By switching to high efficiency motors, LKAB cuts its annual energy bill by several hundred thousand dollars (no date)
- Heinz food processing factory (UK) – a new energy centre will be 14 % more efficient due to combustion air fans controlled by AC drives. The energy centre has four boilers and has replaced the existing boiler plant.

Reference information

[137, EC, , 139, US_DOE, , 231, The motor challenge programme, , 232, 60034-30]

3.7 Compressed air systems (CAS)

Description

Compressed air is a air that is stored and used at a pressure higher than atmospheric pressure. Compressed air systems take a given mass of air, which occupies a given volume of space, and compress it into a smaller space.

Compressed air accounts for as much as 10 % of industrial consumption of electricity, or over 80 TWh per year in the EU-15.

Compressed air is used in two ways:

- as an integral component in industrial processes, e.g.
 - providing low purity nitrogen to provide an inert process atmosphere
 - providing low purity oxygen in oxidation processes, e.g. waste water treatment
 - for clean rooms, protection against contaminants, etc.
 - stirring in high temperature processes, e.g. steel and glass
 - blowing glass fibres and glass containers
 - plastics moulding
 - pneumatic sorting
- as an energy medium, e.g.
 - driving compressed air tools
 - driving pneumatic actuators (e.g. cylinders).

The predominant use of compressed air in IPPC applications is as an integral component in industrial processes. The pressure, the compressed air purity and the demand profile are predetermined by the process itself.

Compressed air is intrinsically clean and safe, due to its low risk of ignition or explosion either directly or from parts retaining heat, and it is therefore widely used in hazardous areas in chemical and related industries. Contrary to electricity, it does not require a 'return' pipe/cable and when used for driving tools, provides a high power density and – in the case of positive displacement tools – constant torque at constant pressure even at low rotational speeds. This represents an advantage compared to electrical tools in many applications. It is also easy to adapt to changing production requirements (often in high volume production situations), and can be used with its own pneumatic logic controls. It can be readily installed (although these are being superseded as cheaper electronic controls become available).

Pneumatic mechanical devices are often used for short, fast, low force linear movements or create high forces at low speed, such as driving assembly tools and processes (either manual or automated). Electric devices used for the same purpose are available: there are stroke magnets for short, fast movements and motors with threaded-rod-drives for high forces. However, pneumatic tools are convenient due to their low weight-to-power ratio which make them useful for long periods of time without overheating and with low maintenance costs.

However, when there are no other driving forces, alternatives to using compressed air should be considered.

The compressed air supply often represents an integral part of the plant design and has to be analysed in parallel with the overall compressed air requirements of the facility. In IPPC applications, the CAS is an important energy user and the share of the total energy used in the facilities may vary between 5 and 25 %. Due to the interest in energy efficiency, manufacturers of compressors and related equipment have developed technologies and tools for the optimisation of existing CASs and for design of new and more efficient alternatives.

Nowadays investment is governed by lifecycle cost analyses, especially with the supply of a new CAS. Energy efficiency is considered a major parameter in CAS design, and there is still potential in the optimisation of existing CASs. The lifetime of a large compressor is estimated at 15 to 20 years. In this time, the demand profile in a facility can change and may need to be reassessed, and in addition to this, new technologies are becoming available to improve the energy efficiency of existing systems.

In general, the choice of an energy medium (e.g. CAS) depends on many parameters of the application and has to be analysed case by case.

Energy efficiency in CASs

In most major process industry uses, compressed air is an integral component in the industrial process. In the majority of such applications, it is the only readily available technology to perform the process as it is, i.e. without a major redesign. In such situations energy efficiency in CASs is primarily or exclusively determined by the efficiency of compressed air production, treatment and distribution.

The energy efficiency of compressed air production, treatment and distribution is predetermined by the quality of planning, manufacturing and maintenance of the system. The aim of an expert design is to provide compressed air suitable for the needs of the application. A proper understanding of the application and the compressed air demand must be identified before the implementation of one or more of the energy efficiency techniques. It is sensible to embed these techniques in an energy management system where a reliable compressed air system audit is supported by a good quality database (see Sections 2.1 and 2.15.1).

In 2000, a study was carried out under the European SAVE programme to analyse the energy efficiency potentials in a CAS. Even though it covers all applications, and CAS in IPPC facilities are typically larger than the average CAS in industry, it provides a good overview on the relevant measures for improving the energy efficiency of a CAS.

A summary is given in Table 3.23:

Energy savings measure	% applicability (1)	% gains (2)	% potential contribution (3)	Comments
System installation or renewal				
Improvement of drives (high efficiency motors)	25	2	0.5	Most cost effective in small (<10 kW) systems
Improvement of drives (speed control)	25	15	3.8	Applicable to variable load systems. In multi-machine installations, only one machine should be fitted with a variable speed drive. The estimated gain is for overall improvement of systems, be they mono or multi-machine.
Upgrading of compressor	30	7	2.1	
Use of sophisticated control systems	20	12	2.4	
Recovering waste heat for use in other functions	20	20 – 80	4.0	Note that the gain is in terms of energy, not of electricity consumption, since electricity is converted to useful heat
Improved cooling, drying and filtering	10	5	0.5	This does not include more frequent filter replacement (see below)
Overall system design, including multi-pressure systems	50	9	4.5	
Reducing frictional pressure losses (for example by increasing pipe diameter)	50	3	1.5	
Optimising certain end use devices	5	40	2.0	
System operation and maintenance				
Reducing air leaks	80	20	16.0	Largest potential gain
More frequent filter replacement	40	2	0.8	
TOTAL			32.9	
Table legend: (1) % of CASs where this measure is applicable and cost effective (2) % reduction in annual energy consumption (3) Potential contribution = applicability * reduction				

Table 3.23: Energy savings measures in CASs [168, PNEUROP, 2007]

When using compressed air for driving tools, it should be taken into account that 'mechanical efficiency' is defined as 'shaft power of the tool divided by the total electrical input power needed to produce the compressed air consumed by the tool' and is typically in the range of 10 – 15 %.

Achieved environmental benefits

The aim of most techniques used to design or to modify a CAS is to improve of the energy efficiency of that system. Consequential benefits of improving energy efficiency of a CAS may include the reduction of noise emissions and the use of cooling water. Life expectancy of CASs and compressors is relatively high, therefore the use of materials in replacement equipment is low.

Cross-media effects

Emissions are limited to noise and oil mist. Other environmental impacts of a CAS are minor in relation to the use of energy.

In most facilities, the CAS is an independent sub-system. Most of the possible modifications in these systems do not influence other systems or processes. Energy usage for a CAS should be accounted for when used in other processes, see Section 1.3

Operational Data

Components of a CAS

A CAS is a combination of four sub-systems independent of the application:

- compressed air generation
- compressed air storage
- compressed air treatment
- compressed air distribution.

In addition to this, there are auxiliary systems such as heat recovery or condensate treatment.

Typical components of the sub-systems are shown in Table 3.24:

Generation	Storage	Treatment	Distribution	Auxiliary systems
Compressor	Receiver	Dryer	Piping	Heat recovery
Controller		Filter	Valves	Condensate drains
Cooler				

Table 3.24: Typical components in a CAS
[168, PNEUROP, 2007]

A scheme of the typical components of a compressed air system is shown in Figure 3.31.

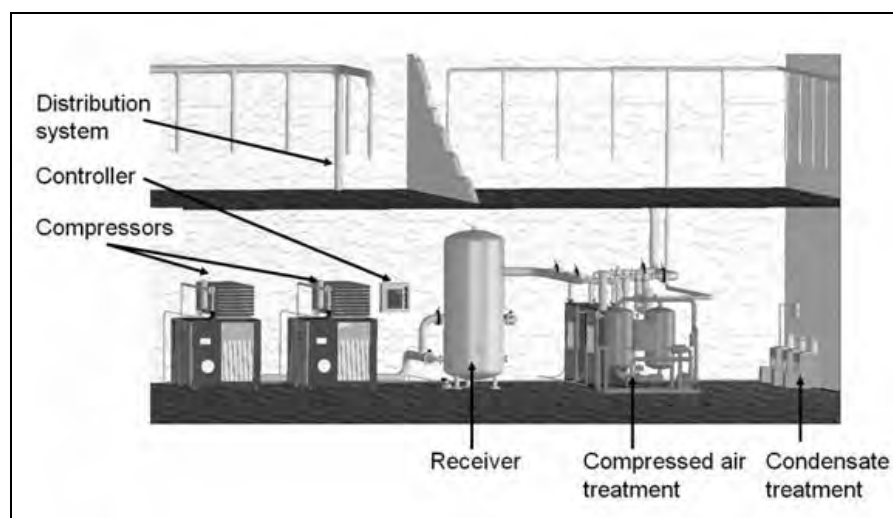

Figure 3.31: Typical components of a compressed air system (CAS)
[168, PNEUROP, 2007]

The majority of facilities have a multi-compressor station with central compressed air treatment and a large distribution system. In addition to this, machines such as looms or glass manufacturing devices often have an integrated, dedicated compressed air system. There is no standard system design for specific applications. Depending on the process and the parameters, there is the need to select the right components and to manage their interaction.

Types of compressors

Efficiency varies with the type of the compressor and with design. Efficiency, and therefore, running costs are key factors in the selection of a compressor, but the choice may be determined by the required quality and quantity of the compressed air.

Air compressor technology includes two basic groups, positive displacement and dynamic compressors. These are further segmented into several compressor types as shown in Figure 3.32 and text below:

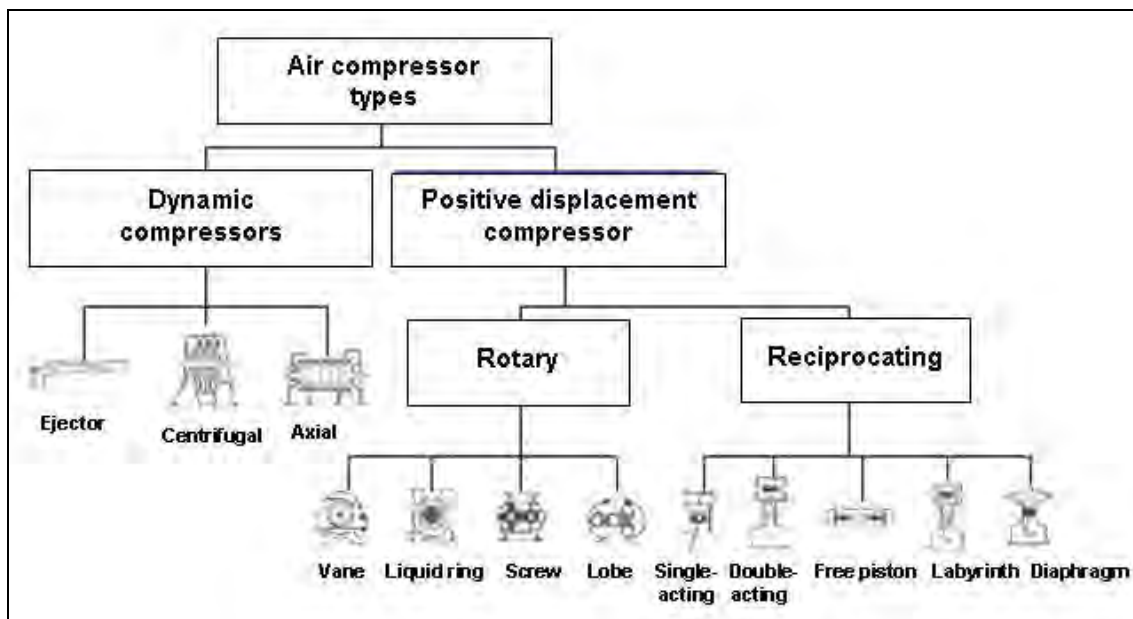

Figure 3.32: Types of compressors [168, PNEUROP, 2007]

- **positive displacement compressors** increase the pressure of a given quantity of air by reducing the space occupied by the air at the original pressure. This type of compressor is available in two basic styles, reciprocating and rotary. Both of these basic styles is then further segmented by different technologies:
 - *reciprocating compressors* utilise a piston moving within a cylinder to compress low pressure air to high pressure. They are available in single-acting and double-acting configurations
 - *rotary screw compressors* are the most widely applied industrial compressors in the 40 (30 kW) to 500 hp (373 kW) range. They are available in both lubricated and oil-free configurations. The popularity of rotary compressors is due to the relatively simple design, ease of installation, low routine maintenance requirements, ease of maintenance, long operating life and affordable cost
- **dynamic compressors** are rotary continuous-flow machines in which the rapidly rotating element accelerates the air as it passes through the element, converting the velocity head into pressure, partially in the rotating element and partially in stationary diffusers or blades. The capacity of a dynamic compressor varies considerably with the working pressure.

Applicability

Each CAS is a complex application that requires expertise in its design and the application of particular techniques. The design depends on many parameters such as:

- demand profile (including peak demand)
- compressed air quality needed
- pressure
- spatial constraints imposed by the building and/or plant.

As an example, ISO 8573-1 classifies compressed air quality for three types of contaminants. There are several classes which show the wide spread of purity needed for any contaminant in different applications:

- solid particle 8 classes
- humidity and liquid water 10 classes
- total oil content 5 classes.

In addition to this, it is not possible to evaluate the application of energy efficiency techniques for completely different systems. This can be illustrated by two demand profiles as shown in Figure 3.33.

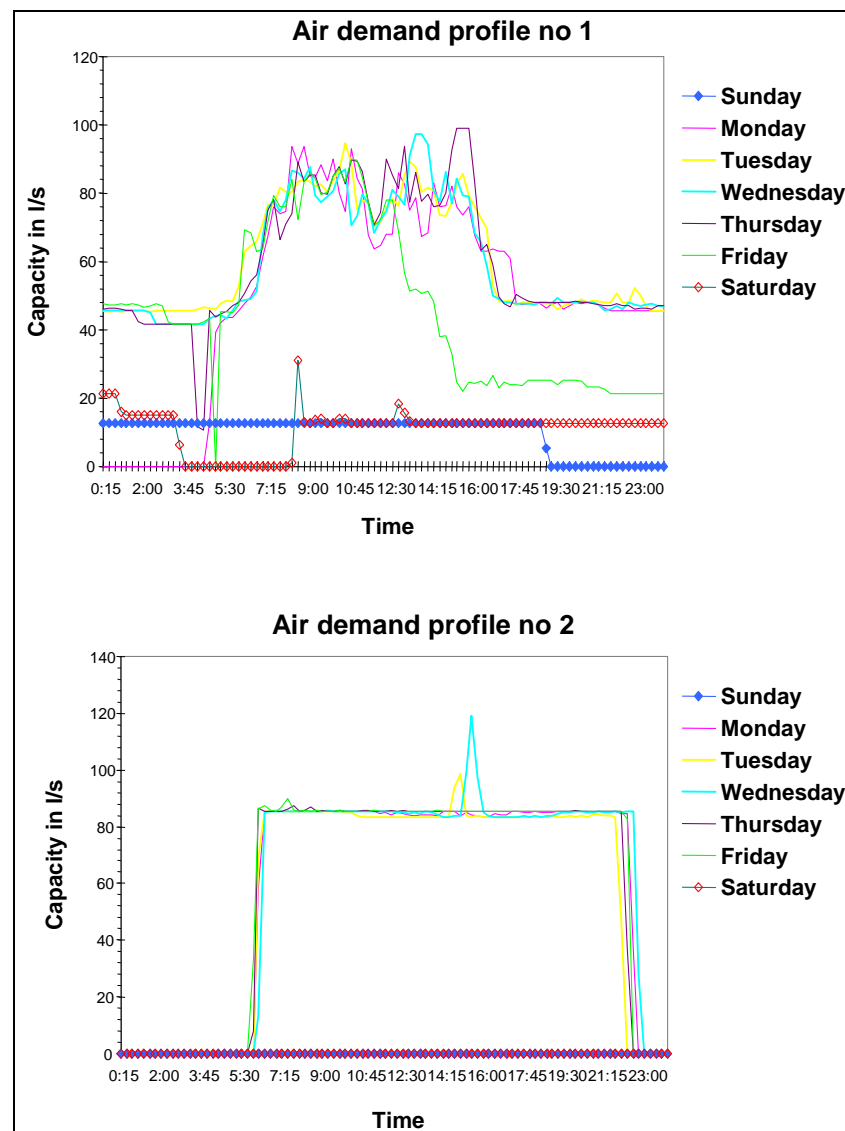

Figure 3.33: Different demand profiles
[168, PNEUROP, 2007]

The description of the following techniques (see Section 3.7.1 to 3.7.10) gives an brief overview of the possibilities. An expert system and demand analysis are the precondition for a new design or the optimisation of a CAS.

As described in Chapter 2, modifications in complex systems have to be evaluated case by case.

Economics

The price of compressed air is very variable in Europe from one company to another, from EUR 0.006 to 0.097 per Nm³ (considering that in 2006 the price of the electricity varied between EUR 0.052/kWh in Finland and was EUR 0.1714/kWh in Denmark: NUS consulting study on the electricity price). It is estimated that 75 % of this goes on energy compared to only 13 % on investment and 12 % on maintenance (based on usage of 6000 hours/year for five years). The variation in its cost is mainly due to the difference between an optimised installation and an installation that has not been optimised. It is essential to take this key parameter into consideration both when designing an installation and in the running of an existing installation.

The energy cost of compressed air is expressed in terms of specific energy consumption (SEC) in Wh/Nm³. For a correctly dimensioned and well managed installation, operating at a nominal flow and at a pressure of 7 bars, the following can be taken as a reference (it takes different compressor technologies into account):

$$85 \text{ Wh/Nm}^3 < \text{SEC} < 130 \text{ Wh/Nm}^3 \text{ [194, ADEME, 2007]}$$

This ratio represents the quality of the design and the management of the compressed air installation. It is important to know and monitor it (see Benchmarking in Section 2.16), because it can quickly deteriorate, leading to a large rise in the price of the air.

Initiatives have already been taken by Member State organisations and manufacturers in the area of energy efficiency improvement. Such programmes have shown that the implementation of the described techniques have a good return of investment.

Driving force for implementation

The improvement of energy efficiency in combination with short amortisation periods is the relevant motivation for the implementation of the described techniques (normal market forces).

Examples

Widely used.

Reference information

[190, Druckluft, , 191, Druckluft, , 193, Druckluft] [168, PNEUROPE, 2007, 169, EC, 1993, 194, ADEME, 2007] [189, Radgen&Blaustein, 2001, 196, Wikipedia]

3.7.1 System design

Description

Nowadays many existing CASs lack an updated overall design. The implementation of additional compressors and various applications in several stages along the installation lifetime without a parallel redesign from the original system have frequently resulted in a suboptimal performance of a CAS.

One fundamental parameter in a CAS is the pressure value. A number of pressure demands, depending on the application, usually sets up a trade-off between low pressures giving a higher energy efficiency and high pressures where smaller and cheaper devices can be used. The majority of consumers use a pressure of about 6 bar(g), but there are requirements for pressures of up to 13 bar(g). Often the pressure is chosen to meet the maximum pressure needed for all devices.

It is important to consider that too low a pressure will cause malfunctioning of some machines, while a pressure higher than necessary will not, but will result in reduced efficiency. In many cases, there is an 8 or 10 bar(g) system pressure, but most of the air is throttled to 6 bar(g) by pressure reducing valves.

It is state-of-the-art to choose a pressure which satisfies 95 % of all needs and uses a small pressure-increasing device for the rest. Operators try to eliminate the devices needing more than 6 bar(g), or having two systems with different pressures, one with a higher pressure and one for 6.5 bar(g).

Another basic parameter is the choice of the storage volume. As compressed air demand typically comes from many different devices, mostly working in intermittently, there are fluctuations in air demand. A storage volume helps to reduce the pressure demand fluctuations and to fill short-timing peak demands (see Section 3.7.10).

Smoothed demand allows a steadier running of smaller compressors, with less idling time and thus less electric energy is needed. Systems may have more than one air receiver. Strategically locating air receivers near sources of high short-timing demands can also be effective, meeting peak demand of devices and making it possible to lower system pressures.

A third fundamental design issue for a compressed air system is dimensioning the pipework and positioning the compressors. Any type of obstruction, restriction or roughness in the system will cause resistance to the airflow and will cause the pressure to drop, as will long pipe runs. In the distribution system, the highest pressure drops are usually found at the points of use, including undersized hoses, tubes, push-fit connectors, filters, regulators and lubricators. Also, the use of welded pipework may reduce frictional losses.

Sometimes the air demand has grown 'organically' over the years and a former side branch of the pipework – with a small diameter – has to transfer a higher volume flow, resulting in pressure loss. In some cases, plant equipment is no longer used. The airflow to this unused equipment should be stopped as far back in the distribution system as possible without affecting operating equipment.

A properly designed system should have a pressure loss of less than 10 % of the compressor's discharge pressure to the point of use. This can be reached by: regular pressure loss monitoring, selecting dryers, filters, hoses and push-fit connectors having a low pressure drop for the rated conditions, reducing the distance the air travels through the distribution system and recalculating the pipe diameters if there are new air demands.

What is often summed up under the point 'overall system design' is actually the design function of the use of compressed air. This can lead to inappropriate use, for example, over-pressurisation followed by expansion to reach the proper pressure, but these situations are rare. In industry nowadays, most people are aware of compressed air as a significant cost factor.

Achieved environmental benefits

Keeping up a compressed air system design as a state-of-the-art system as this lowers electric energy consumption.

Cross-media effects

No data submitted.

Operational data

Better efficiency may require more and better equipment (more and bigger tubes, filters, etc.).

Applicability

There are many compressed air systems, with estimates as high as 50 % of all systems, that could be improved by a revision of their overall design, with a gain of 9 % by lowering the pressure and with better tank dimensioning (in 50 % of systems) and 3 % by lowering pipework pressure losses (in 50 % of systems) resulting in 6 % = 0.5 x (0.09 + 0.03) energy savings.

System design may also include the optimisation of certain end use devices, typically in 5 % of all systems it is possible to lower the demand by some 40 %, resulting in 2 % (i.e. 0.05 x 0.4) energy savings.

Economics and driving force for implementation

The costs of revising a compressed air system with consequent readjustment of pressure and renewing pipework is not easy to calculate and depends very much on the circumstances of the particular plant. The savings in a medium size system of 50 kW can be estimated to be:

$$50 \text{ kW} \times 3000 \text{ h/yr} \times \text{EUR } 0.08/\text{kW} \times 10 \% = \text{EUR } 1200/\text{yr}$$

The costs for a major revision in such a system, adding a 90 litre tank near a critical consumer and a shut-off valve for a sparsely used branch, replacing 20 metres of pipework, 10 hoses and disconnectors is about EUR 2000, so the payback period is a profitable 1.7 years. Often the costs are lower, when only some pressure readjustment needs to be done, but in every case there has to be thorough considerations about the lowest tolerable pressure meeting the needs.

Economics are a driving force to revise compressed air systems. A major obstacle is a lack of knowledge and/or of skilled staff responsible for compressed air systems. Technical staff may be aware that the compressed air is expensive, but the inefficiencies are not readily obvious, and the operator may lack staff with sufficient in-depth experience.

Initiatives in many countries of the EU for spreading compressed air knowledge strongly promoted the implementation, creating a 'win-win-win' situation: the owner of the compressed air systems wins lower overall costs, the supplier of compressors and other devices wins higher revenues and the environment wins lower power station emissions.

Examples

No data submitted.

Reference information

[168, PNEUROP, 2007, 194, ADEME, 2007]

3.7.2 Variable speed drives (VSD)

Description

Variable speed drives (VSD, see Section 3.6.3) for compressors find applications mainly when the process air requirements of the users fluctuate, over times of the day and days of the week. Conventional compressor control systems such as load/unload, modulation, capacity control and others, try to follow this change in the air demand. If this leads to high switching frequencies and high idle time, a consequential reduction in the energy efficiency takes place. In VSD compressors, the speed of the electric motor is varied in relation to the compressed air demands, resulting in a high level of energy savings.

Studies show that a majority of compressed air applications have moderate to large fluctuations in air demand and hence there is great potential for energy savings by the application of variable speed driven compressors.

Achieved environmental benefits

Savings in energy.

Cross-media effects

None.

Operational data

Tests carried out by an independent laboratory have demonstrated high energy savings, when running against typical air demand patterns. Variable speed drives on compressors, apart from energy savings, also yield some additional benefits:

- pressure is very stable and this benefits operational process stability in some sensitive processes
- power factors are much higher than for conventional drives. This keeps reactive power low
- starting currents never exceed the full load currents of the motor. Users can, as a consequence, reduce the ratings of electrical components. Also where applicable, the users can avoid power penalties from utility companies by avoiding current peaks during start-up. Peak savings occur automatically
- VSD technology provides a smooth start-up at low speeds eliminating current and torque peaks, thus reducing mechanical wear and electrical stress and extending the operating lifetime of the compressor
- the noise level is reduced as the compressor runs only when necessary.

Applicability

Variable speed drive compressors are appropriate for a number of operations in a wide range of industries, including metal, food, textile, pharmaceutical, chemical plants, etc. where there is a highly fluctuating demand pattern for compressed air. No real benefit can be achieved if the compressor operates continuously at its full capacity or close to it (see Examples, below).

VSD compressors may be applied into an existing compressed air installation. On the other hand, VSD controllers could be integrated into existing fixed speed compressors; however, better performances are obtained when the VSD controller and the motor are supplied in conjunction since they are matched to give the highest efficiency within the speed range. VSD applications should be limited to more up-to-date compressors due to possible problems with older compressors. The manufacturer or CAS expert should be consulted if in doubt.

Many CASs already have a variable speed driven compressor so the applicability across industry for additional variable speed compressors is some 25 %. The savings can be up to 30 %, although the average gain in a CAS, where one compressor with a variable speed drive is added, is about 15 %. It is likely that more CASs can employ variable speed driven compressors to their advantage.

Economics

Energy typically constitutes about 80 % of the life cycle costs of the compressor, the balance of 20 % comprises investments and maintenance. An installation, where (conservatively estimated) 15 % energy is saved owing to using variable speed drives, saves 12 % life cycle costs, whereas the additional investment for the variable speed compressor (instead of a traditional one) adds only some 2 to 5 % to the life cycle costs.

Driving force for implementation

Economics and environmental concerns are the primary drivers.

Examples

Capacity tests to BS1571 were undertaken on an 18-month old screw compressor at Norwegian Talc Ltd. Hartlepool, UK. Energy savings of 9.4 kW (or 9 % of full-load power) at 50 % rated delivery were possible, and greater savings were possible if running at an even lighter load. However, at full-load the energy consumption would be 4 % higher due to the power losses with the inverter. Therefore, a VSD should not be used with compressors running for long periods at full-load.

Reference information

[168, PNEUROP, 2007, 194, ADEME, 2007, 195, DETR]

3.7.3 High efficiency motors (HEM)

Description

Although a formal definition for a high efficiency motor does not exist, these components are generally classified as motors where losses have been reduced to the absolute minimum. High efficiency motors minimise electrical and mechanical losses to provide energy savings. Various classifications exist worldwide to differentiate high efficiency motors from others. Examples are EFF1, NEMA premium, etc. (see Section 3.6.1).

Achieved environmental benefit

Savings in energy.

Cross-media effects

- current drawn is lower
- heat generated is lower.

Operational data

No data submitted.

Applicability

Motor losses are independent of where and what for the motor is used for. This means that high efficiency motors can be used almost anywhere. High efficiency motors are already used in most large applications (75 %); the majority of the remaining 25 % are smaller systems.

Economics

A seemingly small efficiency gain of even 1 – 2 % contributes to proportional savings during the entire lifetime of the motor. Cumulative savings will be substantial.

Driving force for implementation

Cost savings.

Examples

No data submitted.

Reference information

[168, PNEUROP, 2007, 194, ADEME, 2007, 195, DETR]

3.7.4 CAS master control systems

Description

In the majority of IPPC applications, CASs are multi-compressor installations. The energy efficiency of such multi-compressor installations can be significantly improved by CAS master controls, which exchange operational data with the compressors and partly or fully control the operational modes of the individual compressors.

The efficiency of such master controls strongly depends on the capabilities of the communication link, which can range from simple floating relay contacts to networks using automation protocols. An increase in communication capabilities offers more degrees of freedom to retrieve operational data from the compressor, to control the operational mode of the individual compressors and to optimise the overall energy consumption of a CAS.

The control strategy of the master control has to take into account the characteristics of the individual compressors, in particular their control mode. Some remarks on control modes of common compressor types are given to illustrate this. The most commonly used control modes of individual compressors are:

- switching between load, idle and stop, and
- frequency control.

The main features of sophisticated compressor and master controls can be summarised as follows:

- advanced communication features (e.g. based on automation protocols)
- comprehensive access of the CAS master control to operational data of individual compressors
- comprehensive control of all compressor operation modes by the CAS master control
- self-learning optimisation of master control strategy, including recognition of CAS properties
- determination and activation of highly energy efficient combinations of loaded, idling and stopped compressors and transitions between these states to match total free air delivery (FAD) demand
- effective control of variable frequency compressors to compensate short term fluctuations in FAD demand avoiding inefficient long term operation at constant speed, in particular at low frequencies
- minimisation of switching frequencies and idle operation of fixed speed compressors
- sophisticated prediction methods and models for total FAD demand including recognition of cyclic demand patterns (daily or weekly shift and workspace patterns, etc.)
- additional functions like remote monitoring, plant data collection, maintenance planning, teleservice and/or supply of preprocessed operational data via web servers
- control of other CAS components in addition to compressors.

Achieved environmental benefit

- improved energy efficiency
- current drawn and heat generated are lower.

Cross-media effects

None.

Operational data

- *in single compressor installations:* the optimal operating conditions in a CAS take place when the compressor works continuously at a fixed speed at optimum efficiency. However, if the air demand is not continuous, stopping/idling the compressor during long idle periods may be a more efficient solution:
- **compressors without frequency control** are switched between load, idle and stop to operate at a fixed speed and provide 100 % (FAD) during load and 0 % FAD during idle or stop. Sometimes, operating the compressor in idle mode instead of stopping it may be necessary, if the pressure regulation requires more frequent changes between 100 % FAD and 0 % FAD than the permissible starting frequency of the electric drive motor would allow for.

The power consumption during idle operation is typically 20 – 25 % of the full load value. Additional losses result from venting the compressor after switching to stop and from electric starting losses of the drive motor. In single compressor installations the required switching frequency directly depends on the load profile, the receiver (storage) size, the admissible pressure band and the FAD of the compressor.

If these control parameters are chosen inappropriately, the average efficiency of fixed speed compressors operating in discontinuous mode can be significantly reduced compared to those operating at full speed in continuous mode. In such cases, the use of sophisticated master controls to optimise the process parameters of the compressor working discontinuously is an effective tool to improve the efficiency of the CAS. Complex master controls are designed and programmed to minimise idle operation and switching frequencies using various strategies by directly stopping compressors whenever the motor temperature (measured or estimated) allows for a possible immediate restart, where necessary. Fixed speed compressors are very energy efficient if minimisation of idle periods is achieved

- **in compressors with frequency controls** the operating speed of the compressor element is continuously varied between maximum and minimum speed. Normally the controls range between maximum and minimum speed which is approx. 4:1 to 5:1 and the FAD of displacement compressors (e.g. screw compressors) is roughly proportional to the operating speed. Due to inherent losses in frequency converters and induced losses in the asynchronous drive motors, the efficiency of the drive system itself is reduced compared to fixed speed drives (3 – 4 % reduction at full load, and even more at part load). In addition, the efficiency rate of displacement compressors (e.g. oil-injected and dry running screw compressors) significantly decreases at low operating speeds compared to operation at the design point.

In single compressor installations, these negative effects can be compensated by the appropriate regulation properties of the variable frequency compressor when eliminating the idling, venting and/or starting losses that fixed speed compressors would have in the same application. Due to the limited control range (see above), even variable frequency compressors have some idling, stopping and/or starting losses at low FAD demands.

- *multi-compressor installations:* For multi-compressor installations the above reasoning is too simplistic because the varying overall FAD demand will be matched by the master control through complex combinations of, and transitions between, the operation modes of several compressors. This also includes controlling the operating speed of a variable frequency compressor, where there are any, in order to significantly minimise the idle operation and switching frequencies of the fixed speed compressors.

The integration of a variable frequency compressor in a multi-compressor installation can be very successful in a CAS with a relatively low storage capacity, strongly and/or rapidly varying FAD demand, few compressors and/or insufficiently staged compressor sizes. A CAS with reasonably staged compressor sizes, on the other hand, enables master controls to precisely adjust produced FAD to FAD demand by activating a multitude of different compressor combinations with low switching frequencies and low idle time.

Master controls typically operate multiple compressors on a common pressure band to keep a defined minimum pressure at a n appropriate measurement point. This provides clear energy savings compared to cascade schemes. Sophisticated master controls use strategies which allow narrowing of the pressure band without increasing the switching frequencies and the idle time of the compressors. A narrow pressure band further lowers the average backpressure and hence reduces the specific energy requirement of the loaded compressors and artificial downstream demand.

Applicability

According to the SAVE study, the retrofit of sophisticated control systems is applicable to, and cost effective for, 20 % of existing CASs. For typically large CASs in IPPC installations, the use of sophisticated master controls should be regarded as state-of-the-art.

The highest energy savings can be achieved if the implementation of sophisticated master controls is planned in the phase of system design phase together with the initial compressor selection or in combination with major component (compressors) replacements. In these cases, attention should be paid to the selection of master and compressor controls with advanced, comprehensive and compatible communication capabilities.

Due to the long lifetime of a CAS, this optimum scenario is not always within reach, but retrofitting an existing CAS with sophisticated master controls and – if there is no more progressive alternative – even connecting old compressors to it via floating relay contacts, can provide significant energy savings.

Economics

The cost effectiveness for integrating master control systems in a newly designed CAS depends on circumstances like demand profiles, cable lengths and compressor types. The resulting average energy savings is estimated to be 12%. In the case of retrofitting, a master control system in an existing CAS, the integration of older compressors and the availability of plans gives another uncertainty, but a payback time of less than one year is typical.

Driving force for implementation

The primary driving force for implementation is the reduction of energy costs, but some others are worth mentioning. If sophisticated master and compressor controls provide advanced communication capabilities, it becomes possible to collect comprehensive operational data in the master control. In combination with other features, this provides a basis for planned or condition-based maintenance, teleservice, remote-monitoring, plant data collection, compressed air costing and similar services, which contribute to a reduction of maintenance costs, an increase of operational availability and a higher awareness of compressed air production costs.

Examples

The installation of a computerised compressor control system has reduced compressed air generation costs by 18.5% at Ford Motor Company (formerly Land Rover) Solihull, UK. The system was installed and has been operated with no disruption to production. The overall costs for the system produced a payback period of 16 months which could be replicated on most compressed air systems utilising three or more compressors. This presents a simple and reliable opportunity for large compressed air users to reduce their electrical costs as shown below:

- potential users: any compressor house containing three or more compressors
- investment costs: total system-related costs were EUR 44900, of which EUR 28300 were capital costs (1991 prices)
- savings achieved: 600000 kWh (2100 GJ/year, worth EUR 34000/year (1991 prices))
- payback period: 1.3 years (direct benefit from controller); eight months (taking into account consequent leakage reduction).

(GBP 1 = EUR 1.415489, 1 January 1991)

The required investment costs have fallen significantly nowadays, thus the capital cost would have reduced from EUR 28300 to 5060 in 1998 resulting in a payback of less than 3 months despite the lower cost of electricity to Land Rover in 1998.

Reference information

[113, Best practice programme, 1996]

3.7.5 Heat recovery

Description

Most of the electrical energy used by an industrial air compressor is converted into heat and has to be conducted outwards. In many cases, a properly designed heat recovery unit can recover a high percentage of this available thermal energy and put to useful work heating either air or water when there is a demand.

Achieved environmental benefits

Energy savings.

Cross-media effects

None.

Operational data

Two different recovery systems are available:

- heating air: air-cooled packaged compressors are suitable to heat recovery for space heating, industrial drying, preheating aspirated air for oil burners or any other applications requiring warm air. Ambient atmospheric air is passed through the compressor coolers where it extracts the heat from the compressed air process.

Since packaged compressors are typically enclosed in cabinets and already include heat exchangers and fans, the only system modifications needed are the addition of ducting and another fan to handle the duct loading and to eliminate any back-pressure on the compressor cooling fan. These heat recovery systems can be modulated with a simple thermostatically-controlled hinged vent.

Heat recovery for space heating is less efficient for water-cooled compressors because an extra stage of heat exchange is required and the temperature of the available heat is lower. Since many water-cooled compressors are quite large, heat recovery for space heating can be an attractive opportunity

- heating water: it is also possible to use a heat exchanger to extract waste heat from the lubricant coolers found in packaged air- and water-cooled compressors to produce hot water. Depending on design, heat exchangers can produce non-potable or potable water. When hot water is not required, the lubricant is routed to the standard lubricant cooler.

Hot water can be used in central heating or boiler systems, shower systems, industrial cleaning processes, plating operations, heat pumps, laundries or any other application where hot water is required.

Applicability

Heat recovery systems are available for most compressors on the market as optional equipment, either integrated in the compressor package or as an external solution. An existing CAS can generally be retrofitted very easily and economically. Heat recovery systems are applicable for both air- and water-cooled compressors.

Economics

As much as 80 - 95 % of the electrical energy used by an industrial air compressor is converted into thermal energy. In many cases, a properly designed heat recovery unit can recover approximately 50 - 90 % of this available thermal energy and put it into useful work heating air or water.

The potential energy savings are dependent on the compressed air system, on the operating conditions and on the utilisation.

Recoverable heat from a compressed air system is normally insufficient to be used to produce steam directly.

Typical air temperatures of 25 to 40 °C above the cooling air inlet temperature and water temperatures of 50 to 75 °C can be obtained.

An example for an energy savings calculation of an oil-injected screw compressor is given in Table 3.25 below:

Nominal power compressor	Recoverable heat (approx. 80 % of nominal power)	Annual fuel oil saving at 4000 running hours/yr	Annual cost saving @ EUR 0.50/l fuel oil
kW	W	Litres/yr	EUR/yr
90.72		36330	18165

Table 3.25: Example of cost savings
[168, PNEUROP, 2007]

$$\text{Annual cost saving (EUR/yr)} = \frac{\text{nominal power compressor (kW)} \times 0.8 \times \text{running hours/yr} \times \text{fuel oil costs (EUR/l)}}{\text{gross calorific value fuel oil (kWh/l)} \times \text{heating oil efficiency factor}}$$

Equation 3.12

where:

- gross calorific value fuel oil = 10.57 (kWh/l)
- efficiency factor oil heating = 75 %.

Driving force for implementation

Cost savings.

Examples

No data submitted.

Reference information

[121, Caddet Energy Efficiency, 1999, 168, PNEUROP, 2007]

3.7.6 Reducing compressed air system leaks

Description

The reduction of compressed air system (CAS) leaks has by far the highest potential gain on energy. Leakage is directly proportional to the system pressure (gauge). Leakages are present in every CAS and they are effective 24 hours a day, not only during production.

The percentage of compressor capacity lost to leaks should be less than 10 % in a well maintained large system. For small systems, leakage rates of less than 5 % are recommended. The amount of leakage in a poorly maintained 'historically grown' CAS can be up to 25 %.

Preventive maintenance programmes for compressed air systems should therefore include leak prevention measures and periodic leak tests. Once the leaks are found and repaired, the system should be re-evaluated. Tests should include the following:

- estimating the amount of leakage: all methods of estimating the amount of leakage in a CAS require no demands on the system, which means that all devices consuming air are turned off and therefore all air consumption is only due to leakage:

- direct measurement is possible if a compressed air consumption measurement device is installed
- in a CAS with compressors that use start/stop controls, the estimation of the amount of leakage is possible by determination of the running time (on-load time) of the compressor in relation to the total time of the measurement. In order to get a representative value, the measurement time should include at least five starts of the compressor. Leakage expressed as a percentage of the compressor capacity is then calculated as follows:

$$\text{Leakage (\%)} = 100 \times \text{running time/measurement time}$$

- in a CAS with other control strategies, leakage can be estimated if a valve is installed between the compressor and the system. An estimation of the total system volume downstream of that valve and a pressure gauge downstream of the valve are also required
- the system is then brought to operating pressure (P1), the compressor is switched off and the valve shut. The time (t) it takes for the system to drop from P1 to a lower pressure P2 is measured. P2 should be about 50 % of the operating pressure (P1). The leakage flow can then be calculated as follows:
 - Leakage (m³/min) = system volume (m³) x (P1 (bar) – P2 (bar)) x 1.25/t (min)
 - The 1.25 multiplier is a correction for the reduced leakage with falling system pressure
 - Leakage expressed as a percentage of the compressor capacity is then calculated as follows:

$$\text{Leakage (\%)} = 100 \times \text{leakage (m}^3\text{/min)/compressor inlet volume flow (m}^3\text{/min)}$$

- reducing the leakage: stopping leaks can be as simple as tightening a connection or as complex as replacing faulty equipment such as couplings, fittings, pipe sections, hoses, joints, drains, and traps. In many cases, leaks are caused by badly or improperly applied thread sealant. Equipment or whole parts of the system no longer in use should be isolated from the active part of the CAS.

An additional way to reduce leakage is to lower the operating pressure of the system. With lower differential pressure across a leak, the leakage flowrate is reduced.

Achieved environmental benefits

Energy savings.

In addition to being a source of wasted energy, leaks can also contribute to other operating losses. Leaks cause a drop in system pressure, which can make air tools function less efficiently, which decreases productivity. In addition, by forcing the equipment to cycle more frequently, leaks shorten the life of almost all system equipment (including the compressor package itself). Increased running time can also lead to additional maintenance requirements and increased unscheduled downtime. Finally, air leaks can lead to adding unnecessary compressor capacity.

Cross-media effects

None reported.

Operational data

Leaks are a significant source of wasted energy in an industrial compressed air system, sometimes wasting 20 – 30 % of a compressor's output. A typical plant that has not been well maintained will likely have a leak rate equal to 20 % of total compressed air production capacity.

On the other hand, proactive leak detection and repair can reduce leakage to less than 10 % of compressor output, even in a larger CAS.

Several methods exist for leak detection:

- searching for audible noise caused by larger leaks
- applying soapy water with a paint brush to suspect areas
- using an ultrasonic acoustic detector
- tracing gas leaks using, e.g. hydrogen or helium.

While leakage can occur in any part of the system, the most common problem areas are:

- couplings, hoses, tubes, and fittings
- pressure regulators
- open condensate traps and shut-off valves
- pipe joints, disconnections, and thread sealants
- compressed air tools.

Applicability

Generally applicable to all CASs (see Table 3.23).

Economics

The costs of leak detection and repair depend on the individual CAS and on the expertise of the maintenance crew of the plant. Typical savings in a medium size CAS of 50 kW are:

$$50 \text{ kW} \times 3000 \text{ h/yr} \times \text{EUR } 0.08/\text{kWh} \times 20 \% = \text{EUR } 2400/\text{yr}$$

The typical costs for regular leakage detection and repair is EUR 1000/yr.

As leakage reduction is widely applicable (80 %) and gives the highest gains (20 %), it is the most important measure for reducing CAS energy consumption.

Driving force for implementation

No data submitted.

Examples plant

Based on 1994 data, Van Leer (UK) Ltd used 179 kWh to produce 1000 m³ of compressed air, at a cost of EUR 7.53/1000 m³. The leakage reduction exercise resulted in an annual energy savings of 189200 kWh worth EUR 7641/year. This represented a 25 % saving on the cost of providing compressed air. The leakage survey cost EUR 2235 and a further EUR 2874 (including replacement parts and labour) was spent on remedial work. With savings of EUR 7641/year, the leakage reduction programme achieved a payback period of nine months (GBP 1 = EUR 1.314547, 1 January 1994).

Reference information

[168, PNEUROP, 2007]

3.7.7 Filter maintenance

Description

Pressure losses can be caused by badly maintained filters, either through inadequate cleaning or disposable filters not being replaced frequently enough.

Achieved environmental benefits

- energy savings
- reduced emissions of oil mist and/or particles.

Cross-media effects

Increased use of filters, and discarding as waste.

Operational data

No data submitted.

Applicability

All CASs.

Economics

See Table 3.23.

Driving force for implementation

No data submitted.

Examples

No data submitted.

Reference information

3.7.8 Feeding the compressor(s) with cool outside air

Description

Often the main compressor station is placed near the main loads demanding compressed air, to decrease the pressure drops along the lines. It is not uncommon to find the main station placed underground, or in inner rooms inside the installation. In such cases, there is normally a lack of fresh air to feed the compressors, and the motors are compelled to compress the ambient air, which is generally at a temperature higher than the outside air temperature. For thermodynamic reasons, the compression of warm air requires more energy than the compression of cool air. In technical literature, it is found that each increase of 5 °C of inlet air temperature at the compressor causes an increase of about 2 % of the power needed. This energy can be saved simply by feeding the compressed air station with outside air, especially in cold seasons, when the difference between outside and inside temperatures can be several times greater than 5 °C, depending on the location. A duct can be installed connecting the outside and the intake of the compressor, or to the entire compressed air station. A fan may be required, depending on the length of the duct, and this energy should be considered during planning. The outside intake should be placed on the north side, or at least in the shade for most of the time.

Achieved environmental benefits

Less consumption of primary energy resources. Normally compressors are driven by electric motors.

Cross-media effects

None known.

Operational data

Due to the presence of a large amount of heat released by the compressor, whether it is recovered or not, the room temperature in CA stations is always high. It is not uncommon to find room temperatures of 30 – 35 °C, even in winter. Obviously, the greater the difference of outside-inside temperatures, the greater the power savings achievable; it has to be borne in mind that such savings are to be multiplied for the running hours of compressors normally in operation.

Applicability

Reducing the compressors inlet air temperature by feeding cool air from the outside is always possible. Sometimes it is sufficient to open a circular hole in a wall, and install a duct connecting the outside intake with the compressor intake. When the CA station is located in a situation where access to the outside is difficult, the ventilation of the room should be improved. It is estimated to be applicable in 50 % of cases.

Economics

The reduction of the air temperature entering the compressor involves economic advantages such as: the cold air feed is free; the reduction of running use of compressors (savings of kWh); the reduction of electric power supply (savings of kW).

Table 3.26 gives an evaluation of the savings that may be achieved by using this technique. This example is taken from an actual energy diagnosis.

	Description	Value	Unit	Formula	Comment
A	Present compression installed power	135 k	W	-	
B	Working hours/year at full load	2000	h/yr	-	
C	Energy needed	270000	kWh	AxB	
D	Decrease of feeding air temperature achieved	5	°C -		Estimate
E	Savings per cent	2.00	%	-	From tech. literature
F	Annual electric energy savings	5400	kWh	CxE	
G	Cost of kWh	0.1328	EUR/kWh	-	Average datum
H	Annual economic savings	717	EUR/year	FxG	
I	Investment	5000	EUR	-	Estimate for duct and fan
L	Internal rate of return (IRR) before taxes	6.7 %		-	From cost-benefit analysis (*)
M	Net positive value	536	EUR	-	From cost-benefit analysis (*)
N	Payback 7	.0	years	-	From cost-benefit analysis (*)
(*) For a lifetime of 10 years and an Interest rate of 5 %					

Table 3.26: Savings obtained by feeding the compressor with cool outside air

Driving force for implementation

- simplicity of installation
- energy and money savings.

Examples

A semi-conductor mill in Italy.

Reference information

[229, Di Franco, , 231, The motor challenge programme, , 233, Petrecca, 1992]

3.7.9 Optimising the pressure level

Description

The lower the pressure level of the compressed air generated, the more cost effective the production. However, it is necessary to ensure that all active consumers are supplied with sufficient compressed air at all times. Improved control systems make it possible to reduce peak pressure. In principle, there are several ways to ‘narrow’ the pressure ranges, thus reducing the pressure of the compressed air generated. These possibilities are listed below and illustrated in Figure 3.35:

- direct readjustment via mechanical switches on the compressors. The cheapest way to adjust the pressure range of a compressor is to use mechanical pressure switches. Since the setting sometimes changes by itself, these control switches have to be readjusted from time to time
- intelligent control using a frequency converter compressor or optimal compressor size. The pressure range is readjusted by means of a frequency converter compressor functioning as a peak load compressor and adapting its speed drives to specific compressed air needs, or by means of a master control which switches to a compressor of the most appropriate size
- reduction of the pressure range right to the ‘limit’ (optimised intelligent control). The intelligent control system reduces the pressure range to the point which allows the compressor network to operate just above the limit of under supply. Figure 3.34 shows different efficiencies of those control systems.

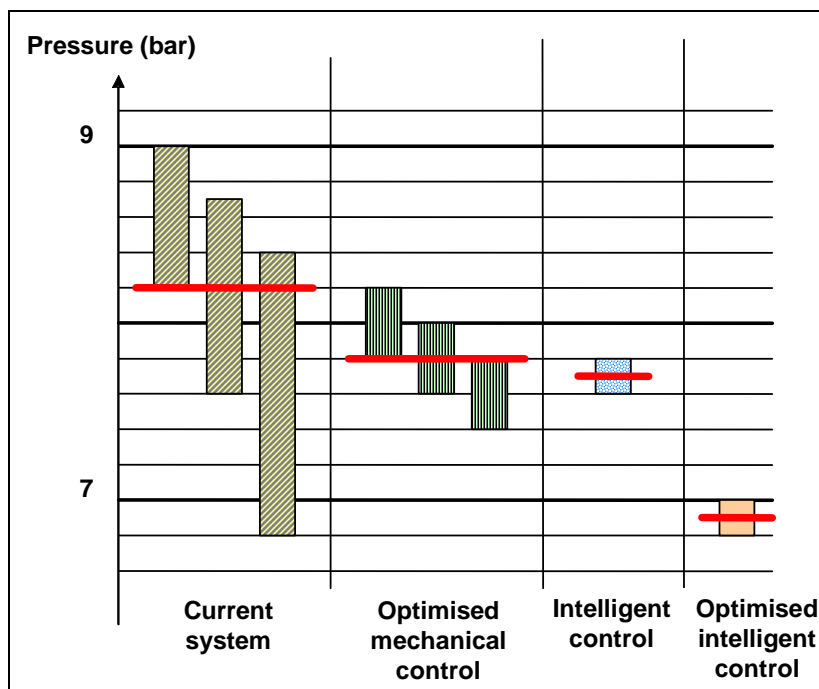

Figure 3.34: Different kinds of compressor control
[28, Berger, 2005]

Figure 3.34 is described below:

- horizontal red lines in the different control systems indicate the average pressure of the compressed air generated
- diagonally filled yellow bars for current systems show that the average pressure of the compressed air is 8.2 bar
- vertically filled green bars show that the mechanical pressure switches can only be set to a difference of 0.4 bar (the difference between the predefined lower and upper limit) due to occurring tolerance margins, thus generating compressed air at 7.8 bar. This is based on the assumption that the point at which the first peak load compressor is switched on remains unchanged at 7.6 bar
- an intelligent control system – blue spotted bars – can narrow the pressure range of the entire compressor station down to 0.2 bar. This control system responds to the rate of pressure changes. Provided that the point at which the first peak load compressor is switched on, also remains the lower predefined pressure limit in the future, the average pressure here is 7.7 bar.

A pressure of 7.7 bar is still quite high compared to other comparable compressor stations. Since the pressure limit for switching on the second peak load compressor (= consecutive compressor) is 6.8 bar, this is regarded as the lower limit for the compressed air. This pressure corresponds to that of similar compressor stations. The average pressure in this case is 6.9 bar.

Achieved environmental benefits

In practice, it has been shown that reducing pressure by 1 bar results in energy savings of 6 to 8 %. The pressure reduction also brings about a reduction in the leakages.

Cross-media effects

No data submitted.

Operational data

No data submitted.

Applicability

The VSD-based control of a compressor which can be used in intelligent and optimised intelligent control systems usually proves to be cost effective only in the case of a new purchase, because the subsequent installation of a frequency converter in an existing compressor is not recommended by manufacturers.

Economics

With optimised intelligent control, the pressure of the compressed air can thus be reduced from an average of 8.2 to 6.9 bar, which corresponds to energy savings of 9.1 %. Optimising the control involves only minor costs and can generate savings in the range of several hundred MWh/yr, that is, tens of thousands of euros (e.g. with an installed compressor performance of 500 kW, savings of about 400 MWh/yr can be achieved and about EUR 20 000/yr can be achieved in the case of 8700 operational hours/year).

Driving force for implementation

Cost savings.

Example plants

The installation of a computerised compressor control system has reduced compressed air generation costs by 18.5 % at Land Rover (UK). The overall costs for the system produced a payback period of 16 months. Further savings of 20 % were also obtained by repairing compressed air leaks.

Reference information

[227, TWG, , 244, Best practice programme]

3.7.10 Storage of compressed air near high-fluctuating uses

Description

Tanks storing compressed air can be situated near parts of the CAS with highly fluctuating usage.

Achieved environmental benefits

Smooths out peaks in demand. By reducing peak demand, the system requires less compressor capacity. The loads are more evenly spread, and compressors can run at their most efficient loads.

Cross-media effects

No data submitted.

Operational data

No data submitted.

Applicability

- consider in all cases with areas of highly fluctuating demand
- widely used.

Economics.

Reduced capital and running costs.

Driving force for implementation

No data submitted.

Example plants

No data submitted.

Reference information

No data submitted.

3.8 Pumping systems

Introduction

Pumping systems account for nearly 20 % of the world's electrical energy demand and range from 25 to 50 % of the energy usage in certain industrial plant operations. Pumping systems are used widely in different sectors:

- industrial services, e.g.
- food processing
- chemicals
- petrochemical
- pharmaceutical
- commercial and agricultural services
- municipal water/waste water services
- domestic applications.

Pumps fall into two major groups described by the method for moving a fluid: *rotodynamic* pumps and *positive displacement* pumps. In industry, the majority are driven by electric motors but they can be driven by steam turbines in large industrial applications (or even by standalone reciprocating engines).

Rotodynamic pumps (usually centrifugal) are based on bladed impellers which rotate within the fluid to impart a tangential acceleration to the fluid and a consequent increase in the energy of the fluid. The purpose of the pump is to convert this energy into pressure energy of the fluid to be used in the associated piping system. After motors, centrifugal pumps are arguably the most common machine in the world, and they are a significant user of energy.

Positive displacement pumps cause a liquid to move by trapping a fixed amount of fluid and then forcing (displacing) that trapped volume into the discharge pipe. Positive displacement pumps can be further classified as either:

- a rotary type (e.g. the rotary vane pump). Common uses of vane pumps include high pressure hydraulic pumps, and in low vacuum applications, including evacuating refrigerant lines in air conditioners
- a reciprocating type (e.g. the diaphragm pump). Diaphragm pumps have good suction lift characteristics, some are low pressure pumps with low flowrates. They have good dry running characteristics and are low shear pumps (i.e. do not break up solid particles). They can handle high solid content liquids, such as sludges and slurries even with a high grit content. Diaphragm pumps with teflon diaphragms, ball check valves, and hydraulic actuators are used to deliver precise volumes of chemical solutions at high pressures (as much as 350 bar) into industrial boilers or process vessels. Diaphragm pumps can be used to provide oil-free air for medical, pharmaceutical and food-related purposes.

The energy and materials used by a pumping system depend on the design of the pump, the design of the installation and the way the system is operated. Centrifugal pumps are generally the cheapest option. Pumps may be used as single-stage, or multi-stage, e.g. to achieve higher/lower pressures. They are often paired as duty and standby pumps in critical applications.

3.8.1 Inventory and assessment of pumping systems

Description and Operational data

(The information on Achieved environmental benefits, Cross-media effects, Applicability, Economics, Driving forces for implementation, Examples, and Reference information for ENE techniques for pumping systems is given in Section 3.8.7)

The first step towards identifying applicable energy savings measures and optimising a pumping system is to establish an inventory of the pumping systems in the installation with the key operating characteristics. The inventory can be established in two phases (see Section 2.15.1 and Annex 7.7.3):

- basic system description: this consists of consulting company records or carrying out simple measurements, in order to assemble the following data:
- list of, e.g. the 50 largest pumps consuming energy (by total pump power rating): size and type
- function of each pumps
- power consumption of each of these pumps
- demand profile: estimated variation during day/week
- type of control system
- operating hours/year, and hence annual energy consumption
- problems or maintenance issues specific to the pump.

In many organisations, most or all of these data could be assembled by in-house staff.

- documentation and measurement of the system's operating parameters: documenting or measuring the following elements is desirable for all pumping systems, and is essential for large systems (over 100 kW). Collection of these data will require a significant level of technical expertise, either from in-house engineering staff or from a third party.

Because of the large variety of pumping systems, it is not possible to give a definitive list of points to look for in the assessment, but Sections 3.8.2 to 3.8.6 detail a useful list of key issues to address.

3.8.2 Pump selection

Description and Operational data

(The information on Achieved environmental benefits, Cross-media effects, Applicability, Economics, Driving forces for implementation, Examples, and Reference information for ENE techniques for pumping systems is given in Section 3.8.7)

The pump is the heart of the pumping system. Its choice is driven by the need of the process which could be, first of all, a static head and a flowrate. The choice also depends on the system, the liquid, the characteristic of the atmosphere, etc.

In order to obtain an efficient pumping system, the choice of the pump has to be done so as to have an operating point as close as possible to the best efficiency point as indicated in Figure 3.35.

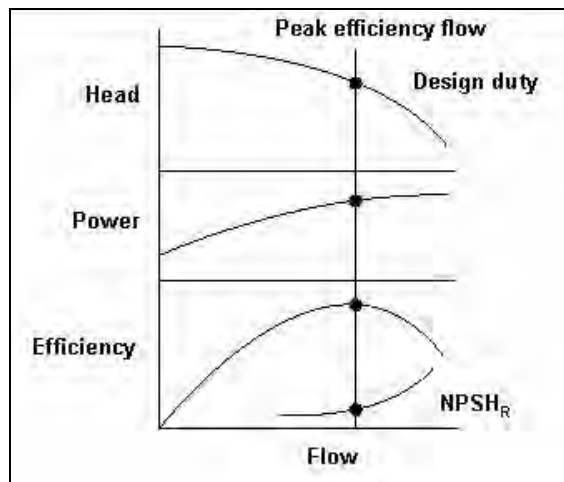

Figure 3.35: Peak efficiency flow vs. head, power and efficiency [199, TWG]

Figure 3.36 shows the ranges of total head as a function of the pump capacity for a given speed in different types of pumps.

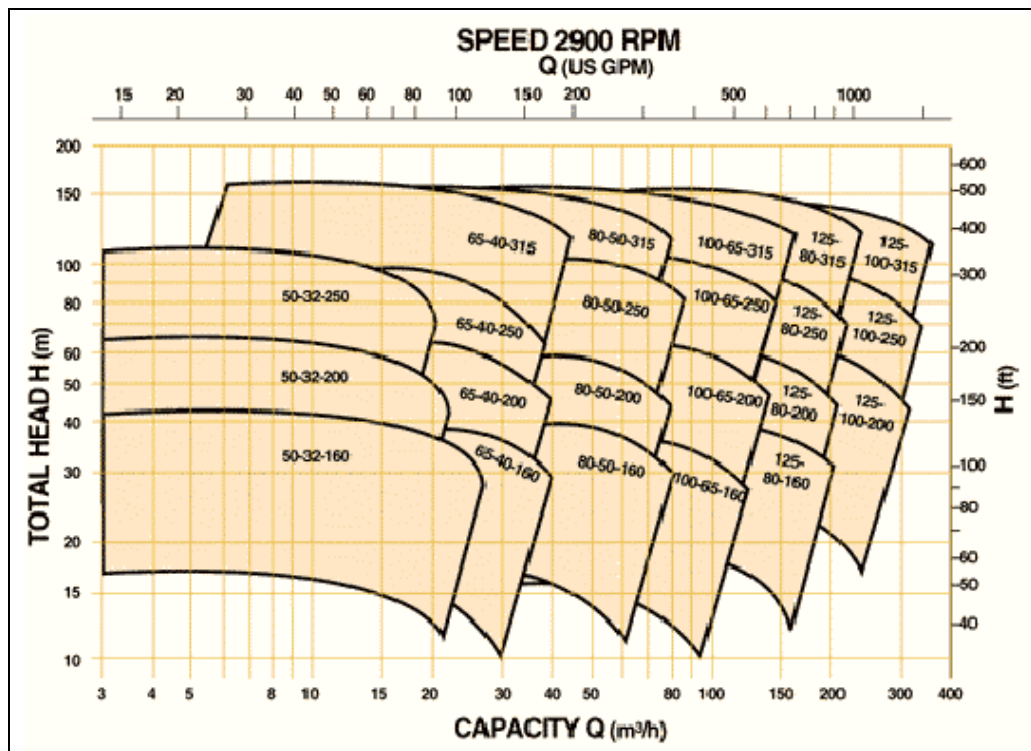

Figure 3.36: Pump capacity vs. head
[199, TWG]

It is estimated that 75% of pumping systems are oversized, many by more than 20%. Oversized pumps represent the largest single source of wasted pump energy.

When choosing a pump, oversizing is neither cost nor energy efficient as:

- the capital cost is high
- the energy cost is high because more flow is pumped at a higher pressure than required. Energy is wasted from excessive throttling, large bypassed flows, or operation of unnecessary pumps.

Where oversized pumps are identified, their replacement must be evaluated in relation to other possible methods to reduce capacity, such as trimming or changing impellers and/or using variable speed controls. Trimming centrifugal pump impellers is the lowest cost method to correct oversized pumps. The head can be reduced 10 to 50 per cent by trimming or changing the pump impeller diameter within the vendor's recommended size limits for the pump casing.

The energy requirements of the overall system can be reduced by the use of a booster pump to provide the high pressure flow to a selected user and allow the remainder of the system to operate at a lower pressure and reduced power.

The European Procurement Lines for water pumps provides a simple methodology for selecting a highly efficient pump with a high efficiency for the requested duty point. This methodology can be downloaded from:

http://re.jrc.ec.europa.eu/energyefficiency/motorchallenge/pdf/EU_pumpguide_final.pdf

3.8.3 Pipework system

Description and Operational data

(The information on Achieved environmental benefits, Cross-media effects, Applicability, Economics, Driving forces for implementation, Examples, and Reference information for ENE techniques for pumping systems is given in Section 3.8.7)

The pipework system determines the choice of the pump performance. Indeed, its characteristics have to be combined with those of the pumps to obtain the required performance of the pumping installation as shown in the Figure 3.37 below.

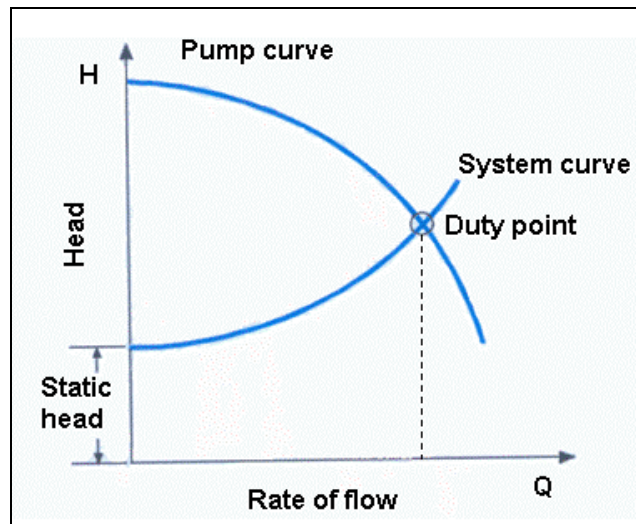

Figure 3.37: Pump head versus flowrate

The energy consumption directly connected to the piping system is the consequence of the friction loss on the liquid being moved, in pipes, valves, and other equipment in the system. This loss is proportional to the square of the flowrate. Friction loss can be minimised by means such as:

- avoiding the use of too many valves
- avoiding the use of too many bends (especially tight bends) in the piping system
- ensuring the pipework diameter is not too small.

3.8.4 Maintenance

Description and Operational data

(The information on Achieved environmental benefits, Cross-media effects, Applicability, Economics, Driving forces for implementation, Examples, and Reference information for ENE techniques for pumping systems is given in Section 3.8.7)

Excessive pump maintenance can indicate:

- pumps are cavitating
- badly worn pumps
- pumps that are not suitable for the operation.

Pumps throttled at a constant head and flow indicate excess capacity. The pressure drop across a control valve represents wasted energy, which is proportional to the pressure drop and flow.

A noisy pump generally indicates cavitation from heavy throttling or excess flow. Noisy control valves or bypass valves usually mean a high pressure drop with a correspondingly high energy loss.

Pump performance and efficiency deteriorates over time. Pump capacity and efficiency are reduced as internal leakage increases due to excessive clearances between worn pump components: backplate; impeller; throat bushings; rings; sleeve bearings. A monitoring test can detect this condition and help size a smaller impeller, either new, or by machining the initial one, to achieve a higher reduction in energy. Internal clearances should be restored if performance changes significantly.

Applying coatings to the pump, will reduce friction losses.

3.8.5 Pumping system control and regulation

Description and Operational data

(The information on Achieved environmental benefits, Cross-media effects, Applicability, Economics, Driving forces for implementation, Examples, and Reference information for ENE techniques for pumping systems is given in Section 3.8.7)

A pump application might need to cover several duty points, of which the largest flow and/or head will determine the rated duty for the pump. A control and regulation system is important in a pumping system so as to optimise the duty working conditions for the head pressure and the flow. It provides:

- process control
- better system reliability
- energy savings.

For any pump with large flow or pressure variations, when normal flows or pressures are less than 75 % of their maximum, energy is probably being wasted from excessive throttling, large bypassed flows (either from a control system or deadhead protection orifices), or operation of unnecessary pumps.

The following control techniques may be used:

- shut down unnecessary pumps. This obvious but frequently overlooked measure can be carried out after a significant reduction in the plant's use of water or other pumped fluid (hence the need to assess the whole system)
- variable speed drives (on the electric motor) yield the maximum savings in matching pump output to varying system requirements, but they do have a higher investment cost compared to the other methods of capacity control. They are not applicable in all situations, e.g. where loads are constant (see Section 3.6.3)
- multiple pumps offer an alternative to variable speed, bypass, or throttle control. The savings result because one or more pumps can be shut down when the flow of the system is low, while the other pumps operate at high efficiency. Multiple small pumps should be considered when the pumping load is less than half the maximum single capacity. In multiple pumping systems, energy is commonly lost from bypassing excess capacity, running unnecessary pumps, maintaining excess pressure, or having a large flow increment between pumps
- controlling a centrifugal pump by throttling the pump discharge (using a valve) wastes energy. Throttle control is, however, generally less energy wasteful than two other widely used alternatives: no control and bypass control. Throttles can, therefore, represent a means to save pump energy, although this is not the optimum choice.

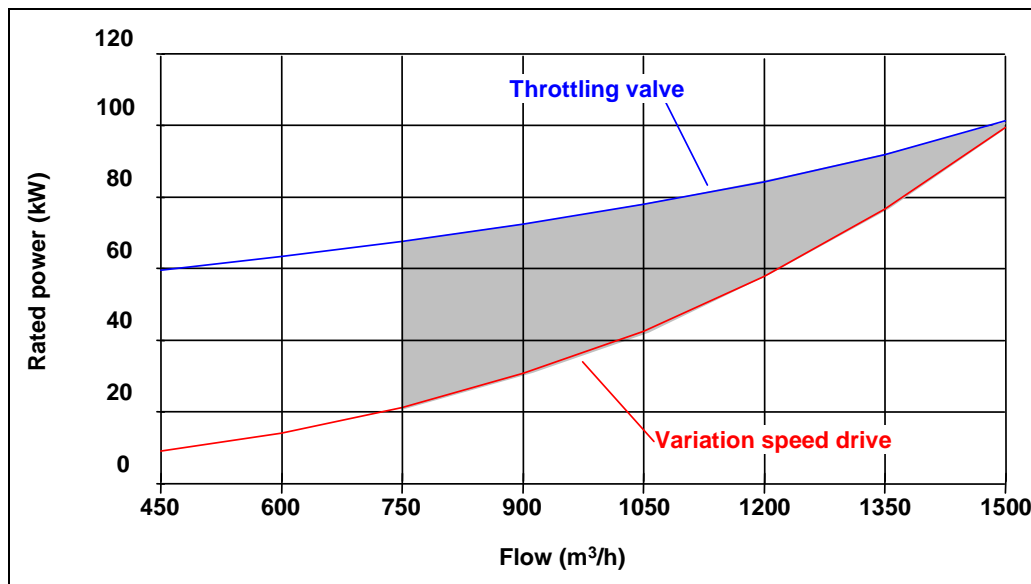

Figure 3.38: Example of energy consumption for two pumping regulation systems for a rotodynamic pump

3.8.6 Motor and transmission

See Electrical motor driven sub-systems, Section 3.6. Note that it is important to match the right pump for the task (see Section 3.8.2) to the correct size of motor for the pumping requirements (pumping duty), see Section 3.6.2.

3.8.7 Achieved environmental, Cross media effects, Applicability and other considerations for ENE techniques in pumping systems

Achieved environmental benefits

Some studies have shown that 30 to 50 % of the energy consumed by pumping systems could be saved through equipment or control system changes.

Cross-media effects

None reported.

Applicability

The applicability of particular measures, and the extent of cost savings depend upon the size and specific nature of the installation and system. Only an assessment of a system and the installation needs can determine which measures provide the correct cost-benefit. This could be done by a qualified pumping system service provider or by qualified in-house engineering staff.

The assessment conclusions will identify the measures that are applicable to a system, and will include an estimate of the savings, the cost of the measure, as well as the payback time.

Economics

Pumping systems often have a lifespan of 15 to 20 years, so a consideration of lifetime costs against initial (purchase) costs are important.

Pumps are typically purchased as individual components, although they provide a service only when operating as part of the system, so a consideration of the system is important to enable a proper assessment of the cost-benefit.

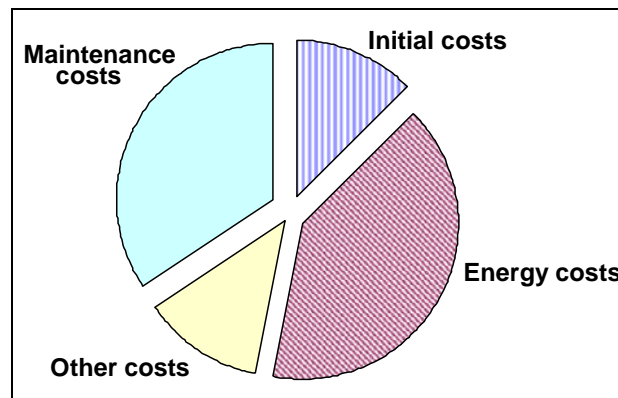

Figure 3.39: Typical life cycle costs for a medium sized industrial pump
[200, TWG]

Driving force for implementation

Energy and cost savings.

Examples

The optimisation techniques are widely used.

Reference information

[170, EC, 2003, 199, TWG, , 200, TWG]

3.9 Heating, ventilation and air conditioning (HVAC) systems

Introduction

A typical HVAC system comprises the heating or cooling equipment (for boilers, see Section 3.2; heat pumps, Section 3.3.2, etc.), pumps (Section 3.8) and/or fans, piping networks, chillers (Section 3.3.3) and heat exchangers (Section 3.3.1) transferring or absorbing heat from a space or a process. A scheme of an HVAC system is shown in Figure 3.40.

Studies have shown that about 60 % of the energy in an HVAC system is consumed by the chiller/heat pump and the remaining 40 % by peripheral machinery.

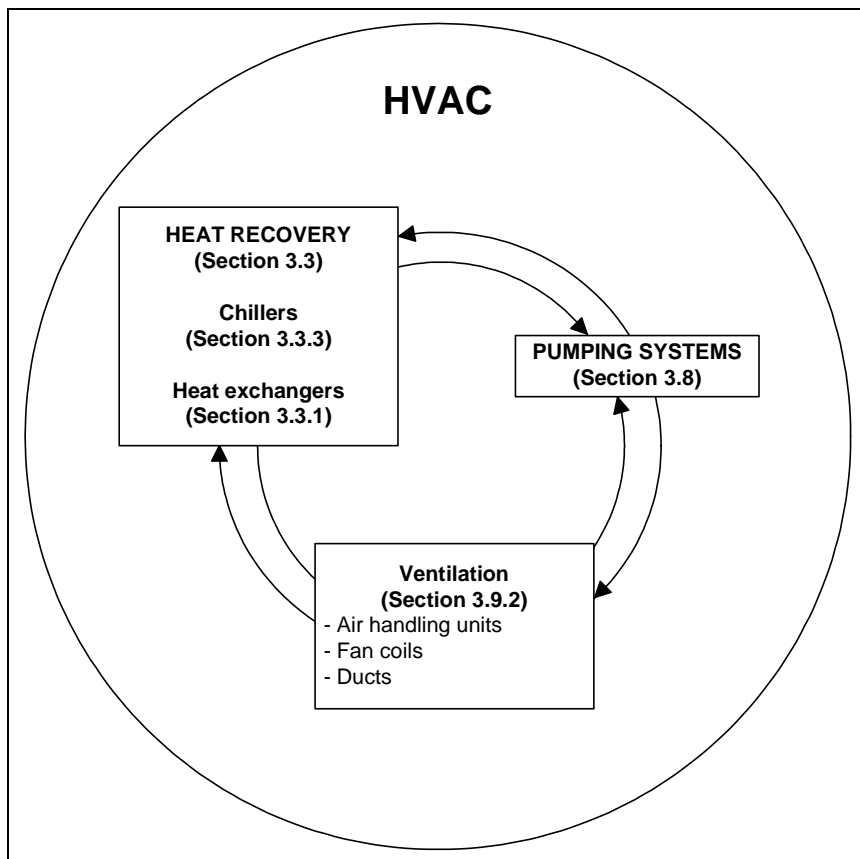

Figure 3.40: Scheme of an HVAC system

3.9.1 Space heating and cooling

Description

In IPPC installations there are a wide range of space heating and cooling activities. The application and use depend on the sector and the location in Europe, and are used:

- to maintain satisfactory working conditions
- to maintain product quality (e.g. cold rooms)
- to maintain input material quality and handling characteristics, e.g. enclosed waste storage areas in Scandinavia, prevention of corrosion on components treatment in surface treatment metal industries.

The systems can be localised (e.g. IR space heaters for equipment in storage areas) or centralised (e.g. air conditioning systems in offices).

The consumption of energy in space heating/cooling is considerable. For instance, in France it is about 30 TWh, representing nearly 10 % fuel consumption. It is quite common to have high heating temperatures in industrial buildings that could be easily reduced by 1 or 2 °C; conversely, when cooling, it is common to have temperatures that could be increased by 1 or 2 °C without degrading the comfort. These measures imply a change for the employees and they should be implemented with an information campaign.

Energy savings can be achieved in two ways:

- reducing the heating/cooling needs by:
- building insulation
- efficient glazing
- air infiltration reduction
- automatic closure of doors
- destratification
- lower temperature settings during non-production periods (programmable regulation)
- reducing set point
- improving the efficiency of heating systems through:
- recovery or use of waste heat (see Section 3.3)
- heat pumps
- radiative and local heating systems coupled with reduced temperatures in the unoccupied areas of the buildings.

Achieved environmental benefits

No data submitted.

Cross-media effects

No data submitted.

Operational data

To lower the temperature set point of 1°C for heating, and raising it by 1°C for air conditioning can reduce energy consumption about 5 – 10 %, depending on the average temperature difference between indoors and outdoors. Generally, raising air conditioning temperatures saves more, as the temperature differentials are generally higher. These are generalisations, and the actual savings will vary according to climate, on a regional basis.

Limiting heating/cooling during non- production periods can save 40 % of electrical consumption for a plant working on an 8 hours per day basis. Limiting heating coupled with a permanent reduced temperature in unoccupied areas and local radiative heating in occupied areas, can generate nearly 80 % energy savings depending on the percentage of occupied areas.

Applicability

Temperatures may be set by other criteria, e.g. regulatory minimum temperatures for staff, maximum temperatures to maintain product quality for food.

Economics

No data submitted.

Driving force for implementation

No data submitted.

Examples

No data submitted.

Reference information

[278, ADEME], [234, PROMOT, , 260, TWG, 2008]

3.9.2 Ventilation

Introduction

A ventilation system is essential for many industrial installations to function well. It:

- protects staff from pollutant and heat emissions within premises
- maintains a clean working atmosphere to protect product quality.

A ventilation plant is a system consisting of many interacting parts (see Figure 3.41). For instance:

- the air system (intake, distributor, transport network)
- the fans (fans, motors, transmission systems)
- the ventilation control and regulation systems (flow variation, centralised technical management (CTM), etc.)
- energy recovery devices
- air cleaners
- and the different types of ventilation system chosen (general ventilation, specific ventilation, with or without air conditioning, etc.).

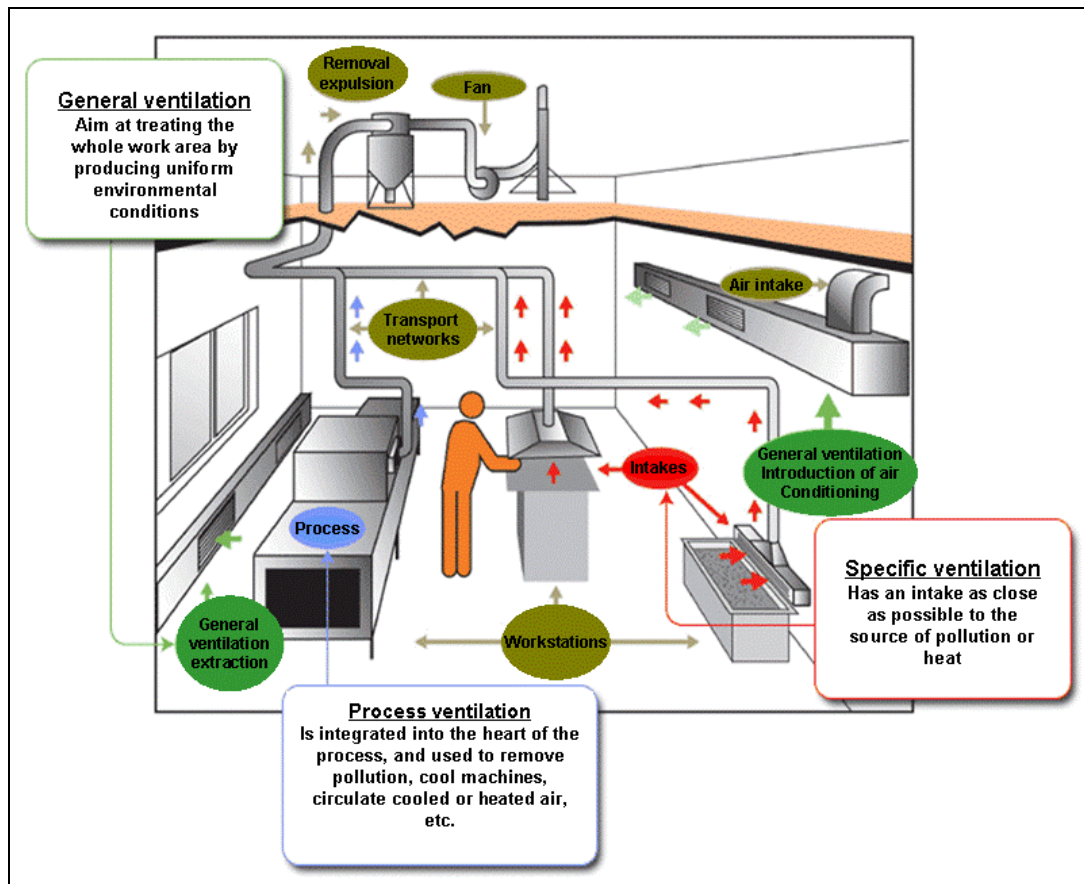

Figure 3.41: Ventilation system

3.9.2.1 Design optimisation of a new or upgraded ventilation system

Description

Having a clear idea of the requirements for a ventilation system helps to make the right choices and to decide on the right design. These may be:

- clean air intake
- maintenance of environmental conditions (temperature, pressure, humidity, etc.), for either improving comfort and health within working areas or for product protection
- transportation of materials
- extraction of smoke, dust, humidity and/or hazardous products.

The flow diagram shown in Figure 3.42 can assist in determining the most suitable energy efficiency options for a particular situation:

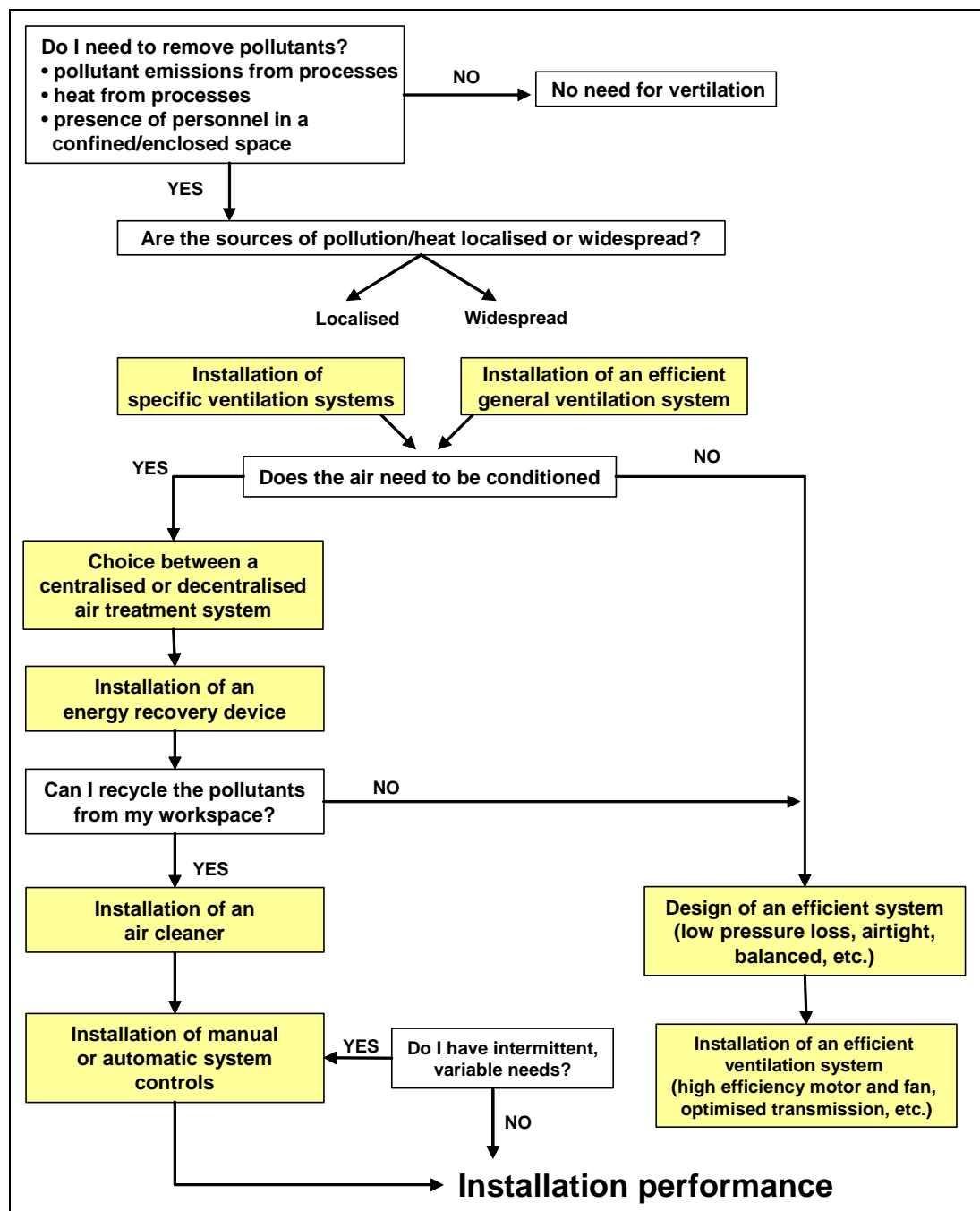

Figure 3.42: Flow diagram to optimise energy use in ventilation systems

Interactions and their relative effects, particularly between the fan and the air duct system, can account for a high percentage of the losses in a given circuit. A coherent approach must therefore be used to design a system that meets both functional specifications and optimal energy efficiency requirements.

The following types of ventilation system can be used, see Figure 3.41:

- *general ventilation*: these systems are used to change the air in large volume working areas. Several types of clean air ventilation systems are possible, depending on the premises to be ventilated, the pollution, and whether or not air conditioning is required. Airflow is a major element influencing energy consumption. The lower the flowrate, the lower the energy consumption
- *specific ventilation*: these ventilation systems are designed to remove emissions as close as possible to the source. Unlike general ventilation systems, they are directed at localised pollutant emissions. These systems have the advantage of capturing pollutants as soon as they are emitted, using specific intakes, and preventing them from being propagated throughout the work area. They have the following advantages:
 - preventing any contact with their operators
 - avoiding the renewal of all the air in the work area.

In both cases, extracted air may require treatment prior to discharge to the atmosphere (see the CWW BREF).

Achieved environmental benefits

It is estimated that 10 % of the electricity consumption in companies is by ventilation systems. Where there is also air conditioning, ventilation and air conditioning can take up an even larger share of the corporate energy budget.

Cross-media effects

None reported.

Operational data

- *fans*: fans are the principal source of electricity consumption in the installation. Their type, size and controls are major factors from the point of view of energy. Note: choosing a high efficiency fan of the correct size may mean that a smaller fan can be chosen and savings on the purchase price can be obtained. When designing or modifying an installation, key issues are:
 - a fan with a high efficiency rating: the maximum efficiency of fans is generally between 60 and 85 % depending on the type of fan. Manufacturers are developing ranges of even more efficient fans
 - a fan designed to operate as close as possible to its optimal rate: with a single fan, efficiency can vary according to its operating rate. It is therefore essential to choose the correct size of fan for the installation, so that it operates as close as possible to maximum efficiency
- *the air system*: the design of an air system must meet certain conditions in order to be energy efficient:
 - ducts must be sufficiently large in diameter (a 10 % increase in diameter can produce a 72 % reduction in the power absorbed)
 - circular ducts, which offer less pressure loss, are better than rectangular ducts of an equal section
 - avoid long runs and obstacles (bends, narrower sections, etc.)

- check that the system is airtight, particularly at joints
- check that the system is balanced at the design stage, to make sure all 'users' receive the necessary ventilation. Balancing the system after it has been installed means that single leaf dampers have to be installed in some ducts, increasing losses in pressure and energy
- *electric motors (and coupling with fans)*: choose the correct type and size of motor (see electric motor driven sub-systems in Section 3.6)
- *managing airflow*: airflow is a basic parameter when it comes to energy consumption by ventilation systems. For example: for a 20% reduction in flow, 50% less power is consumed by the fan. Most ventilation installations do not have to operate constantly at their maximum rate. So it is important to be able to adjust the fan operating speed in accordance with, e.g:
 - production (quantity, product type, machine on/off, etc.)
 - period (year, month, day, etc.)
 - human occupation of the work area

It is essential to analyse needs using presence detectors, a clock, and process-driven controls, and to design a controlled ventilation installation.

'Dual flow' ventilation, which combines blowing (the intake of fresh air) with extraction (the removal of polluted air), provides better airflow control and is more easily controlled, e.g. by a process air conditioning and energy recovery management system. Installing automatic controls can provide a method of controlling the ventilation system using various (measured, defined, etc.) parameters and optimising its operation at all times.

There are many techniques for varying airflow in line with demand, but they are not all equally energy efficient:

- electronic speed controls can be used to adapt the rate of operation of fans whilst optimising energy consumption by the motor, producing significant energy savings
- changing the blade angle of propeller fans also provides substantial energy savings
- *energy recovery system*: when ventilated premises have an air conditioning system, the renewed air needs to be reconditioned, which consumes large amounts of energy. Energy recovery systems (exchangers) can be used to recover some of the energy contained in the polluted air expelled from the work area. When choosing an energy recovery system, check the following three parameters:
 - thermal efficiency
 - pressure loss
 - behaviour when fouled
- *air filtering*: an air filter allows the air in the ventilated premises to be re-used. The flow of air to be renewed and reconditioned is thereby reduced, providing significant energy savings. Opting for an air filter when the ventilation installation is designed is advisable because the extra cost at that stage will be relatively small compared with its installation at a later stage. It is essential to check that the pollutants that remain can be recycled. Where this solution is possible, it is important to know the following parameters:
 - recycling efficiency
 - pressure loss
 - behaviour when filter is fouled

To improve the operation of an existing installation; see Section 3.9.2.2.

Applicability

Applicable to all new systems or when upgrading.

Economics

In most audited installations, potential energy savings of up to 30 % of consumption have been detected. There are many possible actions giving a return on investment often within 3 years.

Driving force for implementation

- health and safety conditions at work
- cost savings
- product quality.

Examples

Widely used.

Reference information

[202, IFTS_CMI, 1999]

3.9.2.2 Improving an existing ventilation system within an installation

Description

Note that improving ventilation system efficiency sometimes also brings improvements in:

- the comfort and safety of personnel
- product quality.

An existing ventilation system can be improved at three levels:

- optimising the operation of the installation
- introducing a maintenance and monitoring plan for the installation
- investment in more efficient technical solutions.

Achieved environmental benefits

Energy saved after optimising all the parameters of the ventilation system will produce, on average, a reduction in the order of 30 % of the energy bill associated with its operation.

Cross-media effects

None reported.

Operational data

Energy diagnosis (comprehensive audit)

Knowing the installation is an essential precursor to improving its performance. A diagnosis of the installation enables the following:

- evaluation of the performance of the ventilation system
- determination of the costs involved in producing compressed air
- detection of any malfunctions
- selection of a new installation of the correct size.

Installation maintenance and monitoring

The energy consumption of a ventilation system increases over time for an identical service. To maintain its efficiency, it is necessary to monitor the system and when necessary carry out maintenance operations, which will produce substantial energy savings whilst increasing the lifetime of the system. These operations may consist of:

- conducting leak detection and repair campaigns on the air duct system
- changing filters regularly, particularly in the air cleaning devices, because:
 - loss of pressure increases very rapidly with a worn out filter
 - the filter's efficiency at removing particles deteriorates over time
- checking compliance with health and safety standards associated with pollutant removal
- measuring and recording regularly the key values for the installation (electricity consumption and pressure loss in devices, airflow).

Operation

- immediate action:
 - stop or reduce ventilation where possible. The energy consumption of a ventilation installation is directly linked to rate of airflow. Airflow is determined by:
 - the presence of operators
 - the number of sources of pollution and types of pollutants
 - the rate and distribution of each source of pollution
 - replace clogged filters
 - fix leaks in the air system
 - if the air is conditioned, check settings and ensure they suit specific needs
- simple, effective action:
 - equip workstations with appropriate specific intakes
 - optimise the number, shape and size of the pollutant intakes to reduce (as much as possible) the airflow necessary for removing pollutants (see the STM BREF)
 - consider regulating ventilation flow automatically according to actual need. There are many possible ways of controlling this regulation:
 - having ventilation automatically controlled by a machine when it stops and starts (most of the time this function is provided by machine tools or welding torches fitted with a vacuum)
 - having ventilation automatically triggered by pollution emissions. For example, putting a part into a treatment bath changes the rate of pollution emissions. Ventilation can, in this case, be accelerated when parts are immersed and reduced the rest of the time
 - closing baths or tanks when not in use, manually or automatically (see the STM BREF)

Note that where flow is regulated, it will be necessary to check that the health conditions are still correct in all conditions of operation.

- air duct systems must be balanced to prevent over-ventilation at certain points. Balancing can be carried out by a specialist company
- cost-effective action:
 - fit fans where there is a variable flow with an electronic speed control (ESC)
 - install high efficiency fans
 - install fans with an optimum operating rate that suits the specific needs of the installation
 - install high efficiency motors (e.g. labelled EFF1)
 - integrate the management of the ventilation system into a centralised technical management system (CTM)
 - introduce measurement instrumentation (flow meters, electricity meters) to monitor the operation of the installation
 - investigate the possibility of integrating air filters into the air duct system and energy recovery devices to avoid large energy losses when expelling polluted air
 - investigate the possibility of modifying the whole ventilation system and breaking it down into general ventilation, specific ventilation and process ventilation.

Applicability

Applicable to all existing systems.

Economics

In most audited installations, potential energy savings of up to 30 % consumption have been detected. There are many possible actions giving a return on investment often within two years.

Driving force for implementation

- health and safety conditions at work
- cost savings
- product quality.

Examples

Widely used.

Reference information

[202, IFTS_CMI, 1999]

3.9.3 Free cooling

Description

Cooling, both for industrial processes and/or air conditioning, can be enhanced from an energy efficiency point of view by adopting *free cooling* techniques. Free cooling takes place when the external ambient air enthalpy is less than the indoor air enthalpy. It is *free* because it makes use of ambient air.

This free contribution can be transferred to the system needing cooling either directly or indirectly. Normally indirect methods are used in practice. They consist, in general, of extraction-recirculation air systems (see Figure 3.43). The regulation is done by automatic modulating valves: when cool outside air is available (i.e. when the outside wet bulb temperature drops below the required chilled water set point), valves automatically increase the intake of the cool air, reducing at the same time the internal recirculation to a minimum to maximise the use of the free cooling. By using techniques such as this, refrigeration equipment is partially avoided in certain seasons of the year and/or during the night. There are various technical possibilities to take advantage of free cooling. In Figure 3.43, a possible simple plant adopting free cooling is shown.

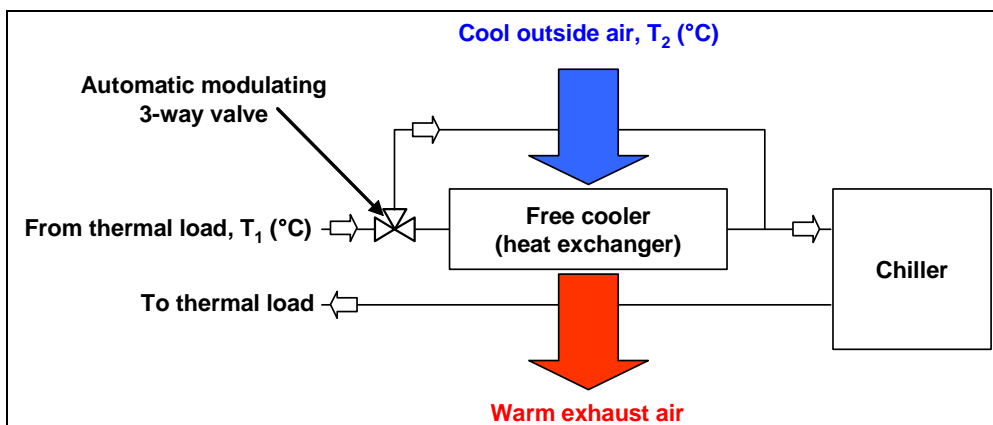

Figure 3.43: Possible scheme for the implementation of free cooling

The water returning from the thermal load, and directed to the chiller, is automatically diverted by the 3-way valve to the free cooler. Here, the water is precooled, and this reduces the thermal load on the chiller and the energy consumed by the compressors. The more the ambient temperature drops under the return water temperature, the greater the free cooling effect and the greater the energy savings.

Achieved environmental benefits

Normally chillers are driven by electric motors, and sometimes by endothermic drives, so there is less consumption of primary energy resources.

Cross-media effects

None known.

Operational data

Free cooling is best considered when the ambient temperature is at least 1 °C below the temperature of water coming from the thermal load, i.e. entering the chiller. For example, in Figure 3.43, if T_1 (temperature of water returning from the thermal load) is 11 °C, free cooling can be activated when T_2 (outside air temperature) drops under 10 °C.

Applicability

Free cooling is applicable in specific circumstances: for indirect transferring, ambient air temperature must be below the temperature of refrigerant fluid returning to the chiller; for direct uses, the outside air temperature must be below or equal the required temperature. Possible extra space for the equipment must also be taken into account.

It is estimated that it is applicable in 25 % of cases.

Free cooling exchangers can be retrofitted to existing chilled water systems and/or incorporated into new ones.

Economics

Adoption of free cooling techniques involves a series of economic advantages, such as: the source of cold is free, a reduction of running time of compressors with consequential energy savings in terms of kWh no longer used from the electrical network, a reduction of electric power supply cost.

It is usually better to investigate the use of free cooling during the project planning for a new or upgraded system. Payback for a new system could be as little as 12 months; payback for retrofitting units is up to 3 years.

Driving force for implementation

- simplicity of installation
- energy and money savings.

Examples

Widely used.

Reference information

[240, Hardy, , 241, Coolmation]

3.10 Lighting

Description

Artificial lighting accounts for a significant part of all electrical energy consumed worldwide. In offices, from 20 to 50 per cent of the total energy consumed is due to lighting. Most importantly, for some buildings over 90 per cent of lighting energy consumed can be an unnecessary expense through over-illumination. Thus, lighting represents a critical component of energy use today, especially in large office buildings and for other large scale uses where there are many alternatives for energy utilisation in lighting.

There are several techniques available to minimise energy requirements in any building:

a) identification of lighting requirements for each area

This is the basic concept of deciding how much lighting is required for a given task. Lighting types are classified by their intended use as general, localised, or task lighting, depending largely on the distribution of the light produced by the fixture. Clearly, much less light is required for illuminating a walkway compared to that needed for a computer workstation. Generally speaking, the energy expended is proportional to the design illumination level. For example, a lighting level of 800 lux might be chosen for a work environment encompassing meeting and conference rooms, whereas a level of 400 lux could be selected for building corridors:

- general lighting is intended for the general illumination of an area. Indoors, this would be a basic lamp on a table or floor, or a fixture on the ceiling. Outdoors, general lighting for a parking area may be as low as 10 – 20 lux since pedestrians and motorists already accustomed to the dark will need little light for crossing the area
- task lighting is mainly functional and is usually the most concentrated, for purposes such as reading or inspection of materials. For example, reading poor quality print products may require task lighting levels up to 1500 lux, and some inspection tasks or surgical procedures require even higher levels.

b) analysis of lighting quality and design

- the integration of space planning with interior design (including choice of interior surfaces and room geometries) to optimise the use of natural light. Not only will greater reliance on natural light reduce energy consumption, but will favourably impact on human health and performance
- planning activities to optimise the use of natural light
- consideration of the spectral content required for any activities needing artificial light
- selection of fixtures and lamp types that reflect best available techniques for energy conservation.

Types of electric lighting include:

- *incandescent light bulbs*: an electrical current passes through a thin filament, heating it and causing it to become excited, releasing light in the process. The enclosing glass bulb prevents the oxygen in air from destroying the hot filament. An advantage of incandescent bulbs is that they can be produced for a wide range of voltages, from just a few volts up to several hundred. Because of their relatively poor luminous efficacy, incandescent light bulbs are gradually being replaced in many applications by fluorescent lights, high intensity discharge lamps, light-emitting diodes (LEDs), and other devices

- *arc lamps or gas discharge lamps*: an arc lamp is the general term for a class of lamps that produce light by an electric arc (or voltaic arc). The lamp consists of two electrodes typically made of tungsten which are separated by a gas. Typically, such lamps use a noble gas (argon, neon, krypton or xenon) or a mixture of these gases. Most lamps contain additional materials, such as mercury, sodium, and/or metal halides. The common fluorescent lamp is actually a low pressure mercury arc lamp where the inside of the bulb is coated with a light emitting phosphor. High intensity discharge lamps operate at a higher current than the fluorescent lamps, and come in many varieties depending on the material used. Lightning could be thought of as a type of natural arc lamp, or at least a flash lamp. The type of lamp is often named by the gas contained in the bulb including neon, argon, xenon, krypton, sodium, metal halide, and mercury. The most common arc or gas discharge lamps are:
 - fluorescent lamps
 - metal halide lamps
 - high pressure sodium lamps
 - low pressure sodium lamps.

The electric arc in an arc or gas discharge lamp consists of gas which is initially ionised by a voltage and is therefore electrically conductive. To start an arc lamp, usually a very high voltage is needed to 'ignite' or 'strike' the arc. This requires an electrical circuit sometimes called an 'igniter', which is part of a larger circuit called the 'ballast'. The ballast supplies a suitable voltage and current to the lamp as its electrical characteristics change with temperature and time. The ballast is typically designed to maintain safe operating conditions and a constant light output over the life of the lamp. The temperature of the arc can reach several thousand degrees Celsius. An arc or gas discharge lamp offers a long life and a high light efficiency, but is more complicated to manufacture, and requires electronics to provide the correct current flow through the gas

- *sulphur lamps*: the sulphur lamp is a highly efficient full spectrum electrodeless lighting system whose light is generated by sulphur plasma that has been excited by microwave radiation. With the exception of fluorescent lamps, the warm-up time of the sulphur lamp is notably shorter than for other gas discharge lamps, even at low ambient temperatures. It reaches 80 % of its final luminous flux within twenty seconds (video), and the lamp can be restarted approximately five minutes after a power cut
- *light emitting diodes, including organic light emitting diodes (OLEDs)*: a light emitting diode (LED) is a semiconductor diode that emits incoherent narrow spectrum light. One of the key advantages of LED-based lighting is its high efficiency, as measured by its light output per unit of power input. If the emitting layer material of an LED is an organic compound, it is known as an organic light emitting diode (OLED). Compared with regular LEDs, OLEDs are lighter, and polymer LEDs can have the added benefit of being flexible. Commercial application of both types has begun, but applications at an industrial level are still limited.

Different types of lights have vastly differing efficiencies as shown in Table 3.27 below.

Name	Optical spectrum	Nominal efficiency (lm/W) ⁽¹⁾	Lifetime (Mean time between failures, MTBF) (hours)	Colour temperature ⁽²⁾ (kelvin)	Colour	Colour rendering index ⁽⁴⁾
Incandescent light bulb	Continuous	12 - 17	1000 - 2500	2700	Warm white (yellowish)	100
Halogen lamp	Continuous	16 - 23	3000 - 6000	3200	Warm white (yellowish)	100
Fluorescent lamp	Mercury line + phosphor	52 - 100	8000 - 20000	2700 - 5000	White (with a tinge of green)	15 - 85
Metal halide lamp	Quasi-continuous	50 - 115	6000 - 20000	3000 - 4500	Cold white	65 - 93
High pressure sodium	Broadband	55 - 140	10000 - 40000	1800 - 2200 ⁽³⁾	Pinkish orange	0 - 70
Low pressure sodium	Narrow line	100 - 200	18000 - 20000	1800 ⁽³⁾	Yellow, virtually no colour rendering	0
Sulphur lamp	Continuous	80 - 110	15000 - 20000	6000	Pale green	79
Light emitting diodes		20 - 40	100000		(Amber and red light)	
		10 - 20			(Blue and green light)	
		10 - 12		(White)		

(1) 1 lm = 1 cd·sr = 1 lx·m² (2) Colour temperature is defined as the temperature of a black body emitting a similar spectrum. (3) these spectra are quite different from those of black bodies. (4) The colour rendering index (CRI) is a measure of the ability of a light source to reproduce the colours of various objects being lit by the source.

Table 3.27: Characteristics and efficiency of different light types

The most efficient source of electric light is the low pressure sodium lamp. It produces an almost monochromatic orange light, which severely distorts colour perception. For this reason, it is generally reserved for outdoor public lighting usages. Low pressure sodium lights generate light pollution that can be easily filtered, contrary to broadband or continuous spectra.

Data on options, such as types of lighting, are available via the Green Light Programme. This is a voluntary prevention initiative encouraging non-residential electricity consumers (public and private), referred to as 'Partners', to commit to the European Commission to install energy efficient lighting technologies in their facilities when (1) it is profitable, and (2) lighting quality is maintained or improved.

c) management of lighting

- emphasise the use of lighting management control systems including occupancy sensors, timers, etc. aiming at reducing lighting consumption
- training of building occupants to utilise lighting equipment in the most efficient manner
- maintenance of lighting systems to minimise energy wastage.

Achieved environmental benefits

Energy savings.

Cross-media effects

Certain types of lamps, e.g. mercury vapour, fluorescent, contain toxic chemicals such as mercury or lead. At the end of their useful life, lamps must be recycled or disposed of correctly.

Operational data

It is valuable to provide the correct light intensity and colour spectrum for each task or environment. If this is not the case, energy could not only be wasted but over-illumination could lead to adverse health and psychological effects such as headache frequency, stress, and increased blood pressure. In addition, glare or excess light can decrease worker efficiency. Artificial nightlighting has been associated with irregular menstrual cycles.

To assess effectiveness, baseline and post-installation models can be constructed using the methods associated with measurement and verification (M&V) options A, B, C and D described in Table 3.28.

M&V option	How savings are calculated	Cost
Option A: Focuses on physical assessment of equipment changes to ensure the installation is to specification. Key performance factors (e.g. lighting wattage) are determined with spot or short term measurements and operational factors (e.g. lighting operating hours) are stipulated based on the analysis of historical data or spot/short term measurements. Performance factors and proper operation are measured or checked yearly	Engineering calculations using spot or short term measurements, computer simulations, and/or historical data	Dependent on number of measurement points. Approx. 1 – 5 % of project construction cost
Option B: Savings are determined after project completion by short term or continuous measurements taken throughout the term of the contract at device or system level. Both performance and operations factors are monitored	Engineering calculations using metered data	Dependent on number and type of systems measured and the term of analysis/metering. Typically 3 - 10 % of project construction cost
Option C: After project completion, savings are determined at whole building or facility level using the current year and historical utility meter or sub-meter data	Analysis of utility meter (or sub-meter) data using techniques from simple comparison to multivariate (hourly or monthly) regression analysis	Dependent on number and complexity of parameters in analysis. Typically 1 - 10 % of project construction cost
Option D: Savings are determined through simulation of facility components and/or the whole facility	Calibrated energy simulation/modelling; calibrated with hourly or monthly utility billing data and/or end-use metering	Dependent on number and complexity of systems evaluated. Typically 3 – 10 % of project construction cost

Table 3.28: Savings achievable from lighting systems

The only section of the protocol which is relevant to lighting is reproduced in this section. For more information, the entire protocol can be downloaded from <http://www.evo-world.org/>.

Applicability

Techniques such as the identification of illumination requirements for each given use area, planning activities to optimise the use of natural light, selection of fixture and lamp types according to specific requirements for the intended use, and management of lighting are applicable to all IPPC installations. Other measurements such as the integration of space planning to optimise the use of natural light are only applicable to new or upgraded installations.

Economics

The Green Light investments use proven technology, products and services which can reduce lighting energy use from between 30 and 50 %, earning rates of return of between 20 and 50 %.

Payback can be calculated using techniques in the ECM REF.

Driving force for implementation

- health and safety at work
- energy savings.

Examples

Widely used.

Reference information

[209, Wikipedia, , 210, EC, 2000] [210, EC, 2000, 238, Hawken, 2000, 242, DiLouie, 2006]
[211, ADEME, 1997, 212, BRE_UK, 1995, 213, EC, , 214, EC, 1996, 215, Initiatives, 1993, 216, Initiatives, 1995, 217, Piemonte, 2001, 218, Association, 1997, 219, IDAE]

3.11 Drying, separation and concentration processes

Introduction

Drying is an energy intensive process. It is considered here with separation and concentration techniques, as the use of different techniques or combinations offer energy savings.

Heat may be transferred by convection (direct dryers), by conduction (contact or indirect dryers), by thermal radiation such as infrared, microwave or high frequency electromagnetic field (radiative dryers) or by a combination of these. Most industrial dryers are of the convective type with hot air or direct combustion gases as the drying medium.

Separation is a process which transforms a mixture into at least two streams (which may be product-product or product-waste streams) which are different in composition. The separation technology consists, therefore, in partitioning and isolating the wanted products from a mixture containing either different substances or a pure substance in several phases or sizes. Alternatively, it may be used to separate waste streams, see the CWW BREF).

The separation process takes place in a separation device with a separation gradient applied by a separating agent. In this section, the separation methods have been classified according to the different principles of separation and separating agents used.

The purpose of this section is not to describe exhaustively every separation technique, but to focus mainly on those issues which have a higher potential for energy savings. For further details of a particular method, see the Reference information.

Classification of the separation methods:

- input of energy into the system:
detailed classification for these techniques can be structured considering the different types of energy provided to the system as listed below:
 - heat (vaporisation, sublimation, drying)
 - radiation
 - pressure (mechanical vapour recompression)
 - electricity (electrofiltration of gases, electro dialysis)
 - magnetism (use of magnets) (see ferrous and non-ferrous metals, EFS for non-metals)
 - kinetic (centrifugal separation) or potential energy (decantation)

- withdrawal of energy out of the system:
 - cooling or freezing (condensation, precipitation, crystallisation, etc.)
- mechanical barriers:
 - filters or membranes (nano, ultra or microfiltration, gas permeation, sieving)
- others:
 - physico-chemical interactions (solution/precipitation, adsorption, flotation, chemical reactions)
 - differences in other physical or chemical properties of the substances such as density, polarity, etc.

Combination of the previously mentioned principles of separation or separating agents may be used in several processes leading to hybrid separating techniques. Examples are:

- distillation (vaporisation and condensation)
- pervaporation (vaporisation and membrane)
- electro dialysis (electric field and ion-exchange membrane)
- cyclonic separation (kinetic energy and potential energy).

3.11.1 Selecting the optimum technology or combination of technologies

Description

Selecting a separation technology often has more than one solution. The choice depends on the characteristics of the feed and the required outputs and other constraints linked to the type of plant and sector. The separation process also has its own constraints. Technologies can be used in stages, e.g. two or stages of the same technology or combinations of different technologies.

Achieved environmental benefits

Minimising energy usage. A significant amount of energy can be saved where it is possible to use two or more separation stages or pretreatments (see Examples, below).

Cross-media effects

None reported.

Operational data

Some factors related to either the feed material, the final product or the process which should be considered before selecting a separation technique, are:

- feed material:
 - type, shape:
 - liquid
 - pasty
 - granular, powdery
 - fibrous
 - plane
 - belt
 - already in shape
 - mechanical fragility
 - thermosensitivity
 - moisture content
 - flowrate/quantity to be treated
 - if applicable:
 - shape and size

- size of droplets
- viscosity
- final product specifications:
 - moisture content
 - shape and size
 - quality:
 - colour
 - oxidation
 - taste
- process:
 - batch/continuous
 - heat sources:
 - fossil fuels (natural gas, fuel, coal, etc.)
 - electricity
 - renewable (solar, wood, etc.)
 - heat transfer through:
 - convection (hot air, superheated steam)
 - conduction
 - thermal radiation (radiant energies: infrared, microwaves, high frequency)
 - maximum temperature
 - capacity
 - residence time
 - mechanical action on the product.

A feasibility study is necessary to define the best solution(s) from a technical, economic, energy, and environmental point of view. Requirements should be precisely defined:

- feed and product parameters (mass and flow characteristics), especially the moisture content of the product: the last moisture percentages are usually the more difficult to dry and so are the most energy consuming
- list of all the utilities available (electricity, refrigeration, compressed air, steam, other cold or hot sources) and their characteristics
- available possible space
- possible pretreatment
- waste heat recovery potential of the process
- high energy efficiency utilities equipment and sources (high efficiency motors, use of waste heat, etc.).

A comparative analysis of the proposals has to be made on a technical, economic, energy, and environmental basis:

- within the same boundaries, including utilities, effluent treatment, etc.
- taking into account each environmental impact (air, water, waste, etc.)
- taking into account maintenance and security
- quantifying the time and cost of training of the operators.

The energy consumption of some separation processes indicated for several sizes of species is shown in Figure 3.44.

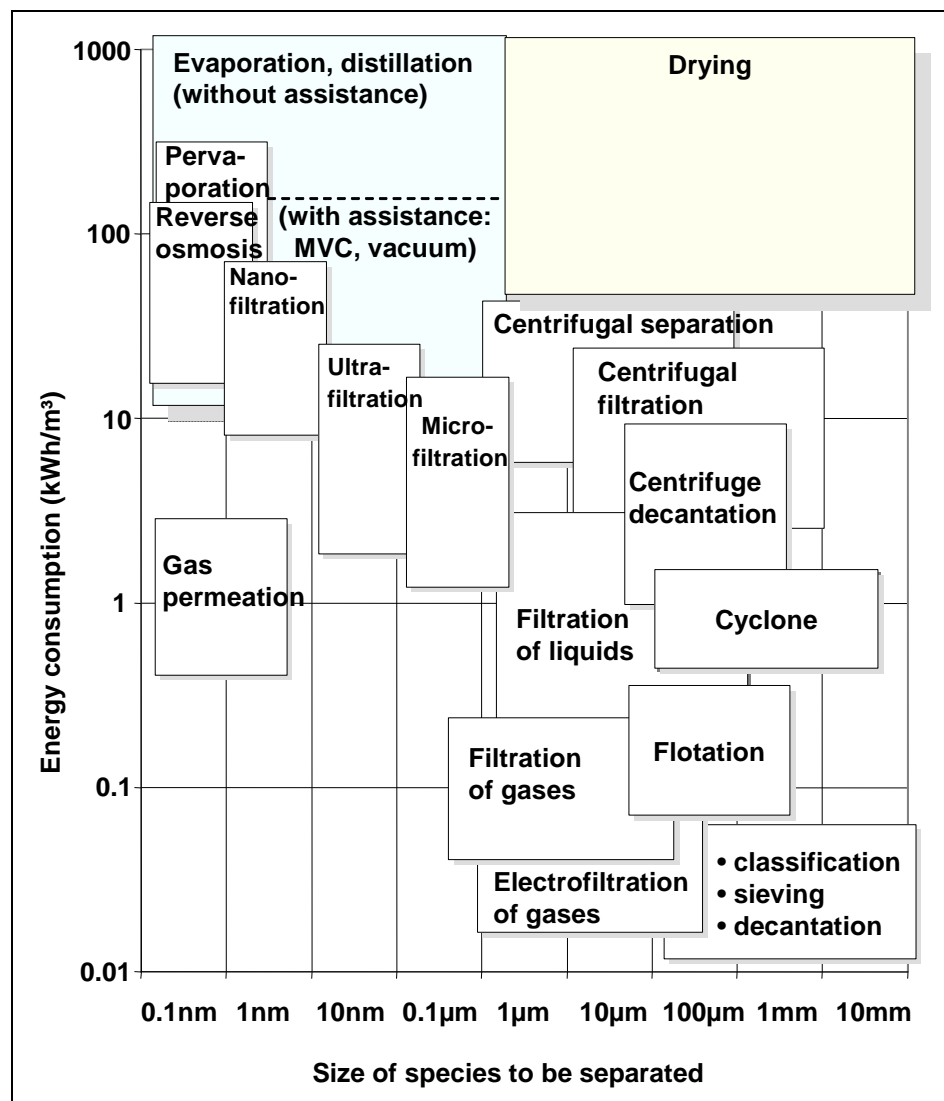

Figure 3.44: Energy consumption of some separation processes
[248, ADEME, 2007]

Applicability

Identification of the appropriate technologies is applicable in all cases. Installation of new equipment is usually carried out on a cost-benefit basis and/or for production quality or throughput reasons.

Economics

No data submitted.

Driving force for implementation

- cost reduction
- product quality
- process throughput capacity.

Examples

When drying liquids (e.g. spray drying), the pretreatment can be membrane filtration (reverse osmosis, nanofiltration, ultrafiltration or microfiltration). Membrane filtration has an energy consumption of 1 - 3 orders of magnitude lower than evaporative drying, and can be used as a first pretreatment stage. For example, in the drying industry, milk can be concentrated to 76 % moisture content before spray drying.

Reference information

[201, Dresch_ADEME, 2006]

3.11.2 Mechanical processes

Description

The energy consumption for mechanical processes can be several orders of magnitude lower compared to thermal drying processes, see Figure 3.44.

As long as the material to be dried lets it, it is recommendable to use predominantly mechanical primary separation processes to reduce the amount of energy used for the entire process. Generally speaking, the majority of products can be mechanically pretreated to average moisture content levels (the ratio between the liquid mass of the liquid to be removed and the mass of dry substance) of between 40 and 70 per cent. In practice, the use of the mechanical process is limited by the permissible material loads and/or economic draining times.

Sometimes mechanical processes are also recommendable prior to thermal treatment. When drying solutions or suspensions (spray drying, for instance), the pretreatment can be membrane filtration (reverse osmosis, nanofiltration, ultrafiltration or microfiltration). For example, in the dairy industry, milk can be concentrated to 76 % moisture content before spray drying.

Achieved environmental benefits

No data submitted.

Cross-media effects

No data submitted.

Operational data

No data submitted.

Applicability

No data submitted.

Economics

No data submitted.

Driving force for implementation

No data submitted.

Examples

No data submitted.

Reference information

[202, IFTS_CMI, 1999]

3.11.3 Thermal drying techniques

3.11.3.1 Calculation of energy requirements and efficiency

Description

Drying is a commonly used method in many industrial sectors. In a dryer system, first of all the damp material is heated to the vaporisation temperature of water, then the water is evaporated at a constant temperature.

$$Q_{th} = (c_G m_G + c_W m_W) \Delta T + m_D \Delta H_V \quad \text{Equation 3.13}$$

Where:

- Q_{th} = useful output in kWh/h
- m_G, m_W = mass flows of dry matter and proportion of water in the material in kg/s
- ΔT = heating temperature change in Kelvin
- m_D = quantity of water evaporated per unit of time in kg/s
- c_G, c_W = specific heat capacities of dry matter and proportion of water in the material in kJ/(kg K)
- ΔH_V = vapourisation heat of water at the respective evaporation temperature (approx. 2300 kJ/kg at 100 °C).

The vapourised water volume is generally removed using air from the drying chamber. The power demand Q_{pd} required to heat the volume of input air (excluding the useful heat output Q_{th}) can be calculated as shown in Equation 3.14.

$$Q_{pd} = V c_{pd} \Delta T_{pd} \quad \text{Equation 3.14}$$

Where:

- Q_{pd} = power demand required to heat the input air in kWh/h (thermal exhaust losses)
- V = flowrate of the input air in m³/h
- c_{pd} = the air's specific heat capacity (approx. 1.2 kJ/m³·K) at 20 °C and 1013 mbar)
- ΔT_{pd} = difference between the temperature of the fresh air and the exhaust air in Kelvin.

The plant's heat losses (such as surface loss) must also be covered above and beyond this power demand. These system losses correspond to the holding power Q_{hp} (power demand of the system when unloaded, at working temperature, and in recirculating air mode only). The entire heat requirement is shown in Equation 3.15.

$$Q_I = Q_{th} + Q_{pd} + Q_{hp} \quad \text{Equation 3.15}$$

Where:

- Q_I = power output required
- Q_{hp} = power demand for unloaded systems.

The thermal efficiency of the firing must be taken into account, depending on the firing equipment. This produces a consequent output Q_{total} shown in Equation 3.16.

$$Q_{total} = Q_I / \eta_{fuel} \quad \text{Equation 3.16}$$

Where:

- Q_{total} = total power output
- η_{fuel} = thermal efficiency.

Figure 3.45 demonstrates the bandwidths for the specific secondary energy consumption per kilogram of evaporated water at maximum load and with maximum possible evaporation performance for various types of dryers. For the purposes of comparison, it has been assumed that the convection dryers use electrical resistance heating.

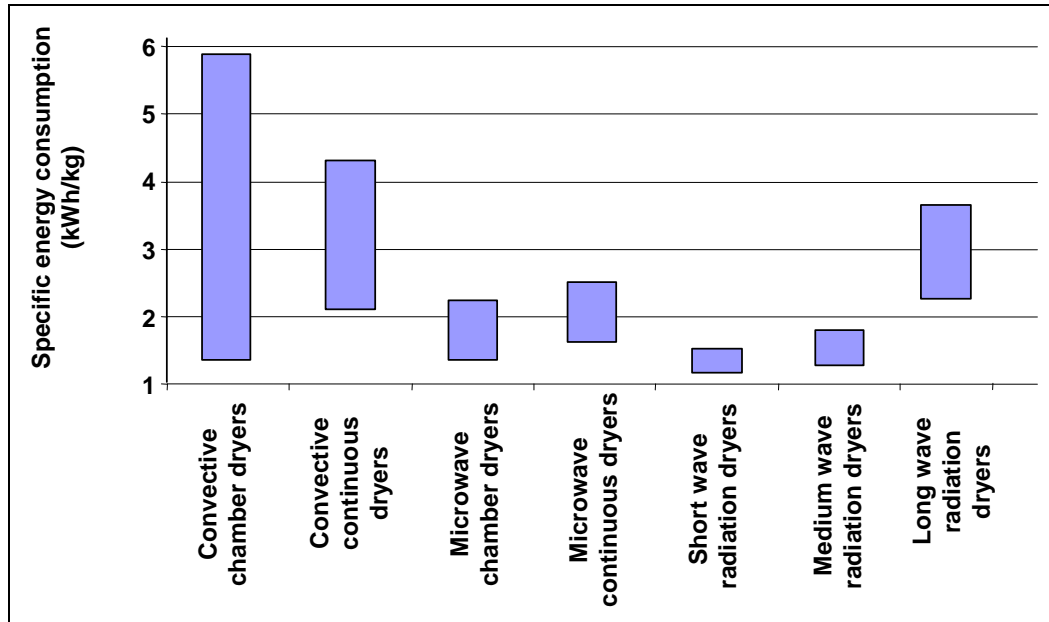

Figure 3.45: Bandwidths for the specific secondary energy consumption of different types of dryer when vaporising water [26, Neisecke, 2003]

Achieved environmental benefits

No data submitted.

Cross-media effects

No data submitted.

Operational data

As indicated in Section 3.11.1, considering the use of mechanical separation processes as a possible pretreatment before drying could, in many cases, reduce significantly the energy consumption.

The optimisation of air humidity in dryers is of vital importance to reduce the energy consumption to a minimum in drying processes.

Applicability

No data submitted.

Economics

No data submitted.

Driving force for implementation

No data submitted.

Examples

No data submitted.

Reference information

[26, Neisecke, 2003, 203, ADEME, 2000]

3.11.3.2 Direct heating**Description**

Direct heating is achieved primarily by convection. A warm or hot gas, usually air (which may be mixed with the combustion gases of the fuel) or steam (see Section 3.11.3.4) is passed through, over or around the material(s) to be dried, which may be in e.g. a rotating drum, on racks or jigs.

Typical direct drying systems are:

- with a flowing gas:
 - e.g. rotating drum, drying oven or kiln, tunnel dryers, spiral belt dryers, tray dryers
- with aerated solids:
 - e.g. through circulator, batch dryers, stationary rack dryers
- with large scale agitation of solids:
 - e.g. fluidised bed, spin flash drying.

Achieved environmental benefits

Direct heating, in particular with hot air warmed by direct combustion, avoids many of the heat losses in indirect systems, boilers and steam pipe lines, etc.

Cross-media effects

None identified.

Operational data

The materials being dried and the liquids being removed must be compatible and safe to use with the system, e.g. not flammable if direct heating is by burning natural gas.

Applicability

Widely used.

Economics

None provided.

Driving force for implementation

- cost reduction
- space
- simplicity (e.g. air drying reduces the need for steam).

Examples

Widely used in many industries, such as in revolving drums drying organic chemicals, fertilisers, food products and sand. It is also used in the surface treatment of metals, and the drying components on jigs. The dryer is the last stage in the jig line, and is a tank, with a size compatible with the preceding tanks containing treatment solutions and rinses. The jigs are lowered and raised into the dryer, as they are into the treatment tanks. The dryer may be fitted with an automatically opening lid.

Reference information

[263, Tempany, 2008, 266, Ullmann's, 2000]

3.11.3.3 Indirect heating

Description

Direct heating is achieved by conduction. The heat is transferred to the material to be dried by a heated surface. The material may be stationary or continually transferred from one hot surface to another.

Typical indirect drying systems are:

- flat and strip materials, such as textiles, paper or board used drum driers. The moist material is wrapped around rotating horizontal cylinders heated internally, usually with steam
- low viscosity materials such as solutions of organic or inorganic material, a roller drier is usually used. The material flows onto heated rollers as a thin layer, and the dried solid is removed with a scaper blade as a film, flakes or powder
- pasty materials are dried by:
 - grooved roller drier (which produces short segments for further drying),
 - hollow screw drier which use one or two hollow Archimedes screws turning in a trough. The screws are heated with hot water, saturated steam, or hot oils, etc.
 - all phase drier which is a contact drier with stirrer and kneeder. The housing, lid, hollow main roller and its disc elements are heated with steam, hot water or hot oil
- Granular materials are dried by:
 - rotary driers, either with heated pipes within the drum or the material to be dried in whin tubes in the heated drum. These have low air velocity, which is useful for dusty materials
 - screw conveyor driers with paddles which turn in a heated container
 - cone worm drier with a cone-shaped stirrer rotating in a heated funnel shaped jacket
 - tray driers, with heated trays
 - spiral tube driers, in which the material is only briefly in contact with the heated surface of the tube and is transported pneumatically. It can be sealed and may be used for organic solvent removal, with solvent recovery.

Achieved environmental benefits

None submitted.

Cross-media effects

Likely to use more energy than direct heating, due to losses in the transfer of heat, as this process has two stages: heating the surface then heating the material.

Operational data

See Description.

Applicability

These driers have can have specific applications, such as when organic solvents are removed.

Economics

None provided.

Driving force for implementation

Applications such as where direct heating cannot be applied, or there are other constraints.

Examples

Widely used.

Reference information

[264, Tempany, 2008, 266, Ullmann's, 2000]

3.11.3.4 Superheated steam

Description

Superheated steam is steam heated to a temperature higher than the boiling point of water at a given pressure. It cannot exist in contact with water, nor contain water, and resembles a perfect gas; it is also called surcharged steam, anhydrous steam, and steam gas. Superheated steam can be used as a heating fluid instead of hot air in any direct dryers (where the heating fluid is in direct contact with the product); for example, in spray drying, in a fluidised bed, in a spouted bed, in drums, etc.

Achieved environmental benefits

The advantage is that the limiting phenomenon is only heat transfer and not mass (water) transfer. The drying kinetic is thus better. Dryers are smaller and so are heat losses. Moreover, the energy (latent heat) of the water coming from the product can easily be recycled in the dryer via mechanical vapour recompression (MVR) or used in another process, increasing the energy savings.

Dealing with volatile organic compounds (VOCs) is easier because of the limited volume of exhaust gases. These compounds may be easily recovered.

Cross-media effects

Thermosensitive products can be damaged by the high temperature.

Operational data

Energy consumption is about 6–70 kWh/t evaporated water without heat recovery and 170 to 340 kWh/t with heat recovery (MVR, for example).

Process control is easier because the final moisture of the product and drying kinetic can be controlled through steam temperature. The elimination of air reduces the risks of fire and explosion.

Applicability

Any direct dryers can be retrofitted with superheated steam. Tests should be conducted to guarantee the product quality, and economic calculations have to be made.

Economics

The investment is generally higher, especially when MVR is used.

Driving force for implementation

Energy savings should be the first driving force for implementation. Better product quality is often reported, especially in the agro-food industry (better colour, absence of oxidation, etc.).

Examples

- Sucrierie Lesaffre (Nangis, France): drying of beet pulp using superheated steam
- applications: sludge, beet pulp, alfalfa, detergent, technical ceramics, wood-based fuel, etc.

Reference information

[208, Ali, 1996]

3.11.3.5 Heat recovery in drying processes

Description

Drying is often a high temperature process and waste heat may be recovered:

- either directly, when the drying process is a direct one using hot air as the heating fluid:
 - mix the exhaust air with fresh air directly before the burner
 - if the exhaust air is contaminated too much (dust, moisture, etc.), recycle heat from exhaust air via an heat exchanger (see Section 3.3.1.) to preheat the product to be dried or the drying air
- or indirectly, using mechanical vapour recompression (MVR) to compress the exhaust vapour (see Section 3.3.2), especially when the heating fluid is superheated steam (see Section 3.11.3.4).

Only 'direct' recycling is considered here.

Achieved environmental benefits

Minimise energy usage.

Cross-media effects

Preheating the air before the burner via heat recovery may disturb the drying process by influencing the temperature-moisture content. Possible contaminants may appear when there is no heat exchanger. Regulation may be needed to correctly control the drying temperature.

Operational data

- energy savings are always greater when ambient air is cold (in winter, for example)
- at least 5 % energy savings are expected.

Applicability

This technique can be used for almost any continuous hot air convective dryers (tunnel, oven, drum, etc.). Attention is to be paid to burner adjustment and sizing of the different items: fan, pipe diameter, regulation valve and heat exchanger if applicable. Stainless steel is required for the heat exchanger. When the dryer burner works with fuel, exhaust air contains sulphur and SO₂ and may damage the heat exchanger if condensation occurs.

Economics

Payback time may be very variable, depending on the energy cost, the evaporating capacity of the dryer and the number of running hours. Never forget to make a simulation with hypotheses on the rise of energy prices.

Driving force for implementation

Saving money through energy savings.

Example plants

Beet pulp drying (Cambrai, France): heat recovery on exhaust gases.

Information Reference

[203, ADEME, 2000]

3.11.3.6 Mechanical vapour recompression or heat pumps with evaporation

Concentration by evaporation coupled with MVR (mechanical vapour recompression) or a heat pump, is a highly efficient technique for wastewater treatment. In particular, this technique makes it possible to significantly reduce waste water volumes sent to treatment at a low cost, as well as allowing water recycling.

Description

To evaporate one tonne of water, 700 to 800 kWh/t energy power is required. It is possible to reduce the energy needs by using heat recovery solutions, such as heat pumps, including mechanical vapour recompression (MVR) (see Section 3.3.2), or multiple effect evaporators with thermo-compression.

Cross-media effects

The concentration of wastewater streams may require different management and treatment techniques (i.e. may no longer be suitable for waste water discharge).

Operational data

Several types of evaporators and their specific consumptions are shown together in Table 3.29.

Evaporator type	Specific consumptions ^{1, 2, 3}	
	kg steam/twe ¹ (kWh)	kWh of electricity/twe ¹
1 stage 1200	(960)	10
2 stage 650	(520)	5
1 stage with thermocompression	450 – 550 (400)	5
3 stage	350 – 450 (320)	5
6 stage with thermocompression	115 – 140 (100)	5
1 stage with MVR	0 – 20 (8)	15 – 30
2 stage with MVR	0 – 20 (8)	10 – 20
Heat pump		
Notes:		
1. twe: tonne of water evaporated		
2. Average values for different concentration of product		
3. Last column corresponds to auxiliaries consumptions (pump, refrigerating towers, etc.)		

Table 3.29: Evaporator types and specific consumptions

Applicability

The choice of technology depends on the nature of the product and the concentrate. Feasibility tests can be necessary.

Economics

Determined on a case by case basis.

Driving force for implementation

- cost savings
- increase in production throughput and/or product quality.

Examples

ZF Lemforder Mecacentre manufactures different pieces for the car industry (suspension or steering balls, steering columns, etc.). In 1998, during the process of obtaining ISO 14001 certification, the company installed an MVR evaporator to concentrate wash water from cleaning workpieces. The equipment installed concentrates up to 120 litres of wastewater per hour with a power of 7.2 kWh and allows the recycling of 20 to 25 m³ of purified water per month in the production system. The residual concentrated liquid waste is sent to a suitable waste management treatment installation:

- investment cost: EUR 91 469
- annual saving obtained: EUR 76 224
- return on investment time: 14 months.

Reference information

[26, Neisecke, 2003, 197, Wikipedia, , 201, Dresch_ADEME, 2006] [243, R&D, 2002]

3.11.3.7 Optimisation of the insulation of the drying system

Description

As with all heated equipment, heat losses can be reduced by insulating the drying system, such as ovens and steam pipes and condensate pipes (see also Section 3.2.11). The type of insulation used and the thickness required depends on the operating temperature of the system, the materials being dried and if liquids other than water are being removed, or if the water vapour may be contaminated (e.g. with acid vapour).

The insulation needs to be maintained, as it can suffer deterioration with time due to embrittlement, mechanical damage, action of damp (e.g. from condensing water vapour, steam leaks) or contact with chemicals. Damaged insulation can be identified by visual inspection or by infrared scanning, see Section 2.10.1.

Achieved environmental benefits

Energy savings.

Cross-media effects

None identified.

Operational data

Where the hot surfaces may be in contact with personnel, a maximum surface temperature of 50 °C is recommended.

Insulation can cover leaks and/or corrosion, and periodic checks need to be made to identify these.

Applicability

When insulating a large drying system or refurbishing a plant.

Economics

These can be calculated on a project basis.

Driving force for implementation

Cost savings and health and safety.

Examples

Widely used.

Reference information

[265, Tempany, 2008, 268, Whittaker, 2003]

www.pip.org

3.11.4 Radiant energies

Description

In radiant energies such as infrared (IR), high frequency (HF) and microwaves (MW), energy is transferred by thermal radiation. Note that there is a difference between drying and curing: drying requires the raising of the solvent molecules to or above the latent heat of evaporation, whereas curing techniques provide the energy for cross-linking (polymerisation) or other reactions. The drying and curing of coatings are discussed in the STS BREF.

These technologies are applied in industrial production processes to heat products and thus, can be applied in drying processes. Radiant energies can be used alone or in combination with conduction or convection.

Achieved environmental benefits

Radiant energies have specific characteristics allowing energy savings in these processes:

- direct transfer of energy. Radiant energies allow direct transfer of energy from source to product, without using intermediate media. The heat transfer is thus optimum, especially by avoiding energy loss through ventilation systems. This can achieve significant energy savings. For example, for paint drying processes, about 80 % of energy is extracted with the waste gases
- high power density. Surface (IR) or volume (HF, MW) power densities are higher for radiant energies compared to conventional technologies such as hot air convection. This leads to a higher production velocity and allows treatment of high specific energy products such as some paints
- energy focusing. Energy can easily be focused on the required part of the product
- control flexibility. Thermal inertia is low with radiant energies and power variations are large. Flexible control can be used, which leads to energy savings and good quality manufactured products.

Cross-media effects

None reported.

Operational data

Exhaust airflow is generally far lower because air is not the intermediate medium for heat transfer but is just used to extract steam or other solvents. Treatment of exhaust gases, if applicable, is thus easier and less expensive.

Other achieved benefits specific for IR:

- direct heating: reduction of hot air exhaust, thus energy saving; few or no hot fluids transported
- reduction of equipment size
- easier regulation
- retrofitting of plants.

Other achieved benefits specific for HF and MW:

- direct heating: reduction of hot air exhaust, thus energy saving; few or no hot fluids transported
- volume heating leads to rapid drying and less losses
- selective heating, water is heated preferentially
- homogeneous heating if the size of the products is compatible with wavelength
- efficient heat transfer.

Differential heating of heterogeneous products can occur and lead to poor quality products.

Some disadvantages for IR:

- larger investment (20 - 30 %)
- essentially for flat or simple-shaped products
- often not the priority choice of constructors.

Some disadvantages for HF and MW:

- larger investment (20 - 30 %)
- often not a priority choice of constructors.

Applicability

Radiant energies, in particular IR, can be used in retrofitting of installations or to boost the production line, coupled with convection or conduction.

In spite of their advantages (speed of action, quality of final products, energy savings), the use of radiant energies is not common in industrial applications, today known as having a great energy savings potential.

IR can be used in:

- curing of paint, ink and varnish
- drying of paper, paperboard, pre-drying of textiles
- drying powder in the chemical and plastics industries.

HF can be used in the drying of:

- massive (monolithic) products: textiles (reels of wire), ceramics
- powder in the chemical industry.

MW can be used in the drying of:

- massive (monolithic) products (wood, agro-industry) or flat products
- chemical and pharmaceutical products (under vacuum).

Economics

Investment is generally more expensive (20 – 30 %) than conventional techniques.

Driving force for implementation

Radiant energies lead to compact systems. Lack of space availability can be a driving force. They can be used to boost existing production lines, especially IR.

Examples

Biotex is a French plant producing latex pillows. Pillows are very difficult to dry and must have a moisture content of <1 % to avoid problems during usage. The convective tunnel (impinging jet) was not sufficient for a good production quality and consumed a lot of energy. The implementation of an HF system at the output of the tunnel met the requirements in terms of quality and reduced the specific energy consumption per pillow by 41 % (primary energy) with an eight fold reduction of production time. The convector tunnel leaves pillows with 19 to 45 % moisture, HF achieves 1 %. Payback time was 4 years.

Reference information

[204, CETIAT, 2002, 205, ADEME, , 206, ADEME, 2002]

3.11.5 Computer-aided process control/process automation in thermal drying processes

Description

In the vast majority of applications with thermal drying processes, dryers are normally controlled using target value specifications and/or predominantly empirical values (operator experience). The retention time, throughput speed, starting moisture content, temperature and product quality are all used as control parameters. Moisture sensors with linear characteristics and low interferences, while still offering high service lives, are required to determine the moisture content. A computer can calculate these measurements in real time and compare them with target values calculated from the mathematical model of the drying process. This requires an exact knowledge of the drying process and suitable software. The controller changes the corresponding control variable by comparing the target and actual values.

Examples from different plants show that savings of between 5 and 10% can be achieved compared with using traditional empirical controllers.

Achieved environmental benefits

No data submitted.

Cross-media effects

No data submitted.

Operational data

No data submitted.

Applicability

No data submitted.

Economics

No data submitted.

Driving force for implementation

No data submitted.

Examples

No data submitted.

Reference information

[207, ADEME, 2000]

4 BEST AVAILABLE TECHNIQUES

4.1 Introduction

In understanding this chapter and its contents, the attention of the reader is drawn back to the preface of this document and in particular to the text quoted below:

From Section 3 of the Preface, 'Relevant legal obligations of the IPPC Directive and the definition of BAT':

The purpose of the IPPC Directive is to achieve integrated prevention and control of pollution arising from the activities listed in its Annex I, leading to a high level of protection of the environment as a whole including energy efficiency. The legal basis of the Directive relates to environmental protection. Its implementation should also take account of other Community objectives such as the competitiveness of the Community's industry thereby contributing to sustainable development. The Scope gives further information on the legal basis of energy efficiency in the Directive.

More specifically, the IPPC Directive provides for a permitting system for certain categories of industrial installations requiring both operators and regulators to take an integrated, overall view of the potential of the installation to consume and pollute. The overall aim of such an integrated approach must be to improve the design and build, and the management and control of industrial processes so as to ensure a high level of protection for the environment as a whole. Central to this approach is the general principle given in Article 3 that operators should take all appropriate preventative measures against pollution, in particular through the application of **'best available techniques'**, enabling them to improve their environmental performance including energy efficiency.

The term 'best available techniques' is defined in Article 2(12) of the Directive.

Furthermore, Annex IV to the Directive contains a list of 'considerations to be taken into account generally or in specific cases when determining best available techniques bearing in mind the likely costs and benefits of a measure and the principles of precaution and prevention'. These considerations include the information published by the Commission to comply with Article 17(2).

Competent authorities responsible for issuing permits are required to take account of the general principles set out in Article 3 when determining the conditions of the permit. These conditions must include emission limit values, supplemented or replaced where appropriate by equivalent parameters or technical measures. According to Article 9(4) of the Directive:

(without prejudice to compliance with environmental quality standards), the emission limit values, equivalent parameters and technical measures shall be based on the best available techniques, without prescribing the use of any technique or specific technology, but taking into account the technical characteristics of the installation concerned, its geographical location and the local environmental conditions. In all circumstances, the conditions of the permit shall include provisions on the minimisation of long-distance or transboundary pollution and ensure a high level of protection for the environment as a whole.

Member States have the obligation, according to Article 11 of the Directive, to ensure that competent authorities follow or are informed of developments in best available techniques.

From Section 6 of the Preface, 'How to understand and use this document':

The information provided in this document is intended to be used as an input to the determination of BAT for energy efficiency in specific cases. When determining BAT and setting BAT-based permit conditions, account should always be taken of the overall goal to achieve a high level of protection for the environment as a whole including energy efficiency.

This chapter (Chapter 4) presents the techniques that are considered to be compatible with BAT in a general sense. The purpose is to provide general indications about energy efficiency techniques that can be considered as an appropriate reference point to assist in the determination of BAT-based permit conditions or for the establishment of general binding rules under Article 9(8). It should be stressed, however, that this document does not propose energy efficiency values for permits. The determination of appropriate permit conditions will involve taking account of local, site-specific factors such as the technical characteristics of the installation concerned, its geographical location and the local environmental conditions. In the case of existing installations, the economic and technical viability of upgrading them also needs to be taken into account. Even the single objective of ensuring a high level of protection for the environment as a whole will often involve making trade-off judgements between different types of environmental impact, and these judgements will often be influenced by local considerations.

The best available techniques presented in this chapter will not necessarily be appropriate for all installations. On the other hand, the obligation to ensure a high level of environmental protection including the minimisation of long-distance or transboundary pollution implies that permit conditions cannot be set on the basis of purely local considerations. It is therefore of the utmost importance that the information contained in this document is fully taken into account by permitting authorities.

As a consequence of the integrated approach and the need to balance cross-media effects (as summarised above), energy efficiency ultimately should be considered for the installation as a whole, i.e.:

- it may not be possible to maximise the energy efficiencies of all activities and/or systems in the installation at the same time
- it may not be possible to both maximise the total energy efficiency and minimise other consumptions and emissions (e.g. it may not be possible to reduce emissions such as those to air without using energy)
- the energy efficiency of one or more systems may be de-optimised to achieve the overall maximum efficiency for an installation. See Sections 1.3.5 and 1.5.1.1
- it is necessary to keep the balance between maximising energy efficiency and other factors, such as product quality and the stability of the process
- the use of 'wasted' or surplus heat and/or renewable energy sources may be more sustainable than using primary fuels, even if the energy efficiency in use is lower.

Energy efficiency techniques are therefore proposed as 'optimising energy efficiency'.

The techniques presented in this chapter have been assessed through an iterative process involving the following steps:

- identification of the key energy efficiency issues within the scope of the IPPC Directive (see the Preface and Scope³²)
- examination of the techniques most relevant to address these key issues
- identification of the best energy efficiencies achievable, on the basis of the available data in the European Union and worldwide

³² Energy efficiency in the IPPC Directive and the scope of this document, as well as the interface with other legislation and policy commitments is discussed in the Preface and Scope. It was concluded there that this document would not discuss such issues as the use of renewable energy sources.

- examination of the conditions under which these performance levels were achieved; such as costs, cross-media effects, and the main driving forces involved in implementing the techniques
- selection of the best available techniques (BAT) in a general sense according to Article 2(12) and Annex IV to the Directive.

Expert judgement by the European IPPC Bureau and the relevant Technical Working Group (TWG) has played a key role in each of these steps and in the way in which the information is presented here.

Where available, data concerning costs have been given together with the description of the techniques presented in the previous chapters. These give a rough indication about the magnitude of the costs involved. However, the actual cost of applying a technique will depend strongly on the specific situation regarding, for example, taxes, fees, and the technical characteristics of the installation concerned. It is not possible to evaluate such site-specific factors fully in this document. In the absence of data concerning costs, conclusions on economic viability of techniques are drawn from observations on existing installations.

It is intended that the general BAT in this chapter are a reference point against which to judge the current performance of an existing installation or to judge a proposal for a new installation. In this way they will assist in the determination of appropriate 'BAT-based' conditions for the installation or in the establishment of general binding rules under Article 9(8) of the IPPC Directive. It is foreseen that new installations can be designed to perform at or even better than the general BAT presented here. It is also considered that existing installations could move towards the general BAT or do better, subject to the technical and economic applicability of the techniques in each case.

While the BAT reference documents do not set legally binding standards, they are meant to give information for the guidance of industry, Member States and the public on achievable emission and consumption levels when using specified techniques (including energy efficiencies given in vertical sector BREFs), or the equivalent parameters and technical measures (Article 9(4)). The appropriate conditions for any specific case will need to be determined taking into account the objectives of the IPPC Directive and the local considerations.

Identification of horizontal BAT

The horizontal approach to energy efficiency in all IPPC sectors is based on the premise that energy is used in all installations, and that common systems and equipment occur in many IPPC sectors. Horizontal options for energy efficiency can therefore be identified independently of a specific activity. On this basis, BAT can be derived that embrace the most effective measures to achieve a high level of energy efficiency as a whole. Because this is a horizontal BREF, BAT need to be determined more broadly than for a vertical BREF, such as to consider the interaction of processes, units and systems within a site.

Process-specific BAT for energy efficiency and associated energy consumption levels are given in the appropriate 'vertical' sector BREFs. Some of these have been broadly summarised in [283, EIPPCB].

BAT for specific installations is, therefore, the combination of the specific BAT elements in the relevant sector BREFs, specific BAT for associated activities that may be found in other vertical BREFs, and the generic BAT elements presented in this chapter: those that are general to all installations can be found in Section 4.2 and the relevant BAT for certain systems, processes, activities or equipment are given in Section 4.3 (the relationship is shown in Figure 4.1).

Neither this chapter, nor Chapters 2 and 3 give exhaustive lists of techniques which may be considered, and therefore other techniques may exist or may be developed which may be equally valid within the framework of IPPC and BAT.

Implementation of BAT

The implementation of BAT in new or significantly upgraded plants or processes is not usually a problem. In most cases, it makes economic sense to optimise energy efficiency. Within an existing installation, the implementation of BAT is not generally so easy, because of the existing infrastructure and local circumstances: the economic and technical viability of upgrading these installations needs to be taken into account (see the Preface and the details listed below). The ECM REF [167, EIPPCB, 2006] refers to the following factors:

- for a new plant or major upgrade, the stage of commitment to a selection of techniques (i.e. the point at which changes in design can no longer be cost-effectively made)
- the age and design of the equipment
- the position of the installation in its investment cycle
- the complexity of processes and the actual selection of techniques used in the installation
- the production capacity, volumes and the mix of products being produced
- the type of treatments being applied and quality requirements
- the space available
- cost, 'availability' and robustness of techniques in the timescale required by the operator
- the time required to make changes to activities (including any structural changes) within the installation and how this is optimised with production requirements
- the cost-benefit of any ongoing environmental measures
- new and emerging techniques
- financial and cross-media costs.

Nevertheless, this document does not generally distinguish between new and existing installations. Such a distinction would not encourage the operators of industrial sites to move towards adopting BAT. There is generally a payback associated with energy efficiency measures and due to the high importance attached to energy efficiency, many policy implementation measures, including financial incentives, are available. Information on European and MS action plans and regulations can be found in Annex 7.13.

Some of the techniques are applied continuously and others are applied periodically, in whole or in part. For example, some maintenance tasks are carried out daily, while others are carried at appropriate times, e.g. servicing equipment at shut down times.

Some techniques are very desirable, and often implemented, but may require the availability and cooperation of a third party (e.g. cogeneration), which is not considered in the IPPC Directive.

Aids to understand this chapter

During the preparation of this document, it has become apparent that there is an order in which it is helpful to consider the application of techniques and therefore BAT. This is reflected in the order of the BAT sections, below, and in Figure 4.1.

The first priority is the selection and operation of core processes of the activities covered by the processes. These are discussed in their vertical sector BREFs, which are the first reference point.

In some cases, techniques which can be applied to associated activities in an installation are discussed in a separate vertical sector BREF, e.g. in the LCP, WI or WT BREFs.

However, energy efficiency is a cross-cutting issue, and there are aspects that are not dealt with in the vertical sector BREFs, or that need to be addressed uniformly across sectors. These are addressed in this document.

The first step is an action programme based on an Energy Efficiency Management System (ENEMS), referred to in Section 4.2.1. This may be dealt with (i) by an EMS referred to in the vertical sector BREF, (ii) such an EMS can be amended or (iii) the EMS can be supplemented by a separate ENEMS. Specific BAT apply when upgrading existing installations or developing new ones.

Sections 4.2.2 to 4.2.9 support the implementation of certain sections of the ENEMS. They contain BAT providing more detail on techniques.

Section 4.3 contains BAT for certain common systems, processes, associated activities or equipment which have an impact on the energy efficiency of the installation and are not discussed in detail in vertical BREFs. These may be identified during the course of assessing an installation.

In many cases, additional information is summarised from the discussions in earlier chapters, under the heading '*Applicability*'. This gives information such as which installations the BAT applies to, the frequency and complexity of applying the BAT, etc.

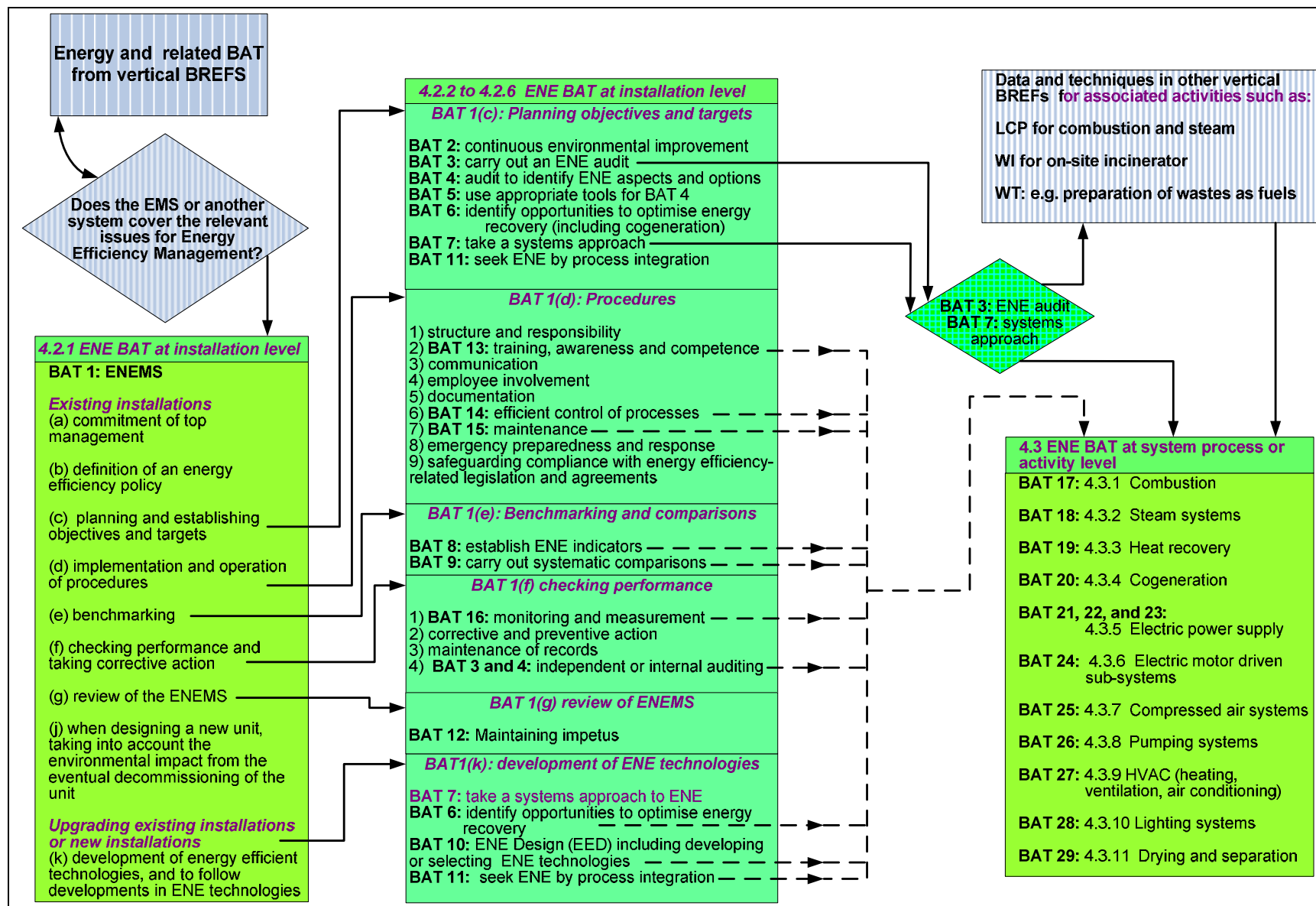

Figure 4.1: Relationships between BAT for Energy efficiency

4.2 Best available techniques for achieving energy efficiency at an installation level

The key element to deliver energy efficiency at an installation level is a formal management approach, described in BAT 1. This is supported by the BAT in the following sections.

4.2.1 Energy efficiency management

A number of energy efficiency management techniques are determined as BAT. The scope (e.g. level of detail) and nature of the energy efficiency management system (ENEMS) (e.g. standardised or non-standardised) will generally be related to the nature, scale and complexity of the installation, as well as the energy requirements of the component processes and systems (see Section 2.1):

1. **BAT is to implement and adhere to an energy efficiency management system (ENEMS) that incorporates, as appropriate to the local circumstances, all of the following features (see Section 2.1. The letters (a), (b), etc. below, correspond those in Section 2.1):**
 - a. commitment of top management (commitment of the top management is regarded as a precondition for the successful application of energy efficiency management)
 - b. definition of an energy efficiency policy for the installation by top management
 - c. planning and establishing objectives and targets (see BAT 2, 3 and 8)
 - d. implementation and operation of procedures paying particular attention to:
 - i) structure and responsibility
 - ii) training, awareness and competence (see BAT 13)
 - iii) communication
 - iv) employee involvement
 - v) documentation
 - vi) effective control of processes (see BAT 14)
 - vii) maintenance (see BAT 15)
 - viii) emergency preparedness and response
 - ix) safeguarding compliance with energy efficiency-related legislation and agreements (where such agreements exist).
 - e. benchmarking: the identification and assessment of energy efficiency indicators over time (see BAT 8), and the systematic and regular comparisons with sector, national or regional benchmarks for energy efficiency, where verified data are available (see Sections 2.1(e), 2.16 and BAT 9)
 - f. checking performance and taking corrective action paying particular attention to:
 - i) monitoring and measurement (see BAT 16)
 - ii) corrective and preventive action
 - iii) maintenance of records
 - iv) independent (where practicable) internal auditing in order to determine whether or not the energy efficiency management system conforms to planned arrangements and has been properly implemented and maintained (see BAT 4 and 5)
 - g. review of the ENEMS and its continuing suitability, adequacy and effectiveness by top management

For (h) and (i), see further features on an energy efficiency statement and external verification, below

- b. when designing a new unit, taking into account the environmental impact from the eventual decommissioning of the unit
- c. development of energy efficient technologies, and to follow developments in energy efficiency techniques.

The ENEMS may be achieved by ensuring these elements form part of existing management systems (such as an EMS) or by implementing a separate energy efficiency management system.

Three further features are considered as supporting measures. Although these features have advantages, systems without them can be BAT. These three additional steps are:

- (see Section 2.1(h)) preparation and publication (and possibly external validation) of a regular energy efficiency statement describing all the significant environmental aspects of the installation, allowing for year-by-year comparison against environmental objectives and targets as well as with sector benchmarks as appropriate
- (see Section 2.1(i)) having the management system and audit procedure examined and validated by an accredited certification body or an external ENEMS verifier
- (see Section 2.1, Applicability, 2) implementation and adherence to a nationally or internationally accepted voluntary system such as:
 - DS2403, IS 393, SS627750, VDI Richtlinie No. 46, etc.
 - (when including energy efficiency management in an EMS) EN ISO 14001:1996. This voluntary step could give higher credibility to the ENEMS. However, non-standardised systems can be equally effective provided that they are properly designed and implemented.

Applicability: All installations. The scope and nature (e.g. level of detail) of applying this ENEMS will depend on the nature, scale and complexity of the installation, and the energy requirements of the component processes and systems.

4.2.2 Planning and establishing objectives and targets

4.2.2.1 Continuous environmental improvement

An important aspect of environmental management systems is continuing environmental improvement. This requires maintaining a balance for an installation between consumption of energy, raw materials and water, and the emissions (see Sections 1.1.6 and 2.2.1). Planned continuous improvement can also achieve the best cost-benefit for achieving energy savings (and other environmental benefits).

2. BAT is to continuously minimise the environmental impact of an installation by planning actions and investments on an integrated basis and for the short, medium and long term, considering the cost-benefits and cross-media effects.

Applicability: All installations.

'Continuously' means the actions are repeated over time, i.e. all planning and investment decisions should consider the overall long term aim to reduce the environmental impacts of the operation. This may mean avoiding short term actions to better use available investments over a longer term, e.g. changes to the core process may require more investment and take longer to implement, but may bring bigger reductions in energy use and emissions (see examples in Section 2.2.1).

The environmental benefits may not be linear, e.g. 2 % energy savings every year for 10 years. They may be stepwise, reflecting investment in ENE projects, etc. (see Section 2.2.1). Equally, there may be cross-media effects: for example it may be necessary to increase energy consumption to abate an air pollutant.

Environmental impacts can never be reduced to zero, and there will be points in time where there is little or no cost-benefit to further actions. However, over a longer period, with changing technology and costs (e.g. energy prices), the viability may also change.

4.2.2.2 Identification of energy efficiency aspects of an installation and opportunities for energy savings

In order to optimise energy efficiency, the aspects of an installation that influence energy efficiency need to be identified and quantified (see Section 2.11). Energy savings can then be identified, evaluated, prioritised and implemented according to BAT 2, above (see Section 2.1(c)).

3. BAT is to identify the aspects of an installation that influence energy efficiency by carrying out an audit. It is important that an audit is coherent with a systems approach (see BAT 7).

Applicability: All existing installations and prior to planning upgrades or rebuilds. An audit may be internal or external.

The scope of the audit and nature (e.g. level of detail, the time between audits) will depend on the nature, scale and complexity of the installation and the energy consumption of the component processes and systems (see Section 2.8.), e.g.:

- *in large installations with many systems and individual energy-using components such as motors, it will be necessary to prioritise data collection to necessary information and significant uses*
- *in smaller installations, a walk-through type audit may be sufficient.*

The first energy audit for an installation may be called an energy diagnosis.

4. When carrying out an audit, BAT is to ensure that the audit identifies the following aspects (see Section 2.11):

- a. energy use and type in the installation and its component systems and processes
- b. energy-using equipment, and the type and quantity of energy used in the installation
- c. possibilities to minimise energy use, such as:
 - controlling/reducing operating times, e.g. switching off when not in use (e.g. see Sections 3.6, 3.7, 3.8, 3.9, 3.11)
 - ensuring insulation is optimised, e.g. see Sections 3.1.7, 3.2.11 and 3.11.3.7
 - optimising utilities, associated systems, processes and equipment (see Chapter 3)
- d. possibilities to use alternative sources or use of energy that is more efficient, in particular energy surplus from other processes and/or systems, see Section 3.3
- e. possibilities to apply energy surplus to other processes and/or systems, see Section 3.3
- f. possibilities to upgrade heat quality (see Section 3.3.2).

Applicability: All installations. The scope of the audit and the nature (e.g. level of detail) will depend on the nature, scale and complexity of the installation, and the energy consumption of the component processes and systems.

Examples of some techniques for optimising systems and processes are given in the relevant sections in Chapter 3.

5. BAT is to use appropriate tools or methodologies to assist with identifying and quantifying energy optimisation, such as:

- energy models, databases and balances (see Section 2.15)
- a technique such as pinch methodology (see Section 2.12) energy or enthalpy analysis (see Section 2.13), or thermoeconomics (see Section 2.14)
- estimates and calculations (see Sections 1.5 and 2.10.2).

Applicability: Applicable to every sector. The choice of appropriate tool or tools will depend on the sector, and the size, complexity and energy usage of the site. This will be site-specific, and is discussed in the relevant sections.

6. BAT is to identify opportunities to optimise energy recovery within the installation, between systems within the installation (see BAT 7) and/or with a third party (or parties), such as those described in Sections 3.2, 3.3 and 3.4.

Applicability: The scope for energy recovery depends on the existence of a suitable use for the heat at the type and quantity recovered (see Sections 3.3 and 3.4, and Annexes 7.10.2 and 7.10.3). A systems approach is set out in Section 2.2.2 and BAT 7). Opportunities may be identified at various times, such as a result of audits or other investigations, when considering upgrades or new plants, or when the local situation changes (such as a use for surplus heat is identified in a nearby activity).

The cooperation and agreement of a third party may not be within the control of the operator, and therefore may not be within the scope of an IPPC permit. In many cases, public authorities have facilitated such arrangements or are the third party.

4.2.2.3 A systems approach to energy management

The major energy efficiency gains are achieved by viewing the installation as a whole and assessing the needs and uses of the various systems, their associated energies and their interactions (see Sections 1.3.5, 1.4.2 and 2.2.2).

7. BAT is to optimise energy efficiency by taking a systems approach to energy management in the installation. Systems to be considered for optimising as a whole are, for example:

- process units (see sector BREFs)
- heating systems such as:
 - steam (see Section 3.2)
 - hot water
- cooling and vacuum (see the ICS BREF)
- motor driven systems such as:
 - compressed air (see Section 3.7)
 - pumping (see Section 3.8)
- lighting (see Section 3.10)
- drying, separation and concentration (see Section 3.11).

Applicability: All installations. The scope and nature (e.g. level of detail, frequency of optimisation, systems to be considered at any one time) of applying this technique will depend on factors such as the nature, scale and complexity of the installation, the energy requirements of the component processes and systems and the techniques considered for application.

4.2.2.4 Establishing and reviewing energy efficiency objectives and indicators

Quantifiable, recorded energy efficiency objectives are crucial for achieving and maintaining energy efficiency. Areas for improvement are identified from an audit (see BAT 3). Indicators need to be established to assess the effectiveness of energy efficiency measures. For process industries, these are preferably indicators related to production or service throughput (e.g. GJ/t product, see Section 1.3), termed specific energy consumption (SEC). Where a single energy objective (such as SEC) cannot be set, or where it is helpful, the efficiency of individual processes, units or systems may be assessed. Indicators for processes are often given in the relevant sector BREFS (for an overview, see [283, EIPPCB])

Production parameters (such as production rate, product type) vary and these may affect the measured energy efficiency and should be recorded to explain variations and to ensure that energy efficiency is realised by the techniques applied (see Sections 1.4 and 1.5). Energy use and transfers may be complicated and the boundary of the installation or system being assessed should be carefully defined on the basis of entire systems (see Sections 1.3.5 and 1.4.2 and BAT 7). Energy should be calculated on the basis of primary energy, or the energy uses shown as secondary energy for the different utilities (e.g. process heat as steam use in GJ/t, see Section 1.3.6.1).

8. BAT is to establish energy efficiency indicators by carrying out all of the following:

- a. identifying suitable energy efficiency indicators for the installation, and where necessary, individual processes, systems and/or units, and measure their change over time or after the implementation of energy efficiency measures (see Sections 1.3 and 1.3.4)
- b. identifying and recording appropriate boundaries associated with the indicators (see Sections 1.3.5 and 1.5.1)
- c. identifying and recording factors that can cause variation in the energy efficiency of the relevant process, systems and/or units (see Sections 1.3.6 and 1.5.2).

Applicability: All installations. The scope and nature (e.g. level of detail) of applying these techniques will depend on the nature, scale and complexity of the installation, and the energy consumption of the component processes and systems.

Secondary or final energies are usually used for monitoring ongoing situations. In some cases, it may be most convenient to use more than one secondary or final energy indicator, for example, in the pulp and paper industry, where both electricity and steam are given as joint energy efficiency indicators. When deciding on the use (or change) of energy vectors and utilities, the energy indicator used may also be the secondary or final energy. However, other indicators such as primary energy or carbon balance may be used, to take account of the production of any secondary energy vector and the cross-media effects, depending on local circumstances (see Section 1.3.6.1).

4.2.2.5 Benchmarking

Benchmarking is a powerful tool for assessing the performance of a plant and the effectiveness of energy efficiency measures, as well as overcoming paradigm blindness³³. Data may be found in sector BREFs, trade association information, national guidance documents, theoretical energy calculations for processes, etc. Data should be comparable and may need to be corrected, e.g. for type of feedstock. Data confidentiality may be important, such as where energy consumption is a significant part of the cost of production, although it may be possible to protect data (see Section 2.16). See also the establishment of energy indicators in BAT 8.

Benchmarking can also be applied to processes and working methods (see Sections 2.5 and 2.16).

9. BAT is to carry out systematic and regular comparisons with sector, national or regional benchmarks, where validated data are available.

Applicability: All installations. The level of detail will depend on the nature, scale and complexity of the installation, and the energy consumption of the component processes and systems. Confidentiality issues may need to be addressed (see Section 2.16): for instance, the results of benchmarking may remain confidential. Validated data include those in BREFs, or those verified by a third party. The period between benchmarkings is sector-specific and usually long (i.e. years), as benchmark data rarely change rapidly or significantly in a short time period.

4.2.3 Energy efficient design (EED)

The planning phase of a new installation, unit or system (or one undergoing major refurbishment) offers the opportunity to consider the lifetime energy costs of processes, equipment and utility systems, and to select the most energy efficient options, with the best lifetime costs (see Section 2.1(c)).

10. BAT is to optimise energy efficiency when planning a new installation, unit or system or a significant upgrade (see Section 2.3) by considering all of the following:

- a. the energy efficient design (EED) should be initiated at the early stages of the conceptual design/basic design phase, even though the planned investments may not be well-defined. The EED should also be taken into account in the tendering process
- b. the development and/or selection of energy efficient technologies (see Sections 2.1(k) and 2.3.1)
- c. additional data collection may need to be carried out as part of the design project or separately to supplement existing data or fill gaps in knowledge
- d. the EED work should be carried out by an energy expert
- e. the initial mapping of energy consumption should also address which parties in the project organisations influence the future energy consumption, and should optimise the energy efficiency design of the future plant with them. For example, the staff in the (existing) installation who may be responsible for specifying design parameters.

³³ Paradigm blindness is a term used to describe the phenomenon that occurs when the dominant paradigm prevents one from seeing viable alternatives, i.e. 'the way we do it is best, because we've always done it this way'

Applicability: All new and significantly refurbished installations, major processes and systems. Where relevant in-house expertise on ENE is not available (e.g. non-energy intensive industries), external ENE expertise should be sought (see Section 2.3).

4.2.4 Increased process integration

There are additional benefits to seeking process integration, such as optimising raw material usage.

11. BAT is to seek to optimise the use of energy between more than one process or system (see Section 2.4), within the installation or with a third party.

Applicability: All installations. The scope and nature (e.g. level of detail) of applying this technique will depend on the nature, scale and complexity of the installation, and the energy requirements of the component processes and systems.

The cooperation and agreement of a third party may not be within the control of the operator, and therefore may not be within the scope of an IPPC permit. In many cases, public authorities have facilitated such arrangements or are the third party.

4.2.5 Maintaining the impetus of energy efficiency initiatives

To successfully achieve ongoing energy efficiency improvement over time, it is necessary to maintain the impetus of energy efficiency programmes (see Section 2.5).

12. BAT is to maintain the impetus of the energy efficiency programme by using a variety of techniques, such as:

- a. implementing a specific energy efficiency management system (see Section 2.1 and BAT 1)
- b. accounting for energy usage based on real (metered) values, which places both the obligation and credit for energy efficiency on the user/bill payer (see Sections 2.5, 2.10.3 and 2.15.2)
- c. the creation of financial profit centres for energy efficiency (see Section 2.5)
- d. benchmarking (see Section 2.16 and BAT 9)
- e. a fresh look at existing management systems, such as using operational excellence (see Section 2.5)
- f. using change management techniques (also a feature of operational excellence, see Section 2.5).

Applicability: All installations. It may be appropriate to use one technique or several techniques together. The scope and nature (e.g. level of detail) of applying these techniques will depend on the nature, scale and complexity of the installation, and the energy consumption of the component processes and systems. Techniques (a), (b) and (c) are applied and maintained according to the relevant sections referred to. The frequency of application of techniques such as (d), (e) and (f) should be far enough apart to enable the progress of the ENE programme to be assessed, and is therefore likely to be several years.

4.2.6 Maintaining expertise

Human resources are required for the implementation and control of energy efficiency management, and staff whose work may affect energy should receive training (see Section 2.1(d)(i) and (ii), and Section 2.6).

13. BAT is to maintain expertise in energy efficiency and energy-using systems by using techniques such as:

- a. recruitment of skilled staff and/or training of staff. Training can be delivered by in-house staff, by external experts, by formal courses or by self-study/development (see Section 2.6)
- b. taking staff off-line periodically to perform fixed term/specific investigations (in their original installation or in others, see Section 2.5)
- c. sharing in-house resources between sites (see Section 2.5)
- d. use of appropriately skilled consultants for fixed term investigations (e.g. see Section 2.11)
- e. outsourcing specialist systems and/or functions (e.g. see Annex 7.12)

Applicability: All installations. The scope and nature (e.g. level of detail) of applying these techniques will depend on the nature, scale and complexity of the installation, and the energy requirements of the component processes and systems.

4.2.7 Effective control of processes

14. BAT is to ensure that the effective control of processes is implemented by techniques such as:

- a. having systems in place to ensure that procedures are known, understood and complied with (see Sections 2.1(d)(vi) and 2.5)
- b. ensuring that the key performance parameters are identified, optimised for energy efficiency and monitored (see Sections 2.8 and 2.10)
- c. documenting or recording these parameters (see Sections 2.1(d)(vi), 2.5, 2.10 and 2.15).

Applicability: All installations. The scope and nature (e.g. level of detail) of applying these techniques will depend on the sector, nature, scale and complexity of the installation, and the energy requirements of the component processes and systems.

4.2.8 Maintenance

Structured maintenance and the repair of equipment that uses energy and/or controls energy use at the earliest opportunity are essential for achieving and maintaining efficiency (see Sections 2.1(d)(vii), 2.9 and BAT 1).

15. BAT is to carry out maintenance at installations to optimise energy efficiency by applying all of the following:

- a. clearly allocating responsibility for the planning and execution of maintenance
- b. establishing a structured programme for maintenance based on technical descriptions of the equipment, norms, etc. as well as any equipment failures and consequences. Some maintenance activities may be best scheduled for plant shutdown periods
- c. supporting the maintenance programme by appropriate record keeping systems and diagnostic testing
- d. identifying from routine maintenance, breakdowns and/or abnormalities possible losses in energy efficiency, or where energy efficiency could be improved
- e. identifying leaks, broken equipment, worn bearings, etc. that affect or control energy usage, and rectifying them at the earliest opportunity.

Applicability: All installations. The scope and nature (e.g. level of detail) of applying these techniques will depend on the nature, scale and complexity of the installation, and the energy requirements of the component processes and systems. Carrying out repairs promptly has to be balanced (where applicable) with maintaining the product quality and process stability and the health and safety issues of carrying out repairs on the operating plant (e.g. it may contain moving and/or hot equipment, etc.).

4.2.9 Monitoring and measurement

Monitoring and measurement are an essential part of checking in a ‘plan-do-check-act’ system, such as in energy management (Section 2.1). It is also a part of the effective control of processes (see BAT 14).

16. BAT is to establish and maintain documented procedures to monitor and measure, on a regular basis, the key characteristics of operations and activities that can have a significant impact on energy efficiency. Some suitable techniques are given in Section 2.10.

Applicability: All installations. The scope and nature (e.g. level of detail) of applying this technique will depend on the nature, scale and complexity of the installation, and the energy requirements of the component processes and systems.

4.3 Best available techniques for achieving energy efficiency in energy-using systems, processes, activities or equipment

Introduction

Section 4.2.2.3 identifies the importance of seeing *the installation as a whole, and assessing the needs and purposes of the various systems, their associated energies and their interactions*. BAT 7 gives examples of systems commonly found in installations.

In Section 4.2, there are BAT that are generally applicable to all systems, processes and associated activities. These include:

- analysing and benchmarking the system and its performance (BAT 1, 3, 4, 8 and 9)
- planning actions and investments to optimise energy efficiency considering the cost-benefits and cross-media effects (BAT 2)
- for new systems, optimising energy efficiency in the design of the installation, unit or system and in the selection of processes (BAT 10)
- for existing systems, optimising the energy efficiency of the system through its operation and management, including regular monitoring and maintenance (see BAT 14, 15 and 16).

The BAT presented in this section therefore assume that these general BAT in Section 4.2 are also applied to the systems described below, as part of their optimisation.

4.3.1 Combustion

Combustion is a widely used process for both direct heating (such as in cement and lime manufacture, steel making) and indirect heating (such as firing steam boiler systems and electricity generation). Techniques for energy efficiency in combustion are therefore addressed in the appropriate sector BREFs. For other cases, such as combustion in associated activities, the Scope of the LCP BREF states:

'...smaller units can potentially be added to a plant to build one larger installation exceeding 50 MW. This means that all kinds of conventional power plants (e.g. utility boiler, combined heat and power plants, district heating plants.) used for mechanical power and heat generation are covered by this (LCP BREF) work.'

17. BAT is to optimise the energy efficiency of combustion by relevant techniques such as:

- those specific to sectors given in vertical BREFs
- those given in Table 4.1.

	Techniques for sectors and associated activities where combustion is not covered by a vertical BREF				
	Techniques in the LCP BREF July 2006 by fuel type and section				Techniques in this document (the ENE BREF) by section
	Coal and lignite	Biomass and peat	Liquid fuels	Gaseous fuels	
Lignite pre-drying	4.4.2				
Coal gasification	4.1.9.1 4.4.2 7.1.2				
Fuel drying		5.1.2, 5.4.2 5.4.4			
Biomass gasification		5.4.2 7.1.2			
Bark pressing		5.4.2 5.4.4			
Expansion turbine to recover the energy content of pressurised gases				7.1.1 7.1.2 7.4.1 7.5.1	
Cogeneration 4.	5.5 6.1.8	5.3.3 5.5.4	4.5.5 6.1.8	7.1.6 7.5.2	3.4 Cogeneration
Advanced computerised control of combustion conditions for emission reduction and boiler performance	4.2.1 4.2.1.9 4.4.3 4.5.4	5.5.3 6	.2.1 6.2.1.1 6.4.2 6.5.3.1	7.4.2 7.5.2	
Use of the heat content of the flue-gas for district heating	4.4.3				
Low excess air	4.4.3 4.4.6	5.4.7	6.4.2 6.4.5	7.4.3	3.1.3 Reducing the mass flow of the flue-gases by reducing the excess air

	Techniques for sectors and associated activities where combustion is not covered by a vertical BREF				
	Techniques in the LCP BREF July 2006 by fuel type and section				Techniques in this document (the ENE BREF) by section
	Coal and lignite	Biomass and peat	Liquid fuels	Gaseous fuels	
Lowering of exhaust gas temperatures	4.4.3		6.4.2		3.1.1 Reduction of the flue-gas temperature by: <ul style="list-style-type: none"> • dimensioning for the maximum performance plus a calculated safety factor for surcharges • increasing heat transfer to the process by increasing either the heat transfer rate, or increasing or improving the heat transfer surfaces • heat recovery by combining an additional process (for example, steam generation by using economisers,) to recover the waste heat in the flue-gases • installing an air or water preheater or preheating the fuel by exchanging heat with flue-gases (see 3.1.1 and 3.1.1.1). Note that the process can require air preheating when a high flame temperature is needed (glass, cement, etc.) • cleaning of heat transfer surfaces that are progressively covered by ashes or carbonaceous particulates, in order to maintain high heat transfer efficiency. Soot blowers operating periodically may keep the convection zones clean. Cleaning of the heat transfer surfaces in the combustion zone is generally made during inspection and maintenance shutdown, but online cleaning can be applied in some cases (e.g. refinery heaters)
Low CO concentration in the flue-gas	4.4.3		6.4.2		
Heat accumulation			6.4.2	7.4.2	
Cooling tower discharge	4.4.3		6.4.2		
Different techniques for the cooling system (see the ICS BREF)	4.4.3		6.4.2		

	Techniques for sectors and associated activities where combustion is not covered by a vertical BREF				
	Techniques in the LCP BREF July 2006 by fuel type and section				Techniques in this document (the ENE BREF) by section
	Coal and lignite	Biomass and peat	Liquid fuels	Gaseous fuels	
Preheating of fuel gas by using waste heat				7.4.2	3.1.1 Reduction of the flue-gas temperature: <ul style="list-style-type: none"> preheating the fuel by exchanging heat with flue-gases (see 3.1.1). Note that the process can require air preheating when a high flame temperature is needed (glass, cement, etc.)
Preheating of combustion air				7.4.2	3.1.1 Reduction of the flue-gas temperature: <ul style="list-style-type: none"> installing an air preheater by exchanging heat with flue-gases (see 3.1.1.1). Note that the process can require air preheating when a high flame temperature is needed (glass, cement, etc.)
Recuperative and regenerative burners					3.1.2
Burner regulation and control					3.1.4
Fuel choice					Note that the use of non-fossil fuels may be more sustainable, even if the ENE in use is lower
Oxy-firing (oxyfuel)					3.1.6
Reducing heat losses by insulation					3.1.7
Reducing losses through furnace doors					3.1.8
Fluidised bed combustion	4.1.4.2 5	.2.3			

Table 4.1: Combustion system techniques to improve energy efficiency

4.3.2 Steam systems

Steam is a widely used heat transport medium because of its non-toxic nature, stability, low cost and high heat capacity, and flexibility in use. Steam utilisation efficiency is frequently neglected, as it is as not as easily measured as the thermal efficiency of a boiler. It may be determined using tools such as those in BAT 5 in conjunction with appropriate monitoring (see Section 2.10).

18. BAT for steam systems is to optimise the energy efficiency by using techniques such as:

- those specific to sectors given in vertical BREFs
- those given in Table 4.2

Techniques for sectors and associated activities where steam systems are not covered by a vertical BREF		
Techniques in the ENE BREF		
	<i>Benefits</i>	<i>Section in this document</i>
DESIGN		
Energy efficient design and installation of steam distribution pipework	Optimises energy savings	2.3
Throttling devices and the use of backpressure turbines: utilise backpressure turbines instead of PRVs	Provides a more efficient method of reducing steam pressure for low pressure services. Applicable when size and economics justify the use of a turbine	
OPERATING AND CONTROL		
Improve operating procedures and boiler controls	Optimises energy savings	3.2.4
Use sequential boiler controls (apply only to sites with more than one boiler)	Optimises energy savings	3.2.4
Install flue-gas isolation dampers (applicable only to sites with more than one boiler)	Optimises energy savings	3.2.4
GENERATION		
Preheat feed-water by using: <ul style="list-style-type: none"> waste heat, e.g. from a process economisers using combustion air deaerated feed-water to heat condensate condensing the steam used for stripping and heating the feed water to the deaerator via a heat exchanger 	Recovers available heat from exhaust gases and transfers it back into the system by preheating feed-water	3.2.5 3.1.1
Prevention and removal of scale deposits on heat transfer surfaces. (Clean boiler heat transfer surfaces)	Promotes effective heat transfer from the combustion gases to the steam	3.2.6
Minimise boiler blowdown by improving water treatment. Install automatic total dissolved solids control	Reduces the amount of total dissolved solids in the boiler water, which allows less blowdown and therefore less energy loss	3.2.7
Add/restore boiler refractory	Reduces heat loss from the boiler and restores boiler efficiency	3.1.7 2.9
Optimise deaerator vent rate	Minimises avoidable loss of steam	3.2.8
Minimise boiler short cycling losses	Optimises energy savings	3.2.9
Carrying out boiler maintenance		2.9
DISTRIBUTION		
Optimise steam distribution systems (especially to cover the issues below)		2.9 and 3.2.10
Isolate steam from unused lines	Minimises avoidable loss of steam and reduces energy loss from piping and equipment surfaces	3.2.10
Insulation on steam pipes and condensate return pipes. (Ensure that steam system piping, valves, fittings and vessels are well insulated)	Reduces energy loss from piping and equipment surfaces	3.2.11 and 3.2.11.1
Implement a control and repair programme for steam traps	Reduces passage of live steam into the condensate system and promotes efficient operation of end-use heat transfer equipment. Minimises avoidable loss of steam	3.2.12
RECOVERY		

Techniques for sectors and associated activities where steam systems are not covered by a vertical BREF				
Collect and return condensate to the boiler for re-use. (Optimise condensate recovery)	Recovers the thermal energy in the condensate and reduces the amount of makeup water added to the system, saving energy and chemicals treatment			3.2.13
Re-use of flash-steam. (Use high pressure condensate to make low pressure steam)	Exploits the available energy in the returning condensate			3.2.14
Recover energy from boiler blowdown	Transfers the available energy in a blowdown stream back into the system, thereby reducing energy loss			3.2.15
Techniques in the LCP BREF July 2006 by fuel type and by section				
	<i>Coal and lignite</i>	<i>Biomass and peat</i>	<i>Liquid fuels</i>	<i>Gaseous fuels</i>
Expansion turbine to recover the energy content of pressurised gases				7.4.1 and 7.5.1
Change turbine blades	4.4.3	5.4.4	6.4.2	
Use advanced materials to reach high steam parameters	4.4.3		6.4.2	7.4.2
Supercritical steam parameters	4.4.3, 4.5.5		6.4.2	7.1.4
Double reheat	4.4.3, 4.5.5		6.4.2, 6.5.3.1	7.1.4, 7.4.2, 7.5.2
Regenerative feed-water	4.2.3, 4.4.3	5.4.4	6.4.2	7.4.2
Use of heat content of the flue-gas for district heating	4.4.3			
Heat accumulation			6.4.2	7.4.2
Advanced computerised control of the gas turbine and subsequent recovery boilers				7.4.2

Table 4.2: Steam system techniques to improve energy efficiency

4.3.3 Heat recovery

The main types of heat recovery systems are described in Section 3.3:

- heat exchangers (see Section 3.3.1)
- heat pumps (see Section 3.3.2).

Heat exchange systems are widely used with good results in many industrial sectors and systems, and are widely used for implementing BAT 5 and 11. Heat pumps are being increasingly used.

The use of 'wasted' or surplus heat may be more sustainable than using primary fuels, even if the energy efficiency in use is lower.

Heat recovery is not applicable where there is no demand that matches the production curve. However, it is being applied in an increasing number of cases, and many of these can be found outside of the installation, see Section 3.4 and Annex 7.10.

Techniques for cooling and the associated BAT are described in the ICS BREF, including techniques for the maintenance of heat exchangers.

19. BAT is to maintain the efficiency of heat exchangers by both:

- a. monitoring the efficiency periodically, and
- b. preventing or removing fouling

See Section 3.3.1.1.

4.3.4 Cogeneration

There is significant interest in cogeneration, supported at European Community level by the adoption of Directive 2004/8/EC on the promotion of cogeneration, and Directive 2003/96/EC on energy taxation, as well as by various national level policies and incentives. Relatively small scale plants may now be economically feasible, and incentives may also be available. In many cases, cogeneration has been successfully installed due to the assistance of local authorities. See Section 3.4 and Annex 7.10.3 and 7.10.4.

Utilities modelling, described in Section 2.15.2, can assist the optimisation of generation and heat recovery systems, as well as managing the selling and buying of surplus energy.

20. BAT is to seek possibilities for cogeneration, inside and/or outside the installation (with a third party).

Applicability: The cooperation and agreement of a third party may not be within the control of the operator, and therefore may not be within the scope of an IPPC permit.

Cogeneration is as likely to depend as much on economic conditions as ENE optimisation. Cogeneration opportunities should be sought on the identification of possibilities, on investment either on the generator's side or potential customer's side, identification of potential partners or by changes in economic circumstances (heat, fuel prices, etc.).

In general, cogeneration can be considered when:

- *the demands for heat and power are concurrent*
- *the heat demand (on-site and/or off-site), in terms of quantity (operating times during year), temperature, etc. can be met using heat from the CHP plant, and no significant heat demand reductions can be expected.*

Section 3.4 discusses the application of cogeneration, the different types of cogeneration (CHP) plants and their applicability in individual cases.

Successful implementation may depend on a suitable fuel and/or heat price in relation to the price of electricity. In many cases, public authorities (at local, regional or national level) have facilitated such arrangements or are the third party.

4.3.5 Electrical power supply

Quality of the electrical power supply and the manner in which the power is used can affect energy efficiency, see Section 3.5. This may be difficult to understand and is often overlooked. There are often energy losses as unproductive power inside the installation and in the external supply grid. There can also be loss of capacity in the installation's electrical distribution system, leading to voltage drops, causing overheating and premature failure of motors and other equipment. It may also lead to increased charges when buying in electricity.

21. **BAT is to increase the power factor according to the requirements of the local electricity distributor by using techniques such as those in Table 4.3, according to applicability (see Section 3.5.1).**

Technique	Applicability
Installing capacitors in the AC circuits to decrease the magnitude of reactive power	All cases. Low cost and long lasting, but requires skilled application
Minimising the operation of idling or lightly loaded motors	All cases
Avoiding the operation of equipment above its rated voltage	All cases
When replacing motors, using energy efficient motors (see Section 3.6.1)	At time of replacement

Table 4.3: Electrical power factor correction techniques to improve energy efficiency

22. **BAT is to check the power supply for harmonics and apply filters if required (see Section 3.5.2).**
23. **BAT is to optimise the power supply efficiency by using techniques such as those in Table 4.4, according to applicability:**

Technique	Applicability	Section in this document
Ensure power cables have the correct dimensions for the power demand	When the equipment is not in use, e.g. at shutdown or when locating or relocating equipment	3.5.3
Keep online transformer(s) operating at a load above 40 – 50 % of the rated power	<ul style="list-style-type: none"> for existing plants: when the present load factor is below 40 %, and there is more than one transformer on replacement, use a low loss transformer and with a loading of 40 – 75 % 	3.5.4
Use high efficiency/low loss transformers	At time of replacement, or where there is a lifetime cost benefit	3.5.4
Place equipment with a high current demand as close as possible to the power source (e.g. transformer)	When locating or relocating equipment	3.5.4

Table 4.4: Electrical power supply techniques to improve energy efficiency

4.3.6 Electric motor driven sub-systems³⁴

Electric motors are widely used in industry. Replacement by electrically efficient motors (EEMs) and variable speed drives (VSDs) is one of the easiest measures when considering energy efficiency. However, this should be done in the context of considering the whole system the motor sits in, otherwise there are risks of:

- losing the potential benefits of optimising the use and size of the systems, and subsequently optimising the motor drive requirements
- losing energy if a VSD is applied in the wrong context.

³⁴ In this document 'system' is used to refer to a set of connected items or devices which operate together for a specific purpose, e.g. ventilation, CAS. See the discussion on system boundaries in Sections 1.3.5 and 1.5.1. These systems usually include motor sub-systems (or component systems).

The key systems using electric motors are:

- compressed air (CAS, see Section 3.7)
- pumping (see Section 3.8)
- heating, ventilation and air conditioning (see Section 3.9)
- cooling (see the ICS BREF).

24. BAT is to optimise electric motors in the following order (see Section 3.6):

1. optimise the entire system the motor(s) is part of (e.g. cooling system, see Section 1.5.1)
2. then optimise the motor(s) in the system according to the newly-determined load requirements, by applying one or more of the techniques in Table 4.5, according to applicability

Driven system energy savings measure	Applicability	Section in this document ¹
SYSTEM INSTALLATION or REFURBISHMENT		
Using energy efficient motors (EEM)	Lifetime cost benefit	3.6.1
Proper motor sizing	Lifetime cost benefit	3.6.2
Installing variable speed drives (VSD)	Use of VSDs may be limited by security and safety requirements. According to load. Note in multi-machine systems with variable load systems (e.g. CAS) it may be optimal to use only one VSD motor	3.6.3
Installing high efficiency transmission/reducers	Lifetime cost benefit	3.6.4
Use: <ul style="list-style-type: none"> • direct coupling where possible • synchronous belts or cogged V-belts in place of V belts • helical gears in place of worm gears 	All	3.6.4
Energy efficient motor repair (EEMR) or replacement with an EEM	At time of repair	3.6.5
Rewinding: avoid rewinding and replace with an EEM, or use a certified rewinding contractor (EEMR)	At time of repair	3.6.6
Power quality control	Lifetime cost benefit	3.5
SYSTEM OPERATION and MAINTENANCE		
Lubrication, adjustments, tuning	All cases	2.9
Note ¹ : Cross-media effects, Applicability and Economics are given in Section 3.6.7		

Table 4.5: Electric motor techniques to improve energy efficiency

3. when the energy-using systems have been optimised, then optimise the remaining (non-optimised) motors according to Table 4.5 and criteria such as:
 - i. prioritising the remaining motors running more than 2000 hours per year for replacement with EEMs
 - ii. electric motors driving a variable load operating at less than 50 % of capacity more than 20 % of their operating time, and operating for more than 2000 hours a year should be considered for equipping with variable speed drives.

4.3.7 Compressed air systems (CAS)

Compressed air is widely used as either part of a process or to provide mechanical energy. It is widely used where there is risk of explosion, ignition, etc. In many cases, it is used as an integral part of the process (such as providing low quality nitrogen as an inert atmosphere, and for blowing, moulding or mixing), and it is difficult to assess its mechanical efficiency. In some cases, e.g. where driving small turbines such as assembly tools, it has a low overall efficiency, and where there are no health and safety constraints, replacement with other drives may be considered (see Section 3.7).

25. **BAT is to optimise compressed air systems (CAS) using the techniques such as those in Table 4.6, according to applicability:**

Technique	Applicability	Section in this document
SYSTEM DESIGN, INSTALLATION or REFURBISHMENT		
Overall system design, including multi-pressure systems	New or significant upgrade	3.7.1
Upgrade compressor	New or significant upgrade	3.7.1
Improve cooling, drying and filtering	This does not include more frequent filter replacement (see below)	3.7.1
Reduce frictional pressure losses (for example by increasing pipe diameter)	New or significant upgrade	3.7.1
Improvement of drives (high efficiency motors)	Most cost effective in small (<10 kW) systems	3.7.2, 3.7.3, 3.6.4
Improvement of drives (speed control)	Applicable to variable load systems. In multi-machine installations, only one machine should be fitted with a variable speed drive	3.7.2
Use of sophisticated control systems		3.7.4
Recover waste heat for use in other functions	Note that the gain is in terms of energy, not of electricity consumption, since electricity is converted to useful heat	3.7.5
Use external cool air as intake	Where access exists	3.7.8
Storage of compressed air near highly-fluctuating uses	All cases	3.7.10
SYSTEM OPERATION and MAINTENANCE		
Optimise certain end use devices	All cases	3.7.1
Reduce air leaks	All cases. Largest potential gain	3.7.6
More frequent filter replacement	Review in all cases	3.7.7
Optimise working pressure	All cases	3.7.9

Table 4.6: Compressed air system techniques to improve energy efficiency

4.3.8 Pumping systems

Some 30 to 50 % of the energy consumed by pumping systems may be saved through equipment or control system changes (see Section 3.8).

For electric motors used for driving pumps, see BAT 24. However, the use of VSDs (a key technique) is also mentioned in Table 4.7.

26. **BAT is to optimise pumping systems by using the techniques in Table 4.7, according to applicability (see Section 3.8):**

Technique	Applicability	Section in this document	Additional information
DESIGN			
Avoid oversizing when selecting pumps and replace oversized pumps	For new pumps: all cases For existing pumps: lifetime cost benefit	3.8.1 3.8.2	Largest single source of pump energy wastage
Match the correct choice of pump to the correct motor for the duty	For new pumps: all cases For existing pumps: lifetime cost benefit	3.8.2 3.8.6	
Design of pipework system (see Distribution system, below)		3.8.3	
CONTROL and MAINTENANCE			
Control and regulation system	All cases	3.8.5	
Shut down unnecessary pumps	All cases	3.8.5	
Use of variable speed drives (VSDs)	Lifetime cost benefit. Not applicable where flows are constant	3.8.5	See BAT 24, in Section 4.3.6
Use of multiple pumps (staged cut in)	When the pumping flow is less than half the maximum single capacity	3.8.5	
Regular maintenance. Where unplanned maintenance becomes excessive, check for: <ul style="list-style-type: none"> • cavitation • wear • wrong type of pump 	All cases. Repair or replace as necessary	3.8.4	
DISTRIBUTION SYSTEM			
Minimise the number of valves and bends commensurate with keeping ease of operation and maintenance	All cases at design and installation (including changes). May need qualified technical advice	3.8.3	
Avoiding using too many bends (especially tight bends)	All cases at design and installation (including changes). May need qualified technical advice	3.8.3	
Ensuring the pipework diameter is not too small (correct pipework diameter)	All cases at design and installation (including changes). May need qualified technical advice	3.8.3	

Table 4.7: Pumping system techniques to improve energy efficiency

Note that throttle control is less energy wasteful than bypass control or no control. However, all are wasteful of energy and should be considered for replacement according to size of the pump and how frequently it is used.

4.3.9 Heating, ventilation and air conditioning (HVAC) systems

A typical HVAC system comprises the equipment providing some or all of the following functions:

- system heating (boilers, see Section 3.2; heat pumps, see Section 3.3.2, etc.)
- cooling (see Section 3.3)
- pumps (see Section 3.8)
- heat exchangers (see Section 3.3.1) transferring or absorbing heat from a space or a process
- space heating and cooling (Section 3.9.1)
- ventilation by fans extracting or providing air through ducts, to or from heat exchangers and/or the external air (see Section 3.9.2).

Studies have shown that about 60 % of the energy in an HVAC system is consumed by the chiller/heat pump and the remaining 40 % by peripheral machinery. Air conditioning is increasingly used across Europe, particularly in the south.

Ventilation is essential for many industrial installations to function. It:

- protects staff from pollutant and heat emissions within premises
- maintains a clean working atmosphere to protect product quality.

Requirements may be dictated by health, safety and process considerations (see Section 3.9).

27. BAT is to optimise heating, ventilation and air conditioning systems by using techniques such as:

- for ventilation, space heating and cooling, techniques in Table 4.8 according to applicability
- for heating, see Sections 3.2 and 3.3.1, and BAT 18 and 19
- for pumping, see Section 3.8 and BAT 26
- for cooling, chilling and heat exchangers, see the ICS BREF, as well as Section 3.3 and BAT 19 (in this document).

Energy savings measure	Applicability	Section in this document
DESIGN and CONTROL		
Overall system design. Identify and equip areas separately for: <ul style="list-style-type: none"> • general ventilation • specific ventilation • process ventilation 	New or significant upgrade. Consider for retrofit on lifetime cost benefit	3.9.1 3.9.2.1
Optimise the number, shape and size of intakes	New or upgrade	3.9.2.1
Use fans: <ul style="list-style-type: none"> • of high efficiency • designed to operate at optimal rate 	Cost effective in all cases	3.9.2.1 3.9.2.2
Manage airflow, including considering dual flow ventilation	New or significant upgrade	3.9.2.1
Air system design: <ul style="list-style-type: none"> • ducts are of a sufficient size • circular ducts • avoid long runs and obstacles such as bends, narrow sections 	New or significant upgrade	3.9.2.1
Optimise electric motors, and consider installing a VSD	All cases. Cost effective retrofit	3.9.2.1, 3.9.2.2, 3.6, 3.6.3, 3.6.7 and BAT 24
Use automatic control systems. Integrate with centralised technical management systems	All new and significant upgrades. Cost effective and easy upgrade in all cases	3.9.2.1 3.9.2.2
Integration of air filters into air duct system and heat recovery from exhaust air (heat exchangers)	New or significant upgrade. Consider for retrofit on lifetime cost benefit. The following issues need to be taken into account: the thermal efficiency, the pressure loss, and the need for regular cleaning	3.9.2.1 3.9.2.2
Reduce heating/cooling needs by: <ul style="list-style-type: none"> • building insulation • efficient glazing • air infiltration reduction • automatic closure of doors • destratification • lowering of temperature set point during non-production period (programmable regulation) • reduction of the set point for heating and raising it for cooling 	Consider in all cases and implement according to cost benefit	3.9.1
Improve the efficiency of heating systems through: <ul style="list-style-type: none"> • recovery or use of wasted heat (Section 3.3.1) • heat pumps • radiative and local heating systems coupled with reduced temperature set points in the non occupied areas of the buildings 	Consider in all cases and implement according to cost benefit	3.9.1
Improve the efficiency of cooling systems through the use of free cooling	Applicable in specific circumstances	3.9.3
MAINTENANCE		
Stop or reduce ventilation where possible	All cases	3.9.2.2
Ensure system is airtight, check joints	All cases	3.9.2.2
Check system is balanced	All cases	3.9.2.2
Manage airflow: optimise	All cases	3.9.2.2
Air filtering, optimise: <ul style="list-style-type: none"> • recycling efficiency • pressure loss • regular filter cleaning/replacement • regular cleaning of system 	All cases	3.9.2.2

Table 4.8: Heating, ventilation and air conditioning system techniques to improve energy efficiency

4.3.10 Lighting

Health and safety at work is the priority criterion for lighting systems requirements. The energy of lighting systems can be optimised according to the specific use requirements, see Section 3.10.

28. **BAT is to optimise artificial lighting systems by using the techniques such as those in Table 4.9 according to applicability (see Section 3.10):**

Technique	Applicability
ANALYSIS and DESIGN OF LIGHTING REQUIREMENTS	
Identify illumination requirements in terms of both intensity and spectral content required for the intended task	All cases
Plan space and activities in order to optimise the use of natural light	Where this can be achieved by normal operational or maintenance rearrangements, consider in all cases. If structural changes, e.g. building work, is required, new or upgraded installations
Selection of fixtures and lamps according to specific requirements for the intended use	Cost benefit on lifetime basis
OPERATION, CONTROL, and MAINTENANCE	
Use of lighting management control systems including occupancy sensors, timers, etc.	All cases
Train building occupants to utilise lighting equipment in the most efficient manner	All cases

Table 4.9: Lighting system techniques to improve energy efficiency

4.3.11 Drying, separation and concentration processes

The separation of (usually) a solid from a liquid may be carried out by one or more stages. By optimising the process steps necessary to achieve the required product, substantial energy savings can be achieved. Energy efficiency may be optimised by using two or more techniques in combination (see Section 3.11).

29. **BAT is to optimise drying, separation and concentration processes by using techniques such as those in Table 4.10 according to applicability, and to seek opportunities to use mechanical separation in conjunction with thermal processes:**

Technique	Applicability	Additional information	Section in this document
DESIGN			
Select the optimum separation technology or combination of techniques (below) to meet the specific process equipments	All cases		3.11.1
OPERATION			
Use of surplus heat from other processes	Depends on the availability of surplus heat in the installation (or from third party)	Drying is a good use for surplus heat	3.11.1
Use a combination of techniques	Consider in all cases	May have production benefits, e.g. improved product quality, increased throughput	3.11.1
Mechanical processes, e.g. filtration, membrane filtration	Process dependent. To achieve high dryness at lowest energy consumption, consider these in combination with other techniques	Energy consumption can be several orders of magnitude lower, but will not achieve high % dryness	3.11.2
Thermal processes, e.g. <ul style="list-style-type: none"> • directly heated dryers • indirectly heated dryers • multiple effect 	Widely used, but efficiency can be improved by considering other options in this table	Convective (direct) heat dryers may be the option with the lowest energy efficiency	3.11.3 3.11.3.1 3.11.3.2 3.11.3.3 3.11.3.6
Direct drying	See thermal and radiant techniques, and superheated steam	Convective (direct) heat dryers may be the option with the lowest energy efficiency	3.11.3.2
Superheated steam	Any direct dryers can be retrofitted with superheated steam. High cost, needs lifetime cost benefit assessment. High temperature may damage product	Heat can be recovered from this process	3.11.3.4
Heat recovery (including MVR and heat pumps)	Consider for almost any continuous hot air convective dryers	3.	11.1 3.11.3.5 3.11.3.6
Optimise insulation of the drying system	Consider for all systems. Can be retrofitted		3.11.3.7
Radiation processes e.g. <ul style="list-style-type: none"> • infrared (IR) • high frequency (HF) • microwave (MW) 	Can be easily retrofitted. Direct application of energy to component to be dried. They are compact and Reduce the need for air extraction. IR limited by substrate dimensions. High cost, needs lifetime cost benefit assessment	More efficient heating. Can boost production throughput coupled with convection or conduction	3.11.4
CONTROL			
Process automation in thermal drying processes	All cases	Savings of between 5 and 10 % can be achieved compared with using traditional empirical controllers	3.11.5

Table 4.10: Drying, separation and concentration system techniques to improve energy efficiency

5 EMERGING TECHNIQUES FOR ENERGY EFFICIENCY

5.1 Flameless combustion (flameless oxidation)

Description

Recuperative and regenerative burners are used in a novel combustion mode with homogeneous flame temperature (High temperature air combustion (HiTAC) technology or flameless combustion), without the temperature 'hot spots' of a conventional flame, in a substantially extended combustion zone.

Flameless combustion corresponds to a combustion mode where the techniques of combustion staggering and internal recirculation in the thermal chamber have been taken to an extreme. The working principle for regenerative burners is shown in Figure 5.1.

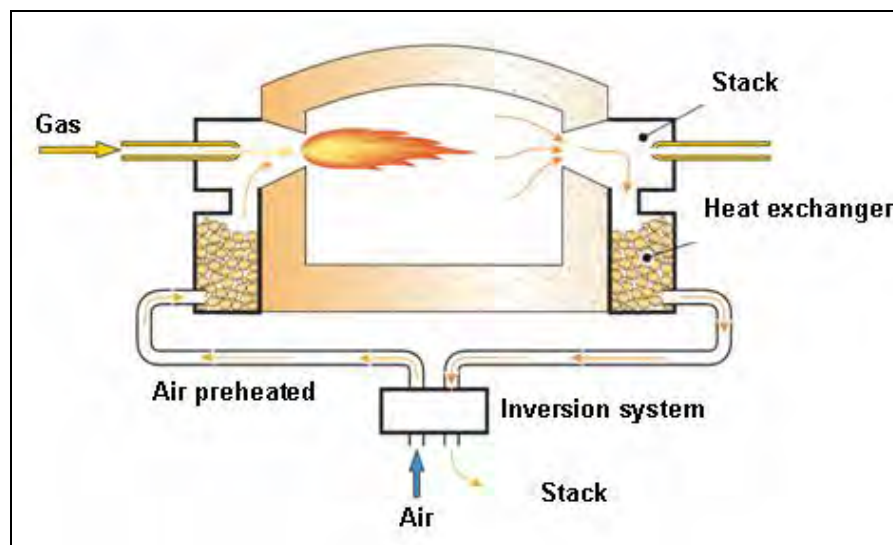

Figure 5.1: Working principle for regenerative burners
[277, ADEME]

There are two types of HiTAC burners: one-flame burners and two-flame burners. A one-flame HiTAC burner is characterised by a single flame created by one fuel nozzle surrounded by air inlets and flue-gas outlets. This single flame develops a long tube axis of the fuel-jet nozzle during cooling and heat periods. Fuel is supplied continuously through the same nozzle and in this way a single flame can be formed with a permanent position. The position of the flame remains almost unchanged between heating and cooling periods, as the regenerators are located around the nozzle of the fuel jet.

In a two-flame HiTAC burner, there are two separated high-cycle regenerative burners. The two burners are located in the walls of the furnace and work in pairs. A set of valves change the direction of the air and flue-gases according to the required switching time. Normally there are several pairs of burners working together. In this type of HiTAC, the flame is shifted from one burner to another in accordance with the switching time between the heating and cooling periods of the regenerator.

The air preheated by the combustion products ($>1000\text{ }^{\circ}\text{C}$) feeds the oven (Figure 5.1). In traditional systems, such an air preheating would lead to very high local temperatures in the flame, and therefore to high NO_x emission levels. In the flameless oxidation systems, on the contrary, the air inlet and the gas feeding inputs are carried out separately (extreme combustion staggering) at high injection speeds. The burner and combustion chamber geometries, and the high speed of flow gases create the recirculation of the combustion products towards the burner. This leads to a decrease in the O_2 local concentration and a thermal dilution of the flame (two NO_x formation sources).

The high air combustion temperature ($>1000\text{ }^{\circ}\text{C}$) preheated by the heat recuperative regenerative system initiates the ignition and sustainability of this combustion mode.

The combustion is therefore distributed around the whole volume of the chamber. The flame cannot be seen by the naked eye. The relative homogeneity in temperature and composition inside the chamber is one of the main characteristics of the process.

The principle of a flameless oxidation may also be implemented with non-preheated air combustion but at a high process temperature ($800\text{ }^{\circ}\text{C}$). In this case, the process needs initiation.

Achieved environmental benefits

According to tests, the HiTAC burner has reached 35 % higher efficiency than a conventional jet burner. Besides the higher efficiency, the HiTAC burner's large flame volume resulted in an increased heat transfer coefficient. The fuel used in the test was LPG (propane). The energy balance for both the HiTAC and the conventional burner is shown in Figure 5.2.

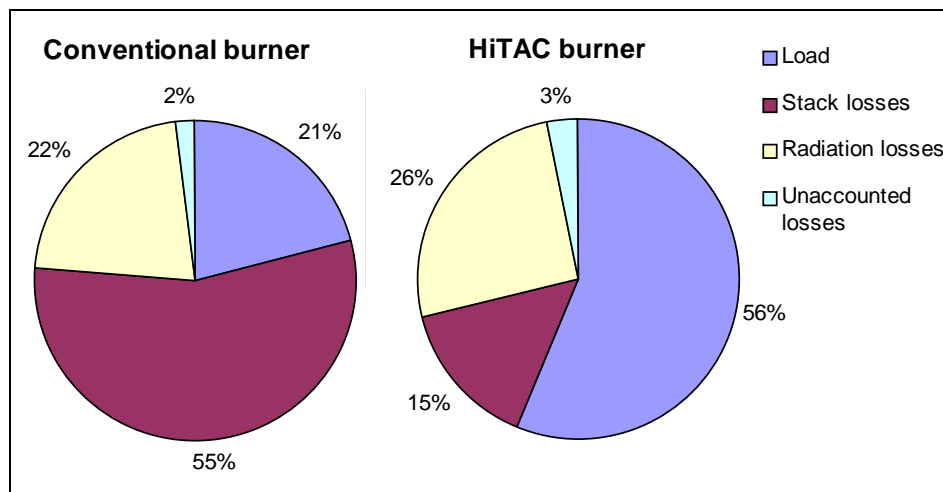

Figure 5.2: The net heat output results according to test furnaces of both conventional and HiTAC burners
[17, Åsbländ, 2005]

The flameless combustion technique provides a large decrease of NO_x emissions thanks to a strong recirculation of the combustion products ($<200\text{ mg/Nm}^3$ at 3 % O_2). This technique avoids temperature peaks, as shown in Figure 5.3. In this figure, a comparison between the different combustion types as a function of combustive temperature and its O_2 concentration is shown.

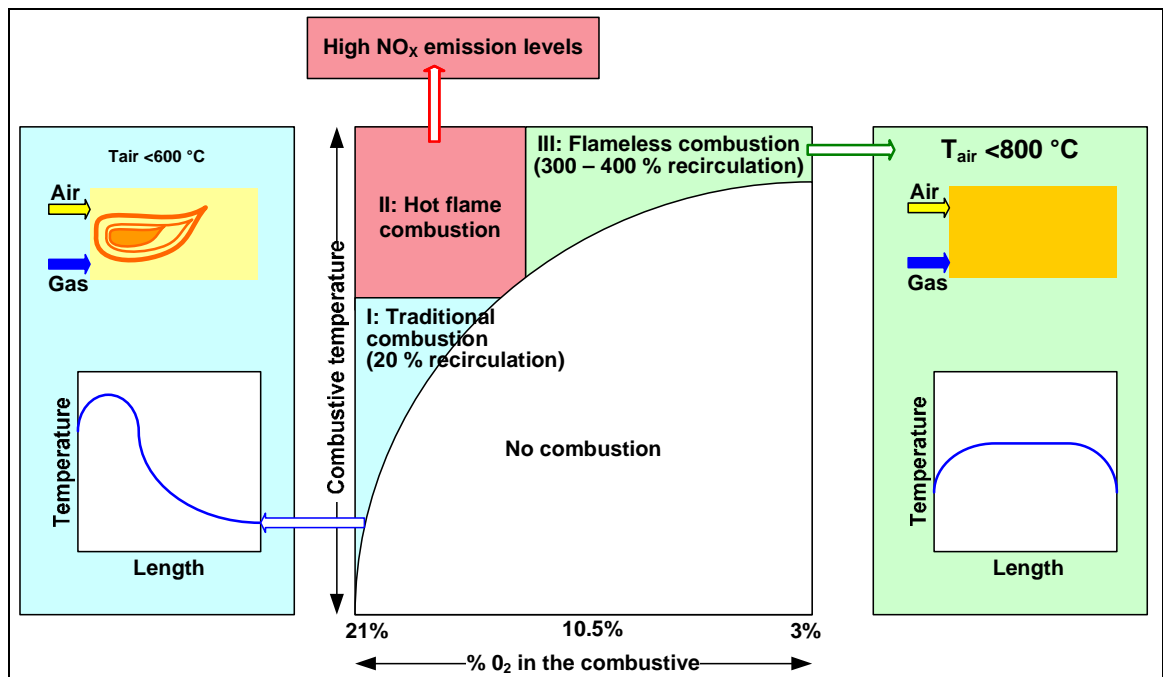

Figure 5.3: Flameless combustion conditions

In the flameless oxidation mode, due to the decreasing temperature peaks, the average temperature level at the oven can be augmented, without local overheating near the burners (with medium impact onto the refractory's oven). The heating transfer towards the product can be considerably increased, while the noise is strongly reduced. These conditions lead to:

- energy savings of between 9 and 40 %
- NO_x emission reduction of between 6 and 80 %.

Cross-media effects

No data submitted.

Operational data

A HiTAC furnace achieves:

- high energy utilisation efficiency, or decreased CO_2 emissions
- a more uniform temperature profile
- low NO_x and CO emissions
- lower combustion noise
- no need for extra energy saving devices
- smaller flue-gas tubes
- even temperature distribution
- enhanced heat transfer
- increased product quality productivity
- longer lifetime of furnace and tubes.

In HiTAC technology, the combustion air is preheated to a very high temperature before it is injected into the furnaces at high speed. Operating in the flameless combustion mode allows fuel to burn completely at very low oxygen levels. This method makes the flame longer, slows combustion speeds, and keeps combustion temperatures lower than those of conventional high temperature combustion furnaces, thus effecting lower NO_x emissions as well as more uniform flame temperature distribution. The flame turns distinctively pale green during the process.

This combustion technique also utilises the concept of separated fuel and hot air injection into the furnace. This gives better furnace performance and higher fuel savings.

For HiTAC's industrial application, fuel nozzles and combustion air nozzles are arranged on the burner at a certain distance from each other. Fuel and high temperature air are injected directly into the furnace at high velocity. Thereby the gas in the zone near the burner is thoroughly mixed and its partial pressure of oxygen is lowered. The combustion stability of fuel directly injected into this zone with oxygen at low partial pressure is possible if the temperature in the preheated air exceeds the auto ignition temperature of the fuel.

In the industrial furnace, the combustion air can be obtained at a temperature of 800 – 1350 °C using a high performance heat exchanger. For example, a modern regenerative heat exchanger switched in the high cycle can recover as much as 90 % of the waste heat. Thus, a large energy saving is achieved.

Applicability

Heating furnaces, where regenerative burners using flameless combustion technology could be applied, are widespread in several sectors throughout Europe; these sectors include iron and steel, bricks and tiles, non-ferrous metals, foundries and at the time of writing potentially a few applications in small glass furnaces. For instance, 5.7 % of the primary energy demanded in the EU is used in the steel industry. Energy also accounts for a high proportion of production costs in these industries.

This technique is not always applicable to existing process lines, because the furnaces need to be designed so that the burners fit in. HiTAC burners also have quite high demands for purity of the atmosphere: if process gas is utilised, there will be too much dust in the furnace to use HiTAC burners.

Economics

A drawback with this technique is the investment cost of the burners. However, the payback rates are often below 3 to 5 years. Therefore, higher productivity in the furnace and low emissions of nitrogen oxides are important factors to be included in the cost-benefit analysis.

Driving force for implementation

Higher productivity in the furnace and lower emissions of nitrogen oxides are important factors.

Examples

The steel manufacture S SAB Tunnplåt AB in Borlänge, Sweden has installed one pair of regenerative burners using HiTAC technology in a walking beam furnace. The furnace preheats steel slabs with a total capacity of 300 tonnes/h. The fuel to the burners is heavy fuel oil. The installation consists of two burners, which, in regenerative mode, burn in a sequence of 60 seconds each interval (changing between burning fuel and suction of waste gas every minute).

The HiTAC burners are installed in the preheating zone of the furnace, where no burners were previously installed. After the preheating zone there is a heating zone (zone 2). The capacity of the new installation is about 10 % of the capacity in zone 2. Each HiTAC burner has the capacity of approx. 2MW. The total number of burners in the furnace is 119.

This long time test of a pair of regenerative burners in a oil-fired furnace showed a very good reliability and that the necessity of maintenance on the installation has been low.

A comparison with an ordinary recuperative burner system shows a approximately 12 % fuel savings due to the higher heat recovery ratio. The one pair of regenerative burners has been dimensioned to increase the productivity in the furnace by 2 %. The measurement of the NO_x contents in the flue-gases in the vicinity of the HiTAC burners also showed that the pair of HiTAC burners did not add any extra contribution to the total amount of NO_x concentrations of approx. 150 ppm (4 % O₂ content).

Reference information

[17, Åsblom, 2005], [26, Neisecke, 2003], [277, ADEME].

5.2 Compressed air energy storage**Description**

Compressed air energy storage (CAES) is a complex energy storage technique in which air is compressed by using energy (usually electricity from the power grid at off-peak times) and utilises that energy later to generate surplus energy as needed. The compressed air is often stored in appropriate underground mines or caverns created inside salt rocks.

Achieved environmental benefits

It depends on application. Compressed air energy storage may facilitate the feed-in of large amounts of wind energy into the grid or the number of starts and shutdowns of power plants may be reduced.

Cross-media effects

If the cavern used to store air needs to be created, there may be environmental disadvantages.

Operational data

Excess power from the grid in the example plants below is used in an electric motor to drive a compressor. The compressed air is cooled, and used to fill a large cavern, heated and then supplied to a modified gas turbine. The energy from the compressed air, together with that supplied from combustion processes drives the turbine stage, and is thus converted by an electrical generator and re-supplied to the grid.

Applicability

There are two plants in operation. Compressed air energy storage is rather an energy management than an energy efficiency technique, as it is used to decouple the timing of generation and consumption of electric energy. However, energy gets lost as the storage efficiency is less than 80 %.

The technique may be suitable where there is access to suitable compressed air storage and surplus off-peak energy to generate compressed air.

Economics

Three possible implementation scenarios economically viable are:

- central device (300 MW, best prospects commercially)
- decentralised device (50 MW)
- remote island (30 MW).

Driving force for implementation

Strong requirement for energy storage to deliver the energy when needed.

Example plants

A 290 MW unit built in Hundorf (Germany) in 1978, and a 110 MW unit built in McIntosh, Alabama (US) in 1991. A third commercial CAES plant (2700 MW) is planned for construction in Norton, Ohio (US).

Reference Literature

[281, EWEC, 2004] [282, Association]

6 CONCLUDING REMARKS

6.1 Timing and progress of the work

The kick-off meeting of the technical working group (TWG) was held in May 2005 and the first draft was issued for consultation in April 2006. The second draft, with proposals for best available techniques (BAT), was issued for consultation in July 2007. The final TWG meeting was held in November 2007.

6.2 Sources of information

Energy is used in many ways in modern society and its industries. The importance of energy efficiency was recognised when the first steam engines were developed in the industrial revolution. The study of energy and energy conversion is called thermodynamics, and the fundamental laws of thermodynamics referred to briefly in this document date from this time. More recently, the impacts of climate change from combustion (the major route globally for delivering various types of energy) and the cost and security of energy supply have become high profile issues, creating much interest and a large amount of published information. Most data used from the information exchange has been taken from studies dated 2000 to 2007, but some data from the 1990s are also included, as important key concepts have not changed.

The vast amount of data available on energy efficiency relates to a very wide range of topics, not all related to IPPC. It is also usual to find the scope of horizontal BREFs can be very wide, and both these issues added to the challenge of managing the information exchange. Therefore, in developing this document, the focus has been to address energy efficiency as one of the key considerations of the IPPC Directive, by providing information on the best available techniques (BAT) to support the implementation of IPPC at a European and installation level.

The data are widely spread by information type, predominantly:

- specific data mainly from energy-intensive industries, (e.g. glass, chemicals, metallurgy)
- data on cross-cutting technologies (e.g. combustion, steam, motor drives, pumps, compressed air)
- general data produced on energy efficiency for all industries and businesses – not only those of IPPC size.

Sources of information used were also widespread, such as EU-funded projects, energy efficiency programmes in Member States and other countries (mainly the US and Japan), industry papers and journals as well as text books. To make energy efficiency relevant to a wide audience, many of these documents gave examples of one or (usually) more techniques used in combination by installations or companies. This added to the challenge of presenting the data, as it was therefore necessary to identify and describe the individual techniques according to the BREF Outline and Guide. To help with the understanding of the techniques, and how they may be used together, many of the examples are given in the annexes and are cross-referenced.

Good practice or BAT guides for energy efficiency were received from the following MS: Austria, Germany, the Netherlands and the UK. While these gave a good overview, more detailed data were made available in technology- or industry-specific sources: for example, France contributed over 100 documents on individual technologies, issues and examples, and Finland contributed a further 11 documents. Spain provided a review of the fundamentals of thermodynamics to support the scientific understanding of this work, which has been included as an annex.

The data directly from industry came from some of the major energy intensive industries (chemicals and petro-chemicals, waste incineration, iron and steel, electricity generation, and glass), as well as the manufacturers of compressed air systems. Data on other energy-using systems, techniques and examples in non-energy intensive industries came from EU-funded programmes and Member States.

A major source of data were the comments from the TWG to the two drafts, and the accompanying additional information: approximately 2300 comments in total. Further information has been sought and exchanged to clarify and verify individual techniques and comments. Among many other sources, the online encyclopaedia Wikipedia has been used to clarify certain terms and there are differing views on its usefulness. Some TWG members prefer traditional sources and references that have been peer-reviewed, while others accepted its ease of access compared with these traditional sources. Wikipedia definitions have not been used for critical areas, such as the BAT conclusions.

There was little information on energy efficiencies achieved by individual techniques and only limited data on general indicative energy savings in some cross-cutting techniques and examples. It was therefore not possible to conclude on energy efficiency values for individual techniques, although some indicative values are given with some of the techniques in Chapters 2 and 3, and in the examples in the annexes. These are thought to provide helpful information on the varying magnitude of energy savings when selecting techniques at a site level.

Information also came from site visits and bilateral meetings in Member States and with industries.

Additional problems in assessing and using the data were that many documents (or approaches taken by different sources) took different routes to the same end, and the same techniques were often given unrelated names. This meant that data may not have been found in the anticipated documents, or were not readily identified in electronic or manual searches. The sources were not always directed at IPPC-type installations, and/or the subjects overlapped. For example, many areas in an installation are heated, ventilated and/or cooled. In building technology, this subject area is referred to as HVAC (heating, ventilation and air conditioning). However, most data seem to be derived for offices and commercial buildings, and it was not clear if this applies to industrial situations, such as ventilation of fumes from industrial processes, or whether more data need to be added.

6.3 Degree of consensus

At the final TWG meeting in November 2007, a high level of consensus was achieved on the format of the document and the techniques to be considered. Most importantly, there was also complete consensus that the conclusions could be expressed as horizontal BAT for all the industries and installations within the scope of the IPPC Directive. No split view was recorded.

In this horizontal document (covering widely differing industries and applications), it was not possible to identify data on energy efficiency values for each technique. However, two points should be noted:

- a key BAT agreed was that each installation should agree its own ENE markers and measure its own performance against these, using a selection of energy efficiency techniques
- key energy efficiency techniques and data for the first round of 'vertical', process specific BREFs are summarised in [283, EIPPCB].

6.4 Gaps and overlaps in knowledge and recommendations for future information gathering and research

6.4.1 Gaps and overlaps in data

Data on techniques

There was a lack (or apparent lack) of data submitted or clarity on the following issues:

- Energy efficiency design (EED): the submitted data indicated that there were energy efficiency gains from the use of external energy efficiency specialists and the identification (and discarding) of tenders and/or manufacturers who would not benefit from optimising energy efficiency (e.g. where the lowest initial capital cost was presented, rather than the life time cost). However, energy intensive industries have significant internal expertise, and felt these issues are tackled sufficiently well internally, and no conclusion was reached on including these techniques in the BAT. Further detailed information is needed on examples from applying these two techniques in energy efficient design.
- Effective control of processes: specific techniques and parameters for control should be investigated for vertical sectors when updating BREFs.
- Monitoring and measuring are both vital to achieve energy efficiency. Although the data received and used in Section 2.10 are useful, they do not reflect fully the range of possible techniques that can be used in all sectors. This may reflect the lack of attention this has been given in the source documents. It would be helpful for vertical sector BREFs to describe appropriate techniques, either directly or referenced from this document. Further information on monitoring and measuring is also needed for the revision of this document.
- Combustion and steam: a large amount of information exists on these topics. They are both dealt with at length in the LCP BREF, which states that the work of the LCP information exchange covered all kinds and sizes of conventional power plants (e.g. utility boilers, combined heat and power plants, district heating systems) used for mechanical power and heat generation; above and below the 50 MW IPPC threshold for LCP. However, many additional techniques not found in the LCP BREF were supplied during the information exchange for ENE. The conclusion was to list and refer to the techniques found in the LCP BREF in this document, and add the additional techniques. Additional information is needed for:
 - techniques on combustion and/or steam systems not currently used in larger scale installations. For example, although FBC (fluidised bed combustion) is described in the LCP BREF, it is used more widely, and an overview of its applicability in other sectors and its advantages and disadvantages would be helpful in this document. See also high temperature flameless combustion (Section 5.1).
 - steam: data are needed for identifying when steam is BAT for heating and process use.
- Heat recovery: data are missing to support the identification of the BAT for using heat exchangers and heat pumps.
- Heating, ventilation and air conditioning (HVAC): Section 3.9 is constructed around data on ventilation systems. However, while references are made to other components for HVAC systems (such as pumps and heat exchangers), data were not available on HVAC as a coherent system (including from the EU website quoted). Additional data may also be required on industrial extraction techniques from processes (analogous to that found in

the STM BREF): this could be gathered for use in this horizontal BREF, or for the vertical sector BREFs.

- Chilling systems: it was anticipated that these would be covered by the HVAC section. However, the large scale chilling of areas for storing perishable raw materials and products (in particular foodstuffs) consumes a significant amount of energy in EU industrial sectors, and further information is needed for the review. UN Environmental Programme (UNEP) data on the latest discussions on the Montreal Protocol were received too late for inclusion in this document. An important technique appears to be the use of the right refrigerants (and therefore the right equipment systems) in industrial chillers. Important points appear to be:
 - that the refrigerants should not only have zero ozone-depleting potential, but also low greenhouse warming potential and lower energy demand in use
 - equipment and handling techniques should be available to manage the risk of releases during operation, as well as during replacement or cessation of use.

More information is required.

- Cooling systems: this topic is covered in the ICS BREF (industrial cooling systems). The primary BAT conclusion for cooling in the ICS BREF is to use the surplus heat from one source for meeting all or part of the heat demands of another system (which may be part of the same process or installation, or external to the installation). This and other principle BAT findings from the ICS BREF are summarised in this document to assist users.
- Power correction for electrical power supplies: two sources gave 0.95 as the power factor to be aimed for. However, correction to this factor cannot be economically achieved by certain activities, such as arc furnaces. Other industries were not sure what power factors would be appropriate to their activities, so no consensus could be agreed on what value should be achieved, and whether this was industry-specific. More data are required on this. Suitable industry-specific factors should be ascertained when updating vertical sector BREFs.
- Compressed air systems (CAS): there was a lack of information to enable the identification of when the use of compressed air is BAT. It is clear that where it is integrated into major process activities (e.g. producing low grade nitrogen as a process gas, blowing glass), it cannot readily be replaced. However, for some horizontal associated activities, such as a transport medium, in assembly tools, etc., more data are required to advise on when the use of a CAS is BAT. A good practice energy efficiency benchmark was provided, but is too general to be used with the BAT. Further information is needed to derive benchmarks by compressor type, etc.
- Drying and separation techniques: these have been placed together, as a key BAT conclusion is, where technically feasible, to use more than one stage when drying products, e.g. to use mechanical separation followed by a heated drying stage. However, there are still areas and techniques for drying and separation which are not described here.
- No data were received on the following:
 - vacuum systems
 - building insulation: no data were supplied in a form that could readily be used
 - control of heat loss/gain at building ingress points, such as doors and windows
 - internal transport systems, such as conveyors, powder movement by compressed air, etc.

Recommendation

The gaps identified above should be addressed with further information when this document is reviewed, or when reviewing other related horizontal documents in the BREF series (such as the ICS BREF and the CWW BREF, etc.).

Cost data

As with many BREFs, there was a lack of cost and cost benefit data for most techniques. This is difficult to address in a horizontal BREF, as the size and application differs from industry to industry. In some cases, this is addressed by the examples given in the annexes.

6.4.2 Specific operational data

In preparing this document, energy efficiency data were sought that could be used for assessing the various techniques described in different installation types. Some indicative data are included, particularly in Chapter 3 and in the examples in the annexes. However, it was not possible to provide more specific operational data, because of the wide variety of possible applications in different installations and processes covered by a horizontal BREF document. (See also Section 6.4.3, below).

Also, it was often difficult to establish costs data, such as ranges of cost for equipment and techniques.

Recommendation

When reviewing this document, a gain, any generic data on energy consumption and/or efficiency should be sought, such as from equipment suppliers.

In the reviewing of the vertical BREFs, special attention should be paid to updating (or, where it currently does not exist, providing) process-specific energy data, to assist with assessing the energy efficiency of specific processes. The data should be provided as a meaningful measure to the sector concerned (see the discussion in Section 1.4). Data should also distinguish between new and existing plants, and where applicable, other installation and/or process differences, regional differences, etc.

Also, generic data on the costs of applying the techniques described, including from the users, manufacturers and suppliers of techniques, equipment and installations should be sought when reviewing this document.

6.4.3 Research issues and further work

In general, a significant amount of research is underway on energy efficiency, and no new generic areas were identified for future research. Research on new process technologies are more likely to be carried out on a sector- or product-specific basis than generically. However, it is important to note that research in certain areas can be seen to lead to developments that improve energy efficiency. These may well have integrated benefits (such as increased product yield and/or quality, and/or reduced emissions) for example:

- core process technology (e.g. catalysis, biotechnological/biocatalysis approaches)
- using specific radiation wavelengths rather than convection or conduction heating (e.g. microwaves to initiate reactions, using curing technologies in coating systems rather than drying)
- the use of heat recovery in novel applications (e.g. heat recovery in intensive livestock units, use of heat pumps)
- process intensification.

A strong need has been identified for further work in two areas:

- more data, such as for the areas identified in Section 6.4.1, above
- more demonstration projects and programmes to promote the use of existing advanced techniques, where:
 - data are lacking, and/or
 - those techniques are currently only used in one industry or have only achieved limited industrial uptake.

The reasons for the lack of uptake of techniques novel to a sector were identified as the risk taken by one operator in changing, e.g. process conditions on a continuous process, and the potential loss of quality product/production throughput time.

A specific example is high temperature flameless combustion. This is applied commercially in Japan in steel making. It is also used in the US and elsewhere in steel making, bricks and tiles, non ferrous metals, foundries, and potentially in small glass furnaces. A pilot project for an application in steel making has been concluded satisfactorily in the EU, but there is no known commercial implementation, although the technique may save about 30 % of energy consumption in the cases studied.

The EC is launching and supporting, through its RTD programmes, a series of projects dealing with clean technologies, emerging effluent treatment and recycling technologies and management strategies. Potentially these projects could provide a useful contribution to future document reviews. Readers are therefore invited to inform the EIPPCB of any research results which are relevant to the scope of this document (see also the preface to this document).

Current EU-funded energy efficiency-related projects in the CORDIS programme can be found on the project database at <http://cordis.europa.eu>.

This programme changes over time, and some current examples are:

- rumpling protection:
 - development of thin ceramic coatings for protection against temperature and stress-induced rumpling of the metal surface of turbine blades
- SRS NET and EEE:
 - scientific reference system on new energy technologies, energy end-use efficiency and energy RTD
- ECOTARGET:
 - new and innovative processes for radical changes of the European pulp and paper industry
- FENCO-ERA:
 - initiative for fossil energy technologies towards zero emissions power plants
- various new and clean energy technology assessment systems.

6.5 Review of this document

The data on techniques for energy efficiency are largely recent (2000 to 2007), and unlikely to change significantly in the near future. The document structure was significantly changed in the second draft, which drew much additional information and allowed further gaps in this document to be identified (see 6.4.1, above). Filling these gaps would be to the benefit of European industries and a review for this may be considered for 2013, concluding in approximately 2015.

REFERENCES

- 2 Valero-Capilla, A., Valero-Delgado A. (2005). "Fundamentals of energy thermodynamics".
- 3 FEAD and Industry, E. W. T. (2005). "Plug-ins to the Introduction to energy".
- 4 Cefic (2005). "How to define energy efficiency?"
- 5 Hardell, R. and Fors, J. (2005). "How should energy efficiency be defined?"
- 6 Cefic (2005). "Key Aspects of Energy Management".
- 7 Lytras, K., Caspar, C. (2005). "Energy Audit Models".
- 9 Bolder, T. (2003). "Dutch initial document on Generic Energy Efficiency Techniques".
- 10 Layer, G., Matula, F., Saller, A., Rahn, R. (1999). "Determination of energy indicators for plants, manufacturing methods and products (abridged version)".
- 11 Franco, N. D. (2005). "Energy models".
- 12 Pini, A. a. U., A. and Casula, A. and Tornatore, G. and Vecchi, S. (2005). "Energy saving evaluation using pinch analysis tool".
- 13 Dijkstra, A. "Definition of benchmarking".
- 16 CIPEC (2002). "Energy Efficiency Planning and Management Guide".
- 17 Åsbländ, A. (2005). "High temperatur air combustion".
- 18 Åsbländ, A. (2005). "Mechanical Vapour Recompression".
- 20 Åsbländ, A. (2005). "Surplus heat recovery at board mill".
- 21 RVF, T. S. A. o. W. M. (2002). "Energy recovery by condensation and heat pumps at Waste-to-Energy to plants in Sweden".
- 26 Neisecke, P. (2003). "Masnahmen zur Verminderung des Energiverbrauchs bei ausgewählten Einzeltechniken".
- 28 Berger, H. (2005). "Energieefficiencte Technologien umd efficiensteigernde Massnahmen".
- 29 Maes, D., Vrancan, K. (2005). "Energy efficiency in steam systems".
- 31 Despretz, H., Mayer, B. "Auditor"Tools. SAVE-project AUDIT II".
- 32 ADENE (2005). "Steam production".
- 33 ADENE (2005). "Steam netwokrs".
- 34 ADENE (2005). "Heat recovery systems".
- 36 ADENE (2005). "Process control systems".
- 40 ADENE (2005). "Transport energy management".

- 48 Teodosi, A. (2005). "Operating procedure of heat exchangers with flashed steam in an alumina refinery".
- 51 Pini, A., Casula, A., Tornatore, G., Vecchi, S. (2005). "Energy saving evaluation using pinch analysis tools".
- 55 Best practice programme (1998). "Monitoring and Targeting in large companies. Good Practice Guide 112. Best Practice Programme. SAVE".
- 56 Best practice programme (1996). "Monitoring and targeting in small and medium-sized companies. Good practice guide 125".
- 62 UK_House_of_Lords (2005). "Energy Efficiency, Volume I:".
- 63 UK_House_of_Lords (2005). "Energy Efficiency. Volume II: Evidence".
- 64 Linde, E. (2005). "Energy efficient stationary reciprocating engine solutions".
- 65 Nuutila, M. (2005). "Energy Efficiency in Energy Production".
- 67 Marttila, M. (2005). "Pinch Technology for Energy Analysis".
- 89 European Commission (2004). "EMAS Energy Efficiency Toolkit for Small and Medium sized Enterprises".
- 91 CEFIC (2005). "Guidelines for Energy Efficiency in Combustion installation".
- 92 Motiva Oy (2005). "Benchmarking and Energy Management Schemes in SMEs, Draft".
- 93 Tolonen, R. (2005). "Improving the eco-efficiency in the district heating and district cooling in Helsinki".
- 94 ADEME (2005). "Energy efficiency in transport".
- 95 Savolainen, A. (2005). "Electric motors and drives".
- 96 Honskus, P. (2006). "An approach to ENE BREF content".
- 97 Kreith, F. a. R. E. W. (1997). "CRC Handbook of Energy efficiency", 0-8493-2514-5.
- 98 Sitny, P., Dobes, V. (2006). "Monitoring and targeting".
- 107 Good Practice Guide (2004). "A strategic approach to energy and environmental management".
- 108 Intelligent Energy - Europe (2005). "Benchmarking and energy management schemes in SMEs (BESS), Draft".
- 113 Best practice programme (1996). "Developing an effective energy policy. Good practice guide 186".
- 114 Caddet Analysis Series No. 28 (2001). "Energy Conservation in the Pulp and Paper Industry".
- 115 Caddet Analysis Series No. 23 "Industrial Heat Pumps".

- 116 IEA Heat Pump Centre "IEA Heat Pump Centre", <http://www.heatpumpcentre.org>.
- 117 Linnhoff March "Pinch methodology", www.linnhoffmarch.com.
- 118 KBC "Pinch methodology", www.kbcat.com.
- 119 Neste Jacobs Oy "Pinch methodology", www.nestejacobs.com.
- 120 Helsinki Energy (2004). "What is District Cooling?"
www.helsinginenergia.fi/kaukojaahdytys/en/index.html.
- 121 Caddet Energy Efficiency (1999). "Pressured air production and distribution. Caddet Energy Efficiency Newsletter No 3".
- 122 W ikipedia_Combustion (2007). <http://en.wikipedia.org/wiki/Combustion>.
- 123 US_DOE "Improving steam system performance. A source book for industry." Best Practices activity for the U.S. Department of Energy's (DOE) Industrial Technologies Program.
- 125 EIPPCB "LCP BREF".
- 126 EIPPCB "C&L BREF".
- 127 TWG "TWG comments D1", personal communication.
- 128 EIPPCB "LVIC-S BREF".
- 130 US_DOE_PowerFactor "Motor Challenge Fact sheet, Reducing Power Factor Cost".
- 131 ZVEI "Position Paper on the Green Paper on Energy Efficiency: Improving Energy Efficiency by Power Factor Correction".
- 132 W ikipedia_Harmonics, <http://en.wikipedia.org/wiki/Harmonics>.
- 133 AENOR (2004). "EN 12953-10".
- 134 Amalfi, X. (2006). "Boiler Audit House".
- 135 EUROELECTRICS "Harmonics", personal communication.
- 136 CDA "Harmonics", <http://www.copper.org/homepage.html>.
- 137 EC "EURODEEM", <http://re.jrc.ec.europa.eu/energyefficiency/eurodeem/index.htm>.
- 139 US_DOE "Motor Master Plus",
<http://www1.eere.energy.gov/industry/bestpractices/software.html>.
- 140 EC (2005). "Green Paper on Energy Efficiency COM(2005)265 final of 22 June 2005".
- 141 EU (2007). "Berlin Declaration".
- 142 EC (2007). "Energy Efficiency Action Plan October 2007 COM (2006) 545 FINAL".
- 145 EC (2000). "Green Paper: Towards a European Strategy for the security of Energy Supply COM (2000) 769 FINAL Nov 2000".

References

- 146 EC (2004). "Directive 2004/8/EC of the EP and Council on the promotion of cogeneration based on a useful heat demand in the internal energy market and amending Directive 92/42/EEC".
- 147 EC (2006). "Council Directive 2006/32/EC of 5 April 2006 on energy end-use efficiency and energy services and repealing Council Directive 93/76/EEC".
- 148 EC (2005). "Framework Directive 2005/32/EC for the setting of eco-design requirements for energy using products (EuP)".
- 152 EC (2003). "Guidance on Interpretation of "Installation" and "Operator" for the Purposes of the IPPC Directive amended 2007".
- 153 Wikipedia "thermodynamics: laws, definitions, etc".
- 154 C olumbia_Encyclopedia "Enthalpy".
- 156 Beerkens, R. G. C., van Limpt H.A.C., Jacobs, G (2004). "Energy Efficiency benchmarking of glass furnaces", Glass Science Technology, pp. 11.
- 157 Beerkens R.G.C. , v. L., H. (2006). "Analysis of Energy Consumption and Energy Savings Measures for Glass Furnaces".
- 158 Szabo, L., Dr (2007). "Energy efficiency indicators", personal communication.
- 159 EIPPCB (2006). "STS BREF: Surface treatment using organic solvents".
- 160 Aguado, M. (2007). "Site visit, Outokumpo Tornio steel works, Finland", personal communication.
- 161 SEI (2006). "Certified energy management systems".
- 162 SEI (2006). "The New Irish Energy Managment Standard- Aughinish Alumina Experience".
- 163 Dow (2005). "ENE TWG kick off meeting presentation".
- 164 OECD (2001). "The application of biotechnology to industrial sustainability:".
- 165 BESS_EIS "Energy savings in design".
- 166 DEFRA, U. (2003). "Delivering energy efficiency savings".
- 167 EIPPCB (2006). "Economics and cross-media BREF".
- 168 PNEUROP (2007). "Proposed new text for compressed air section (CAS)".
- 169 EC (1993). "SAVE programmes - set up to implement directive 93/76/EEC to limit carbon dioxide emissions by improving energy efficiency".
- 170 EC (2003). "European motor challange programme - Pumping systems programme", European motor challange programme.
- 171 de Smedt P. Petela E., M., I., Brodkorb M. (2006). "Model-based utilities management optimisation and management".
- 172 Maagøe Petersen, P. (2006). "Energy Efficient Design".

- 173 EIPPCB (2003). "Intensive livestock farming BREF".
- 174 EC (2007). "Novel potato process - LIFE project LIFE04ENV/DK/67", LIFE, LIFE04ENV/DK/67.
- 175 Saunders_R. (2006). "Electron Beam: One Way to Mitigate Rising Energy Costs", RADTECH report.
- 176 Boden_M. (2007). "Confirmation: EEFIN report results still valid", personal communication.
- 177 Beacock, S. (2007). "EUREM project", personal communication.
- 179 Stijns, P. H. (2005). "Energy management system - Atrium Hospital, Heerlen. NL", Euro Heat and Power.
- 180 Ankirchner, T. (2007). "European energy manager training project", personal communication.
- 181 Wikipedia "Process control engineering".
- 182 Wikipedia "Discussion and information on quality assurance and quality management:" http://en.wikipedia.org/wiki/ISO_9000.
- 183 Bovankovich (2007). "Energy management: what you need to know", personal communication.
- 186 UBA_AT "Energieeffiziente Technologien und effizienzsteigernde Massnahmen".
- 188 Carbon_Trust_(UK) (2005). "Energy use in Pig Farming ECG089", Energy Consumption Guide.
- 189 Radgen&Blaustein (2001). "Compressed Air Systems in the European Union", LOG-X, 3-932298-16-0.
- 190 Druckluft "System optimisation in CAS", <http://www.druckluft-effizient.de/e/facts/08-system-optimisation.pdf>.
- 191 Druckluft "Compressed Air Distribution", <http://www.druckluft-effizient.de/e/facts/07-air-distribution.pdf>.
- 193 Druckluft "Compressed Air-Example plants", <http://www.druckluft-effizient.de/e/links/downloads.php?m=link>.
- 194 ADEME (2007). "Compressed Air".
- 195 DETR "Air compressors with integral variable speed control", Best Practice Programme, Energy Efficiency, <http://www.druckluft-effizient.de/links/demoprojekte/uk-vsd.pdf>.
- 196 W ikipedia "Compressed Air".
- 197 W ikipedia "Drying".
- 199 TWG "Annex 1622 Front Ends Pump Systems".

References

- 200 TWG "Annex 1612 Front Ends Pump Systems".
- 201 Dresch_ADEME, M. (2006). "DRYING-Proposal for "Energy Efficiency Techniques" BREF".
- 202 IFTS_CMI (1999). "Contribution à l'élaboration de la stratégie de l'ADEME pour la maîtrise de l'énergie dans les procédés de séparation / concentration".
- 203 ADEME (2000). "Les procédés de séchage dans l'industrie".
- 204 CETIAT (2002). "Gains énergétiques induits par l'utilisation des énergies radiantes dans l'industrie: bilans thermiques sur site et retours d'expérience".
- 205 ADEME "Optimisation énergétique du séchage du latex naturel", www.ademe.fr.
- 206 ADEME (2002). "Les énergies radiantes et leurs applications industrielles".
- 207 ADEME (2000). "Mesure de l'humidité des solides dans l'industrie".
- 208 Ali, B. (1996). "Séchage à la vapeur d'eau saturée - Etat de l'art", Cahiers de l'AFSIA.
- 209 Wikipedia "Lighting".
- 210 EC (2000). "The European Motor Green Light Programme", <http://sunbird.jrc.it/GreenLight/>.
- 211 ADEME (1997). "Financer des travaux d'économie d'énergie en hotellerie restauration".
- 212 BRE_UK (1995). "Financial aspects of energy management in buildings - Good practice guide 165".
- 213 EC "Guide to Energy Efficiency Bankable Proposals".
- 214 EC (1996). "Shared energy saving and supply agreement for UK buildings".
- 215 Initiatives, I. C. f. L. E. (1993). "Profiting from energy efficiency! A financing handbook for municipalities".
- 216 Initiatives, I. C. f. L. E. (1995). "Energy Smart Cities, Energy Efficiency Financing Directory".
- 217 Piemonte, R. (2001). "Gestione del servizio di illuminazione pubblica e realizzazione di interventi di efficienza energetica e di adeguamento normativo sugli impianti comunali, con l'opzione del finanziamento tramite terzi - Capitolato tipo d'appalto per le amministrazioni comunali".
- 218 Association, W. E. E. (1997). "Manual on financing energy efficiency projects".
- 219 IDAE "Propuesta de Modelo de Ordenanza Municipal de Alumbrado Exterior".
- 220 Blasiak W., Y., W., Rafidi N., (2004). "Physical properties of a LPG flame with high-temperature air on a regenerative burner," Combustion and Flame, pp. 567-569.
- 221 Yang W., B. W. (25 May 2005,). "Mathematical modelling of NO emissions from High Temperature Air Combustion with Nitrous Oxide Mechanism", Fuel Processing Technology, pp. 943-957.

- 222 Yang W., B. W. (2005). "Flame Entrainments Induced by a Turbulent Reacting Jet Using High-Temperature and Oxygen Deficient Oxidizers", Energy and Fuels, pp. 1473-1483.
- 223 Rafidi N., B. W. (2005). "Thermal performance analysis on a two composite material honeycomb heat regenerators used for HiTAC burners," Applied Thermal Engineering, pp. 2966-2982.
- 224 Mörtberg M., B. W., Gupta A.K (2005). "Combustion of Low Calorific Fuels in High Temperature and Oxygen Deficient Environment." Combustion Science and Technology.
- 225 Rafidi N., B. W., Jewartowski M., Szewczyk D. (June 2005). "Increase of the Effective Energy from the Radiant Tube Equipped with Regenerative System in Comparison with Conventional Recuperative System", IFRF Combustion Journal, article No 200503.
- 226 CADDET (2003, March). "'High-performance Industrial Furnace Based on High-temperature Air Combustion Technology - Application to a Heat Treatment Furnace'".
- 227 TWG "Comments to Draft 2 ENE BREF".
- 228 Petrecca, G. (1992). "Industrial Energy Management".
- 229 Di Franco, N. "Energy diagnose in semi-conductors mill".
- 230 Association, C. D. (2007). "Harmonics", <http://www.copper.org/applications/electrical/pq/issues.html>.
- 231 The motor challenge programme "The motor challenge programme," <http://re.jrc.ec.europa.eu/energyefficiency/motorchallenge/index.htm>.
- 232 60034-30, I. "Rotating electrical machines - Part 30: efficiency classes of single speed, three-phase, cage induction motors (IE code)".
- 233 Petrecca, G. (1992). "Industrial Energy Management".
- 234 P ROMOT "PROMOT", http://promot.cres.gr/promot_plone.
- 236 Fernández-Ramos, C. (2007). "Energy efficient techniques LCP BREF", personal communication.
- 237 Fernández-Ramos, C. (2007). "Cooling in CV BREF", personal communication.
- 238 Hawken, P. (2000). "Natural Capitalism", ISBN 0-316-35300-0.
- 240 Hardy, M. "A Practical Guide to Free Cooling, Alternative Cooling, Night Cooling and Low Energy Systems," <http://www.ambthair.com>.
- 241 Coolmation "Free Cooling".
- 242 DiLouie, C. (2006). "Advanced Lighting Controls: Energy Savings, Productivity, Technology and Applications," ISBN 0-88173-510-8.
- 243 R&D, E. (2002). "Waste water concentration by mechanical vapour recompression (MVR) or heat pump (HP)".

References

- 244 Best practice programme "Compressed air costs reduced by automatic control system", <http://www.druckluft-effizient.de/links/demoprojekte/gpcs137.pdf>.
- 245 Di Franco, N. (2008). "Energy efficient management of transformers".
- 246 ISPRA, D. J. I. (2008). "Figure-Comparison of energy efficient and conventional pumping system", personal communication.
- 248 ADEME (2007). "Drying systems-Proposal for ENE BREF".
- 249 TWG (2007). "TWG Final ENE BREF Meeting Nov 2007".
- 250 ADEME (2006). "Energy Diagnosis Reference Frame for Industry", personal communication.
- 251 Eurostat (2007). "Panorama of Energy".
- 252 EEA (2005). "Atmospheric greenhouse gas concentrations", CSI 013.
- 254 EIPPCB (2005). "Waste Incineration BREF", BREF.
- 255 EC; Waste, P. f. a. D. o. t. E. P. a. t. C. o. and COM_(2005)_667 (2005). "Proposal for a Directive of the European Parliament and the Council on Waste COM (2005) 667".
- 256 Tempany, P. (2007). "Continuing environmental improvement", personal communication.
- 257 Clark, J. H. (2006). "Green Chemistry: today (and tomorrow)", Green Chemistry.
- 258 Tsatsaronis, G. and Valero, A. (1989). "Thermodynamics meets economics - Combining thermodynamics and economics in energy systems", Mechanical Engineering.
- 259 IEA (2006). "Scenarios and strategies to 2050".
- 260 TWG (2008). "Comments on Draft 3: BAT Chapter, etc".
- 261 Carbon_Trust_UK (2005). "Energy use in Pig Farming".
- 262 UK_Treasury (2006). "(The Stern report): The economics of climate change".
- 263 Tempany, P. (2008). "Directly heated drying".
- 264 Tempany, P. (2008). "Indirectly heated drying".
- 265 Tempany, P. (2008). "Insulation and drying".
- 266 Ullmann's (2000). "Ullmann's Encyclopedia of Industrial Chemistry 6th edition electronic release".
- 267 EIPPCB (2006). "STM: Surface treatment of Metals and Plastics".
- 268 Whittaker, G. (2003). "Specifying for industrial Insulation Systems", Steam Digest Volume 4.
- 269 Valero, A. (2007). "Introduction to Thermodynamics for the ENE BREF".

- 270 Tempany, P. (2008). "Estimations and calculations", personal communication.
- 271 US_DOE (2004). "Waste Heat Reduction and recovery for improving furnace efficiency, productivity and emissions performance", DOE/GO-102004-1975.
- 272 Finland, M. O.-. (2007). "Energy audit for transport chains".
- 276 Agency, S. E. P. (1997). "Energy Conservation in the Pulp and Paper Industry", 4712/4.
- 277 ADEME "Récupération de chaleur par préchauffage de l'air".
- 278 ADEME "Space heating".
- 279 Czech_Republic (2006). "Energy Performance Contracting - The ESCO concept".
- 280 UBA_DE (2006). "Energy Services Company (ESCO) concept".
- 281 EWEC (2004). "Proceedings of the European Wind Energy Conference".
- 282 Association, E. S.,
http://www.electricitystorage.org/tech/technologies_technologies_caes.htm.
- 283 EIPPCB "Summary on Energy Efficiency issues in the BREF series".
- 284 Valero, A., Torres, C "Thermoeconomic analysis".
- 285 Valero, A. (1989). "Thermoeconomics: A new chapter of physics".
- 286 F rangopoulos, <http://www.eolss.net/E3-19-toc.aspx>.

GLOSSARY

ENGLISH TERM	MEANING
Symbols	
μm	micrometre ($1 \mu\text{m} = 10^{-6} \text{m}$)
~	around; more or less
$^{\circ}\text{C}$	degree Celsius
θ_0	ambient conditions
ΔT	temperature difference (increase)
ε	exergetic efficiency
σ	entropy production J/K
η	thermal efficiency
A	
A	amp (ampere). The SI symbol for electrical current
AC a	alternating current
AEA	Austrian Energy Agency, also AEA Technology (a UK consultancy)
aka	also known as
AN a	ammonium nitrate (NH_4NO_3)
APH A	air preheater
API	American Petroleum Institute
APQP	advanced product quality planning is a structured method of defining and establishing the steps necessary to ensure that a product satisfies customers. It facilitates communications with all actors involved to ensure that all needed steps are completed on time
ASTM	a large international standards organisation. Originally, the American Society for Testing and Methods, now ASTM International
AT Au	air preheater
atm	atmosphere ($1 \text{atm} = 101325 \text{N/m}^2$)
av a	average
B	
B	exergy
bar	bar ($1.013 \text{bar} = 1 \text{atm}$)
bara ba	bar absolute
barg	bar gauge which means the difference between atmospheric pressure and the pressure of the gas. At sea level, the air pressure is 0 bar gauge, or 101325 bar absolute
BAT	best available techniques
BOOS	burner out of service
Bq B	Becquerel (s^{-1}) – activity of a radionuclide
BREF B	BAT reference document
BTEX	benzene, toluene, ethyl benzene, xylene
C	
C	velocity m/s
C	specific heat of an incompressible substance J/(kgK)
C ₄ stream	a mixture of molecules all having four carbon atoms. Usually: <ul style="list-style-type: none"> • butadiene (C_4H_6) • butene-1, butene-2 and isobutylene (C_4H_8) • N-butanes and isobutene (C_4H_{10})
CAES	compressed air energy storage
CAS	compressed air system

ENGLISH TERM	MEANING
cavitation	when a volume of liquid is subjected to a sufficiently low pressure it may rupture and form a cavity. This phenomenon is termed cavitation inception and may occur behind the blade of a rapidly rotating impeller or propeller or on any surface vibrating underwater (or in fluids generally) with sufficient amplitude and acceleration. Cavitation is usually an undesirable occurrence. In devices such as propellers and pumps, cavitation causes a great deal of noise, damage to components, vibrations, and a loss of efficiency. Although the collapse of cavities is a relatively low energy event, it is highly localised and can even erode metals such as steel. The pitting caused by the collapse of cavities produces great wear on components and can dramatically shorten a propeller's or pump's lifetime
CC c	combined cycle
CCGT	combined cycle gas turbine
CCP	coal combustion products
CDM	clean development mechanisms
CEM c	continuous emission monitoring
CEMS c	continuous emission monitoring system
CEN	European Committee for Standardisation
CENELEC	European Committee for Electrotechnical Standardisation
CFB c	circulating fluidised bed
CFBC	circulating fluidised bed combustion
CFC	chlorofluorocarbon is a compound consisting of chlorine, fluorine, and carbon. CFCs are very stable in the troposphere. They move to the stratosphere and are broken down by strong ultraviolet light, where they release chlorine atoms that then deplete the ozone layer
CHP	combined heat and power (cogeneration)
CIP c	clean-in-place system
cm c	centimetre
COD	chemical oxygen demand: the amount of potassium dichromate, expressed as oxygen, required to chemically oxidise substances contained in waste water (at approx. 150 °C)
COP	coefficient of performance (e.g. for heat pumps)
COPHP	coefficient of performance of heat pump cycle
COPR	coefficient of performance of refrigeration cycle
c_p	specific heat at constant pressure J/(kgK)
continual improvement	a process of improving year by year the results of energy management, increasing efficiency and avoiding unnecessary consumptions
CP	mass flow rate multiplied by specific heat capacity
cross-media effects	the calculation of the environmental impacts of water/air/soil emissions, energy use, consumption of raw materials, noise and water extraction (i.e. everything required by the IPPC Directive)
CTM c	centralised technical management
c_v	specific heat at constant volume J/(kgK)
cv c	control volume
D	
d	day
DBB	dry bottom boiler. The most common type of coal-burning furnace in the electric utility industry is the dry, bottom pulverised coal boiler. When pulverised coal is burned in a dry bottom boiler, about 80 per cent of the unburned material or ash is entrained in the flue-gas and is captured and recovered as fly ash. The remaining 20 per cent of the ash is dry bottom ash, a dark grey, granular, porous, predominantly sand size material that is collected in a water
DC d	direct current
DC d	district cooling
DCS	distributed control systems
DDCC	direct digital combustion control
DE G	Germany

ENGLISH TERM	MEANING
DH d	istrict heating
DK D	enmark
E	
E	exergy J
E	specific flow
e	exergy per unit mass J/kg
EA e	energy audit
EAM	energy audit model
EDTA	ethylenediamine tetraacetic acid
EEl e	energy efficiency indicator
EFF	motor efficiency classification scheme created by the European Commission and the EU motor manufacturers (CEMEP). There are three class levels of efficiency, known as EFF1 (high efficiency motors), EFF2 (standard efficiency motors) and EFF3 (poor efficiency motors), applying to low voltage two- and four-pole motors with ratings of between 1.1 and 90 kW
EGR	exhaust gas recirculation
EIF e	energy intensity factor
EII	energy intensity index: Solomon Associate's benchmarking index for oil refineries
EIPPCB	European IPPC Bureau
ELV	emission limit value. The mass, expressed in terms of certain specific parameters, concentration and/or level of an emission, which may not be exceeded during one or more periods of time
EMAS	European community eco-management and audit scheme
emission	the direct or indirect release of substances, vibrations, heat or noise from individual or diffuse sources in the installation into the air, water or land
EMS	environment management system
EN	European Norm (standard)
ENE e	energy efficiency
ENEMS	energy efficiency management system
energy audit	the process of identification of the energy consumptions, the conservation potentials and appropriate efficiency practices
energy performance	the amount of energy consumed in relation with obtained results. The lower the specific energy consumption, the higher the energy performance
EO e	energy output
EOP, EoP	end-of-pipe
EPC	energy performance contracting
EPER	European pollutant emission register
ESCO/ESCO	energy service company
E _T	total energy J
EU-15	15 Member States of the European Union
EU-25	25 Member States of the European Union
EVO	The efficiency valuation organisation
F	
f	saturated liquid
FAD	free air delivery
FBC	fluidised bed combustion
FBCB	fluidised bed combustion boiler
f _g	difference in property for saturated vapour and saturated liquid
FI Fi	inland
FMEA	failure mode and effects analysis. A systematic process for identifying potential (design and) process failures before they occur, with the intent to eliminate them or minimise the risk associated with them
FR Fr	rance
G	
g	acceleration of gravity m/s ²
g	gram

ENGLISH TERM	MEANING
g	saturated gas
G	Gibbs free energy
G	giga 10 ⁹
GJ g	igajoule
GMO g	enetic modified organism
GPM g	allons per minute
green certificate	a market-based tool to increase use of renewables. Green certificates represent the environmental value of renewable energy production. The certificates can be traded separately from the energy produced
GT g	as turbine
GTCC	gas turbine combined cycle
GW g	igawatt
GWh gi	gawatt hours
GWh _e	gigawatt hours electrical
GWP g	lobal warming potential
H	
H	enthalpy J
h	specific enthalpy J/kg
h	hour
hammer	fluid hammer, see water hammer
harmonics	a sine-shaped component of a periodic wave or quantity having a frequency that is an integral multiple of a fundamental frequency. It is a disturbance in clean power
HCV	higher calorific value, higher combustion value
HCFC	hydrochlorofluorocarbons. A class of haloalcanes where not all hydrogen has been replaced by chlorine or fluorine.
HDPE h	igh-density polyethylene
HF	high frequency radiation. Electromagnetic radiation possessing radio wave frequencies between 3 and 30 MHz
HFO h	eavy fuel oil
HiTAC	High temperature air combustion technology
HMI	human machine interface
HP hi	gh pressure
HPS	high pressure steam. Steam with a pressure much greater than atmospheric
HRSG	heat recovery steam generator
HV	high voltage. The International Electrotechnical Commission and its national counterparts (IEE, IEEE, VDE, etc.) define high voltage circuits as those with more than 1000 V for alternating current and at least 1500 V for direct current, and distinguish it from low voltage (50 – 1000 V AC or 120 – 1500 V DC) and extra low voltage (<50 V AC or <120 V DC) circuits. This is in the context of the safety of electrical apparatus.
HVAC	heating, ventilation and air conditioning
hydrotreater	hydrodesulphurisation (HDS) unit. These are widely used in the petroleum refining industry and are also often also referred to as a hydrotreater. It uses a catalytic chemical process to remove sulphur (S) from natural gas and from refined petroleum products such as gasoline or petrol, jet fuel, kerosene, diesel fuel, and fuel oils
Hz h	erzt
I	
ID in	ternal diameter
IE Ire	land
IEA	International Energy Agency
IEC	International Electrotechnical Commission
IEF	Information Exchange Forum (informal consultation body in the framework of the IPPC Directive)
IGCC	integrated gasification combined cycle

ENGLISH TERM	MEANING
installation	a stationary technical unit where one or more activities listed in Annex I to the IPPC Directive are carried out, and any other directly associated activities which have a technical connection with the activities carried out on that site and which could have an effect on emissions and pollution
IPCC	Intergovernmental Panel on Climate Change
IPPC	integrated pollution prevention and control
IR	infrared radiation. Electromagnetic radiation whose wavelength is longer than that of visible light but shorter than that of terahertz radiation and microwaves, i.e. between 750 nm and 1mm.
IRR	internal rate of return
ISO I	International Standardisation Organisation
ISO 14001	International Organization for Standardization Environmental Management Standard
IT It	Italy
J	
J	joule
JRC J	Joint Research Centre
K	
K	kelvin (0 °C = 273.15 K)
kcal	kilocalorie (1 kcal = 4.19 kJ)
kg ki	kilogram
kJ	kilojoule (1 kJ = 0.24 kJcal)
KN	kinetic energy J
kPa k	kilopascal
kt k	kilotonne
kWh	kilowatt-hour (1 kWh = 3600 kJ = 3.6 MJ)
L	
l	litre
LCP	large combustion plant
LCV	lower calorific value, lower combustion value
lean, lean manufacturing	a generic process management philosophy derived mostly from the Toyota production system (TPS) but also from other sources. It is renowned for its focus on reduction of the original Toyota 'seven wastes' in order to improve overall customer value. Lean is often linked with six sigma because of that methodology's emphasis on reduction of process variation (or its converse smoothness)
LDPE l	low-density polyethylene
LFO	light fuel oil (lighter than HFO)
LHV	lower heating value
lm	lumen: the SI unit of luminous flux. 1 lm = 1 cd·1sr = 1 lux·m ²
LP l	low pressure
LP steam	low pressure steam: steam with a pressure less than, equal to, or not greatly above, atmospheric
LPG liq	liquid petroleum gas
LPS	low pressure steam
lux	(symbol: lx) the SI unit of illuminance. It is used in photometry as a measure of the intensity of light, with wavelengths weighted according to the luminosity function, a standardised model of human brightness perception. In English, "lux" is used in both singular and plural
LVOC	large volume organic chemicals (BREF)
M	
m	mass
m	metre
M	mega 10 ⁶
m/min me	metres per minute
m ²	square metre
m ³	cubic metre
MBPC	model-based predictive control
mg	milligram (1 mg = 10 ⁻³ gram)

ENGLISH TERM	MEANING
MIMO m	ulti-input, multi-output
MJ	megajoule (1 MJ = 1000 kJ = 10 ⁶ joule)
mm	millimetre (1 mm = 10 ⁻³ m)
monitoring	process intended to assess or to determine the actual value and the variations of an emission or another parameter, based on procedures of systematic, periodic or spot surveillance, inspection, sampling and measurement or other assessment methods intended to provide information about emitted quantities and/or trends for emitted pollutants
MP m	edium pressure
MPS	medium pressure steam
MRC	medical research council
MS Me	mber State
MSA	measurement systems analysis. A method using experiments and mathematics to determine how much the variation within the measurement process contributes to overall process variability
Mt	megatonne (1 Mt = 10 ⁶ tonne)
MTBF	mean time between failures
mV	millivolt (mV), 10 ⁻³ volt, 1/1000 of a volt
MV	megavolt (MV) 10 ⁶ volts, 1 000 000 volts
MVR	mechanical vapour recompression system. A type of heat pump
M&V	measurement and verification
MW	microwave radiation. Electromagnetic radiation possessing wavelengths ranging from 1mm to 1 m.
MW _e	megawatts electric (energy)
MWh _e	megawatts hour electric (power)
MWh _h	megawatts hour heat (power)
MW _{th}	megawatts thermal (energy)
N	
N	nozzle
n.a.	not applicable OR not available (depending on the context)
n.d. n	o data
ng	nanogram (1 ng = 10 ⁻⁹ gram)
NG n	atural gas
Nm ³	normal cubic metre (101325 kPa, 273 K)
NMHC n	on-methane hydrocarbons
NMVOC	non-methane volatile organic compounds
NPSH	net positive suction head. It shows the difference, in any cross-section of a generic hydraulic circuit, between the pressure and the liquid vapour pressure in that section. In pump operation, two aspects of this parameter are called respectively NPSH (a) net positive suction head (available) and NPSH (r) net positive suction head (required), where NPSH (a) is computed at the pump inlet port, and NPSH (r) is the NPSH limit the pump can withstand without cavitating. Retrieved from " http://en.wikipedia.org/wiki/NPSH "
O	
OECD	Organisation for Economic Co-operation and Development
OFA o	verfire air
operator	any natural or legal person who operates or controls the installation or, where this is provided for in national legislation, to whom decisive economic power over the technical functioning of the installation has been delegated
°R d	egree Rankin
Otto cycle	four stroke engine
P	
P	peta 10 ¹⁵
P, p	pressure
Pa p	ascal
PCB pol	ychlorinated benzenes
PCDD pol	ychlorinated-dibenzo-dioxins

ENGLISH TERM	MEANING
PCDF pol	polychlorinated-dibenzo-furans
PDCA p	plan-do-check-act cycle
PFBC pr	pressurised fluidised bed combustion
PI p	process-integrated
PID	proportional integral derivative control
PLC	programmable logic controls
PM p	permanent magnet
pollutant	individual substance or group of substances which can harm or affect the environment
ppb	parts per billion
ppm	parts per million (by weight)
ppmvd	parts per million by volume for dry gases
PRV p	pressure reducing valve
PT	potential energy
Q	
Q	heat J
Q̇	heat rate
QFD q	quality function deployment
QMS q	quality management system
R	
R	gas constant J/(gK)
R&D	research and development
R _u	universal gas constant J/(molK)
right first time	a quality management system. A concept integral to total quality management, where there is a commitment to customers not to make mistakes. The approach requires employees at all levels to commit to, and take responsibility for, achieving this goal. Quality circles are sometimes used as a method to help in this process
ROI	return on investment
S	
S	entropy J/K
s	specific entropy J/(kgK)
s	second
saturated steam	steam at the temperature of the boiling point which corresponds to its pressure
SAVE programme	EC energy efficiency programme, now completed
SCADA	supervisory control and data acquisition
SE	Sweden
SEC	specific energy consumption
SEI	Sustainable energy Ireland. Organisation to promote and assist the development of sustainable energy
sensible heat	heat energy that is transported by a body that has a temperature higher than its surroundings via conduction, convection, or both. Sensible heat is the product of the body's mass, its specific heat capacity and its temperature above (an inferred) reference temperature
SG s	steam generator
six sigma, 6 sigma, 6-σ	a quality system where the likelihood of an unexpected failure is confined to six standard deviations (where sigma is the standard deviation, and 6-σ equates to 3.4 defects per million)
SME	small to medium sized enterprise
SPC	statistical process control
SPD	
specific consumption	consumption related to a reference basis, such as production capacity, or actual production (e.g. mass per tonne or per unit produced)
SPOT	steam plant optimisation tool
staleness	having lost freshness as a consequence of over-work, boredom and/or age. Unoriginality as a result of being dull and hackneyed
steady state	situation in which all state variables are constant in spite of ongoing processes that strive to change them

ENGLISH TERM	MEANING
superheated steam	steam heated to a temperature higher than the boiling point corresponding to its pressure. It cannot exist in contact with water, nor contain water, and resembles a perfect gas; also called surcharged steam, anhydrous steam, and steam gas
T	
t	time
t	metric tonne (1000 kg or 10 ⁶ gram)
T	temperature
T	tera 10 ¹²
t/yr t	onne(s) per year
TAC	total allowable concentration
TDS	total dissolved solids
TEE	abbreviation for white certificate in Italy, see white certificate
thyristor drive	a motor and controller combination including the drive shaft, where AC supply current is regulated by a thyristor phase control to provide variable voltage to a DC motor
TOC	total organic carbon
top management	the person or group of people of the highest authority that direct the company or part of it
TQM	total quality management is a comprehensive and structured approach to organisational management that seeks to improve the quality of products and services through ongoing refinements in response to continuous feedback. TQM processes are divided into four sequential categories: plan, do, check, and act (the PDCA cycle)
TWG	technical working group
U	
U	internal energy J
u	internal energy per unit of mass J/kg
UHC unb	urned hydrocarbons
UPS	uninterruptible power supply. A device which maintains a continuous supply of electric power to connected equipment by supplying power from a separate source when utility power is not available
V	
V	volume
v	specific volume m ³ /kg
V	volt. The SI derived unit of electric potential difference or electromotive force
VA	volt-ampere: in electrical terms, means the amount of apparent power in an alternating current circuit equal to a current of one ampere at an emf of one volt. It is equivalent to watts for non-reactive circuits (in industry usually found as kVA: 10 kVA = 10 000 watts capability (where the SI prefix k equals kilo); 10 MVA = 10 000 000 watts capability (where M equals mega)
VAM v	inyl acetate monomer
VOCs	volatile organic compounds. Compounds that have high enough vapour pressures to significantly vaporise under ambient conditions. Includes a wide range of molecules such as aldehydes, ketones and hydrocarbons. Commonly found in solvents for paint, printing inks, adhesives, some fuels, etc. See the STS BREF
vol-%	percentage by volume. (Also % v/v)
volute	spiral casing housing the rotor in a centrifugal pump
W	
W	work J

ENGLISH TERM	MEANING
water hammer	(or, more generally, fluid hammer) a pressure surge or wave caused by the kinetic energy of a fluid in motion when it is forced to stop or change direction suddenly. It depends on the fluid compressibility where there are sudden changes in pressure. For example, if a valve is closed suddenly at an end of a pipeline system, a water hammer wave propagates in the pipe. Steam heating systems for buildings may also be vulnerable to water hammer. In a steam system, water hammer most often occurs when some of the steam condenses into water in a horizontal section of the steam piping. Subsequently, steam picks up the water, forms a 'slug' and hurls it at high velocity into a pipe elbow, creating a loud hammering noise and greatly stressing the pipe. This condition is usually caused by a poor condensate drainage strategy
wet steam	steam which contains water held in suspension mechanically; also called misty steam
WBB	Wet bottom boiler. A boiler that contains a wet bottom furnace. It is a kind of boiler used for pulverised fuel firing. In a wet bottom boiler, the bottom ash is kept in a molten state and tapped off as a liquid. The ash hopper in wet bottom furnaces contains quenching water. When the molten slag comes in contact with the quenching water, it fractures instantly, crystallises, and forms pellets. Wet bottom boilers are preferred for low volatile coals that produce a lot of ash. However, it has higher investment costs and higher maintenance costs, so it is built less often
white certificate	a market-based tool to get energy savings for some category of operators (distributors, consumers, etc.) coupled with a trading system for energy efficiency measures resulting in energy savings. The savings would be verified and certified by the so-called 'white' certificates
WI w	aste incineration
wt-%	percentage by weight. (Also % w/w)
W-t-E	waste to energy
X	
x	molar fraction, quality
X	quality
Y	
yr y	ear
Z	
Z	compressibility factor
z	elevation, position m

7 ANNEXES

7.1 Energy and the laws of thermodynamics

[269, Valero, 2007]

Auditing processes for energy diagnosis in industrial installations are crucial in order to understand where energy is used, and to ensure it is used and controlled efficiently. For auditing, mass, energy and exergy balances for the equipment and corresponding processes need to be performed. Recommendations can then be made to improve efficiencies and/or minimise resulting dissipated energies. The basic science that deals with energy and the various concepts and laws describing the conservation of one form of energy to another, and the various systems employed with systems in equilibrium is thermodynamics. The basic concepts of thermodynamics are summarised here focusing on those areas that have special importance for the optimisation of energy use and energy efficiency in industry. Detailed explanations can be found in university degree books (see Bibliography in Section 7.1.4.1).

7.1.1 General principles

7.1.1.1 Characterisation of systems and processes

(Note: where symbols or formulae have dimensions, these are indicated in SI units)

A thermodynamic system is the quantity of matter within a prescribed boundary under consideration; everything external to the system is called surroundings. Systems may be considered as closed or open. A system can be considered as closed if there is no interchange of matter between system and surroundings. If there is an interchange, the system is considered to be open.

A very important class of systems that is frequently encountered by engineers is steady-flow systems. A steady-flow system can be defined as any fixed region-of-space system through which a fluid flows and the properties of this fluid, either internal to the system or at its boundaries, do not change as time passes. Typical examples include air compressors, gas turbines, steam turbines, boilers, pumps, heat exchangers, etc. All these devices have in common that each has one or more fluid streams entering and leaving. Devices with these characteristics are also known as steady-state or steady-flow systems, steady-flow control volumes or flow systems.

Any characteristic of a system is called property. Temperature, volume, pressure or mass are some of the most familiar examples. Properties are considered to be intensive, if they are independent of the size of the system (temperature, pressure, density) or extensive if their values depend on the size or extent of the system (mass, volume, total energy). When an extensive property is divided by the total mass of a system, the resulting property is called specific property. The state of a system is the condition of the system as described by its properties. Equation of state is any equation relating properties of a substance.

A system which is in equilibrium experiences no changes when it is isolated from its surroundings. Any change that the system may undergo is known as process. A system is said to be at steady-state if none of its properties changes with time. If the system returns to its original condition or state at the end of the process, then the system has undergone a cycle. Reversible processes are those in which everything involved with the process (systems and surroundings) can be returned to its original condition after the process has been executed. After an irreversible process, this is not possible. No process involving friction or unbalanced potential can be reversible. Even though all actual processes are irreversible, the study of reversible processes are quite useful to understand the limits of behaviour of systems and processes.

7.1.1.2 Forms of energy storage and transfer

7.1.1.2.1 Energy storage

Energy can be stored in numerous forms. The most important forms encountered in thermodynamic applications are: internal, kinetic and potential energy. Other forms of energy such as magnetic, electric, and surface tension effects are significant only in some specialised cases and will not be considered here. Energy is measured in joules (J) or in other units such as kilowatt-hour (kWh).

The internal energy (U) is associated with the microscopic forms of energy, i.e. to the motion, position and internal state of the atoms or molecules of the substance.

The energy associated to the motion of the system as a whole relative to some reference frame is called kinetic energy KN . Kinetic energy is expressed as:

$$KN = \frac{mC^2}{2} \quad (\text{J}) \quad \text{Equation 7.1}$$

Where: $C =$ the velocity of the system relative to some fixed reference frame
 $m =$ the mass of the body in motion.

The change in gravitational potential energy, PT is associated with the position of the system as a whole (elevation) in the Earth's gravitational field and can be expressed as:

$$PT = mgz \quad (\text{J}) \quad \text{Equation 7.2}$$

Where: $g =$ the gravitational acceleration and
 $z =$ the elevation of the centre of gravity of a system relative to some arbitrarily selected reference plane.

The energy of a system that consists of the kinetic, potential and internal energies is expressed as:

$$U_{K,P} = U + KN + PT = U + \frac{mC^2}{2} + mgz \quad (\text{J}) \quad \text{Equation 7.3}$$

7.1.1.2.2 Energy transfer

The forms of energy discussed above which constitute the total energy of a system are static forms of energy and can be stored in a system. However, energy can also be transformed from one form to another and transferred between systems. For closed systems, energy can be transferred through work and heat transfer. Heat and work are not properties because they depend on the details of a process and not just the end states. The rate of energy transfer is expressed in watts (1 watt = 1 joule/1 second).

Heat

Heat (Q) can be defined as energy in transit from one mass to another because of a temperature difference between the two. It accounts for the amount of energy transferred to a closed system during a process by means other than work. The transfer of energy occurs only in the direction of decreasing temperature.

Heat can be transferred in three different ways: conduction, convection and radiation. Conduction is the transfer of energy from the more energetic particles of a substance to the adjacent particles that are less energetic due to interactions between the particles. Conduction can take place in solids, liquids and gases. Convection is the energy transfer between a solid surface at a certain temperature and an adjacent moving gas or liquid at another temperature. Thermal radiation is emitted by matter as a result of changes in the electronic configurations of the atoms or molecules within it. The energy is transported by electromagnetic waves and it requires no intervening medium to propagate and can even take place in vacuum.

Work

The thermodynamic definition of work (W) is: work is done by a system on its surroundings if the sole effect on everything external to the system could have been the raising of a weight. Like heat, work is also energy in transit. The rate of energy transfer by work is called power and its unit in the SI system is denoted by W .

7.1.2 First and second law of thermodynamics

The two fundamental and general laws of thermodynamics are: (1) energy is conserved and (2) it is impossible to bring about any change or series of changes the sole net result of which is the transfer of energy as heat from a low to a high temperature. In other words, heat will not by itself flow from low to high temperatures.

A process will not occur unless it satisfies both the first and the second laws of thermodynamics.

7.1.2.1 The first law of thermodynamics: energy balance

The first law of thermodynamics is the general principle of physics and it states that energy is conserved. Although the law has been stated in a variety of ways, all have essentially the same meaning. The following are examples of typical statements:

- whenever energy is transformed from one form to another, energy is always conserved
- energy can neither be created nor destroyed
- the total sum of all energies remains constant for a given system
- the net energy in the form of heat added or removed to or from a system that operates in a cyclic manner equals the net energy in the form of work produced or consumed by the system
- the value of the net work done by or on a closed system undergoing an adiabatic process between two given states depends solely on the end states and not on the details of the adiabatic process.

7.1.2.1.1 Energy balance for a closed system

For a closed system, the first law implies that the change in system energy equals the net energy transfer to the system by means of heat and work. That is:

$$U_2 - U_1 = Q - W \quad (\text{J}) \quad \text{Equation 7.4}$$

In Equation 7.4, the usual convention on signs has been used: heat is positive when it is added to the system, and work is positive when it is produced by the system.

7.1.2.1.2 Energy balance for open systems

Most applications of engineering thermodynamics are conducted on a control volume basis. In such cases, the conservation of mass principle must be applied. The time rate of accumulation of mass within the control volume equals the difference between the total rates of mass flow in and out across the boundary.

$$\frac{dm}{dt} = \sum_1 \dot{m}_1 - \sum_2 \dot{m}_2 \quad (\text{kg/s}) \quad \text{Equation 7.5}$$

The energy rate balance for such a system is:

$$\frac{dU}{dt} = \dot{Q} - \dot{W} + \dot{m}_1 \left(h_1 + \frac{C_1^2}{2} + gz_1 \right) - \dot{m}_2 \left(h_2 + \frac{C_2^2}{2} + gz_2 \right) \quad (\text{in SI units, W}) \quad \text{Equation 7.6}$$

In Equation 7.6, h is the specific enthalpy of the flows entering and exiting the system:

$$h = u + Pv \quad (\text{J/kg}) \quad \text{Equation 7.7}$$

For steady-flow systems, the mass flow rates and the rates of energy transfer by heat and work are constant with time.

$$\sum_1 \dot{m}_1 = \sum_2 \dot{m}_2 \quad (\text{kg/s}) \quad \text{Equation 7.8}$$

Hence, at steady state, the first law of thermodynamics can be expressed as:

$$\dot{Q} - \dot{W} = \dot{m}_1 \left(h_1 + \frac{C_1^2}{2} + gz_1 \right) - \dot{m}_2 \left(h_2 + \frac{C_2^2}{2} + gz_2 \right) \quad (\text{W}) \quad \text{Equation 7.9}$$

7.1.2.1.3 First law efficiencies: thermal efficiency and coefficient of performance

In general, the efficiency of a thermal system indicates the relation between the useful energy produced and the amount of energy used.

The thermal efficiency of a heat engine is the fraction of the heat input that is converted to net work output:

$$\eta = \frac{W_{net,out}}{Q_{in}} \quad (\text{dimensionless}) \quad \text{Equation 7.10}$$

Other efficiency indicators are the Coefficients of Performance COP of any refrigeration cycle, COP_R , and heat pump cycle, COP_{HP} , given by:

$$COP_R = \frac{Q_C}{Q_H - Q_C} \quad (\text{dimensionless}) \quad \text{Equation 7.11}$$

$$COP_{HP} = \frac{Q_H}{Q_H - Q_C} \quad (\text{dimensionless}) \quad \text{Equation 7.12}$$

Unlike the thermal efficiency, the value of COP can be greater than unity. This means, e.g. that the amount of heat removed from the refrigerated space can be greater than the amount of work input.

7.1.2.2 The second law of thermodynamics: entropy

The second law of thermodynamics enables us to know which types of transformations are possible or impossible and in which direction they occur. Like the first law, the second can be postulated in many different ways and two of them are listed below:

- it is not possible to construct a heat engine which produces no other effect than the exchange of heat from a single source initially in an equilibrium state and the production of work. Heat engines must always reject heat to a thermal energy reservoir
- no cyclical device can cause heat to transfer from thermal energy reservoirs at low temperatures to reservoirs at high temperatures with no other effects.

To state the second law in a general and usable form, the concept of entropy is needed.

7.1.2.2.1 Entropy

When two stable states of a system are connected by different internally reversible processes, we find that the integral of the heat interchanged over its temperature is not dependent on the process path. This means that a function exists which only depends on the state properties (or properties of the state) of the system: this function is called entropy. The change of entropy is defined as follows:

$$\underbrace{S_2 - S_1}_{\text{Entropy change}} = \underbrace{\int_1^2 \left(\frac{\delta Q}{T} \right)}_{\substack{\text{Entropy} \\ \text{transfer} \\ \text{rev. process}}} \text{ (J/K)} \quad \text{Equation 7.13}$$

Entropy is an abstract property and can be viewed as a measure of disorder. By using entropy, more forms of the second law can be introduced:

- the total entropy of an engine and all of the surrounding components that interact with the engine must increase when the heat engine is not completely reversible
- the only processes that can occur are those for which the entropy of the isolated system increases (this statement is known as the increase of entropy principle).

7.1.2.2.2 Entropy balance for closed systems

Due to the irreversible nature of almost any actual process, entropy is not a conservative property. The entropy balance for a closed system is expressed as:

$$\Delta S = \underbrace{S_2 - S_1}_{\text{Entropy change}} = \underbrace{\int_1^2 \left(\frac{\delta Q}{T} \right)}_{\text{Entropy transfer}} + \underbrace{\sigma}_{\text{Entropy production}} \text{ (J/K)} \quad \text{Equation 7.14}$$

The first term on the right side of Equation 7.14 is associated with heat transfer to or from the system during the process and can be interpreted as the entropy transfer accompanying heat transfer. A positive value means that entropy is transferred into the system and a negative value means that entropy is transferred out. The term is called entropy production and accounts for the irreversibilities generated in the process. The entropy production is positive whenever irreversibilities occur and zero in the ideal case where no irreversibilities take place.

From now on, the amount of irreversibilities through entropy production can be measured with a simple entropy balance. Irreversibilities are the key for understanding the process of energy degradation, and the so-called energy savings and conservation techniques. Whereas energy is not destroyed but degraded, the key issue of any energy analyst is to pinpoint irreversibilities in processes and propose solutions for avoiding them.

7.1.2.3 Entropy balance for an open system

The entropy rate within a control volume during a process is equal to the sum of the rate of entropy transfer through the control volume boundary by heat transfer, the net rate of entropy transfer into the control volume by mass flow, and the rate of entropy generation within the boundaries of the control volume as a result of irreversibilities:

$$\underbrace{\frac{dS_{cv}}{dt}}_{\substack{\text{Rate} \\ \text{of} \\ \text{entropy} \\ \text{change}}} = \underbrace{\sum_j \frac{\dot{Q}_j}{T_j}}_{\substack{\text{Rate} \\ \text{of} \\ \text{entropy} \\ \text{transfer} \\ \text{with} \\ \text{heat}}} + \underbrace{\sum_i \dot{m}_i s_i - \sum_e \dot{m}_e s_e}_{\substack{\text{Rate} \\ \text{of} \\ \text{entropy} \\ \text{transfer} \\ \text{with} \\ \text{mass}}} + \underbrace{\dot{\sigma}}_{\substack{\text{Rate} \\ \text{of} \\ \text{entropy} \\ \text{generation}}} \quad (\text{W/K})$$

Equation 7.15

The terms $\dot{m}_i s_i$ and $\dot{m}_e s_e$ represent the rates of entropy transfer into and out of the system accompanying mass flow. \dot{Q}_j represents the time rate of heat transfer at the location on the boundary where the instantaneous temperature is T_j . The ratio \dot{Q}_j/T_j accounts for the accompanying rate of entropy transfer. The term σ denotes the time rate of entropy production due to irreversibilities within the control volume.

7.1.2.4 Exergy analysis

7.1.2.4.1 Exergy

Exergy of a thermodynamic system is the maximum theoretical useful work (shaft work or electrical work) obtainable as the system is brought into complete thermodynamic equilibrium with the thermodynamic environment while the system interacts with this environment only. A system is said to be in the dead state when it is in thermodynamic equilibrium with its surroundings. At the dead state, a system is at the temperature and pressure of its surroundings; it has no kinetic or potential energy and it does not interact with the surroundings. Exergy is a measure of the departure of the state of a system from the environment. Once the environment is specified, a value can be assigned to exergy in terms of property values for the system only and exergy can be regarded as a property of the system. The value of exergy, as defined in Equation 7.16, cannot be negative and is not conserved but destroyed by irreversibilities. The specific exergy on a unit mass basis is:

$$e = (u - u_0) + P_0(v - v_0) - T_0(s - s_0) + C^2 / 2 + gz \quad (\text{J/kg}) \quad \text{Equation 7.16}$$

The subscript 0 denotes the dead state.

When a mass flows across the boundaries of a control volume, there is an exergy transfer accompanying the mass and work flows. This is named specific flow exergy or physical exergy of a material stream, and is given by:

$$e = (h - h_0) - T_0(s - s_0) + C^2 / 2 + gz \quad (\text{J/kg}) \quad \text{Equation 7.17}$$

7.1.2.4.2 Exergy balances

The exergy balance for a closed system is obtained with the combination of the energy and entropy balances. The exergy change in a closed system is equal to the sum of the exergy transfer accompanying heat, the exergy transfer accompanying work minus the destruction of exergy. The final equation is:

$$\Delta E = \underbrace{E_2 - E_1}_{\text{Exergy change}} = \underbrace{\int_1^2 \left(1 - \frac{T_0}{T_j}\right) \delta Q}_{\text{Exergy transfer accompanying heat}} - \underbrace{[W - P_0(V_2 - V_1)]}_{\text{Exergy transfer accompanying work}} - \underbrace{T_0 \sigma}_{\text{Exergy destruction}} \quad (\text{J}) \quad \text{Equation 7.18}$$

T_0 and P_0 denote the temperature and pressure at ambient conditions. T_j is the surface temperature where the heat transfer takes place. The rate of exergy change in open systems is given by:

$$\underbrace{\frac{dE_{cv}}{dt}}_{\text{Rate of exergy change}} = \underbrace{\sum_j \left(1 - \frac{T_0}{T_j}\right) \dot{Q}_j - \left(\dot{W}_{cv} - P_0 \frac{dV_{cv}}{dt}\right)}_{\text{Rate of exergy transfer}} + \underbrace{\sum_i \dot{m}_i e_i - \sum_e \dot{m}_e e_e}_{\text{Rate of Exergy destruction}} - \dot{I} \quad (\text{W}) \quad \text{Equation 7.19}$$

7.1.2.4.3 Second law efficiency: Exergetic efficiency

The thermal efficiency and coefficient of performance are based only on the first law of thermodynamics and make no reference to the best possible performance. However, the exergetic efficiency or second law efficiency overcomes this deficiency and gives a measure of approximation to reversible operation. Exergetic efficiencies are useful for distinguishing means for utilising energy resources that are thermodynamically effective from those that are less so. They can be used to evaluate the effectiveness of engineering measures taken to improve the performance of a thermal system. The exergetic efficiency is defined in a generic form as the ratio between the exergy recovered and the exergy supplied:

$$\varepsilon = \frac{E_{\text{recovered}}}{E_{\text{supplied}}} \quad (\text{dimensionless}) \quad \text{Equation 7.20}$$

Exergetic efficiency expressions can take many different forms depending on the analysed system. For a heat engine, the exergy supplied is the decrease in the exergy of the heat transferred to the engine, which is the difference between the exergy of the heat supplied and the exergy of the heat rejected. The net work output is the recovered exergy. For a refrigerator or heat pump, the exergy supplied is the work input and the recovered exergy is the exergy of the heat transferred to the high temperature medium for a heat pump and the exergy of the heat transferred from the low temperature medium for a refrigerator.

7.1.3 Property diagrams, tables, databanks and computer programs

7.1.3.1 Property diagrams

According to the state postulate, if any two state variables of a simple pure substance are specified, the third is determined. This implies that the state of that substance can be represented in a diagram with two independent properties. The five basic properties of a substance that are usually shown on property diagrams are: pressure (P), temperature (T), specific volume (v), specific enthalpy (h), specific entropy (s) and quality (x) if a mixture of two phases is involved. The most commonly encountered property diagrams are: pressure-temperature (P - T), pressure-specific volume (P - v), temperature-specific volume (T - v), temperature-(specific) entropy (T - s) and (specific) enthalpy-(specific) entropy (h - s). These diagrams are very useful in plotting processes. Additionally, the first three diagrams are helpful for explaining the relationships between the three phases of matter.

For example, a T - s diagram is shown in Figure 7.1. T - s diagrams are widely used in thermodynamics, because they are very useful in visualising irreversibilities of processes. Constant-volume, constant-pressure and constant-enthalpy lines can be seen in T - s diagrams. Vertical lines on T - s diagrams represent processes undergoing isentropic (same entropy) compression/expansion, while horizontal lines inside the dome mean isothermal phase changes (vaporisation/condensation).

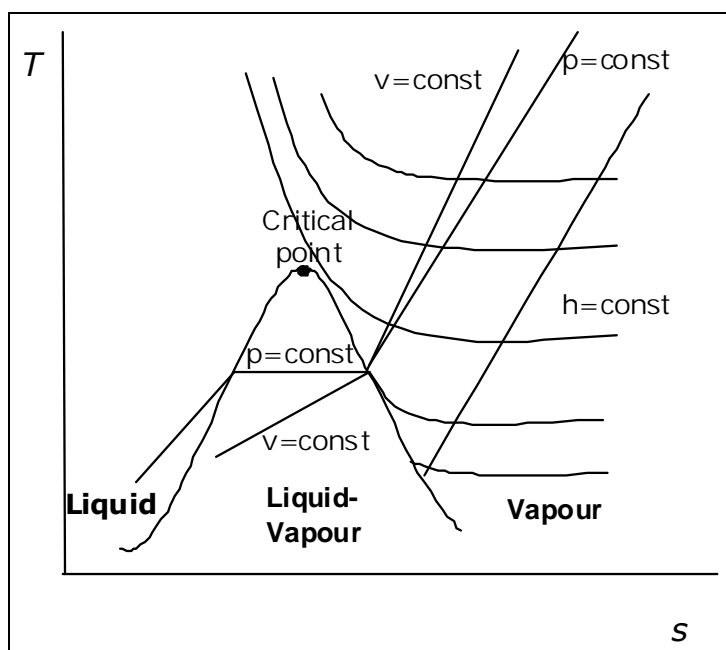

Figure 7.1: Temperature-entropy diagram

7.1.3.2 Property tables, databanks and simulation programs

Tables in the real world are not enough, and it is necessary to have thermodynamic properties of many substances, both pure and mixed. In fact, complex thermodynamic data banks and associated physical property models form the heart of any computer energy simulator. The need is so important that inaccuracy or unavailable data may lead to reject attractive energy conservation solutions. Fortunately, a considerable amount of databases and computer programs may be found in literature and on the market. The problem arises in having judgement to select with good criteria even if contradictory data are found. Quality, accurate and up-to-date information is, in many cases, critical. This is a key issue when calculating mixture properties in which departure from non-ideal behaviour is common. Some major data compilations can be found in the American Petroleum Institute, API (US); Beilstein Institute of Organic Chemistry, Beilstein; Design Institute for Physical Property Data, DIPPR of AIChE; Deutsche Gesellschaft

für Chemisches Apparatewesen, Chemische Technik und Biotechnologie e.V., DECHEMA; Physical Property Data Service, PDS in the U.S.; and others. For instance, DIPPR has a comprehensive pure component data compilation meanwhile a primary source of mixture data is DECHEMA. Commercial simulation programs with extensive capabilities for calculating thermodynamic properties can be easily found. Three of the most widely-used programs are the trademarked: ASPEN PLUS, HYSIM, and PRO/II. However, these computer packages may do more than is needed by an analyst carrying out routine calculations to determine energy savings, or conversely, they may perform in a less specialised way. These programs are costly both in effort of handling and in acquisition and maintaining. Intermediate solutions that allow the analyst to compose their own simulation solutions and include pure substance properties are, for instance, EES, Thermoptim, and BBlocks. Therefore, it is important that the analyst devotes sufficient time to judging which is worth acquiring. Starting from scratch is not advisable in most cases.

7.1.3.3 Identification of inefficiencies

These are discussed in Section 1.2.2.6.

7.1.4 Nomenclature

Symbol	Meaning	Unit
C	Velocity m	/s
E	Exergy J	
\dot{E}	Exergy rate	J/s
e	Exergy per unit of mass	J/kg
E_T	Total energy	J
g	Acceleration of gravity	m/s ²
H	Enthalpy J	
h	Specific enthalpy	J/kg
I	Irreversibility J	
\dot{I}	Irreversibility rate	J/s
KN	Kinetic energy	J
m	Mass kg	
\dot{m}	Mass rate	kg/s
P, p	Pressure Pa	
PT	Potential energy	J
Q	Heat J	
\dot{Q}	Heat rate	J/s
S	Entropy J	/K
s	Specific entropy	J/(kgK)
t	Time s	
T	Temperature K	
U	Internal energy, energy	J
u	Internal energy per unit of mass	J/kg
V	Volume m	³
v	Specific volume	m ³ /kg
W	Work J	
\dot{W}	Work rate	J
z	Elevation, position	m

Symbol	Meaning	Unit
Greek Letters		
η	Thermal efficiency	-
ε	Exergetic efficiency	-
σ	Entropy production	J/K
$\dot{\sigma}$	Rate of entropy production	J/(kgK)
Subscripts		
0	Ambient conditions	
av	Average of the considered property	
C	Compressor	
cv	Control volume	

7.1.4.1 Bibliography

- Anderson, E. E. Thermodynamics. International Thomson Publishing. 1994
- Avallone, E. A. Mark's Standard Handbook for Mechanical Engineers. 9th Edition. McGraw Hill. 1978
- Bejan, A.; Tsatsaronis, G. and Moran, M. Thermal Design and Optimization. Wiley Interscience. 1996
- Çengel, Y. A. and Boles, M. A. Thermodynamics: an engineering approach. International Edition. McGraw Hill. 1994
- Danner R.P.; Spencer C.F.; Nagvekar M. Thermophysical Properties for Design Simulations in Developments in the Design of Thermal Systems, Ed. By R.F. Boehm, Cambridge Univ. Press, 1997
- Hering, E. and Modler, K. Grundwissen des Ingenieurs. München: Carl Hanser Verlag, cop. 2002
- Lozano, M. A. and Valero, A. Determinación de la exergía para sustancias de interés industrial. Ingeniería química. Marzo 1986
- Moran, M. J. and Shapiro, H. N. Fundamentals of Engineering Thermodynamics. 4th Edition. John Wiley & Sons. 2000
- Moran, M. J.; Shapiro, H. N.; Munson, and Dewitt. Introduction to thermal systems engineering. John Wiley & Sons. 2003
- Moore, W.J. Physical Chemistry, 1974
- Perry, R. H. and Green, D. Perry's chemical engineers' handbook. McGraw Hill. 1984
- The CRC Handbook of thermal engineering. Keith F. Editor in chief. CRC Press Springer. 2000
- Valero, A. and Lozano, M.A. Los balances de energía, entropía, exergía y energía libre. Métodos para el diagnóstico de instalaciones industriales. Ingeniería química. Mayo 1987
- Valero, A. and Lozano M.A. An Introduction of Thermoconomics in Developments in the Design of Thermal Systems, Ed. By R.F. Boehm, Cambridge Univ. Press, 1997
- Valero-Capilla A. and Valero-Delgado A. Fundamentals of energy thermodynamics, 2005
- Wark, K. Thermodynamics. McGraw Hill. 1983

7.2 Case studies of thermodynamic irreversibilities

7.2.1 Case 1. Throttling devices

Throttling devices are very common in industry and are used to control and reduce pressure mainly through valves. Since the throttling process is isenthalpic (where the enthalpy up and down flows are equal) no energy is lost and according to the first law of thermodynamics, its efficiency is optimal.

However, this is a typical mechanical irreversibility which reduces pressure and increases the entropy of the fluid, without giving any additional benefit. Consequently, exergy is lost and the fluid is less capable of producing energy in a turbine expansion process, for instance.

Therefore, if the point is to reduce the pressure of a fluid, it is desirable to tend to isentropic expansions providing useful work as an additional result through turbines. If this is not possible, the working pressure should always be the highest possible because this will avoid the use of compressors or pumps for fluid transportation (additional useful energy).

A very frequent practice in industrial installations is to keep the pressure at the inlet of the turbine at the design conditions. This usually implies the use and abuse of admission valves to control the turbine. According to the second law, it is better to have fluctuation of the pressure specifications (sliding pressure) and to keep the admission valves completely open.

As a general recommendation, valves should be sized as large as possible. A satisfactory throttling process can be achieved with a pressure drop of 5 – 10 % at maximum flow instead of 25 – 50 % as has happened in the past, where valves were small sized. Of course the pump driving the fluid must be also sized according to the variable conditions.

Finally, it must be stressed that pipes also act as throttling devices, decreasing the pressure of the fluid flowing through them. Therefore, a good design with good materials and few obstacles such as unnecessary valves, elbows, bows, etc. will limit the exergy losses across the process.

In any case, it is clear that an exergy accounting that considers all the energy levels existing in the plant must be performed, because from the first law point of view, irreversibilities are very difficult or impossible to identify.

Numerical example

During a unit commissioning in a power plant, a steam extraction coming from the high pressure turbine ($P = 40 \text{ kg/cm}^2$, $T = 350 \text{ }^\circ\text{C}$) is used in order to feed a turbopump.

Since the turbopump operates at an inlet pressure of 8 kg/cm^2 , the steam coming from the high pressure turbine must be throttled (see Figure 7.2). In the following thermodynamic example, variables of the steam are evaluated at the inlet and outlet of the valve. The process is sketched on the T-s and h-s diagrams (see Figure 7.3) and the exergy flow is obtained when the nominal flow is $45\,000 \text{ kg/h}$.

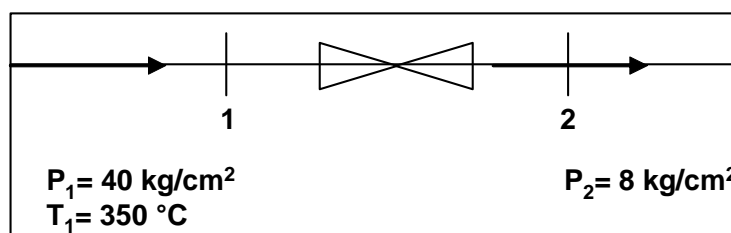

Figure 7.2: Steam throttling process

Solution

The first law of thermodynamics reveals that the process is isenthalpic since no work or heat transfer is associated with the throttling process:

$$0 = m_1(H_2 - H_1) \Rightarrow H_2 = H_1 \quad \text{Equation 7.21}$$

The specific enthalpy and entropy obtained through the property tables are:

- at P_1 and T_1 :
 - $h_1 = 3091.95 \text{ kJ/kg}$ and $S_1 = 6.58 \text{ kJ/kg K}$
- at P_2 and $h_2 = h_1$
 - $T_2 = 319 \text{ }^\circ\text{C}$
 - $S_2 = 7.30 \text{ kJ/kg K}$

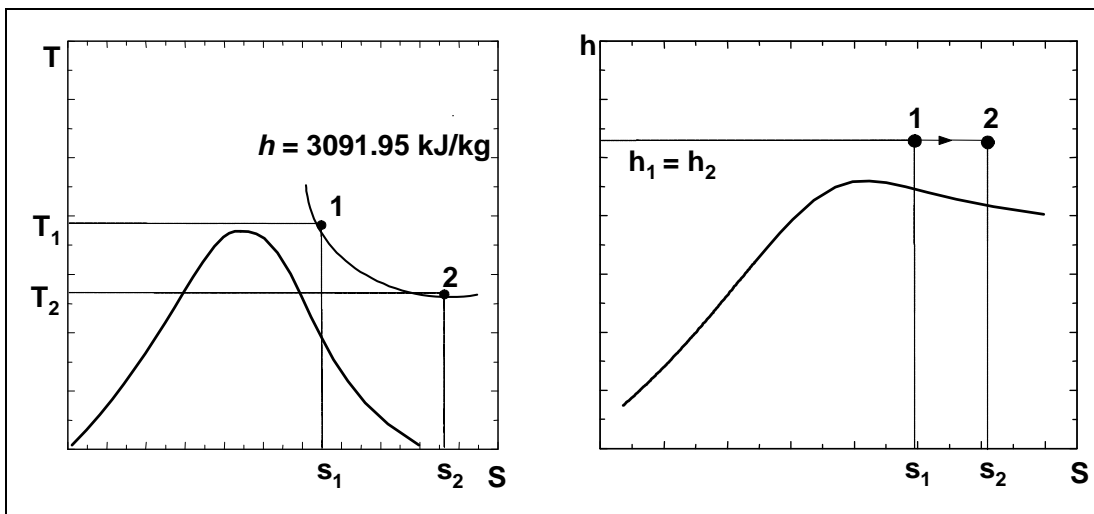

Figure 7.3: T-S and h-S diagrams for the steam throttling process of the example

The specific flow exergy is calculated as:

$$e = H - T_0s \quad \text{Equation 7.22}$$

Where $T_0 = 273 \text{ K}$ and the potential and kinetic energy are considered negligible. Hence:

- $e_1 = 3091.95 - 273 \times 6.58 = 1295.61 \text{ kJ/kg}$

and

- $e_2 = 3091.95 - 273 \times 7.30 = 1099.05 \text{ kJ/kg}$

This process is completely irreversible (mechanical irreversibility). The exergy loss is obtained through an exergy balance to the system. Since there is no heat or work transfer, the exergy balance reduces to:

$$I = m(e_1 - e_2) = 45000 \text{ kg/h} \cdot \frac{1}{3600} \text{ s/h} \cdot (1295.61 - 1099.05) = 2457 \text{ kW} = 2.457 \text{ MW}$$

7.2.2 Case 2. Heat exchangers

Heat exchangers are devices where two streams exchange heat. Every heat transfer is the result of a temperature difference and thus is always associated with entropy generation and exergy destruction. Therefore, there is a contradiction between the ideas of minimum exergy loss and maximum heat transfer efficiency.

In a counterflow heat exchanger like the one shown in Figure 7.4, where a hot fluid at $T_{1,in}$ is cooled down to $T_{1,out}$, by releasing heat to a cold fluid that heats up from $T_{2,in}$ to $T_{2,out}$, therefore, the exergy loss in the process is calculated as follows:

The change in kinetic and potential energy are usually negligible and no work interactions are present. For a first approximation, the pressure drop can also be considered negligible. The irreversibility created in the heat exchanger is given by:

$$I = (e_{1,in} + e_{2,in}) - (e_{1,out} + e_{2,out}) = (h_{1,in} + h_{2,in}) - (h_{1,out} + h_{2,out}) - T_0 [(s_{1,in} + s_{2,in}) - (s_{1,out} + s_{2,out})] = T_0 \left[m_1 C_{p1} \ln \frac{T_{1,out}}{T_{1,in}} + m_2 C_{p2} \ln \frac{T_{2,out}}{T_{2,in}} \right] \quad \text{Equation 7.23}$$

It can be demonstrated from the equation above that I is always positive and increases with the temperature differences at the inlet and outlet of the fluids in the counterflow exchanger and between the top and bottom in a parallel-flow exchanger. In any case, a counterflow exchanger is always better than a concurrent one (parallel-flow) from the exergy point of view, because exergy is always being given off to a system at a similar temperature.

The irreversibilities taking place in heat exchangers are due to two factors: heat transfer caused by the temperature difference and pressure loss associated with the fluid circulation. Both fluid friction and irreversible heat transfer can be reduced decreasing the fluid flow. However, in order to obtain the same effect of heat exchange, a larger transfer area is required, i.e. larger heat exchangers must be designed.

The idea of extending the use of counterflow heat exchange to the whole installation, i.e. extending it to all flows to be heated or cooled in the plant, so that the temperature change through which heat must flow is reasonably low, leads to the energy integration of processes and the use of energy cascades. This is the philosophy of the pinch methodology, developed for the integration of heat exchanger networks. The integration can also be extended to power cycles, heat pumps and refrigeration cycles in the most efficient way. In summary, this procedure assures the lowest steam consumption (or any another heat source) and the lowest cooling water (or any other cold source) under the thermodynamic and technical conditions that may be assessed.

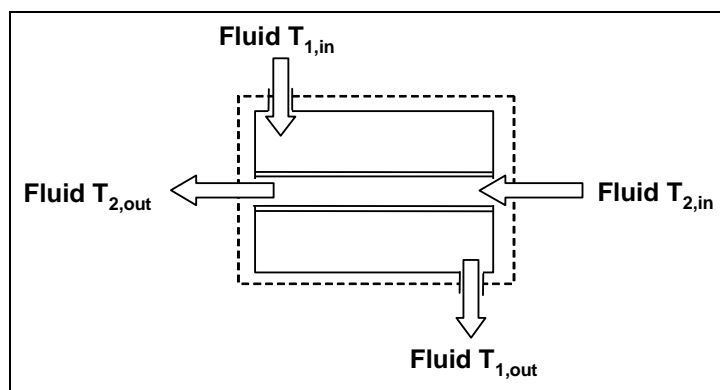

Figure 7.4: Counterflow heat exchanger

Numerical example

In a boiler reheater (see Figure 7.5), 1 100 000 kg/h of steam is heated from 350 to 540 °C at a pressure of 40 kg/cm². The heat absorbed by the steam comes from the exhaust gases of a combustion process. The average temperature where the heat transfer occurs is 1000 °C. In Figure 7.6 the process is sketched on the T-s and h-s diagrams and the heat absorbed by the steam and exergy losses is determined.

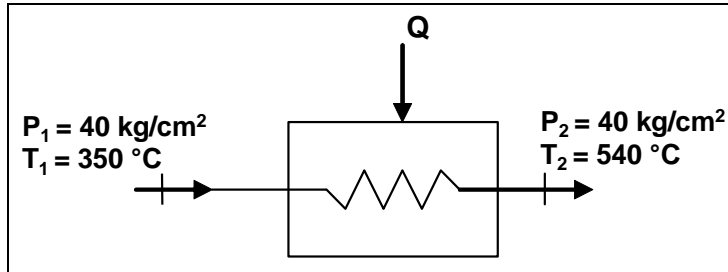

Figure 7.5: Reheating process of a steam flow

Solution

The energy balance of the system considered in Figure 7.5 is:

- $m (h_2 - h_1) = Q$

The specific enthalpy and entropy obtained through the property tables is:

- at P_1 and T_1 :
 - $h_1 = 3091.95$ kJ/kg and
 - $s_1 = 6.58$ kJ/kg K
- at P_2 and T_2 :
 - $h_2 = 3530.85$ kJ/kg and
 - $s_2 = 7.21$ kJ/kg K.

Hence, the heat transfer obtained is:

- $Q = 11\,100\,000 \times (3530.85 - 3091.95) = 438.9$ kJ/kg = 482.7×10^6 kJ/h

T-s and h-s diagrams are shown in Figure 7.6:

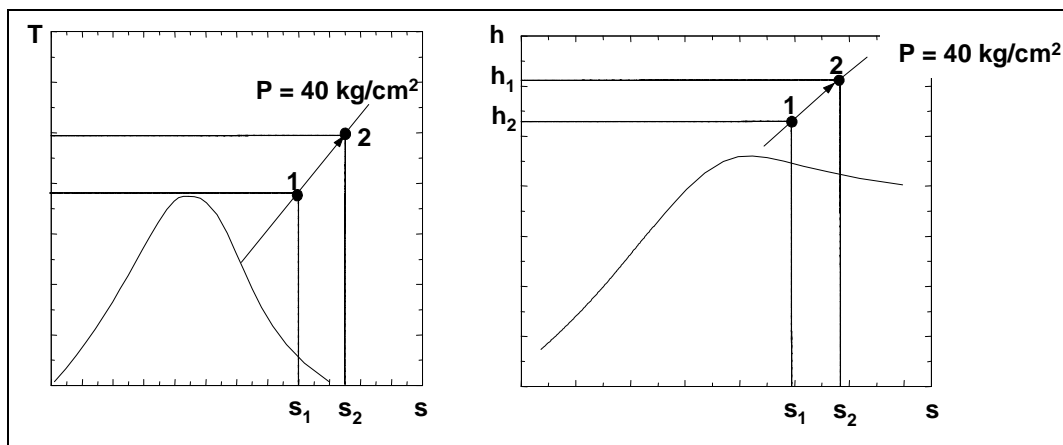

Figure 7.6: T-s and h-s diagrams for the steam reheating process of the example

The specific flow exergy is calculated as:

$$e = h - T_0 s$$

Where $T_0 = 273$ K and the potential and kinetic energy are considered negligible. Hence:

$$e_1 = 3091.95 - 273 \times 6.58 = 1295.61 \text{ kJ/kg}$$

and

$$e_2 = 3530.85 - 273 \times 7.21 = 1562.52 \text{ kJ/kg}$$

The exergy loss generated is given by:

$$I = \left(1 - \frac{T_0}{T_j}\right) \dot{Q} - \dot{W} + m_1(e_1 - e_2) \Rightarrow$$

$$I = \left(1 - \frac{273}{1273}\right) 482.7 \times 10^6 + 1.1 \times 10^6 (1295.61 - 1562.52) = 85.82 \times 10^6 \text{ kJ/h} = 23.84 \text{ MW}$$

7.2.3 Case 3. Mixing processes

The mixing of fluids with different compositions or temperatures is a rather process very common in industry. This concept includes tempering processes for temperature control, mixing processes for quality control, substance purifying processes, distillation, etc.

For example, an adiabatic mixture of two different ideal gases flow at the same temperature and pressure and n_1 and n_2 equals the number of moles of each flow. The generation of entropy in the mixing process corresponds to the sum of the entropy increase of each gas due to their expansions from P to their new partial pressure of the mixture. Hence:

$$\sigma = \frac{1}{n_1 + n_2} \left[n_1 R \ln \frac{P_1}{P} - n_2 R \ln \frac{P_2}{P} \right] = -R \sum x_i \ln x_i \text{ (J/K)}$$

Since $P_i = x_i P$ and $x_i = \frac{n_i}{\sum n_i}$ the exergy loss is calculated as follows:

$$I = T_0 \sigma = -RT_0 \sum x_i \ln x_i \quad (\text{J})$$

This expression is always positive and symmetrical with respect to the value $x_i = 0.5$. It tends to zero when x_i tends to zero (maximum purity). Figure 7.7 shows I_i/RT_0 versus the molar fraction of one component in the mixture x_i . The maximum exergy is reached when $x_i = 0$, but under these conditions, it is relatively easy to separate both components. As the mixture is being purified, the exergy loss per mole of the separated component increases.

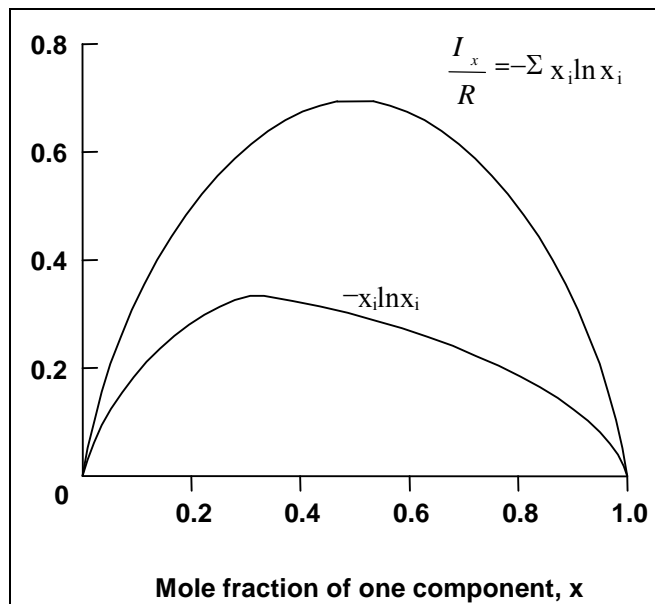

Figure 7.7: I_i/RT_0 versus molar fraction of one component in the mixture

For the considered binary system, the irreversibility is equal to:

$$I = -RT_0 [x \ln x + (1-x) \ln(1-x)] \quad \text{and} \quad \frac{dI}{dx} = -RT_0 \ln \left[\frac{x}{(1-x)} \right]$$

Some of the values of this derivative are presented in Table 7.1:

x	I/RT_0	$(1/RT_0) dI/dx$
0.10	0.325	2.20
0.01	0.056	4.96
10^{-3}	7.91×10^{-3}	6.91
10^{-4}	1.02×10^{-3}	9.21

Table 7.1: Some values of the derivatives

This derivative indicates the work required to improve the purity of the product and the easiness to pollute. In other words, the exergy value of the product is related with this derivative. Multicomponent mixtures behave in the same way. The maximum value of the function $-\sum x_i \ln x_i$ that takes place for equimolar mixtures is shown in Table 7.2:

N	$-\sum x_i \ln x_i$	N	$-\sum x_i \ln x_i$
2	0.693 5		1.609
3	1.099 7		1.946
4	1.386 10		2.302

Table 7.2: Maximum values for mixtures

As the number of mixture components increases, the irreversibility effects become more dramatic. These ideas lead to a set of recommendations for energy savings in mixing processes. Firstly and most importantly, mixing processes must be avoided whenever it is possible. Obtaining high quality steam or a very pure substance requires a great amount of exergy that is mostly lost when mixed with a lower quality flow (even if the energy loss is zero). Secondly, the quality specifications of a certain product must not be exceeded and above all, once they are exceeded, they should never be mixed with lower quality flows.

This way, if a product with 0.1 % purity is mixed equimolarly with another of 1 % purity, the final product will have 0.55 % purity, but the exergy value of this product will decrease significantly with respect to the individual flows, since this is related with the derivative $\frac{dI}{dx}$ and not with the mean composition value.

Some quality specifications of products should be reviewed and should be made 'softer' if possible. This is something basic in the chemical industry, in which it is very common to find partially refined matter mixed with over purified products or mixtures of products coming from two parallel units for achieving an average purity.

Numerical example

A steam flow at a pressure of 180 kg/cm² and a temperature of 550 °C is mixed with saturated liquid at 180 kg/cm², in order to reach the temperature design specifications of certain equipment (see Figure 7.8).

In Figure 7.9, the final temperature of the mixture and the exergy loss is determined when the mass flow of steam is 1 100 000 kg/h and of the liquid 30 000 kg/h.

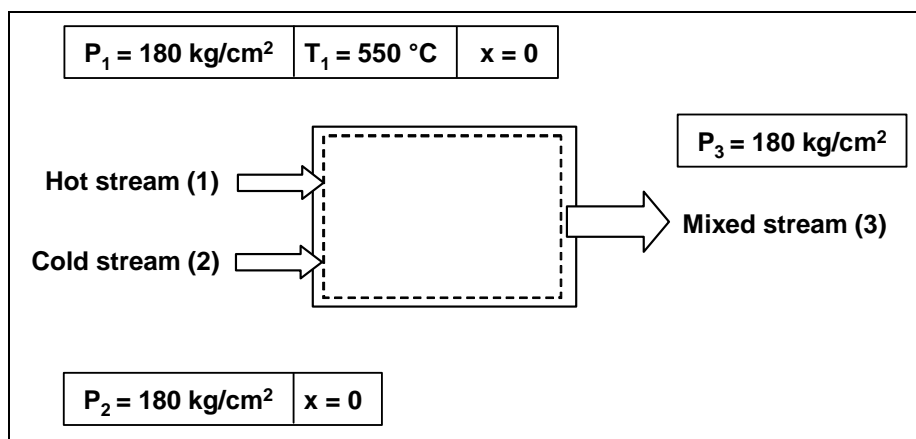

Figure 7.8: Mixing chamber of two flows

Solution

The mass balance of the system is:

$$m_1 + m_2 = m_3$$

Since there is no work or heat transfer to the process and the kinetic and potential energy can be assumed to be zero, the energy balance reduces to:

$$m_1 h_1 + m_2 h_2 = (m_2 + m_1) h_3$$

At P_1 and T_1 , the specific enthalpy and entropy obtained through the property tables is: $h_1 = 3414.2$ kJ/kg and $s_1 = 6.41$ kJ/kg K respectively. For the saturated liquid at the cold stream

(2), only one property (pressure in this case) is needed to fix the state: $h_2 = 1717.06$ kJ/kg and $s_2 = 3.85$ kJ/kg K. From the energy balance applied above:

$$h_3 = \frac{1.1 \times 10^6 (3414.2) + 30 \times 10^3 (1717.06)}{1.13 \times 10^6} = 3369.14 \text{ kJ/kg}$$

At the mixed stream (3), with h_3 and P_3 , $T_3 = 534$ °C and $s_3 = 6.35$ kJ/kg K.

The change in specific enthalpy and entropy can be obtained with the help of the property tables. The specific flow exergy is calculated, where $T_0 = 273$ K and the potential and kinetic energy are considered negligible. Hence:

$e_1 = 1664.52$ kJ/kg	$e_2 = 666.67$ kJ/kg	and	$e_3 = 1634.55$ kJ/kg
-----------------------	----------------------	-----	-----------------------

The irreversibility is obtained through the exergy balance:

$$I = m_1(e_1 - e_3) + m_2(e_2 - e_3) \Rightarrow$$

$$I = 1.1 \times 10^6 (1664.52 - 1634.55) + 30 \times 10^3 (666.67 - 1634.55) = 3.76 \times 10^6 \text{ kJ/h} = 1.04 \text{ MW}$$

The T-s diagram is shown in Figure 7.9:

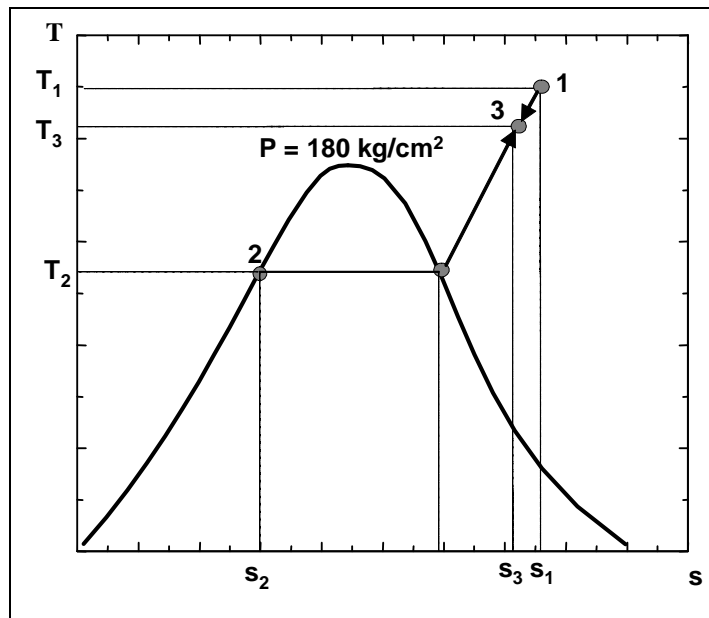

Figure 7.9: T-s diagram for the mixing process of the example

Remarks for all three case studies

Irreversibilities are the effects of any improvable energy system. Besides a voiding finite pressure, temperature and/or chemical potential differences, the causes of poor energy design come from decoupling supply and demand. Time plays an important role in energy efficient systems. Energy systems spontaneously decrease their pressure, temperature and chemical potential to reach equilibrium with their surroundings. To avoid this, there are two strategies:

- to couple energy donors with energy acceptors immediately
- storage: to enclose a system within rigid walls for pressure, adiabatic walls for temperature, and/or to confine the chemical systems into metastable states.

In other words, confine the systems into reservoirs that maintain their intensive properties constant with time.

7.3 Example of the application of energy efficiency

7.3.1 Ethylene cracker

Ethylene crackers convert feedstock coming from the refinery into ethylene and propylene which form the main feedstock for the polymers industry. Ethylene crackers are highly energy intensive. Energy costs represent more than 50 % of the operational costs of a unit.

Feedstocks (F_i) typically are naphtha, LPG and gasoil coming from refineries. The main products (P_1) are ethylene and propylene. Within the industry however, it is the custom to add three other high value products to the main products for comparison purposes: butadiene, benzene and hydrogen. Butadiene and benzene do not, in fact, come out as pure products in a cracker. Butadiene is part of the C_4 stream and benzene of the cracker petrol stream. They are usually extracted in dedicated extraction units which do not form part of the overall picture of the ethylene crackers.

Usually the ratio of these high value products to ethylene varies in a narrow window (between 1.7 and 2.3) and will depend on cracking conditions and feedstock quality/type.

For plants where the economics are mostly driven by ethylene production, a more meaningful energy indicator might be to divide energy use by ethylene production rather than by high value chemicals.

Energy vectors

- steam: a typical ethylene cracker would usually have several steam levels (a high pressure level of approx. 100 barg, a medium pressure level of approx. 20 barg and low pressure level of approx. 4 barg). Depending on the configuration, the cracker will import steam at some levels and export at other levels
- electricity: most crackers are net electricity consumers. Those equipped with cogeneration may be net exporters of electricity. Within the industry, the convention is to use a conversion factor of 37.5 % to convert electricity to primary energy when comparing different plants
- hot water: most crackers produce relatively large amounts of hot water. However, in most cases, the temperature of this hot water is too low for use by other plants but, in some cases, integration with other plants or outside consumers is possible. In this case a credit should be given for export of these calories. So, an improvement of energy efficiency is determined by an 'external' circumstance, independent of the 'intrinsic' performance characteristics of the unit under examination that is the actual possibility of using an output stream for a duty that otherwise should be satisfied with additional primary energy. As a consequence, two units with the same 'intrinsic' performance would be rated differently if only one of them can find an energy use for one of its output streams (heat integration)
- fuel: most crackers produce a liquid fuel (pyrolysis fuel oil) and gaseous fuel (a methane rich mixture). Most of the gaseous fuel is recycled to fire the ethylene furnaces. Depending on the configuration and mode of operation, the gaseous fuel produced may be self sufficient to fire all the furnaces and the rest of fuel gas is exported, or there may still be a deficit so the import of an external fuel is required which is typically natural gas. Only the fuel consumed internally by the ethylene cracker is taken into account in the energy balance. All fuels exported are counted as products (this is logic as the fuel value was already present in the feedstock)
- cooling water: all crackers use cooling water. Sometimes cooling towers are part of the ethylene cracker; however, this cooling water comes from cooling towers which also supply cooling water to other production units. In this case, the energy related to the production of cooling water is often not reported when calculating the energy efficiency of the process

- ethylene processes also use other utilities such as N_2 and compressed air. Often these utilities are produced centrally on the site or by a third party. The energy related to these utilities is often not counted.

7.3.2 Vinyl acetate monomer (VAM) production

Some of the components of the proposed section to calculate the energy intensity factor (EIF) may not be applicable for each process. Therefore, it has to be modified to the prevailing needs.

As an example, a vinyl acetate monomer (VAM) plant is taken. Several components of a VAM plant are not being measured or quantified (marked with ? in Figure 7.10) whereas others can easily be named (marked with ✓ in Figure 7.10).

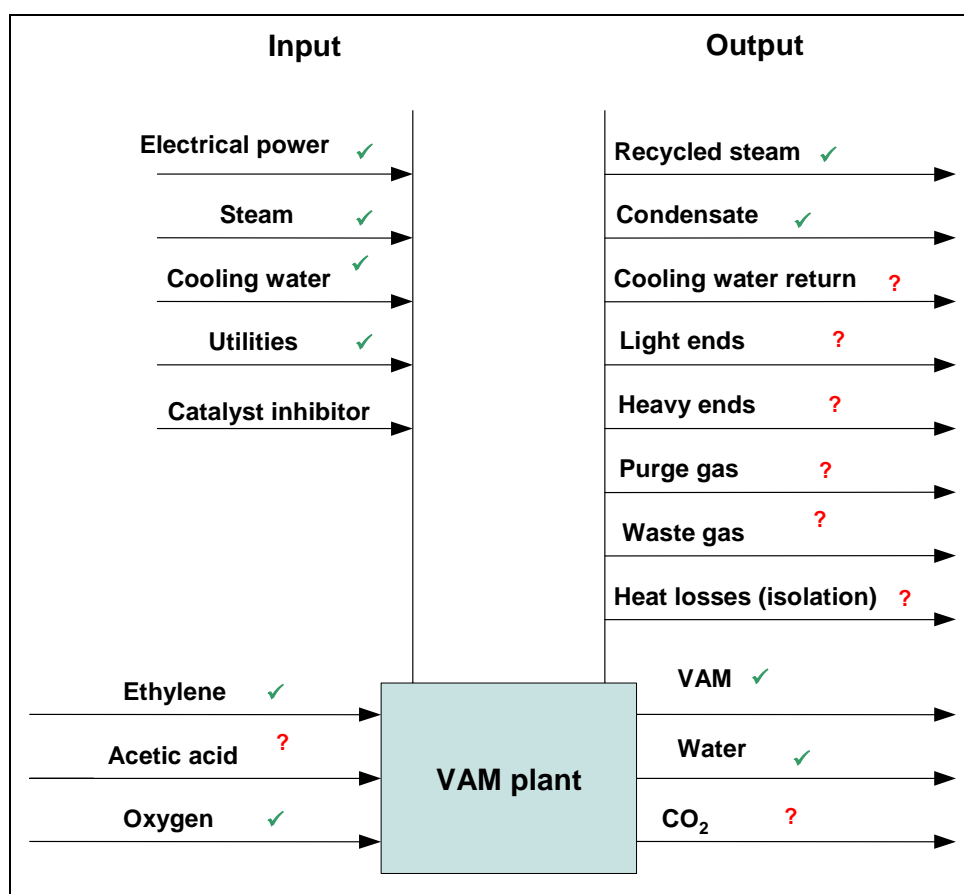

Figure 7.10: Inputs and outputs for a vinyl acetate monomer (VAM) plant

Heat losses via cooling water return and isolation should never be counted in the EIF or EEI. Waste gas and purge gas should not be counted if it is incinerated without heat recovery. For those terms it may, however, be useful to gain some insight into their order of magnitude to verify the economic potential needed to reduce these losses or waste streams.

In contrast, more reflection is required on the other terms such as light and heavy ends or if waste and/or purge gas are valorised in other processes. In the proposed model, these streams were not included as it is assumed that the fuel content of these streams is already present in the feedstock. However, it is the responsibility of the operator to define how to account for these terms.

7.3.3 A hot rolling mill in a steel works

The feeding to a rolling mill consists of approximately 2 decimetres thick, flat steel plates that are to be rolled out to bands with a thickness of a few millimetres. The rolling mill consists of furnaces, rolling mill equipment, cooling equipment and support systems including pumps, fans, hydraulics and lubricating systems, lights, a mechanical workshop, staff space, changing rooms, etc.

A flow chart of a rolling mill is shown in Figure 7.11.

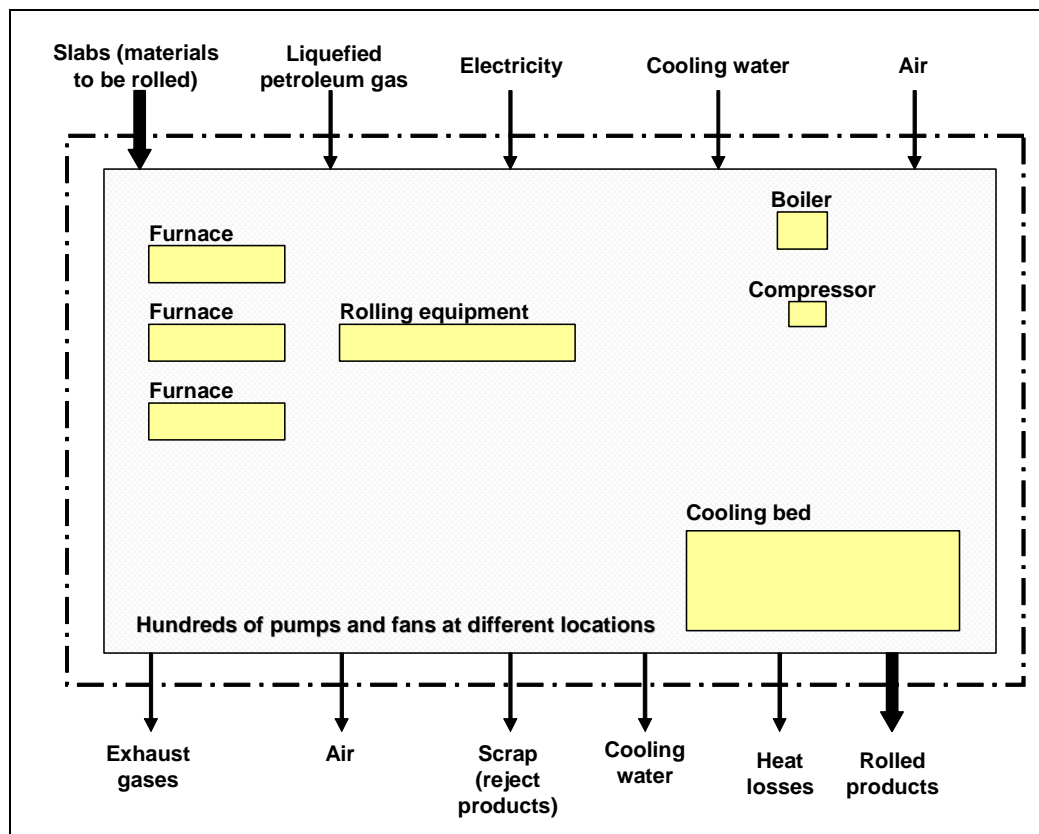

Figure 7.11: Flow chart of a rolling mill

In this case, several different primary energy sources are involved. However, the following discussion is restricted to the use of electric energy. The number of electrically driven components or sub-systems in a rolling mill can be estimated at more than one thousand.

The electric energy consumption can be registered easily with reliable electricity meters. Steel production may either mean the weight of slabs entering the rolling mill or the weight of rolled and approved final products. The difference corresponds to the weight of scraps that may fall at different stages in the rolling mill.

An analysis of data taken from an existing rolling mill during a period of 11 weeks was made and some of the results are shown in Figure 7.12. The energy consumption varied between around 80 and 120 kWh per tonne delivered products, dependent on how many tonnes that were produced per week. The average consumption was thus 100 kWh/tonne and the variation $\pm 20\%$. No energy savings measures were taken during this period.

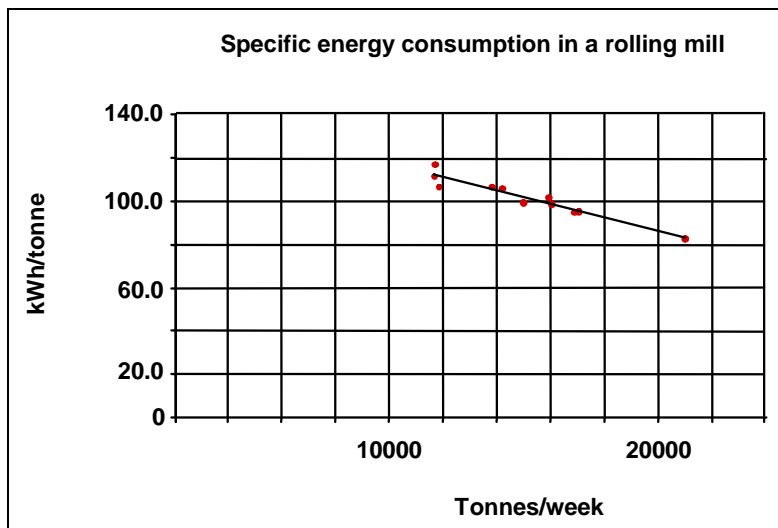

Figure 7.12: Specific energy consumption in a rolling mill

The reduction of the specific energy consumption with an increasing production rate is quite normal and is caused by two factors:

- the production equipment will be operating for longer periods when the production rate is high. This means that the idling periods become shorter. Some types of equipment run continuously, even during non-production time. This type of energy consumption will be reduced when the non-production time gets shorter
- there is a base energy consumption that does not depend on the utilisation of production capacity. This consumption is related to the use of lighting, fans for ventilation, office machines, etc. At higher production rates, the consumption will be spread over more tonnes of products.

The decrease in the specific energy consumption with an increasing production rate is thus caused by fluctuations in market conditions which are beyond the company's control.

A programme to improve energy efficiency was then carried out at the rolling mill. A number of measures were taken with the aim of decreasing the energy consumption and the results of these measures are illustrated in Figure 7.13. The results appeared to be largely independent of the production rate. As can be seen in Figure 7.13, it is possible to separate the results of energy saving efforts and results caused by other factors, such as the utilisation of capacity

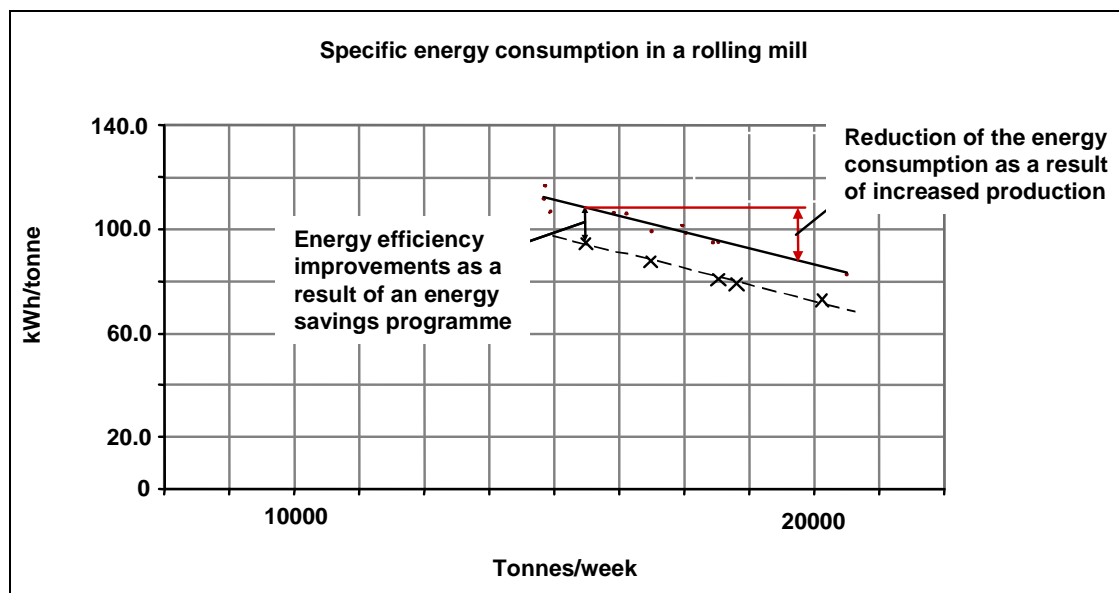

Figure 7.13: Changes in specific energy consumption in a rolling mill

It is also obvious that interpretation difficulties will arise when comparing the specific energy consumption month by month or year by year. The specific energy consumption may very well increase from one period to the next though a number of energy savings measures have been taken. In this case, the effect of such measures is not large enough to compensate for the increase in energy consumption due to low production rates.

7.4 Examples of implementation of energy efficiency management systems

Example 1: Aughinish Alumina (AAL), Ireland [161, SEI, 2006]

Aughinish Alumina (AAL) is Europe's largest alumina refinery, producing more than 1.6 million tonnes of alumina yearly by treating bauxite ore, which is then exported to smelters for processing into aluminium. The plant, located on the island of Aughinish, Co Limerick, is one of Ireland's largest energy users and employs 400 staff. Alumina refining is an energy intensive process, with energy accounting for about 30 % of the total cost.

The company responded to a suggestion by Sustainable Energy Ireland (SEI) to implement an ENEMS. The system chosen was the Danish DS 2403 (the Irish IS 393 is based on this, and has subsequently been issued). The company chose a standardised system to guarantee delivery of a systematic and structured approach to improving energy and reducing energy-related costs. DS 2403 is very similar to ISO 14001, and this was of major benefit, as it required little more than shaping the ENEMS to fit with the existing ISO 14001 procedures.

Danish consultants carried out a preliminary review and audit, and a gap analysis of what was needed to meet the standard. A full time energy manager was appointed to develop the necessary systems. AAL already had extensive metering in place so the emphasis was on making better use of available data and instigating formal reviews and reporting procedures to highlight problems and identify opportunities.

All engineers, maintenance, and purchasing personnel whose work was directly affected by the requirements of the standard were given a one-day training course on its operation. The remaining 400 employees were given a one-hour 'energy awareness' presentation covering more general points.

Examples of actions identified and undertaken:

- Improved heat recovery*

A series of shell and tube heaters use regenerative steam to heat boiler feed-water to 120 °C before it enters the deaerators. The performance of the heaters was poor for some time, due to scaling in the steam lines. This led to non-conformances, which in turn initiated a more focused programme of troubleshooting to identify how best to resolve the problem. Thermographic analysis and pressure surveys identified possible regions of high pressure drop in steam lines. This information, coupled with detailed calculations to identify what pressure drops were tolerable, indicated that AAL should make specific modifications in one area during the annual plant shutdown. The analysis proved correct and the modifications resulted in a significant improvement in energy efficiency. The approach was successfully applied in another location and further improvements are expected when other areas are modified later in 2006.
- Higher feed temperature for input stream*

Lime slurry must be added to the digester to control extraction. The slurry temperature must be as high as possible, otherwise the digester will require more steam from the boilers to achieve its target temperature. Operating problems early in 2005 resulted in low slurry temperatures and non-conformances. The resulting investigation identified a simple, low cost method of resolving the problem; it is unlikely that this would have happened without the standard. Although the saving was small in the context of AAL's overall energy bill, it was nonetheless real and also improved operation of the lime slaker.

Example 2: Outokumpu, Tornio works, Finland [160, Aguado, 2007]

Outokumpu is an international company and Tornio works is the world's largest integrated site producing stainless steel, with a capacity of 1.65 M tonnes and employing 2300 staff. They are integrating their energy efficiency management with their ISO 14001 EMS, and energy consumption reporting within this will be instigated at the site before 1 Dec 2007. They were listed in the Dow Jones Sustainability Index in 2006, which charts corporate responsibility.

Other sites: Avesta, Degerfors and Nyby successfully certified their energy efficiency MS systems to SS 627750 in 2006. Avesta has a Dec 2007 target to reduce electricity consumption by 3 % from 980 to 950 kWh/tonne, and fuel efficiency (LPG) by 2 % from 608 to 596 kWh/tonne. Degerfors has the objective to reduce energy use for heating in the dispatching area by 40 % from 2005. Sheffield (melting shop) is to introduce a new energy management system, with an energy group and energy champion, and aims to reduce non-production energy use by 10 %, against 2006 usage (again, by Dec 2007).

Example 3: The Dow Chemical Company [163, Dow, 2005]

The Dow Chemical Company is an international company with six operating segments, 28 businesses and more than 3200 products with annual sales of EUR 29 400 million (1USD = 0.73416 EUR, 1st January 2005). They employ 43 000 staff on 208 manufacturing sites in 38 countries worldwide. Their power consumption is 3 500 MW, of which 54 % is generated internally and 74 % of this is cogeneration.

Dow uses the management systems, work process and continuous improvement tools that are already in place.

Goals set by the Global Management Board: 1995 – 2005, improvement in energy efficiency 2 % per year (20 % total with 1994 as reference year). 2005 – 2015 goals were being set in 2005.

Strategy: to ensure long term sustainability, business units include energy efficiency and conservation goals and plans as part of their strategic planning and project implementation.

Dow's implementation of energy efficiency addresses all the requirements as set out in Section 2.1 such as a defined structure, communication, data management, identification of opportunities and implementation. Energy efficiency is part of 'most effective technology' development and appropriately evaluated in long term investments. Marketing, brainstorming and leveraging are also used. There is a global energy conservation leader, supporting all the businesses in Dow. Each location has an energy efficiency focal point/leader to co-ordinate the energy efficiency activities in that location, with energy conservation steering teams at major hub locations.

Staff are engaged by publicised success stories, energy efficiency tools everyone can use, external links, savings contests, and other activities.

The structure is integrated, site energy steering teams comprise site and plant leadership, and an 'across the business envelope' approach. This ensures process plant objectives really translate into actual savings at a company level, maximises integration and energy use synergies between plants, sharing and leveraging of ideas and projects, as well as identifying opportunities at site level and planning.

A key factor is the use of existing work processes and continuous improvement tools with:

- a focus on engineering/most effective technology – energy efficient solutions
- a focus on maintenance/operations/energy teams
- inclusion of by-product fuels/alternative energy and improvements in energy intensity reporting (the use of by-product fuel might have a negative effect on overall fuel efficiency, but could reduce CO₂ emission by other fossil fuels, therefore should not be penalised as a negative effect on energy efficiency)
- six sigma implementation: this is a data driven methodology to 'reduce rework' and 'sustain the gains', and involves systematic 'measure-analyse-improve-control'. It uses (among others) customer requirement evaluation, statistical analyses and opportunity prioritisation tools. Improvement implementation focuses on change management, management commitment and communication.

Achievements

Dow achieved the targeted 20 % reduction in specific energy consumption (referred to as energy intensity by Dow and other chemical and petrochemical companies), down from 13 849 kJ/kg of product to 11 079 kJ/kg, measured as kg of total DOW product mix.

Examples of specific improvements

Dow Central Germany (five locations):

- optimisation of the Boehlen location steam and fuel gas balance resulted in a considerable annual CO₂ reduction, and (local) energy efficiency improvement
- a hydrogen envelope improvement project was initiated between two locations (40 km apart) to minimise the vented/flared hydrogen and maximise chemical and fuel usage which resulted in a closed hydrogen balance (minimised losses) and CO₂ reduction measures.

Freeport site, Texas, US:

- initiation of a site-wide programme to reduce electrical consumption on motor driven systems. A tool was developed to allow operations personnel to assess energy savings opportunities and to either develop operating procedures to reduce energy use or to identify opportunities for engineering changes.

Terneuzen site, NL:

- optimisation of the steam balances between power and utilities and the olefins cracker production facilities resulted in less steam losses and more efficient steam reduction (turbine/reduction stations).

7.5 Example of energy efficient core processes

Example 1: The enzymatic production of acrylamide (Mitsubishi Rayon, Japan)

[164, OECD, 2001]

In the classic process, acrylonitrile was hydrolysed by the addition of stoichiometric amounts of sulphuric acid in the presence of polymerisation inhibitors to prevent both starting materials and products polymerising. In the 1970s, a heterogeneous copper catalyst was developed which eliminated the need for sulphuric acid. It had many advantages and was widely applied.

However, the development in polymerisation technologies and polymer applications created a new demand for a more highly purified acrylamide monomer. This revealed that the acrylamide produced by the catalytic process, which had been recognised as high quality, nevertheless contained minor by-products that affected the polymerisation reactions. The Medical Research Council (MRC) therefore started development of an enzymatic acrylamide production process which reduced the level of by-products. This was hydrolysis using a recoverable immobilised whole cell catalyst.

Pilot scale development of the first-generation microbe took one and a half years for process development and quality assurance. For the second and third generations, about six months of bench-scale tests were sufficient to ensure the process application and product quality. The development of the Genetic modified organism (GMO) took about seven years to build up the relevant technologies. The worldwide acrylamide production is shown in Table 7.3.

Process	Worldwide acrylamide production capacity 10 ⁵ tonnes/year			
	Japan	Asia (excl. Japan)	United States	Europe
Catalytic 0.	9	0.75	1.35	1.15
Enzymatic (1998)	0.2	0.2	0.1	0.35
Enzymatic (2001, est.)	n.a.	0.5	n.a.	0.45

Table 7.3: Worldwide acrylamide production capacity 10⁵ tonnes/year
[164, OECD, 2001]

The first enzymatic process required decolourisation and concentration steps, but the new process did not, see Table 7.4

Reaction process	Catalytic (1971)	Enzymatic (1985)
Reaction temperature	343K	273 – 288K
One-pass reaction yield	70 – 80 %	~ 100 %
Acrylamide concentration	~ 30 %	48 – 50 %
Concentration R	equipped	Not required
Purification	Catalyst removal	Protein removal

Table 7.4: Comparison of acrylamide processes
[164, OECD, 2001]

Comparative studies have been carried out on the environmental impacts of the catalytic processes, the original enzymatic processes and the new enzymatic processes. The conclusions are that the biotechnological approach has lower impacts than the catalytic process, particularly for energy consumption and carbon dioxide production. The energy savings are given in Table 7.5 and Table 7.6.

	Catalytic process	Enzymatic (old process)	Enzymatic (new process)
Steam l.	6	2.8	0.3
Electric power	0.3	0.5	0.1
Raw materials	3.1	3.1	3.1

Table 7.5: Comparison of energy consumption as MJ/kg acrylamide
[164, OECD, 2001]

	Catalytic	Enzymatic (old)	Enzymatic (new)
Steam l.	25	2.0	0.2
Electric power	0.25	0.25	0.1
Raw materials	2.3	2.3	2.3

Table 7.6: Comparison of CO₂ production kg CO₂/kg acrylamide
[164, OECD, 2001]

Example 2: Use of radiation cured inks or paint systems in place of conventional solvent-based systems

54" heat set press (≈ 1.37 m). A typical print job is 35 – 40 % coverage on a light 12-point board stock. The calculations are based on three shifts, 75 % available hours running = 4680 hours per year.

Conventional inks and drying system:

Solvent-based inks and coatings, 60 – 65 % solids. The dryers use gas to heat air to approx. 150 °C. The electricity to move the air is included in the calculation.

Often, the substrate is cooled over chill rollers after the ovens. The solvent-laden air (waste gas) is usually treated (by oxidisers). The energy requirements for these two systems have not been included in the calculation.

Electron beam (EB) system:

EB inks are 100 % solids. When exposed to high-energy electrons they polymerise or cure (melt and then harden). Minimal heat is deposited into the substrate (temperature shift about 8 – 12 °C so no cooling is required). There are no waste gases containing solvent to treat. However, the EB curing requires an inert nitrogen atmosphere. No data for the energy used to generate were given, so the cost per unit volume of N₂ has been assumed to be entirely electrical energy used in its generation, and this has been added to the energy usage. The energy savings made from an electron beam ink system are shown in Table 7.7.

GJ per year	Conventional	EB
Gas	4.67×10^4	-
Electric	384	5.31×10^3
	4.7×10^4	5.31×10^3
Savings	4169	0 GJ/yr
		89 %
Cost savings		USD 649162 (2006, on combined NG and electricity cost)

Table 7.7: Energy savings made from an electron beam ink system
[175, Saunders_R., 2006]

Example 3. Heat recovery in broiler housing (intensive chicken farming)

Normally, the air in a broiler house is heated. In the 'combideck' system, the floor is heated. The system consists of a heat pump, underground storage comprising tubes, and a layer of isolated hollow strips below the floor. Broilers require heat until about day 21 (about 28 °C), which is supplied by pumping hot water through the underfloor system. After a short period of equilibrium, the growing process generates excess heat. This is now absorbed into water in the underfloor system and is stored in the ground. The system has a better performance on broiler production (reduction of mortality, higher meat price, better feed ratio) and a positive effect on animal welfare (less heat stress, lower mortality, less veterinary services needed).

Investment costs are EUR 2 per broiler place with 20 broilers per m². Operational costs (depreciation, interest and maintenance) are EUR 0.20 per broiler place per year. The annual increased yields reportedly outweighed the yearly operational costs by a factor of about 3. For instance, veterinarian costs were reduced by about 30 %. Energy costs were reduced by about 52 %. The payback time is about 4 – 6 years. [173, EIPPCB, 2003]

7.6 Example of maintaining the impetus of energy efficiency initiatives: operational excellence

Example 1: Shell Nederland Chemie, Moerdijk, the Netherlands (900 000 mt/year ethylene plant)

This company sought to reduce energy costs and carbon dioxide emissions. A project was implemented in partnership with Shell Global Solutions using the company's 'Energise' programme.

The plant staff were constantly searching for ways of saving energy, but had limited time, due to the need to concentrate on maintaining production continuity and product quality. There was doubt that significant savings could be made at the lower olefins plant, as it was already very energy efficient. However, Energise consultants worked with plant representatives to devise operational improvements designed to reduce energy use.

Initially, the team identified 150 opportunities for improvement, and, after review, 23 of these were developed and implemented as formal projects. Work was carried out without a shutdown and while the plant was operational. About 59 % of the total savings were obtained by modifying process control strategies, including configuring new control loops and optimising set points. The remainder of the savings came through procedural changes (23 % of the total) and by improving maintenance of process equipment and instrumentation (18 %). The key improvement areas were:

- significant savings made by adjusting the pressure levels around the compressor systems, and installing new instruments to facilitate the running of the compressors at optimal performance. Control modifications for the propylene refrigerant compressors cut power demand by about 10 %, for example
- operational variation which was also significantly reduced over the entire throughput range, which decreases the likelihood of capacity restrictions, and may avoid the occasional need to reduce overall plant throughput. In particular, summertime capacity bottlenecks have been significantly reduced
- that many of the energy savings came from achieving a better understanding of the plant's steam balance, fine-tuning of the equipment, and investing in instrumentation to monitor equipment performance.

The focus was on operational excellence, best practices and process control strategies, not investment in new hardware. The series of small-scale projects had a capital investment of USD 100 000 (reported in 2006: about EUR 75 000) for engineering, procurement, and construction of the additional electronic instrumentation.

Energy savings of USD 5 million/year (about EUR 3.6 million), or 3.5 % were achieved.

Example 2: Dow Corning, several installations

Operational excellence was implemented at all plants, by improving manufacturing assets with heightened operating discipline. The plants became more reliable and operated predictably, yielding significant benefits in higher product quality and higher plant utilisation. This revealed hidden capacities in all plants of generally 15 – 20 %, with minimal capital investment.

7.7 Monitoring and metering

7.7.1 Quantitative measurements – metering

Two corporate divisions (operating units) shared one electricity utility meter. Costs were split on a 60/40 basis. The unit paying 60 % had disproportionately high energy costs, and as a consequence of this allocated fixed cost, the closure and relocation of the unit to another site was considered. An advanced metering system with automated meter reading was installed (see Section 2.15.2). This showed that the division paying 60 % was actually using <41 % of the complex's electrical energy. It also identified a heat treating process that caused a 175 kW spike once a week. This was moved to a time of day with a cheaper tariff (see Section 7.1.1). Total savings were USD 324 000 (\approx EUR 240 000) per year [183, Bovankovich, 2007] [227, TWG].

7.7.2 Model-based utilities – optimisation and management

Example 1: Schott AG, DE

The company produces different kinds of glass products and has several production sites in Germany and elsewhere.

Energy consumption and related costs were historically allocated to various units within the company on a fixed basis, and not on actual usage. The managers could therefore not influence their energy costs, so there was little motivation to reduce consumption. The company introduced an automated energy monitoring system (ECS – energy control system), with fully electronic metering and software modelling:

- electricity: 940 measuring points
- water: 203 measuring points
- gas: 49 measuring points
- compressed air: 43 measuring points
- fuel oil: 8 measuring points
- N₂, O₂, NH₃: 7 measuring points.

Achieved environmental benefits:

- energy savings by raised cost consciousness
- optimisation of energy use.

Operational benefits:

- faster elimination of defects with less production losses
- smoothing of energy delivery
- transparency of energy flows.

Economics:

- software: about EUR 50 000
- hardware: about EUR 500/measuring point
- savings per year:
 - peak load lowering at delivery of electricity: about 3 to 5 %
 - payback period: about 0.9 to 2 years (dependent on project)

Schott glass: [127, TWG]

Example 2: Atrium Hospital, Heerleen, NL

The hospital had built a state-of-the-art trigeneration utility in the late 1990s, to produce and deliver steam, heat, electricity and cooling to the hospital 24 hours a day, with 100 % reliability. The utility comprises a hot water boiler, two steam boilers, electrical and absorption chiller units, heat exchangers, two gas engine based CHP units and two emergency generators. The complexity of the plant and utility, and the fuel costs made optimum economic operation impossible. A survey was carried out. As a result, a flue-gas condenser was installed, saving about 520 to 713 MWh per year: 5 % of the energy demand. A real-time utilities management system was installed, with an internal ROI of 49 % (at about EUR 75 000 – 95 000/yr on a variable energy cost of about EUR 1.2 million [179, Stijns, 2005].

7.7.3 Energy models, databases and balances**Example 1: Electric energy models**

The content of a simple electric model is illustrated in Table 7.8.

		A	B	C	D	E	F	G
Departments	Devices	n.	Rated power kW	Rated efficiency	Working hours per year	Load factor	Energy consumed kWh	%
Department 1	Device 1	10	55	0.92	500	1	298913	
	Device 2	20	40	85	4000	0.8	301176	
	Device 3	15	10	0.9	4000	0.9	600000	
Total Dept. 1			780				1200089	17.5
Department 2	Device 1	1	500	0.85	3500	0.5	1029411	
	Device 2	20	15	0.9	4000	1	1333333	
	Device 3	5	7.5	0.8	4500	0.9	189844	
	Device 4	10	2	0.75	1500	0.8	32000	
	Device 5	3	150	0.92	3000	0.95	1394022	
Total Dept. 2			1307				3978611	58.1
Department #.	Device.
TOTALS			3250				5425000	100.0

Table 7.8: A simple electric model

‘n.’ in column ‘A’ represents the number of identical devices (under both a technical and an operating point of view) present in that department.

The ‘energy consumed’ in column ‘F’ is given by multiplying the number of devices x rated power x working hours x load factor and dividing by rated efficiency:

$$F = \frac{A * B * D * E}{C} \quad \text{Equation 7.24}$$

By adding all energies consumed in each department, the total energy consumed by the entire plant can be calculated.

If the context studied is not so broad or complex, this kind of model could be adequate to detect the areas where energy saving possibilities are most likely to be found. It is sufficient to direct attention to the distribution of electricity consumptions for each department, shown in column 'G'. It is very likely that a series of actions to improve energy efficiency will be found in those departments where consumption of energy is the highest, while departments whose consumption is low can be neglected or taken into account later.

When the context deserves it (because the cycle of production is extremely complex, or when energy data have never been collected before) it would also be useful to collect the following data to identify energy saving actions, e.g.

- for motors and drives:
 - kind of machinery driven by the motor (compressor, fan, pump, etc.)
 - identification code
 - manufacturer and model name
 - type of motor
 - installation year, or residual life
 - number of rewinds carried out so far
 - type of speed control if existing
 - type of mechanical transmission
 - possibility to shift the operation to different times (to exploit more favourable electricity tariffs at specific times or on specific days)

- for lighting apparatus:
 - type of lighting body
 - number of lamps in a body
 - number of lighting bodies
 - type of lamps
 - rated power of the lamp
 - efficiency of the lamp
 - kind of ballast (iron, copper or high frequency).

Example 2. Thermal energy models

Although all previous data should be collected, in the first level thermal model ('generators' side) only a few of them must be taken into account as in the drawing of an electric model (see Table 7.9):

		A	B	C	D	E	F	G
Process	Device	n.	Rated power kW _{th}	Rated efficiency	Working hours per year	Load factor	Energy consumed Nm ³ CH ₄	%
Phase 1 (e.g. burning)	Big kilns	4	800 0.	85	7700	0.8	2417000	
	Small kilns	5	600 0.	85	7700	0.8	2266000	
Total phase 1		6200					4683000	76.5
Phase 2 (e.g. heat production)	Hot water boiler	2	2500 0.	92	1000	0.5	283200	
	Steam boiler	2	1000 0.	92	7000	0.5	793200	
	Hot water boiler	2	1000 0.	92	1600	0.5	181200	
Total phase 2		9000					1257600	20.5
Phase 3 (e.g. Services)	Spray drier	1	400 0.	7	200	1	11900	...
	Hot air generator	1	400 0.	85	1600	0.5	39200	
	Small heaters	37	30	0.8	1600	0.5	115700	
	Big heaters	2	60 0.	8	1600	0.5	12500	3.0
Total phase 3		2030					179300	
TOTALS		3250					6119900	100.0

Table 7.9: Data in a thermal energy model (generators side)

In this case, to make the comparison easier, the energy consumed has been estimated as Nm³ of natural gas. The amounts of natural gas consumed are given, in this case, by:

$$F = \frac{A \times B \times D \times E \times 3600}{C \times 34\,500}$$

Where

• 3600	conversion factor from kWh to kJ
• 34 500	is the net heating value for natural gas (kJ/Nm ³).

The first level thermal model ('generators' side) must be checked to see if the total amount of energy demand is equal to the total energy reported in the invoices for natural gas supply. If so, the model is reliable and useful to indicate the best areas in which to implement energy saving actions.

When assessing the thermal use of energy, second level models ('users' side) are also required to be built. To draw up such data sheets, it is necessary to take a census of all machinery needing thermal energy in any form (hot water, steam, hot air, etc.) except fuel (taken into account in the first level model).

For every item of machinery, the following data should be collected:

- kind of thermal carrier needed
- hours/year of thermal demand
- load factor at which thermal energy is used
- rated thermal power.

Such data can be arranged in Table 7.10 as follows.

		A	B	C	D	E	F	G
Departments	Devices	n.	Thermal carrier	Thermal power kWth	Working hours per year	Load factor	Energy request Nm ³ CH ₄	%
Department 1	Device 1	2	Steam	500	1000	1	104200	
	Device 2	1	Steam	125	500	0.8	5200	
	Device 3	5	Hot water	75 5000		0.8	156400	
Total Dept. 1							265800	21.8
Department 2	Device 1	1	Steam	75	2500	0.5	9800	
	Device 2	20	Hot air	10	3000	1	62500	
	Device 3	5	Steam	50	2500	0.8	52100	
	Device 4	10	Hot water	5	1500	0.8	6300	
	Device 5	3	Steam	25	3000	0.9	21100	
Total Dept. 2							151800	12.5
Department.	Device.							
TOTALS							1215700	10.0

Table 7.10: Data in a thermal energy model (users side)

The second level model ('users' side') is used to verify the match between the heat supplied by the utilities (boilers, heat generators, etc.) and the heat requested by the users. In this case, the amounts in column F are given by:

$$F = \frac{A \times C \times D \times E \times 3600}{34\,500}$$

In Table 7.9, the calculation was as follows:

$$1\,257\,600 + 179\,300 = 1\,436\,900 \text{ Nm}^3 \text{ of natural gas supplied.}$$

In the second level model shown in Table 7.10 the calculation shows 1 215 700 Nm³ of natural gas demand. The 15 % difference is due to the efficiencies at the following steps: heat generation, distribution piping and regulation, and final use.

If this difference is acceptable, then the two models can be considered as 'certified'; in the opposite case some correction (normally to the number of working hours or the load factors) is needed to reach convergence.

If the difference between the two amounts is big, this is due to a high level of losses in the production-distribution-use for different carriers (e.g. steam, hot water). In this case, different actions aiming to improve the energy efficiencies, for example, in the field of insulations, of recovery of condensate, are likely to be possible.

7.8 Other tools used for auditing tools and supporting other techniques used at a site level

7.8.1 Auditing and energy management tools

Many tools have been developed to ‘standardise’ contents and approaches of audits. Usually external audit companies have their own tailor-made tools, such as checklists to use in auditing procedures. Other tools are produced by trade associations, government bodies, etc. The list below briefly reviews some of the types of tools used to assist audits and monitoring of energy efficiency activities. Many of these tools may overlap and it is the responsibility of the auditor or operator to determine what is necessary to use. The above-mentioned tools are general, and not specific to a target sector or an energy audit model, but their usefulness frequently corresponds to one or several phases of the audit survey:

- **audit guide or audit handbook, energy management handbook:** this is a core component of an energy audit scheme, which is the basis of training sessions and is targeted essentially to auditors. It explains and describes how an audit is to be made, how the calculations are to be conducted, and the types and contents of the most frequently proposed energy conservation options (ECOs). Although auditors are assumed to have some background in thermodynamics (and also electrical engineering), these handbooks frequently entail a section of reminders on these energy related topics
- **energy checks, checklists or walk-through guides:** associated with energy audit models of the scanning type, these supporting documents are developed in order to facilitate the work of the auditor, assuring at the same time both the quality and the speed of the survey. They are primarily intended for energy auditors but can also be used as self-auditing tools for those energy managers in industrial premises who intend to start an in-house energy management process before requesting external assistance. Checklists can be:
 - general (see maintenance, Section 2.9)
 - specific for some activities (see energy audits, Section 2.11)
 - specific for some technical systems (utilities and buildings)
 - specific for some industrial branches (production processes).

They may also be used to identify compliance or energy savings opportunities with best practices in energy management or in technologies (see Implementation and operation of procedures in Section 2.1, and Operational excellence, Section 2.5).

- **calculation methods and software:** also known as energy models. These are another core component of energy audit schemes, and are associated with analytical energy audit models. Their primary objective is to help the auditor in the quantitative assessment of energy savings potentials and evaluation of investment costs and paybacks. The use (by an auditor) of a recommended or certified calculation tool (provided it is used correctly) assists with achieving quality results for the audited client
- **data collection form(s):** generally associated with the calculation tool for which they constitute the input data, this type of support document helps the auditor in collecting all the necessary information for the survey. It will be part of the final report and will also contribute to facilitating the follow-up of the site energy features and the interpretation of the audit results and recommendations
- **report templates:** as for data collection forms, report templates are also frequently associated with the calculation tool where output results are integrated in the report. As the report is the deliverable of the audit, using a template helps all the participants to make the most profitable use of the audit service and produce good quality audit reports
- **checklist for quality control of audit reports:** this checklist is a document which can be used at both company level and at auditor level (self-check). It is a complement of, or an alternative to, report templates and a practical translation of energy audit models: the expected results specified in the energy audit model should be in the report and the

checklist is an easy way to verify that the work has therefore been done according to the specifications

- **target values or benchmarking:** (see Section 2.16) these key figures can be used to initiate the need for energy audits, they are also used by the auditors as technical data to justify their recommendations in the case of simplified audits
- **databases on energy conservation options (ECOs):** one difficult part of the audit is having detailed information on costs and consequences of energy savings recommendations. A database of ECOs encompassing this information will save a lot of time and money for the auditor/operator and thus help lower the cost of the audits with a maintained quality. Keeping the data up-to-date requires quite a lot of work. An example is:
 - default data: these can contribute to detailed audits in checking calculations or replacing data difficult to meter or evaluate either way. They may be derived from databases (see above), reference data or experience gained from another site, audit, etc.

7.8.2 Measurement and verification protocol

The International Performance Measurement and Verification Protocol (IPMVP) is an industry-standard protocol for measuring and verifying energy savings. It is a broad framework that outlines a flexible and broad set of measurement and verification approaches for evaluating energy savings in buildings and building systems, e.g. lighting (but not process operations). This allows building owners, energy service companies (ESCOs), and financiers of buildings energy efficiency projects to quantify the performance and energy savings from energy conservation measures (ECMs).

Specific techniques are designed to match project costs and savings requirements with particular efficiency measures and technologies. Each option is applicable to different programmes and projects based on factors such as the complexity of the efficiency measures under evaluation and the risk expectations. Accordingly, each option varies in accuracy and cost of implementation, as well as strengths and limitations. One of the larger goals of this initiative was to help create a secondary market for energy efficiency investments by developing a consistent set of monitoring and verification (M&V) options that can be applied to a range of energy savings measures in a uniform manner resulting in reliable savings over the term of the project.

The protocol is managed through EVO (the Efficiency Valuation Organisation) and more information can be found on:

http://www.evo-world.org/index.php?option=com_content&task=view&id=61&Itemid=80
[92, Motiva Oy, 2005, 227, TWG, , 250, ADEME, 2006, 261, Carbon_Trust_UK, 2005]

7.9 Benchmarking

7.9.1 Mineral oil refineries

The refinery industry already considers energy efficiency issues seriously because energy costs represent more than 50% of global operating costs. On a single refinery level, energy performance can be followed by the energy intensity factor. In fact, it is simpler to use the ratio between globally consumed energy on the site to the amount of treated crude, which is equivalent to the EIF. Following this ratio against time requires interpretation, in order to clarify what comes from energy management and what comes from other factors. However, this ratio cannot be used for the purpose of comparing the energetic performance of different refineries, as all refineries are different in complexities, schemes, processed crudes and production mixes. All these parameters affect the energy needs of the refineries.

Oil refineries convert crude oil into marketable oil products and consume energy in the process. Every refinery is a unique and complex combination of individual process units. Indicators that attempt to capture this complexity have been developed to monitor the energy performance of a given refinery over time and to assess the relative energy performance of different refineries. An attempt to catch this complexity is the Solomon Energy Benchmark for refineries. Solomon Associates have introduced the concept of the energy intensity index (EII). Solomon Associates carry out a worldwide benchmark study of refineries every two years. It covers all aspects such as capacity, maintenance costs, operational expenditure, and energy performance. The energy performance is measured via the EII indicator, which is defined as follows:

$$EII = 100 \times \frac{\text{Total actual refinery energy consumed}}{\Sigma(\text{unit throughput} \times \text{unit energy standard}) + \text{sensible heat} + \text{offsite energy}}$$

In this equation:

- the numerator is the total actual refinery energy consumption (expressed in lower heating value) and equals the total consumption of fuel/electricity (both imported and internal generation), but also takes into account any export of steam and/or electricity. Electricity from the external grid is converted to primary energy using a standard efficiency factor of 37.5 %
- the denominator is the standard energy consumption according to Solomon (called guide energy) and consists of three main elements:
 - the sum of the guide energies for each of the production units: this guide energies are calculated by multiplying the unit utilised capacity (normal throughput or feed rate) with a unit specific energy standard factor provided by Solomon for each unit. For some production units, this energy factor depends on feed quality (e.g. crude density)/operation severity (catalytic reformers, catalytic crackers, etc.)/type of production facility, etc. These guide energies per unit are summed to give the total standard energy consumption for all of the refineries production facilities according to Solomon
 - a sensible heat factor: this factor accounts for the energy required to raise the plant input from ambient temperature to 104.4 °C. The basis for the plant input is all gross raw material input streams (and their respective densities) that are 'processed' in process units. Blend stocks are not taken into account
 - an offsite energy factor: this factor accounts for the energy consumed in utility distribution systems and operation of product blending, tank farms (tank heating, heating of rundown lines, terminalling facilities) and environmental facilities. The basis for the calculation is the raw material input to process units as well as to blending operations and a complexity factor of the refinery.

The EII is dimensionless and, in contrast to the definition of EEI presented in Section 1.3, decreases with increasing energy performance.

The EII attempts to benchmark the energy efficiencies of refineries having different complexities and different units. Still this tool is considered by the refining industry as an imperfect tool for comparison purposes at best. Some refineries that have a poor EII have few opportunities for improving energy performance, whereas others with a good EII sometimes still have a large potential for improvement. Moreover, the EII does not give a good insight to the areas/units that need improvement. The detailed breakdown of the site into main production units can be of more help in this respect to identify opportunities for improving energy performance [227, TWG].

7.9.2 Austrian Energy Agency

The Austrian Energy Agency's (AEA) report 'Energy benchmarking at the company level, company report diary' gives benchmarking factors other than for specific energy consumption. For example, scores for using certain energy saving technologies (see Chapter 3):

- frequency of boiler checks (100 % of the plants reported frequent boiler checks)
- frequency of compressed air line checks (25 % of the plants systematically removed dead legs from systems when the process is changed and 50 % of them occasionally check dead legs)
- using energy saving technologies (variable speed drives, energy efficient motors (EEMs), heat recovery, heat pumps and energy efficient lighting, boiler maintenance and compressed air).

However, this may drive a bottom-up approach (i.e. changing specific components) rather than assessing whole systems.

7.9.3 Scheme for SMEs in Norway

Norway has a web-based benchmarking scheme for SMEs. Benchmarking is based on comparing the specific consumptions (e.g. kWh/kg) of the companies. Specific consumptions are calculated according to the total energy used and the total production of the site. To date, 43 different benchmarking groups have been established among the 800 participating companies. Because on factory usually produces different products with different energy intensities, correction factors are used to normalise these differences.

7.9.4 Benchmarking covenants in the Netherlands

In the Netherlands, long-term agreements (covenants) between the government and large companies (consuming over 0.5 PJ energy per year) are based on benchmarking. The covenants provide a framework for CO₂ emissions reduction.

A key example is the Dutch paper and board industry, with 26 manufacturing plants, and which is a substantial energy consumer in the Netherlands. Participating companies commit themselves to take energy reduction measures to bring their installations within the world top installations in their lines of industry. The world top in this context means the top 10 % of energy efficient installations. The national industry association played a vital role in the management of the benchmarking process and commissioned two consultants, one accounting and one engineering with experience of the industry.

The covenant prescribes that energy efficiency is calculated using the lower heating value of primary fuels used for all purposes at a location (e.g. steam and power generation, direct heating, combustion engines). Electricity drawn from, or supplied to, the national grid, is converted at a standard yield of 40 %.

The consultants evaluated energy performance information of paper mills all over the world, available in the public area as well as from their own databases. Since Dutch mills only operate the downstream end of the papermaking process (without pulp manufacture) the evaluation was confined to units of operation in that part of the process. The following generic units were benchmarked:

- stock preparation
- paper machine
- final processing (winding, cutting, packing, etc.)
- energy conversion
- general utilities and auxiliaries.

Performance information from different units was made comparable by the introduction of correction factors. These were, for instance, used for aspects like raw material composition, deinking, sizing, waste water treatment facilities and power configuration.

Best ENE practices used by the world's top 10 % were identified for six sub segments of the industry, depending on the end-product:

- newsprint
- printing and writing
- tissue
- container board
- carton board and folding boxboard
- small speciality paper mills.

(A similar scheme operates in Flanders Province, Belgium) [227, TWG].

7.9.5 Glass industry benchmarking

The glass industry is investigating several methods to identify the most energy efficient glass-melting operations:

- best practice methods and application of energy balances
- determination of the theoretical energy or enthalpy demand and the practically lowest level of energy consumption
- benchmarking of specific consumption of industrial glass furnaces
- development of new melting and fining techniques.

Since 1999, data on about 250 glass furnaces have been collected for the purpose of benchmarking for the different glass industry sectors. Unfortunately, it was not possible to obtain complete and reliable data worldwide; however, data have been obtained from Europe, Japan, the US, Canada and Turkey.

Different ranking methods could be used:

- from lowest specific energy consumption to the highest and defining the world's top 10 % of furnaces
- best in region, using the average of furnaces in a region as the benchmark
- the lowest achievable energy consumption of a glass furnace applying all best available techniques (from literature, suppliers and the GLS BREF).

A theoretical energy demand has been calculated and thermodynamic models are available. At a temperature of 1400 °C, a typical soda-lime-silica batch demand is about 0.52 MJ/kg of glass for the chemical reactions and 1.75 MJ/kg for heating the glass melt.

Parameters determining energy efficiency were found to be:

- cullet (waste glass) fractions in the batch
- raw material selection
- age and type of furnace
- specific pull and total pull rate

- furnace age
- electric boosting
- batch preheating
- other factors such as:
 - furnace design and insulation
 - excess air balance
 - type of burner and fuel.

The data were normalised to primary energy to take account of the electricity used and the oxygen generation for the oxy-furnaces, and for the cullet level in feed. Other parameters could arguably be normalised, e.g. the furnace could be normalised to 0 years (i.e. new), but this would then not take account of cold repairs during the campaign to improve energy efficiency.

As a result, the 10 % level was identified at 4285 MJ/t of molten glass, with a difference between the most energy efficient furnace and the middle ranking furnace (50 % ile) was 25 %. The best practice for container and float glass was identified.

7.9.6 Allocation of energy/CO₂ emissions between different products in a complex process with successive steps

USIPA, the French starch producers association, with the help of PriceHousewaterCoopers, has developed a methodology of assessment/allocations of the energy in the starch and derivatives production process. This methodology has been used:

- to allocate energy uses at different processing step and to different kinds of products
- to allocate CO₂ emissions at the different processing step and to different kinds of products
- to realise improvements in energy use.

It can therefore be used as a benchmarking tool.

The starch industry is characterised by a wide range of products which are produced from a few raw materials, with several successive process steps. The product from a step can be, either sold to customers for specific uses or further processed in the starch plant to obtain other products.

These production steps are well identified in specific process work areas and/or specific equipment; they are either continuous or batch process.

Raw material → starch → sugar → products → polyols

To simplify the approach, the products have been sorted in homogenous families (dried starches - natural or modified), liquid sugars, dried sugars, liquid dextrose, dried dextrose, liquid polyols, dried polyols, fermentation products.

Energy uses (which may be equated to emissions of CO₂), are allocated to the different processing steps, and thus to quantities of sold products. Specific coefficients can be calculated in relation to sold products. Because the water content may vary from one step to the other in the process, all calculations are made in reference to products at 100 % dry solids.

For example, for CO₂ emissions, the specific CO₂ emission is allocated to each processing step, in relation with the steam quantities used in the process step (through CO₂ emissions related to steam production on site) and with combustibles used in dryers in this process step. Specific emissions of CO₂ can then be allocated to a product, by the addition of the specific CO₂ emissions in each of the successive production steps.

The methodology has no benefits in itself, but is a tool in understanding:

- the contribution of each production step to energy use/intensity, and/or CO₂ emissions
- the contribution of different product families to the energy consumption pattern of a plant.

Implementation of the techniques requires desk work and access to operating information (volume produced, energy uses, etc.) at workshop levels, for each of the different processing steps.

Examples:

CO₂ emissions for French starch plants – product specific emission factors.

This methodology has also been used in a French starch company for setting up a voluntary commitment for limitation of GHG emissions (AERES).

Reference information

USIPA – PWC reports [227, TWG]

7.10 Chapter 3 examples

7.10.1 Steam

Example 1– Insulating valves

Insulating a single 100 mm valve controlling steam at 800 kPa (8 bar) (175 °C) located indoors would reduce heat losses by 0.6 kW. This would reduce boiler fuel costs by EUR 40/year and give an energy saving of 5 MWh/year.

For Johnson Matthey Catalysts in Teesside, UK, the fitting of insulation jackets to valves and flanges have resulted in:

- annual energy savings of 590 MWh
- carbon savings of 29 tonnes/year
- payback period of 1.6 years.

Example 2 – Preheating feed-water including using economisers (see Section 3.2.5)

An economiser might be used for a gas-fired boiler with a production capacity of 5 t/h steam at 20 barg.

The boiler produces steam with an output of 80 % and during 6500 hours per year. The gas will be purchased at a cost of EUR 5/GJ.

The economiser will be used to preheat the fresh boiler water before it flows to the degasser. Half of the condensate will be recovered, the other half will be supplemented with fresh water. This means the economiser can provide an improvement of 4.5 %.

The current use of the boiler is:

- $\frac{6500 \text{ h/yr} \times (2798.2 - 251.2) \text{ kJ/kg} \times 5 \text{ t/h} \times 5/\text{GJ}}{0.80 \times 1000} = \text{EUR } 517\,359/\text{yr}$

The annual operational cost is reduced with the installation of the economiser to:

- $\frac{6500 \text{ h/yr} \times (2798.2 - 251.2) \text{ kJ/kg} \times 5 \text{ t/h} \times 5/\text{GJ}}{0.845 \times 1000} = \text{EUR } 489\,808/\text{yr}$

- the savings thus amount to EUR 27 551/yr.

Example 3 – Installing an economiser (see Section 3.2.5)

A boiler generates 20 400 kg/h of 1 barg steam by burning natural gas. Condensate is returned to the boiler and mixed with makeup water to yield 47 °C feed-water. The stack temperature is measured at 260 °C. The boiler operates 8400 h/ year at a n energy cost of USD 4.27/GJ. By installing an economiser, the energy savings can be calculated as follows:

enthalpy values:

- for 1 barg saturated steam = 2780 kJ/kg
- for 47 °C feed-water = 198 kJ/kg.

Boiler thermal output = 20 400 kg/h x (2781 – 198) kJ/kg = 52.693 million kJ/h =14 640 kW.

The recoverable heat corresponding to a stack temperature of 260 °C and a natural gas-fired boiler load of 14 640 kW is read from Table 3.7, Section 3.2.5 as~1350 kW.

Annual savings = 1350 kJ/s x USD 4.27/10⁶ kJ x 8400 h/year x 3600 s/h = USD 174 318/year = EUR 197 800/year (USD 1 = EUR 1.1347, conversion date 1 January 2002).

Prevention and removal of scale deposits on heat transfer surfaces (see Section 3.2.6)

Example 1

A steam boiler uses 304 000 Nm³ natural gas yearly and has an average annual use of 8000 hours. If a scale of 0.3 mm thick is allowed to form on the heat changing surface, then the heat transfer will be reduced by 2.9 %.

The increase in operating costs per year compared to the initial situation is:

304 000 Nm³/year x 2.9 % x EUR 0.15/Nm³ = EUR 1322 per year.

Example 2

A boiler uses 474 800 GJ of fuel while operating for 8000 hours yearly at its rated capacity of 20 400 kg/h of 1 barg steam. If a scale of ~0.8 mm thick is allowed to form on the boiler tubes, and the scale is of "normal" composition, a fuel loss of 2 % will occur The increase in operating costs, assuming energy is priced at USD 2.844/GJ, is:

annual operating cost increase = 474 800 GJ x USD 2.844/GJ x 0.02 = USD 27 000 = EUR 30 637 (USD 1 = EUR 1.1347, conversion date 1 January 2002).

Minimising blowdown (see Section 3.2.7)

Example 1

An automated blowdown control system is installed on a flame pipe boiler, which generates steam at 25 bar for 5500 hours a year. The blowdown system will reduce the blowdown rate from 8 to 6 %. The boiler provides 25 tonnes of steam per hour and its boiler efficiency amounts to 82 %. The gas price is EUR 5/GJ.

The make-up water is supplied at 20 °C, and costs EUR 1.3 per tonne (including purification). The price for discharging waste water is EUR 0.1 per tonne.

Assuming that the condensate does not return, the blowdown only needs to be determined based on the flow of fresh water as return condensate does not contain any salts. The conductivity of fresh water is 222 $\mu\text{S/cm}$. This is an indication of the amount of dissolved salts in the water. Make-up water may have a maximum conductivity of 3000 – 4000 $\mu\text{S/cm}$.

The blowdown rate (B) is thus calculated as follows:

- quantity of salts in = quantity of salts out
- $(25\,000 + B) \times 222 = B \times 3000$

So the blowdown rate is: 1998 l/hr or 8 %.

The initial quantity of fresh make-up water is:

- $25\,000 \text{ kg/h} \times (1 + 0.08) = 28000 \text{ l/h}$.

After installation of the blowdown control system this becomes:

- $25\,000 \text{ kg/h} \times (1 + 0.06) = 26\,500 \text{ l/h}$, the difference is 500 l/h.
- the enthalpy of make-up water at 25 barg is: 972.1 kJ/kg
- the enthalpy of feed-water at 20°C at atmospheric pressure is: 83.9 kJ/kg
- the difference thus is 888.2 kJ/kg.

Savings on fuel costs thus amount to:

- $500 \text{ l/h} \times 5500 \text{ h} \times 888.2 \text{ kJ/kg} \times \text{EUR } 5/\text{GJ}/0.82/1\,000\,000 = \text{EUR } 14\,894/\text{yr}$

Savings were also made on purification and blowdown costs.

The quantity of water saved amounts to: $500 \text{ l/h} \times 5500 \text{ h/yr} = 2750 \text{ t/yr}$.

This represents an avoided cost of EUR 3850/yr.

The installation thus generates annual profits of EUR 18 744
[227, TWG]

Example 2

Assume that the installation of an automatic blowdown control system reduces your blowdown rate from 8 to 6 %. This example assumes a continuously operating natural gas fire, 1 barg, 45 350 kg/h steam boiler. Assume a makeup water temperature of 16 °C, boiler efficiency of 82 %, with fuel valued at USD 2.844/GJ, and the total water, sewage and treatment costs USD 0.001057 per kg. The total annual cost savings are:

- boiler feed-water:
 - Initial = $45\,350/(1-0.08) = 49\,295 \text{ kg/h}$
 - Final = $45\,350/(1-0.06) = 48\,246 \text{ kg/h}$
- makeup Water Savings = $49\,295 - 48\,244 = 1049 \text{ kg/h}$
- enthalpy of boiler water = 787.4 kJ/kg; for make-up water at 16 °C = 65.1 kJ/kg
- thermal Energy savings = $787.4 - 65.1 = 722.3 \text{ kJ/kg}$

annual fuel savings = $1049 \text{ kg/h} \times 8760 \text{ h/year} \times 722.3 \text{ kJ/kg} \times 2.844 \text{ GJ}/0.82 \times 10^{-6} = \text{USD } 23\,064$

annual water and chemical savings = $1049 \text{ kg/h} \times 8760 \text{ h/year} \times \text{USD } 0.001056/\text{kg} = \text{USD } 9714$

total savings = $\text{USD } 23\,064 + \text{USD } 9714 = \text{USD } 32\,778 = \text{EUR } 37\,192.11$ (USD 1 = EUR 1.1347, conversion date 1 January 2002).

Recovering heat from the boiler blowdown (see Section 3.2.15)**Example 1**

A heat exchanger is installed between the blowdown pipe of a boiler and the supply of fresh make-up water. The boiler works for 7600 hrs at a pressure of 10 barg yearly and has an efficiency of 82 %. The boiler has a blowdown rate of 6 % and is natural gas fired at a cost of EUR 4/GJ. The supply of fresh make-up water is at 5.3 t/h.

For every 10 t/h steam at a 6 % blowdown rate, an efficiency profit of 368 MJ/h is achieved (see Table 3.17 in Section 3.2.15). To reach this profit value, a supply of fresh make-up water of 5.3 t/h is needed. This leads to efficiency profits of $5.3/10 \times 368 = 195$ MJ/h.

This leads to the following savings:

$$\frac{7600 \text{ h} \times 195 \text{ MJ/h} \times \text{EUR } 4/\text{GJ}}{1000 \times 0.82} = \text{EUR } 7229/\text{yr}$$

Insulation on steam pipes and condensate return pipes (see Section 3.2.11)**Example**

In a plant where the value of steam is USD 4.265/GJ, a survey of the steam system identified 30 m of bare 25 mm diameter steam line and 53 m of bare 50-mm line both operating at 10 bar. An additional 76 m of bare 100-mm diameter line operating at 10 bar was found. From Table 3.10 in Section 3.2.11, the quantity of heat lost per year is:

- 25 mm line: $342 \text{ m} \times 301 \text{ GJ/yr per } 30 \text{ m} = 102\,942 \text{ GJ/yr}$
- 50-mm line: $53 \text{ m} \times 506 \text{ GJ/yr per } 30 \text{ m} = 26\,818 \text{ GJ/yr}$
- 100-mm line: $76 \text{ m} \times 438 \text{ GJ/yr per } 30 \text{ m} = 33\,288 \text{ GJ/yr}$
- total heat loss = $(28\,547 + 7\,452 + 9\,234)/30 \text{ m} = 163\,048 \text{ GJ/yr}/30 \text{ m} = 5435$

The annual operating cost savings from installing 90 % efficient insulation is:

$$\text{USD } 0.90 \times 4.265/\text{GJ} \times 5435 \text{ GJ/yr.} = \text{USD } 20\,860 = \text{EUR } 23\,670$$

(USD 1 = EUR 1.1347, conversion date 1 January 2002).

Installation of removable insulating pads on valves and fittings (see Section 3.2.11.1)

Using Table 3.11 in Section 3.2.11.1, the annual fuel and cost savings from installing a 25 mm thick insulating pad on an uninsulated 150 mm gate valve in a 17.24 barg saturated steam line (208 °C) can be calculated. Assume continuous operation with natural gas at a boiler efficiency of 80 % and a fuel price of USD 4.265/GJ:

$$\text{annual fuel savings} = 1751 \text{ W} \times 8760 \text{ h/year} \times 1/0.80 \times 3600 \text{ s/h} = 69.024 \text{ GJ/year}$$

$$\text{annual cost savings} = 69.024 \text{ GJ/year} \times \text{USD } 4.265/\text{GJ} = \text{USD } 295 \text{ per } 150 \text{ mm gate valve} = 334.73 \text{ EUR (USD } 1 = 1.1347 \text{ EUR, conversion date 1 January 2002).}$$

Implementing a control and repair programme for steam traps (see Section 3.2.12)

Example 1

The amount of steam lost can be estimated for a steam trap as follows:

$$L_{t,y} = \frac{1}{150} \times FT_{t,y} \times FS_{t,y} \times CV_{t,y} \times h_{t,y} \times \sqrt{P_{in,t}^2 - P_{out,t}^2} \quad \text{Equation 7.25}$$

Where:

- $L_{t,y}$ = the amount of steam that steam trap t is losing in period yr (tonne)
- $FT_{t,y}$ = the operating factor of steam trap t during period yr
- $FS_{t,y}$ = the load factor of steam trap t during period yr
- $CV_{t,y}$ = the flow coefficient of steam trap t during period yr
- $h_{t,y}$ = the amount of operating hours of steam trap t during period yr
- $P_{in,t}$ = the ingoing pressure of steam trap t (atm)
- $P_{out,t}$ = the outgoing pressure of steam trap t (atm).

The operating factor $FT_{t,yr}$ follows from Table 7.11.

	Type	FT
BT	Blow through	1
LK	Leaks 0.	25
RC	Rapid cycle	0.20

Table 7.11: Operating factors for steam losses in steam traps

The load factor takes into account the interaction between steam and condensate. The more condensate that flows through the steam trap, the less space there is to let through steam. The amount of condensate depends on the application as shown in Table 7.12 below:

Application	Load factor
Standard process application	0.9
Drip and tracer steam traps	1.4
Steam flow (no condensate)	2.1

Table 7.12: Load factor for steam losses

Finally the size of the pipe also determines the flow coefficient:

$$CV = 3.43 D^2$$

where D = the radius of the opening (cm).

An example calculation is:

- $FT_{t,yr} = 0.25$
- $FS_{t,yr} = 0.9$ because the amount of steam that passed through the trap is condensed, but correct in comparison with the capacity of the steam trap
- $CV_{t,yr} = 7.72$
- $D = 1.5$ cm
- $h_{t,y} = 6000$ hours per year
- $P_{in,t} = 16$ atm
- $P_{out,t} = 1$ atm.

The steam trap thus loses up to 1110 tonnes of steam per year.

If this occurs in a company where steam costs EUR 15/tonne, then the final loss would amount to: EUR 16 650 per year.

If steam is escaping fully rather than leaking, costs might rise to up to EUR 66 570 per year.

These losses rapidly justify the setting up of an effective management and control system for all the steam traps in a company.

Example 2:

In a plant, the value of steam is USD 9.92/1000 kg. A trap on a 10 barg steam line is stuck open. The trap orifice is 3 mm in diameter. Table 3.12 in Section 3.2.12 shows the estimated steam loss as 34.4 kg/h. By repairing the failed trap, annual savings are:

savings = 34.4 kg/h x 8760 h/year x USD 9.92/1000 kg = USD 2988/year = EUR 3390.45 (USD 1 = EUR 1.1347, conversion rate 1 January 2002).

Re-use of flash steam (see Section 3.2.14)

Example 1:

A vent pipe has the following properties:

- velocity of flash steam: 1.5 m/s
- diameter of vent pipe: 102 mm
- hours of operation: 8000 h/year
- boiler efficiency: 82 %
- cost of fuel: USD 4.265/GJ

A vent condenser could condense the flashed steam, transfer its thermal energy to incoming make-up water, and then return it to the boiler. Energy is recovered in two forms: hotter make-up water and clean, distilled condensate ready for use in the operation.

Energy recovery potential of a vent condenser					
Pipe diameter (mm)	Energy content, GJ/year*				
	Steam velocity, m/s				
	1	1.5	2	2.5	3
50 95		148	195	243	295
102 390		586	781	976	1171
152 881		1319	1757	2200	2638
254 2442		3661	4885	6198	7327

*Assuming continuous operation, 21 °C make-up water, and condensed steam at 38 °C

Table 7.13: Energy recovery potential of a vent condenser for several steam velocities and pipe diameters

Adapted from [123, US_DOE]

Referring to Table 7.15, the potential energy recovered from the flashed steam is 586 GJ, based on 8670 hours of annual operation. The annual potential fuel cost savings are:

- annual energy recovered = 586 GJ/year x 8000 h/year/8760 h/year x 1/0.82 = 652 GJ
- annual potential fuel cost savings = 652 GJ x USD 4.265/GJ = USD 2781 = EUR 3155.57 (USD 1 = EUR 1.1347, conversion date 1 January 2002).

**Note that the annual fuel savings are per vent. Often, there are several such vents in a steam facility, and the total savings can be a significantly larger number. The additional heat exchanger cost still needs to be considered, but available literature shows a quick payback for the measure.

In Table 7.14, the quantity of steam obtained per pound of condensate flashed is given as a function of both condensate and steam pressures.

High-pressure condensate flashing				
High pressure condensate (barg)	Per cent of condensate flashed (kg steam/kg condensate)			
	Low pressure steam (barg)			
	3.4	2	1	0.34
15	10.4	12.	8	15.2
10	7.	8	10.3	12.7
7	4.6	7.	1	9.6
5	2.5	5.	1	7.6
				9

Table 7.14: Percentage of steam obtained per mass of condensate as a function of both condensate and steam pressures

Adapted from [123, US_DOE]

Example 2:

In a plant where the cost of steam is USD 4.265/GJ, saturated steam at 10 barg is generated, and a portion of it is throttled to supply 2 barg steam. Assuming continuous operation, determine the annual savings of producing low pressure steam by flashing 2268 kg/h of 10 barg condensate. The average temperature of the boiler make-up water is 21 °C.

From the table above, when 10 barg condensate is flashed at 2 barg, 10.3 % of the condensate vaporises.

$$\text{Low pressure steam produced} = 2268 \text{ kg/h} \times 0.103 = 233.6 \text{ kg/h}$$

From the ASME Steam Tables, the enthalpy values are:

- for 2 barg saturated steam = 2725.8 kJ/kg
- for 21 °C make up water = 88.4 kJ/kg

annual savings are obtained as follows:

- annual savings = 233.6 kg/h x (2725.8– 88.4) kJ/kg x 8760 h/year x USD 4.265/GJ = USD 23 019 = EUR 26 119.37

(USD 1 = EUR 1.1347, conversion date 1 January 2002).

Minimising boiler short cycling losses (see Section 3.2.9)

Example 1:

A 745.7 W boiler with a cycle efficiency of 72.7 % (E_1) is replaced with a 447.4 W boiler with a cycle efficiency of 78.8 % (E_2). The annual cost savings can be calculated as follows:

- fractional fuel savings = $(1 - E_1/E_2) = 1 - 72.7/78.8 \times 100 = 7.7 \%$

If the original boiler used 211 000 GJ of fuel yearly, the savings from switching to the smaller boiler (given a fuel cost of USD 2.844/GJ) are:

- annual savings = 211 000 GJ x 0.077 x USD 2.844/GJ = USD 46 200 = EUR 52 422.56 (USD 1 = EUR 1.1347, conversion date 1 January 2002).

7.10.2 Waste heat recovery

Acid cleaning of heat exchangers

The plants adopting the known Bayer process to extract alumina from the raw material bauxite, named also alumina refineries, operate the caustic leaching of the ore at high temperatures, which can be as high as 250 °C, like in the reference Italian alumina refinery (which will be described in this section) and in many others, or as low as 140 °C, like in some western Australian plants, depending on the bauxite type.

The reaction or digestion-phase is followed by a depressurising phase in which, in a number of progressive flashing stages, the temperature and the pressure of the liquor decrease until atmospheric conditions are reached.

The flashed steam delivered in this phase is recovered by condensing it, shell side, into a series of shell and tube condensers where tube-side flows the caustic liquor returning to the reaction phase. The recovery efficiency of the flashed steam covers a very important role in the energy efficiency of the entire process, as the higher the recovery is, the lower the request of fresh steam to the digesters, and consequently the lower the fuel oil consumption of the process.

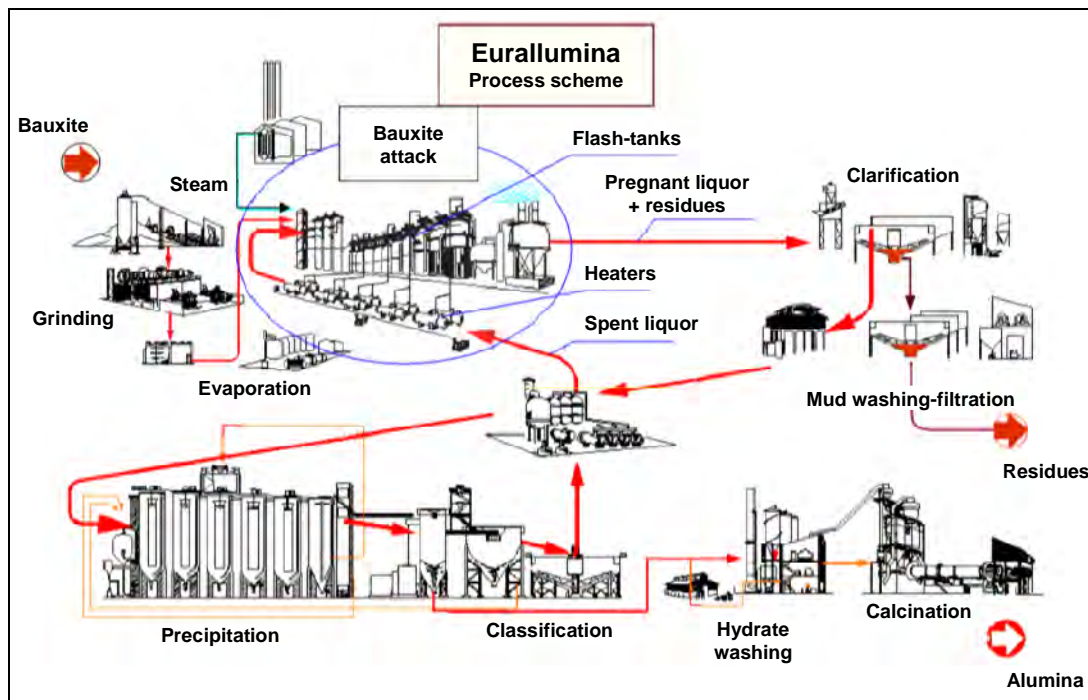

Figure 7.14: Process scheme of Eurallumina alumina refinery [48, Teodosi, 2005]

Description (of the energy efficiency technique)

The shell and tube heaters are subject to an acid cleaning routine, to renew the internal surface of the tubes and restore the heat transfer efficiency. The tubes are in fact subject to silica scaling precipitating from the process liquor, especially occurring at higher temperatures.

Notwithstanding a desilication treatment normally adopted by refineries, the silica level in the Bayer liquor is such that the scaling rate can seriously impact the recovery of the flashed steam and the energy efficiency.

The frequency optimisation of the acid cleaning routine is the way to improve the average heat transfer coefficient of the heaters and consequently reduce the fuel oil consumption of the process.

Achieved environmental benefits (especially including improvements in energy efficiency)

The operating cycles of the heaters have been reduced from 15 to 10 days, and consequently the frequency of the tube acid cleaning routine has increased. This operating change has permitted the average heat transfer coefficient to increase, and the recovery of the flashed steam to improve. See Figure 7.15.

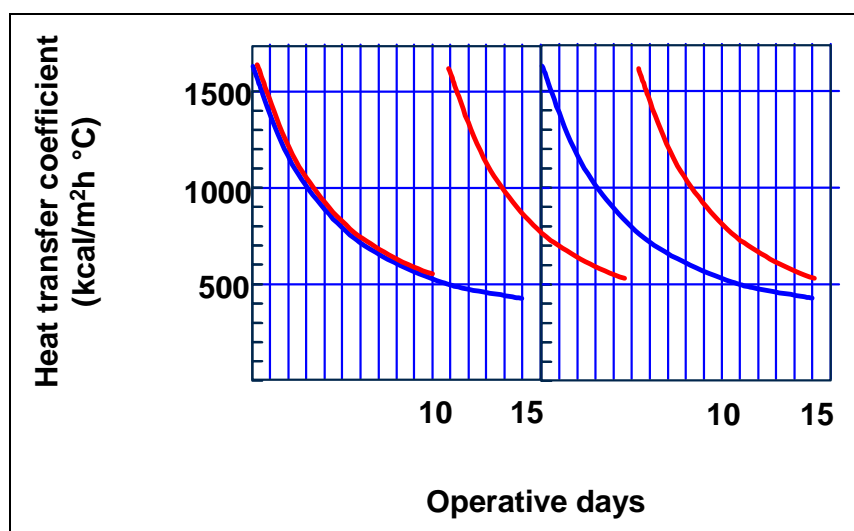

Figure 7.15: Operative cycle of heaters
[48, Teodosi, 2005]

Cross-media effects

The only side-effect caused by the implementation of this technique can be represented by the additional quantity of exhausted acid relevant to the increased frequency of acid cleaning, to be finally disposed of. In the case of the alumina refinery, however, this does not create any environmental problems, as the exhausted acid resulting from the operation is disposed of together with the process residues, or the exhausted bauxite, which are alkaline. The mix of the two residues offers in fact the opportunity for an neutralisation of the process wastes (the so called red mud), before their disposal to the mud basin.

Operational data

The performance data are those regarding the energy and oil consumptions which have already been mentioned. As far as emissions are concerned, the oil saved at the boilers turns out into a corresponding reduction of emissions from the boilers stack, evaluated around 10 000 tonnes CO₂/yr, and also 150 tonnes SO₂/yr before the adoption of the desulphurisation process, which took place in the refinery in 2000.

The technique of the tube acid cleaning must be supported by the preparation of the acid solution at the recommended concentration and with the addition of an appropriate corrosion inhibitor to protect the metal surface. A useful technique to improve the protection against the acid attack of the metal, during the acid circulation inside the tubes, is to circulate some cold water shell side, in order to avoid an uncontrolled temperature increase somewhere in the tubes.

Applicability

The high temperature heaters in the reference refinery have been equipped with stainless steel tubes, in order to eliminate the phenomenon of tube leaks occurring. This choice was decided due to the importance covered for the process continuity by the production of good condensate, utilised as boiler feed-water. This factor also contributes in having long lasting heaters (for over 12 years) in spite of the frequent acid cleaning routine.

Economics

The costs associated with the new procedure can be given by minor investment necessary for some facilities required by the increased cleaning frequency, as well as by the company to do the operation. The process savings are those reported in terms of oil saving and emissions reduction.

The improvement achieved in the energy efficiency of the system can be estimated in a reduction of the fuel oil consumption by a round 3 kg/tonne alumina, which corresponds to 1.6 % of the process oil consumption. Given the production rate of the refinery which is around 1 Mtonne alumina/yr, the saving equates to 3000 tonnes of fuel oil per year.

Driving force for implementation

Economic reasons.

Examples

Eurallumina, Portovecompany, Italy.

Reference information

[48, Teodosi, 2005]

Surplus heat recovery at a board mill

Description (of the energy efficiency technique)

Co-operation between municipalities and industry is seen as an important way to increase energy efficiency. One good example of such co-operation is the one in Lindsberg, Sweden, a small municipality with about 23 000 inhabitants. AssiDomän Cartonboard in Frövi, Sweden has delivered surplus heat to the district heating network since 1998. This network is operated by Linde Energi AB (the municipality's energy company). The deliveries cover over 90 % of the demand in the district heating system. The heat is distributed through a 17 km long transit pipe, with a forward and return pipe to Lindsberg.

The board mill strives to reduce its environmental pollution and as a result the water consumption has decreased considerably in the last few decades. This has given the mill the possibility to produce a hot water surplus with a temperature of approx. 75 °C. The hot water temperature is raised further in a flue-gas cooler before delivering heat to the district heating network, see Figure 7.16.

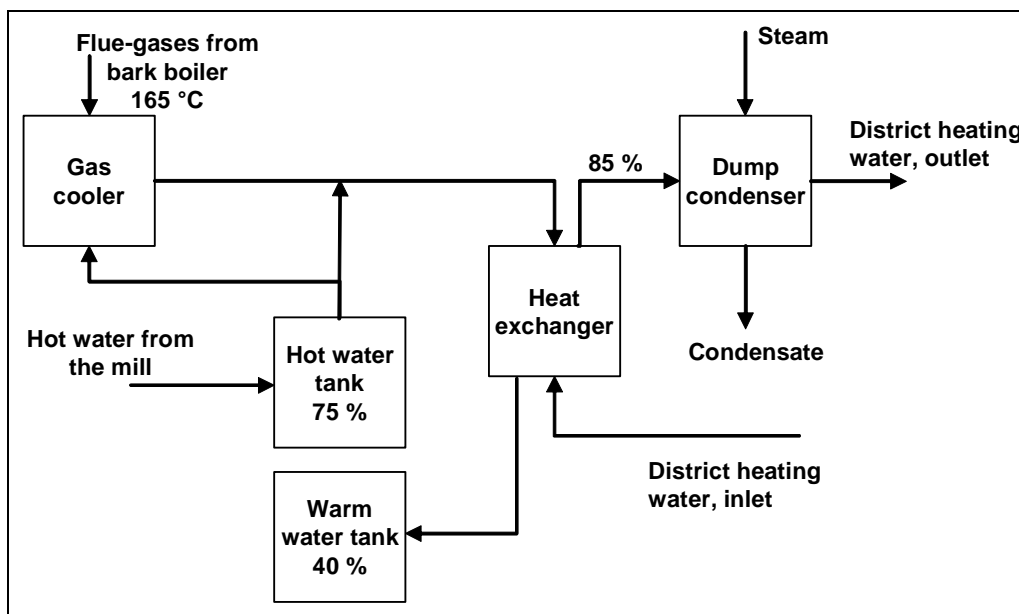

Figure 7.16: Heat recovery system connected to the district heating system [20, Åsbländ, 2005]

With this arrangement of the heat recovery system, the excess heat from the mill, which has been collected by the secondary heat system, is utilised. Furthermore, the heat in the exhaust gases which would otherwise be discharged to the environment is utilised. The use of these heat sources does not normally increase the mill's fuel consumption. However, at peak loads a dump steam condenser is used in series, and this steam usage results in increased fuel consumption in the mill (mainly bio-fuels).

Achieved environmental benefits (especially including improvements in energy efficiency)

Before the board mill was connected to the district heating system, 65 % of the heat demand was supplied fossil fuels (fuel oil and LPG) while the remainder was supplied by an electricity driven groundwater heat pump (35 %). Today, the heat deliveries from the board mill cover more than 90 % of the district heating demand. The oil boilers at Linde Energi AB are used only during the coldest weather periods, i.e. about 2 weeks per year, and the heat pump is decommissioned.

Compared to the situation before AssiDomän was connected to the district heating system, the usage of fossil fuels has decreased by 4200 tonnes LPG and 200 m³ fuel oil per year. Further, the electricity consumption has decreased by 11 000 MWh/year since the groundwater heat pump was taken out of service.

Cross-media effects

Besides the obvious benefits of less usage of fossil fuels and electricity, decommissioning of the heat pump has decreased the release of ozone depleting substances to the air.

Operational data

No data submitted.

Applicability

This type of co-operation is not limited to industry and municipalities. In an industrial park, this type of co-operation could be very fruitful. In fact it is one of the ideas behind the concept of eco-industrial parks.

Economics

The total investment cost amounted to EUR 15 million. Linde Energi AB received a grant from the Swedish government of EUR 2.3 million (15 % of total investment).

Driving force for implementation

The driving force was both economical and environmental concerns from both the company and the municipality. The timing was also right since the heat surplus in the mill was becoming a problem (risk of thermal pollution) and the heat pump in the district heating system needed an overhaul due to the mandatory out phasing of CFC-working fluids.

Examples

- Södra Cell Värö, Varberg
- Shell refinery, Göteborg
- Swedish Steel, Borlänge
- SCA, Sundsvall.

Reference information:

[20, Åsblad, 2005]

7.10.3 Cogeneration

Internal combustion engines (reciprocating engines) example: Bindewald Kupfermühle

- flour mill: 100 000 t wheat and rye/yr
- malthouse: 35 000 t malt/yr

This is a CHP plant with a stationary reciprocating engine (fuel savings 12.5 Mio. kWh compared to separated production with 12 Mio. kWh_{el} and about 26 Mio. kWh_{th})

Technical data:

- fuel power: 2* 2143 k_{fuel} (natural gas)
- electric power: 2*700 kW_{el}
- thermal power: 2* 1.200 kW_{th}
- power generation: about 10.2 Mio. kWh_{el}/yr
- heat production: about 17.5 Mio. kWh_{th}/yr
- full load hours: 7286 h/yr
- power to heat ratio: 0.58.

Operating data:

- start of operation: December 1991
- degrees of efficiency:
 - electric efficiency: 33 %
 - thermal efficiency: 56 %
 - fuel efficiency: 89 %
- amount of maintenance:
 - every thousand hours short maintenance
 - every 10 000 hours in depth maintenance
 - availability: about 90 %
- cost effectiveness:
 - capital expenditures: EUR 1.2 million (including peripheral equipment)
 - payback period:
 - static: 5 years
 - dynamic: 7 years
- benefit for the environment:
 - fuel saving: 12 000 MWh_{fuel}/year
 - CO₂ saving: 2 500 t/year.

Reference information

[64, Linde, 2005]

7.10.4 Trigeration**Example: Barajas Airport, Madrid, Spain**

Barajas Airport buildings need of both heating and cooling is huge, the new airport terminal has a floor area of 760 000 m² (76 hectares). Applying the trigeneration concept, the engines are generating electricity as a base load plant at top overall efficiency, instead of flying idle as emergency generators without contributing to the investment payback.

The overriding priority was to develop a cost efficient CHP plant that will be technically advanced, environmentally friendly, and that will guarantee the extremely high level of reliability necessary for this key facility in such an important location.

The solution was six Wärtsilä 18V32DF dual-fuel engines burning natural gas as the main fuel and light fuel oil (LFO) as the back-up fuel. However, the running hours in LFO are limited to a maximum of 200 hours per year, due to local environmental restrictions.

The trigeneration plant generates a net electrical output of 33 MW and is connected to both the airport's internal grid and the public grid. The plant provides electricity on a continuous basis, as well as heating for the new terminals during the winter, and cooling during the summer. Table 7.15 shows technical data for the CHP plant.

Technical parameters	Data	Units
Power at generator terminals	33.0	MW _e
Heat rate in gas mode	8497/42.4 %	kJ/kWh _e
Gross thermal power	24.6	MW _{th}
Total thermal power	30.9	MW _{th}
Heat recovery circuit	Water 120/80	°C
Fuel efficiency of the CHP plant	74 %	
Absorption chiller capacity	18.0	MW _c
Total chiller capacity	37.4	MW _c
Chilled water circuit	6.5/13.5	°C
Normal fuel	Gas	
Back-up fuel	Light fuel oil	
HT back-up cooling	Radiators	
LT and chiller cooling	Cooling tower	

Table 7.15: Technical data for the Barajas Airport's trigeneration plant

Six single-stage absorption chillers are installed in the power plant building. The chilled water is distributed to the consumers out in the new terminal through a separate piping system. The lithium bromide (LiBr) absorption chillers are powered by the 120 °C heat recovery circuit and cooled by the cooling towers.

The Madrid Barajas Airport's CHP plant has an oil-fired boiler for heating back-up/peaking and electrically driven compressors as chilling back-up/peaking.

The plant will sell excess power to the grid and be continuously interconnected to the national grid. The electric distribution system has high redundancy in order to cover all malfunctioning of the plant and still be able to feed the airport. If the gas supply fails, the engines will still be able to take full load running on oil.

Reference information

[64, Linde, 2005]

7.11 Demand management

Description

This usually refers to managing electricity demand. It is important to distinguish the cost saving elements from the energy saving measures.

In most EU (and many other) countries, there is a complex pricing structure for electricity, depending on the peak quantity used, the time at which power is drawn from the grid and other factors, such as the possibility to accept a cap on the quantity supplied. Peak usage in an installation may mean that part of the electricity units used will be charged at a premium rate and/or contract cost penalties may be incurred. Control of this is necessary, and moving or smoothing the peaks will result in cost savings. However, this may not decrease the total energy units used, and there is no increase in physical energy efficiency.

Peaks in demand can be avoided or controlled for example, by:

- converting connections from star to delta for low loadings, using automatic delta to star converters, using soft-starters, etc., for equipment with large power demand, such as large motors,
- using control systems to stagger the start up of equipment, e.g. at the start of shifts (see Section 2.15.2)
- changing the time of day processes causing spikes in electrical usage are used.

Achieved environmental benefits

No data submitted.

Cross-media effects

May not achieve energy savings.

Operational data

Some examples of high instantaneous demands are:

- on start up of equipment with significant power usage, e.g. large motors
- start up of a shift, with several systems starting, e.g. pumps, heating
- processes such as heat treatment, with high energy demands, particularly if not used constantly.

High instantaneous demands can also cause energy losses by distorting the even pattern of the AC cycles of the phases and loss of useful energy. See Harmonics, Section 3.5.2.

Applicability

Consider in all installations.

Control can be manual (e.g. changing the time of day a process is used), simple automatic controls (e.g. timers), or linked to more sophisticated energy and/or process management systems (see Section 2.15.2)

Economics

Unnecessary power consumption and peaks in power result in higher costs.

Driving force for implementation

Cost saving.

Examples

Widely used.

Reference information

<http://members.rediff/seetech/Motors.htm>

[183, Bovankovich, 2007]

<http://www.mrotoday.com/mro/archives/exclusives/EnergyManagement.htm>

7.12 Energy Service Company (ESCO)

Description

Attention in energy policy debates is frequently drawn to the untapped potential for energy savings. The failure to leverage this potential is attributable not so much to economic factors as to structural shortcomings and a lack of information on the part of energy users. Energy performance contracting (EPC) via energy service providers, or energy service companies (ESCOs or ESCos) can assist in leveraging energy savings. However, it should be noted that there are other third party options and incentives.

The ESCo will identify and evaluate energy saving opportunities and then recommend a package of improvements to be paid for through savings. The ESCo will guarantee that savings meet or exceed annual payments to cover all project costs – usually over a mid- to long term contract of, e.g. seven to 10 years. If savings do not materialise, the ESCo pays the difference.

The importance of energy services is underscored by the EU Directive on energy end-use efficiency and energy services of April 5, 2006 (2006/32/EC), which defines energy services as follows:

'Energy service is the physical benefit, utility or good derived from a combination of energy with energy efficient technology and/or with action, which may include the operations, maintenance and control necessary to deliver the service, which is delivered on the basis of a contract and in normal circumstances has proven to lead to verifiable and measurable or estimable energy efficiency improvement and/or primary energy savings'

An energy service provider can supply, for example, the following types of energy, depending upon the application involved:

- thermal energy (building heating, steam, process heat, process water, hot water)
- cooling (coolant water, district cooling)
- electricity (light and power from cogeneration plants or photovoltaic installations)
- air (compressed air, ventilation, air conditioning).

Achieved environmental benefits

Energy savings. The savings to be achieved will be the subject of the EPC.

Cross-media effects

None reported.

Operational data

The ESCO may perform the following tasks (in chronological order):

- identification of energy saving potential
- feasibility study
- determination of objectives and energy savings agreement signature
- preparing the project for implementation
- management of the construction and putting the finished work into operation

- evaluation of the environmental and economical parameters actually achieved.

Applicability

It has been widely used in the US for 10 – 20 years. Increasingly used in the EU.

Economics

The basic contractual clause of the energy performance contract (EPC) concluded between the enterprise and the ESCO consists in the obligation of ESCO to achieve, for the enterprise, both the predefined reduction of environmental load and contracted economical parameters of the project. Such required parameters may be agreed upon on an individual basis and often include the following:

- the guaranteed level of annual savings on energy costs as compared to the existing condition
- guaranteed return on investment resulting from the future savings on energy costs and other financial effects (including the sale of surplus emissions permits, income from the sale of 'white certificates', savings on service and maintenance costs)
- guaranteed level of reduced emissions
- guaranteed reduced level of the consumption of primary fuels
- other guaranteed parameters as agreed upon between the ESCO and the enterprise.

Driving force for implementation

The following drivers can be met by successful energy performance contracting (EPC) through an ESCO:

- provision of the necessary skills to respond to the following drivers (see Section 2.6)
- the method and correct performance of the energy audit
- proposed concept of changes comprising more options and a feasibility study
- selection of the optimum option taking account of the expected future development of the enterprise
- selection of the best performing energy savings technologies and processes
- provision of necessary funds for the installation of energy efficient technologies
- selection of the suppliers of particular components
- correctness of the procedures used for the installation of energy efficient technologies.
- achievement of the planned energy performance and economical efficiency.

Examples

Replacement of a malfunctioning compressor in a compressed air system

Company A uses compressed air to dry semifinished products. However, a malfunctioning compressor is preventing Company A from producing these at full capacity and the company is beginning to fall behind on its orders.

Company A decides to remedy this situation by integrating a compressor into their production line with comparable output that will be rented from a compressor provider or another supplier. After Company A's own compressor is repaired, the rented unit will be returned to its owner.

Table 7.16 shows the advantages and drawbacks of renting equipment, from the standpoint of the energy user.

Factors	Advantages	Level	Disadvantages
Capital expenditure	Low in the short term		High in the long term
Level of expertise required by the organisation			Relatively high
Personnel qualification level required			Relatively high
Maintenance and repair expenditures			Relatively high
Dependence on outside providers	Mo	derate	
Expenditures for co-ordination and communication		Moderate	
Security of energy supply	Relatively high		
Scope of quality warranty	Relatively broad	Customer assumes responsibility for this	
Cost transparency	Relatively high		
Term of contract	Short		
Incentive to save energy			Relatively low

Table 7.16: Advantages and disadvantages of renting CAS equipment

Reference information

[279, Czech_Republic, 2006, 280, UBA_DE, 2006]

<http://www.esprojects.net/en/energyefficiency/financing/esco>

<http://re.jrc.ec.europa.eu/energyefficiency/ESCO/index.htm>

7.12.1 Technical facilities management

When an energy service provider (an ESCO) supplies technical facilities management services, it assumes responsibility for operation, maintenance and operating cost optimisation of a specific facility.

Technical facilities management generally improves the efficiency of the facility under management since, in most cases, a smaller investment in measurement and control technology is involved. The facility remains the customer's property, and the only change is that the technical services are outsourced.

The energy service provider charges either for individual services or is paid a lump sum fee. The customer can also reduce its energy costs by sharing in the energy savings realised by the energy service provider, thus providing an incentive to use energy efficiently and economically.

Technical facilities management is most commonly used when the customer needs trouble-free and totally reliable operational performance and does not have a sufficient number of specialists on his staff.

Table 7.17 shows the advantages and drawbacks of technical facilities management from the standpoint of the energy user:

Factors	Advantages	Level	Disadvantages
Capital expenditure			High
Expertise required by the organisation	Low		
Personnel qualification level required	Low		
Maintenance and repair expenditures	Low		
Dependence on outside providers			High
Expenditures for co-ordination and communication	M	oderate	
Security of energy supply	Relatively broad		
Scope of quality warranty	Relatively broad	Customer assumes responsibility for this	
Cost transparency (applies to capital expenditures only and not to energy and other costs)	high		
Term of contract	Short		
Incentive to save energy			Relatively low

Table 7.17: Advantages and disadvantages of supplying a CAS via an ESCO

Example:

Cogeneration plant financing

Company C (a printing company) has decided to increase its production capacity, which will necessitate realisation of a new cogeneration facility. After Company C settles on a solution, an energy service provider (which is also the facility manufacturer) obtains the financing, and does the planning and building for the facility under a 15 year contract. Financing is provided by the contractual charges that Company C pays to the energy service provider-cum-facility manufacturer.

7.12.2 Final energy supply services (also referred to as installation contracting)

In this case, the energy service provider plans, finances, builds and operates the energy installation under contracts whose terms generally vary from five to 20 years. During this time, the installation remains the property of the energy service provider. The customer enters into an energy services contract with the energy service provider for the purchase of a specific quality of energy at a specific price. Under this contract, the customer has no say in the financing, operation or maintenance of the installation.

The energy service provider's costs are included in the overall price, which comprises a base price (monthly or otherwise) and a variable price depending on consumption, e.g. x number of euros per cubic metre of hot water. This arrangement provides the customer with an incentive to make economical use of the energy services purchased.

If the customer also uses the energy service provider's distribution network, this should be included in the contract, which should also specify the energy transfer point or points. In this case, the energy service provider assumes direct responsibility for providing heated space and can thus cut down on end-use energy by trying to find the most efficient ways to supply final energy.

This energy services model is well suited for new buildings when energy services are to be outsourced; or for buildings whose energy systems need a top to bottom modernisation that involves the replacement of old equipment, e.g. supplying heat from modernised boiler systems. Final energy is supplied in a approximately 90 per cent of all energy services contracting scenarios.

Table 7.18 shows the advantages and drawbacks of final energy supply from the standpoint of the energy user.

Factor	Advantages	Level	Disadvantages
Capital expenditure	Low		
Expertise required by the company	Low		
Personnel qualification level required	Low		
Maintenance and repair expenditures	Low		
Dependence on outside providers		High	
Expenditures for co-ordination and communication		Moderate	
Security of energy supply	High		
Scope of quality warranty	High		
Cost transparency	Relatively broad		
Term of contract			High
Incentive to save energy	High		

Table 7.18: Advantages and disadvantages of energy via an ESCO

7.13 European Commission website and Member State National Energy Efficiency Actions Plans (NEEAPs)

The European Commission has a website dedicated to energy efficiency at:

http://ec.europa.eu/energy/demand/legislation/end_use_en.htm

As any list of policies, actions, tools and policy support measures will rapidly become out of date, this web page provides a useful source and has sections and links on the following issues:

Legislation:

- End-use Efficiency & Energy Services
- Energy Efficiency in Buildings
- Eco-design of Energy-Using Products
- Energy Labelling of Domestic Appliances
- Energy Star Programme
- Combined Heat and Power (Cogeneration) (with MS Reports)
- Under discussion

National Energy Efficiency Action Plans (NEEAP)

A table gives access to PDF files of all the ENE plans and/or related communications for the MSs, in the MS language(s) and/or in English (in some cases, only a summary is provided in English. (Only Sweden's input was missing in March 2008).

Examples of MS actions are:

- tax deductions for energy saving investments
- ecology grants towards the cost of ENE techniques
- support for demonstration projects in energy technology
- feasibility studies
- energy diagnoses
- cogeneration certificates (blue certificates)
- energy planning regulation, where every environmental permit requires an accompanying energy plan or study
- benchmarking covenant, where industries undertake a formal obligation (externally verified) to perform well, e.g. to be among the world's top 10 % best in ENE

- audit covenant, where industries commit to perform a complete energy audit and implement all economically feasible measures
- energy saving certificates (white certificates), see EuroWhiteCert, below.
- energy saving agreements

Initiatives/Projects

The EuroWhiteCert Project is described on this website, with links to the latest information.

Events

Latest events, e.g. press release can be accessed.

Links

As well as the other links described above, the site links to the EU EMEEES project, which deals with the “Evaluation and Monitoring for the EU Directive on Energy End-Use Efficiency and Energy Services”.

A ‘What’s new’ link lists various European published documents (reports, frequently asked questions, etc.), consultations and meetings.

The site map button gives access to:

- policy papers
- legislation
- voluntary agreements, including:
 - European Motor Challenge Programme
 - GreenLight Programme
 - Green Building Programme
- promotional activities, including:
 - project databases
 - publications and brochures
- support programmes, including:
 - research and technology development (RTD) framework programmes (FP)
 - intelligent energy – Europe and previous non-RTD support programmes
- international relations.

For further information, contact TREN EnergyServices@ec.europa.eu

7.14 EU Emissions trading scheme (ETS)

Building on the innovative mechanisms set up under the Kyoto Protocol to the 1992 United Nations Framework Convention on Climate Change (UNFCCC) – Joint Implementation, the Clean Development Mechanism and international emissions trading – the EU has developed the largest company-level scheme for trading in emissions of carbon dioxide (CO₂), making it the world leader in this emerging market.

The EU Emissions Trading Scheme (ETS) is based on a recognition that creating a price for carbon through the establishment of a liquid market for emission reductions offers the most cost-effective way for EU Member States to meet their Kyoto obligations and move towards the low carbon economy of the future. The scheme should allow the EU to achieve its Kyoto target at a cost of between EUR 2.9 billion and 3.7 billion annually. This is less than 0.1 % of the EU's GDP. Without the scheme, compliance costs could reach up to EUR 6.8 billion a year.

The ETS has been established through binding legislation proposed by the European Commission and approved by all EU Member States and the European Parliament. The scheme is based on six fundamental principles:

- it is a 'cap-and-trade' system
- its initial focus is on CO₂ from big industrial emitters
- implementation will take place in phases, with periodic reviews and opportunities for expansion to other gases and sectors
- allocation plans for emission allowances are decided periodically
- it includes a strong compliance framework
- the market is EU-wide but taps emissions reduction opportunities in the rest of the world through the use of clean development mechanisms (CDM) and JI, and provides for links with compatible schemes in third countries (for example in Russia and developing countries).

The scheme is based on a common trading commodity of carbon allowances: one allowance represents the right to discharge one tonne of CO₂. The EC agrees MS national plans for carbon allowances, which give each installation in the scheme the right to a number of allowances. The decisions are made public. There are gains for EU based businesses:

- due to mandatory monitoring and reporting of emissions, companies will establish CO₂ budgets and carbon management systems for the first time
- because CO₂ will have a price, companies will engage the ingenuity of their engineers to identify cost-effective ways to reduce their emissions, both through improving current production processes and investing in new technologies.
- a whole range of new businesses are emerging in Europe as a result of the EU carbon market: carbon traders, carbon finance specialists, carbon management specialists, carbon auditors and verifiers. New financial products such as carbon funds are entering the market.

What the scheme covers

While emissions trading has the potential to involve many sectors of the economy and all the greenhouse gases controlled by the Kyoto Protocol (CO₂, methane, nitrous oxide, hydrofluorocarbons, perfluorocarbons and sulphur hexafluoride), the scope of the ETS will be intentionally limited during its initial phase while experience of emissions trading is built up.

Consequently, during the first trading period, from 2005 to 2007, the ETS covered only CO₂ emissions from large emitters in the power and heat generation industry and in selected energy-intensive industrial sectors: combustion plants, oil refineries, coke ovens, iron and steel plants and factories making cement, glass, lime, bricks, ceramics, pulp and paper. A size threshold based on production capacity or output determines which plants in these sectors are included in the scheme.

Even with this limited scope, more than 12 000 installations in the 27 Member States will be covered, accounting for a round 45 % of the EU's total CO₂ emissions or about 30 % of its overall greenhouse gas emissions.

How will emissions trading benefit companies and the environment?

Theoretically, companies A and B both emit 100 000 tonnes of CO₂ per year. In their national allocation plans their governments give each of them emission allowances for 95 000 tonnes, leaving them to find ways to cover the shortfall of 5000 allowances. This gives them a choice between reducing their emissions by 5000 tonnes, purchasing 5000 allowances in the market or taking a position somewhere in between. Before deciding which option to pursue they compare the costs of each.

In the market, the price of an allowance at that moment is EUR 10 per tonne of CO₂. Company A calculates that cutting its emissions will cost it EUR 5 per tonne, so it decides to do this because it is cheaper than buying the necessary allowances. Company A even decides to take the opportunity to reduce its emissions not by 5000 tonnes but by 10 000 to ensure that it will have no difficulty holding within its emission limit for the next few years.

Company B is in a different situation. Its reduction costs are EUR 15 per tonne, i.e. higher than the market price, so it decides to buy allowances instead of reducing emissions.

Company A spends EUR 50 000 on cutting its emissions by 10 000 tonnes at a cost of EUR 5 per tonne, but then receives EUR 50 000 from selling the 5000 allowances it no longer needs at the market price of EUR 10 each. This means it fully offsets its emission reduction costs by selling allowances, whereas without the emissions trading scheme it would have had a net cost of EUR 25 000 to bear (assuming that it cut emissions by only the 5000 tonnes necessary).

Company B spends EUR 50 000 on buying 5000 allowances at a price of EUR 10 each. In the absence of the flexibility provided by the ETS, it would have had to cut its emissions by 5000 tonnes at a cost of EUR 75 000.

Emissions trading thus brings a total cost-saving of EUR 50 000 for the companies in this example. Since Company A chooses to cut its emissions (because this is the cheaper option in its case), the allowances that Company B buys represent a real emissions reduction even if Company B did not reduce its own emissions.

Reference literature

EU Emissions trading: An Open Scheme Promoting Global Innovation to Combat Climate Change 2004, ISBN 92-894-8326-1 available at:
http://ec.europa.eu/environment/climat/pdf/emission_trading3_en.pdf

7.15 Transport systems optimisation

Depending on the industry sector, transport may be a significant energy consumer in a company. Energy consumption of company transport can be reduced by good ‘transport management’ which is part of the overall management system of the company.

There are also transport systems within the site, such as by pipeline, pneumatic movement of powders, conveyors, fork lift trucks, etc. However, no data has been supplied on these for this document.

The selection of the most environmentally effective transport system depends on the type of product. Road transport is used widely, but rail and ship transport are both used for bulk materials, and pipelines are used for liquids and gases.

7.15.1 Energy audit for transport chains

Intensifying the operation of their transport chains allows companies to improve the logistics of their transport and reduce transportation costs, consumption of energy, and carbon dioxide emissions. The energy audit procedure for transport chains is a tool for identifying measures to increase efficiency and for finding out savings potentials.

The energy audit procedure for transport chains aims to:

- improve cost efficiency
- reduce use of energy and production of CO₂ emissions

Contents of the energy audit:

- all actual and potential means of transport
- logistics, including:
 - packaging; e.g. this can be changed to increase the utilisation of transport, so more product is moved per load, and there are fewer vehicle movements
 - loading
 - storage and handling
 - size and shape of vehicles used
- haulage personnel.

Benefits of the energy audit:

- reduced costs through the improved efficiency of transportation and energy conservation
- individualisation and phasing of development areas
- making good operational practices known within transport chains.

Examples are given in the Sections 7.15.2 and 7.15.3 [272, Finland, 2007].

7.15.2 Road transport energy management

Description of the energy efficiency technique

To manage the energy efficiency of transport, generate long-term improvements in fuel performance, monitor and target successfully and measure the improvements from any initiative it is necessary to collect and analyse data.

The following four steps are essential in a fuel management programme:

- setting up a system of collecting data
- making sure data are collected accurately
- cleaning up data
- analysing and interpreting the data.

The main options for data collection are to:

- collect data manually and key into a spreadsheet or database
- collect data from the fuel pump and upload electronically into a computer spreadsheet or database
- use fuel cards, and either use their reporting systems, or upload them electronically into a computer spreadsheet or database
- monitor the amount of fuel that actually goes through each vehicle's engine by using an onboard device. Many modern trucks with electronically controlled engines can be specified with an optional onboard data system that can capture this information
- fit a separate fuel flow-meter and link this to a proprietary onboard computer to record the fuel consumption.

Allied to the appropriate download methods and computer software, the two last options noted in the bullet point list above should give good quality data about individual vehicle and driver performance, and both have the advantage of measuring fuel actually going into the engine, rather than being dispensed from the storage tank. However, this approach does have some limitations. It does not control bulk fuel stock, i.e. reconciling deliveries and the amount of fuel dispensed.

It is also expensive because the fuel measurement system is replicated on each vehicle rather than a single system monitoring the whole fleet. So it may be necessary to treat onboard devices as an addition to the basic pump system rather than as a replacement for it.

It is important to retain raw data (i.e. fuel used and distance travelled) to avoid creating errors by averaging fuel consumption figures. In other words, when averaging the fuel consumption over any period, the totals of distance and volumes should be used.

Factors which influence fuel consumption

- the vehicle is obviously one of the largest factors in determining the fuel performance (the make/model, the specification, the age of the vehicle, the condition of the vehicle, operational details, equipment and products used, e.g. lubricants, aerodynamics, etc.)
- the driver who drives the vehicle is considered to be the biggest single influence on fuel consumption. Issues concerning the driver start with recruitment and selection and continue through training, motivation and involvement
- the load being carried will naturally affect a vehicle's fuel performance. Total weight is the critical factor, and this often changes during the journey as deliveries are made
- the optimisation of size, shape and loading of the containers holding the products is crucial
- the weather also influences fuel consumption. This needs to be remembered when comparing data gathered during different weather conditions. Wind, rain, sleet, snow, etc. can all have a great impact on performance
- the type of road will play its part, with narrow winding roads giving worse fuel consumption than straight dual carriageways. Slow and tortuous routes through hilly terrain will drag down the fuel performance of even the best vehicles
- fuel acquisition. The two main properties of fuel are the amount of energy it contains, which is highly dependent on the density of the fuel, and the ease with which it combusts.

Monitoring

There are five key elements in monitoring:

1. Measure consumption regularly – this will generally involve the production of regular (preferably weekly) records of the fuel consumption of each vehicle.
2. Relate consumption to output – normally the distance travelled by the vehicle is related to the fuel used (e.g. km per litre), but this can be further refined. Other measures include fuel per tonne km (i.e. fuel used to carry one tonne of payload a distance of one km).
3. Identifying present standards – analyse fuel consumption figures for similar vehicles undertaking similar types of work over a representative period of time. Arrive at an approximate fuel consumption standard for each vehicle. This would not constitute an 'efficient' standard but rather a base or actual figure.
4. Report performance to the individuals responsible – fuel consumption data should be reported regularly to people who have some influence on fuel consumption. These would normally include drivers, engineers and middle and top management.
5. Take action to reduce consumption – taking a systematic overview of fuel use often generates ideas for reducing consumption. Comparing the fuel efficiencies of different vehicles is likely to reveal anomalies in their performance. Identifying the causes of these anomalies should enable good practice to be distinguished from bad, and allow steps to be taken to eliminate poor performance.

Tightening up operating practices and vehicle maintenance in this way often leads to savings even without the introduction of specific fuel saving measures.

Historical fuel information is crucial to plan and implement energy saving measures. Fuel information for each vehicle at raw data level is kept throughout its life, in much the same way as its servicing records.

Reporting

The following standard reports are useful in fuel management:

- bulk tank stock reconciliation
- individual vehicle and driver fuel performance
- exception reports.

Vehicle performance can then be grouped by type, such as:

- articulated/rigid
- gross vehicle weight
- manufacturer/model
- age
- work done.

Driver performance can also be grouped, using categories such as shift, type of work and trained or untrained. The usual periods for measurement are weekly, monthly and year to date.

Useful comparisons are against:

- targets
- previous period(s) for the analysis of trends
- same period last year
- other depots, bearing in mind regional and operational differences
- similar vehicles
- industry averages, e.g. road test reports, published cost tables.

These data are used at least by the following people:

- the top management (a concise overview, summaries and exception reports)
- the transport manager (the fuel saving initiatives, investigate specifics and carry out individual performance reviews)
- the driver trainer (plan a fuel-related training programme and set up discussions with drivers, who themselves need to start monitoring their own performance)
- engineering and maintenance staff (monitor and analyse the fuel figures).

There are many areas of fuel management which can be subject to key performance indicators and targets. The easiest are where measurement is straightforward and unaffected by too many outside factors. Examples would include bulk tank fuel losses where the figures might be measured each week with a requirement to investigate and resolve any losses over a target figure.

More complicated measures are involved in the monitoring system of vehicle performance. The simplest way is merely to take current performance and demand an improvement. However, this takes into consideration only what has actually been achieved rather than what is achievable.

Where the routes, loads, etc. are consistent, it may be possible to set up standard targets by route, using your best driver to set the target for everyone else, although obviously, this will not take into account seasonal and other such outside influences, and therefore will need to be interpreted very carefully.

A more sophisticated approach is to use energy intensity as an indicator. For freight transport this is defined as fuel consumed/(tonnes carried x distance travelled) and would normally be measured as litres per tonne kilometre.

Achieved environmental benefits

The reduction of fuel consumption has a direct correspondence to the environmental effects. Reducing consumption not only represents avoided costs but also fewer tonnes of CO₂ are produced.

Cross-media effects

None reported.

Operational data

Driving in a fuel-efficient manner can improve safety and benefit the vehicle's driveline, brakes and tyres as well. So there could well be a reduction in the costs of accidents, maintenance, repairs and downtime.

Some operators have even used the improvement in fuel economy as a commercial tool to emphasise the contribution they are making to the environment.

Thorough communication between drivers and management is part of a good fuel programme. If handled well, there is a potential spin-off here, because it might lead to better understanding and some barriers being broken down. Some organisations have used fuel efficiency as a means of changing the driver culture.

Applicability

This fuel management technique can be applied to industries that have road transport fleets.

Economics

The combination of the crude oil price and fuel excise duty has meant that fuel has generally proved to be a fast-rising operating cost. This means that any investment in good fuel management now may well pay even greater dividends in the future.

The achievement of fuel savings invariably requires an investment in time, effort or money – and often all three. Financial expenditure on such things as fuel monitoring equipment or better vehicles is easy to quantify, but do not forget hidden costs, such as investment in management, clerical and operative time, which may be more difficult to pin down.

Driving force for implementation

Cost savings – not all energy conservation measures are equally cost effective. Different measures will be better suited to different types of operation. However, it is important that anyone wishing to reduce their fuel consumption should proceed in a systematic manner, rather than introduce new practices on a piecemeal basis. It is practical that energy consumption of transport is included in a generic energy management system/structure.

7.15.3 Improving packaging to optimise transport use

Example plant

- company: VICO SA located in Vic-sur-Aisne (France)
- activity: production of potato crisps and other products derived from potatoes
- quantity: 32 000 tonnes per year
- turnover: EUR 114.4 million/year.

To deliver its products to 2500 selling points in France, VICO SA needed to use 9000 truck movements per year. The products were packaged and placed on pallets to a height of 1.8 metres. In this manner, a standard truck (2.8 metres high) contained 38 pallets (on one level) and the filling rate was limited to 70 %. Following a feasibility study, the product packaging was changed to allow the storage on pallets to 1.4 metres high and to be loaded on two levels. This enabled the number of truck movements to be reduced by 10 % and the kilometres travelled by 20 %:

- investment required: EUR 76 224
- payback time: 1.5 month
- test period: 3 months
- initial consumption: 686 030 l/year of gasoil (diesel)
- consumption after implementation of the new packaging: 536 875 l/year of gasoil
- reduction by 22 % of the gasoil (diesel) consumption
- indirect cost reduction for the company (transport is an external activity for this company): EUR 610 000 per year.

Reference information

ADEME guide on good energy practices in industry (ref 3745)
[94, ADEME, 2005] [103, Best practice programme, 1996]

7.16 European energy mix

Electricity

To create 1 GJ of electrical power, the average fuel use and emissions released for the EU-25 are:

Electrical power	GJ	1
Primary energy	GJ	#2.6
Oil	kg	9.01
Gas	m ³	6.92
Coal	kg	15.7
Brown coal	kg	34.6
SO ₂	kg	0.10
CO ₂	kg	*147
NO ₂	kg	0.16

European Mix*	
Oil	4.1 %
Gas	19.0 %
Hard coal	13.1 %
Raw brown coal	23.8 %
Coal in total	36.9 %
Nuclear	30.9 %

IFEU Calculation		Fuel oil	Electricity from oil firing	Natural gas	Electricity from gas	Hard coal	Electricity from coal	Brown coal	Electricity from brown coal	Nuclear power
Current	GJ		1.00E+00		1.00E+00		1.00E+00		1.00E+00	1.00E+00
Primary energy	GJ	3.69E+00		2.90E+00		2.38E+00		2.82E+00		3.35E+00
Oil	kg	9.22E+01	7.88E+01							4.19E-01
Gas	m ³			7.14E+01	5.33E+01					3.74E-01
Coal	kg					8.48E+01	8.19E+01			3.03E+00
Brown coal	kg							3.19E+02	3.12E+02	
SO ₂	kg	6.44E-02	2.43E-01	3.24E-03	2.88E-03	5.05E-02	1.48E-01	3.73E-03	2.22E-01	3.22E-02
CO ₂	kg	1.26E+01	2.47E+02	1.46E+01	1.32E+02	1.06E+01	2.17E+02	7.84E+00	3.16E+02	6.27E+00
NO ₂	kg	3.46E-02	3.68E-01	7.79E-02	1.51E-01	4.11E-02	1.10E-01	6.30E-03	6.14E-01	1.43E-02

These average emission factors associated with generating electrical power are derived from the ECOINVENT 1994 database.
Data from the WFD revision. * data from IEA for EU-25 for 2004

Table 7.19: Average emission factors associated with generating electrical power

Steam

To produce steam with energy value of 1 GJ, the average fuel use and emissions released for the whole of Europe are:

Steam	GJ	1
Primary energy	GJ	1.32
Oil	kg	12.96
Gas	m ³	10.46
Coal	kg	14.22
SO ₂	kg	0.54
CO ₂	kg	97.20
NO ₂	kg	0.18

European Mix (estimated mix)	
Oil	40.0 %
Gas	30.0 %
Hard Coal	30.0 %

		Fuel oil	Heat from oil firing	Natural gas	Heat from gas	Hard coal	Heat from coal
Heat GJ			1.00E+00		1.00E+00		1.00E+00
Primary energy	GJ	1.29E+00		1.41E+00		1.28E+00	
Oil k	g	3.24E+01	2.75E+01				
Gas m	³			3.49E+01	2.81E+01		
Coal k	g					4.74E+01	4.14E+01
SO ₂	kg	4.01E-02	9.95E-01	1.61E-02	5.75E-04	4.76E-02	3.70E-01
CO ₂	kg	6.51E+00	9.22E+01	7.16E+00	6.48E+01	5.82E+00	1.15E+02
NO ₂	kg	1.77E-02	1.78E-01	3.47E-02	4.47E-02	3.77E-02	2.17E-01
ECOINVENT							
		Fuel oil	Heat from oil firing	Natural gas	Heat from gas	Hard coal	Heat from coal
Heat GJ			1.00E+00		1.00E+00		1.00E+00
Primary Energy	GJ	1.22E+00		1.43E+00		1.36E+00	
Oil k	g	3.06E+01	2.60E+01				
Gas m	³			3.53E+01	3.00E+01		
Coal k	g					5.21E+01	4.17E+01
SO ₂	kg	1.59E-02	1.41E+00	3.06E-02	6.47E-04	6.98E-02	6.29E-01
CO ₂	kg	4.24E-01	9.16E+01	7.29E+00	6.47E+01	6.36E+00	1.16E+02
NO ₂	kg	8.24E-04	1.88E-01	3.18E-02	2.35E-02	5.50E-02	2.50E-01
GEMIS							
		Fuel oil	Heat from oil firing	Natural gas	Heat from gas	Hard coal	Heat from coal
Heat GJ			1.00E+00		1.00E+00		1.00E+00
Primary Energy	GJ	1.35E+00		1.39E+00		1.20E+00	
Oil k	g	3.42E+01	2.89E+01				
Gas m	³			3.44E+01	2.63E+01		
Coal k	g					4.27E+01	4.12E+01
SO ₂	kg	6.44E-02	5.78E-01	1.52E-03	5.03E-04	2.54E-02	1.11E-01
CO ₂	kg	1.26E+01	9.27E+01	7.02E+00	6.49E+01	5.28E+00	1.13E+02
NO ₂	kg	3.46E-02	1.69E-01	3.76E-02	6.59E-02	2.05E-02	1.83E-01

These average emissions factors for steam generation are derived as averages from the ECOINVENT and GEMIS databases.

Table 7.20: Average emission factors for steam generation

7.17 Electrical power factor correction

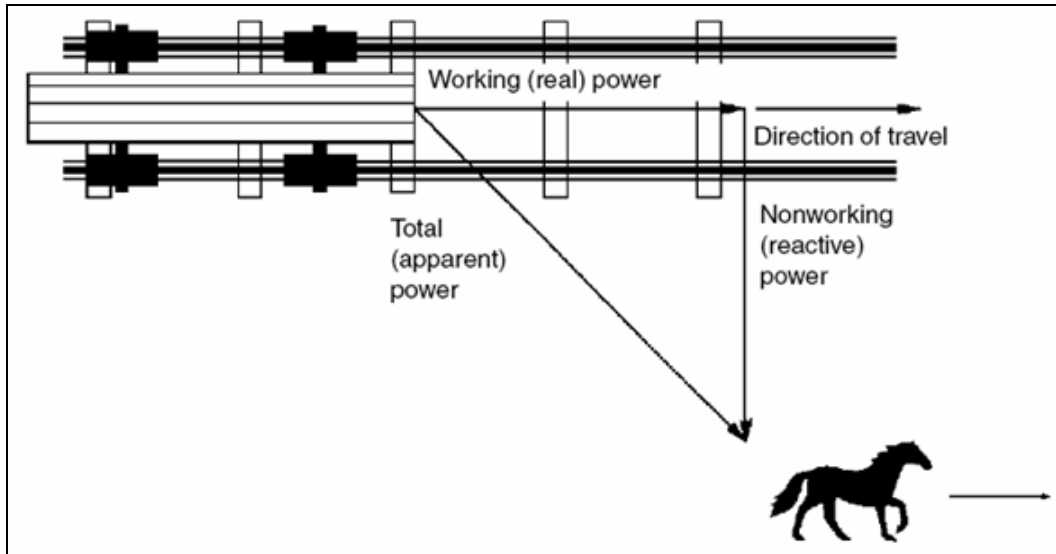

Figure 7.17: Reactive and apparent power explanation
[123, US_DOE]

To understand the electrical power factor, visualise a horse pulling a railway wagon along a track. Because the railway ties are uneven, the horse must pull the wagon from the side of the track. The horse is pulling the wagon at an angle to the direction of the wagon's travel. The power required to move the wagon down the track is the working (real or net) power. The effort of the horse is the total (apparent) power. Because of the angle of the horse's pull, not all of the horse's effort is used to move the wagon down the track. The wagon will not move sideways; therefore, the sideways pull of the horse is wasted effort or nonworking (reactive) power.

The angle of the horse's pull is related to the power factor, which is defined as the ratio of real (working or net) power to apparent (total) power. If the horse is led closer to the centre of the track, the angle of side pull decreases and the real power approaches the value of the apparent power. Therefore, the ratio of real power to apparent power (the power factor) approaches 1. As the power factor approaches 1, the reactive (nonworking) power approaches 0.

Reference:

US DOE: Motor challenge programme, Fact sheet: Reducing Power Factor Cost
<http://www1.eere.energy.gov/industry/bestpractices/pdfs/mc60405.pdf>