



EUROPEAN COMMISSION

**Integrated Pollution Prevention and Control (IPPC)**

**Reference Document on Best Available Techniques for  
Intensive Rearing of Poultry and Pigs**

**July 2003**

This document is one of a series of foreseen documents as below (at the time of writing, not all documents have been drafted):

<b>Full title</b>	<b>BREF code</b>
Reference Document on Best Available Techniques for Intensive Rearing of Poultry and Pigs	ILF
Reference Document on the General Principles of Monitoring	MON
Reference Document on Best Available Techniques for the Tanning of Hides and Skins	TAN
Reference Document on Best Available Techniques in the Glass Manufacturing Industry	GLS
Reference Document on Best Available Techniques in the Pulp and Paper Industry	PP
Reference Document on Best Available Techniques on the Production of Iron and Steel	I&S
Reference Document on Best Available Techniques in the Cement and Lime Manufacturing Industries	CL
Reference Document on the Application of Best Available Techniques to Industrial Cooling Systems	CV
Reference Document on Best Available Techniques in the Chlor – Alkali Manufacturing Industry	CAK
Reference Document on Best Available Techniques in the Ferrous Metals Processing Industry	FMP
Reference Document on Best Available Techniques in the Non Ferrous Metals Industries	NFM
Reference Document on Best Available Techniques for the Textiles Industry	TXT
Reference Document on Best Available Techniques for Mineral Oil and Gas Refineries	REF
Reference Document on Best Available Techniques in the Large Volume Organic Chemical Industry	LVOC
Reference Document on Best Available Techniques in the Waste Water and Waste Gas Treatment/Management Systems in the Chemical Sector	CWW
Reference Document on Best Available Techniques in the Food, Drink and Milk Industry	FM
Reference Document on Best Available Techniques in the Smitheries and Foundries Industry	SF
Reference Document on Best Available Techniques on Emissions from Storage	ESB
Reference Document on Best Available Techniques on Economics and Cross-Media Effects	ECM
Reference Document on Best Available Techniques for Large Combustion Plants	LCP
Reference Document on Best Available Techniques in the Slaughterhouses and Animals By-products Industries	SA
Reference Document on Best Available Techniques for Management of Tailings and Waste-Rock in Mining Activities	MTWR
Reference Document on Best Available Techniques for the Surface Treatment of Metals	STM
Reference Document on Best Available Techniques for the Waste Treatments Industries	WT
Reference Document on Best Available Techniques for the Manufacture of Large Volume Inorganic Chemicals (Ammonia, Acids and Fertilisers)	LVIC-AAF
Reference Document on Best Available Techniques for Waste Incineration	WI
Reference Document on Best Available Techniques for Manufacture of Polymers	POL
Reference Document on Energy Efficiency Techniques	ENE
Reference Document on Best Available Techniques for the Manufacture of Organic Fine Chemicals	OFC
Reference Document on Best Available Techniques for the Manufacture of Specialty Inorganic Chemicals	SIC
Reference Document on Best Available Techniques for Surface Treatment Using Solvents	STS
Reference Document on Best Available Techniques for the Manufacture of Large Volume Inorganic Chemicals (Solids and Others)	LVIC-S
Reference Document on Best Available Techniques in Ceramic Manufacturing Industry	CER

## EXECUTIVE SUMMARY

The Intensive Rearing of Poultry and Pigs (ILF) BREF (Best Available Techniques reference document) reflects an information exchange carried out under Article 16(2) of Council Directive 96/61/EC. This executive summary – which is intended to be read in conjunction with the BREF Preface’s explanation of objectives, usage and legal terms – describes the main findings, the principal BAT conclusions and the associated emission/consumption levels. It can be read and understood as a stand-alone document but, as a summary, it does not present all the complexities of the full BREF text. It is therefore not intended as a substitute for the full BREF text as a tool in BAT decision making.

### Scope of work

The scope of the BREF for intensive livestock is based on Section 6.6 of Annex I of the IPPC Directive 96/61/EC as ‘Installations for the intensive rearing of poultry or pigs with more than:

- (a) 40000 places for poultry
- (b) 2000 places for production pigs (over 30 kg), or
- (c) 750 places for sows.’

The Directive does not define the term ‘poultry’. From the discussion in the Technical Working Group (TWG) it was concluded that in this document the scope of poultry is chicken laying hens and broilers, turkeys, ducks and Guinea fowls. However, only laying hens and broilers are considered in detail in this document because of a lack of information on turkeys, ducks and Guinea fowls. The production of pigs includes the rearing of weaners, whose growing/finishing starts at a weight that varies between 25 and 35 kg of live weight. The rearing of sows includes mating, gestating and farrowing sows and gilts.

### Structure of the industry

#### *Farming in general*

Farming has been and still is dominated by family run businesses. Until the sixties and into the early seventies, poultry and pig production were only part of the activities of a mixed farm, where crops were grown and different animal species were kept. Feed was grown on the farm or purchased locally and residues of the animal were returned to the land as fertiliser. Only a very small number of this type of farm may still exist in the EU, because increasing market demands, the development of genetic material and farming equipment and the availability of relatively cheap feed has encouraged farmers to specialise. As a consequence animal numbers and farm sizes have increased and intensive livestock farming began.

Animal welfare issues and developments in these have been respected throughout this work, although they have not been a primary driving force. In addition to the existing EU-legislation, the discussion about animal welfare will be continued. Some of the Member States have already different regulations concerning animal welfare and promote housing system requirements exceeding animal welfare regulations.

#### *Poultry*

Worldwide, Europe is the second largest producer of hen eggs with about 19 % of the world total and it is expected that this production will not change significantly in the coming years. Eggs for human consumption are produced in all Member States. The largest producer of eggs in the EU is France (17 % of egg production) followed by Germany (16 %), Italy and Spain (both 14 %) closely followed by the Netherlands (13 %). Of the exporting Member States the Netherlands is the largest exporter with 65 % of its production exported, followed by France, Italy and Spain, while in Germany consumption is higher than production. Most of the EU-produced consumption eggs (about 95 %) are consumed within the European community itself.

The majority of laying hens in the EU are kept in cages, although particularly in Northern Europe, non-cage egg production has gained in popularity over the past ten years. For example,

the United Kingdom, France, Austria, Sweden, Denmark and the Netherlands have all increased the proportion of eggs produced in systems such as barn, semi-intensive, free range and deep litter. Deep litter is the most popular non-cage system in all Member States, except for France, Ireland and the United Kingdom, where semi-intensive systems and free range are preferred.

The number of layers kept on one farm varies considerably between a few thousand and up to several hundred thousand. Only a relatively small number of farms per Member State are expected to be under the scope of the IPPC Directive, i.e. over 40000 laying hens. The total number of farms in the EU meeting this threshold is just over 2000.

The biggest producer of poultry meat in the EU-15 (year 2000) is France (26 % of EU-15 poultry meat production), followed by United Kingdom (17 %), Italy (12 %) and Spain (11 %). Some countries are clearly export-orientated, such as the Netherlands, where 63 % of production is not consumed within the country, and Denmark, France and Belgium where 51 %, 51 % and 31 % of production are not consumed within the country of production. On the other hand, some countries such as Germany, Greece and Austria have consumption higher than production; in those countries, 41 %, 21 % and 23 % of the total consumption is imported from other countries.

Production of poultry meat has been increasing since 1991. The largest EU producers (France, UK, Italy and Spain) all show an increase in their poultry meat production.

Broilers are generally not housed in cages, although cage systems exist. The majority of poultry meat production is based on an all-in all-out system applying littered floors. Broiler farms with over 40000 bird places, thus falling under the scope of the IPPC Directive, are quite common in Europe.

### *Pigs*

The EU-15 accounts for approximately 20 % of world pork production, which is indicated by slaughtered carcass weight. The major producer of pork is Germany (20 %), followed by Spain (17 %), France (13 %), Denmark (11 %) and the Netherlands (11 %). Together they produce more than 70 % of the EU-15 indigenous production. The EU-15 is a net exporter of pork, importing only a very small amount. However, not every major producer is a net exporter; Germany, for example, imported about twice as much as it exported in 1999.

In the EU-15, pig production increased by 15 % between 1997 and 2000. The total number of pigs in December 2000 was 122.9 million, which corresponds to a 1.2 % decrease as compared with 1999.

Pig farms vary considerably in size. Across the EU-15, 67 % of sows are in units of more than 100 sows. In Belgium, Denmark, France, Ireland, Italy, the Netherlands and the United Kingdom this figure is over 70 %. In Austria, Finland and Portugal smaller sow units are predominant.

The majority of pigs for fattening (81 %) are reared on units of 200 pigs or more, with 63 % of them on units of more than 400 pigs. 31 % of fattening pigs are reared on holdings of more than 1000 pigs. The industry in Italy, United Kingdom and Ireland is characterised by units of more than 1000 fattening pigs. Germany, Spain, France and the Netherlands have significant proportions of pigs in units of between 50 and 400 fattening pigs. From these numbers it is obvious that only a relatively small number of farms will fall under the scope of the IPPC Directive.

In the assessment of consumption and emission levels of pig farming it is important to know the production system applied. Growing and finishing typically aim for a slaughter weight of 90 - 95 kg (UK), 100 - 110 kg (other) or 150 - 170 kg (Italy), these weights being reached over different periods of time.

## Environmental impact of the industry

In intensive livestock the key environmental aspect is that the animals metabolise feed and excrete nearly all the nutrients via manure. In the production of pigs for slaughter the process of nitrogen consumption, utilisation and losses is well understood and is shown in Figure 1. Unfortunately such a figure is not available for poultry.

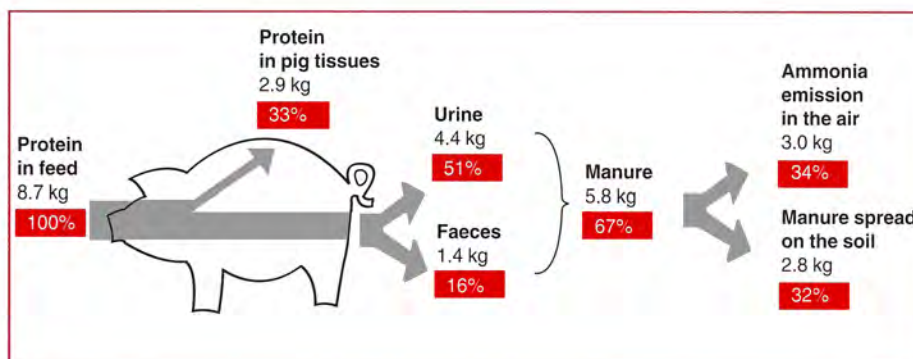

Figure 1: Consumption, utilisation and losses of protein in the production of a pig of 108 kg

Intensive livestock farming coincides with high animal densities and this density can be considered as a rough indicator of the amount of animal manure produced by the livestock. A high density might suggest that the mineral supply available from the animal manure might exceed the requirements of the agricultural area for growing crops or maintaining grassland.

In most countries pig production is concentrated in certain regions, for example in the Netherlands production is concentrated in the southern provinces, in Belgium it is strongly concentrated in West Flanders. In France intensive pig production is concentrated in Brittany and in Germany pig production is concentrated in the northwest. Italy has concentrations of pig production in the Po valley; in Spain this is in Cataluña and Galicia and in Portugal pig production is concentrated in the north. The highest densities are reported to be in the Netherlands, Belgium and Denmark.

Data on the concentration of livestock production at a regional level are considered to be a good indication of whether a region might have potential environmental problems. This is clearly illustrated by Figure 2, which shows problems such as: acidification ( $\text{NH}_3$ ,  $\text{SO}_2$ ,  $\text{NO}_x$ ), eutrophication (N, P), local disturbance (odour, noise) and diffuse spreading of heavy metals and pesticides.

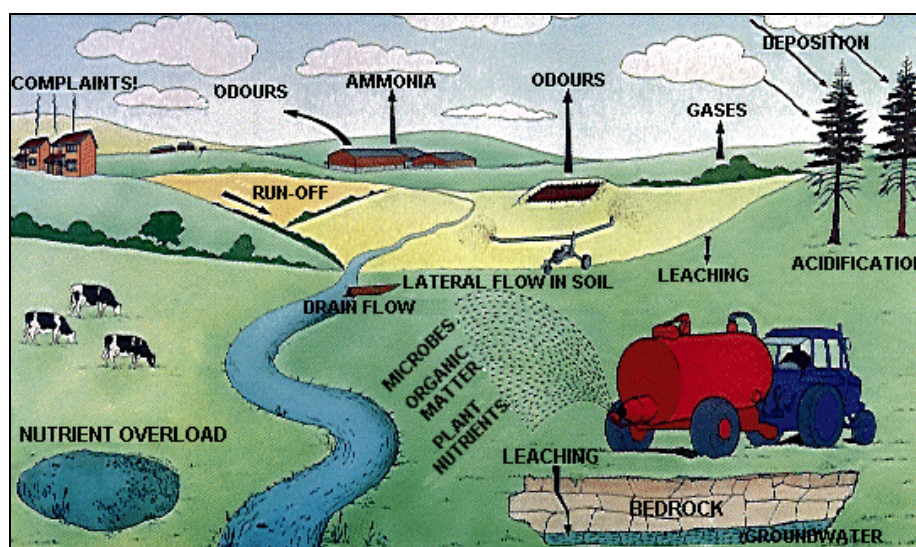

Figure 2: Illustration of environmental aspects related to intensive livestock farming

## Applied techniques and BAT on intensive livestock farming

Generally, the activities that can be found on intensive livestock farms are:

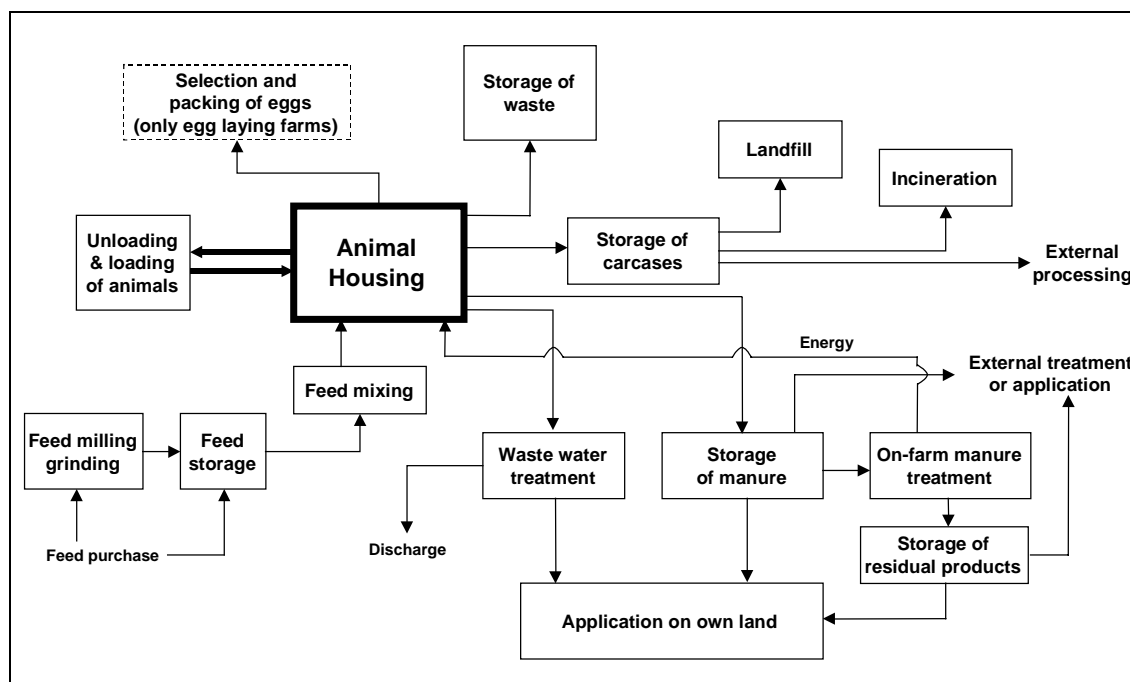

Figure 3: General scheme of activities on intensive livestock farms

The central environmental issue in intensive livestock farming is manure. This is reflected in the order in which on-farm activities are presented in Chapters 4 and 5 in this document, starting with good agricultural practice, followed by feeding strategies to influence quality and composition of the manure, methods of removing the manure from the housing system, the storage and treatment of manure and finally the landspreading of manure. Other environmental issues such as waste, energy, water and waste water, and noise are also addressed, although in lesser detail.

Ammonia has been given most attention as the key air pollutant as it is emitted in the highest quantities. Nearly all the information on the reduction of emissions from animal housing reported on the emission reduction of ammonia. It is assumed that techniques reducing the emissions of ammonia will reduce emissions of the other gaseous substances as well. Other environmental impacts relate to nitrogen and phosphorus emissions to soil, surface water and groundwater, and result from the application of manure to land. Measures to decrease these emissions are not limited to how to store, treat or apply the manure once it arises, but comprise measures throughout a whole chain of events, including steps to minimise the production of manure.

In the paragraphs below the applied techniques and the conclusions on BAT are summarised for poultry and pigs.

### *Good agricultural practice in the intensive rearing of pigs and poultry*

Good agricultural practice is an essential part of BAT. Although it is difficult to quantify environmental benefits in terms of emission reductions or reductions in the use of energy and water, it is clear that conscientious farm management will contribute to an improved environmental performance of an intensive poultry or pig farm. For improving the general environmental performance of an intensive livestock farm, BAT is to do all of the following:

- identify and implement education and training programmes for farm staff
- keep records of water and energy usage, amounts of livestock feed, waste arising and field applications of inorganic fertiliser and manure
- have an emergency procedure to deal with unplanned emissions and incidents
- implement a repair and maintenance programme to ensure that structures and equipment are in good working order and that facilities are kept clean
- plan activities at the site properly, such as the delivery of materials and the removal of products and waste, and
- plan the application of manure to land properly.

### ***Feeding strategies for poultry and pigs***

The composition of poultry feed varies considerably not just between installations but also between MSs. This is because it is a mixture of different ingredients, such as cereals, seeds, soya beans, and bulbs, tubers, roots or root crops and products of animal origin (e.g. fish meal, meat and bone meal and milk products). The main ingredients for pigs are cereals and soya.

The efficient feeding of animals aims to supply the required amount of net energy, essential amino acids, minerals, trace elements and vitamins for growth, fattening or reproduction. Pigs feed formulation is a complex matter and factors such as, live weight and the stage of reproduction, influence the composition of feed. Liquid feed is the most commonly applied, but dry feed or mixtures are also applied.

Apart from formulating the feed to closely match the requirements of the birds and the pigs, different types of feeding are also given during production cycles. See Table 1 for the different categories and the number of feeds phases that are most commonly applied and that are BAT.

An applied technique to reduce the excretion of nutrients (N and P) in manure, for pigs and poultry, is 'nutritional management'. Nutritional management aims to match feeds more closely to animal requirements at various production stages, thus reducing the amount of nitrogen waste rising from undigested or catabolised nitrogen, and which is subsequently eliminated through urine. Feeding measures include phase-feeding, formulating diets based on digestible/available nutrients, using low protein amino acid-supplemented diets and using low phosphorus phytase-supplemented diets or diets with highly digestible inorganic feed phosphates. Furthermore the use of certain feed additives, such as enzymes, may increase the feed efficiency thereby improving the nutrient retention and hence reducing the amount of nutrient left over in the manure.

For pigs a crude protein reduction of 2 to 3 % (20 to 30 g/kg of feed) can be achieved depending on the breed/genotype and the actual starting point, for poultry this is 1 to 2 % (10 to 20 g/kg of feed). The resulting range of dietary crude protein contents concluded to be BAT is reported in Table 1. The values in the table are only indicative, because they, amongst others, depend on the energy content of the feed. Therefore levels may need to be adapted to local conditions. Research on further applied nutrition is currently being carried out in a number of Member States and may support possible further reductions in the future, depending on the effects of changes in genotypes.

As far as phosphorus is concerned, a basis for BAT is to feed animals (poultry and pigs) with successive diets (phase-feeding) with lower total phosphorus contents. In these diets, highly digestible inorganic feed phosphates and/or phytase must be used in order to guarantee a sufficient supply of digestible phosphorus.

For poultry a total phosphorus reduction of 0.05 to 0.1 % (0.5 to 1 g/kg of feed) can be achieved depending on the breed/genotypes, the use of feed raw materials and the actual starting point by the application of highly digestible inorganic feed phosphates and/or phytase in the feed. For pigs this reduction is 0.03 to 0.07 % (0.3 to 0.7 g/kg of feed). The resulting range of dietary total phosphorus contents is reported in Table 1. As for the pigs situation, the BAT associated values

in the table are only indicative, because they, amongst others, depend on the energy content of the feed. Therefore levels may need to be adapted to local conditions. Further applied nutrition research is currently being carried out in a number of Member States and may support further possible reductions in the future, depending on the effects of changes in genotypes.

Species	Phases	Crude protein content (% in feed) <sup>1)</sup>	Total phosphorus content (% in feed) <sup>2)</sup>	Remark
Broiler	starter	20 – 22	0.65 – 0.75	1) With adequately balanced and optimal digestible amino acid supply  and  2) With adequate digestible phosphorus by using e.g. highly digestible inorganic feed phosphates and/or phytase
	grower	19 – 21	0.60 – 0.70	
	finisher	18 – 20	0.57 – 0.67	
Turkey	<4 weeks	24 – 27	1.00 – 1.10	
	5 – 8 weeks	22 – 24	0.95 – 1.05	
	9 – 12 weeks	19 – 21	0.85 – 0.95	
	13+ weeks	16 – 19	0.80 – 0.90	
	16+ weeks	14 – 17	0.75 – 0.85	
Layer	18 – 40 weeks	15.5 – 16.5	0.45 – 0.55	
	40+ weeks	14.5 – 15.5	0.41 – 0.51	
Weaner	<10 kg	19 – 21	0.75 – 0.85	
Piglet	<25 kg	17.5 – 19.5	0.60 – 0.70	
Fattening pig	25 – 50 kg	15 – 17	0.45 – 0.55	
	50 – 110 kg	14 – 15	0.38 – 0.49	
Sow	gestation	13 – 15	0.43 – 0.51	
	lactation	16 – 17	0.57 – 0.65	

**Table 1: Indicative crude protein levels in BAT-feeds for poultry and pigs**

***Housing systems for poultry; laying hens***

Most laying hens are still kept in cages. The conventional housing system is a battery with open manure storage under the cages, but nowadays most techniques are an improvement of this system. The principle behind the reduction of ammonia emissions from the cages is a frequent removal of the manure. Drying of manure also reduces the emissions by inhibiting the chemical reactions. The quicker the manure is dried the lower the emission of ammonia. A combination of frequent removal and forced drying of manure gives the highest reduction of ammonia emissions from the housing and also reduces emissions from the storage facilities, but at an associated energy cost. The cage systems commonly applied, and which are BAT are:

- a cage system with manure removal, at least twice a week, by way of manure belts to a closed storage
- vertical tiered cages with a manure belt and with forced air drying, where the manure is removed at least once a week to a covered storage
- vertical tiered cages with a manure belt and with whisk-forced air drying, where the manure is removed at least once a week to a covered storage
- vertical tiered cages with a manure belt and with improved forced air drying, where the manure is removed from the house at least once a week to a covered storage
- vertical tiered cages with a manure belt and with drying tunnel over the cages; the manure is removed to a covered storage after 24 – 36 hours.

The cage system with an aerated open manure storage (also known as a deep pit system) is a conditional BAT. In regions where a Mediterranean climate prevails, this system is BAT. In regions with much lower average temperatures, this technique can show a significantly higher ammonia emission and is not BAT unless a means of drying the manure in the pit is provided.

However, as a consequence of the requirements of Directive 1999/74/EC laying down minimum standards for the protection of laying hens, the above-mentioned cage systems will be banned. This will prohibit the installation of any new conventional cage systems by 2003 and lead to a total ban on the use of such cage systems by 2012. However, in 2005 it will be decided whether the above-mentioned Directive needs to be reviewed. This decision depends on the results of several studies and on-going negotiations.



The banning of conventional cage systems will require farmers to use the so-called enriched cage or non-cage systems. Different techniques applying the enriched cage concept are currently under development but little information is yet available. However, these designs will form the only alternative cage system that will be allowed for new installations from 2003 onwards. Applied non-cage housing systems, which are concluded to be BAT, are:

- a deep litter system (with or without forced drying of the manure)
- a deep litter system with a perforated floor and forced drying of the manure
- an aviary system with or without range and/or outside scratching area.

The information in the main body of the BREF, on all the above mentioned housing systems, shows that improving the animal welfare would have a negative effect of limiting the achievable reduction of ammonia emissions from layer housing.

### ***Housing systems for poultry; broilers***

The traditional housing for intensive broiler production is a simple closed building construction of concrete or wood with natural light or windowless with a light system, thermally insulated and force-ventilated. Buildings are also used that are constructed with open sidewalls (windows with jalousie-type curtains); forced ventilation (negative pressure principle) is applied by way of fans and air inlet valves. The broilers are kept on litter (normally chopped straw, but wood shavings or shredded paper are also applied) spread over the entire house floor area. Manure is removed at the end of each growing period. Broilers are normally kept at a stocking density of 18 to 24 birds per m<sup>2</sup> and the houses can stock between 20000 and 40000 birds. New legislation on animal welfare is expected to limit the stocking density of broilers.

To reduce ammonia emissions from the housing wet litter must be avoided. For this reason a new housing technique (VEA-system) was designed where attention was paid to the insulation of the building, to the drinking system (to avoid spillage) and to the application of wood shavings/sawdust. However, emissions were shown to be equal to the traditional housing system. The decision on BAT was that BAT on housing systems for broilers is:

- the naturally ventilated house with a fully littered floor and equipped with non-leaking drinking systems
- the well-insulated fan ventilated house with a fully littered floor and equipped with non-leaking drinking systems (VEA-system).

Some newly developed systems have a forced drying system that blows air through a layer of litter and droppings. The reduction in ammonia emissions is considerable (83 – 94 % reductions compared to the traditional housing system), but they are expensive, show an increase in energy use and have high dust levels. However, when already in place they are concluded to be BAT. These techniques are:

- a perforated floor system with forced air drying system
- a tiered floor with forced air drying system
- a tiered cage system with removable cage sides and the forced drying of manure.

There is normally a system for heating the air in broiler houses. This can be the “combideck system”, which heats the floor and the substances (such as litter) on top of it. The system consists of a heat pump, an underground storage facility made of tubes, and a layer of isolated hollow strips (intermediately spaced every 4 cm) 2 – 4 metres below the floor. The system uses two water cycles: one serving the house and the other acting as the underground storage. Both cycles are closed and connected through a heat pump. In the broiler house, the hollow strips are put in an insulated layer below the concrete floor (10 - 12 cm). Depending on the temperature of the water that flows through the strips, the floor and the litter will either be warmed up or cooled down.

This combideck system, also proposed as a technique to reduce energy, is a conditional BAT. It can be applied if local conditions allow, e.g. if soil conditions allow the installation of closed underground storages of the circulated water. The system is only applied in the Netherlands and

in Germany, at a depth of 2 – 4 metres. It is not yet known if this system performs equally well in locations where the frosts are longer and harder and penetrate the soil or where the climate is much warmer and the cooling capacity of the soil might not be sufficient.

### *Housing systems for pigs; general remarks*

A number of general points are made on pig housing which are followed by a detailed description of applied housing techniques and BAT on housings for mating and gestating sows, growers/finishers, farrowing sows and weaners.

Designs to reduce ammonia emissions to air from pig housing systems, as presented in Chapter 4, basically involve some or all of the following principles:

- reducing emitting manure surfaces
- removing the manure (slurry) from the pit to an external slurry store
- applying an additional treatment, such as aeration, to obtain flushing liquid
- cooling the manure surface
- using surfaces (for example, of slats and manure channels) which are smooth and easy to clean.

Concrete, iron and plastic are used in the construction of slatted floors. Generally speaking and given the same slat width, manure dropped on concrete slats takes longer to fall into the pit than when using iron or plastic slats, and this is associated with higher emissions of ammonia. It is worth noting that iron slats are not allowed in some Member States.

The frequent removal of manure by flushing with slurry may result in a peak in odour emissions with each flush. Flushing is normally done twice a day; once in the morning and once in the evening. These peaks in odour emissions can cause a nuisance to neighbours. Additionally treatment of the slurry also requires energy. These cross-media effects have been taken into account in defining BAT on the various housing designs.

With respect to litter (typically straw), it is expected that the use of litter in pig housing will increase throughout the Community due to a raised awareness of animal welfare. Litter may be applied in conjunction with (automatically-controlled) naturally ventilated housing systems, where litter would protect the animals from low temperatures, thus requiring less energy input for ventilation and heating. In systems where litter is used, the pen can be divided into a dunging area (without litter) and a littered solid floor area. It is reported that pigs do not always use these areas in the correct way, i.e. they dung in the littered area and/or use the slatted- or solid dunging area to lie on. However, the pen design can influence the behaviour of the pigs, although it is reported that in regions with a warm climate this might not be sufficient to prevent the pigs dunging and lying in the wrong areas. The argument for this is that in a full litter system the pigs do not have the possibility of cooling down by lying on an uncovered floor.

An integrated evaluation of litter use would include the extra costs for litter supply and mucking out, as well as the possible consequences on the emissions from storage of the manure and for the application onto land. The use of litter results in solid manure which increases the organic matter of the soils. In some circumstances therefore this type of manure is beneficial to soil quality; this is a very positive cross-media effect.

In Chapter 4 applied housing techniques for pigs are assessed on the ammonia emission reduction potential, N<sub>2</sub>O and CH<sub>4</sub> emissions, cross-media effects (use of energy and water, odour, noise, dust), applicability, operability, animal welfare and cost; all compared against a specific reference system.

### *Housing systems for pigs; mating/gestating sows*

Currently applied housing systems for mating/gestating sows are:

- fully-slatted floors, artificial ventilation and underlying deep collection pit (Note: this is the reference system)
- fully- or partly-slatted floors with a vacuum system underneath for frequent slurry removal
- fully- or partly-slatted floors with flush canals underneath the floor and where flushing is done with fresh slurry or with slurry that is aerated
- fully- or partly-slatted floors with flush gutters/tubes underneath and where flushing is done with fresh slurry or with slurry that is aerated
- partly-slatted floors with a reduced manure pit underneath
- partly-slatted floors with manure surface cooling fins
- partly-slatted floors with a manure scraper
- solid concrete floor with full litter
- solid concrete floor with straw and electronic feeders.

Currently mating and gestating sows can be housed either individually or in a group. However, EU legislation on pig welfare (91/630/EEC) provides minimum standards for the protection of pigs and will require sows and gilts to be kept in groups, from 4 weeks after service to 1 week before the expected time of farrowing, for new or rebuilt houses from 1 January 2003, and from 1 January 2013 for existing housing.

Group-housing systems require different feeding systems (e.g. electronic sow feeders) to individual housing systems, as well as a pen design that influences sow behaviour (i.e. the use of dunging- and lying areas). However, from an environmental point of view, the submitted data seems to indicate that group-housing systems have similar emission levels to individual housing systems, if similar emission reduction techniques are applied.

In the same EU legislation on pig welfare as mentioned above (Council Directive 2001/88/EC amending 91/630/EEC), requirements for flooring surfaces are included. For gilts and pregnant sows, a specified part of the floor area must be continuous solid floor of which a maximum of 15 % is reserved for drainage openings. These new provisions apply to all newly built or rebuilt holdings from 1 January 2003, and to all holdings from 1 January 2013. The effect of these new flooring arrangements on emissions compared to a typical existing fully slatted floor (which is the reference system) has not been investigated. The maximum 15 % void for drainage in the continuous solid floor area is less than the 20 % void for the concrete slatted floor area in the new provisions (a maximum 20 mm gap and a minimum slat width of 80 mm for sows and gilts). Therefore the overall effect is to reduce the void area.

In the assessment on BAT on housing systems, techniques are compared against the reference system used for the housing of mating and gestating sows, which is a deep pit under a fully-slatted floor with concrete slats. The slurry is removed at frequent or infrequent intervals. Artificial ventilation removes gaseous components emitted by the stored slurry manure. The system has been applied commonly throughout Europe. Regarding housing systems for mating/gestating sows, BAT is to have:

- fully- or partly-slatted floors with a vacuum system underneath for frequent slurry removal, or
- partly-slatted floors and a reduced manure pit.

It is generally accepted that concrete slats give more ammonia emissions than metal or plastic slats. However, for the BAT mentioned above no information was available on the effect of different slats on the emissions or costs.

New to build housing systems with a fully- or partly-slatted floor and flush gutters or tubes underneath and flushing is applied with non-aerated liquid are conditional BAT. In instances where the peak in odour, due to the flushing, is not expected to give nuisance to neighbours

these techniques are BAT for new to build systems. In instances where this technique is already in place, it is BAT (without condition).

A housing system with manure surface cooling fins using a closed system with heating pumps performs well but is a very costly system. Therefore manure surface cooling fins are not BAT for new to build housing systems, but when it is already in place, it is BAT. In retrofit situations this technique can be economically viable and thus can be BAT as well, but this has to be decided on a case by case basis.

Partly-slatted floor systems with a manure scraper underneath generally perform well, but the operability is difficult. Therefore a manure scraper is not BAT for new to build housing systems, but it is BAT when the technique is already in place.

Fully- or partly-slatted floor systems and flushing gutters or tubes underneath with flushing applied with non-aerated liquid is, as already mentioned earlier, BAT when it is already in place. The same technique operated with aerated liquid is not BAT for new to build housing systems because of odour peaks, energy consumption and operability. However, in instances where this technique is already in place, it is BAT.

### **Split view:**

One Member State supports the conclusions on BAT, but in their view the following techniques are also BAT in instances where the techniques are already in place and are also BAT when an extension (by means of a new building) is planned to operate with the same system (instead of two different systems):

- fully- or partly-slatted floors with flushing of a permanent slurry layer in channels underneath with non-aerated or aerated liquid.

These systems, often applied in this Member State, can achieve a higher ammonia emission reduction than those systems previously identified as BAT or conditional BAT. The argument then is that the high cost of retrofitting existing systems by any of these BATs is not justified. When an extension is added, for example by means of a new building, to a plant already adopting these systems, implementation of BAT or conditional BAT would reduce operability by making the operator use two different systems at the same farm. Therefore, the Member State considers these systems are BAT because of their good emission reduction capability, their operability and cost considerations.

On systems using litter very variable emission reduction potentials are reported to date, and further data must be acquired to allow better guidance on what is BAT for litter based systems. However, the TWG concluded that when litter is used, along with good practices such as having enough litter, changing the litter frequently, designing the pen floor suitably, and creating functional areas, then they cannot be excluded as BAT.

### ***Housing systems for pigs; growers/finishers***

Currently applied housing systems for growers/finishers are:

- fully-slatted floors, artificial ventilation and underlying deep collection pit (Note: this is the reference system)
- fully- or partly-slatted floors with a vacuum system underneath for frequent slurry removal
- fully- or partly-slatted floors with flush canals underneath and where flushing is done with fresh slurry or with slurry that is aerated
- fully- or partly-slatted floors with flush gutters/tubes underneath and where flushing is done with fresh slurry or with slurry that is aerated
- partly-slatted floors with a reduced manure pit underneath
- partly-slatted floors with manure surface cooling fins
- partly-slatted floors with a manure scraper

- partly-slatted floors with a central convex solid floor or an inclined solid floor at the front of the pen, a manure channel with slanted side walls and a sloped manure pit
- partly-slatted floors with a reduced manure pit, including slanted walls and a vacuum system
- partly-slatted floor with fast removal of slurry and littered external alley
- partly-slatted floor with a covered box
- solid concrete floor with full litter and outdoor climate
- solid concrete floor with a littered external alley and a straw flow system.

Growers/finishers are always housed in a group and most of the systems for the group housing of sows apply here as well. In the assessment on BAT on housing systems, techniques are compared against the reference system used for the housing of growers/finishers, which is a fully-slatted floor with a deep manure pit underneath and mechanical ventilation. On housing systems for growers/finishers, BAT is:

- a fully-slatted floor with a vacuum system for frequent removal, or
- a partly-slatted floor with a reduced manure pit, including slanted walls and a vacuum system, or
- a partly-slatted floor with a central, convex solid floor or an inclined solid floor at the front of the pen, a manure gutter with slanted sidewalls and a sloped manure pit.

It is generally accepted that concrete slats give more ammonia emissions than metal or plastic slats. However, the reported emission data show only a difference of 6 %, but costs are significantly higher. Metal slats are not allowed in every Member State, and they are not suitable for very heavy pigs.

New to build housing systems with a fully- or partly-slatted floor and flush gutters or tubes underneath and where flushing is applied with non-aerated liquid are conditional BAT. In instances where the peak in odour, due to the flushing, is not expected to give nuisance to neighbours these techniques are BAT for new to build systems. In instances where this technique is already in place, it is BAT (without condition).

A housing system with manure surface cooling fins using a closed system with heating pumps performs well but is a very costly system. Therefore manure surface cooling fins are not BAT for new to build housing systems, but when it is already in place, it is BAT. In retrofit situations this technique can be economically viable and thus can be BAT as well, but this has to be decided on a case by case basis. It has to be noted that energy efficiency can be lower in situations where the heat that arises from the cooling is not used, for example because there are no weaners to be kept warm.

Partly-slatted floor systems with a manure scraper underneath generally perform well, but the operability is difficult. Therefore a manure scraper is not BAT for new to build housing systems, but it is BAT when the technique is already in place.

Fully- or partly-slatted floor systems and flushing gutters or tubes underneath with flushing applied with non-aerated liquid is, as already mentioned earlier, BAT when it is already in place. The same technique operated with aerated liquid is not BAT for new to build housing systems because of odour peaks, energy consumption and operability. However, in instances where this technique is already in place, it is BAT.

#### **Split view:**

One Member State supports the conclusions on BAT, but for the same reason and using the same arguments as mentioned earlier on the housing for mating/gestating sows, in their view the following techniques are also BAT:

- a fully- or partly-slatted floor with flushing of a permanent slurry layer in channels underneath with non-aerated or aerated liquid.

On systems using litter very variable emission reduction potentials are reported to date, and further data must be acquired to allow better guidance on what is BAT for litter based systems. However, the TWG concluded that when litter is used, along with good practices such as having enough litter, changing the litter frequently, designing the pen floor suitably, and creating functional areas, then they cannot be excluded as BAT. The following system is an example of what may be BAT:

- solid concrete floors with a littered external alley and a straw flow system.

### *Housing systems for pigs; farrowing sows*

Currently applied housing systems for farrowing sows are:

- crates with fully-slatted floors and underlying deep collection pit (which is the reference)
- crates with fully-slatted floors and a board on a slope underneath
- crates with fully-slatted floors and a combination of a water and manure channel underneath
- crates with fully-slatted floors and a flushing system with manure gutters underneath
- crates with fully-slatted floors and manure pan underneath
- crates with fully-slatted floors and manure surface cooling fins
- crates with partly-slatted floors
- crates with partly-slatted floors and a manure scraper

Farrowing sows in Europe are generally housed in crates with iron and/or plastic slatted floors. In the majority of the houses sows are confined in their movement, with piglets walking around freely. Most houses have controlled ventilation and often a heated area for the piglets during the first few days. This system with a deep manure pit underneath is the reference system.

The difference between fully- and partly-slatted floors is not so distinct in the case of farrowing sows, where the sow is confined in its movement. In both cases dunging takes place in the same slatted area. Reduction techniques therefore focus predominantly on alterations to the manure pit.

BAT is a crate with a fully-slatted iron or plastic floor and with a:

- combination of a water and manure channel, or
- flushing system with manure gutters, or
- manure pan underneath.

A housing system with manure surface cooling fins using a closed system with heating pumps performs well but is a very costly system. Therefore manure surface cooling fins are not BAT for new to build housing systems, but when it is already in place, it is BAT. In retrofit situations this technique can be economically viable and thus can be BAT as well, but this has to be decided on a case by case basis.

Crates with a partly-slatted floor and a manure scraper underneath generally perform well, but the operability is difficult. Therefore a manure scraper is not BAT for new to build housing systems, but it is BAT when the technique is already in place.

For new installations the following techniques are not BAT:

- crates with a partly-slatted floor and a reduced manure pit, and
- crates with a fully-slatted floor and a board on a slope.

However, when these techniques are already in place it is BAT. It has to be noted that with the latter system flies can easily develop if no control measures are undertaken.

Data must be acquired to allow better guidance on what is BAT for litter based systems. However, the TWG concluded that when litter is used, along with good practices such as having enough litter, changing the litter frequently, and designing the pen floor suitably then they cannot be excluded as BAT.

*Housing systems for pigs; weaners*

Currently applied housing systems for weaners are:

- pens or flatdecks with fully-slatted floors and an underlying deep collection pit (reference)
- pens or flatdecks with fully- or partly-slatted floors and a vacuum system for frequent slurry removal
- pens or flatdecks with fully-slatted floors and a concrete sloped floor to separate faeces and urine
- pens or flatdecks with fully-slatted floors and a manure pit with scraper
- pens or flatdecks with fully-slatted floors and flush gutters/tubes underneath, where flushing is done with fresh slurry or with slurry that is aerated
- pens with partly-slatted floors; the two-climate system
- pens with partly-slatted floors and a sloped or convex solid floor
- pens with partly-slatted floors and a shallow manure pit and a channel for spoiled drinking water
- pens with partly-slatted floors with triangular iron slats and manure channel with gutters
- pens with partly-slatted floors and manure scraper
- pens with partly-slatted floors with triangular iron slats and a manure channel with sloped side wall(s)
- pens with partly-slatted floors and manure surface cooling fins
- partly-slatted floors with triangular slats and a covered box
- solid concrete floors with straw and natural ventilation.

Weaners are housed in a group in pens or flatdecks. In principle, manure removal is the same for a pen as for a flatdeck (raised pen) design. The reference system is a pen or flatdeck with a fully-slatted floor made of plastic or metal slats and a deep manure pit.

It is assumed, that in principle, reduction measures applicable to conventional weaner pens can also be applied to the flatdeck, but experiences with such a change have not been reported.

BAT is a pen:

- or flatdeck with a fully-slatted- or partly-slatted floor with a vacuum system for frequent slurry removal, or
- or flatdeck with a fully-slatted floor beneath which there is a concrete sloped floor to separate faeces and urine, or
- with a partly-slatted floor (two-climate system), or
- with a partly-slatted iron or plastic floor and a sloped or convex solid floor, or
- with a partly-slatted floor with metal or plastic slats and a shallow manure pit and channel for spoiled drinking water, or
- with a partly-slatted floor with triangular iron slats and a manure channel with sloped side walls.

New to build housing systems with a fully-slatted floor and flush gutters or tubes underneath and where flushing is applied with non-aerated liquid are conditional BAT. In instances where the peak in odour, due to the flushing, is not expected to give nuisance to neighbours these techniques are BAT for new to build systems. In instances where this technique is already in place, it is BAT (without condition).

A housing system with manure surface cooling fins using a closed system with heating pumps performs well but is a very costly system. Therefore manure surface cooling fins are not BAT for new to build housing systems, but when it is already in place, it is BAT. In retrofit situations this technique can be economically viable and thus can be BAT as well, but this has to be decided on a case by case basis.

## **Executive Summary**

---

Fully-slatted and partly-slatted floor systems with a manure scraper generally perform well, but the operability is difficult. Therefore a manure scraper is not BAT for new to build housing systems, but it is BAT when the technique is already in place.

Weaners are also kept on solid concrete floors with part- or full litter. No ammonia emission data is reported for these systems. However, the TWG concluded that when litter is used, along with good practices such as, having enough litter, changing the litter frequently, and designing the pen floor suitably, then they cannot be excluded as BAT.

The following system is an example of what is BAT:

- a natural ventilated pen with a fully littered floor.

### ***Water for pigs and poultry***

In the rearing of pigs and poultry water is used for cleaning activities and for watering the animals. Reduction of the animals' water consumption is not considered to be practical. It will vary in accordance with their diet and, although some production strategies include restricted water access, permanent access to water is generally considered to be an obligation.

In principle three types of animal drinking systems are applied: low capacity nipple drinkers or high capacity drinkers with a drip-cup, water troughs and round drinkers for poultry, and for pigs these are: nipple drinkers in a trough or cup, water troughs and biting nipples. All of these have some advantages and some disadvantages. However, there is not enough data available to come to a BAT conclusion.

On activities where water is used, it is BAT to reduce water use by doing all of the following:

- cleaning animal housing and equipment with high-pressure cleaners after each production cycle or each batch. For pig housing, typically wash-down water enters the slurry system and therefore it is important to find a balance between cleanliness and using as little water as possible. In poultry housing it is also important to find the balance between cleanliness and using as little water as possible
- carry out a regular calibration of the drinking-water installation to avoid spill
- keeping record of water use through metering of consumption, and
- detecting and repairing leakages.

### ***Energy for pigs and poultry***

In the rearing of pigs and poultry, the information on the use of energy focuses on heating and ventilating the housing systems.

BAT for pigs and poultry is to reduce energy use by application of good farming practice starting with animal housing design and by adequate operation and maintenance of the housing and the equipment.

There are many actions that can be taken as part of the daily routine to reduce the amount of energy required for heating and ventilation. Many of these points are mentioned in the main body of the document. Some specific BAT measures are mentioned below:

BAT for poultry housing is to reduce energy use by doing all of the following:

- insulating buildings in regions with low ambient temperatures (U-value 0.4 W/m<sup>2</sup>/°C or better)
- optimising the design of the ventilation system in each house to provide good temperature control and to achieve minimum ventilation rates in winter
- avoiding resistance in ventilation systems through frequent inspection and cleaning of ducts and fans, and
- applying low energy lighting.



BAT for pig housing is to reduce energy use by doing all of the following:

- applying natural ventilation where possible; this needs proper design of the building and of the pens (i.e. microclimate in the pens) and spatial planning with respect to the prevailing wind directions to enhance the airflow; this applies only to new housing
- for mechanically ventilated houses: optimising the design of the ventilation system in each house to provide good temperature control and to achieve minimum ventilation rates in winter
- for mechanically ventilated houses: avoiding resistance in ventilation systems through frequent inspection and cleaning of ducts and fans, and
- applying low energy lighting.

### *Storage of manure from pigs and poultry*

The Nitrates Directive lays down minimum provisions on storage of manure in general with the aim of providing all waters a general level of protection against pollution, and additional provisions on storage of manure in designated Nitrate Vulnerable Zones. Not all provisions in this Directive are addressed in this document because of a lack of data, but where they are addressed, the TWG agreed that BAT for slurry storage tanks, solid manure heaps or slurry lagoons is equally valid inside and outside these designated Nitrate Vulnerable Zones.

BAT is to design storage facilities for pig and poultry manure with sufficient capacity until further treatment or application to land can be carried out. The required capacity depends on the climate and the periods in which application to land is not possible. For pig manure, for example, the capacity can differ from the manure that is produced on a farm over a 4 – 5 month period in Mediterranean climate, a 7 – 8 month period in the Atlantic or continental conditions, to a 9 – 12 month period in boreal areas. For poultry manure the required capacity depends on the climate and the periods in which application to land is not possible

For a stack of pig manure that is always situated on the same place, either on the installation or in the field, BAT is to:

- apply a concrete floor, with a collection system and a tank for run-off liquid, and
- locate any new to build manure storage areas where they are least likely to cause annoyance to sensitive receptors for odour, taking into account the distance to receptors and the prevailing wind direction.

If poultry manure needs to be stored, BAT is to store dried poultry manure in a barn with an impermeable floor, and with sufficient ventilation.

For a temporary stack of pig or poultry manure in the field, BAT is to position the manure heap away from sensitive receptors such as, neighbours, and watercourses (including field drains) that liquid run-off might enter.

BAT on the storage of pig slurry in a concrete or steel tank comprises all of the following:

- a stable tank able to withstand likely mechanical, thermal and chemical influences
- the base and walls of the tank are impermeable and protected against corrosion
- the store is emptied regularly for inspection and maintenance, preferably every year
- double valves are used on any valved outlet from the store
- the slurry is stirred only just before emptying the tank for, e.g., application on land.

It is BAT to cover slurry tanks using one of the following options:

- a rigid lid, roof or tent structure, or
- a floating cover, such as chopped straw, natural crust, canvas, foil, peat, light expanded clay aggregate (LECA) or expanded polystyrene (EPS).

All of these types of covers are applied but have their technical and operational limitations. This means that the decision on what type of cover is preferred can only be taken on a case by case basis.

A lagoon used for storing slurry is equally as viable as a slurry tank, providing it has impermeable base and walls (sufficient clay content or lined with plastic) in combination with leakage detection and provisions for a cover.

It is BAT to cover lagoons where slurry is stored using one of the following options:

- a plastic cover, or
- a floating cover, such as chopped straw, LECA or natural crust.

All these types of covers are applied but have their technical and operational limitations. This means that the decision on what type of cover is preferred can only be taken on a case by case basis. In some situations it might be very costly, or technically not even possible to install a cover to an existing lagoon. The cost for installing a cover for very large lagoons or lagoons that have unusual shapes can be high. It might technically be impossible to install a cover when, for example, embankment profiles are not suitable to attach the cover to.

### ***On-farm treatment of manure from pigs and poultry***

Manure treatment prior to or instead of land spreading may be performed for the following reasons:

1. to recover the residual energy (biogas) in the manure
2. to reduce odour emissions during storage and/or land spreading
3. to decrease the nitrogen content of the manure, with the aim of preventing possible ground and surface water pollution as a result of land spreading and to reduce odour
4. to allow easy and safe transportation of the manure to distant regions or when it has to be applied in other processes.

A number of manure treatment systems is applied, although the majority of farms in the EU are able to manage manure without recourse to the techniques listed below. Besides treatment on-farm, pig and poultry manure may also be (further) treated off-site in industrial installations such as, poultry litter combustion, composting or drying. The assessment of off-site treatment is outside the scope of this BREF.

Applied techniques for the on-farm treatment of pig and or poultry manure are:

- mechanical separation
- aeration of liquid manure
- biological treatment of pig slurry
- composting of solid manure
- composting of poultry manure with pine bark
- anaerobic treatment of manure
- anaerobic lagoons
- evaporation and drying of pig slurry
- incineration of broiler manure
- applying additives to manure

In general, on-farm processing of manure is BAT only under certain conditions (i.e. is a conditional BAT). The conditions of on-farm manure processing that determine if a technique is BAT relate to conditions such as the availability of land, local nutrient excess or demand, technical assistance, marketing possibilities for green energy, and local regulations.

The following Table 2 gives some examples on the conditions for BAT for pig manure processing. The list is not exhaustive and other techniques may also be BAT under certain conditions. It is also possible that the chosen techniques are also BAT under other conditions.

<b>Under the following conditions</b>	<b>an example of what is BAT:</b>
<ul style="list-style-type: none"> <li>the farm is situated in an area with nutrient surplus but with sufficient land in the vicinity of the farm to spread the liquid fraction (with decreased nutrient content), and</li> <li>the solid fraction can be spread on remote areas with a nutrient demand or can be applied in other processes</li> </ul>	mechanical separation of pig slurry using a closed system (e.g. centrifuge or press-auger) to minimise the ammonia emissions (Section 4.9.1)
<ul style="list-style-type: none"> <li>the farm is situated in an area with nutrient surplus but with sufficient land in the vicinity of farm to spread treated liquid fraction, and</li> <li>the solid fraction can be spread on remote areas with a nutrient demand, and</li> <li>the farmer gets technical assistance for running the aerobic treatment installation properly</li> </ul>	mechanical separation of pig slurry using a closed system (e.g. centrifuge or press-auger) to minimise the ammonia emissions, followed by aerobic treatment of the liquid fraction (Section 4.9.3.) and where the aerobic treatment is well-controlled so that ammonia and N <sub>2</sub> O production are minimised
<ul style="list-style-type: none"> <li>there is a market for green energy, and</li> <li>local regulations allow co-fermentation of (other) organic waste products and land spreading of digested products</li> </ul>	anaerobic treatment of manure in a biogas installation (Section 4.9.6.)

**Table 2: Examples of conditional BAT on on-farm pig manure processing**

An example of a conditional BAT on poultry manure processing is:

- applying an external drying tunnel with perforated manure belts, when the housing system for layers does not incorporate a manure drying system or another technique for reducing ammonia emissions.

### ***Landspreading of manure from pigs and poultry***

#### ***General***

The Nitrate Directive lays down minimum provisions on the application of manure to land with the aim of providing all waters a general level of protection against pollution from nitrogen compounds, and additional provisions for applying manure to land in designated vulnerable zones. Not all provisions in this Directive are addressed in this document because of a lack of data, but when they are addressed, the TWG agreed that BAT on landspreading is equally valid inside and outside these designated vulnerable zones.

There are different stages in the process, from pre-production of the manure, to post-production and finally spreading on land, where emissions can be reduced and/or controlled. The different techniques that are BAT and that can be applied at the different stages in the process are listed below. However, the principle of BAT is based on doing all the following four actions:

- applying nutritional measures
- balancing the manure that is going to be spread with the available land and crop requirements and – if applied – with other fertilisers
- managing the landspreading of manure, and
- only using the techniques that are BAT for the spreading of manure on land and – if applicable – finishing off.

BAT is to minimise emissions from manure to soil and groundwater by balancing the amount of manure with the foreseeable requirements of the crop (nitrogen and phosphorus, and the mineral supply to the crop from the soil and from fertilisation). Different tools are available to balance the total nutrient uptake by soil and vegetation against the total nutrient output of the manure, such as a soil nutrient balance or by rating the number of animals to the available land.

BAT is to take into account the characteristics of the land concerned when applying manure; in particular soil conditions, soil type and slope, climatic conditions, rainfall and irrigation, land use and agricultural practices, including crop rotation systems. BAT is to reduce pollution of water by doing in particular all of the following:

- not applying manure to land when the field is:
  - water-saturated
  - flooded
  - frozen
  - snow covered
- not applying manure to steeply sloping fields
- not applying manure adjacent to any watercourse (leaving an untreated strip of land), and
- spreading the manure as close as possible before maximum crop growth and nutrient uptake occur.

BAT is managing the landspreading of manure to reduce odour nuisance where neighbours are likely to be affected, by doing in particular all of the following:

- spreading during the day when people are less likely to be at home and avoiding weekends and public holidays, and
- paying attention to wind direction in relation to neighbouring houses.

Manure can be treated to minimise odour emissions which can then allow more flexibility for identifying suitable sites and weather conditions for land application.

### Pig manure

The emissions of ammonia to air caused by the landspreading can be reduced through the selection of the right equipment. The reference technique is a conventional broadcast spreader, not followed by fast incorporation. Generally, landspreading techniques that reduce ammonia emissions also reduce odour emissions.

Each technique has its limitations and is not applicable in all circumstances and/or on all types of land. Techniques that inject slurry show the highest reduction, but techniques that spread slurry on top of the soil followed by incorporation shortly afterwards can achieve the same reduction. However, this requires extra labour and energy (costs) and only applies to arable land that can easily be cultivated. BAT conclusions are shown in Table 3. The achieved levels are very site-specific and serve only as an illustration of potential reductions.

The majority of the TWG agreed that either injection or bandspreading and incorporation (if the land can be easily cultivated) within 4 hours is BAT for applying slurry to arable land, however there was a split view on this conclusion (see below).

The TWG also agreed that, for applying slurry to land, the conventional broadcast spreader is not BAT. However, four Member States proposed that where broadcasting is operated with a low spread trajectory, and at low pressure (to create large droplets; thereby avoiding atomisation and wind drift), and slurry is incorporated into the soil as soon as possible (at least within 6 hours), or is applied to a growing arable crop, these combinations are BAT. The TWG has not reached consensus on this latter proposal.

No reduction techniques for the spreading of solid pig manure have been proposed. However, for reducing ammonia emissions from the landspreading of solid manure, incorporation is the important factor not the technique on how to spread. For grassland, incorporation is not possible.

**Split views:**

1. Two Member States do not support the conclusion that bandspreading of pig slurry on arable land followed by incorporation is BAT. In their view applying bandspreading on its own, which has an associated emission reduction of 30 – 40 % is BAT for spreading pig slurry on arable land. Their argument is that bandspreading already achieves a reasonable emission reduction and that the extra handling required for incorporation is difficult to organise and the extra reduction that can be achieved does not outweigh the extra costs.
2. Another split view on incorporation involves solid pig manure. Two Member States do not support the conclusion that incorporation of solid pig manure as soon as possible (at least within 12 hours), is BAT. In their view incorporation within 24 hours, which has an associated emission reduction of around 50 %, is BAT. Their argument is that the extra ammonia emission reduction that can be achieved does not outweigh the extra costs and difficulties involved in organising the logistics for incorporation within a shorter time.

Land use	BAT	Emission reduction	Type of manure	Applicability
grassland and land with <u>crop height</u> below 30 cm	trailing hose (bandspreading)	30 % this may be less if applied on grass height >10 cm	slurry	slope (<15 % for tankers; <25 % for umbilical systems); not for slurry that is viscous or has a high straw content, size and shape of the field are important
mainly grassland	trailing shoe (bandspreading)	40 %	slurry	slope (<20 % for tankers; <30 % for umbilical systems); not viscous slurry, size and shape of the field, grass less than 8 cm high
grassland	shallow injection (open slot)	60 %	slurry	slope <12 %, greater limitations for soil type and conditions, not viscous slurry
mainly grassland, arable land	deep injection (closed slot)	80 %	slurry	slope <12 %, greater limitations for soil type and conditions, not viscous slurry
arable land	bandspreading and incorporation within 4 hours	80 %	slurry	incorporation is only applicable for land that can be easily cultivated, in other situations BAT is bandspreading without incorporation
arable land	incorporation as soon as possible, but at least within 12 hours	within: 4 hrs: 80 % 12 hrs: 60 – 70 %	solid pig manure	only for land that can be easily cultivated

**Table 3: BAT on landspreading equipment for pig manure**Poultry manure

Poultry manure has a high available nitrogen content and it is therefore important to get an even spread distribution and an accurate application rate. In this respect the rota-spreader type is poor. The rear-discharge spreader and dual-purpose spreader are much better. For wet poultry manure (<20 % dm) from caged systems, such as described in Section 4.5.1.4, broadcasting with a low trajectory at low pressure is the only applicable spreading technique. However, no conclusion about which spreading technique is BAT has been drawn. For reducing ammonia emissions from landspreading poultry manure, incorporation is the important factor not the technique on how to spread. For grassland, incorporation is not possible.

BAT on landspreading – wet or dry – solid poultry manure is incorporation within 12 hours. Incorporation can only be applied to arable land that can be easily cultivated. The achievable emission reduction is 90 %, but this is very site-specific and serves only as an illustration of a potential reduction.

### **Split view:**

Two Member States do not support the conclusion that incorporation of solid poultry manure within 12 hours is BAT. In their view incorporation within 24 hours, which has an associated ammonia emission reduction of around 60 – 70 %, is BAT. Their argument is that the extra ammonia emission reduction that can be achieved does not outweigh the extra costs and difficulties involved in organising the logistics for incorporation within a shorter time.

## **Concluding remarks**

A feature of this work is that the ammonia emission reduction potential, associated with the techniques described in Chapter 4, are given as relative reductions (in %) against a reference technique. This is done because consumption and emission levels of the livestock depend on many different factors, such as the animal breed, the variation in feed formulation, production phase and management system applied, but also on other factors such as climate and soil characteristics. The consequence of this is that the absolute ammonia emissions from applied techniques, such as the housing systems, the storage of manure, and manure application to land, will cover a very wide range and make interpretation of absolute levels difficult. Therefore, the use of ammonia-reduction levels expressed in percentages has been preferred.

### ***Level of consensus***

This BREF has the support of most of the TWG members, although on five BAT conclusions split views have to be noted. The first two split views concern a housing system used for mating/gestating sows and growers/finishers. The third split view is on the landspreading of pig slurry by using a bandspreader followed by incorporation. The fourth and fifth split views concern the time taken between the landspreading and the incorporation of solid pig and poultry manure. All five split views are fully described in this executive summary.

### ***Recommendations for future work***

For future BREF reviews, all TWG members and interested parties should continue to collect data, in a format that can be easily compared, on the current emission and consumption levels and on the performances of techniques to be considered in the determination of BAT. On monitoring, very little information was made available and this should be considered a key issue in the future review of the BREF. Some other specific areas where data and information are missing concern the following:

- enriched cage systems for layers
- turkeys, ducks and Guinea fowls
- the use of litter in pig housing
- the associated costs and feeding equipment for the multiphase feeding of pigs and poultry
- techniques for the on-farm processing of manure, this needs further qualification and quantification to allow a better assessment for BAT considerations
- the use of additives in manure
- noise, energy, waste water and waste
- issues such as the dry matter content of manure and irrigation
- quantification of distances to watercourses when spreading manure to land
- quantification of sloping fields when spreading manure to land
- sustainable drainage techniques.

Animal welfare has been considered in this document. However, it would be useful to develop assessment criteria regarding animal welfare aspects of housing systems.

***Suggested topics for future R&D projects***

Section 6.5 in the main body of the BREF shows a list of about thirty topics that could be considered as potential topics for future Research and Development projects.

The EC is launching and supporting, through its RTD programmes, a series of projects dealing with clean technologies, emerging effluent treatment and recycling technologies and management strategies. Potentially these projects could provide a useful contribution to future BREF reviews. Readers are therefore invited to inform the EIPPCB of any research results which are relevant to the scope of this document (see also the preface of this document).





---

## PREFACE

### 1. Status of this document

Unless otherwise stated, references to “the Directive” in this document means the Council Directive 96/61/EC on integrated pollution prevention and control. As the Directive applies without prejudice to Community provisions on health and safety at the workplace, so does this document.

This document forms part of a series presenting the results of an exchange of information between EU Member States and industries concerned on best available technique (BAT), associated monitoring, and developments in them. It is published by the European Commission pursuant to Article 16(2) of the Directive, and must therefore be taken into account in accordance with Annex IV of the Directive when determining “best available techniques”

### 2. Relevant legal obligations of the IPPC Directive and the definition of BAT

In order to help the reader understand the legal context in which this document has been drafted, some of the most relevant provisions of the IPPC Directive, including the definition of the term “best available techniques”, are described in this preface. This description is inevitably incomplete and is given for information only. It has no legal value and does not in any way alter or prejudice the actual provisions of the Directive.

The purpose of the Directive is to achieve integrated prevention and control of pollution arising from the activities listed in its Annex I, leading to a high level of protection of the environment as a whole. The legal basis of the Directive relates to environmental protection. Its implementation should also take account of other Community objectives such as the competitiveness of the Community’s industry thereby contributing to sustainable development.

More specifically, it provides for a permitting system for certain categories of industrial installations requiring both operators and regulators to take an integrated, overall look at the polluting and consuming potential of the installation. The overall aim of such an integrated approach must be to improve the management and control of industrial processes so as to ensure a high level of protection for the environment as a whole. Central to this approach is the general principle given in Article 3 that operators should take all appropriate preventative measures against pollution, in particular through the application of best available techniques enabling them to improve their environmental performance.

The term “best available techniques” is defined in Article 2(11) of the Directive as “the most effective and advanced stage in the development of activities and their methods of operation which indicate the practical suitability of particular techniques for providing in principle the basis for emission limit values designed to prevent and, where that is not practicable, generally to reduce emissions and the impact on the environment as a whole.” Article 2(11) goes on to clarify further this definition as follows:

“techniques” includes both the technology used and the way in which the installation is designed, built, maintained, operated and decommissioned;

“available” techniques are those developed on a scale which allows implementation in the relevant industrial sector, under economically and technically viable conditions, taking into consideration the costs and advantages, whether or not the techniques are used or produced inside the Member State in question, as long as they are reasonably accessible to the operator;

“best” means most effective in achieving a high general level of protection of the environment as a whole.

Furthermore, Annex IV of the Directive contains a list of “considerations to be taken into account generally or in specific cases when determining best available techniques ... bearing in mind the likely costs and benefits of a measure and the principles of precaution and prevention”. These considerations include the information published by the Commission pursuant to Article 16(2).

Competent authorities responsible for issuing permits are required to take account of the general principles set out in Article 3 when determining the conditions of the permit. These conditions must include emission limit values, supplemented or replaced where appropriate by equivalent parameters or technical measures. According to Article 9(4) of the Directive, these emission limit values, equivalent parameters and technical measures must, without prejudice to compliance with environmental quality standards, be based on the best available techniques, without prescribing the use of any technique or specific technology, but taking into account the technical characteristics of the installation concerned, its geographical location and the local environmental conditions. In all circumstances, the conditions of the permit must include provisions on the minimisation of long-distance or transboundary pollution and must ensure a high level of protection for the environment as a whole.

Member States have the obligation, according to Article 11 of the Directive, to ensure that competent authorities follow or are informed of developments in best available techniques.

### **3. Objective of this Document**

Article 16(2) of the Directive requires the Commission to organise “an exchange of information between Member States and the industries concerned on best available techniques, associated monitoring and developments in them”, and to publish the results of the exchange.

The purpose of the information exchange is given in recital 25 of the Directive, which states that “the development and exchange of information at Community level about best available techniques will help to redress the technological imbalances in the Community, will promote the worldwide dissemination of limit values and techniques used in the Community and will help the Member States in the efficient implementation of this Directive.”

The Commission (Environment DG) established an information exchange forum (IEF) to assist the work under Article 16(2) and a number of technical working groups have been established under the umbrella of the IEF. Both IEF and the technical working groups include representation from Member States and industry as required in Article 16(2).

The aim of this series of documents is to reflect accurately the exchange of information which has taken place as required by Article 16(2) and to provide reference information for the permitting authority to take into account when determining permit conditions. By providing relevant information concerning best available techniques, these documents should act as valuable tools to drive environmental performance.

### **4. Information Sources**

This document represents a summary of information collected from a number of sources, including in particular the expertise of the groups established to assist the Commission in its work, and verified by the Commission services. All contributions are gratefully acknowledged.

### **5. How to understand and use this document**

The information provided in this document is intended to be used as an input to the determination of BAT in specific cases. When determining BAT and setting BAT-based permit conditions, account should always be taken of the overall goal to achieve a high level of protection for the environment as a whole.

The rest of this section describes the type of information that is provided in each section of the document.

Chapter 1 provides general information at a European level on the agricultural sectors concerned. This includes economic data, consumption and production levels of eggs, poultry and pork as well as information on some legislative requirements.

In Chapter 2 the production systems and techniques are described that are commonly applied in Europe. This chapter provides the basis for the reference systems identified in Chapter 4 to assess the environmental performance of reduction techniques. It is not intended to describe only the reference techniques, nor can it cover all modifications of a technique that can be found in practice.

Chapter 3 provides data and information on current emission and consumption levels reflecting the situation in existing installations at the time of writing. It attempts to present the factors that account for the variation of consumption and emissions levels.

Chapter 4 describes the techniques that are considered to be most relevant for determining BAT and BAT-based permit conditions. This information includes consumption and emission levels considered achievable by using the technique, some idea of the costs and the cross-media effects associated with application, as well as the extent to which the technique is applicable to the range of installations requiring IPPC permits (e.g. new, existing, large or small installations). Techniques that are generally seen as obsolete are not included.

Chapter 5 presents the techniques and the emission and consumption levels that are considered to be compatible with BAT in a general sense. The purpose is thus to provide general indications regarding the emission and consumption levels that can be considered as an appropriate reference point to assist in the determination of BAT-based permit conditions or for the establishment of general binding rules under Article 9(8). It should be stressed, however, that this document does not propose emission limit values. The determination of appropriate permit conditions will involve taking account of local, site-specific factors such as the technical characteristics of the installation concerned, its geographical location and the local environmental conditions. In the case of existing installations, the economic and technical viability of upgrading them also needs to be taken into account. Even the single objective of ensuring a high level of protection for the environment as a whole will often involve making trade-off judgements between different types of environmental impact, and these judgements will often be influenced by local considerations.

Although an attempt is made to address some of these issues, it is not possible for them to be considered fully in this document. The techniques and levels presented in Chapter 5 will therefore not necessarily be appropriate for all installations. On the other hand, the obligation to ensure a high level of environmental protection including the minimisation of long-distance or transboundary pollution implies that permit conditions cannot be set on the basis of purely local considerations. It is therefore of the utmost importance that the information contained in this document is fully taken into account by permitting authorities.

Since the best available techniques change over time, this document will be reviewed and updated as appropriate. All comments and suggestions should be made to the European IPPC Bureau at the Institute for Prospective Technological Studies at the following address:

Edificio Expo; C/ Inca Garcilaso s/n; E-41092 Seville, Spain  
Telephone: +34 95 4488 284  
Fax: +34 95 4488 426  
e-mail: [eippcb@jrc.es](mailto:eippcb@jrc.es)  
Internet: <http://eippcb.jrc.es>

---

# Reference Document on Best Available Techniques for Intensive Rearing of Poultry and Pigs

<b>EXECUTIVE SUMMARY</b> .....	<b>I</b>
<b>PREFACE</b> .....	<b>XXIII</b>
<b>SCOPE OF WORK</b> .....	<b>XXXIX</b>
<b>1 GENERAL INFORMATION</b> .....	<b>1</b>
1.1 Intensive livestock farming .....	1
1.2 The poultry production sector in Europe.....	2
1.2.1 Egg production .....	3
1.2.2 Broiler production .....	5
1.2.3 Economics of the poultry sector .....	7
1.3 The pig production sector in Europe .....	10
1.3.1 Dimension, evolution and geographical distribution of the pig production sector in Europe .....	10
1.3.2 Production and consumption of pork .....	15
1.3.3 Economics of the pig sector .....	17
1.4 Environmental issues of intensive poultry and pig farming .....	18
1.4.1 Emissions to air .....	20
1.4.2 Emissions to soil, groundwater and surface water .....	22
1.4.3 Other emissions .....	24
<b>2 APPLIED PRODUCTION SYSTEMS AND TECHNIQUES</b> .....	<b>25</b>
2.1 Introduction.....	25
2.2 Poultry production.....	26
2.2.1 Production of eggs .....	26
2.2.1.1 Cage battery systems for laying hens.....	27
2.2.1.1.1 Battery system with open manure storage under the cages .....	29
2.2.1.1.2 Battery systems with aerated open manure storage (deep-pit or high-rise systems and canal house).....	29
2.2.1.1.3 Stilt house system.....	30
2.2.1.1.4 Battery system with manure removal by way of scrapers to a closed storage.....	31
2.2.1.1.5 Manure-belt battery with frequent removal of manure to a closed storage with or without drying. ....	31
2.2.1.1.6 Enriched cage .....	32
2.2.1.2 Non-cage housing systems for laying hens .....	34
2.2.1.2.1 Deep litter system for laying hens .....	34
2.2.1.2.2 Aviary system (perchery) .....	35
2.2.2 Production of broiler meat .....	35
2.2.3 Other poultry production sectors.....	36
2.2.3.1 Production of turkeys .....	36
2.2.3.1.1 Commonly applied housing systems .....	36
2.2.3.1.2 Closed house system .....	37
2.2.3.1.3 Partially ventilated littered floor system.....	38
2.2.3.2 Production of ducks .....	39
2.2.3.3 Production of guinea fowl.....	40
2.2.4 Control of poultry housing climate .....	40
2.2.4.1 Temperature control and ventilation .....	40
2.2.4.2 Illumination.....	43
2.2.5 Poultry feeding and watering .....	44
2.2.5.1 Poultry feed formulation .....	44
2.2.5.2 Feeding systems .....	45
2.2.5.3 Drinking water supply systems .....	46
2.3 Pig production.....	47
2.3.1 Pig housing and manure collection .....	47
2.3.1.1 Housing systems for mating and gestating sows.....	49
2.3.1.1.1 Individual housing with a fully or partly-slatted floor for mating and gestating sows .....	50
2.3.1.1.2 Sow crates with a solid floor for mating and gestating sows.....	50
2.3.1.1.3 Group housing with or without straw for gestating sows .....	51
2.3.1.2 Housing systems for farrowing sows .....	52

2.3.1.2.1	Housing for farrowing sows with confined movement.....	52
2.3.1.2.2	Housing of farrowing sows allowing sow movement.....	54
2.3.1.3	Housing systems for weaners .....	54
2.3.1.4	Housing of growers-finishers .....	57
2.3.1.4.1	Housing of growers-finishers on a fully-slatted floor.....	57
2.3.1.4.2	Housing of growers/finishers on a partly-slatted floor .....	58
2.3.1.4.3	Housing of growers-finishers on a solid concrete floor and straw.....	59
2.3.2	Control of pig housing climate .....	61
2.3.2.1	Heating of pig housing .....	62
2.3.2.2	Ventilation of pig housing .....	63
2.3.2.3	Illumination of pig housing .....	66
2.3.3	Pig feeding and watering systems.....	67
2.3.3.1	Pig feed formulation.....	67
2.3.3.2	Feeding systems .....	68
2.3.3.3	Drinking water supply systems.....	70
2.4	Processing and storage of animal feed.....	70
2.5	Collection and storage of manure .....	71
2.5.1	Poultry manure .....	73
2.5.2	Pig manure.....	73
2.5.3	Storage systems for solid and litter based manure (FYM).....	74
2.5.4	Storage systems for slurry .....	75
2.5.4.1	Slurry storage in tanks .....	75
2.5.4.2	Slurry storage in earth-banked stores or lagoons.....	76
2.5.4.3	Slurry storage in flexible bags .....	77
2.6	On-farm manure processing .....	77
2.6.1	Mechanical separators .....	78
2.6.2	Aerobic treatment of liquid manure.....	78
2.6.3	Aerobic treatment of solid manure (composting).....	79
2.6.4	Anaerobic treatment .....	79
2.6.5	Anaerobic lagoons .....	79
2.6.6	Pig manure additives .....	80
2.6.7	Impregnation with peat.....	82
2.7	Manure application techniques .....	83
2.7.1	Slurry transport systems .....	84
2.7.1.1	Vacuum tanker .....	84
2.7.1.2	Pumped tanker.....	84
2.7.1.3	Umbilical hose.....	84
2.7.1.4	Irrigator.....	84
2.7.2	Slurry application systems.....	85
2.7.2.1	Broadcast spreader .....	85
2.7.2.2	Band spreader.....	87
2.7.2.3	Trailing shoe spreader .....	87
2.7.2.4	Injector (open slot) .....	88
2.7.2.5	Injector (closed slot).....	88
2.7.2.6	Incorporation .....	89
2.7.3	Solid manure application systems .....	90
2.8	Transport on-farm.....	91
2.9	Maintenance and cleaning .....	91
2.10	Use and disposal of residues.....	92
2.11	Storage and disposal of carcasses.....	93
2.12	Treatment of waste water.....	93
2.13	Installations for heat and power production .....	94
2.14	Monitoring and control of consumption and emission .....	94
<b>3</b>	<b>CONSUMPTION AND EMISSION LEVELS OF INTENSIVE POULTRY AND PIG FARMS</b> .....	<b>97</b>
3.1	Introduction .....	97
3.2	Consumption levels .....	98
3.2.1	Feed consumption and nutritional levels .....	98
3.2.1.1	Poultry feeding .....	99
3.2.1.2	Pig feeding.....	100
3.2.2	Water consumption.....	104
3.2.2.1	Water requirements of poultry farms.....	104

3.2.2.1.1	Animal consumption .....	104
3.2.2.1.2	Use of cleaning water .....	105
3.2.2.2	Water requirements of pig farms.....	105
3.2.2.2.1	Animal consumption .....	105
3.2.2.2.2	Use of cleaning water .....	107
3.2.3	Energy consumption .....	107
3.2.3.1	Poultry farms.....	108
3.2.3.2	Pig farms .....	109
3.2.4	Other inputs.....	111
3.2.4.1	Bedding (litter).....	111
3.2.4.2	Cleaning material .....	112
3.3	Emission levels .....	112
3.3.1	Excretion of manure.....	113
3.3.1.1	Levels of excretion and characteristics of poultry manure.....	113
3.3.1.2	Levels of excretion and characteristics of pig manure .....	116
3.3.2	Emissions from housing systems .....	120
3.3.2.1	Emissions from poultry housing .....	120
3.3.2.2	Emissions from pig housing.....	121
3.3.3	Emissions from external manure storage facilities.....	122
3.3.4	Emissions from manure treatment.....	122
3.3.5	Emissions from landspreading .....	123
3.3.5.1	Emissions to air.....	123
3.3.5.2	Emissions to soil and groundwater .....	124
3.3.5.3	Emissions N, P and K to surface water .....	125
3.3.5.4	Emissions of heavy metals.....	125
3.3.6	Emissions of odour.....	127
3.3.7	Noise .....	127
3.3.7.1	Sources and emissions on poultry farms .....	128
3.3.7.2	Sources and emissions on pig farms .....	129
3.3.8	Quantification of other emissions .....	129
<b>4</b>	<b>TECHNIQUES TO CONSIDER IN THE DETERMINATION OF BAT.....</b>	<b>131</b>
4.1	Good agricultural practice for environmental management .....	132
4.1.1	Site selection and spatial aspects.....	133
4.1.2	Education and training .....	133
4.1.3	Planning activities .....	133
4.1.4	Monitoring .....	134
4.1.5	Emergency planning .....	134
4.1.6	Repair and maintenance .....	135
4.2	Nutritional management.....	135
4.2.1	General approach .....	135
4.2.2	Phase feeding .....	141
4.2.3	Addition of amino acids to make low-protein, amino acid-supplemented diets for poultry and pigs.....	143
4.2.4	Addition of phytase to make low phosphorus, phytase supplemented diets for poultry and pigs.....	146
4.2.5	Highly digestible inorganic feed phosphates.....	148
4.2.6	Other feed additives .....	149
4.3	Techniques for the efficient use of water .....	150
4.4	Techniques for the efficient use of energy .....	151
4.4.1	Good practice for the efficient use of energy on poultry farms.....	152
4.4.1.1	Fuels for heating .....	152
4.4.1.2	Electricity.....	153
4.4.1.3	Low-energy illumination.....	155
4.4.1.4	Heat recovery in broiler housing with heated and cooled littered floor (combideck system).....	156
4.4.2	Good practice for the efficient use of energy on pig farms.....	159
4.5	Techniques for the reduction of emissions from poultry housing .....	161
4.5.1	Techniques for cage housing of laying hens .....	161
4.5.1.1	Cage systems with aerated open manure storage (deep-pit or high rise systems and canal house).....	164
4.5.1.2	Cage system in a stilt house .....	165
4.5.1.3	Cage system with manure removal by way of scrapers to a closed storage .....	165

4.5.1.4	Cage system with manure removal by way of manure belts to a closed storage .....	166
4.5.1.5	Vertical tiered cages with manure belts and manure drying.....	167
4.5.1.5.1	Vertical tiered cages with manure belts with forced air drying .....	167
4.5.1.5.2	Vertical tiered cages with manure belt with whisk-forced air drying .....	169
4.5.1.5.3	Vertical tiered cages with manure belts with improved forced air drying .....	170
4.5.1.5.4	Vertical tiered cages with manure belt with drying tunnel over the cages.....	171
4.5.2	Techniques for non-cage housing of laying hens .....	172
4.5.2.1	Deep litter or floor regime systems .....	172
4.5.2.1.1	Deep litter system for layers .....	172
4.5.2.1.2	Deep litter system with forced air manure drying.....	173
4.5.2.1.3	Deep litter system with perforated floor and forced drying .....	174
4.5.2.2	Aviary system.....	176
4.5.3	Techniques for housing of broilers .....	177
4.5.3.1	Perforated floor with forced air drying system.....	178
4.5.3.2	Tiered floor system with forced air drying for broilers .....	179
4.5.3.3	Tiered cage system with removable cage sides and forced drying of manure.....	180
4.5.4	Techniques for housing of turkeys .....	182
4.5.5	End-of-pipe techniques for the reduction of air emissions from poultry housing .....	183
4.5.5.1	Chemical wet scrubber .....	183
4.5.5.2	External drying tunnel with perforated manure belts .....	184
4.6	Techniques for reducing emissions from pig housing .....	186
4.6.1	System-integrated housing techniques for mating and gestating sows.....	188
4.6.1.1	Fully-slatted floor with vacuum system (FSF vacuum).....	189
4.6.1.2	Fully-slatted floor with flushing of a permanent slurry layer in channels underneath (FSF Flush channels).....	190
4.6.1.3	Fully-slatted floor with flush gutters or flush tubes (FSF flush gutters).....	192
4.6.1.4	Partly-slatted floor with a reduced manure pit (SMP).....	193
4.6.1.5	Partly-slatted floor with manure surface cooling fins.....	195
4.6.1.6	Partly-slatted floor with vacuum system (PSF Vacuum System).....	196
4.6.1.7	Partly-slatted floor with flushing of a permanent slurry layer in channels underneath (PSF Flush channels).....	197
4.6.1.8	Partly-slatted floor with flushing gutters or flush tubes (PSF flush gutter) .....	198
4.6.1.9	Partly-slatted floor with scraper (PSF scraper).....	199
4.6.1.10	Solid concrete floor and full litter (SCF full litter).....	201
4.6.1.11	Solid concrete floor system with straw and electronic sow feeders .....	201
4.6.2	System-integrated housing techniques for farrowing sows .....	203
4.6.2.1	Crates with fully-slatted floor and a board on a slope .....	204
4.6.2.2	Crates with fully-slatted floor and combination of a water and manure channel .....	205
4.6.2.3	Crates with fully-slatted floor and flushing system with manure gutters .....	206
4.6.2.4	Crates with fully-slatted floor and manure pan .....	207
4.6.2.5	Crates with fully-slatted floor and manure surface cooling fins.....	208
4.6.2.6	Crates with partly-slatted floor .....	208
4.6.2.7	Crates with partly-slatted floor and manure scraper .....	209
4.6.3	System-integrated housing techniques for weaned piglets .....	210
4.6.3.1	Pens or flatdecks with fully-slatted floor and concrete sloped floor to separate faeces and urine .....	212
4.6.3.2	Pens or flatdecks with fully-slatted floor and manure pit with scraper .....	212
4.6.3.3	Pens or flatdecks with fully-slatted floor and flush gutters or flush tubes.....	213
4.6.3.4	Pens with partly-slatted floor; the two climate system .....	214
4.6.3.5	Pens with partly-slatted floor and sloped or convex solid floor .....	215
4.6.3.6	Pens with partly-slatted floor and shallow manure pit and channel for spoiled drinking water .....	216
4.6.3.7	Pens with partly-slatted floor with triangular iron slats and manure channel with gutters .....	216
4.6.3.8	Pens with partly-slatted floor and manure scraper.....	217
4.6.3.9	Pens with partly-slatted floor with triangular iron slats and manure channel with sloped side wall(s) .....	218
4.6.3.10	Pens with partly-slatted floor and manure surface cooling fins.....	219
4.6.3.11	Partly-slatted floor with covered box: the kennel housing system .....	220
4.6.3.12	Pens with solid concrete straw-bedded floor: natural ventilation.....	221
4.6.4	System integrated housing techniques for growers/finishers.....	222
4.6.4.1	Partly-slatted floor with flushing gutters or flush tubes (PSF flush gutter) .....	223
4.6.4.2	Partly-slatted floor with manure channel with slanted side wall(s).....	225

4.6.4.3	Partly-slatted floor with a reduced manure pit, including slanted walls and a vacuum system .....	226
4.6.4.4	Partly-slatted floor with manure surface cooling fins .....	226
4.6.4.5	Partly-slatted floor with fast removal of slurry and littered external alley (PSF + EA litter) .....	227
4.6.4.6	Partly-slatted floor with covered box: the kennel housing system .....	228
4.6.4.7	Solid concrete floor with litter and outdoor climate .....	229
4.6.4.8	Solid concrete floor with littered external alley (SCF + EA litter) .....	229
4.6.5	End-of-pipe measures for reduction of air emissions from housing of pigs .....	230
4.6.5.1	Bioscrubber .....	230
4.6.5.2	Chemical wet scrubber .....	231
4.7	Techniques for the reduction of odour .....	232
4.8	Techniques for the reduction of emissions from storage .....	235
4.8.1	Reduction of emissions from storage of solid manure .....	235
4.8.1.1	General practice .....	235
4.8.1.2	Application of a covering to solid manure stacks .....	236
4.8.1.3	Storage of poultry manure in a barn .....	237
4.8.2	Reduction of emissions from storage of slurry .....	237
4.8.2.1	General aspects .....	237
4.8.2.2	Application of a rigid cover to slurry stores .....	238
4.8.2.3	Application of a flexible cover to slurry stores .....	239
4.8.2.4	Application of a floating cover to slurry stores .....	239
4.8.2.5	Application of covers to earth-banked slurry stores .....	242
4.8.3	Feed storage .....	243
4.9	Techniques for on-farm processing of manure .....	243
4.9.1	Mechanical separation of pig slurry .....	246
4.9.2	Aeration of liquid manure .....	247
4.9.3	Mechanical separation and biological treatment of pig slurry .....	248
4.9.4	Composting of solid manure .....	250
4.9.5	Composting of poultry manure using pine bark .....	251
4.9.6	Anaerobic treatment of manure in a biogas installation .....	252
4.9.7	Anaerobic lagoon system .....	253
4.9.8	Evaporation and drying of pig manure .....	254
4.9.9	Incineration of poultry manure .....	255
4.9.10	Pig manure additives .....	256
4.10	Techniques for the reduction of emissions from application of manure to land .....	257
4.10.1	Balancing spreading of manure with the available land .....	257
4.10.2	Groundwater protection schemes .....	259
4.10.3	Management of landspreading of manure as applied in the UK and Ireland .....	259
4.10.4	Manure application systems .....	260
4.10.5	Low-rate irrigation system for dirty water .....	264
4.11	Techniques to reduce noise emissions .....	265
4.11.1	Control of noise from ventilation fans .....	265
4.11.2	Control of noise from discontinuous on-farm activities .....	267
4.11.3	Application of noise barriers .....	269
4.12	Techniques for the treatment and disposal of residues other than manure and carcasses .....	270
4.12.1	Treatment of liquid residues .....	270
4.12.2	Treatment of solid residues .....	271
<b>5</b>	<b>BEST AVAILABLE TECHNIQUES .....</b>	<b>273</b>
5.1	Good agricultural practice in the intensive rearing of pigs and poultry .....	275
5.2	Intensive rearing of pigs .....	277
5.2.1	Nutritional techniques .....	277
5.2.1.1	Nutritional techniques applied to nitrogen excretion .....	277
5.2.1.2	Nutritional techniques applied to phosphorus excretion .....	278
5.2.2	Air emissions from pig housing .....	278
5.2.2.1	Housing systems for mating/gestating sows .....	279
5.2.2.2	Housing systems for growers/finishers .....	281
5.2.2.3	Housing systems for farrowing sows (including piglets) .....	282
5.2.2.4	Housing systems for weaners .....	283
5.2.3	Water .....	284
5.2.4	Energy .....	285
5.2.5	Manure storage .....	285



5.2.6	On-farm manure processing .....	286
5.2.7	Techniques for landspreading pig manure.....	287
5.3	Intensive rearing of poultry .....	289
5.3.1	Nutritional techniques.....	289
5.3.1.1	Nutritional techniques applied to nitrogen excretion.....	289
5.3.1.2	Nutritional techniques applied to phosphorus excretion.....	290
5.3.2	Air emissions from poultry housing .....	290
5.3.2.1	Housing systems for layers.....	290
5.3.2.2	Housing systems for broilers.....	292
5.3.3	Water .....	292
5.3.4	Energy .....	293
5.3.5	Manure storage .....	293
5.3.6	On-farm manure processing .....	294
5.3.7	Techniques for landspreading poultry manure .....	294
<b>6</b>	<b>CONCLUDING REMARKS.....</b>	<b>295</b>
6.1	Timing of the work.....	295
6.2	Sources of information .....	295
6.3	Level of consensus.....	295
6.4	Recommendations for future work .....	296
6.5	Suggested topics for future R&D projects.....	297
	<b>REFERENCES .....</b>	<b>299</b>
	<b>GLOSSARY OF TERMS .....</b>	<b>307</b>
	<b>ABBREVIATIONS.....</b>	<b>309</b>
<b>7</b>	<b>ANNEXES.....</b>	<b>311</b>
7.1	Animal species and livestock units (LU).....	311
7.2	References to European legislation.....	312
7.3	National legislation of European Member States .....	313
7.4	Examples of emission limit values and manure spreading limits in Member States .....	326
7.5	Example of protocol for monitoring of ammonia emissions from housing systems.....	327
7.6	Example of calculation of costs associated with the application of emission reduction techniques .....	329
7.7	Procedure for BAT-assessment of techniques applied on intensive poultry and pig farms.....	338

---

## List of tables

Table 1.1: Some typical poultry breeding data.....	3
Table 1.2: Summary of egg production costs in different systems.....	7
Table 1.3: Number of birds, total farms and farms under definition of Section 6.6 of Annex 1 of Council Directive 96/69/EC for different European Member States .....	9
Table 1.4: Number of pig farms in European Member States under definition of Section 6.6 of Annex 1 of Council Directive 96/69/EC.....	14
Table 1.5: General production levels pig farming UK.....	16
Table 1.6: Emissions to air from intensive livestock production systems.....	20
Table 1.7: Schematic overview of processes and factors involved in ammonia release from animal houses .....	21
Table 1.8: Main emissions to soil and groundwater from intensive livestock production systems.....	22
Table 2.1: Range of weights of meat and egg production duck breeds.....	39
Table 2.2: Example of required indoor temperatures for broiler housing .....	41
Table 2.3: Advisable limit values for different gaseous substances in the indoor air in broiler housing applied in Belgium .....	41
Table 2.4: Example of light requirements for poultry production as practised in Portugal.....	44
Table 2.5: Applied number of animals per drinker system in different cages.....	47
Table 2.6: General indicative levels of indoor environment for pigs .....	61
Table 2.7: Example of applied temperature requirements for calculation of heating capacity in heated housing for different pig categories in healthy condition.....	62
Table 2.8: Effect of feeding system on weight gain, FCR and feed losses .....	70
Table 2.9: Times of storage of poultry and pig manure in a number of MSs.....	72
Table 2.10: Qualitative comparison of characteristics of four slurry-transport systems .....	85
Table 3.1: Key environmental issue of the major on-farm activities .....	97
Table 3.2: Indication of production time, conversion ratio and feeding level per poultry species.....	99
Table 3.3: Appraisal of current protein and lysine levels and scope for recommended amino acids balance .....	100
Table 3.4: Applied calcium and phosphorus levels in feed for poultry.....	100
Table 3.5: Appraisal of current protein and lysine levels and scope for recommended amino acids for sows (1 phase for each major stage of growth).....	101
Table 3.6: Applied calcium and phosphorus levels in feed for sows .....	102
Table 3.7: Example of rationing used for light and heavy finishers in Italy .....	102
Table 3.8: Appraisal of current protein and lysine levels and scope for recommended amino acids for pigs (1 phase for each major stage of growth).....	103
Table 3.9: Calcium and phosphorus levels applied to feed for growers/finishers.....	103
Table 3.10: Average nutritional levels applied in Italy for heavy weight pigs for different live weight intervals (as % of raw feed) .....	104
Table 3.11: Water consumption of different poultry species per cycle and per year .....	104
Table 3.12: Estimated water use for cleaning of poultry housing .....	105
Table 3.13: Water requirements of finishers and sows in l/head/day with respect to age and stage of production .....	106
Table 3.14: Example of the effect of water/feed-ratio on the production and dry matter content of manure of growers/finishers.....	106
Table 3.15: Effect of water delivery of drinking-nipples on the production and dry matter content of manure of growers/finishers.....	107
Table 3.16: Estimated water use for the cleaning of pig housing.....	107
Table 3.17: Indicative levels of daily energy consumption of activities on poultry farms in Italy .....	108
Table 3.18: Indicative levels of energy use of poultry farms in the UK .....	109
Table 3.19: Approximate annual energy use for typical pig housing types and systems in the UK .....	110
Table 3.20: Total annual energy use per head on different farm types of different size in the UK.....	110
Table 3.21: Average daily energy consumption per type of pig farm and by type of energy source used in Italy .....	111
Table 3.22: Average daily energy consumption for farms in Italy by farm size and energy source .....	111
Table 3.23: Typical amounts of bedding material used by pigs and poultry in l housing systems .....	112
Table 3.24: Example of contribution to NH <sub>3</sub> -N emissions of different activities in the UK (1999).....	112
Table 3.25: Example of models used in Belgium for the calculation of mineral gross production in manure .....	113
Table 3.26: Range of reported levels of poultry manure production, dm-content and nutrient analysis of fresh poultry manure in different poultry housing systems.....	115

Table 3.27: Range of levels reported on daily and annual production of manure, urine and slurry by different pig categories .....	116
Table 3.28: Example of effect of reduced CP-levels in feed for growers and finishers on daily consumption, retention and losses of nitrogen.....	117
Table 3.29: Average excretion of nitrogen (kg per year) in a housing with a breeding sow (205 kg) and different numbers of piglets (up to 25 kg) at weaning.....	117
Table 3.30: Nitrogen retention in different growing phases of finishers (Italian data).....	118
Table 3.31: Annual excretion of nitrogen for different categories of finishers.....	118
Table 3.32: Example of consumption, retention and excretion of phosphorus in pigs (kg per pig) .....	118
Table 3.33: Average composition of manure and standard deviation (between brackets) in kg per 1000 kg of manure.....	119
Table 3.34: Indication of reported levels of air emission from poultry housing (kg/bird/yr) .....	121
Table 3.35: Range of air emission from pig housing systems in kg/animal place/year .....	121
Table 3.36: Emission of NH <sub>3</sub> for different slurry storage techniques.....	122
Table 3.37: Factors influencing the emission levels of ammonia into air from landspreading.....	124
Table 3.38: Livestock manure nitrogen pressure (1997) .....	125
Table 3.39: Heavy metal concentrations in slurry and dry manure .....	126
Table 3.40: Heavy metal concentrations in slurry and dry matter .....	126
Table 3.41: Estimated average yearly contribution to heavy metal input through pig and poultry manure in Germany .....	127
Table 3.42: Reported odour emission levels from pig slurry.....	127
Table 3.43: Typical sources of noise and example of noise levels on poultry units .....	128
Table 3.44: Typical sources of noise and examples of noise levels on pig units.....	129
Table 4.1: Information provided for each technique included in Chapter 4 .....	131
Table 4.2: Standard levels of nitrogen (N) excretion in Belgium, France and Germany.....	137
Table 4.3: Standard levels of excretion of diphosphorus pentoxide (P <sub>2</sub> O <sub>5</sub> ) in Belgium, France and Germany .....	137
Table 4.4: Percentage reduction in nitrogen (N) output obtained with the reference feeding programmes compared to the standard level of excretion in France and Germany.....	137
Table 4.5: Percentage reduction in diphosphorus pentoxide (P <sub>2</sub> O <sub>5</sub> ) output obtained with the reference feeding programmes compared to the standard level of excretion in Belgium, France and Germany .....	137
Table 4.6: Regressions used in Belgium to calculate the actual level of excretion .....	138
Table 4.7: Nutritional management in Belgium, France and Germany: characteristics of reference feeds .....	139
Table 4.8: Index of costs for compound feed and nitrogen content according to feeding management..	140
Table 4.9: Summary of the effect of a reduction of dietary protein and the use of low-protein diets on nitrogen excretion and ammonia emission .....	144
Table 4.10: Total phosphorus, phytate-phosphorus and phytase activity in selected plant feedstuff .....	146
Table 4.11: Calculated reduction of phosphorus excretion based on the digestibility of poultry .....	148
Table 4.12: Intermitting air drying of manure in layer cage systems .....	154
Table 4.13: Specific stream of light and adjustability of different types of light bulbs and fluorescent lamps .....	155
Table 4.14: Indication of longevity of different types of light for poultry housing.....	156
Table 4.15: Results of the application of the combideck system.....	158
Table 4.16: Farm levels at Henk Wolters, Dalfsen, the Netherlands.....	159
Table 4.17: Summary of characteristics of system integrated techniques for battery housing of laying hens .....	163
Table 4.18: Summary of the characteristics of techniques for non-cage housing of laying hens .....	172
Table 4.19: Summary of characteristics of system-integrated techniques for the housing of broilers.....	177
Table 4.20: Summary of operational and cost data of a chemical wet scrubber for emissions from layer and broiler housing .....	184
Table 4.21: Performance levels of system-integrated housing techniques for new installations for mating and gestating sows.....	189
Table 4.22: Performance levels of system-integrated housing techniques for new installations for farrowing sows .....	203
Table 4.23: Performance levels of system-integrated housing techniques for new installations for weaned piglets .....	211
Table 4.24: Performance levels of system-integrated housing techniques for new installations for growers/finishers .....	223
Table 4.25: Summary of the reductions in ammonia emissions and of the costs of a bioscrubber for different pig categories .....	231

Table 4.26: Summary of the reduction of ammonia emissions and of the costs of a chemical wet scrubber for different pig categories .....	232
Table 4.27: Reductions of ammonia evaporation from pig slurry storage achieved by applying different types of floating covers .....	241
Table 4.28: Summary of performance data of on-farm manure treatment techniques .....	245
Table 4.29: Results of mechanical separation techniques expressed as percentages of raw manure in solid fraction .....	246
Table 4.30: Cost data for some mechanical separation techniques .....	247
Table 4.31: Mass balance of the mechanical separation and biological treatment of pig slurry .....	248
Table 4.32: Relative distribution of a number of components over different product streams .....	249
Table 4.33: Composition of manure and products in g/kg .....	249
Table 4.34: Estimation of the operating costs of an installation for the mechanical separation and biological treatment of sow manure with a capacity of 5 ktonnes per year in EUR/tonne manure.....	250
Table 4.35: Cost data for the composting of the poultry manure of 200000 layers by means of mechanical turning .....	252
Table 4.36: Costs for an installation for evaporating and drying pig manure with a capacity of 15 - 20 m <sup>3</sup> per day.....	255
Table 4.37: Cost data for the on-farm incineration of poultry manure.....	256
Table 4.38: Characteristics of four different slurry distribution systems and incorporation techniques ..	263
Table 4.39: Reducing effect of different noise measures .....	266
Table 5.1: Indicative crude protein levels in BAT-feeds for pigs .....	278
Table 5.2: Indicative total phosphorus levels in BAT-feeds for pigs .....	278
Table 5.3: Examples of conditional BAT on on-farm manure processing .....	287
Table 5.4: BAT on landspreading equipment .....	288
Table 5.5: Indicative crude protein levels in BAT-feeds for poultry .....	290
Table 5.6: Indicative total phosphorus levels in BAT-feeds for poultry .....	290
Table 7.1: Animal species expressed in livestock units .....	311
Table 7.2: Maximum tolerated limits to organic N- and P <sub>2</sub> O <sub>5</sub> application (kg/ha) by landspreading of manure in Flanders from 1-1-2003.....	326
Table 7.3: Maximum tolerated limits to organic N and P <sub>2</sub> O <sub>5</sub> application (kg/ha) by landspreading of manure in Flanders in sensitive zones concerning water .....	326
Table 7.4: Examples of emission limit values for certain on-farm activities .....	326
Table 7.5: Examples of factors to include in the measurement of emissions from poultry housing .....	327
Table 7.6: Example of factors to include in the measurement of emissions from pig housing .....	328
Table 7.7: 'Units' used for assessing costs.....	330
Table 7.8: Capital expenditure considerations .....	331
Table 7.9: Annual cost considerations .....	331
Table 7.10: Additional costs incurred with liquid manure application by soil injection in the UK .....	332
Table 7.11: Additional costs incurred in solid manure incorporation by ploughing in the UK.....	332
Table 7.12: Additional costs incurred with changes of a building in the UK.....	333
Table 7.13: Additional costs incurred with metal grid floor replacement in the UK .....	333
Table 7.14: Finishing pig space requirement in the UK.....	334
Table 7.15: Interest on agricultural mortgage in the UK.....	335
Table 7.16: Economic life of facilities .....	335
Table 7.17: Repair costs as a percentage of new costs.....	336
Table 7.18: Annual costs to consider in capital costs of feeding systems .....	336
Table 7.19: Annual costs to consider in capital costs of housing systems .....	337
Table 7.20: Annual costs to consider in capital costs of manure storage systems.....	337
Table 7.21: Annual costs to consider in capital costs of manure storage systems.....	337
Table 7.22: Assessment matrix .....	339

---

## List of figures

Figure 1.1: Animal density in the European Union, expressed as number of livestock units per hectare of utilised agricultural area .....	2
Figure 1.2: Dynamics of egg production and consumption in the EU.....	4
Figure 1.3: Example of the production chain of the egg production sector .....	5
Figure 1.4: Dynamics of poultry meat production and consumption in the EU .....	6
Figure 1.5: Example of the production chain of the broiler production sector .....	7
Figure 1.6: Distribution of breeding sows in Europe for each Member State in 1998 .....	10
Figure 1.7: Gross indigenous pig production in 1998.....	11
Figure 1.8: Number of holders by unit size in 1997. Legend indicates unit size (in reverse order) .....	12
Figure 1.9: Number of animals in unit size categories (1997).....	12
Figure 1.10: Number of sows in different sized units (1997). Legend indicates size of unit in terms of number of sows.....	13
Figure 1.11: Number of pigs for fattening on various size units (1997).....	13
Figure 1.12: Spatial density of pig production in the EU-15 .....	15
Figure 1.13: Carcase weight of slaughtered pigs for each Member State.....	15
Figure 1.14: Pigmeat trade by European Member States.....	16
Figure 1.15: Consumption of pig meat per capita (kg/person) over time in Europe.....	17
Figure 1.16: Illustration of environmental aspects related to intensive livestock farming .....	19
Figure 1.17: Consumption, utilisation and losses of protein in the production of a slaughter pig with a final live weight of 108 kg.....	20
Figure 1.18: Nitrogen cycle showing the main transformations and losses to the environment.....	23
Figure 2.1: General scheme of activities on intensive livestock farms.....	26
Figure 2.2: Four common battery designs for housing of laying hens.....	28
Figure 2.3: Example of open manure pit under a stair-step battery .....	29
Figure 2.4: Deep-pit system for laying hens.....	30
Figure 2.5: Example of a canal system for laying hens .....	30
Figure 2.6: Example of open manure channel with scraper under a stair-step battery .....	31
Figure 2.7: Example of a manure-belt battery (3 tiers) with a belt under each tier to remove manure to a closed storage .....	32
Figure 2.8: Schematic picture of a possible design of an enriched cage.....	33
Figure 2.9: Schematic cross-section of traditional deep litter system for layers.....	34
Figure 2.10: Schematic picture of an aviary system .....	35
Figure 2.11: Example of schematic cross-section of a commonly applied broiler house .....	36
Figure 2.12: Schematic cross-section of the partially ventilated litter floor system for turkeys.....	38
Figure 2.13: Schematic overview of a housing design for mating sows on a partly-slatted floor .....	50
Figure 2.14: Floor design for sow crates with a solid concrete floor for mating and gestating sows .....	51
Figure 2.15: Example of group-housing for gestating sows on a solid concrete floor with full litter.....	51
Figure 2.16: Example of a housing system with several functional areas for gestating sows .....	52
Figure 2.17: Farrowing pen design with a fully-slatted floor (the Netherlands).....	53
Figure 2.18: Example of confined housing of farrowing sows on a fully-slatted floor with a storage pit underneath .....	54
Figure 2.19: Example of an applied plan for a farrowing pen (partly-slatted floor) without restricted sow movement .....	54
Figure 2.20: Cross-section of rearing unit with fully-slatted floor and plastic or metal slats .....	55
Figure 2.21: Schematic picture of a weaner pen with a partly-slatted floor (1/3) and a cover above the lying area .....	56
Figure 2.22: Example of a single growing-finishing pen with a fully-slatted floor and examples of two pen layout with different feeding systems .....	58
Figure 2.23: Pen design for growers-finishers with partly-slatted (convex) floor and solid area in the centre .....	58
Figure 2.24: Design of a partly-slatted floor system with restricted straw use for growers-finishers.....	59
Figure 2.25: Solid concrete floor with slatted external alley and scraper underneath .....	59
Figure 2.26: Open front design using straw bales for protection (UK) .....	60
Figure 2.27: An example of a solid concrete floor system for growers-finishers.....	60
Figure 2.28: Solid concrete floor with external littered alley and manure channel .....	61
Figure 2.29: Schematic picture of airflow in an exhaust ventilation system .....	64
Figure 2.30: Schematic picture of airflow in a pressure ventilation system .....	64
Figure 2.31: Schematic picture of airflow in a neutral ventilation system .....	65
Figure 2.32: Example of silos built close to the broiler houses (UK).....	71
Figure 2.33: Storage of littered manure with separate containment of the liquid fraction (Italy).....	74
Figure 2.34: Example of aboveground slurry tank with belowground receiving pit .....	76

Figure 2.35: Example of earth-banked slurry store and design features .....	76
Figure 2.36: Example of a broadcast spreader with a splash plate .....	85
Figure 2.37: Example of a raingun.....	86
Figure 2.38: Example of a broadcast technique with low trajectory and low pressure .....	86
Figure 2.39: Example of a broadcast technique with low trajectory and low pressure .....	87
Figure 2.40: Example of a band spreader fitted with rotary distributor to improve lateral distribution .....	87
Figure 2.41: Example of a trailing shoe spreader.....	88
Figure 2.42: Example of an open-slot shallow injector.....	88
Figure 2.43: Incorporation equipment combined with a big tanker .....	89
Figure 2.44: Example of a rotaspreader .....	90
Figure 2.45: Example of a rear discharge spreader .....	90
Figure 2.46: Example of a dual purpose spreader .....	91
Figure 4.1: Amino acid supplementation allows a decrease in the amount of protein intake by animals whilst maintaining an adequate amino acid supply .....	143
Figure 4.2: Effect of reduced crude-protein diets on the intake of water by pigs.....	151
Figure 4.3: Schematic representation of the installation of the heat recovery system in a broiler house .	157
Figure 4.4: Graphic representation of the working principle of the “combideck-system” during one broiler production cycle .....	157
Figure 4.5: Schematic picture of a cage with forced (pneumatic) drying installation .....	167
Figure 4.6: Schematic picture of a design incorporating two cages and with a manure belt and a drying channel .....	168
Figure 4.7: Principle of whisk-forced air drying .....	169
Figure 4.8: Schematic picture of a drying tunnel over vertical tiered cages .....	171
Figure 4.9: Deep litter systems with forced drying via tubes under the slatted floor .....	174
Figure 4.10: Deep litter system with perforated floor and forced manure drying .....	175
Figure 4.11: Schematic representation of a forced drying system with a perforated floor for broilers (A), an improved design (B), and a detail of the floor of the improved design (C).....	179
Figure 4.12: Schematic cross-section and principle of a tiered floor system with forced drying (upward flow) for broilers .....	180
Figure 4.13: Schematic representation of a littered tiered cage system in a broiler house .....	181
Figure 4.14: Schematic cross-section of a cage in a littered tiered cage system .....	182
Figure 4.15: Schematic picture of a chemical wet scrubber design .....	183
Figure 4.16: Principle of external drying tunnel with perforated manure belts.....	185
Figure 4.17: Fully-slatted floor with vacuum system.....	190
Figure 4.18: Fully-slatted floor with flushing of a permanent slurry layer in canals underneath.....	191
Figure 4.19: Fully-slatted floor with flushing gutters .....	192
Figure 4.20: Fully-slatted floor with flushing tubes .....	192
Figure 4.21: Individual housing with a small manure pit.....	194
Figure 4.22: Solid concrete floor and fully-slatted external alley with storage pit underneath .....	194
Figure 4.23: Manure surface cooling fins .....	196
Figure 4.24: Partly-slatted floor with vacuum system.....	196
Figure 4.25: Partly-slatted floor and external alley with flushing of a permanent slurry layer in canals underneath.....	197
Figure 4.26: Partly-slatted floor with flushing gutter in individual housing situation.....	198
Figure 4.27: Partly-slatted floor with a scraper (PSF scraper) .....	200
Figure 4.28: Solid concrete floor system with straw and electronic sow feeders.....	202
Figure 4.29: Board on a slope under the slatted floor .....	204
Figure 4.30: Combination of a water and manure channel.....	205
Figure 4.31: Flushing system with manure gutter .....	206
Figure 4.32: Fully-slatted floor with manure pan.....	207
Figure 4.33: Farrowing pen with floating cooler fins.....	208
Figure 4.34: Partly-slatted floor with a manure scraper .....	209
Figure 4.35: Flatdecks or pens with concrete sloped floor underneath to separate faces and urine .....	212
Figure 4.36: Flatdeck system with a scraper under a fully-slatted floor .....	213
Figure 4.37: Pens with fully-slatted floor with flush gutters or flush tubes .....	213
Figure 4.38: Cross-section of rearing unit with partly-slatted floor, two-climate .....	214
Figure 4.39: Partly-slatted floor with iron or plastic slats and convex or sloped concrete floor .....	215
Figure 4.40: Shallow manure pit with a channel for spoiled drinking water in front in combination with a convex floor with iron or plastic slats .....	216
Figure 4.41: Convex floor with triangular iron slats in combination with a gutter system .....	217
Figure 4.42: Partly-slatted floor with a manure scraper .....	218
Figure 4.43: Convex floor with triangular iron slats in combination with sewerage system and side walls on a slope in the manure channel .....	219

---

Figure 4.44: Pen for weaners, partly-slatted floor and manure surface cooling .....	219
Figure 4.45: Kennel housing system.....	220
Figure 4.46: pens with solid concrete straw-bedded floor: natural ventilation .....	221
Figure 4.47: Convex floor with concrete (or triangular iron) slats in combination with a gutter system	224
Figure 4.48: Convex floor with concrete slats and side walls on a slope in the manure pit .....	225
Figure 4.49: Rearing pen, partly-slatted floor with concrete or triangular iron slats and manure surface cooling .....	227
Figure 4.50: Partly-slatted floor with fast removal of slurry and littered external alley .....	228
Figure 4.51: Two bioscrubber designs.....	230
Figure 4.52: Example of low rate irrigation system.....	264





## SCOPE OF WORK

The scope of the BREF for intensive livestock is based on Section 6.6 of Annex I of the IPPC Directive 96/61/EC as ‘Installations for the intensive rearing of poultry or pigs with more than:

- (d) 40000 places for poultry
- (e) 2000 places for production pigs (over 30 kg), or
- (f) 750 places for sows.’

The Directive does not define the term **poultry**. From the discussion in the TWG it has been concluded that in this document the scope of poultry is:

- chicken laying hens and broilers
- turkeys
- ducks
- Guinea fowls.

However, only limited information was submitted on ducks and Guinea fowls and therefore these are only briefly discussed.

Hatching is not included in the poultry scope, as this is considered to be a separate activity and not an integrated activity of a layer or broiler farm.

The Directive distinguishes between farms with **pigs** and farms with **sows**. In practice, there are closed cycle farms which have both sows and grower/finishers. Typically their capacities are below the Annex I thresholds for both sectors, but they have at least an equal potential environmental impact as those farms that are identified in Annex I. The TWG concluded that breeding farms, growing/finishing farms and closed cycle farms are all included in the scope of this BREF in respect to the identification of reduction techniques and the assessment of BAT.

The rearing of pigs includes the rearing of weaners, whose growing/finishing starts at a weight level between 25 and 35 kg of live weight. The rearing of sows includes mating, gestating and farrowing sows (including offspring) and gilts (replacement sows).

In line with article 2.3 of Directive 96/61/EC, a **farm** is considered to be an installation that may consist of one or more stationary technical units and of all directly associated activities. For the scope of this work, the TWG included some techniques that they considered relevant but that are not always applied on installations covered by IPPC. For example, landspreading of manure is considered in great detail, although it is acknowledged that landspreading is often carried out by contractors and often not on land belonging to the farm where the manure has been generated. The reason for considering landspreading in such detail is to prevent the benefits of a measure applied by a farmer to reduce emissions in the beginning of a chain being cancelled out by later applying poor landspreading management or techniques at the end of the chain. Or in other words, because the main environmental impacts of farming all result from the manure from the animals, measures to decrease these emissions are not only limited to housing techniques and the storage of manure, but comprise measures throughout a whole chain of events, inclusive of feeding strategies and final landspreading, all of which are within the scope of this document.

Items not within the scope of this work are centralised manure or waste treatment facilities and alternative rearing systems, such as the free range farming of pigs by using rotating systems.

The following relevant **farm activities** are described, although it is acknowledged that not all of the activities will be found on every farm:

## Scope

---

- farm management (including maintenance and cleaning of equipment)
- feeding strategy (and feed preparation)
- rearing of animals
- collection and storage of manure
- on-site treatment of manure
- landspreading of manure
- waste water treatment.

The environmental issues associated with the above listed activities include:

- the use of energy and water
- emissions to air (e.g. ammonia, dust)
- emissions to soil and groundwater (e.g. nitrogen, phosphorus, metals)
- emissions to surface water
- emissions of waste other than manure and carcasses.

Factors such as animal welfare requirements, microbiological emissions and the antibiotic resistance of the animals, are important for the assessment of environmental techniques. They have been included in the assessment where information was made available. Issues concerning aspects such as, human health and animal products have not been part of the information exchange and are not covered in this BREF.

## 1 GENERAL INFORMATION

This chapter provides general information on pig and poultry production in Europe. It briefly describes the position of Europe on the world market and developments in the internal European market and those of its Member States. It introduces the main environmental issues associated with intensive pig and poultry farming.

### 1.1 Intensive livestock farming

Farming has been and still is dominated by family run businesses. Until the sixties and into the early seventies, poultry and pig production were only part of the activities of a mixed farm, where crops were grown and different animal species were kept. Feed was grown on the farm or purchased locally and residues of the animal were returned to the land as fertiliser. Very few examples of this type of farm still exist in the EU.

Since then, increasing market demands, the development of genetic material and farming equipment and the availability of relatively cheap feed encouraged farmers to specialise. As a consequence animal numbers and farm sizes increased and intensive livestock farming started. Feeds were often imported from outside the EU, since the amounts and types needed could not be produced locally. Intensive farming thus led to significant imports of nutrients that were not returned to the same land (via manure) that had produced the crops that provided the feed components. Instead the manure is applied on the available land. However, in many intensive livestock regions there is insufficient land available. In addition, higher nutrient levels were fed to the animals (sometimes more than was strictly necessary) to ensure optimum growth levels. These nutrients were consequently partly excreted in natural processes, thus increasing the level of nutrients in the manure even more.

Intensive livestock farming coincides with high animal densities. Animal density is itself considered a rough indicator of the amount of animal manure produced by livestock. A high density usually indicates that the mineral supply exceeds the requirements of the agricultural area to grow crops or to maintain grassland. Hence, data on the concentration of livestock production at a regional level are considered to be a good indicator of areas with potential environmental problems (e.g. nitrogen pollution).

In a report on the management of nitrogen pollution [77, LEI, 1999], the term livestock units (LU = 500 kg animal mass) is used to present the total size of the livestock population, allowing a summation of animal species according to their feed requirements. The meaning of the term “intensive livestock farming” in Europe is illustrated by using animal density expressed in the number of livestock units per hectare of utilised agricultural area (LU/ha).

Figure 1.1 shows animal density (in LU/ha) at regional levels. Animal density exceeds 2 LU/ha in most of the Netherlands, parts of Germany (Niedersachsen, Nordrhein-Westfalia), Brittany (France), Lombardy (Italy) and some parts of Spain (Galicia, Cataluña). A stocking density of 2 LU/ha is considered to be close to the amounts of nitrogen from livestock manure that may be applied in accordance with the Nitrates Directive. The picture also illustrates that for nearly all Member States the environmental impact of intensive livestock farming is a regional issue, but for a few countries like the Netherlands and Belgium it can almost be considered a national issue.

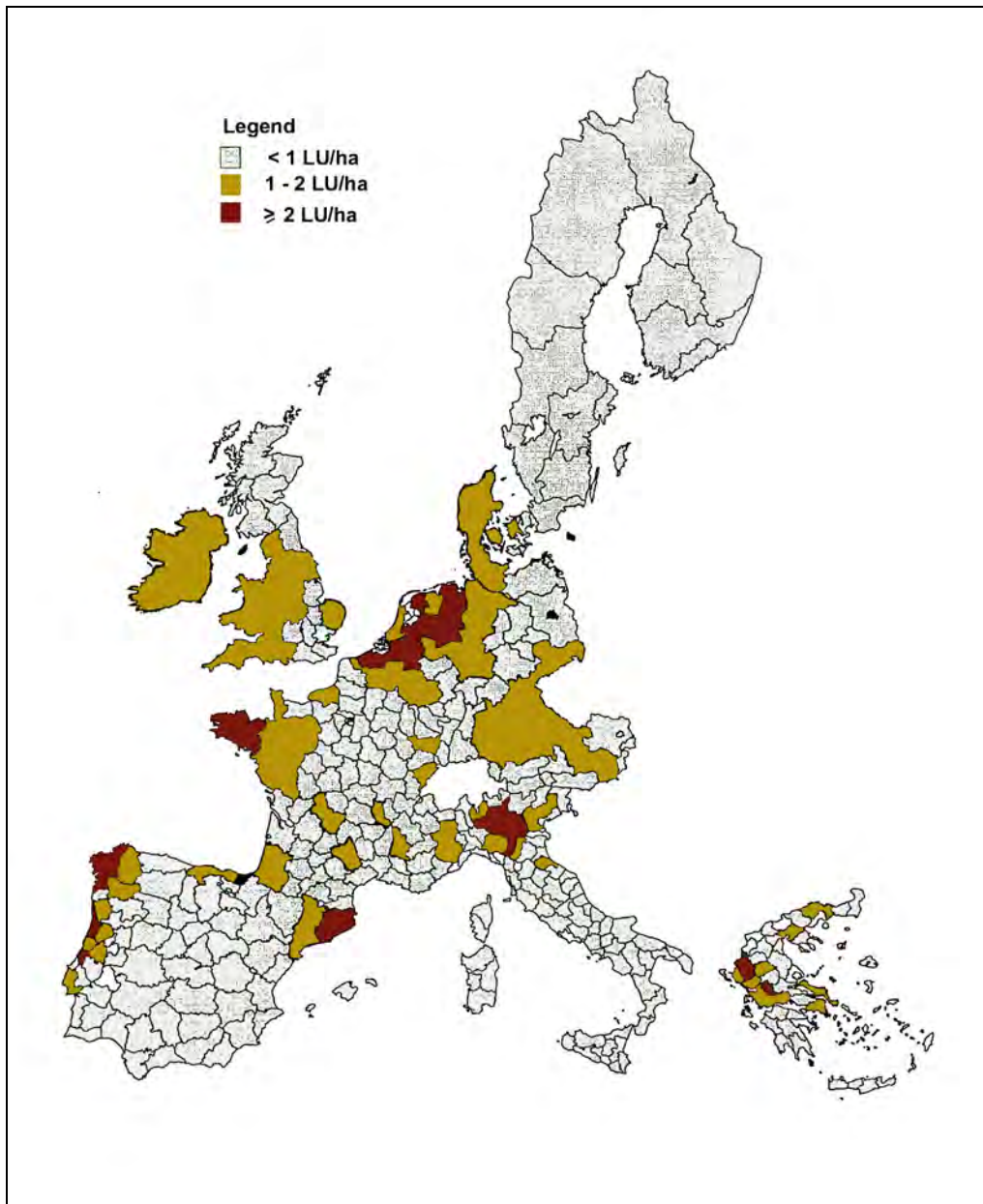

**Figure 1.1: Animal density in the European Union, expressed as number of livestock units per hectare of utilised agricultural area**  
 [153, Eurostat, 2001] [77, LEI, 1999]

The areas with high livestock densities typically have many intensive pig and poultry farms each with a large number of animals. For example, the share of pigs and poultry exceeds 50 % in most of these regions and poultry accounts for more than 20 % of the regional livestock population in parts of France (Pays de la Loire, Bretagne), Spain (Cataluña) and the United Kingdom (East England). In some Member States there is a decline in the actual number of farms, but the remaining farms now tend to keep more animals and have higher production. In only a few Member States (e.g. Spain) are new enterprises being started or large facilities being installed. [77, LEI, 1999]

## 1.2 The poultry production sector in Europe

By far the majority of poultry farms are part of the production chain for chicken eggs or for chicken broilers. A comparatively small number of farms produces turkeys (meat) and ducks (for meat, foie gras or eggs); very little is known about the production of Guinea fowl. The

following sections describe briefly the poultry sectors in Europe with the emphasis on chicken production, as only limited information has been submitted on the other production sectors. More detailed statistical data can be found in the annual reports of the European Commission (DG Agriculture and Eurostat [153, Eurostat, 2001]).

Poultry production data vary per poultry species and poultry breed and also somewhat per MS depending on market demands. Breeds are either selected for their egg producing capacities or growing (meat) potential. Table 1.1 shows some typical production data for poultry species under the scope of IPPC.

Types of technical elements	Laying hens	Broilers	Turkey		Duck
			M	F	
Production cycle (days)	385 – 450	39 – 45	133	98 – 133	42 – 49
Weight (kg)	1.85	1.85 – 2.15	14.5 – 15	7.5 – 15	2.3
Feed conversion ratios	1.77	1.85	2.72	2.37	2.5
Weight (kg)/m <sup>2</sup>	no data	30 – 37	no data	no data	20

**Table 1.1: Some typical poultry breeding data**  
[92, Portugal, 1999] [179, Netherlands, 2001] [192, Germany, 2001]

### 1.2.1 Egg production

Worldwide, Europe is the second largest producer of hen eggs with about 19 % of the world total, equalling 148688 million eggs per year (1998), and it is expected that this production will not change significantly in the coming years. In 1999, the EU-15 had about 305 million layers producing 5342 million tonnes of eggs, or, at an average of about 62 grams per egg, approximately 86161 million eggs. This means that on average about 282 saleable eggs per hen per year were produced (the actual number will be slightly higher, as some eggs will be lost due to cracks and dirt).

Egg production follows a cyclical pattern as production is increased/reduced after periods of favourable/low prices [203, EC, 2001].

Eggs for human consumption are produced in all Member States. The largest producer of eggs in the EU is France (18 % of the flock and 17 % of the egg production) followed by Germany (14 % of the flock and 16 % of egg production), Italy (15 % of the flock and 14 % of the egg production) and Spain (14 % of the flock and 14 % of the egg production) which all have comparable production levels, closely followed by the Netherlands (12 % of the flock and 13 % of the egg production). Of the exporting Member States, the Netherlands is the largest exporter with 65 % of its production followed by France, Italy and Spain, while in Germany consumption is higher than production.

Concerning the housings of the animals, it is expected that reductions in stocking density under Directive 99/74/EC will result in units with a smaller number of animal places, as only a reduced number of hens could be legally housed in cages. As a consequence, the number of installations with more than 40000 places is forecast to decrease; as up to 20 % [203, EC, 2001] of the birds may have to be removed to comply with the new regulations. The current numbers of farms under IPPC (over 40000 bird places) are listed in Table 1.3.

The majority of laying hens in the EU are kept in cages, although particularly in Northern Europe, non-cage egg production has gained in popularity over the past ten years. For example, the United Kingdom, France, Austria, Sweden, Denmark and the Netherlands have increased the proportion of eggs produced in systems such as barn, semi-intensive, free range and deep litter.

Deep litter is the most popular non-cage system in all Member States, except for France, Ireland and the United Kingdom, where semi-intensive systems and free range are preferred.

The number of layers kept on one farm varies considerably between a few thousand and up to several hundred thousand. A relatively small number of farms per Member State are expected to be under the scope of the IPPC Directive. Of other egg laying poultry species only a couple may be found with 40000 places or more.

Most of the EU-produced consumption eggs (about 95 %) are consumed within the European community itself. Average annual consumption per capita in 2000 was about 12.3 kg. Compared with 1991, consumption levels show a slight decline (Figure 1.2).

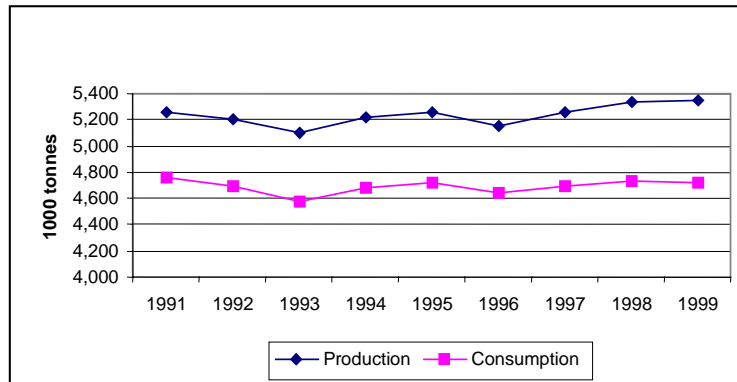
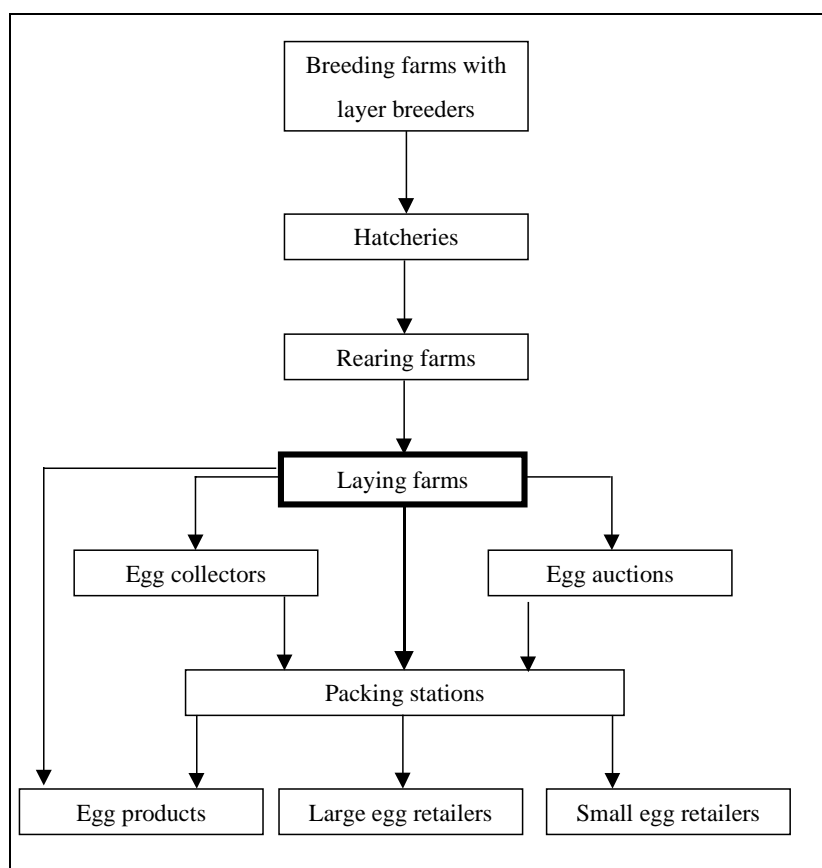

Figure 1.2: Dynamics of egg production and consumption in the EU [153, Eurostat, 2001]

The production chain of the egg production sector is a sequence of different activities, each representing one breeding or production step. The breeding, hatching, rearing and egg laying often take place at different sites and on different farms to prevent the possible spread of diseases. Layer farms, particularly the larger ones, often include grading and packing of eggs after which the eggs are delivered directly to the retail (or wholesale) market.



**Figure 1.3: Example of the production chain of the egg production sector**  
[26, LNV, 1994]

No information was provided on the structure, position and developments of other egg producing sectors (in particular ducks). They form only a very small activity in comparison with the chicken egg production sector.

## 1.2.2 Broiler production

According to DG Agriculture unit D2, the total production of poultry meat in the EU-15 was 8.784 megatonnes for the year 2000, of which 8.332 megatonnes were consumed within the EU. The balance, 0.452 megatonnes (5.1 %) was net export. [203, EC, 2001]

The biggest producer of poultry meat in the EU-15 (year 2000) is France (26 % of EU production), followed by United Kingdom (17 %), Italy (12 %) and Spain (11 %). Some countries are clearly export-oriented, such as the Netherlands, where 63 % of the production is not consumed within the own country, as well as Denmark, France and Belgium where 51 %, 51 % and 31 % respectively of production are not consumed within the own country. On the other hand, some countries such as Germany, Greece and Austria have consumptions higher than their own production; in those countries, 41 %, 21 % and 23 % respectively of total consumption is imported from other countries. [203, EC, 2001]

Production of poultry meat has been increasing since 1991 by an average of 232000 tonnes per year. The largest EU producers (France, UK, Italy and Spain) all showed an increase in their poultry meat production.

From 1991 and up to the year 2000, France and the United Kingdom increased their production by 24.4 % and 38.3 % respectively, while Spain increased its by 11.9 % [203, EC, 2001]. While egg production in the European Union can be described as “flat”, the sector’s growth is in

poultry meat. Public concern about the consumption of beef and veal and pork may further enhance this growth.

Personal consumption has been increasing by an average of 459 grams per person; that means that EU-15 consumption increased by 170666 tonnes per year (1999). Exports to other countries have also been increasing, by an average of 38000 tonnes per year.

The Member States with the largest consumption in the EU are France, UK, Germany and Spain. They all increased their consumption between 1991 and 2000: France by 21 %, Germany and Spain by 41 % and 11 % respectively. The United Kingdom became the main consumer of poultry meat from 1994 onwards; its consumption has increased by 51 %. [203, EC, 2001]

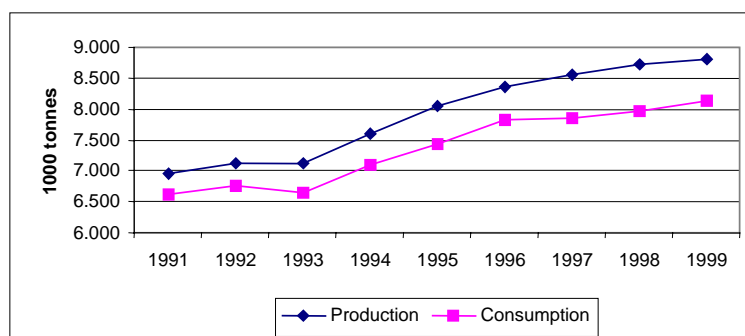

**Figure 1.4: Dynamics of poultry meat production and consumption in the EU**  
[153, Eurostat, 2001]

The production of broilers is a specialised part of the broiler production chain. The different steps in the broiler chain are shown in Figure 1.5. This document addresses in particular the broiler production farms. Broilers are generally not housed in cages, although cage systems exist. The majority of poultry meat production is based on an all-in all-out system applying littered floors. Broiler farms with over 40000 bird places are quite common in Europe. The duration of a production cycle depends on the required slaughter weight, feeding and the condition (health) of the birds and varies between 5 weeks (Finland) and 8 weeks [125, Finland, 2001], after which the broilers are delivered to the slaughterhouse. After every cycle the housing is fully cleaned and disinfected. The length of this period varies from 1 week up to two (Finland, UK) or even three weeks (Ireland).

A type of production that has so far been specific to France involves the so-called “red label” broiler. The broilers have permanent access to the open range and are slaughtered at the minimum age of 80 days, at more than 2 kg live weight. This type of production is gaining popularity and represents to date (year 2000) close to 20 % of the French broiler consumption. [169, FEFAC, 2001] (with reference to ITAVI, 2000)

The turkey production sector is the largest of the other poultry meat producing sectors. It is an important sector in four Member States (France, Italy, Germany and the UK). Since 1991 the production in the EU has increased by 50 %. [203, EC, 2001] Annual patterns of turkey poult placings in the EU show similar patterns with four peak placings in February-March, June, August-September and November-December.



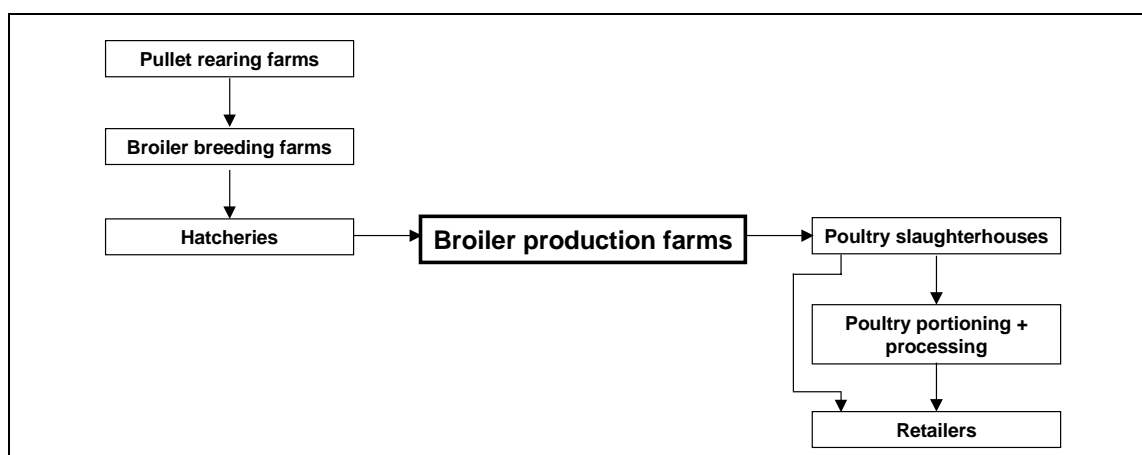

**Figure 1.5: Example of the production chain of the broiler production sector**  
[26, LNV, 1994]

### 1.2.3 Economics of the poultry sector

The majority of poultry farms are family run enterprises. Some farms belong to large holdings carrying out all that activities that are part of a production line, from production to retail and including animal feed supply. The investment in livestock and production items (equipment, housing) is linked with the farms' net margin. The net margin of poultry farms varies in each Member State and depends on production costs and product price. Production costs may consist of:

- costs for chicks (except in integrated systems)
- feed costs
- veterinary costs
- labour costs
- energy costs
- maintenance of equipment and buildings
- depreciation costs for equipment and buildings
- interest.

The cost of egg production is also clearly related to production factors such as the stocking density. Production costs are lowest in multi-bird cages; costs increase with increasing space allowances in cages and with the use of non-cage systems. The production of free-range eggs is considerably more costly than any other system. Therefore higher welfare standards currently being adopted in the EU as a result of Directive 1999/74/CE, which requires more space for the birds, will increase production costs. It is expected that this may lead to increasing imports from countries with lower welfare standards (and therefore lower production costs) at the detriment of EU produced eggs if consumers are not prepared to pay a higher price.

System	Available area	Relative costs
Cage	450 cm <sup>2</sup> /bird	100
Cage	600 cm <sup>2</sup> /bird	105
Cage	800 cm <sup>2</sup> /bird	110
Aviary/Perchery	500 cm <sup>2</sup> /bird	110
Aviary/Perchery	833 cm <sup>2</sup> /bird	115
Deep litter	1429 cm <sup>2</sup> /bird	120
Free range	100000 cm <sup>2</sup> range/bird	140

**Table 1.2: Summary of egg production costs in different systems**  
[13, EC, 1996]

The gross income of a farm depends on the number of eggs or kg of live weight that can be sold and the prices the farmer receives (including the price of end-of-lay hens). The prices of poultry products are not guaranteed or fixed and fluctuate with price fluctuations in the market. This market is in turn affected by the dynamics and the structure of the large grocery retailers (15 in 1999), who are the main outlets for the poultry products and are therefore responsible for the major part of the annual turnover of poultry products.

In 1999, the average price for eggs in the European Union was EUR 78.87/100 kg (EUR 0.049/egg). In 2000, the average price for eggs was EUR 100.39/100 kg (EUR 0.062/egg). Egg and layer feed prices have been decreasing since 1991. Overall, the gross margin for egg production has slightly decreased since 1991. [203, EC, 2001]

In 1998, the average price for broiler meat in the European Union was EUR 143.69 /100 kg. In 1999, the average price for poultry meat from January to September was EUR 133.44 /100 kg. Meat prices have been decreasing ever since 1991, but at the same time feed prices have decreased as well. Generally, since 1991 the gross margin for broiler production has decreased.

Prices are also affected when the sector is hit by product contamination (salmonella and dioxins) or by problems that affect other animal product markets (swine fever, BSE). These effects can be regional, but in particular with export oriented MSs, problems can be easily transferred to the wider European market.

For example, the dioxin crisis in mid-1999 associated with the contamination of animal feedstuffs severely affected the markets for poultry meat and eggs in Belgium.. As products were removed from the shelves of retail outlets, both consumption and prices fell. Whilst the crisis had a severe effect on the financial position of the Belgian industry, neighbouring MSs also felt the effects as both their consumption and prices showed a decline as well. On the other hand, outbreaks of foot-and mouth disease, swine fever and BSE in particular shifted consumer behaviour towards an increased consumption of poultry products.

Few economic data have been submitted on fresh turkey production. The September 2000 National Farmers Union (NFU) market report on fresh turkeys reports on the costs (per bird marketed). As an indication of costs, costs for the finishing of hens were EUR 18 per bird (6.4 kg deadweight) to 22 per bird (6.3 kg deadweight) and for stags EUR 19.5 per bird (6.7 kg deadweight) to 23.4 per bird (10 kg deadweight). These costs depend on the price for a poult, whose starting weight will vary, and on the end weight of the birds when they are sold. Costs also include plucking and bleeding. [126, NFU, 2001]

Member State	Layers			Broilers			Turkeys			Ducks			Guinea fowls		
	Birds (10 <sup>6</sup> )	Farms	IPPC	Birds (10 <sup>6</sup> )	Farms	IPPC	Birds (10 <sup>6</sup> )	Farms	IPPC	Birds (10 <sup>6</sup> )	Farms	IPPC	Birds (10 <sup>6</sup> )	Farms	IPPC
B (2000) <sup>1)</sup>	12.7	4786	172 (50000) <sup>2)</sup>	26.6	2703	320 (50000) <sup>2)</sup>	0.3	232	n.d.	0.04	853	n.d.	0.06	206	n.d.
D	n.d.	n.d.	549 (20000) <sup>2)</sup>	n.d.	n.d.	432 (25000) <sup>2)</sup>	n.d.	n.d.	264 (10000) <sup>2)</sup>	n.d.	n.d.	n.d.	n.d.	n.d.	n.d.
E	40.7	n.d.	n.d.	n.d.	n.d.	n.d.	0.135	n.d.	n.d.	0.092	n.d.	n.d.	n.d.	n.d.	n.d.
FIN (1999) <sup>1)</sup>	3.6	4000	2	5.5	227	64	0.150	55	n.d.	0.003	2	n.d.	none	n.d.	n.d.
IRL	n.d.	n.d.	n.d.	n.d.	n.d.	141	n.d.	n.d.	n.d.	n.d.	1	n.d.	n.d.	n.d.	n.d.
I	47.2	2066	n.d.	475.7	2696	n.d.	38.9	750	n.d.	10.1	n.d.	n.d.	25.3	n.d.	n.d.
NL	32.5	2000	n.d.	50.9	1000	n.d.	1.5	125	n.d.	1	65	n.d.	0.2	20	n.d.
A	n.d.	n.d.	22	n.d.	n.d.	11	n.d.	n.d.	n.d.	n.d.	n.d.	n.d.	n.d.	n.d.	n.d.
P (1998) <sup>1)</sup>	6.2	622	25 (50000) <sup>2)</sup>	199	3217	43 (50000) <sup>2)</sup>	4.7	176	20 (50000) <sup>2)</sup>	0.3	12	0	very few	n.d.	n.d.
S	2.2	900	0	n.d.	n.d.	n.d.	n.d.	n.d.	n.d.	n.d.	n.d.	n.d.	n.d.	n.d.	n.d.
UK	n.d.	n.d.	>200	n.d.	n.d.	700	n.d.	n.d.	20	n.d.	n.d.	10	n.d.	n.d.	n.d.

1) year of report  
2) the number of places, some data were reported with different thresholds than the IPPC-threshold as IPPC threshold in practical statistics does not apply.  
“n.d.” no data submitted or available

**Table 1.3: Number of birds, total farms and farms under definition of Section 6.6 of Annex 1 of Council Directive 96/69/EC for different European Member States**

**Resources:** as reported by Member States in comments and national BAT documents (see references)

## 1.3 The pig production sector in Europe

### 1.3.1 Dimension, evolution and geographical distribution of the pig production sector in Europe

The dynamics of the European pig producing industry are closely followed and described in detail by national and European institutes (e.g. FAO, LEI, MLC, Eurostat). The data in the following sections have been derived from these sources to draw a general picture of the pig producing sector.

In the EU-15, pig production increased by 15 % between 1997 and 2000. The total number of pigs in December 1999 was 124.3 million, which was a 5.4 % increase as compared with 1997. This increase was mainly attributable to growth in pig populations in Spain, the Netherlands and Germany (the latter reflecting a recovery following the outbreak of classical swine fever), which offset declines in the United Kingdom population.

In 1999 production slowed down, but the effects of the recent foot-and-mouth outbreak are not included. Yearly patterns show that pigmeat production is always highest in the last quarter of the year.

Although the pig population surveys conducted in the Member States in December 2000 reveal a slight decline compared with 1999 (-1.2 %), the overall level remained high (122.9 million animals). The biggest falls were recorded in Austria, Finland, Sweden and UK, whilst the total pig population rose by approximately 6.1 % in Denmark.

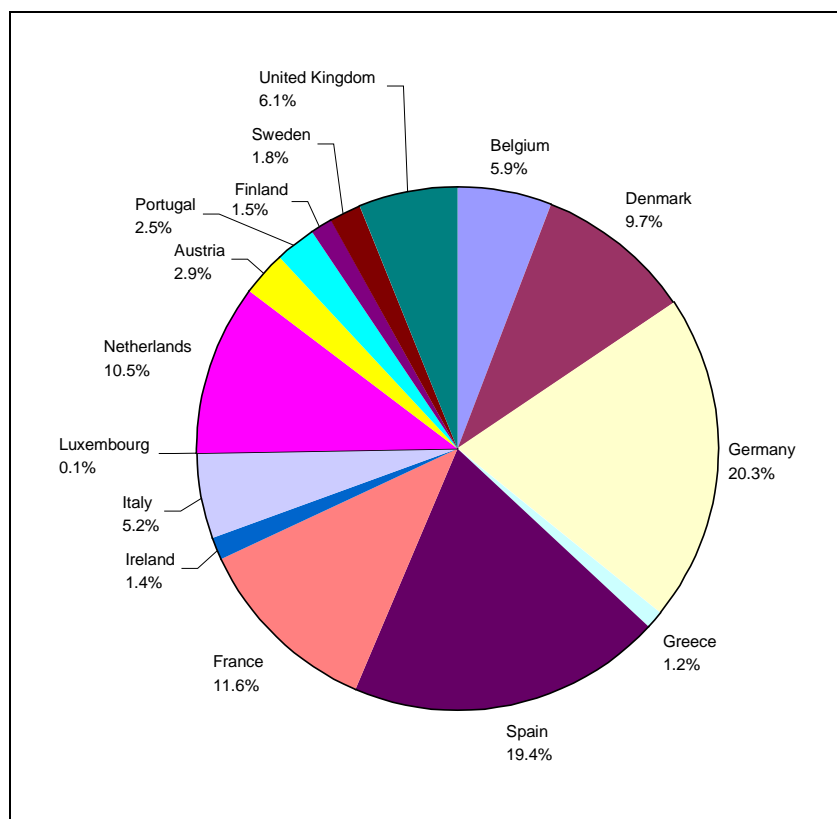
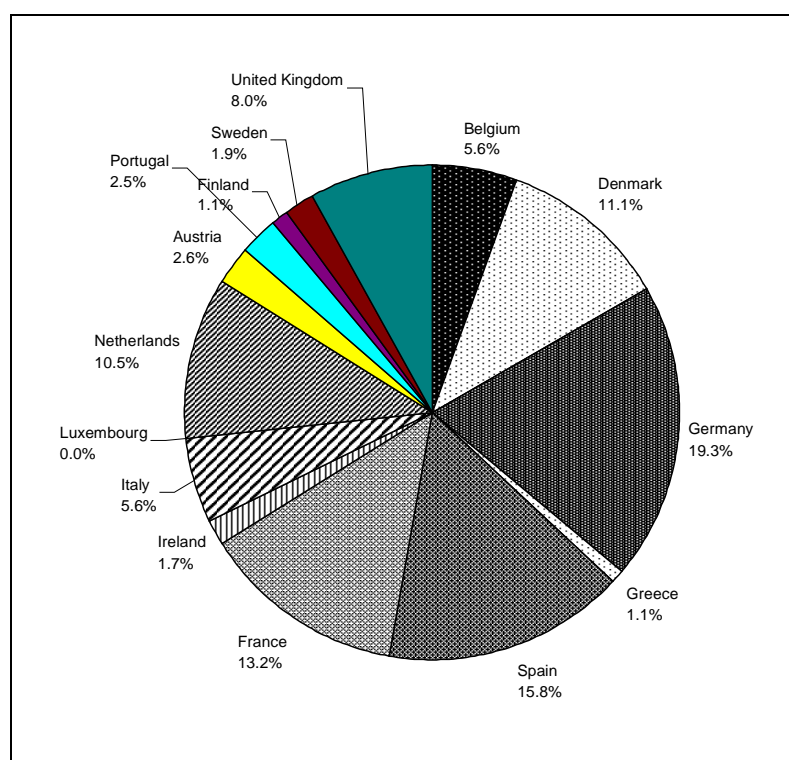

**Figure 1.6: Distribution of breeding sows in Europe for each Member State in 1998**  
[Eurostat Nov/Dec 1998 Surveys]

In 2000, the pig population in EU-15 consisted of an estimated 33.4 million piglets (< 20 kg), 46.9 million finishers (> 50 kg) and 12.9 million breeders (> 50 kg), 0.4 million boars and 21.1 million sows (12.5 breeding and 8.6 mated).

The major pig breeding Member States are Germany, Spain, France, the Netherlands and Denmark with a combined share of 71 % of the breeding sows in 1998 (Figure 1.7). Data for 2000 show that this has increased slightly (73 %), with increases in Denmark and Spain offsetting clear declines in the Netherlands and, to a lesser extent, in Germany.

Sow numbers are reflected in terms of pig output or gross indigenous production (GIP). Again, Germany, Spain, France, Denmark and the Netherlands produced 69.5 % of EU-15 pigs in 1998 (Figure 1.7) and increased their production, so that in 2000 they account for more than 73 % of the total Community output. GIP trends in the Member States show that Ireland, the Netherlands and the UK, in particular, have reduced their production.



**Figure 1.7: Gross indigenous pig production in 1998**  
[Eurostat Nov/Dec 1998 surveys]

Pig farms vary considerably in size. The most recent figures available on unit size relate to 1997. While pig numbers have increased in Europe, the number of units has declined, but individual farm facilities have become larger. The largest average unit size is found in Ireland (1009 heads), followed by the Netherlands (723), Belgium (629), Denmark (605) and the United Kingdom (557). Throughout the EU-15, 71 % of pig farmers have less than 10 pigs. This is common in Greece, Spain, France, Italy, Austria and Portugal, where over 50 % of holders have less than 10 pigs (Figure 1.8). A further 10 percent of units in the EU have herd sizes of between 10 and 49 pigs. Although most holders have small units, the majority of pig production (88 %) is associated with units larger than 200 pigs, 52 % of the units have even more than 1000 pigs (Figure 1.9).

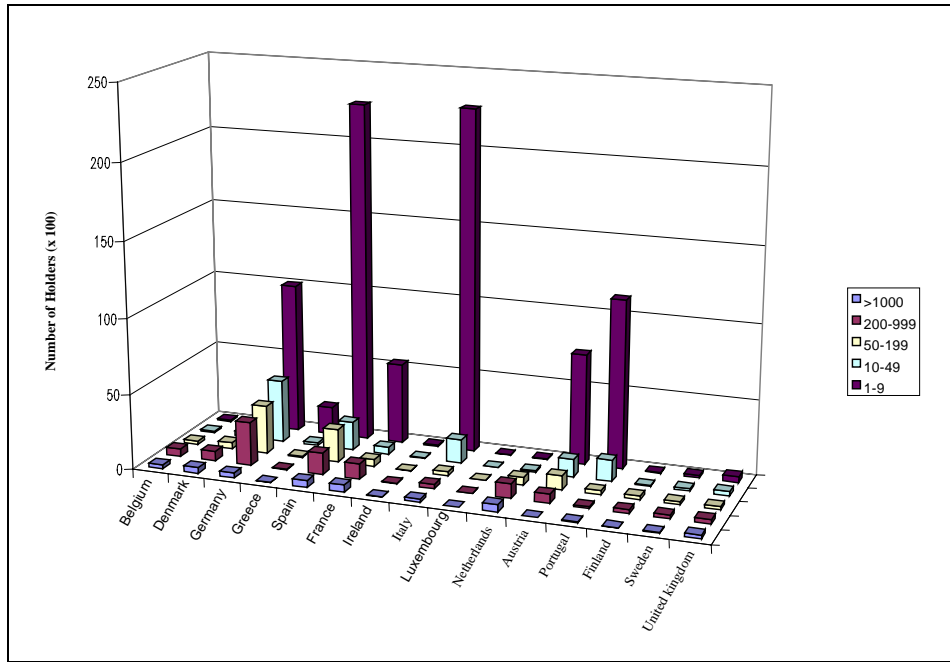

Figure 1.8: Number of holders by unit size in 1997. Legend indicates unit size (in reverse order) [153, Eurostat, 2001]

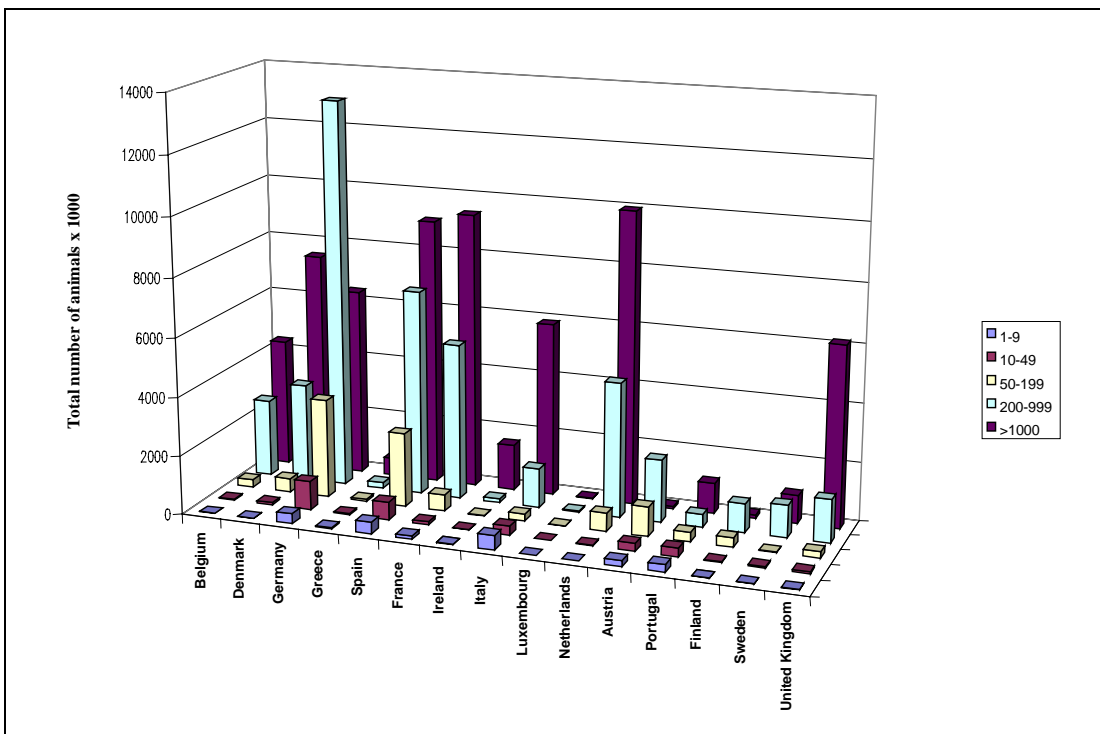
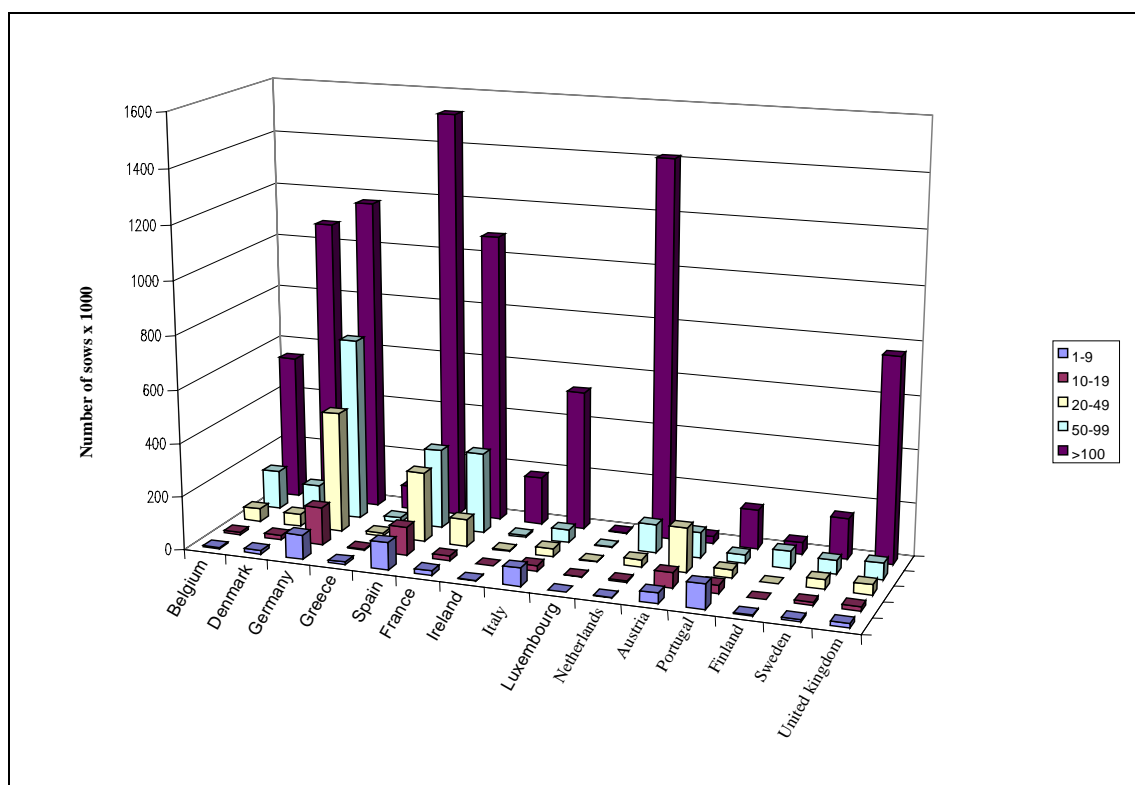

Figure 1.9: Number of animals in unit size categories (1997) [153, Eurostat, 2001]

Across the EU-15, 67 % of sows are in units of more than 100 sows (Figure 1.10). In Belgium, Denmark, France, Ireland, Italy, the Netherlands and the United Kingdom this figure is over 70 %. In Austria, Finland and Portugal smaller sow units are predominant.



**Figure 1.10: Number of sows in different sized units (1997). Legend indicates size of unit in terms of number of sows**  
[153, Eurostat, 2001]

The majority of pigs for fattening (81 %) are reared on units of 200 pigs or more (Figure 1.11) and 63 % of them on units of more than 400 pigs. 31 % of fattening pigs are reared on holdings of more than 1000 pigs. The industry in Italy, United Kingdom and Ireland is characterised by units of more than 1000 fattening pigs. Germany, Spain, France and the Netherlands have significant proportions of pigs in units of between 50 and 400 fattening pigs.

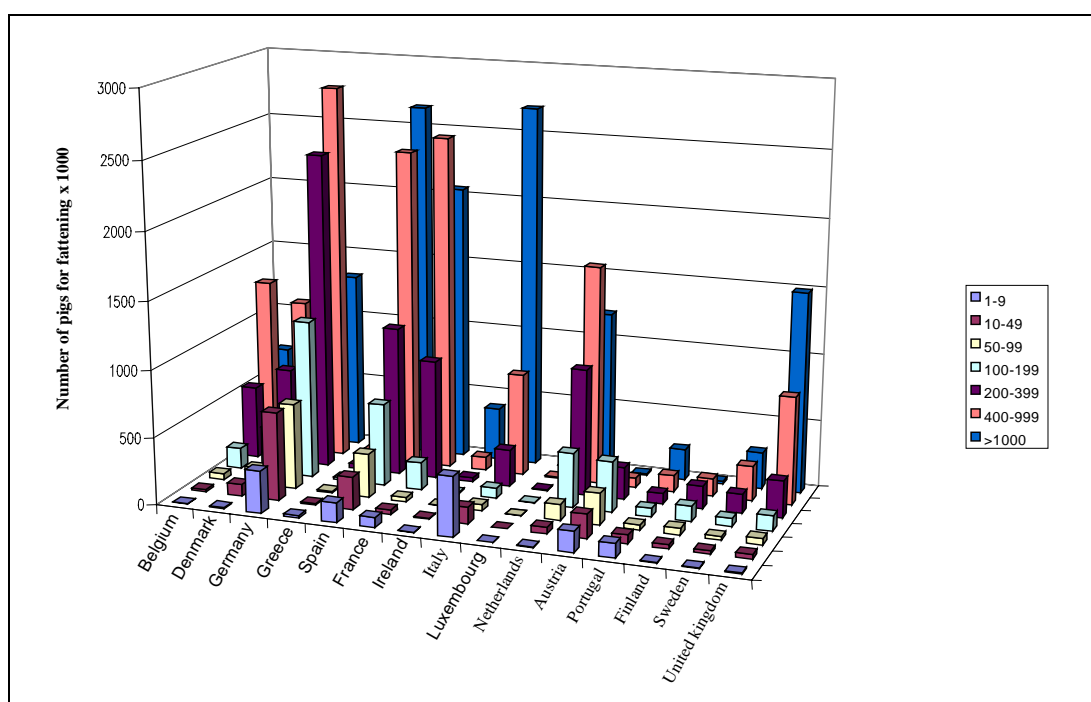

**Figure 1.11: Number of pigs for fattening on various size units (1997)**  
[153, Eurostat, 2001]

From these numbers it is obvious that only a relatively small number of farms will fall within the definition of Section 6.6 of Annex 1 of Council Directive 96/69/EC (Table 1.4).

Member State	Pigs (>30 kg)			Sows		
	Number of animals (million)	Number of farms	Farms under IPPC	Number of animals (million)	Number of farms	Farms under IPPC
B (2000)	2.9	7487	71	0.8	7450	n.d.
DK (1997)	6.2	n.d.	n.d.	1.2	n.d.	n.d.
D (1997)	15.6	n.d.	261	2.6	n.d.	281
E (1997)	11.6	n.d.	822	2.1	n.d.	252
F (1997)	9.9	n.d.	n.d.	1.4	n.d.	n.d.
FIN (1997)	0.79	4727	6	0.18	n.d.	n.d.
IRL (1997)	1.0	n.d.	n.d.	0.19	n.d.	n.d.
I (2001)	0.958	n.d.	407	0.147	n.d.	116
NL (1997)	7.2	n.d.	n.d.	1.4	n.d.	n.d.
A	n.d.	n.d.	6	n.d.	n.d.	n.d.
P (1997)	1.3	n.d.	n.d.	0.33	n.d.	n.d.
UK (1997)	4.7	n.d.	n.d.	0.9	n.d.	n.d.
<i>1997-data are reported in [10, Netherlands, 1999] with reference to Eurostat '97</i> <i>Belgium data for pigs refer to pigs &gt;50 kg live weight</i> <i>German data on IPPC-farms refer to more than 1500 pigs and more than 500 sows</i> <i>Spanish data on IPPC-farms refer to fewer than 750 sows and more than 2000 pigs</i> <i>Finish data refer to growers &gt;20 kg live weight</i> <i>n.d. = no data</i>						

**Table 1.4: Number of pig farms in European Member States under definition of Section 6.6 of Annex 1 of Council Directive 96/69/EC**

In most countries, pig production is concentrated in certain regions, e.g. in the Netherlands pig production is concentrated in the southern provinces. Based on 1994 data, densities of 2314 pigs per 100 ha in Noord-Brabant and 1763 in Limburg have been quoted.

Pig farming in Belgium is strongly concentrated in West Flanders (approximately 60 % of the pig population). In France intensive pig production is concentrated in Brittany (approximately 50 % of the pig population), where larger herd sizes are common.

In Germany pig production is concentrated in the north-west, i.e. in the northern counties of Westphalia and the southern counties of the Weser-Ems-Region in Lower Saxony. Data for 1994 suggests a maximum concentration of 1090 pigs per 100 ha in the Vechta region.

Italy has concentrations of pig production in the Po valley. Currently 73.6 % of Italian pig farming assets are located in the four regions of Lombardia, Emilia-Romagna, Piemonte and Veneto within the Po valley.

The spatial density of pig production is used as an indicator of the potential environmental impact of pig production. Data on total pig numbers per 100 ha of utilised agricultural area (UAA) for each Member States are presented in Figure 1.12. Highest densities are apparent in the Netherlands, Belgium and Denmark, but national statistics can hide regional concentrations of pig production and, for most European MSs, high animal densities and intensive livestock farming are regional concerns (see Figure 1.1).



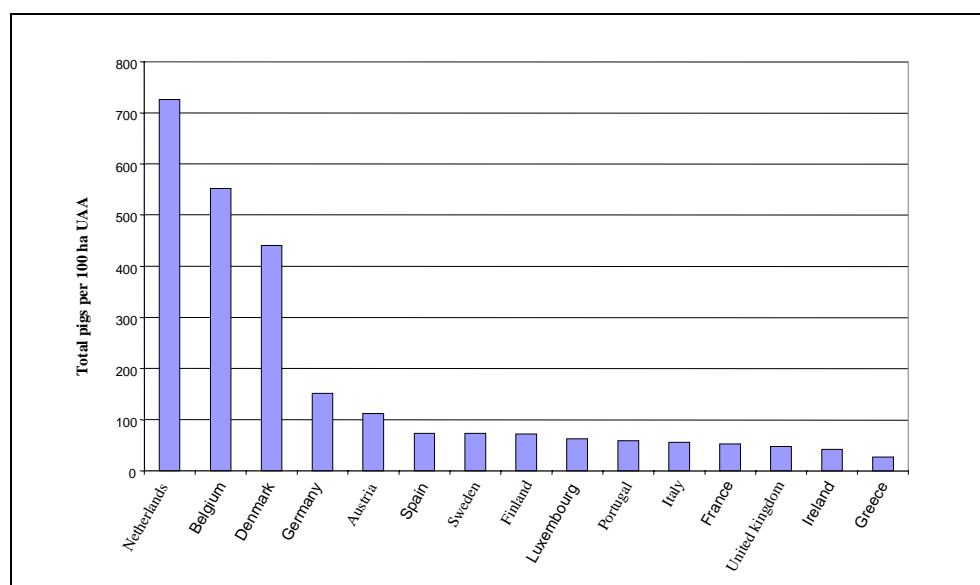
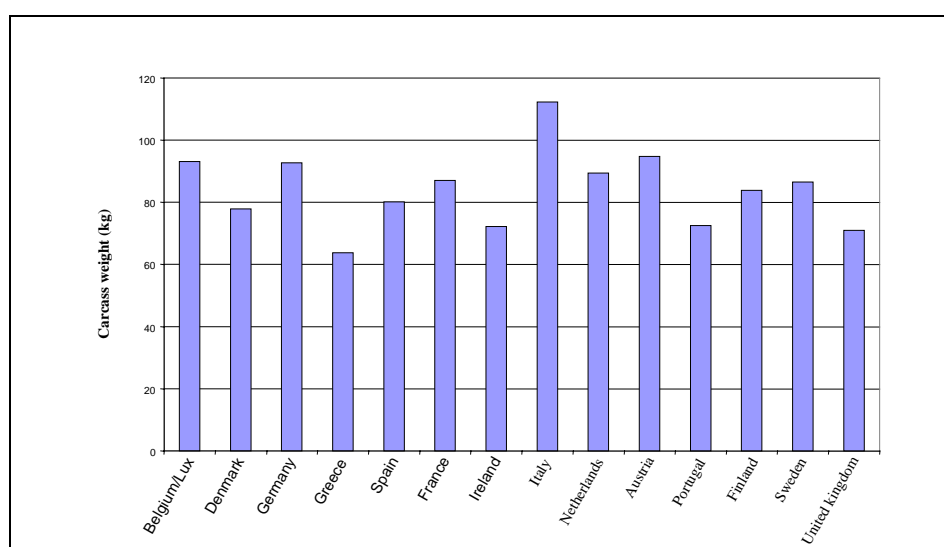

**Figure 1.12: Spatial density of pig production in the EU-15**  
[153, Eurostat, 2001]

### 1.3.2 Production and consumption of pork

The EU-15 accounts for approximately 20 % of the world pork production, as indicated by slaughtered carcass weight. In 2000, the industry in the EU-15 was responsible for an average monthly pork slaughtering of 1.464 (1.328 – 1.552) million tonnes of carcass weight, whether of indigenous or foreign origin, which totalled 17.568 million tonnes of pork in a year. For comparison, this was more than twice the carcass weight of beef and veal slaughterings over the same period of time [153, Eurostat, 2001].

The average weight to which pigs are finished and their average carcass weight vary throughout the EU. This has a significant impact in relation to the period of time that the pigs are housed, the quantity of feed consumed, and the volume of effluent produced. For example in Italy, heavy pigs are reared to an average live weight of 156 kg, yielding a carcass weight of 112 kg. Generally, higher than average carcass weights (in excess of 80 kg) are also produced in Austria, Germany and Belgium (finished 117 kg / carcass 93 kg) (see Figure 1.13).



**Figure 1.13: Carcass weight of slaughtered pigs for each Member State**  
[153, Eurostat, 2001]

Comparing data on carcase weight and live weight, allows in general an average ratio to be derived where the carcase weight is approximately 75 % of live weight. As an expected 204 million pigs were slaughtered in 2000 with an estimated average live weight of 100 kg, this means that the indigenous pig slaughterings have amounted to an estimated 15.3 million tonnes of carcase weight. The major producer of pork is Germany (20 %), followed by Spain (17 %), France (13 %), Denmark (11 %) and the Netherlands (11 %). Together they produce more than 70 % of the EU-15 indigenous production.

Not all of this production is consumed in the Member States themselves. As a whole, the EU is a net exporter of pork, importing only a very small amount (Figure 1.14). Not every major producer is an exporter, for instance Germany is a major producer but still imported about twice as much as it exported in 1999.

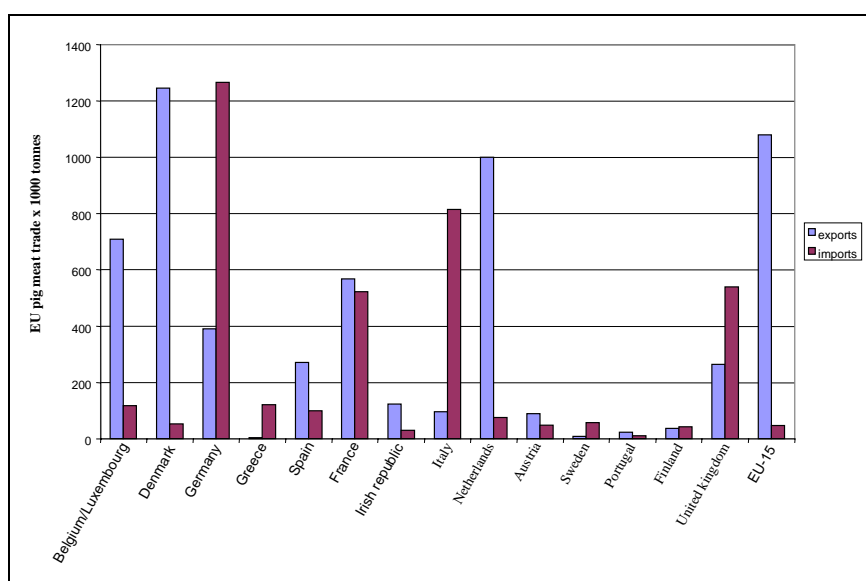

Figure 1.14: Pigmeat trade by European Member States [Eurostat, 1999]

With varying live weights at the end of the finishing period, the period of time needed for rearing a pig also varies in the EU-15. Many factors influence this, such as the feeding, farm management and market demands requiring a certain quality pork. As an example, some production data are shown describing production in the UK.

Species	Characteristic	Unit	Level
Breeding	Offspring	pigs/sow/year	22
Weaners	Live weight range	kg	7 – 35
	Gain	g/day	469
	FCR	kg feed/kg live weight	1.75
Growers/finishers	Live weight range	kg	35 – onwards
	Gain	g/day	630
	FCR	kg feed/kg live weight	2.63

Table 1.5: General production levels pig farming UK [131, FORUM, 2001]

On an EU-wide basis, the consumption of pig meat is higher than for any other meat. Over the past two years, competitive prices and plentiful supplies have driven consumption to new record levels. Per capita consumption in 2000 as a whole was forecast to be about 43.5 kg compared with 41.2 kg in 1997 [203, EC, 2001]. (See Figure 1.15).

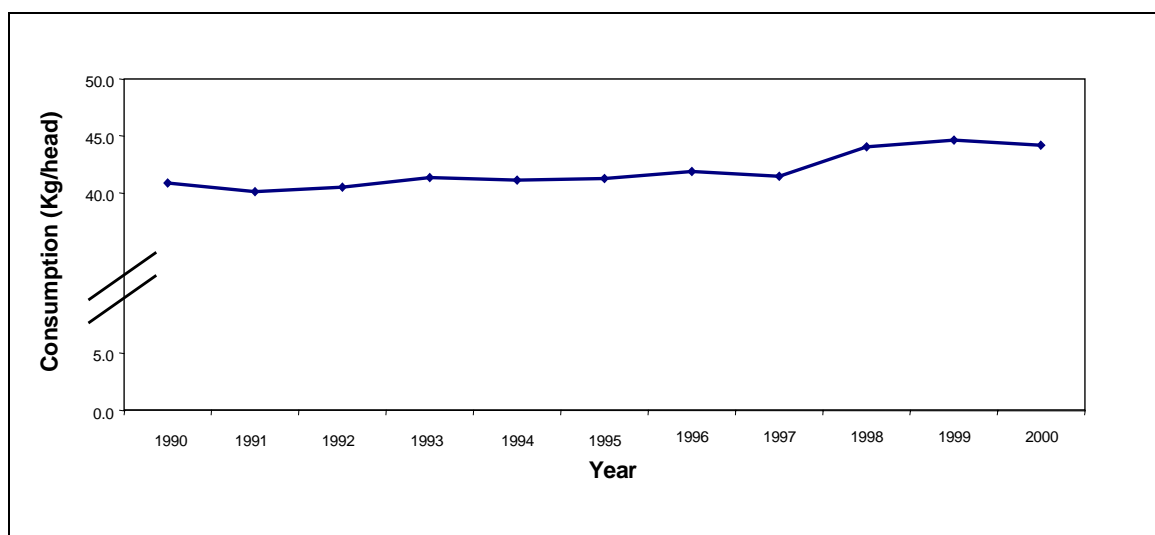

**Figure 1.15: Consumption of pig meat per capita (kg/person) over time in Europe [153, Eurostat, 2001]**

The highest per capita pig meat consumption both in terms of quantity and as a relative proportion of total meat consumption was recorded in 1999 in Denmark (65.8 kg/person of pig meat, compared to a total meat consumption of 117.8 kg/person). Similar levels of pig meat consumption per capita, although with slightly lower figures, are found in Germany, Spain and Austria. Spain has the highest overall consumption of meat in the EU, although it has been remarked that the annual 30 million tourists may contribute to this high amount. While Sweden and Finland have the lowest overall meat consumption in the EU (72 and 69 kg/person respectively), Greece (32 %) and UK (23 %) have the lowest proportional consumption of pig meat. [203, EC, 2001]

### 1.3.3 Economics of the pig sector

The economics of pig production are largely dictated by the availability of feed and access to suitable markets. This has led to regional development of the industry, for example in the Po valley, where pig production has developed in association with cereal growing and dairy production, and due to the easy access to transport.

More recently, environmental constraints have led to a link between production and the availability of land for the irrigation of effluent. Denmark has a definite advantage over pig producers in the Netherlands and several other countries in that its pig population is spread across the entire country, and thereby it has a low density of pigs in relation to land area. The Danish farm system generally combines pig production with mixed farming; allowing effluent to be used in a manner that lessens the environmental hazard. The association with mixed farming also provides benefits in terms of feed costs. A similar situation exists in the concentrated pig production areas in Germany, where pig production is associated with mixed farms, again facilitating a control of the feed inputs and irrigation of the effluent.

Pig density in Spain as a whole is very low, but there is a concentration of intensive pig farming and other agricultural activity in the northern Autonomous Communities (e.g. in Cataluña). There are still many areas where manure can be applied without a potential risk of water pollution by nitrates. It has been stated that the application of animal manure to land is of great agronomic interest to Spain as, along with the savings on chemical fertilisers, it can also improve the structure and fertility of most Spanish soils and can contribute significantly to the fight against desertification. These favourable circumstances support the growth of the sector and even the setting up of foreign companies. [89, Spain, 2000]

Generally, pig production in the EU does not tend to show the level of vertical integration found in the poultry sector, for instance the breeding and finishing of pigs are often carried out in separate facilities. In recent years there has been a tendency towards a more integrated approach with an individual or company based control of feed supply, pig production and slaughtering capacities. There is also a trend that even in situations where breeding and finishing are undertaken on separate sites, these may be owned by a single producer. The most developed integrated production systems are in Denmark, under the guidance of the Federation of Danish Pig Producers and Slaughterhouses (Danske Slagterier).

Few data have yet been submitted on the economic situation and profitability of the pig farming industry. Profitability data are needed to allow the determination of BAT. For this the profitability per sector and per country would be necessary to allow for differences between MSs (see Annex 7.6) to be accounted for.

Pig farming is typically characterised by periods of relatively high profits alternating with periods of negative margins. For Europe as a whole, prices have dropped and the scope for investments at the farm level has become more limited. Many farmers have adopted an attitude of waiting in anticipation for better times. In some countries (such as the Netherlands and the Flemish Region of Belgium) environmental problems have led to calls for fewer pig places and many farms are expected to close down. An increasing debate in some MSs is expected to put intensive livestock farming in general, and pig production in particular, under more pressure and some structural changes in the pig production sector are expected in the coming years.

Where investments are made, there are a variety of reasons why farmers might decide to invest in environmental techniques. Often, national legislation pushes them towards the application of certain techniques, but also the requirements of the large grocery retailers can affect the choice and operation of production techniques. Increasing attention is being paid to animal welfare issues, such as the use of straw and access to an outdoor area. It should be borne in mind that techniques applied under the scope of "animal welfare" legislation are not always associated with the best environmental performance.

The financial terms under which commitments have to be made and under which new techniques are purchased by farmers vary largely between Member States and even between regions within Member States. Two clear examples were reported. The Finnish agri-environmental support programme [125, Finland, 2001] gives assistance to farmers if they participate in a special programme that requires them to take certain actions to reduce the impact of farming activities on the environment; these actions might involve making certain investments, or taking measures, for instance to reduce fertiliser use. In Finland it is also possible to get financial assistance for investments, for example to build new manure storage (Farm investment aid). This assistance can be direct financial assistance, or a loan by a credit institution with interest support, or a government loan at reduced interest. [188, Finland, 2001]

A regional programme was set up by Emilia-Romagna (Italy) to push farmers into investing in techniques for better manure management [127, Italy, 2001]. This programme adopted, for instance, flushing systems with canals, equipment for solid separation of pig slurry, tanks for pig slurry and cages for layers equipped with belt and forced drying.

### **1.4 Environmental issues of intensive poultry and pig farming**

Environmental issues have only been on the agricultural agenda for a relatively short period of time. It was not until the eighties that the environmental impact of intensive livestock farming really became an issue, although there was already an awareness of the contamination of soil due to excess manure application and of odour increasingly becoming an issue due to an increasing population in the rural areas.

One of the major challenges in the modernisation of poultry and pig production is the need to balance the reduction or elimination of the polluting effects on the environment with increasing animal welfare demands, while at the same time maintaining a profitable business.

Potentially, agricultural activities on intensive poultry and pig farms can contribute to a number of environmental phenomena:

- acidification ( $\text{NH}_3$ ,  $\text{SO}_2$ ,  $\text{NO}_x$ )
- eutrophication (N, P)
- reduction of ozone-layer ( $\text{CH}_3\text{Br}$ )
- increase of greenhouse effect ( $\text{CO}_2$ ,  $\text{CH}_4$ ,  $\text{N}_2\text{O}$ )
- desiccation (groundwater use)
- local disturbance (odour, noise)
- diffuse spreading of heavy metals and pesticides.

Increasing knowledge of the different sources responsible for these environmental phenomena has increased the attention paid to a number of environmental aspects associated with the intensive rearing of poultry and pigs. The key environmental aspect of intensive livestock production is related to the natural living processes, i.e. that the animals metabolise feed and excrete nearly all the nutrients via manure. The quality and composition of the manure and the way it is stored and handled are the main factors determining the emission levels of intensive livestock production.

From an environmental point of view, the efficiency with which pigs convert feed for maintenance, growth speed and breeding is important. The pigs' requirements will vary during different stages of their life, e.g. during the rearing and growth periods or during different stages of their reproductive life. To be sure that their nutritional requirements are always met, it has become customary to feed nutrients at levels in excess of the animals' requirements. At the same time, emissions of N into the environment can be observed which are partly due to this imbalance. The process of N consumption, utilisation and losses in the production of slaughter pigs is quite well understood (see Figure 1.17).

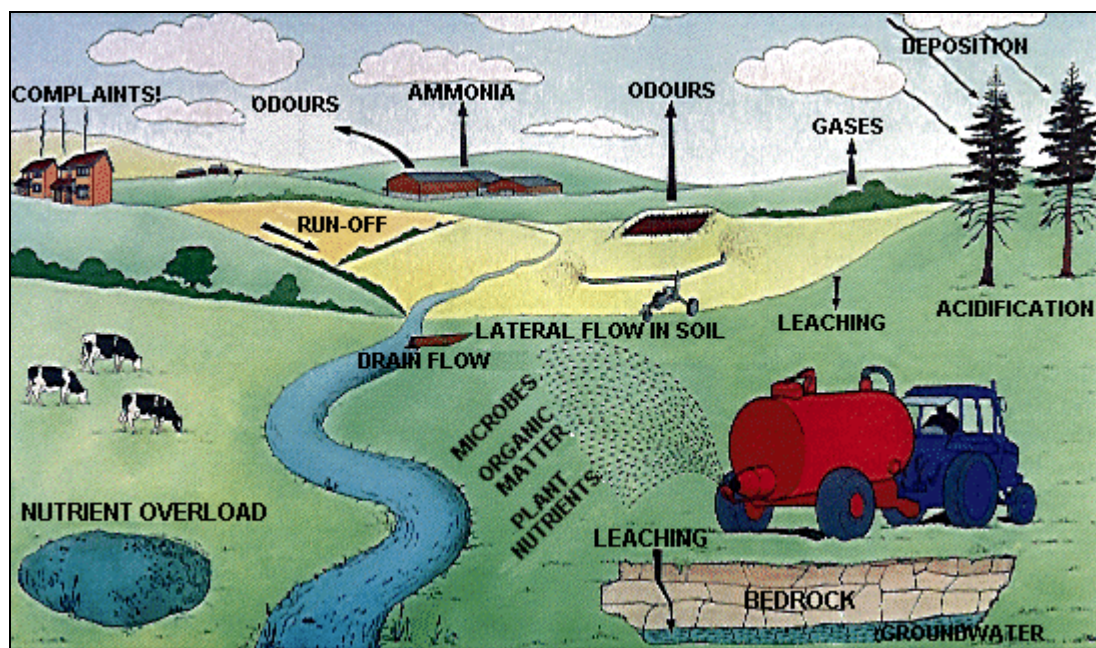

Figure 1.16: Illustration of environmental aspects related to intensive livestock farming [152, Pahl, 1999]

With research having started only relatively recently, many aspects are not known or quantified yet. Emissions are often diffuse and very difficult to measure. Models have been and still are being developed to allow accurate estimations of emissions to be made where direct measurements are not possible. Also, a number of aspects have only just been identified, where focus still is on emissions of ammonia (NH<sub>3</sub>) and on emissions of N and P to soil, groundwater and surface water.

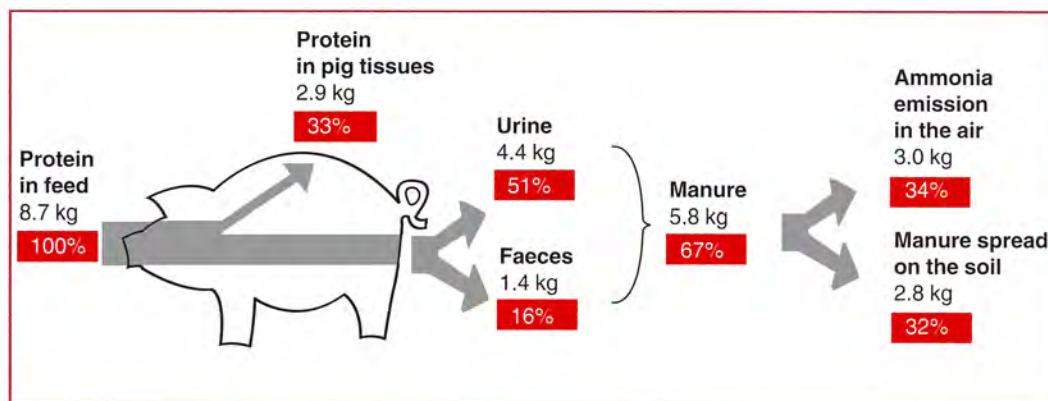

Figure 1.17: Consumption, utilisation and losses of protein in the production of a slaughter pig with a final live weight of 108 kg [99, Ajinomoto Animal Nutrition, 2000]

### 1.4.1 Emissions to air

Air	Production system
Ammonia (NH <sub>3</sub> )	Animal housing, storage of manure and landspreading of manure
Methane (CH <sub>4</sub> )	Animal housing, storage of manure and manure treatment
Nitrous oxide (N <sub>2</sub> O)	Animal housing, manure storage and landspreading
NO <sub>x</sub>	Heaters in buildings and small combustion installations
Carbon dioxide (CO <sub>2</sub> )	Animal housing, energy used for heating and transport on farm, burning of waste
Odour (e.g. H <sub>2</sub> S)	Animal housing, storage of manure, landspreading of manure
Dust	Milling and grinding of feed, feed storage, housing of animals, solid manure storage and application
Dark smoke/CO	Burning of waste

Table 1.6: Emissions to air from intensive livestock production systems

#### N-related emissions

Most attention has been paid to the emission of ammonia from animal housing, as it is considered an important compound for the acidification of soils and water. A technical expert group is specifically working on the abatement of emissions of ammonia under the framework of the UNECE programme on long-range transboundary air pollution [9, UNECE, 1999].

Ammonia gas (NH<sub>3</sub>) has a sharp and pungent odour and in higher concentrations can irritate the eyes, throat and mucous membranes in humans and farm animals. It slowly rises from the manure and spreads through the building and is eventually removed by the ventilation system. Factors such as the temperature, ventilation rate, humidity, stocking rate, litter quality and feed

composition (crude protein) can all affect the ammonia levels. Factors that influence the rate of ammonia emission are presented in Table 1.7. For example in pig slurry, urea nitrogen represents more than 95 % of the total nitrogen in pig urine. As a result of microbial urease activity, this urea can rapidly be converted into volatile ammonia.

High ammonia levels also affect working conditions for the farmer and in many MSs workplace regulations set upper limits for the acceptable ammonia concentration in working environments.

Processes	Nitrogen components and appearance	Affecting Factors
1. Faeces production	Uric acid / urea (70 %) + undigested proteins (30 %)	Animal and feed
2. Degradation	Ammonia/ammonium in manure	Process conditions (manure): T, pH, $A_w$
3. Volatilisation	Ammonia in air	Process conditions and local climate
4. Ventilation	Ammonia in poultry house	Local climate (air): T, r.h., air velocity
5. Emission	Ammonia in environment	Air cleaning
<i>Note: T: temperature, pH: acidity, <math>A_w</math>: water activity, r.h.: relative humidity</i>		

**Table 1.7: Schematic overview of processes and factors involved in ammonia release from animal houses**

The generation of gaseous substances in the animal housing also influences the indoor air quality and can affect the animals' health and create unhealthy working conditions for the farmer.

### **Other gases**

Much less is known about the emissions of the other gases, but some research is currently being carried out, in particular on methane and nitrous oxide. Increased levels of nitrous oxide can be expected from aerated liquid manure treatment processes, as well as with solid manure methods. The level of carbon dioxide resulting from respiration of the animals is proportional to the heat production of the animal. The carbon dioxide can accumulate in broiler houses if they are not properly ventilated.

Soil microbial processes (denitrification) produce nitrous oxide ( $N_2O$ ) and nitrogen gas ( $N_2$ ). Nitrous oxide is one of the gases responsible for the 'greenhouse effect', whilst nitrogen gas is harmless to the environment. Both can be produced from the breakdown of nitrate in the soil, whether derived from manure, inorganic fertilisers or the soil itself, but the presence of manure encourages this process.

### **Odour**

Odour is a local problem but is an issue that is becoming increasingly important as the livestock industry expands and as ever increasing numbers of rural residential developments are built in traditional farming areas, bringing residential areas closer to livestock farms. The increase in farm neighbours is expected to lead to increased attention to odour as an environmental issue.

Odour can be emitted by stationary sources such as storage, and can also be an important emission during landspreading, depending on the spreading technique applied. Its impact increases with farm size. Dust emitted from farms contributes to odour transport. In areas with a high density of pig production, plumes from one farm can potentially transfer diseases to other farms.

Odour emissions especially from large poultry farms, can give rise to problems with neighbours. Emissions of odour are related to many different compounds such as, mercaptans, H<sub>2</sub>S, skatole, thiocresol, thiophenol and ammonia [173, Spain, 2001].

### **Dust**

Dust has not been reported as an important environmental issue in the surroundings of a farm, but it may cause some nuisance during dry or windy weather. Inside the animal house, dust is known under certain circumstances to be a contaminant that can affect both the respiration of the animals and the farmer, such as in broiler houses with high litter contents.

As an example, emissions of respirable dust (small dust particles) from deep litter systems (half litter, half slatted floor) and cage systems were estimated at 2.3 and 0.14 mg/h per hen respectively, based on measurements in commercial houses. Litter systems clearly give higher concentrations of respirable dust within the housing (1.25 and 0.07 mg/m<sup>3</sup> respectively). The differences can be explained in combination with the higher level of activity shown by hens in non-cage systems.

### **1.4.2 Emissions to soil, groundwater and surface water**

Emissions from slurry storage facilities that contaminate soil and ground- or surface water occur because of inadequate facilities or operational failures and should be considered accidental rather than structural. Adequate equipment, frequent monitoring and proper operation can prevent leakage and spillage from slurry storage facilities.

Emissions to surface water can occur from a direct discharge of the waste water arising on a farm. Little quantified information is available on these emissions to surface water. Waste water arising from household and agricultural activities might also be mixed with slurry to be applied onto land, although mixing is not allowed in many MSs.

Waste water discharged directly into surface water can come from various sources but, normally only direct emissions from slurry treatment systems such as the lagoon systems are permitted. Emissions to surface water from these sources contain N and P, but increased levels of BOD may also occur; in particular in dirty water collected from the farmyard and from manure collection areas.

However, from all the sources, landspreading is the key activity responsible for the emissions of a number of components to soil, groundwater and surface water (and air, see Section 1.4.1). Although manure treatment techniques are available, the application of manure onto land is still the most favoured technique. Manure can be a good fertiliser, but where it is applied in excess to soil capacity and crop requirements it is a major agricultural source of emissions.

<b>Soil and groundwater</b>	<b>Production system</b>
Nitrogenous compounds	Landspreading and manure storage
Phosphorus	
K and Na	
(Heavy) metals	
Antibiotics	

**Table 1.8: Main emissions to soil and groundwater from intensive livestock production systems**

Most attention has been given to the emission of **nitrogen** and **phosphorus**, but other elements, such as potassium, nitrite, NH<sub>4</sub><sup>+</sup>, micro-organisms, (heavy) metals, antibiotics, metabolics and other pharmaceuticals may end up in manure and their emissions may cause effects in the long run.



Contamination of waters due to nitrates, phosphates pathogens (particularly faecal coliforms and *Salmonella*) or heavy metals is the main concern. Excess application to land has also been associated with an accumulation of copper in soils, but EU legislation in 1984 significantly reduced the level of copper allowed in pig feeds, thereby reducing the potential for soil contamination when manure is correctly applied. While improved design and management can lead to elimination of potential pollution sources on site, the existing spatial density of pig production in the EU raises particular concern with regard to the availability and suitability of land for spreading pig slurry. Increased environmental regulation of spreading of manure has sought to address this problem. Indeed, in the Netherlands and the Flemish region of Belgium exports of surplus manure are now occurring.

### Nitrogen

For nitrogen, the various emission routes are well illustrated in Figure 1.18. Through these reactions, losses of 25 – 30 % of nitrogen as excreted in pig slurry have been reported. Depending on the weather and soil conditions, this can be 20 – 100 % of the ammoniacal nitrogen if slurry is surface spread. The ammonia emission rate tends to be relatively high in the first few hours after application and decreases rapidly during the day of application. It is important to note that the ammonia release is not only an unwanted air emission, but also a reduction of the fertilising quality of the applied manure.

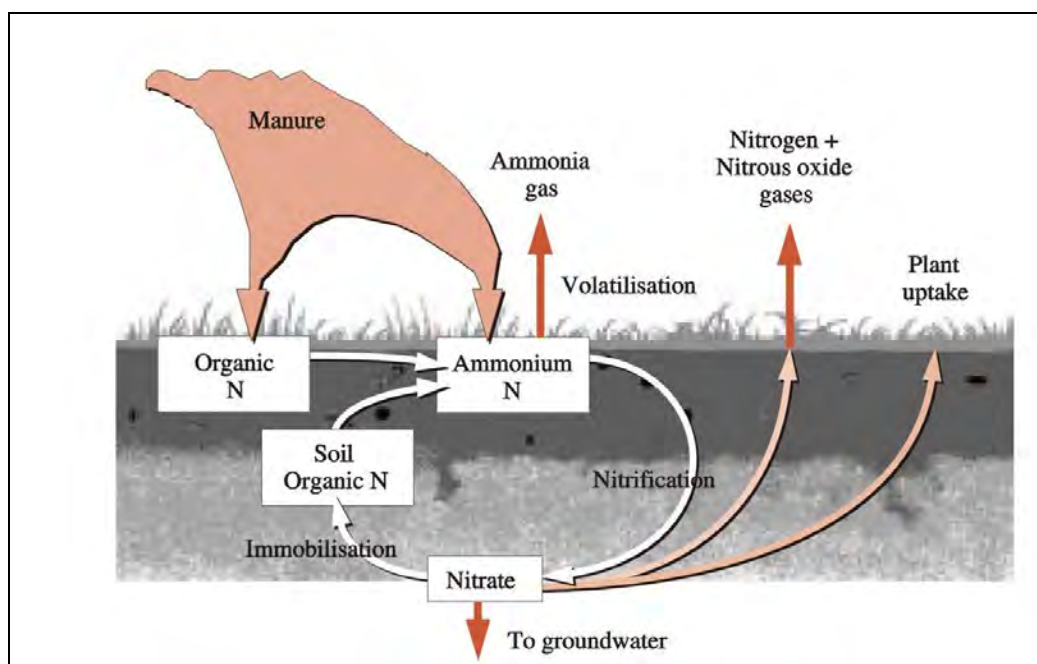

**Figure 1.18: Nitrogen cycle showing the main transformations and losses to the environment [50, MAFF, 1999]**

Pollution from agriculture, and in particular nitrogen pollution, has been identified through research evidence as posing a risk to the quality of European soil and surface and marine waters. The risks relate to the high level of nitrates found in drinking water, eutrophication of surface water (in synergy with phosphorus) and coastal waters and acidification of soils and waters. (Eutrophication involves excessive algal growth, and can lead to potential adverse effects on aquatic biodiversity or human uses of water)

The objective of the EU Nitrates Directive 91/676/EEC is to reduce these risks via a reduction and limitation of nitrogen application per hectare of arable land. Member States are obliged to identify zones, that drain into waters vulnerable to pollution from nitrogen compounds and that require special protection; i.e. the Nitrate Vulnerable Zones. In these zones landspreading is

restricted to a maximum level of 170 kg N/ha per year. In 2000, the combined area of all Nitrate Vulnerable Zones covered 38 % of the total EU-15 land area [205, EC, 2001].

Fewer problems arise from landspreading in areas where sufficient land appropriate for application is available for the amount of manure that is produced. Intensive livestock production and related nitrogen pollution are concentrated in different countries and in various regions in the EU. Nitrogen surpluses are observed to be most critical on pig and poultry farms.

### **Phosphorus**

Phosphorus (P) is an essential element in agriculture and plays an important role in all forms of life. In natural (i.e. unfarmed) systems, P is recycled to soil in litter and natural and vegetative residues, where it remains. In such ecosystems P is fairly efficiently recycled. However, in agricultural systems P is removed in the crop or the animal product and further P has to be imported to sustain productivity. As only part of the P is taken up by the soil (5 – 10 %) large amounts are applied in excess of what is needed, in addition to which increasing amounts of P-containing manure are added.

The importance of manure as a source of phosphorus has increased to the point at which it is estimated that 50 % of the input to EU surface waters from leaching and penetration into soil can be attributed to the application of animal manure. [150, SCOPE, 1997].

Concentrations of 20 – 30 micrograms P/l in lakes or slow rivers can cause water eutrophication, with the danger of a growth of toxic blue algae (cyanophytes) in fresh water, which are P limited [209, Environment DG, 2002]

### **1.4.3 Other emissions**

#### **Noise**

Intensive livestock farming can generate other emissions such as noise and emissions of bioaerosols. Like odour, is of local problem, and disturbances can be kept to a minimum by properly planning activities. The relevance of this problem may increase with expanding farms and with the growth in rural residential developments in traditional farming areas.

#### **Bioaerosols**

Bioaerosols are important for the role they can play in the spread of diseases. The type of feed and feeding technique can influence the concentration and emission of bioaerosols. The feeding of pellets or mealy feed mixes via liquid feed systems and through the addition of feed fats, or oils in the case of dry feed systems, can reduce dust development. Mealy feed mixes are better when combined with oils as binding agents. Liquid feed installations are regarded as desirable. A dry feed system may only be implemented on the basis of automatic slop / raw slop feeders. The high quality of the raw materials can be ensured through dry harvesting and storage. This will then avoid, in particular, microbial and fungal contamination.

Regular cleaning of the housing equipment and all the housing surfaces will remove dust deposits. This regime is assisted by the all-in/all-out rotation method, as following the removal of all the livestock careful cleaning and disinfecting of the housing is necessary.

As a general rule, in non-litter housings less dust occurs than in the case of litter-based housings. In litter-based housings, care must be taken to keep the litter, clean and dry, under all circumstances, and free of mould/fungus. Low air velocities in the floor area can reduce the dust content in the air.

## 2 APPLIED PRODUCTION SYSTEMS AND TECHNIQUES

This chapter describes the major activities and production systems found in intensive poultry and pig production, including the materials and equipment used and the techniques applied. It attempts to present the techniques that are generally applied throughout Europe and to create a background for the environmental data presented in Chapter 3. It also describes those techniques that can serve as a reference or benchmark for the environmental performances of the reduction techniques presented in Chapter 4.

This chapter does not seek to give an exhaustive description of all existing practices, nor can it give a description of all combinations of techniques that may be found on IPPC-farms. Because of historical developments and climatic and geophysical differences, farms will vary in the kind of activities that are applied, as well as in the way in which these activities are carried out. Nevertheless, it should give the reader a general understanding of the common production systems and techniques applied in Europe in the production of poultry products and pig meat.

### 2.1 Introduction

Livestock production is concerned with the processing of feed into a form that is suitable for human consumption. The objective is to reach a high feed utilisation as well as to use production methods that do not cause emissions that are harmful to the environment or to people. In general, the production systems do not require highly complex equipment and installations, but they increasingly require a high level of expertise to properly manage all the activities and to balance the production aims with the animals' welfare.

Intensive livestock farms which have animal numbers within the IPPC size range are generally characterised by a high a degree of specialisation and organisation. Central to all activities is the rearing, growing and finishing of animals for meat and/or egg production. The essential part of all activities is the animal housing system. This system (see Sections 2.2 and 2.3) includes the following elements:

- the way the animals are stocked (cages, crates, free)
- the system to remove and store (internally) the produced manure
- the equipment used to control and maintain the indoor climate
- the equipment used to feed and water the animals.

Other essential elements of the farming system are:

- the storage of feed and feed additives
- the storage of manure in a separate facility
- the storage of carcasses
- the storage of other residues
- the loading and unloading of animals.

Additionally, on egg-producing farms, the selection and packaging of eggs is quite common.

A number of activities can be part of the farming system, but these vary between farms for reasons such as the availability of land, farming tradition, or commercial interest. The following activities or techniques may be encountered on an intensive livestock farm:

- the application of manure on land
- the on-farm treatment of manure
- an installation for milling and grinding of feed
- an installation for the treatment of waste water
- an installation for the incineration of residues such as carcasses.

Schematically, this can be illustrated as in Figure 2.1.

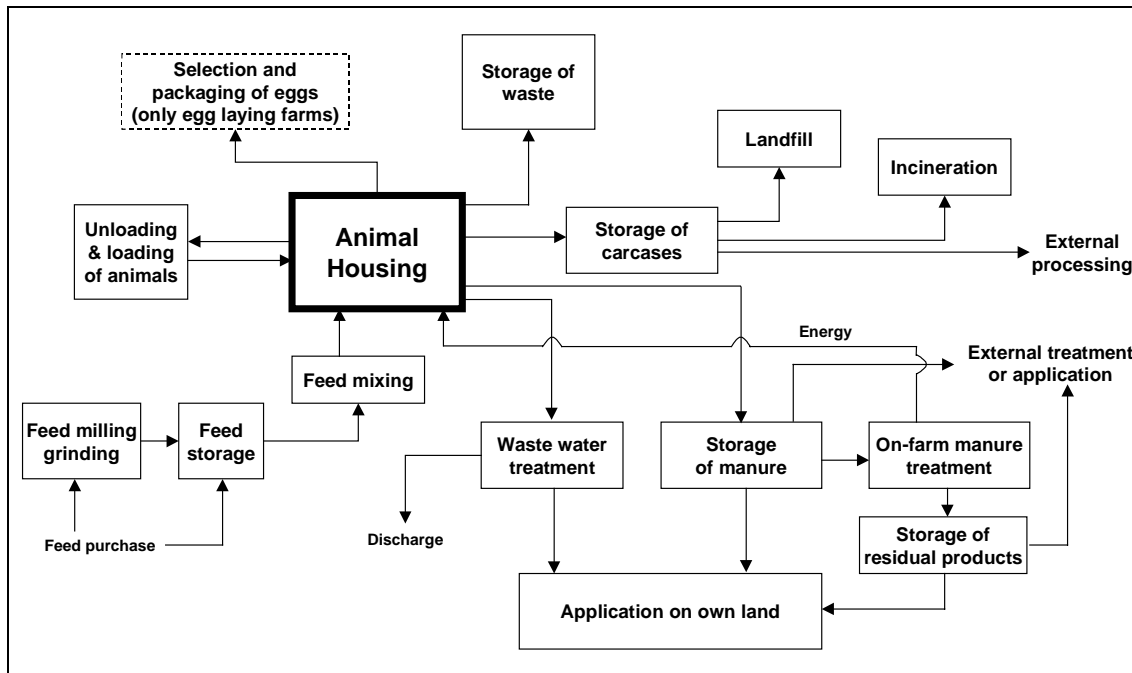

Figure 2.1: General scheme of activities on intensive livestock farms

## 2.2 Poultry production

### 2.2.1 Production of eggs

For commercial egg production, laying breeds are used that result from selection and breeding programmes that optimise their genetic potential for high egg production. Usually, they have small bodies that make them undesirable as meat producers. The smaller bodies benefit these breeds because very few nutrients are wasted in producing great body mass. Instead, they direct more of their dietary nutrients into egg-production. The egg producing breeds are further divided into birds that produce white shelled eggs or brown shelled eggs.

Laying birds kept in the commonly used laying cages have one laying period of about 12 – 15 months measured from the end of the growing period (around 16 – 20 weeks). The laying period can be extended if forced moulting is initiated between the 8<sup>th</sup> and 12<sup>th</sup> month of lay. This takes advantage of a second laying period that can add at least another seven months on the end of the forced moulting-period, taking the laying up to 80 weeks. [124, Germany, 2001]. In non-cage systems, the laying period lasts from about 20 weeks to 15 months, but no forced moulting is initiated.

The number of birds per surface area varies between housing systems. Where the commonly used cage systems allow a stocking density, depending on tier arrangement, of up to 30 – 40 birds/m<sup>2</sup> (corresponding to the available ground area) and severely restrict the birds in their freedom of movement, applied alternative systems have much lower densities of 7 birds/m<sup>2</sup> (littered floor) to 12 – 13 birds/m<sup>2</sup> (enriched cage). The limited space and the lack of structural design elements in the commonly used cages limit species-typical behavioural patterns and lead to damaged plumage, toe deformation and abnormal behaviour (cannibalism). However, cannibalism due to a lack of space can also be expected to occur in the enriched cage as well [194, Austria, 2001].

Most laying hens are still kept in batteries using cage systems, however, from January 2003, European legislation (Directive 1999/74/EC) will not allow the commonly used battery systems in new installations and by January 2012 these housing systems will have to be phased out completely. This means that from January 2012 only enriched cages will be allowed.

However, there are several studies and negotiations currently being undertaken to analyse the disadvantages of the installations defined by the above-mentioned Directive, and which take into account, amongst others, the health and environmental impact of the various systems. Depending on the results of these studies and negotiations it will be decided (in 2005) whether Directive 1999/74/EC will be reviewed. Until this decision is taken, uncertainty remains on the future requirements for cage-systems.

Currently an increasing number of non-cage systems in which the hens can walk around freely, such as free-range, semi-intensive, deep litter, barn and aviary are applied. From January 2002 the definitions of these systems will be changed by Directive 1999/74/EC into free-range and barn systems, where the term 'free-range' is used for housing systems in which the hens also have continuous daytime access to open-air runs. However, in the following sections the traditional terms are still used to describe the different non-cage systems, in order to avoid the terms barn and free-range being used out of the context of the above-mentioned Directive.

Design and management of non-cage systems is comparable with that of broiler systems (see Section 2.2.2).

### 2.2.1.1 Cage battery systems for laying hens

The battery systems can be described as a combination of the following elements:

- building construction
- cage design and placement and
- manure collection, removal and storage.

Intensive egg production usually takes place in closed buildings made of various materials (stone, wood, steel with sheet cladding). The building can be designed with or without a light system, but always with ventilation. The equipment in the housing can vary from hand operated systems to fully automated systems for indoor air quality control, manure removal and egg collection. Close to the housing or immediately attached are the feed storage facilities.

In cage systems, four major battery designs can be distinguished: flatdeck, stair-step, compact and belt-battery (Figure 2.2). In addition to these, fully stepped designs are also available [183, NFU/NPA, 2001]. Constructions can have up to 8 levels or tiers and under current regulation this allows a stocking density of up to 30 – 40 birds per m<sup>2</sup>, depending on the arrangement of the tiers. Rows of cages can be more than 50 m long, and with several corridors some of the modern large enterprises have buildings with 20000 to 30000 birds or more. Typical cages are 450 mm x 450 mm x 460 mm deep and house 3 to 6 birds. The cages are mostly made of steel wire and are equipped with installations for automatic watering (nipple drinkers) and automatic feeding (feed chain or carts) of the birds. Average occupancy of the housing is high (in the range of 311 – 364 days) with little time needed between laying cycles to clean the installation.

Cage floor inclination makes the eggs roll to the front side of the cages, where they are collected by hand or on a transport belt and removed for further selection and packaging. The bird droppings fall through the bottom of the cages at the back and are stored underneath or are removed by scrapers or belts. In general, flatdeck and stair-step cages need more space and require a larger investment per bird. Due to the way they are applied, these systems produce wetter manure and also account for a higher NH<sub>3</sub>-emission than the other systems (concentrations 40 ppm in the cage area at low ventilation rates). No current application rates

for the different cage systems are known, but it is believed that most of the laying hens in Europe are kept in compact or belt battery cage systems.

The droppings of laying hens in battery systems are not mixed with other material and can be managed in different ways, for example in some housing systems, water is added to allow easier transport of the slurry. Essentially, two different ways of collection and storage can be distinguished:

- housing with (temporary) manure storage in the cage area:
  - non-aerated manure
  - aerated manure
- separated cage area and storage facility.

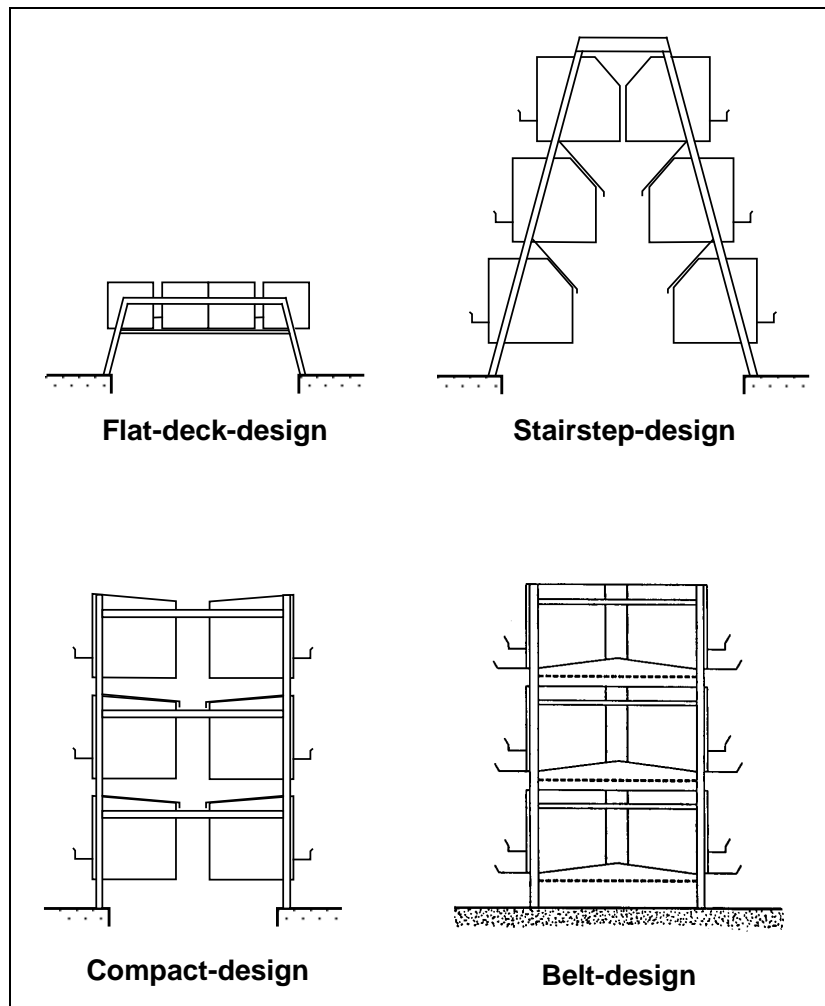

**Figure 2.2: Four common battery designs for housing of laying hens** [10, Netherlands, 1999] and [122, Netherlands, 2001]

The dry matter of fresh laying hen droppings is about 15 – 25 % and drying means that dm-content can increase to 45 – 50 %. Drying to a higher dm-content may be possible to reduce emissions even further, but this requires more energy. Normally, dried manure (45 – 50 %) is removed from the housing for immediate application or transportation, or is stored on-farm in a separate storage facility. In the storage, the dm-content can further increase to about 80 % by natural drying (composting or heating). During this process, emissions of ammonia and odour will occur.

Where fresh manure is removed from the layer housing to a separate closed or open storage, drying occurs entirely naturally or, in the case of deep-pit houses, it can be done by forced

ventilation of the storage area. It should be noted that with quick or immediate removal of the wet droppings, the emitting substance (at 15 – 25 % dm-content) has in fact been removed from the housing to the storage facility where further drying (and emission) takes place.

Amongst the many different combinations that exist, four commonly applied battery systems for laying hens in Europe can be distinguished:

- battery system with open manure storage under the cages
- deep-pit and canal houses
- stilt houses
- manure belt system with external storage.

#### 2.2.1.1.1 Battery system with open manure storage under the cages

The layers are housed in cages in one or more tiers. The cages (flatdeck, stair-step or compact-battery) are equipped with plastic flaps or metal plates on which the droppings remain for a while. Depending on the design, droppings may fall into the manure pit by themselves or be removed by a scraper. The droppings (and the spilled water from the drinkers) are collected in a manure pit underneath the cages and, once a year or less frequently, are removed by a scraper or a front loader [26, LNV, 1994], [122, Netherlands, 2001].

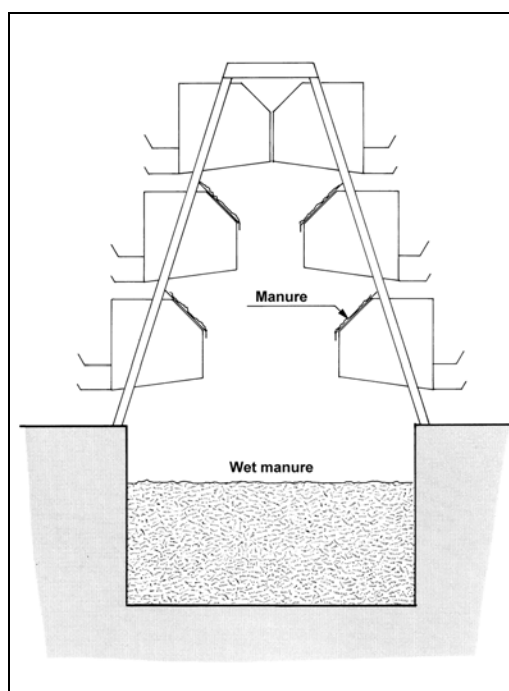

**Figure 2.3: Example of open manure pit under a stair-step battery**  
[10, Netherlands, 1999]

#### 2.2.1.1.2 Battery systems with aerated open manure storage (deep-pit or high-rise systems and canal house)

The cages are positioned above the manure storage pit. The height of a deep-pit system measures between 180 and 250 cm. The canal house has a pit, which measures approximately 100 cm. The wet droppings fall in the pit and remain there for periods of up to a year or more.

In a deep-pit house as well as in a canal house, fans that are placed below the cages in the lower part of the building draw in ventilation air. The air is drawn into the building through the roof (open ridge system) and passes the cage area, where it is warmed up. The warm airstreams then

pass over the manure stored in the pit and leave the house. The manure that is stored in the pit is dried by this flow of warm air.

During storage, heating by fermentation occurs. This fermentation results in a high ammonia emission level. To get a good drying result the manure on the plates underneath the cages should be pre-dried for about 3 days. After 3 days the manure has a dry material content of about 35 – 40 %. [10, Netherlands, 1999]

In the past in the UK, a slat manure drying technique was applied to deep-pit houses with fully stepped and flatdeck systems. It left manure drying in steep sided cones for 6 months, after which the manure was dropped into the deep pit and the slats reset for the rest of the year. This technique may still be applied, but has largely fallen out of use with the demise of most fully stepped and flatdeck cages in deep-pit systems [119, Elson, 1998].

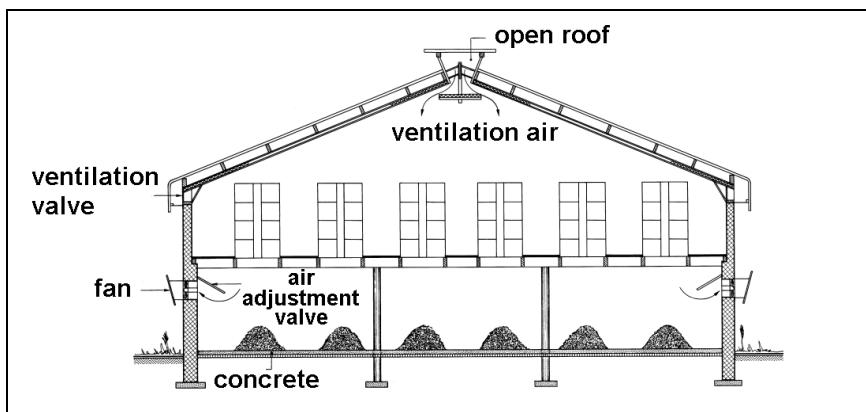

Figure 2.4: Deep-pit system for laying hens [10, Netherlands, 1999]

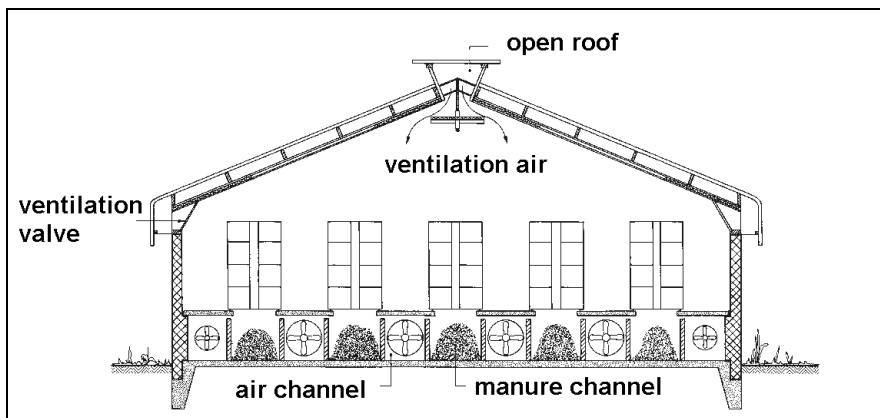

Figure 2.5: Example of a canal system for laying hens [10, Netherlands, 1999]

### 2.2.1.1.3 Stilt house system

A variation on the design of the deep-pit or high-rise system is the stilt house. It combines vertically tiered centre slot cages with scrapers under *all* tiers and an open deep-pit storage. The stilt technique employs a variable valve between the cage and the manure storage areas and has large openings in the manure store walls to enable the wind to pass through and assist drying. Thus, unlike the deep-pit system where manure storage and livestock areas are in the same place, in the stilt system they are separate. Therefore, manure can be removed from the store at any convenient time since it is out of sight and sound of the hens [119, Elson, 1998].



A stilt house can be considered similar to the deep-pit house in Figure 2.4, but without sidewalls.

#### 2.2.1.1.4 Battery system with manure removal by way of scrapers to a closed storage

This system is a variation of the open storage system applying cages over a shallow open manure channel that is as wide as the cages. Manure produced by the birds drops on to a plastic flap or a plate under the cages. From here, the manure goes into the manure channel. The manure is removed on a regular basis (daily or weekly) and stored in a separate storage facility (pit or shed). The pit is usually made of concrete. Using a scraper, after several years the pit floor becomes rough and a film of manure remains on the floor, increasing the emissions of ammonia. Both the manure on the plastic flaps or plates and the manure film on the floor cause a lot of ammonia emissions [10, Netherlands, 1999], [26, LNV, 1994], [122, Netherlands, 2001].

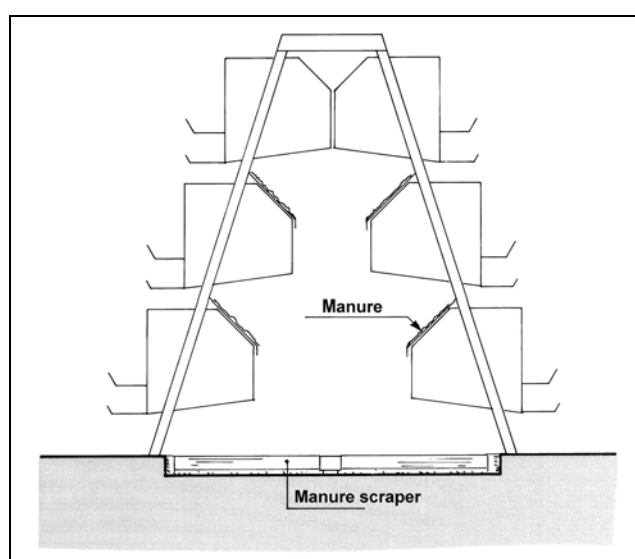
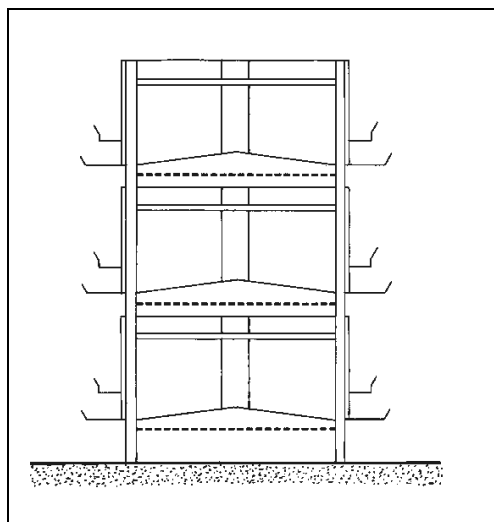

Figure 2.6: Example of open manure channel with scraper under a stair-step battery [10, Netherlands, 1999]

#### 2.2.1.1.5 Manure-belt battery with frequent removal of manure to a closed storage with or without drying.

The manure-belt battery is commonly applied throughout Europe. In this system the laying hens' manure is collected on manure-belts below the cages and transported to a closed storage at least twice a week. The manure is collected on manure-belts that are situated under each tier (or cage level). At the end of the belt a cross conveyor transports the manure further to the external storage. The manure-belts are made of smooth, easy-to-clean polypropylene or trevira and no residue sticks to these belts. With modern reinforced belts, manure can be removed from very long runs of cages. Some drying takes place on the belts, especially in summer conditions, and manure may be held on the belts for up to a week.



**Figure 2.7: Example of a manure-belt battery (3 tiers) with a belt under each tier to remove manure to a closed storage [10, Netherlands, 1999]**

In improved belt systems, air is blown over the manure to achieve faster drying of the manure. The air is introduced just under each tier of cages, usually via rigid polypropylene ducts. Another benefit is the introduction of fresh cooling air immediately adjacent to the birds. Further improvements consist of the introduction of pre-warmed house air and/or the use of heat exchangers to pre-warm incoming outside air.

#### **2.2.1.1.6 Enriched cage**

A very recently developed housing regime for layer birds is the enriched cage. It should be used as a replacement for the hitherto commonly used cage systems: see Section 2.2.1 where the phasing out of the commonly used cage systems is described. Some minimum requirements have been established in the EU Directive including provisions, such as that: each cage must be equipped with perches, laying nest and a sand bath with litter material. [121, EC, 2001].

Depending upon the individual systems manufacturer, designs may differ in the number of birds per cage, the nest, the sand bath design and the arrangement within a cage. Generally, birds are kept in a groups of 40 and more [179, Netherlands, 2001]. Compared with the commonly used cage, it offers more space and is equipped with structural features to stimulate species-specific behaviour. In addition litter, sand, shavings, or other materials are used.

The presence of litter in the cage is one of the main factors that affects management, i.e. issues related to the type of litter material, the filling and removal of the litter surface (automated or not) and the risk of increased levels of dust in the building. There is also an increased risk that eggs that are laid in the litter material are removed with the manure. The selection of the litter material is very important, and depends on its cost, availability, use by birds, and easy removal and disposal. The amount and cost of litter for each laying hen per day is very variable and depends on the material used. It is expected that the litter material will increase the manure volume, so its value as a fertiliser may be affected, as will the processing of the manure after its removal from the building. These aspects can be very different depending on the type of litter material. [204, ASPHERU, 2002]

The cages are made of steel wire with horizontal front meshing or rods and solid partitions arranged in tiers of 3 and more. Manure is removed automatically via manure-belts (with or without belt aeration).

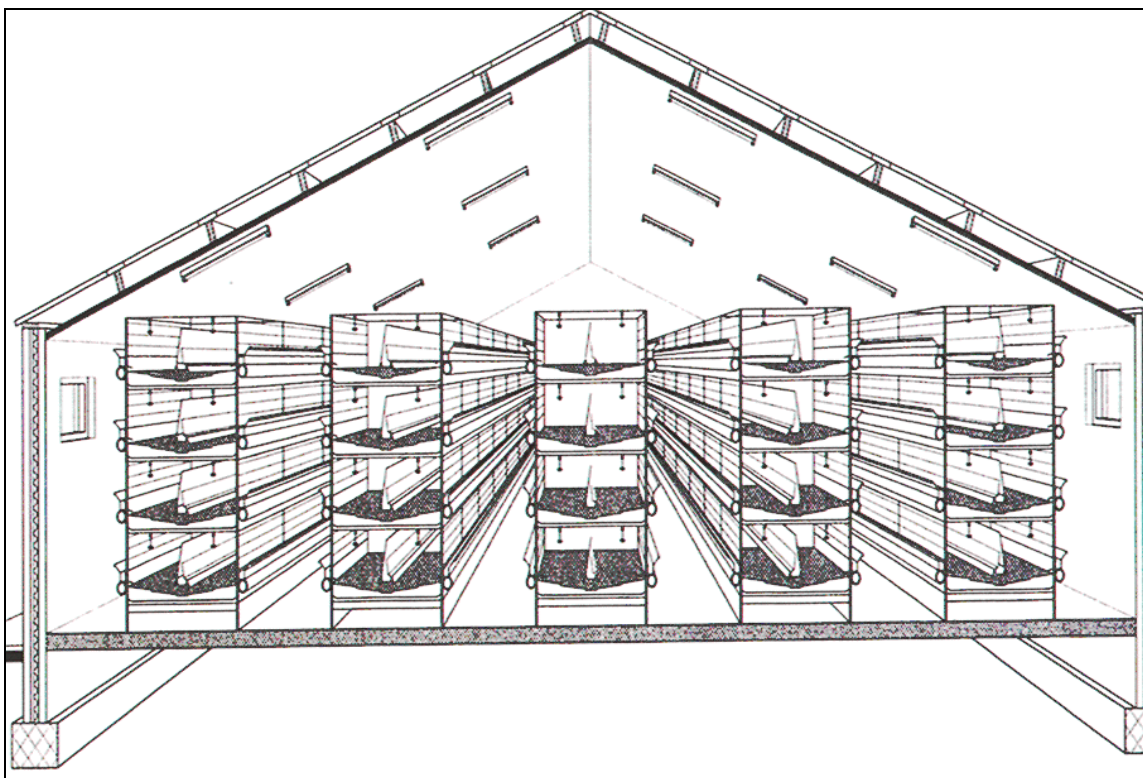

**Figure 2.8: Schematic picture of a possible design of an enriched cage**  
[128, Netherlands, 2000]

A typical emission is reported as being 0.035 kg NH<sub>3</sub> per bird place per year (NL). Ranges have been reported of 0.014 – 0.505 kg NH<sub>3</sub> per bird place per year (D) associated with a rate of approximately 160 grams fresh droppings (of 1.3 % N content) produced per bird per day. The reported dry matter content of the manure is 20 – 60 % depending on the system applied: manure-belt without drying 25 – 35 %, and the aerated belt 35 – 50 %.

The energy required for belt operation and ventilation is comparable to that of other (aerated) belt systems. The use of litter can cause more dust inside the housing. Materials such as sand, shavings or others needs to be disposed of.

Feeding and watering, lighting and ventilation of this system are very similar to the commonly used cage, but in addition 1 – 2 kg litter per birdplace per year is required.

This system is intentionally designed as an alternative to the commonly used cage systems. As such the application would not require substantial changes to the building, but it will require a full replacement of the cages in existing systems.

Total operational costs have been estimated at EUR 1.5 per bird per year (NL).

Nowadays enriched cages are implemented in only a few farms under commercial conditions, for example, in the Netherlands (reference year 2001) only 1 farm applies this system.

**Reference literature:** [122, Netherlands, 2001], [124, Germany, 2001] [180, ASEPRHU, 2001] [179, Netherlands, 2001] [204, ASPHERU, 2002]

### 2.2.1.2 Non-cage housing systems for laying hens

Laying hens are also kept in non-cage housing systems. What these housing systems all have in common is that the birds have more space or can move around more freely within the building. The housing construction in which the birds are kept is similar to that of the cage systems. Various designs are applied in different Member States, such as:

- the deep litter system
- the aviary system.

In Directive 1999/74/EC two non-cage systems are defined: the barn and the free-range system.

#### 2.2.1.2.1 Deep litter system for laying hens

The layer house is a traditional building with respect to walls, roof and foundation. Thermally insulated poultry houses have forced ventilation; either windowless or with windows for natural daylight. Birds are kept in large groups with 2000 to 10000 bird places per housing facility.

The air is replaced and emitted passively by natural ventilation or by forced ventilation with negative pressure. In accordance with EU Egg Marketing Standards currently in effect, at least one third of the floor area (concrete floor) must be covered with bedding (chopped straw or wood shavings used as litter material) and two thirds arranged as droppings (manure) pit.

The pit is covered with slats that are mostly made of wood or artificial material (wire meshing or plastic lattice) and slightly raised. Laying nest, feed installation and the water supply are placed on the slats to keep the litter area dry. The manure is collected in a pit below the slats during the laying period (13 – 15 months). The pit is formed by the raised floor or can be sunk into the ground (Figure 2.9).

Automatic supply of feed and drinking water, with long troughs or automatic round feeders (feeder pans) and nipple drinkers or round drinkers are installed above the pit area. Droppings are removed from the pit at the end of a given laying period; or intermittently, with the aid of (aerated) manure-belts. At least one third of the used-air volume stream is drawn off via droppings pit. Individual or community nests are provided for laying; automatic egg collection is also possible. Lighting programmes to influence performance/rate of lay and crude protein-adapted feeding may be applied. [128, Netherlands, 2000], [124, Germany, 2001]

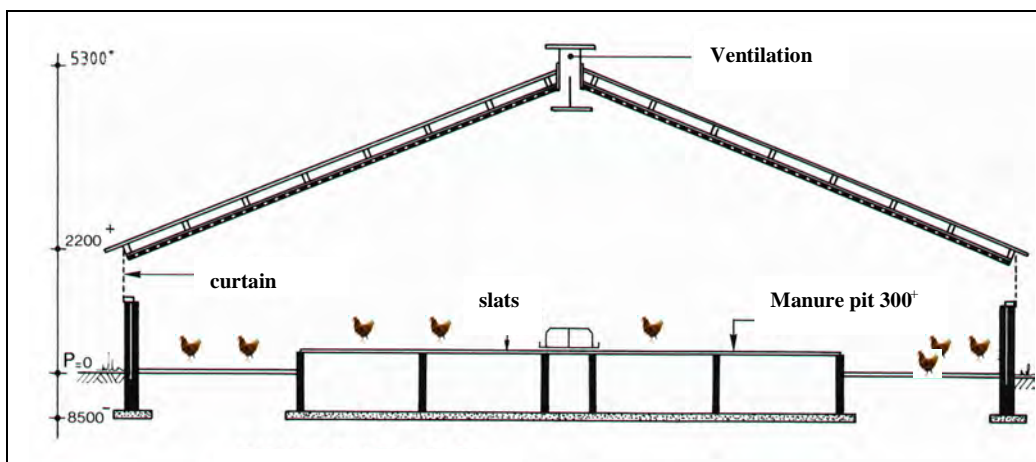
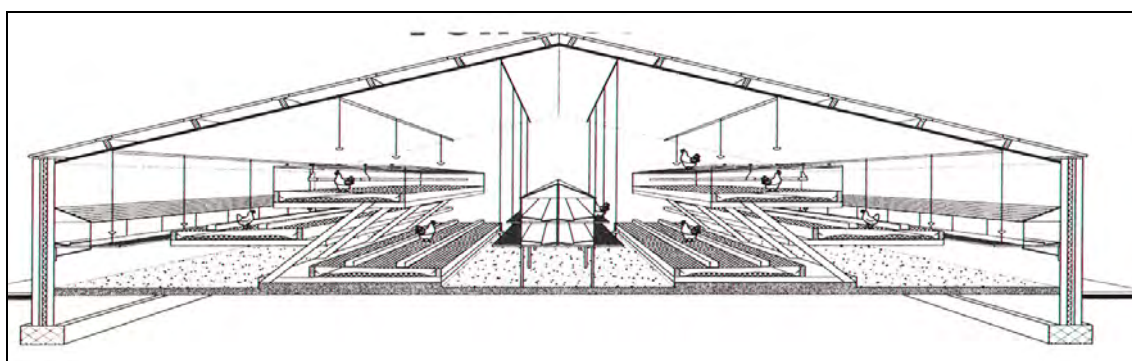

Figure 2.9: Schematic cross-section of traditional deep litter system for layers [128, Netherlands, 2000]

### 2.2.1.2.2 Aviary system (perchery)

This poultry house is a construction with thermal insulation and forced ventilation, either windowless, or with windows for natural daylight and artificial light for applying lighting programmes; houses can be combined with range and outside scratching area. Birds are kept in large groups and enjoy freedom of movement over the entire house area. Housing space is subdivided into different functional areas (feeding and drinking, sleeping and resting, scratch area, egg laying area). The birds can use several house levels that allow for higher stocking densities compared to the commonly used floor regime (deep litter). Droppings are removed via manure belts into containers, or into a manure pit, or otherwise collected in a manure pit. Litter is spread onto a fixed concrete area. Feed (mostly feed chains) and drinking water (nipple or cup drinkers) are automatically supplied. Laying nests (individual or community nest design) have manual or automatic egg collection.

Stocking density is maximised to 9 birds per usable  $m^2$  or to 15.7 birds per ground surface (in  $m^2$ ), with houses accommodating between 2000 and 20000 birds (bird places).

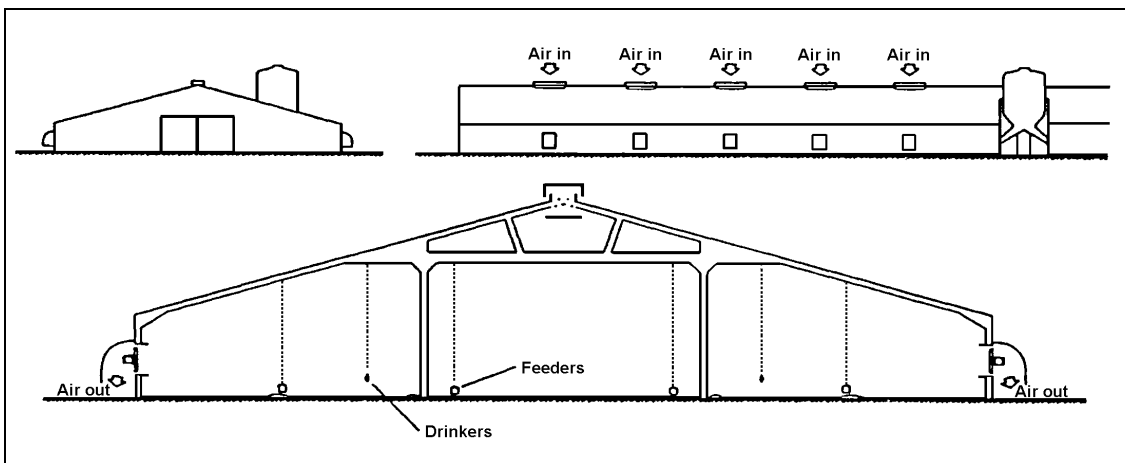

**Figure 2.10: Schematic picture of an aviary system**  
[128, Netherlands, 2000]

## 2.2.2 Production of broiler meat

Broiler meat is produced by growing meat-type breeds of chicken, which in reality are hybrid varieties of combinations of many different breeds. The combinations of breeds are selected to produce a variety (strain) with meat characteristics that the producer desires most. Some breeds grow faster and larger while others emphasise traits like larger breast meat yield, more efficient feed conversion or more disease resistance. Strains are often named after the breeding companies that genetically develop them. Obviously, these strains are not as well suited to laying eggs as the laying breeds.

The traditional housing of intensive broiler production is a simple closed building construction of concrete or wood with natural light or windowless with a light system, thermally insulated and force-ventilated. Buildings are also used that are constructed with open sidewalls (windows with jalousie-type curtains); forced ventilation (negative pressure principle) is applied by way of fans and air inlet valves. Open houses must be located so that they are freely exposed to a natural stream of air and are positioned at a right angle to the prevailing wind direction. Additional ventilating fans operate via ridge slots, and gable openings may apply. This is intended to provide the in-house broiler area with extra air circulation during hot spells in summer. Mesh wire screens along upper sidewalls keep wild birds out.



**Figure 2.11: Example of schematic cross-section of a commonly applied broiler house [129, Silsoe Research Institute, 1997]**

Closed buildings have oil- or gas-fired warm-air blowers for total room heating; radiant heaters are used for zonal heating in houses built for open-air ventilation. Artificial lighting and/or artificial/natural daylight combination lighting system are provided as required.

Broilers are kept on litter (chopped straw, wood shavings or shredded paper) spread over the entire house floor area which, in turn, is built as a solid concrete slab. Manure is removed at the end of each growing period. Automatic, height-adjustable feeding and drinking systems (mostly tube feeders with round feeder pans and nipple drinkers with drip water catch bowls) are applied. Crude protein-adapted feed is given. Broilers are kept at a stocking density of 18 to 24 birds per m<sup>2</sup>. Stocking density is also measured in kg live weight/m<sup>2</sup> (e.g. in Finland), but this number is variable. New legislation is expected to limit the stocking density of broilers. Houses can stock between 20000 and 40000 birds.

## 2.2.3 Other poultry production sectors

### 2.2.3.1 Production of turkeys

Turkeys are kept for meat production and different production systems apply. It can be a two-age system (UK, Netherlands). The first period covers a breeding period for all birds up to 4 – 6 weeks. Then the stags (males) are shifted to a different housing. The breeding period is 19 – 20 weeks with an average slaughter weight for the stags of 14.5 kg (21 – 22 weeks) and for the hens of 7.5 kg (16 – 17 weeks) (see also Table 1.1). In Finland, four ages are distinguished relating to four different feeding rations, with stags being reared for 16 weeks and the hens for 12 weeks. The animals are kept in much higher densities at the start, when they are still small. During the growing period, the birds are thinned and after 22 weeks only a third of the birds may be left. For example in the UK, the hens are removed first and sold as oven ready birds. Stags are used for further processing.

#### 2.2.3.1.1 Commonly applied housing systems

The commonly applied turkey housing is a traditional housing construction, which is very similar to the housing of broilers (Figure 2.11). Turkeys are housed in closed, thermally insulated buildings with forced ventilation, or (more frequently) in open (outdoor-climate) houses with open sidewalls and jalousie-type curtains (unrestricted natural ventilation). Forced ventilation (negative pressure) is applied by fans and inlet valves. Free open-air ventilation is created via automatically controlled jalousies or wall-mounted inlet valves. Open houses are aligned at right angles to the prevailing wind direction and located in such a way as to be exposed to natural airflow. Additional ventilation is applied via ridge slots and gable openings. Radiant gas heaters are applied for heating.

Precautions are put in place to protect against emergencies like power cuts, extreme weather conditions or fire, as per unit a large number of birds will always be at risk. During peak summertime temperatures, additional measures are taken to minimise heat stress on the birds (by providing for larger-volume air change, operating extra fans for bird comfort in open houses, water fogging or roof sprinkling)

Wire meshing in the upper sidewall section is applied to keep wild birds out. A floor regime is operated with litter material (chopped straw, wood shavings) spread over the entire house floor area (built of concrete) with layers up to 9 – 12 inches deep. Manure removal and cleaning of the house takes place at the end of each respective growing period. All litter is removed by an excavator or frontloader. Litter replenishment is applied as needed. Automatic height-adjustable round drinkers and feeders are applied during the growing/feeding period. Daylight length and light intensity can be controlled during brooding and, in closed houses, over the entire brooding/finishing period.

In the following Sections 2.2.3.1.2 and 2.2.3.1.3, possible variations to the commonly applied system are described.

### **2.2.3.1.2 Closed house system**

In this system, wood shavings/sawdust are taken out of the turkey house nine times during the fattening period. This reduces ammonia emissions because the temperature of the litter, together with the droppings, will not increase. The turkey house is similar to the standard as described in Section 2.2.3.1.1. The manure is taken out by means of a tractor with a loading shovel, while the drinking and feeding systems are lifted out of the way.

At the start of the production period a thin layer of wood shavings/sawdust (4 cm) is spread evenly on the floor. After 35 days all the manure is taken out of the house. A fresh layer of 3 cm (instead of 4 cm) of wood shavings/sawdust is provided. This pattern is repeated, at different intervals, until the end of the fattening period, as follows: after 35, 21, 21, 14, 14, 14, 14, 14 and 14 days respectively a 4, 3, 3, 3, 3, 5, 5, (end) cm layer of wood shavings/sawdust are applied. During manure removal the birds are quietly moving away from the shovel. Behind the shovel a system is constructed for spreading the wood shavings/sawdust.

The ammonia emission from this system is estimated at 0.340 kg NH<sub>3</sub> per turkey place per year, but more research is needed to validate this. For this, a new measuring system will be installed in a turkey house to provide NH<sub>3</sub> emission measurements twice a day.

Compared to the commonly used systems (Section 2.2.3.1.1), in which farmers mix the manure several times during the fattening period, no high-energy input is needed. Due to the high dry matter content, compared to the traditional systems, the handling of the manure (e.g. palletising) is easier and also requires less energy.

There is a lot more dust in the house, because of the dry manure and the spreading of a mixture of wood shavings and sawdust (up to 65 %). Farm workers should use face masks. It is clear that labour costs would rise. There is also a question over whether the frequent mucking-out of the housing could affect turkey growth performance.

This system is a management system and does not require any alterations to the housing system. It can be applied in new and existing houses. In existing houses, provisions only have to be made for (semi-) automatically lifting of the feeding and drinking systems.

The investment costs are slightly higher than that of the traditional system. With these systems a farmer also needs regular use of a tractor or a shovel. Labour costs will be increased with the frequent mucking-out. Investment costs are reported to be EUR 6.36 per bird place. Total operational costs are around EUR 0.91 per bird place per year.

In the Netherlands, 1 turkey house (10000 turkeys) is currently applying this system.

**Reference literature:** [128, Netherlands, 2000]. An application leaflet is available by Koudijs-Wouda (turkey feedmill organisation)/Agramatic/Bureau TES (These are respectively a turkey feed plant, Agriculture Design Office and Advisory service for NH<sub>3</sub> emissions)

### 2.2.3.1.3 Partially ventilated littered floor system

A partially ventilated floor is designed to reduce the emission of ammonia in a commonly used turkey housing. About 75 % of the total floor surface is littered and 25 % consists of a raised platform with slats. The raised platform is about 20 cm above the concrete floor and covered with a nylon cloth. On both the concrete floor and the nylon cloth there is a layer of wood shavings. A fan blows air through the raised floor and the wood shavings into the house.

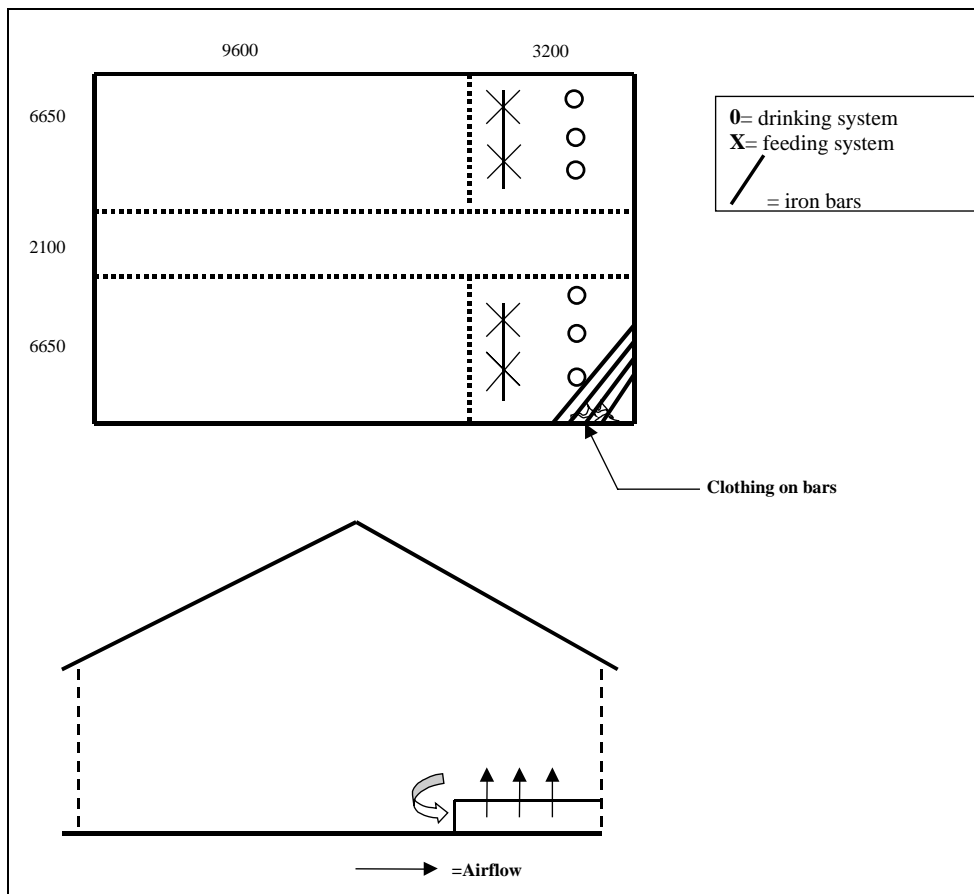

**Figure 2.12: Schematic cross-section of the partially ventilated litter floor system for turkeys [128, Netherlands, 2000]**

This system reduces ammonia emissions by 47 % compared with the reference system, i.e. reducing the emission to 0.360 kg NH<sub>3</sub> per turkey place per year. However, compared to traditional systems, a high energy input is required for ventilation. The measured dust concentrations are high, therefore it requires the use of a device for respiratory protection. Due to the high dry matter content, compared to the traditional systems, the handling of the manure (e.g. palletising) is easier and needs less energy.

The birds will feed and defecate on top of the platform, where the drinkers and feeders are placed. At the beginning of the trial 5 kg/m<sup>2</sup> woodshavings are spread on the concrete floor and 2 kg/m<sup>2</sup> on the platform. During the production cycle, the quality of the litter may require application of more woodshavings. The ammonia emission is reduced by drying some of the litter.



This system can be applied to new and existing houses, as they do not need much alteration. It is questionable whether it is applicable under animal welfare regulations. Considering the weight of the birds, application is considered to be difficult. Also, the cloths covering the slats tore during the trials, which caused sub-optimal air movement.

The extra investment costs will be higher than for the traditional systems and are estimated at EUR 6.36 per bird place (EUR 20 per kg NH<sub>3</sub>). Annual operational costs are about EUR 2 per bird place per year (EUR 2.9 per kg NH<sub>3</sub>).

In the Netherlands, there is only 1 farm applying this system [181, Netherlands, 2002].

**Reference literature:** [128, Netherlands, 2000] [181, Netherlands, 2002]

### 2.2.3.2 Production of ducks

Ducks are generally kept for meat production. There are numerous breeds on the market, but popular breeds for commercial meat production are Pekin and Barbary; Rouen and Muscovy are both Barbary breeds. Different breeds are used for egg-laying, although Pekins have a reasonable laying performance compared with the other meat types. The Muscovy ducks are the heavier types. Drakes are normally heavier than ducks. As with chickens, the meat types are more heavily built than the egg type birds (Table 2.1).

Ducks are kept in housing, although in some Member States outdoor rearing is also allowed. There are three main housing systems for fattening of ducks:

- fully littered, with a water system positioned above a gully
- partly slatted/partly litter
- fully slatted.

The commonly applied duck house is a traditional housing system and is similar to the broiler house (Figure 2.11). It has a concrete floor that is covered with litter. The house is equipped with a ventilation system (natural or mechanical) and, depending on the climatic conditions, heating is applied.

Meat type	Adult drake (kg)	Adult duck (kg)
Pekin	4.00 – 4.50	3.50 – 3.75
Muscovy	4.50 – 5.50	2.25 – 3.00
Rouen	4.50 – 5.00	3.50 – 4.10
Egg type		
Indian Runner	2.00 – 2.25	1.60 – 2.00
Khaki Campbell	2.25	2.00

**Table 2.1: Range of weights of meat and egg production duck breeds [171, FEFANA, 2001]**

Production cycles will vary between Member States. In Germany, the production cycle for duck meat production is divided into a growing period up to day 21 followed by a finishing period until day 47 – 49. Rearing and growing is done in separate stalls. Manure is removed and the stalls are cleaned and disinfected during a service period of about 5 to 7 days before they are stocked again. Stocking density is 20 kg live weight/m<sup>2</sup> accessible floor area in both phases, with accessible areas typically measuring 16 x 26 m for growing and 16 x 66 m for finishing. Thus, the growing stalls can house approximately 20000 young ducks and the finishing stalls about 6000 ducks (See fact sheets in [124, Germany, 2001]).

Commonly applied is the fully littered system using wheat or barley straw or wood chips. The layer is usually not too thick because the manure of ducks is much wetter than that of chicken broilers. Slats, if applied, are usually of plastic-coated wire, wood or synthetic material.

### 2.2.3.3 Production of guinea fowl

No specific information is available on the production of Guinea fowl in Europe. The general picture is that this sector is quite insignificant compared to the production of other poultry species described above. Commercial breeding and raising of guinea keets can be compared with that of turkeys. Guinea fowl is very different in its behaviour from chicken and needs a lot of space. Somewhat dated information from US breeders and from the US Department of Agriculture (USDA) shows that Guinea breeding stock is generally housed in free-range systems. During the laying period the breeders are kept confined in houses equipped with wire floored sun porches. It is an open question whether there are any farms in Europe rearing Guinea fowl intensively in such numbers as to be under the scope of IPPC.

## 2.2.4 Control of poultry housing climate

For all poultry species, housing systems are equipped to maintain the indoor climate, but for broilers in particular climate control has been studied extensively. Factors that are important for the climate in poultry housing in general are:

- indoor air temperature
- air composition and air velocity at animal level
- light intensity
- dust concentration
- stocking density
- insulation of the building.

Adjustment is usually done by controlling the temperature, ventilation and illumination. Minimum health standards and production levels impose requirements on the indoor climate of poultry houses.

### 2.2.4.1 Temperature control and ventilation

**Temperature control:** Temperatures in the poultry house are controlled by means of the following techniques:

- insulation of the walls
- local heating (deep litter systems) or space heating
- direct heating (infrared, gas/air heating, gas-convectors, hot air cannon)
- indirect heating (central heating-space, central heating-floor)
- cooling by spraying of the roof (practised in warmer climates and in summer).

Floors of housing are often made of concrete and are normally not further insulated. Partly insulated floors are sometimes applied (e.g. Finland). There is a potential loss of heat from the housing by radiation to the soil underneath, but this is small and has not been reported as having an effect on the animals' production.

Heating is sometimes applied through heat recovery from exhaust air, which is also used for manure drying. For layers, heating is hardly needed when the stocking density in the cages is high.

Generally, in winter, but also during the early stages of production (young birds) heating is applied to broilers. The capacity of the heating equipment is related to the number of birds in the shed and the volume of the shed. For example, in Portugal gas radiators with a capacity of 6000 kJ equal 650 new born birds per radiator and a capacity of 12500 kJ equals 800 new-born birds. Some typical temperatures for the housing of broilers are shown in Table 2.2. Movement is sometimes restricted when the birds are small to keep them near the brooders.

Ages (days)	Required heating (°C)	Indoor environment temperature (°C)	
		Source 1)	Source 2)
1 to 3	37 – 38	28	30 – 34
3 to 7	35	28	32
7 to 14	32	28	28 – 30
14 to 21	28	26	27
Adults	No heating	18 – 21	18 – 21

**Table 2.2: Example of required indoor temperatures for broiler housing**  
Source 1): [92, Portugal, 1999], Source 2): [183, NFU/NPA, 2001]

In turkey housing, the required temperature is higher (32 °C) at the beginning of the rearing period so heating may need to be applied. When the birds grow, the required ambient indoor-temperature is decreased to 12 – 14 °C. The heating in the turkey housing is locally applied as more ventilation is needed in these systems and this results in higher energy consumption. On a number of farms in the Netherlands recirculation of the air is practised, combining natural and mechanical ventilation. By operating valves, the airflow can be adjusted in such a way that the air is mixed properly and less energy is needed for heating.

**Ventilation:** Poultry housing can be naturally and/or force-ventilated depending on the climatic conditions and the birds' requirements. The building can be designed to force the ventilation air stream across or longitudinally through the building or from an open ridge in the roof downwards via fans below the cages. For both natural and forced ventilation systems, the prevailing wind direction may influence the positioning of the building so as to enhance the required control of the ventilation airflow as well as to reduce emissions to sensitive areas in the vicinity of the enterprise. Where low outdoor temperatures occur, heating equipment may be installed to maintain the required temperature inside the building.

Ventilation is important for the birds' health and will therefore affect production levels. It is applied when cooling is required and for maintaining the composition of the indoor air at the required levels. For example, for the composition of air in broiler housing, in Belgium the limit values concentrations as shown in Table 2.3 are advised, but these values vary between MSs.

Parameter	Limit value
CO <sub>2</sub>	0.20 – 0.30 vol-%
CO	0.01 vol-%
NH <sub>3</sub>	25 ppm
H <sub>2</sub> S	20 ppm
SO <sub>2</sub>	5 ppm

**Table 2.3: Advisable limit values for different gaseous substances in the indoor air in broiler housing applied in Belgium**  
[33, Provincie Antwerpen, 1999]

For layers housed in battery cages, ventilation ranges from 5 – 12 m<sup>3</sup> per bird per hour in summer (depending on the climate zone) and 0.5 – 0.6 m<sup>3</sup> per bird per hour in winter [124, Germany, 2001].

Ventilation systems can be divided into natural and mechanical systems. Natural systems comprise of openings in the ridges of the roof. Minimum outlet sizes are 2.5 cm<sup>2</sup>/m<sup>3</sup> of housing volume with a required inlet of 2.5 cm<sup>2</sup>/m<sup>3</sup> on each side of the building. With natural systems, the design of the building is important to enhance ventilation. If width and height are not properly matched, ventilation may be insufficient and may give raised levels of odour inside the housing.

Mechanical systems operate with negative pressure and a net inlet of 2 cm<sup>2</sup>/m<sup>3</sup> of housing volume. They are more expensive, but give better control of the indoor climate. Different designs are applied, such as:

- roof ventilation
- ridge-parallel ventilation
- side ventilation.

For example in the UK, approximately 40 % of broiler houses may have the ventilation on the roof. Another 50 % have reverse-flow ventilation and 10 % have cross-flow ventilation. Long flow ventilation is an emerging technique, but no further information is made available. In general, broiler-housing facilities are equipped with thermometers at various places to control indoor air temperatures.

For broilers, generally, a maximum ventilation capacity of about 3.6 m<sup>3</sup> per kg live weight is applied in the design of ventilation systems. The air speed at bird level varies with temperature and speed levels of 0.1 to 0.3 m/s have been reported [92, Portugal, 1999]. The ventilation capacity changes with the outside air temperature and relative humidity (RH) and with the age and live weight of the bird (CO<sub>2</sub>, water and heat requirements).

The relationship between ventilation needs and the different variables were found to be as follows: with an outside air temperature of 15 °C and a RH of 60 % the ventilation was determined by the CO<sub>2</sub> balance in the first three days, by the water balance in the period up to 28 days and after this by the heat balance. With lower outside air temperatures, CO<sub>2</sub>-balance and water balance become more important. From a temperature of 15 °C the heat balance becomes more important in combination with lower RH and heavier chickens. It was concluded that a minimum ventilation requirement for broilers should be set at 1 m<sup>3</sup> per kg live weight, to be on the safe side [33, Provincie Antwerpen, 1999].

**Frequency-converter:** [177, Netherlands, 2002] In practice, most of the ventilators are powered by a 230-Volt triac controller. One disadvantage of this controller is that a triac-powered ventilator working at low speed leads to energy losses, which leads to a higher energy consumption per cubic metre of air replacement. Another type of controller which can be used to power a ventilator is a frequency-converter, where the ventilators can work at low speed without any decrease in energy efficiency. Up until now the most used system to ventilate a pig house was a system with 1 (or more) fans in each compartment. These fans, provided with a 230 Volt AC motor, are speed adjusted by a simple fan-controller or a climate-computer based on a triac controller.

With the frequency-converter system, as with the conventional system, fans are used in each compartment. Only the fans are different (3\*400 Volt AC) and can be adjusted with a frequency controller.

The main benefit of this system over the conventional system is the lower energy consumption. The frequency-converter system can be used in all types of pigs' houses and also in poultry houses. One of the benefits of the system is that all the compartments can be adjusted between

5 % and 100 % ventilation, regardless of the influences of the weather (e.g. even in windy weather). A measuring fan is installed below the fans. The fans in all the compartments are linked with one frequency-converter. The highest demanding compartment controls the power output of the frequency controller of all the fans. The valve, constructed under the fan, of the highest demanding fan is opened to maximum. The other compartments do not need that amount of air, so the other valves close till the measuring fan has reached the RPM calculated by the climate control for that compartment.

This way of smothering is the same as that used with the conventional system with the 230 Volt motor. But, the energy loss through smothering by the frequency-converter system is minimal.

The specific qualifications for controlling the 3\*400 Volt motor by the frequency-converter are:

- power-consumption (watt) from a fan controlled by a frequency-converter is reduced to the 3 exponent of the percentage from the normal RPM.
- a great benefit is obtained by adjusting the normal 50 Hz back to a lower frequency. The normal triac-controller reduces the voltage but not the frequency
- very high torque (=power) is delivered to the axle of the fan.

**Energy consumption:** For example, for a fan with  $\varnothing$  500 mm and 1400 RPM, the power used at the maximum speed is 450 Watts. The power-consumption of a 230 Volt fan at 50 % RPM controlled by the triac-controller uses  $\pm$  70 % of 450 Watts, and thus only  $\pm$  315 Watts.

The power-consumption of a 3\*400 Volt fan at 50 % RPM, controlled by the frequency-converter, is:  $0.5 \times 0.5 \times 0.5 = 12.5$  % of 450 Watts =  $\pm$  56 Watts. At 80 % and 25 % RPM this is:

- 80 % RPM =  $0.8 \times 0.8 \times 0.8 = 0.512 \times 100$  % = 51.2 % x 450 Watts = 230 Watts
- 25 % RPM =  $0.25 \times 0.25 \times 0.25 = 0.015 \times 100$  % = 1.5 % x 450 Watts = 7 Watts

Usually the fans do not work at 100 % RPM. At most times of the year the fans work at a lower RPM. For example, during the winter period the fans seldom work above 25 % RPM. With this RPM the power used is only 7 Watts instead of 112 Watts, using a triac controlled system in combination with a measuring fan. A conventional system without measuring fans cannot even work at that low a level, i.e. of 25 % of the maximum RPM. That means more ventilation of heated air during cold periods and therefore additional energy losses.

The Institute for Applied Research in the Netherlands tested this frequency-converter system for one year. Conclusion: the power reduction achievable by using a frequency-converter system was up to 69 % compared to the 230 Volt motors with the conventional system.

Another benefit of using the frequency-converter is that the fans have a longer lifetime, mainly because there is no extra heat production. Moreover triac controlled systems cause the fans to be jerky, depending upon the revolutions per minute, in contrast to a frequency-converter system, which works more regularly.

**Investments costs:** The investments costs of the frequency-converter system are quite similar to a conventional system.

#### 2.2.4.2 Illumination

Poultry housing may use only artificial light or may allow natural light to enter (sometimes called 'daylight' housing). Laying activity and laying rate can be influenced by the use of artificial lighting.

Illumination is also important for poultry production. Different light schemes are applied with alternating periods of light and darkness. An example is shown in Table 2.4.

Age (days)	Duration (hours light/hours dark)	Intensity at ground level (lux)
1 to 3	24/24	30 – 50
3 and above	24/24 or 24/23 or 1/3	Progressive reduction to 5 – 10

**Table 2.4: Example of light requirements for poultry production as practised in Portugal [92, Portugal, 1999]**

In turkey housing, illumination is particularly important during the first few days, after which it can be reduced. Light schemes vary from continuous to 14 – 16 hours a day.

### 2.2.5 Poultry feeding and watering

#### 2.2.5.1 Poultry feed formulation

Feeding is very important, as the quality of feed determines the quality of the product. In particular broiler growth (reaching required weight in only 5 to 8 weeks) depends largely on feed quality. The way feed is obtained varies from purchasing of ready-to-use feed mixtures to the on-farm milling and preparation of the required mixtures, which are often stored in silos adjacent to the birds' housing.

Formulation of poultry feed is very important to meet the requirements of the animals and the production aims and to ensure the right level of energy and essential nutrients, such as amino acids, minerals and vitamins. Feed formulation and the addition of feed substances are regulated on a European level. For each feed substance additive, the relevant directives indicate the maximum dosage, for which species it is applicable, the appropriate age of the animal and whether a withdrawal period has to be observed.

The composition of poultry feed varies considerably – also between MSs –, as it is a mixture of different ingredients, such as:

- cereals and their residuals
- seeds and their residuals
- soya beans and pulses
- bulbs, tubers and roots or root crops
- products of animal origin (e.g. fish meal, meat and bone meal and milk products).

In Spain, for example, pork lard is added to the feed because of the lack of the enzyme lactase, but milk products are not included. And in the UK, 'bulbs, tubers and roots or root crops' are not fed to poultry and neither is bone meal.

The inclusion of the last category of components has now been called into serious question, where there are indications that this practice (feeding processed animal proteins) may have been an important cause of the development of BSE. See also Commission Decision 2000/766/EC. [201, Portugal, 2001]

Elements can be added to poultry feed for different reasons. There are substances that:

1. added in small amounts, can have a positive effect on growth, by increasing the gained weight and improving the feed conversion ratio (FCR). Others (e.g. antibiotics) can have a regulating effect on potential harmful gut flora [201, Portugal, 2001]
2. raise the quality of the feed (e.g. vitamins)
3. have a quality-raising effect on feed, e.g. so called technological additives, such as those that can improve the pressing of feed into granules
4. balance the protein quality of the feed, therefore improving the protein/N conversion (pure amino acids).

Formulating feeds can require the use of linear programming to obtain the required mixtures. All species need sufficient amino acids, but layers in particular require sufficient Ca to produce the eggshell. P is important for its role in the storage of Ca in the bones and will either be fed as a supplement or made more readily available by, for example, feeding phytase. Other minerals and trace elements in the feeds can be more or less controlled as well: Na, K, Cl, I, Fe, Cu, Mn, Se and Zn.

Essential amino acids for poultry are supplied, as their metabolism cannot supply them. They are: arginine, histidine, isoleucine, leucine, lysine, methionine (+cystine), phenylalanine (+tyrosine), threonine, tryptophan and valine. Cystine is not an essential amino acid, but methionine can only be made from cystine and thus they are always linked. As a result of the current ingredients in poultry feed, the most frequent amino acid deficiencies detected in feed mix are sulphur amino acids (methionine and cystine) and lysine. Another quoted deficiency is typically threonine. [171, FEFANA, 2001]

Other elements are not usually added, as they are already sufficiently available in the feed: S and F. Vitamins are not produced by the animals themselves, or are produced in insufficient quantities, and are therefore added to the daily ration. Vitamins are often part of a premix with minerals.

In several MSs the use of antibiotics in feed is under discussion. In several countries feeding without antibiotics is carried out, such as in Sweden, Finland and the UK (only poultry feed), as these have a total ban on the use of all feed antibiotics (including the ones authorised in the EU). See also Section 2.3.3.1 on the use of antibiotics in pig feed.

Apart from the feed formulation, to feed closer to the requirements of the birds, also different types of feeding are given during production cycles. For the different categories, the following number of feeds are most commonly applied:

- layers        2-phase (feeding up to laying, during laying)
- broilers     3-phase (early weeks growing, finishing)
- turkeys     4 - 6 phase (more types for stags than for hens)

Layers can also have a 6-phase feeding, 3 phases up to laying and 3 phases during laying, or 2 to 3 phases up to laying and 1 or 2 phases during laying. [183, NFU/NPA, 2001] [201, Portugal, 2001].

### 2.2.5.2 Feeding systems

Feeding practices depend on the type of production and bird species. Feed is given in mashed form, crumbs or pellets.

Layers are generally fed ad libitum [183, NFU/NPA, 2001] [173, Spain, 2001]. Meat species, such as broilers and turkeys, are also fed ad libitum. Hand feeding is still applied, but in large enterprises, modern feeding systems are applied that reduce spillage of feed and allow accurate (phase) feeding.

Common feeding systems are:

- chain feed conveyor
- auger conveyor
- feeding pans and
- moving feed hopper.

Chain feed conveyors move feed from storage through the feeding gutter. It is possible to influence the feeding pattern, spilling and rationing by adjusting the velocity of the conveyor. Chain feed conveyors are common in floor systems and are also applied in cage systems.

In the auger conveyor, feed is pushed or pulled through the feeding gutter by a spiral. Spillage is low. Application is common in floor systems and aviary systems.

Feeding pans or bowls are connected with the supply via the transport system. The diameter varies from 300 to 400 mm. Feed is transported by a spiral, chain or a steel rod with small scrapers. The system is designed with a lifting device. They are applied in floor systems (e.g. broilers, turkeys and ducks). In the case of bowls, one bowl feeds approximately 65 – 70 birds. For feeding of turkeys, feeding pans are used in the earlier life-stage, but at a later stage feeding barrels (50 – 60 kg) are also used. Feed is supplied in large buckets or square feeding troughs. Tube feeding systems are increasingly applied to reduce spillage.

A feed hopper is a moving system applied in battery systems. It moves alongside the cages on wheels or a rail and is equipped with a funnel shaped hopper. Moved by hand or electrically, this system fills the feeding trays or gutters.

### 2.2.5.3 Drinking water supply systems

For all poultry species water has to be available without restriction. Techniques applying restricted watering have been tried, but for welfare reasons this practice is no longer allowed. Various drinking systems are applied. Design and control of the drinking system aims to provide sufficient water at all times and to prevent spillage at the same time and further wetting of the manure. There are basically three systems [26, LNV, 1994]:

- nipple drinkers
  - high capacity nipple drinkers (80 – 90 ml/min)
  - low capacity nipple drinkers (30 – 50 ml/min)
- round drinkers
- water troughs.

Nipple drinkers have various designs. Usually they are made of a combination of plastic and steel. The nipples are placed underneath the water supply pipe. High capacity nipple drinkers have the advantage that the animal quickly receives a proper amount of water, but has the disadvantage of leaking water during drinking. To catch this leakage, little cups are installed underneath the nipples. The low capacity nipple drinkers do not show the problem of leaking water, but it takes more time for an animal to drink enough water. In aviary systems the drinking hen may block the path of the hens on their way to the nest, and subsequently the eggs can end up in the litter instead of in the nest. [206, Netherlands, 2002]

In floor housing, the nipple drinker system can be installed in such a way that it can be lifted out (for example for cleaning, mucking out). It works with low pressure. A pressure control system is installed at the beginning of each pipe, with a water gauge to measure the consumption.

Round drinkers are made of strong plastic and have different designs depending on the type of bird or the system they are applied to. They are usually attached to a winched line and can be pulled up. They work on low pressure and are easily adjustable.



Water troughs are placed on or below the water supply pipe. There are two designs that either automatically have water in the cup or that supply water when a metal strip is touched.

In most layer housing systems automatic watering systems are applied using nipple drinkers. In the Netherlands 90 % of the water supply systems for layers are nipple drinkers and 10 % are round drinkers [206, Netherlands, 2002].

Drinker system for layers	Number of animals per system			
	Cage system	Enriched cage	Floor system	Aviary system
Nipple drinker (birds/nipple)	2 – 6	5 <sup>1)</sup>	4 – 6 <sup>1)</sup>	10
Round drinker (birds/drinker) <sup>2)</sup>	-	-	125	-
Water trough (birds/trough)	-	-	80 – 100	-

*1) nipple drinkers with cup design*  
*2) round drinkers are also used in other systems to a much lesser extent*

**Table 2.5: Applied number of animals per drinker system in different cages [124, Germany, 2001]**

However, minimum standards on drinking systems for the protection of laying hens are laid down in Directive 1999/74/EC.

In broiler houses watering points are installed in many places. A commonly used system consists of round drinkers and nipples drinkers. The round drinker design gives every bird easy access to water and aims at minimum spillage to prevent wetting the litter. With cups, 40 animals are served and with drinking nipples 12 – 15 animals per nipple is applied.

In the UK nipple drinkers are more commonly applied to broilers than round drinkers, but in the Netherlands only 10 % of the water supply systems for broilers are nipple drinkers and 90 % are round drinkers. [183, NFU/NPA, 2001] [206, Netherlands, 2002]

Drinking water for turkeys is supplied using round drinkers, bell drinkers or water troughs. Round drinkers and troughs can differ in size according to the stage of production (smaller or larger birds). Nipple drinkers are generally not applied, as turkeys do not use these effectively.

## 2.3 Pig production

### 2.3.1 Pig housing and manure collection

The information exchange on the intensive rearing of poultry and pigs confirmed the conclusions of an inventory of European pig housing systems. This inventory, drawn up in 1997, highlighted that there are large differences in pig housing systems between countries as well as within countries [31, EAAP, 1998]. Factors that are considered to be responsible for this variation are:

- climatic conditions
- legislation and socio-economic issues
- economic value of pig sector and profit
- farm structure and ownership
- research
- resources
- traditions.

It is expected that this variation will slowly disappear with increased requirements laid down by directives concerning animal health and welfare, as well as with increased market demands and public concern about the food production chain.

In intensive pig production, different designs apply to different stages of production. The different groups that can be distinguished require different conditions (temperature and management). The following housing systems for sows and pigs can be distinguished:

- housing systems for mating sows
- housing systems for gestating sows
- individual housing systems for lactating sows
- housing systems for weaned piglets (from weaning up to 25 – 30 kg LW)
- housing systems for growers-finishers (from 25 – 30 kg up to 90 – 160 kg of LW).

Intensive pig production applies the all-in/all-out (or batch) system. Also, in order to protect the pigs from infectious diseases, production animals that are brought from outside into a piglet or combined pig production unit may be put in quarantine for a minimum required period (e.g. 30 days, Finland). Manure obtained from this section is usually removed directly to the manure store and not through a manure channel in the pig house. This housing system is not separately addressed in this section.

For all systems, variations in flooring consist of the application of fully-slatted (FS), partly-slatted (PS) or solid (concrete) floors (SCF) and the use of straw or other litter. Slats can be made of concrete, iron or plastic and have different shapes (e.g. triangular). The area of open surface is approximately 20 – 30 % of that of the slatted surface.

In the systems housing sows (without offspring), a distinction is also made between group and individual housing, whereas weaners and growers-finishers are always housed in a group.

Systems for removing manure and urine are related to flooring system, varying from deep pits with a long storage period to shallow pits and manure channels through which the slurry is removed frequently by gravity and valves or by flushing with a liquid.

A further distinction can be made between housing that is naturally ventilated and housing in which the climate is controlled by heating and/or cooling and by forced ventilation with fans.

The housing construction itself shows a variation comparable to that of the flooring systems. Houses can be constructed of durable material and brick-built to withstand cold temperatures, but much lighter material and open constructions are also used. In some Member States artificial heating is commonly applied to all classes of stock including dry sows. From a study comparing the differences between housing systems in the Netherlands and the UK, it is clear that such differences in application do not have to be linked to differences in climatic conditions.

In the following sections technical descriptions are presented of the commonly applied housing systems for sows, weaners and growers-finishers. The environmental performances and other characteristics are described and evaluated in Chapter 4. The overview aims to be representative for the currently applied techniques, but could never be exhaustive given the observed variation in systems and their adapted designs. Information has been used that can be found [10, Netherlands, 1999], [11, Italy, 1999], [31, EAAP, 1998], [59, Italy, 1999], [70, K.U. Laboratorium voor Agrarische Bouwkunde, 1999], [87, Denmark, 2000], [89, Spain, 2000], [120, ADAS, 1999], [121, EC, 2001], [122, Netherlands, 2001], [123, Belgium, 2001], [124, Germany, 2001] and [125, Finland, 2001].

### 2.3.1.1 Housing systems for mating and gestating sows

Sows are housed in different systems depending on the phase of the reproduction cycle they are in. Mating sows are kept in systems which facilitate easy contact between boar(s) and sows. After mating, the sows are usually moved to a separate part of the housing for their gestating period.

In [31, EAAP, 1998] the following observations were made on the housing of sows. Mating and gestating sows are housed individually or in groups. Each method has its advantages and disadvantages to both the animal and the farmer. The differences between individual and group housing are in:

- animal behaviour
- health
- labour intensity.

Individual housing systems generally score better on health and labour intensity. For example, individually housed sows are limited in their movement, but they are easier to control and there is more tranquillity in the stall, which has a positive affect on the mating and in the early stages of gestation [31, EAAP, 1998]. It is also easier to feed the sows in individual housing, where competition does not play a role. However, group housing seems to be better for reproduction.

The pattern of application of systems in Europe is similar for both mating and gestating sows:

- mating sows – 74 % individual against 26 % group-housed
- gestating sows – 70 % individual against 30 % group-housed.

In the UK, most **mating** sows (85 %) are group-housed and have access to straw (> 55 %), as a result of British welfare legislation requiring all sows to be loose-housed from weaning to farrowing by 1999. In Member States producing for the UK market (e.g. Denmark) an increasing proportion of group-housing systems can be observed. Denmark has not prohibited individual confinement of sows in mating units, because several Danish studies have indicated that group housing between weaning and 4 weeks post-weaning might increase the risk of embryo loss. As a consequence the number of live-born piglets/litter is reduced compared to individual housing.

In most other countries individual housing, i.e. stalls, is increasingly applied for mating sows.

Group-housing of **gestating** sows is tending to increase overall in those countries which have prohibited the use of stalls and tethers. Tether systems are rapidly decreasing in all countries and no tethering will be allowed from 31 December 2005 onwards [132, EC, 1991]. This system will therefore not be considered in the overview of applied sow housing techniques.

In the UK, the majority (80 %) of gestating sows are also group-housed and have access to straw (60 %) for the reasons mentioned above. In Germany, Ireland and Portugal loose-housing systems for gestating sows are increasing even though these countries have not banned confinement systems for sows, but here market, welfare and costs of production play a role.

In general, sow housing in Spain and France is dominated by stalls and in Spain, France, Greece and Italy these systems are used increasingly. In Italy, in a minority of cases, gestating sows are kept in individual stalls for the total pregnancy period. The majority of sows are kept in stalls for up to 30 days and are then moved to group pens after the pregnancy is confirmed.

The use of straw in the group-housing of sows is still limited, but is expected to increase under the influence of animal welfare considerations and because of indications that fibre might reduce aggression in sows housed in a group.

### 2.3.1.1.1 Individual housing with a fully or partly-slatted floor for mating and gestating sows

This way of housing mating and gestating sows is very common. The crates measure about 2 m x 0.60 – 0.65 m and the rear end is equipped with concrete slats over a deep pit in which slurry and cleaning waters are stored. Feeding systems and drinkers are placed at the front end.

A central slatted alley runs between the rows of crates and a concrete-floored gangway runs on either side of the crates for feeding. In the mating house, there will be pens for housing the boars (Figure 2.13). These pens are absent in the housing section for gestating sows.

Slurry is collected under the slats and stored in a deep or a shallow pit. The slurry removal rate depends on the pit size. Natural or mechanical ventilation is applied and sometimes a heating system.

The picture shows a common design, but various other designs (with partly-slatted floors (PSF)) are applied to enhance intensive contact between boar and sows. Also, the sows may face the central alley with the troughs placed on the inner side and the slatted area will be at the side corridors.

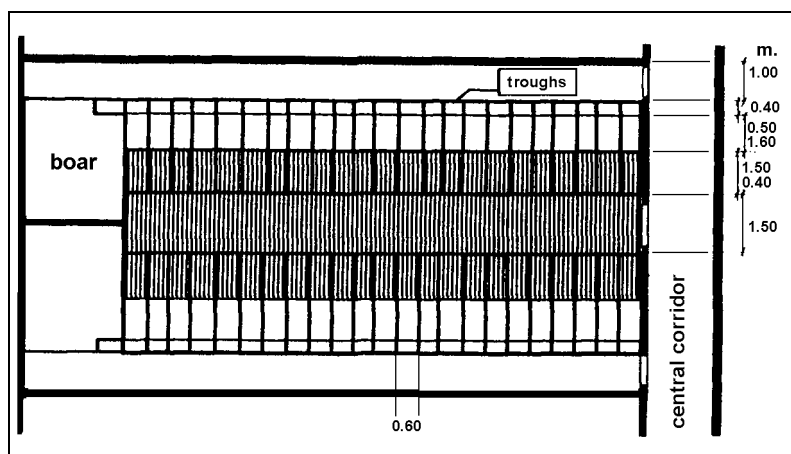
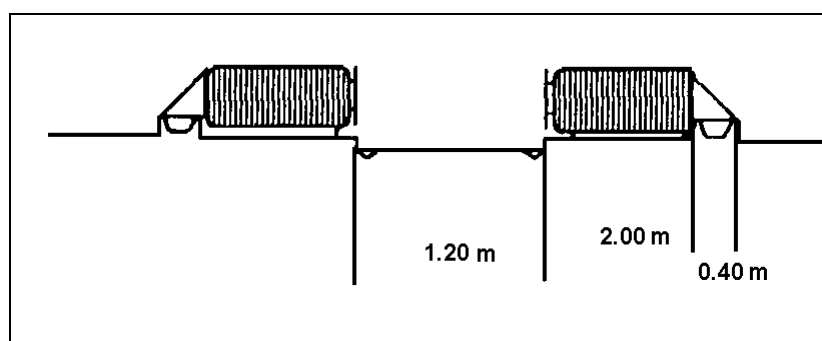

Figure 2.13: Schematic overview of a housing design for mating sows on a partly-slatted floor [31, EAAP, 1998]

### 2.3.1.1.2 Sow crates with a solid floor for mating and gestating sows

In this system mating and gestating sows are housed on concrete floors in a similar way to the design with the PSF, but there is a difference in the design applied to the floor and the removal of manure. Again, feeding and watering are applied at the front of the crate. In the central alley there is a drain-system for removal of urine. Mucking-out of manure and straw (where that is applied) is done frequently.

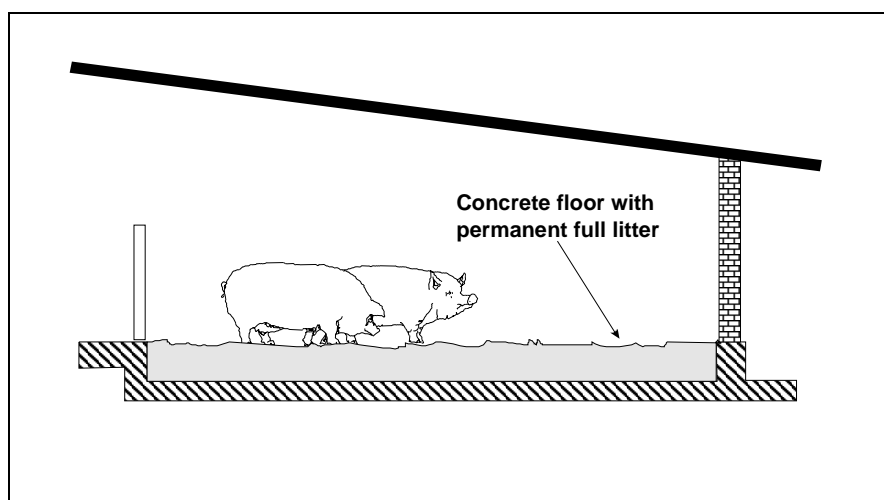

**Figure 2.14:** Floor design for sow crates with a solid concrete floor for mating and gestating sows [31, EAAP, 1998]

In these systems ventilation is natural when straw is applied and mechanical in insulated buildings where no straw is used.

### 2.3.1.1.3 Group housing with or without straw for gestating sows

Two basic designs for group housing of mating and gestating sows are applied. One system has a solid concrete floor with deep litter and the other design has slatted floors at the dunging area and the feeding stalls. The solid part is (almost) completely bedded by a layer of straw or other ligno-cellulosic materials to absorb urine and incorporate faeces. Solid manure is obtained and has to be frequently removed in order to avoid the litter becoming too moist. A frequency of removal of 1 – 4 times a year has been reported but this depends on the litter type, the depth of the bedded area and on general farm management. The frequency of complete litter removal can be higher in Italy, e.g. up to 6 – 8 times. In addition, partial removal of the moistened litter can be carried out weekly. In the case of one cleaning per year, it is spread directly onto the field. With more cleanings the litter is generally stored, such as in a field clamp.



**Figure 2.15:** Example of group-housing for gestating sows on a solid concrete floor with full litter [185, Italy, 2001]

For the ventilation of this housing the same principle applies as for the individual housing of sows. With the application of straw, heating is generally not applied as, at low temperatures, the sows are able to compensate by hiding in the deep litter. The design of this system can vary and can contain various functional areas. An example is shown in Figure 2.16.

Manure handling with this system has been described as follows. In units where bedding is used exclusively for rooting, the amount of litter will be so limited that all the manure is handled in the form of slurry. In units with slatted floor in the dunging area, the manure is cleaned daily using underslat scrapers. In units with solid floor the manure is cleaned either daily with scrapers or 2 – 3 times a week using a tractor-mounted tyre scraper. In units with deep litter in the lying area, the litter is removed 1 – 2 times annually.

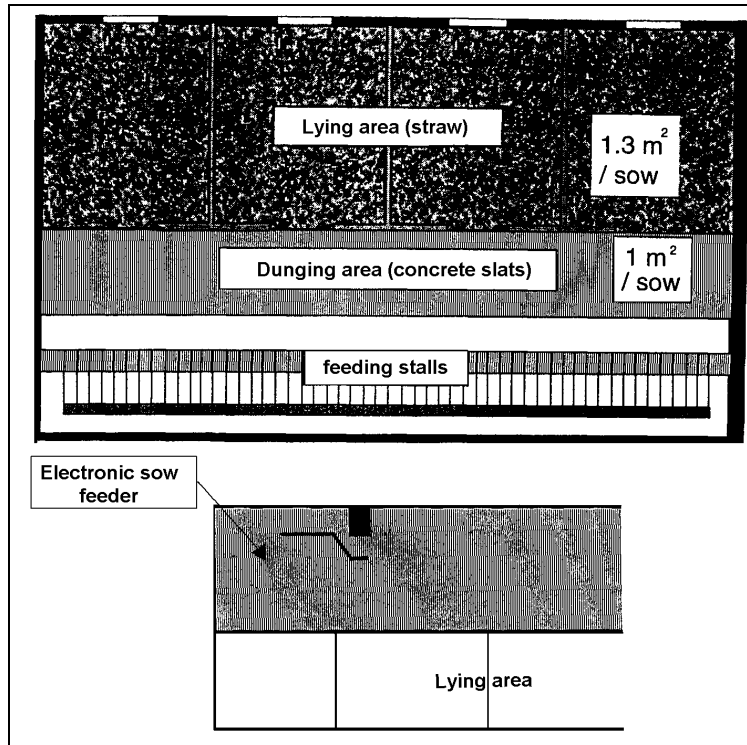

**Figure 2.16: Example of a housing system with several functional areas for gestating sows [87, Denmark, 2000]**

### 2.3.1.2 Housing systems for farrowing sows

Shortly before farrowing (about 1 week), gestating sows are moved to farrowing pens. There are different designs of farrowing pens. A common design has partly- or fully-slatted floors and generally no straw. The sows are often confined in their movement, but loose housing is also applied. For example, straw-based and loose housing can be found in the UK. Fully-slatted is applied widely as it is considered to be more hygienic and labour efficient than partly-slatted or solid floors. On the other hand, Danish information indicates that partly-slatted systems are more energy efficient and a gradual increase in partly-slatted systems is being observed. In Austria, the fully-slatted floor systems are in decline [194, Austria, 2001].

General features of farrowing compartments are:

- applied minimum room temperature of 18 °C
- temperature for the sows 16 – 18 °C
- temperature for the piglets about 33 °C
- low airflow, in particular in the piglet area.

#### 2.3.1.2.1 Housing for farrowing sows with confined movement

A cross-section of a typical pen system for farrowing sows is shown in Figure 2.18. Farrowing pen sections generally contain not more than 10 – 12 sows (pens). Pen sizes measure 4 to 5 m<sup>2</sup>.

Piglets are housed in these systems until weaning after which they are sold or reared in rearing pens (weaner housing). The floor can be fully or partly slatted. Slats made of plastic or plastic-coated metal are increasingly used instead of concrete, as they are considered to be more comfortable.

The slurry is stored under the slatted floor of the crates either in a shallow pit (0.8 m.), in which case it is removed frequently via a central system in the building, or in a deep pit, from where it is removed only at the end of the lactating period or less frequently.

There is a specific area for the piglets, usually positioned in the central alley (for easier observation) between the pens. This area is generally not slatted and is heated during the first days after birth by using a lamp or by warming the floor or both. The sow is limited in her movement to prevent her from crushing the piglets.



**Figure 2.17: Farrowing pen design with a fully-slatted floor (the Netherlands)**

Forced or natural ventilation is applied in such a way that the airflow will not disturb the climate at floor level (around sow and pigs). In modern closed housing, fully automatic climate control is applied, thereby maintaining the temperature and humidity in the farrowing section at a constant level.

The position of the sow is often as pictured in Figure 2.18, but the crates are also put the other way around with the sows facing the alley. In practice, some farmers have observed that this position makes the sows more relaxed, as they can more easily notice movements in the alley, whereas in the other position they cannot turn, which makes them more restless.

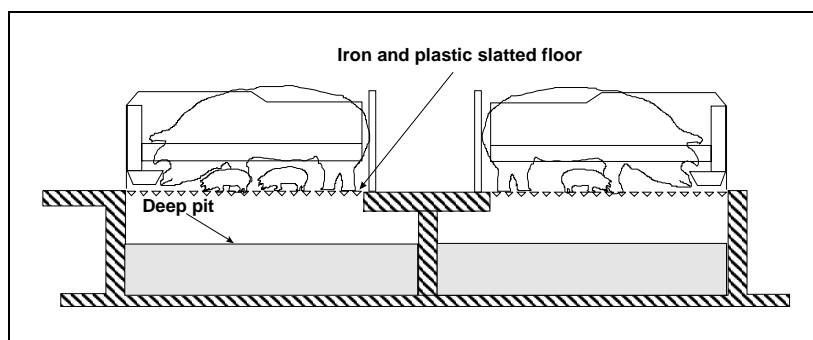
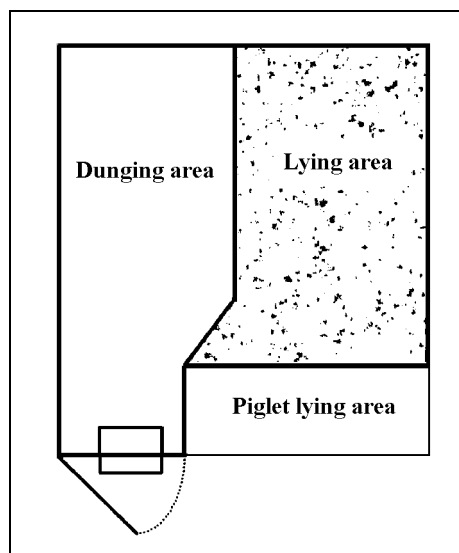

**Figure 2.18: Example of confined housing of farrowing sows on a fully-slatted floor with a storage pit underneath**  
[185, Italy, 2001]

### 2.3.1.2.2 Housing of farrowing sows allowing sow movement

Farrowing sows are housed without being confined in their movement in systems with partly-slatted floors. A separate lying area for the piglets prevents them from being crushed by the sow. This pen is sometimes used to raise the piglets from weaning until about 25 – 30 kg LW. This design requires more space than the design with restricted sow movement and needs more frequent cleaning. Number of pens or sows per compartment is generally less than 10.

Material for the floor system and heating and ventilation requirements for sow and piglets are the same for this system. With free sow housing, the walls of the pen are slightly higher than for the pen with restricted movement.



**Figure 2.19: Example of an applied plan for a farrowing pen (partly-slatted floor) without restricted sow movement**  
[31, EAAP, 1998]

### 2.3.1.3 Housing systems for weaners

Pigs are weaned at approximately 4 weeks (range 3 to 6 weeks), after which they are kept in small groups of the same litter (8 – 12 pigs per pen) up to 30 kg LW (range 25 – 35). However, in the UK the pigs are kept in larger groups. The majority of animals are housed in pens or cages with fully-slatted flooring. Earlier, farrowing pens were frequently used for weaned pigs, but this housing method is apparently being used less and less, except in Greece. The piglets



would remain in the pen (see Figure 2.17) after the sow had been taken to another unit and the crate had been removed. The use of pens specifically designed for the rearing of weaned pigs is, however, more common and is increasing, because it offers better environmental control and management than the older systems.

The tendency is that systems with partly-slatted flooring are decreasing in popularity while fully-slatted flooring systems are increasingly becoming popular, except in Denmark, Belgium and the Netherlands. In Denmark systems with a covered lying area and two-thirds solid floor have become increasingly popular in recent years. Research indicates that this system is more energy efficient than commonly used heated nurseries. Moreover, pen fouling is not a problem, which is one of the main reasons why pig producers tend to select fully-slatted flooring over partly-slatted flooring. In Belgium and the Netherlands there are strong incentives to reduce ammonia emissions and research has indicated that increasing the amount of solid floor (or reducing the slatted) might reduce emissions. Farmers are therefore rewarded for installing such systems [31, EAAP, 1998].

A large proportion (40 %) of the weaners in the UK are housed in relatively cheap straw-based systems, which may be explained by the mild climatic conditions and a tradition of using low-cost housing systems. Straw-based systems are also popular in Denmark and France. In both countries large amounts of straw are available and pig production is normally tied in with crop production (cereals) following a long tradition of using straw from crops in animal production.

Housing of weaners on fully- or partly-slatted floors is very similar to the housing of growers/finishers (Figure 2.20).

The housing is equipped with mechanical ventilation, either negative pressure or balanced pressures type. Ventilation is dimensioned at an output of maximum 40 m<sup>3</sup>/h per place. Auxiliary heating is used in the form of electric fan heaters or a central heating plant with heating pipes.

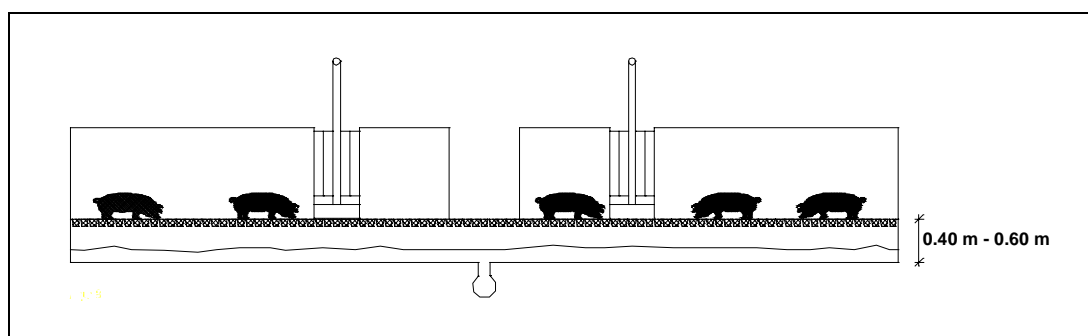

**Figure 2.20: Cross-section of rearing unit with fully-slatted floor and plastic or metal slats [87, Denmark, 2000]**

Manure is handled in the form of slurry and is drained mainly through a pipe discharge plant where the individual sections of the manure channels are emptied via plugs in the pipes. The channels can also be drained via gates. The channels are cleaned after the removal of each group of pigs, often in connection with the cleaning of the pens, i.e. at intervals of 6 – 8 weeks.

In the partly-slatted design a covered lying area is applied which can be removed or lifted, once the pigs have grown and need more ventilation.

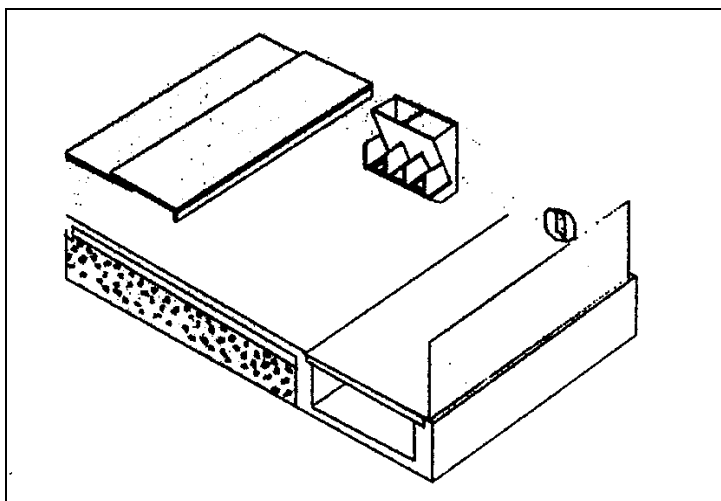

**Figure 2.21: Schematic picture of a weaner pen with a partly-slatted floor (1/3) and a cover above the lying area [31, EAAP, 1998]**

A special design is the housing of weaners in flat decks [133, Peirson/Brade, 2001]. Flat decks were initially developed in the late 1960s and early 1970s as a specialised housing system to provide controlled environment housing for piglets, weaned at 3 to 4 weeks of age, through to 15 – 20 kg live weight. The concept has been extended and is also used to provide second stage housing from about 15 – 20 kg through to weights of up to 50 or 60 kg when pigs make their final move into finishing pens. The thermally insulated buildings used are often of a pre-fabricated sandwich construction with external wood or panel cladding, thermal insulation and panelled internal cladding. The internal layouts and structures have also been installed inside more permanent buildings.

Flat decks are built around a batch system so that each room is stocked on an “all in – all out” basis with piglets from a batch of sows farrowed in the same week. Early designs were based on small group sizes – around 10 pigs per pen – but pen group sizes have tended to increase in recent years.

The original concept was based on fully-slatted pen floors suspended over slurry channels (or tanks) and pens down one or both sides of a feed/access passage. Fully-slatted flooring was seen as an important hygiene/health feature because it separates piglets from their faeces and urine. Floors were originally “weldmesh” or expanded metal. More recently plastic flooring has been used. The pen floor level was originally raised (in comparison to that of the passage floor), but more recent designs have passages and pen floors at the same level.

Ventilation is almost exclusively provided by extractor fans. Typically, air is drawn into each room through inlets in one end of the room from an access passageway common to a group of flat deck rooms. Inlet air is preheated, as necessary, by automatically controlled heaters. Extractor fans, normally situated in the opposite wall, are intended to create air movements across the room, and radiant heaters above the pens (or underfloor heating) provide additional temperature/comfort control.

Feed is normally provided as dry pellets or meal offered in ad-lib hoppers on the front (passage) side of each pen. Slurry is removed from the below-slat channels or tanks at the end of each stocking batch. Pens are power-washed between batches.

Room temperatures are maintained at 28 – 30 °C for the first few days after weaning and are then reduced as the piglets grow. Occupation is usually 4 – 5 weeks in the first-stage pens, and by the end of this period temperatures would have been reduced to 20 – 22 °C.

Many features of flat decks have evolved and been developed over the years. Now the term flat deck is often used to loosely describe almost all slurry-based weaner-housing systems, many of which bear little resemblance to the original concept. Some farmers have provided solid floored lying areas to help improve pig comfort and welfare. Underfloor heating has become a more common feature. Group sizes have tended to increase and the system is slowly evolving into a “nursery” room system with groups of up to around 100 pigs in a group in a partially solid-floored pen (around one third of the floor area solid) and no access passageways.

#### **2.3.1.4 Housing of growers-finishers**

From an average LW of 30 kg (25 – 35 kg) pigs are moved to separate sections to be grown and finished for slaughter. It is not uncommon to house growers (e.g. up to 60 kg) and finishers (from 60 kg onwards) in separate sections, but the housing facilities are very much the same. The housing systems used for growers-finishers can be compared with weaner houses (Section 2.3.1.3), except that most grower/finishers are kept in systems with little or no straw. Partly- and fully-slatted flooring are equally common, but there is a trend towards more fully-slatted flooring except in Belgium, Denmark, the Netherlands, and the UK.

The growing-finishing housing is a brick-built, open or closed, insulated construction for 100 to 200 pigs. It is usually divided into compartments for 10 – 15 pigs (small groups) or up to 24 pigs (large groups). The pens are arranged either with the aisle on one side or in a double row with the aisle in the centre. In the pens with a solid concrete floor, movable covers are used to cover the lying area, at least during the first stage of the growing period.

Feed distribution is usually automated and can be sensor-controlled. Liquid or dry feeding is applied ad-lib or restricted and multi-phase (adapted N and P content). Design of feeding troughs and drinkers depends on type of feeding.

##### **2.3.1.4.1 Housing of growers-finishers on a fully-slatted floor**

This housing system is very common for small (10 – 15 pigs) and large groups (up to 24) of growers-finishers. It is applied in closed, thermally insulated housing with mechanical ventilation and in houses with natural ventilation. Windows allow daylight in and electrical light is used. Auxiliary heating is applied only when necessary, as the pigs’ body-heat is usually capable of satisfying the heat requirement.

The pen is fully slatted and has no physical separation of the lying, eating and dunging areas. The slats are made of concrete or (plastic coated) iron. Manure is trodden through and urine mixes with the manure or runs off through urine/liquid manure channels. The slurry is collected in a manure pit under the fully-slatted floor. Depending on the depth of the pit, it may provide for an extended storage period (high ammonia levels in the house) or it is emptied frequently and the slurry is stored in a separate storage facility. A frequently applied system has the individual sections connected by a central drain, into which they are emptied by lifting a plug or a gate in the pipe.

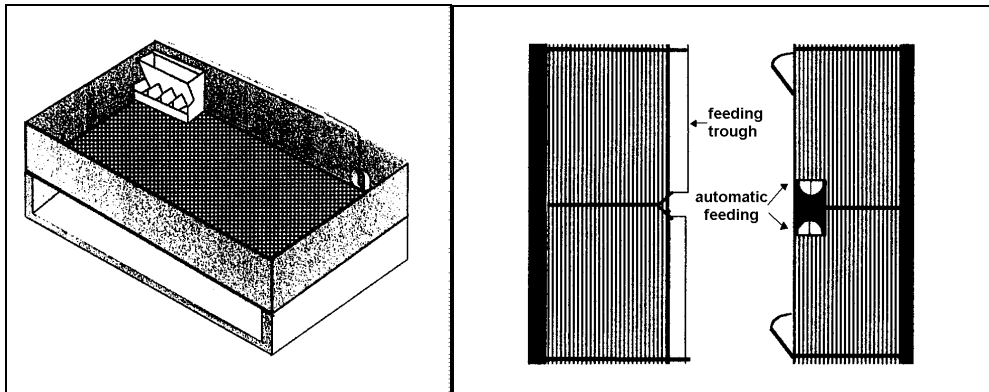

**Figure 2.22: Example of a single growing-finishing pen with a fully-slatted floor and examples of two pen layout with different feeding systems [31, EAAP, 1998]**

**2.3.1.4.2 Housing of growers/finishers on a partly-slatted floor**

Partly-slatted floor systems are applied in similar buildings to those used for fully-slatted-floor systems. The floor is divided into a slatted and a solid/non-slatted section. There are basically two options: to have the solid concrete floor on one side or in the centre of the pen. The solid part can be flat, convex or slightly inclined (see description below).

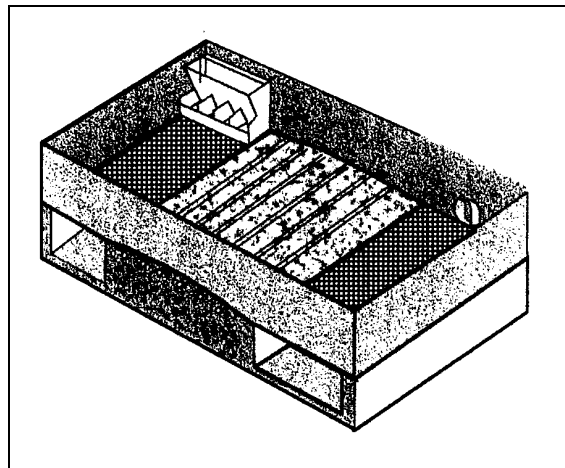

**Figure 2.23: Pen design for growers-fininishers with partly-slatted (convex) floor and solid area in the centre [31, EAAP, 1998]**

The solid part usually functions as a feeding and resting place and the slatted part is used for dunging. The slats are made of concrete or (plastic coated) iron. Manure is trodden through and urine mixes with the manure or runs off through urine/liquid manure channels. The slurry is collected in a manure pit under the fully-slatted floor. Depending on the depth of the pit, it may provide for an extended storage period (high ammonia levels in the house) or it is emptied frequently and the slurry is stored in a separate storage facility. A frequently applied system has the individual sections connected by a central drain, into which they are emptied by lifting a plug or a gate in the pipe.

Restricted straw is applied in the partly-slatted pen that is designed with a concrete floor and one slatted area (solid/slatted: 2:1). Straw is given in straw racks that are filled manually, and from which the pigs bring the straw in themselves. The solid floor has a slight incline and slurry and straw are moved towards the slats by the pigs' activity and therefore this system is also called straw-flow system. Manure is removed several times a day.

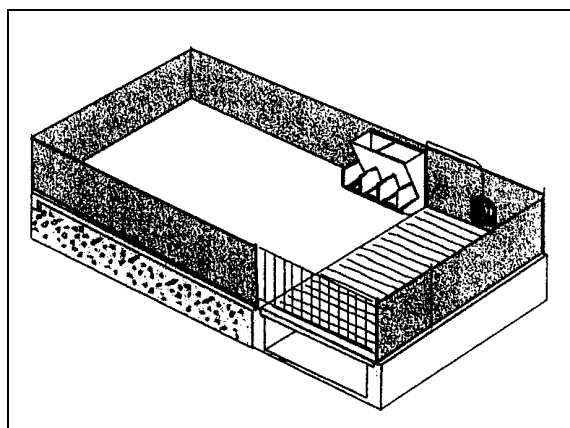

**Figure 2.24: Design of a partly-slatted floor system with restricted straw use for growers-finishers [31, EAAP, 1998]**

A partly-slatted design is applied in Italy with a solid concrete floor and an external slatted alley adjacent to a manure channel. In each pen, the pigs have their housing and feeding area inside the building, but an opening with a shutter allows them to reach the external dunging area with the slatted floor. The pig activity moves the manure through the slats into the manure channel, which is emptied once or twice a day with a scraper. The manure channel runs parallel to the pig building and is connected with a slurry storage facility. This system is also used for mating and gestating sows in group housing.

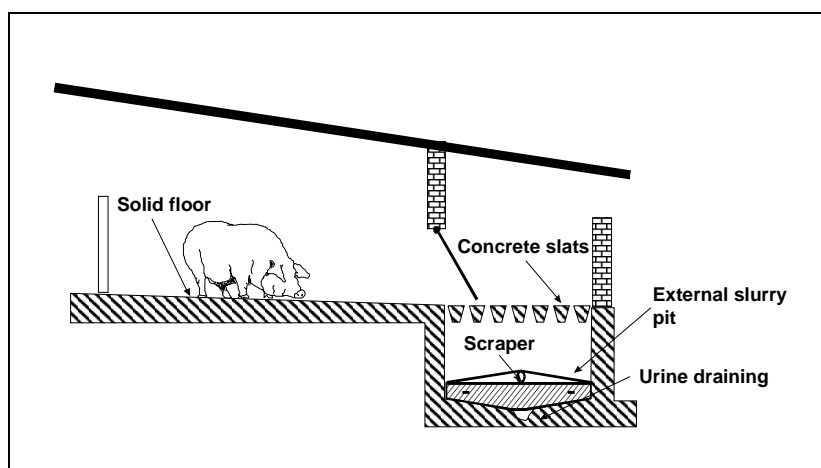

**Figure 2.25: Solid concrete floor with slatted external alley and scraper underneath [59, Italy, 1999]**

#### 2.3.1.4.3 Housing of growers-finishers on a solid concrete floor and straw

In the housing systems for growers-finishers with a concrete floor, straw is applied in restricted amounts for reasons of animal welfare or by big-bale supply to serve as bedding. These systems are applied in closed buildings or in open-front houses. The open-front designs are equipped with wind barriers (netting or spaceboards), but also straw bales are used for insulation and protection against the wind.



**Figure 2.26: Open front design using straw bales for protection (UK)**

Pen designs can vary, but usually there is a lying area with straw and a feeding area, which may be elevated and accessible by steps. The lying area may be covered. The pens may be positioned on one side of the building or on either side of a central aisle. Dunging takes place in the littered area. Mucking-out and cleaning are usually done with a front-end loader after each batch. Group size may be 35 – 40.

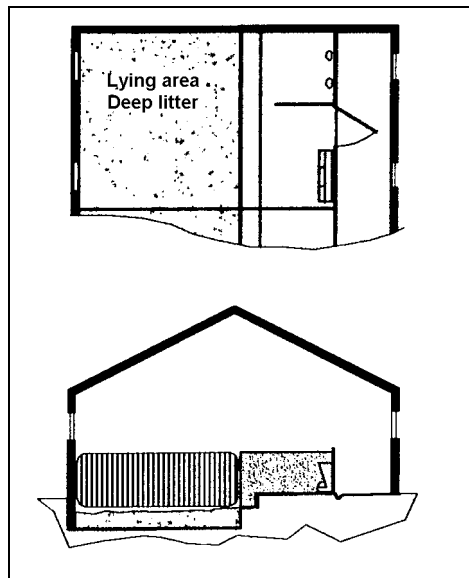

**Figure 2.27: An example of a solid concrete floor system for growers-finishers [31, EAAP, 1998]**

As with the partly-slatted design, a solid concrete floor system is applied in Italy with a littered external alley. The pen area inside is used for lying and feeding and has very little or no straw. The outside dunging area is littered and connected with a manure channel. Manure and straw are moved into the channel by the pigs' activity. Manure is removed once or twice daily by a drag chain or a scraper to an outside manure storage.

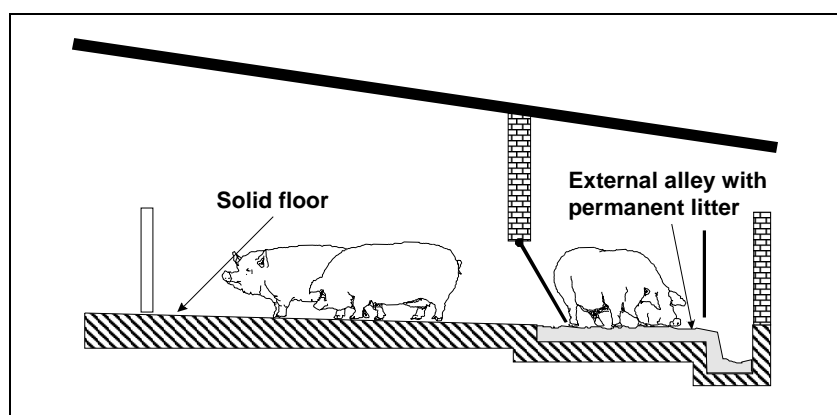

**Figure 2.28: Solid concrete floor with external littered alley and manure channel [59, Italy, 1999]**

### 2.3.2 Control of pig housing climate

The indoor climate in pig housing systems is important, as ammonia, combined with dust, is known to be a frequent cause of pig respiratory diseases, including atrophic rhinitis and enzootic pneumonia. Since stock workers can also be subject to respiratory health issues [98, FORUM, 1999], it is doubly important that pig housing be sufficiently ventilated.

Minimum (qualitative) requirements are laid down in Directive 91/630/EEC [132, EC, 1991] for the control of the pig housing climate. Temperature and humidity of air, dust levels, air circulation and gas concentrations must be below harmful levels. For example, the limit value concentrations shown in (Table 2.6) are advised, but these values vary between MSs. A good atmosphere in the house can be achieved by:

- insulation of the buildings
- heating
- ventilation.

Indoor environment factors	Level/occurrence
CO	Below measurable value
H <sub>2</sub> S	Below measurable value
Relative humidity H	Pigs up to 25 kg : 60 – 80 % Pigs 25 kg upwards : 50 – 60 %
NH <sub>3</sub>	Maximum 10 ppm
Air velocity	Farrowing pens and weaners: <0.15 m/s Mating and gestating sows: <0.20 m/s
CO <sub>2</sub>	Max. 0.20 volume-%

**Table 2.6: General indicative levels of indoor environment for pigs [27, IKC Veehouderij, 1993]**

Performance of the applied systems is affected by:

- design and construction of the building
- position of the building in relation to wind directions and surrounding objects
- application of control systems
- age and production stage of the pigs in the housing.

### 2.3.2.1 Heating of pig housing

The need for temperature control in pig housing depends on climatic conditions, construction of the building and stage of production of the animals. In general, in colder climates or climates with periods of low temperatures, buildings are insulated and equipped with mechanical ventilation. In warmer regions (Mediterranean latitudes), high temperatures are a greater influence on welfare and productivity of adult pigs than low temperatures. Usually there is no need to install heating systems; animal body heat is generally sufficient to maintain welfare temperature within installations. In this context, climate control systems are mainly designed to guarantee good air circulation.

In some housing systems for sows and growers-finishers, large amounts of straw help the animals to maintain a comfortable temperature. However, the most important factors are live weight, age and production stage. Other factors that affect temperature requirements are:

- individual or group housing
- flooring system (fully- or partly slatted or solid floors)
- amount of feed (energy) the animals get.

Farrowing pen	Weaned pigs	Mating and gestating sows	Growers-finishers
Room, 1 <sup>st</sup> week up to 20 °C	7 kg up to 25 °C	Mating up to 20 °C	20 kg up to 20 °C
	10 kg up to 24 °C	Early gestation up to 20 °C	30 kg up to 18 °C
Piglet area, 1 <sup>st</sup> days up to 30 °C	15 kg up to 22 °C	Middle gestation up to 18 °C	40 kg up to 16 °C
	20 kg up to 20 °C	End of gestation up to 16 °C	50 kg up to 15 °C
	25 kg up to 18 °C		

**Table 2.7: Example of applied temperature requirements for calculation of heating capacity in heated housing for different pig categories in healthy condition [27, IKC Veehouderij, 1993]**

Pig housing can be heated by various systems. Heating is applied as local heating or room heating. Local heating has the advantage that it is aimed at the place where it is most needed. Systems applied are:

- floors equipped with heating elements
- heating elements above the pig places radiating heat onto the animals as well as onto the floor surface.

Room ventilation is applied by two methods:

- by preheating: incoming air is preheated by leading the air through a central corridor to warm it to a minimum temperature, to reduce temperature fluctuations and to improve air movement in the housing area
- by post-heating: heating is applied to the air once it has entered the housing area, to reduce temperature fluctuations and to reduce heating cost.

Heating can be direct or indirect. Direct heating is accomplished by applying installations such as:

- gas heat radiators: infra-red, gas air heaters and gas-fuelled radiation convectors
- electric heat radiators: special light-bulbs or ceramic radiators
- electric floor heating: on matting or in the floor
- heaters/blowers.



Indirect heating can be compared to central heating in domestic applications. The installations applied can be:

- standard boilers (efficiency: 50 – 65 %)
- improved efficiency boilers (improved efficiency: 75 %)
- high efficiency boilers (high efficiency: 90 %).

Boilers can be open or closed design. Open designs use indoor air for the burning process. Closed designs draw air from outside the building and are particularly suitable for dusty areas.

### 2.3.2.2 Ventilation of pig housing

Ventilation systems vary from manually controlled natural systems to fully automated fan-based systems. The following basic systems are examples of commonly used ventilation systems:

- Mechanical systems:
  - exhaust ventilation
  - pressure ventilation
  - neutral ventilation.
- Natural systems
  - hand controlled ventilation
  - automatically controlled natural ventilation (ACNV).

With mechanical systems, the distribution of air can be accurately adjusted by means of valves, positioning of the fan(s) and diameter of the air inlets. Natural ventilation depends more on the natural fluctuations of the outside air temperature and on the wind. With fans, more even airflow in the housing can be achieved. This is important when considering the application with housing systems, as the interaction between the housing (flooring) system and the ventilation system affects the air currents and temperature gradients in the house. For example, partly-slatted floors may combine better with mechanical ventilation than with natural ventilation, whereas with fully-slatted floors, natural ventilation may be equally applied [120, ADAS, 1999].

The volume of the housing area and the openings of air inlet and outlet have to correspond to create the required ventilation rate at all times. Irrespective of the production stage and the ventilation system, a draught stream close to the animals must be avoided. Until recently, the majority of ventilation and heat supply systems were installed independently, but in new installations (e.g. in Denmark) it is common to apply integrated installations that match heating and ventilation requirements [87, Denmark, 2000].

Control and adjustment of ventilation are important and can be carried out in different ways. Electronic equipment is applied to measure the revolutions per minute. A measuring fan in a ventilation tube can be used to measure the air velocity in the tube, which is related to a certain pressure and revolution rate.

The following principal ventilation techniques can be applied in pig housing [27, IKC Veehouderij, 1993] [125, Finland, 2001].

Exhaust ventilation in pig housing is ventilation by running fans in the sidewalls or in the roof. Adjustable ventilation openings or windows allow fresh air to be drawn in. Fans exhaust air outside, usually through the ceiling at one or more points. This creates under-pressure, and creates fresh airflows into the building through inlets. Fresh air inlets are usually on the wall close to the ceiling or in the ceiling, so that the air flows from between the roof and the ceiling to the outlet. It is typical in an exhaust ventilation system for the air pressure inside the building

to be lower than outside. Exhaust ventilation works well when it is warm outside and it is therefore a very popular and appropriate system in countries with warmer climates. On growing-finishing pig farms, heating costs may be relatively low when exhaust ventilation is used, provided that it is properly adjusted.

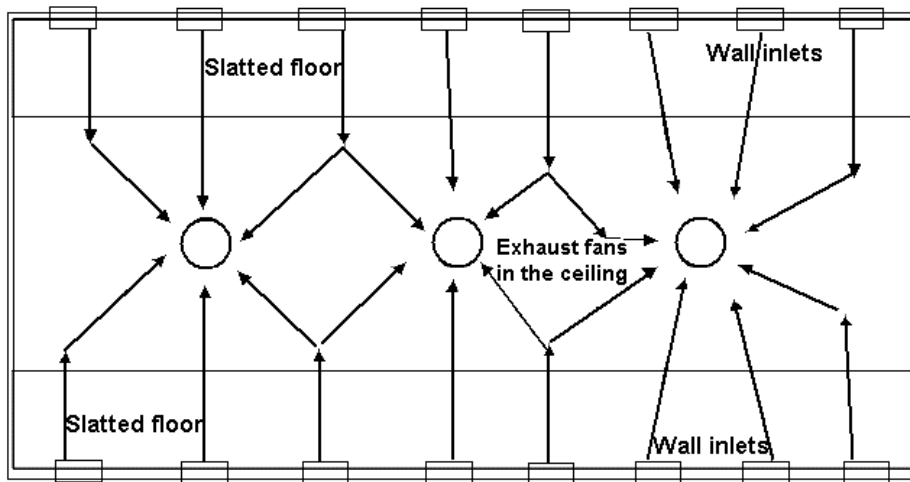

Figure 2.29: Schematic picture of airflow in an exhaust ventilation system [125, Finland, 2001]

In buildings with a pressure ventilation system, fans are used to blow air into the building, which means that the air pressure inside the building is higher than outside. Due to the difference in the pressure, air flows out of the building through outlets. When using pressure ventilation the air entering the building can be preheated, and thus part of the heating in the winter can be done by means of ventilation. The main problem in this system is that the airflow is quite uneven when only one blowing point is used. Airflow is rapid and the air is cold close to the fan, but the airflow slows down rapidly when moving further away from the fan. Blowing channels may be used to avoid this problem. Blowing channels are usually placed in the middle of the pig house.

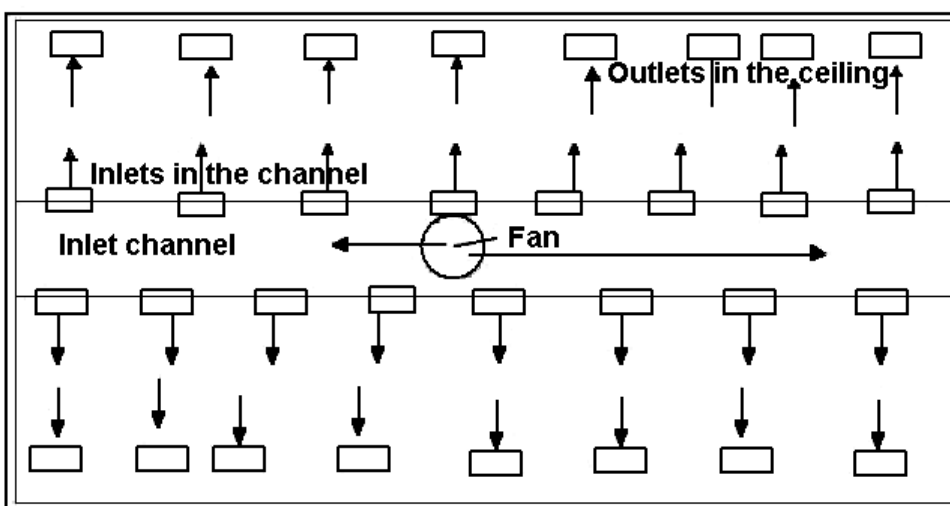
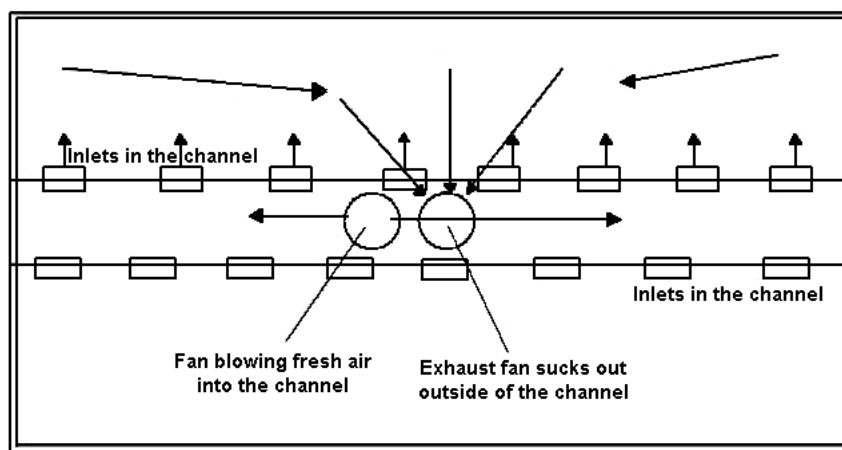

Figure 2.30: Schematic picture of airflow in a pressure ventilation system [125, Finland, 2001]

Air is blown into a channel, which spreads it through the building. The airflow, distribution and direction of the blow are controlled by means of nozzles. Sometimes humidity is a problem, which due to the higher pressure inside than outside leads to condensation on the surfaces of the channels when the air is not preheated. This is why pressure ventilation is not very common in colder climates. It can only be used in concrete buildings because the humidity can damage insulating materials and structural timbers.

A neutral ventilation system is a combination of the exhaust and pressure ventilation systems. As with exhaust ventilation, the exhaust air is drawn out of the building by means of a fan. However, the replacement air does not flow into the building because of negative pressure in the building, but air is drawn in through a channel. Thus, the difference between the air pressure inside and outside the building is much smaller than in the case of exhaust or pressure ventilation. In neutral ventilation, a heat exchanger can be used to reduce the need for additional heating. Neutral ventilation uses more energy than exhaust or pressure ventilation, because the air is drawn in and blown out. Investment costs are also higher, because twice as many blowers and blowing channels are needed as for the other systems.



**Figure 2.31: Schematic picture of airflow in a neutral ventilation system**  
[125, Finland, 2001]

Natural ventilation systems are based on the difference in density and air pressure between warm air and cold air due to wind, temperature and the so-called “chimney effect” that cause warm air to rise and cold air to replace it. The “chimney effect” depends on the relation between opening and position of air inlets and outlets and the inclination of the roof (25°; 0.46 m per metre stall width). Obviously, design and construction of the building are very important with natural ventilation. As the effect is based on temperature differences, it is clear that the effect is largest when the ventilation requirement is at its lowest (in winter).

The naturally created negative pressure is relatively small, even in winter in Finland reportedly less than 20 Pa, and in summer may have to be assisted by exhaust pressure ventilation. Thus, combinations of ventilation systems are applied that work alternately depending on the indoor and outdoor air temperatures. In countries such as the Netherlands wind is the prevailing factor that influences natural ventilation.

Automatically adjustable valves in the air inlets can be applied to control natural ventilation (ACNV). Sensors at pig level send a signal to the system that adjusts the opening of the inlets and thus increases or reduces the airflow.

Ventilation by drawing air from the manure pit in slatted floor systems is also applied and is considered an efficient way to reduce concentrations of manure gases in the house. This system has specific requirements of length and diameters of the air channels.

Irrespective of design or principle applied, ventilation systems have to provide the required ventilation rate, which varies with the different production stages and the time of year. Air velocity around the animals must be kept below 0.15 – 0.20 m/s to avoid a sense of draught.

Mating and gestating sows have relatively low temperature requirements. In Spain and Italy, many farms apply only natural ventilation, with air entering from outside directly into the animal housing area. Nevertheless, in large installations, with a high density of animals, ventilation requirements are met by means of fan ventilation.

Extractor fans are commonly used, but e.g. in Spain there is a trend towards pressure ventilation systems linked to evaporative refrigeration (cooling systems), that enable not only ventilation but also air temperature reductions inside the building.

Throughout Europe, in farrowing and weaning houses it is common to control the indoor climate by operating automatic (sensor controlled) ventilation systems with heating of the air. The inlet of the air is usually via a central corridor (indirect) and the design of the ventilation system in the units is such that draught near the animals is avoided.

Extra local heating is applied to the piglets during their first weeks. Often, a heating lamp (gas or electric) is installed above the solid (non-slatted) lying area. The lying surface itself can also be heated by running hot water through tubes or a reservoir underneath the floor surface.

Weaners still have temperature requirements that require control of temperature and ventilation. Heating may be required during cold weather and the following heating systems are used: radiant heating-lamps, electric heating (thermal bedding with a resistance wire heating) and also hot water heating-systems (under the floor or through aerial tubes).

Heating of the housing of growing and finishing pigs is not common, as their body heat is usually sufficient to create a comfortable environment. In pens with growers, removable covers are sometimes applied to create a more comfortable lying area in the early weeks. The majority of houses for growers-finishers are naturally ventilated with air inlet directly into the pen area, but extractor fans are also used.

Some farms, located in zones where summer temperatures are extremely high, use mist evaporative cooling systems to decrease housing temperature.

### **2.3.2.3 Illumination of pig housing**

Light requirements for pigs are laid down in Directive 91/630/EEC stating that pigs may never be permanently kept in the dark and need light comparable with normal daylight hours. Light must be available for good control of the animals and does not have a negative influence on pig production. Light can be artificial or natural entering through the windows, but additional electric light is normally applied.

Different lamps are used with different energy requirements. Fluorescent light are up to seven times more efficient than filament bulbs, but they are also generally more expensive to buy. Lighting installations should conform with normalised standards for safe operation and must be water-resistant. Lights are installed in such a way that sufficient radiation (light level) is assured to allow the required maintenance and control activities.

### 2.3.3 Pig feeding and watering systems

#### 2.3.3.1 Pig feed formulation

Feeding of pigs is aimed at supplying the required amount of net energy, essential amino acids, minerals, trace elements and vitamins for growth, fattening or reproduction. The composition and supply of pig feed is a key factor in the reduction of emissions to the environment from pig farming.

Pig feed formulation is a complex matter, combining many different components in the most economical way. Different factors influence the composition of a feed. Components used for feed formulation are determined by the location. For example in Spain, cereals are more commonly used inland, whereas in the coastal zones cereals may be partially replaced by cassava. It is now common that different feeds are applied enabling formulation closer to the requirements of the pig. For example, 2-phase feeding is applied for sows and 3-phase for finishers. This section can only give a short overview of the essential elements that are combined in pig feed.

An important feature of a feed is its energy content and in particular the amount of energy that is really available to the pig, the net energy. The net energy of a feed indicates the maximum amount of energy that can be stored as fat tissue and is expressed in MJ/kg.

Essential amino acids for pigs are supplied, as their metabolism cannot supply them. They are: arginine, histidine, isoleucine, leucine, lysine, methionine (+cystine), phenylalanine (+tyrosine), threonine, tryptophan and valine. Concerning the two sulphur containing amino acids, methionine and cystine, the last one is not essential, but as methionine is a precursor of cystine (two molecules of cystine produce one molecule of methionine), they are always linked. The first limiting amino acids are: lysine, methionine (+ cystine), threonine and tryptophan. To prevent deficiency, pig feed has to meet minimum requirements by selecting the right components or by adding synthetic amino acids. [172, Denmark, 2001] [201, Portugal, 2001]

The pigs' requirement for minerals and trace elements is a complex matter, even more so due to the interactions between them. Their doses in feeds are measured in g/kg (minerals) or mg/kg (trace elements). The most important are Ca and (digestible) P for bone tissue. Ca is also important for lactation and P is important for the energy system. Often their functionalities are related and so therefore attention must be given to their ratio. The minimum requirements vary for the different production stages or purposes. For early growth (including weaners) and lactation, more Ca and P is required than for growing and finishing. Mg, K, Na and Cl are usually given at levels sufficient to meet the requirements.

The requirements of trace elements are defined as minimum and maximum levels, as the elements are toxic above certain concentrations.

Important trace elements are Fe, Zn, Mn, Cu, Se and I. The requirements can usually be met, but Fe is given by injection to suckling piglets. Copper and zinc can be added to the feed ration of pigs in a quantity higher than the actual production needs in order to make use of the pharmacological effects and the positive effects on production performance (auxinic effect). However, European and national rules have been adopted, for example in Italy, regarding additives in feeds, which places limits on the addition of copper and zinc in order to reduce the quantity of these two metals in animal slurry.

Vitamins are organic substances that are important for many physiological processes, but can usually not (or not sufficiently) be provided by the pig itself and therefore have to be added to the pig's feed. There are two types of vitamins:

- fat soluble vitamins: A, D, E, K
- water soluble vitamins: B, H (Biotin) and C.

Vitamins A, D, E and K are supplied on a regular basis, but B-vitamins, H and C are supplied daily, as the animal can not store them (except B12). There are minimum requirements for the concentration of vitamins in pig feed, but the requirements of pigs are affected by many factors such as stress, disease and genetic variation. To meet the varying requirements, feed producers apply a safety margin, which means that usually more vitamins are supplied than necessary.

Other substances might be added to pig feed to improve:

- production levels (growth, FCR): e.g. antibiotics and growth promoting substances
- quality of feed: e.g. vitamins and trace elements
- technological characteristics of feed (taste, structure).

Organic acids and acid salts can be added for their effect on digestibility and to allow a better use of the feed energy.

Enzymes are substances that enhance chemical reactions of the pigs' digestive processes. By improving digestibility, they increase the availability of nutrients and improve the efficiency of metabolic processes [201, Portugal, 2001].

Most concern about the environmental importance of feed additives in intensive animal production, is related to the use of the antibiotics, and the potential risk of the development of drug-resistant bacteria. Their application is therefore strongly regulated and registration of these substances is organised at a European level. Authorised antibiotics and growth promoters might be used through the entire growing period, as they are not considered to leave any residues in the body as their metabolites do not cross the intestinal barrier [201, Portugal, 2001].

A report has been drafted on the aspects of the use of antibiotics in the animal production sector by the European Commission, [36, EC, 1999] and summarised in a note by Dijkmans [32, Vito, 1999]. It reports that the resistance of disease-spreading bacteria against a wide range of antibiotics is a growing problem in human medical science. The growing resistance is caused by the increased application of antibiotics in human health science, in veterinary science, and as a feed additive in animal breeding and even for plant protection.

Due to the use of antibiotics in feed, antibiotic resistant micro-organisms might develop in the gastro-intestinal tract of animals. Potentially these resistant bacteria can infest humans on or in the vicinity of the farm. The genetic material (DNA) can be taken up by other bacterial human pathogens. Potential routes for infection of humans are the consumption of contaminated meat or water, or food contaminated by manure. There may also be a risk of infection of people living near the farm.

In several countries, feeding without antibiotics is carried out, such as in Sweden, which has a total ban on all feed antibiotics (including the ones authorised in the EU) and in Denmark which has a total ban on the use of antibiotics in pig feed. In other MSs proposals are under discussion for the total ban on the use of antibiotics. The true effects of antibiotics on FCRs and on manure production are not agreed internationally. Similarly the environmental effects of antimicrobials are also unknown, e.g. such as the resistance of soil and water, and the consequences for soil and water ecology. Antibiotics still might be administered directly to animals in all MSs, even although they are not used in feeds [183, NFU/NPA, 2001].

### 2.3.3.2 Feeding systems

There are no uniform systems practised across the whole of Europe for pig feeding. Feeding systems can be linked with the feeding practice and feeding practice is normally linked with pig production type. For example in the UK, there are weaner producers who produce pigs of 30 kg from their own sows, fatteners who buy the 30 kg pigs and finish them at about 90 kg and

breeder-feeders who have their own sows, breed their own piglets and finish them at about 90 kg. [131, FORUM, 2001].

The design of the feeding installation depends on the structure of the pig feed. Liquid feeding is most common, but for example in Spain dry feeding is applied in 98 % of the farms, and mixtures are also applied. Regimes are ad libitum or restricted. For example in Italy the following variation applies [127, Italy, 2001]:

- on mating/gestating sows: 80 % of farms operate liquid feeding; the other 20 %, dry feeding
- farrowing sows and weaning piglets are (it is assumed) given dry feed
- growing/finishing pigs are liquid-fed on 80 % of farms, 5 % are fed with wetted feed, feed supplied as dry plus drinkers on 5 %, and dry-fed on 15 %.

As far as feeding systems are concerned, descriptions were given in [27, IKC Veehouderij, 1993] and [125, Finland, 2001]. The feeding system consists of the following parts:

- the feeding trough
- the storage facility
- the preparation
- the transport system
- the dosage system.

Feeding can vary from fully hand-operated to fully mechanised and automated systems. Troughs of different designs are used and provisions are made to prevent pigs lying in the trough. Feed is often delivered dry and mixed with water. Different dry feeds are purchased to allow a mixture close to the required nutrient content. Dry feed is usually transferred from the storage to the mixing machines by augers.

Liquid feeders consist of a mixing container, where the feed is mixed with water, and tubes to distribute it to the animals. The rationing of the mixture can be done automatically based on weighing the exact amounts or can be computer controlled, mixing according to the feeding plan and substituting feed when necessary. Liquid feeding can also be operated manually by weighing and mixing the required amounts.

In some loose housing for mating and gestating sows, feeding machines consist of a central feeding station detecting a label around the neck of the sow. The machine identifies the animal and supplies the required amount. The amount and supply are adjusted to allow the sow to eat as much and as often as it needs.

Distribution varies with the type of feed. Dry feed can be transported by a feeding cart or mechanically through tubes or spiral feeders in the same way as liquid feed. Liquid feed is pressed through a plastic tube system, in which the pressure is built up by the pumping system. There are centrifugal pumps, which can pump large amounts and can achieve about 3 bar. Displacement pumps have a lower capacity, but are less limited by pressure build up in the system.

The choice of feeding system is important as it can influence daily weight gain, FCR and percentage feed loss [124, Germany, 2001].

<b>Feeding system</b>	<b>Daily weight gains g/day</b>	<b>Feed conversion kg/kg</b>	<b>Losses %</b>
Dry feeding	681	3.05	3.23
Automatic mash dispenser	696	3.03	3.62
Liquid feeding	657	3.07	3.64

**Table 2.8: Effect of feeding system on weight gain, FCR and feed losses [124, Germany, 2001]**

### **2.3.3.3 Drinking water supply systems**

For the supply of drinking water, a great variety of drinker systems are available. Drinking water can be obtained from deep wells or from the public supply system. The quality of the water is the same as that for human consumption. In some MSs, installations have a main reservoir with a large capacity and with possibilities for disinfecting treatment; inside each house or sector there may be smaller reservoirs to allow water distribution together with medicines and/or vitamins. Different water supply systems are used, such as pipettes, shells or canals [130, Portugal, 2001].

Drinking water can be distributed to the animals in different ways:

- by nipple drinkers in the trough
- by nipple drinkers in a cup
- by a biting nipple
- by filling the trough.

By pressing a nipple with its nose, the pig can make water run into the trough or the cup. Minimum requirement capacities vary from 0.75 – 1.0 litres per minute for piglets and 1.0 - 4.0 litres per minute for sows.

A biting nipple gives water when the pig sucks on it and opens a valve. The water will not run into a trough or cup. The capacity of the bite nipple is 0.5 – 1.5 litres per minute.

Watering the animals by filling the trough can vary between a simple tap to a computerised dosing system measuring exactly the required volume.

## **2.4 Processing and storage of animal feed**

Many on-farm activities involve the processing and storage of feed. Many farmers obtain feed from external producers. It can be readily used or needs only very limited processing. On the other hand, some large enterprises produce the major part of the basic ingredients themselves and purchase some additives to produce the feed mixtures.

Processing of feedstuff consists of grinding or crushing and mixing. Mixing the feedstuffs to obtain a liquid feed is often done shortly before feeding the animals, as this liquid cannot be stored for a long period of time. Grinding and crushing are time-consuming and require a lot of energy. Other energy-consuming parts of the installation are the mixing equipment and the conveyor belts or air pressure generators used to transport the feed.

Feed processing and feed storage facilities are usually located as close as possible to the animal housing. Feed produced on the farm is usually stored in silos or sheds as dry cereals; gas emissions are then limited to the emission of carbon dioxide from respiration.



Industrial feed can be wet or dry. If dry it is often pelleted or granulated to allow easier handling. Dry feed is transported in tanker lorries and unloaded straight into closed silos, therefore dust emissions are usually not a problem.

There are many different designs of silos and materials used. They can be flat at the bottom to stand on the ground or conical, resting on a supporting construction. Sizes and storage capacities are numerous. Nowadays, they are often made of polyester or similar material and the inside is made as smooth as possible to prevent residues sticking to the wall. For liquid feed, materials (resins) are applied to resist low pH products or high temperatures.

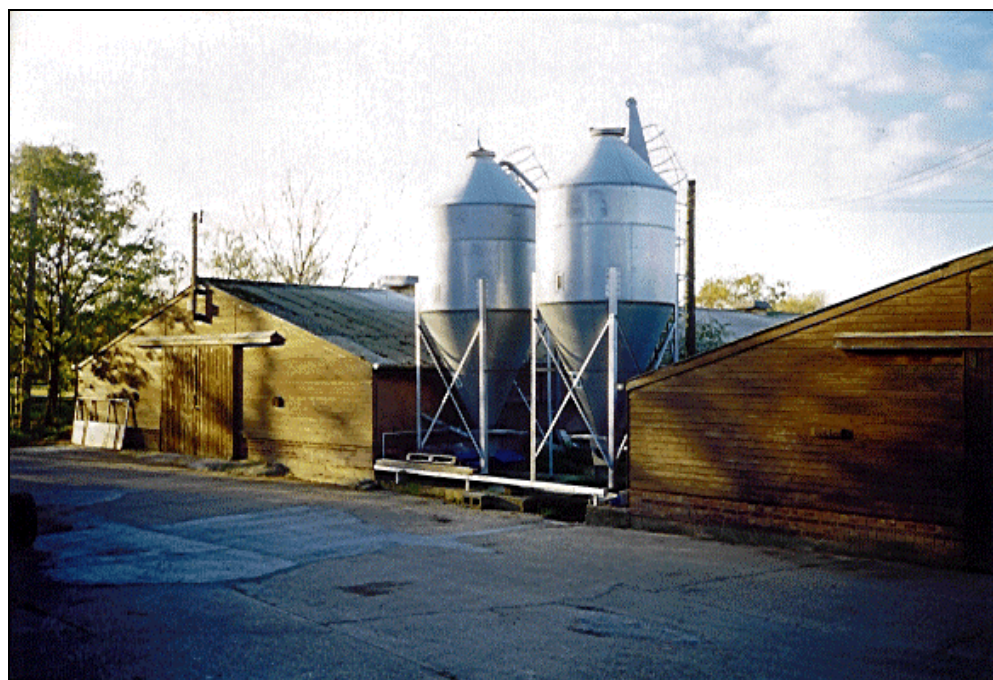

Figure 2.32: Example of silos built close to the broiler houses (UK)

Silos are usually a single construction, but (Italian) designs are on the market that can be transported in parts and assembled in the farmyard. Silos are usually equipped with a manhole for internal inspection and a device for air venting or relieving overpressure during filling. Equipment is also applied for aeration and stirring of the contents (especially soya) and to allow smooth transport of the feed out of the silo.

## 2.5 Collection and storage of manure

Manure is an organic material, which supplies organic matter to soil, together with plant nutrients (in relatively small concentrations compared to the mineral fertilisers). It is collected and stored either as liquid *slurry* or as a *solid manure*. Manure from intensive livestock is not necessarily stored on-farm and particular care is taken in broiler units, because of the risk of spreading disease.

*Slurry* consists of excreta produced by livestock in a yard or a building mixed with rainwater and wash water and, in some cases, with waste bedding and feed. Slurry may be pumped or discharged by gravity.

*Solid manure* includes farmyard manure (FYM) and consists of material from covered straw yards, excreta with a lot of straw in it, or solids from a mechanical slurry separator. Most poultry systems produce solid manure, which can generally be stacked. Pig manure is often handled as slurry.

Slurry can be stored for long periods of time in a storage facility under the animal house, but in general inside storage is temporary and manure is regularly removed to an outside storage facility in the farmyard for further processing. Storage facilities usually have a minimum capacity to guarantee sufficient storage until further manure handling is possible or allowed (Table 2.9). For slurry storage in particular, the required capacity has to allow for minimum freeboard and for rainfall, depending on the type of slurry storage applied. The capacity depends on the climate in relation with the periods in which the application to land is not possible or not allowed in relation with the size of the farm (animal numbers) and the amount of slurry produced and is expressed in months rather than in m<sup>3</sup>. A commonly used storage period is 6 months and large slurry tanks can easily contain 2000 m<sup>3</sup> or more.

EU Member State	External manure storage capacity <sup>1)</sup> (months)	Climate
Belgium	4 – 6	Atlantic/Continental
Luxembourg	5	Atlantic/Continental
Denmark	6 – 9	Atlantic
Finland	12 (except for deep litter)	Boreal
France	3, 4 and (Brittany) 6	Atlantic
Germany	6	Continental
Austria	4	Continental
Greece	4	Mediterranean
Ireland	6	Atlantic
Italy	3 (solid manure) 5 (slurry)	Mediterranean
Portugal	3 – 4	Mediterranean
Spain	3 or more	Mediterranean
Sweden	8 – 10	Boreal
the Netherlands	6 (pig slurry) length of cycle indoors for poultry	Atlantic
UK	4 – 6	Atlantic

*1) deep litter of loose-housed poultry systems is considered as storage space*

**Table 2.9: Times of storage of poultry and pig manure in a number of MSs [191, EC, 1999]**

Manure can have a relatively high dm-content (dried poultry manure and litter-based manure) or can be a mixture of manure, urine and cleaning water called slurry. Facilities for the storage of manures are normally designed and operated in such a way that the substances they contain cannot escape.

The design and the material to be used often have to be chosen in accordance with specifications and technical requirements laid down in guidance notes or in national or regional regulations (e.g. Germany, UK, Belgium). The regulations are often based on water regulations and their objective is to prevent any contamination of ground- or surface water. They also include provisions for maintenance and inspection and procedures to follow in case of an escape of liquid manure which could pose a risk of damage to water resources.

Spatial planning of manure storage on-farm is regulated for protection of water sources and to protect sensitive objects in the vicinity of the farm against odour. Regulations prescribe minimum distances, depending on the number of animals and on site-specific features, such as prevailing wind direction and the type of neighbouring objects.

The following types of manure storage systems are commonly applied:

- storage for solid and litter-based manure
- slurry tanks
- earth-banked stores or lagoons.

### 2.5.1 Poultry manure

Most *solid manure* is produced in buildings and may be stored in the same building until cleared out after the production cycle, i.e.:

- approximately annually for laying hens in deep pit and deep litter systems
- every 6 weeks or so for broilers (table chickens)
- every 16 to 20 weeks for turkeys, and every 50 days for ducks.

For example, in the Netherlands the majority (89 %) of layer and poults houses have a storage capacity of 1 week, 10 % have a capacity of 1 year and 1 % of up to 3 years (deep pit systems).

Some (laying hen) egg production systems allow for more frequent, almost daily removal of manure. For free range systems, birds have access to the outside environment and some droppings will be deposited in fields.

*Laying hens* produce droppings with typical moisture contents of 80 – 85 %, reducing to around 70 – 75 % with regular daily mucking out. The initial moisture content is likely to be mainly influenced by nutrition, whilst the drying rate is affected by the external climate, house environment, ventilation and the manure handling system. Some systems enable manure to be dried to lower moisture contents in order to reduce ammonia emissions. Some laying hens use a litter-based system similar to broilers. In-house manure collection and storage systems are described in Section 2.2.1.

*Broilers (table chickens)* are typically bedded on wood shavings, sawdust or straw which, when combined with bird droppings, produces a fairly dry (around 60 % dry matter) friable manure, often referred to as poultry litter. Sometimes shredded paper is used as a bedding material. Poultry litter quality is affected by temperature and by ventilation, drinker type and management, feeder type and management, stocking density, nutrition and bird health. Systems are described in Section 2.2.2.

*Turkeys* are typically bedded on wood shavings to about 75 mm depth, which produces a litter of around 60 % dry matter, similar to broiler litter. Systems are described in Section 2.2.3.

*Ducks* are normally bedded on straw applying highest amounts in finishing accommodation. A lot of water is spilled and this results in a litter relatively low in dry matter (around 30 % dry matter). Systems are described in Section 2.2.3.

### 2.5.2 Pig manure

*Slurry* may be stored beneath fully-slatted or partly-slatted floors of livestock buildings. The storage period can be quite short but may extend to several weeks, depending on design. In-house manure collection and storage systems are described in Section 2.3. Where further storage is required, slurry is usually sluiced by gravity or pumped to collection pits and/or directly to slurry stores. In some cases a slurry tanker is used.

Where significant quantities of straw are used for bedding, *solid manure* is created which may be removed from buildings regularly (every 1, 2 or 3 days) or (in deep-strawed buildings) after

batches of pigs are moved every few weeks. Solid manure and FYM are typically stored in concrete yards or on field sites ready for spreading to land.

Many pig farms produce both *slurry* and *solid manure*. There is a tendency to collect the excreta and urine separately to reduce ammonia emissions from housing (see Chapter 4). They may be mixed again in storage if further treatment of the slurry and/or the solid manure is not required [201, Portugal, 2001].

### 2.5.3 Storage systems for solid and litter based manure (FYM)

Solid and litter-based manures are normally transported by frontloader or (chain) belt systems and stored on an impermeable concrete floor in the open or in closed barns. The store can be equipped with side walls to prevent slurry or rainwater leaking away. These constructions are often attached to an effluent tank to store the liquid fraction separately. The tank may be emptied regularly or the contents may be moved to a slurry store. Double storey constructions are also applied that allow the liquid fraction of manure and rainwater to drain into a basin underneath the manure storage area (Figure 2.33).



**Figure 2.33: Storage of littered manure with separate containment of the liquid fraction (Italy)**

Temporary field heaps are created prior to field application. They may remain in place for a few days or up to several months and should be sited where there is no risk of run-off entering watercourses or groundwater.

Only one Member State (*Finland: General Agricultural Environment Protection Scheme under their Agri-Environment Programme to which about 90 % of farmers belong*) currently requires farmers to provide a cover for such heaps.

## 2.5.4 Storage systems for slurry

### 2.5.4.1 Slurry storage in tanks

Slurries are pumped from the slurry pit or slurry channel inside the housing to an external slurry storage. Slurry is transported via a pipeline or by means of a slurry tank, and can be stored in slurry tanks above or below ground.

Slurry storage systems consist of collection and transfer facilities. Collection facilities are structural-technical facilities (channels, drains, pits, pipes, slide gates) for the collection and piping of liquid manure, slurry and other effluents, including the pumping station. Valves and sliding gates are important devices to control (back)flow. Although single valve designs are still common, double valve (sliding gate) designs are recommended for safety reasons.

The structural-technical facilities intended for homogenisation and transfer of liquid manure and slurry are called transfer facilities.

***Below-ground tanks and reception pits*** are often used to store small amounts of slurry and can act as reception pits to collect slurry before it is pumped to a larger slurry store. They are usually square constructions built from rendered reinforced blocks, reinforced concrete made on site, ready-made concrete panels, steel panels or glass fibre-reinforced plastic (GRP). With blocks or bricks, extra attention is paid to the impermeability by applying elastic coating or lining. Occasionally, larger stores are constructed with reinforced concrete or block-work, or concrete panels; they may be above ground or partly below ground, and are often rectangular in shape. Below-ground tanks made of reinforced concrete elements with capacities up to 3000 m<sup>3</sup> are the most common storage for slurry in cold regions like Finland [188, Finland, 2001].

***Aboveground circular stores*** are normally made from curved steel panels or concrete sections. Steel panels are coated to protect them against corrosion, usually by coating them with paint or a ceramic layer. Some concrete panel stores may be partly below ground. Normally all stores are built on a properly designed reinforced concrete base. In all tank designs, the thickness of the base plate and the suitability of the seal at the joint of the wall and the tank base are very important features to prevent slurry from leaking away. A typical system has a reception pit with a grid cover next to the main store. A pump is used to transfer slurry to the main store; the pump can be fitted with an extra outlet to allow slurry mixing in the reception pit. Aboveground slurry tanks are filled via a pipe with an opening above or below the slurry surface. Prior to discharge or filling, liquid manure is normally thoroughly mixed with hydraulic or pneumatic stirring systems to agitate sediment and floating matter and to obtain even distribution of the nutrients. Slurry mixing can be carried out using propellers, either mounted through the side of the store or suspended from a gantry over the top of the store. Stirring can cause sudden releases of large quantities of noxious gases and proper ventilation is required, particularly if done in housing.

The main store may have a valve outlet to allow emptying back to the reception pit, or alternatively it can be emptied using a pump located in the store (Figure 2.34).

Slurry tanks can be open or may be covered with a natural or artificial layer of floating matter (such as granulated materials, straw chaff or floating membrane) or with a firm cover (such as a canvas or concrete roof) to keep rainwater out and to reduce emissions.

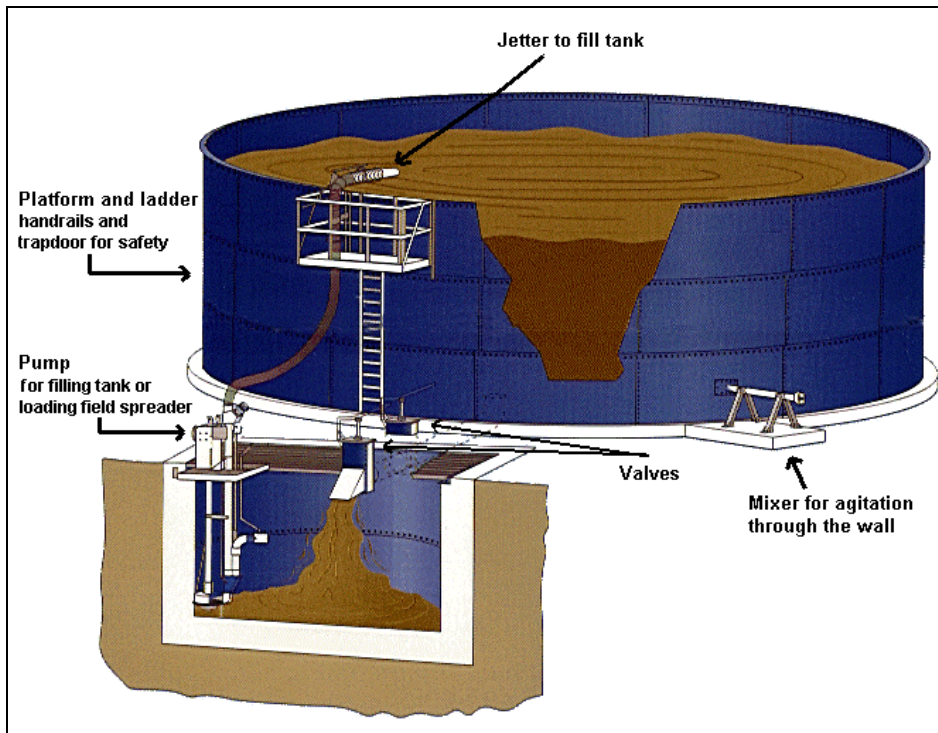

Figure 2.34: Example of aboveground slurry tank with belowground receiving pit [166, Tank manufacturer, 2000]

### 2.5.4.2 Slurry storage in earth-banked stores or lagoons

Earth-banked walls or lagoons are commonly applied in many MSs to store slurry for extended periods of time. Their design varies from simple ponds without any provisions to relatively well monitored storage facilities with thick plastic sheets (e.g. polythene or butyl rubber) on the bottom, protecting the soil underneath. The capacity of a lagoon depends on the slurry production of the enterprise and the operational requirements. There are no specific measures characterising a typical lagoon when it is constructed only for storage purposes [201, Portugal, 2001]. Slurry can be mixed using pumps or propellers.

The soil used to construct an earth-banked store must have special properties to ensure stability and low permeability, which usually means a high clay content. These stores are built below, above or partly-below/partly-above ground level. Earth-banked stores also include a minimum allowance for freeboard (Figure 2.35).

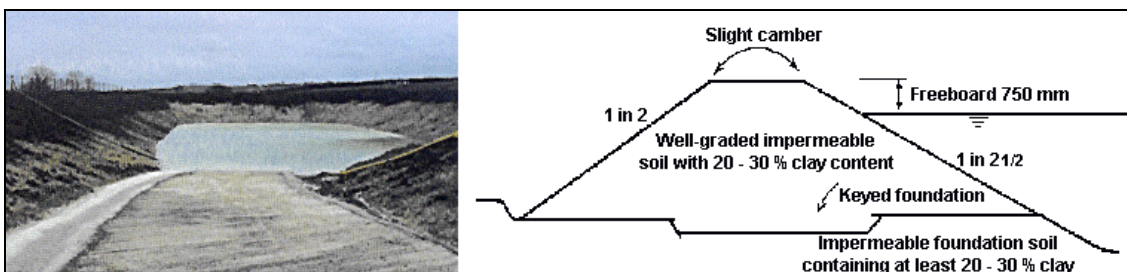

Figure 2.35: Example of earth-banked slurry store and design features [141, ADAS, 2000]

Slurry is transported by pipelines or with a vacuum tank and for this earth-banked stores can be equipped with an access ramp. The earth-banked store is often fenced off to prevent accidents.

On some farms (e.g. in Italy and Portugal) a multiple earth-banked store or lagoon system is used. In Portugal, these systems are normally designed and operated to comply with treatment requirements. Nevertheless, as the slurries have to remain in these systems for a considerable period of time, the lagoons can also serve as storage [201, Portugal, 2001]. In each store slurry is held for a certain period of time for aerobic or anaerobic degradation. Finally, slurry is removed from the last slurry store for further processing. Transport between the different stores can be mechanically or by gravity, using the natural height differences of the site.

#### 2.5.4.3 Slurry storage in flexible bags

For the short-term storage of relatively small amounts of slurry, flexible bags are used. They may be moved from site to site (when empty). Larger bags may be sited more permanently in earthworks to provide longer-term storage. Such stores are filled and emptied by pump and the larger stores can be provided with mixer units.

## 2.6 On-farm manure processing

[17, ETSU, 1998], [125, Finland, 2001], [144, UK, 2000]

A number of manure treatment systems are applied, although the majority of farms in the EU are able to manage manure without recourse to the techniques listed below. Some treatments are carried out in combination. Other novel processes may still be subject to research and development or are used on only a very few farms. In some areas manure treatment is centrally organised and manure is collected from a number of farms for treatment in a communal treatment facility.

Manure treatment prior to or instead of landspreading may be performed for the following reasons:

1. to recover the residual energy (biogas) in the manure
2. to reduce odour emissions during storage and/or landspreading
3. to decrease the nitrogen content of the manure to prevent groundwater and surface water pollution as a result of landspreading and to reduce odour
4. to allow easy and safe transportation to distant regions or to other sites for application in other processes.

The latter two systems are implemented in regions with a nutrient surplus.

**1. Using the energy value of manure:** Organic compounds are converted to methane by the anaerobic biological digestion of manure. Methane can be recovered and used as a fuel at the farm or in the neighbourhood

**2. Reduce odour emissions during storage and/or landspreading:** Manure may give rise to odour nuisance during or after storage. This can in some instances be reduced by aerobic or anaerobic treatment or by additives. [174, Belgium, 2001]

**3. Reduction of nitrogen content of manure:** Nitrogen compounds in manure (organic, ammonium, nitrites and nitrates) can be converted to the environmentally neutral nitrogen gas (N<sub>2</sub>). Techniques to reduce nitrogen content of manure are:

- incineration: oxidises nitrogen compounds to nitrogen gas
- biological denitrification: bacteria convert organic and ammonium nitrogen to nitrates and nitrites (nitrification) and further still to nitrogen gas (denitrification)
- chemical oxidation: supplementing manure with oxidising chemicals and increasing the temperature and pressure also results in the oxidation of nitrogen compounds

**4. Processing of manure for marketing of manure compounds and/or easy and safe transportation:** The water content and volume of the manure are reduced. In addition, pathogenic micro-organisms present in the manure can be inactivated (this prevents spreading of livestock pathogens to other regions), and odour emission is reduced. Sometimes different manure compounds are separated for market reasons. The following techniques are often used:

- filtration: separation of solid (most of the P) and liquid (most of the N) fractions
- ammonia stripping: after pH adjustment,  $\text{NH}_3$  is stripped from the manure fluid and captured
- membrane filtration: after pre-filtration, reverse osmosis is used to separate nitrogen and phosphorus salts from water
- chemical precipitation: addition of  $\text{MgO}$  and  $\text{H}_3\text{PO}_4$  results in the precipitation of magnesium ammonium phosphate
- evaporation: liquid manure is heated or depressurised, vapours are condensed and further treated
- drying: solid manure is dried by ambient air or animal body heat (see also Section 4.5), by burning fossil fuels or by burning biogas from manure fermentation
- lime treatment: increasing the pH results in the separation of  $\text{NH}_3$ , an increase in temperature and a volume reduction
- composting: the volume of the solid pig manure fraction or poultry manure is reduced and many pathogens are inactivated by biological degradation of organic material. (Compost of poultry litter is, for example, used in the mushroom industry in Ireland)
- pelletising: dried manure may be converted to fertiliser pellets.

In the following sections some of the treatment techniques are discussed in more detail.

### 2.6.1 Mechanical separators

Mechanical separation is used on some pig farms to convert raw slurry into separated fibre/solids (ca. 10 % by volume) and a separated liquid (ca. 90 % by volume). A wedge wire run-down screen or vibrating screen produces solids of about 8 – 10 % dry matter. Separators, which press and squeeze slurry against a fabric belt or perforated stainless steel screen, produce solids ranging from 18 – 30 % dry matter. Other techniques are sedimentation, centrifugation or membranes. Occasionally, separation is enhanced by the use of chemical flocculants. Generally, the liquids produced by mechanical separation are more easily managed during storage and handling than raw slurry. (Separation is practised in many countries, but especially in Italy where, in some regions, there is a requirement to separate pig slurry).

Composting can be applied afterwards to enhance the value of the solid product. Aerobic treatment can be applied to further reduce nitrogen surplus in the remaining liquid fraction or this fraction is applied to land without further treatment.

### 2.6.2 Aerobic treatment of liquid manure

On some pig farms, aerobic treatment is used to reduce odour emissions from pig slurry and, in some cases, to reduce its nitrogen content. Liquid manure is composted by means of aeration (liquid composting) or by mixing it with an adequate amount of litter. The mixture can then be composted in a stack or drum. In aeration, aerobic treatment is used to improve the properties of liquid manure without drying and solidifying the manure. Manure contains large quantities of nutrients for plants and micro-organisms, as well as microbes that are capable of utilising these nutrients. The air conducted into liquid manure starts aerobic decomposition, which produces heat, and as a result of the aeration bacteria and fungi which use oxygen in their metabolism multiply. The main products from the activity of micro-organisms are carbon dioxide, water and heat.



Designs are site-specific and take into account loading rate and the time treated slurry needs to be stored before being applied to land. Such systems may include the use of mechanical separators. (France, particularly Brittany, has some treatment plants for reducing N and P, while many countries have a few examples of aerobic treatment for reducing odour e.g. Germany, Italy, Portugal and the UK). Aeration is also applied to prepare slurry for it to be used to flush gutters, tubes or canals under slatted floors.

### 2.6.3 Aerobic treatment of solid manure (composting)

Composting of solid manure is a form of aerobic treatment which can occur naturally in farmyard manure heaps. High porosity (30 – 50 %) is required for sufficient aeration. Temperatures in the compost heap are between 50 and 70 °C and kill most of the pathogens. Compost with a dry matter of up to 85 % can be produced.

Suitability for application depends on the structure of the manure, but requires a minimum dry matter content of 20 %. Typical FYM heaps do not satisfy the requirements for thorough composting. With controlled application, manure is composted in stacks of a size that suits the aerobic conditions and the use of machinery. Best results are obtained by using well-chopped straw and solid manure in the right proportions and by controlling temperature and moisture content in long narrow 'windrows'. Composting can also be performed in a barn (e.g. pre-dried poultry manure). Specific systems have been developed that consist of a combination of tanks with aeration and stirring equipment to enhance the fermentation process and containers or boxes for further fermentation and drying.

Properly composted solid manure significantly reduces the volume of material spread to land and the amount of odour released. For easier handling, pelletising is applied in addition to composting.

### 2.6.4 Anaerobic treatment

Anaerobic digestion is used on some pig farms to reduce odour emissions from slurry. The process is carried out in a biogas reactor in the absence of oxygen. Processes can vary with temperature, process management, operating time and substrate mixing. In practice, the mesophilic process (at 33 – 45 °C) is most common. The thermophilic process is applied in large reactors.

The final products of digestion are biogas (approximately 50 – 75 % methane and 30 – 40 % carbon dioxide) and a stabilised treated slurry. The biogas can be used for heating, or for generating electricity. Application may include the use of mechanical separators, usually after digestion.

### 2.6.5 Anaerobic lagoons

This treatment is applied for pig slurry in warmer climates (e.g. Greece and Portugal). In Greece all pig slurry must be treated to comply with certain legal conditions, whereas in Portugal legal conditions only apply to discharges to watercourses). The treatment system may involve mechanical separation of the solids and subsequent separate treatment of solids and liquids. The liquid is put in a settling basin or lagoon, and overflows or is pumped into the anaerobic lagoon system (often 3 to 5 earth-banked structures). The lagoons serve as a storage for waste water as well as for the biological treatment. Designs are site-specific: for example, in Italy, covers are used to collect biogas.

### 2.6.6 Pig manure additives

[196, Spain, 2002]

Under the generic denomination of manure additives are a group of products made up of different compounds that interact with the manure, changing its characteristics and properties. These products are applied to the pig manure in the pits, and the following effects are described to different degrees in the label of every product:

1. a reduction in the emission of several gaseous compounds (NH<sub>3</sub> and H<sub>2</sub>S)
2. a reduction of unpleasant odours
3. a change in the physical properties of the manure to make easier its use
4. an increase in the fertilising value of the manure
5. a stabilisation of pathogen micro-organisms.

Usually, the items 2 and 3 are the main reasons for their use at a farm level. Below the techniques 1 – 5 are detailed.

**1. additives for reducing the emission of several gaseous compounds:** The decrease in gaseous emissions achieved through its use (mainly NH<sub>3</sub> and H<sub>2</sub>S) is one of the most interesting yet controversial points. Its has been well documented that up to 90 % of the N produced by the pigs is as urea. When the urease produced by faecal micro-organisms comes into contact with urea, the following reaction occurs:

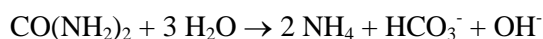

This reaction is highly influenced by temperature and pH, for example, under 10 °C or at a pH below 6.5 the reaction stops.

**2. additives for reducing unpleasant odours:** Odour results from the mix of different compounds under anaerobic conditions. More than 200 substances involved have been identified, such as:

- volatile fatty acids
- alcohols (indol, skatole, p-cresol, etc)
- H<sub>2</sub>S and derivatives
- ammonia
- other N compounds (amines and mercaptans).

There is a huge variation in the proportion and concentration of every substance depending on the type of farm, nutrition and nutritional management, and climatic conditions. This could explain why in many instances the effectiveness of these compounds against odours could not be proven under farm conditions.

**3. additives for changing the physical properties of the manure:** The objective of the additive is to make the manure easier to handle. These additives are probably the most used and their effects are well known. Their use results in an increase in manure flowing, an elimination of superficial crusts, a reduction of solved and suspended solids and a reduction in the stratification of the manure. However, these effects were not demonstrated in every comparable case.

Their application might make the cleaning of the manure pits easier, and thereby might shorten the cleaning time required and allow a saving in water and energy consumption. Moreover, since the manure is more homogeneous, it eases the manure's agricultural use (better dosing).

**4. additives for increasing the fertilising value of the manure:** This effect is in fact derived from the reduction in NH<sub>3</sub> emissions, thereby keeping this N retained in the manure (in many cases through the increased synthesis of the microbial cells, giving higher levels of organic N).

**5. additives for stabilising pathogens micro-organisms:** There are many different micro-organisms in manure, part of these contribute to the gaseous emissions and odours. It is also possible to find faecal coliforms and Salmonella and other pig pathogens, virus, eggs of flies and nematoda in the manure.

Usually, the longer the storage period the higher the decrease in pathogens, because of the different requirements of temperature and pH. The pH decreases within the first month of storage (from 7.5 to 6.5 because the microbial synthesis of volatile fatty acids) which has a negative effect on pathogens survival. Some of the manure additives have been designed to control them, especially the eggs of flies.

### *Types of manure additives*

- **masking and neutralising agents:** These are a mix of aromatic compounds (heliotropin, vanillin) that work by masking the manure odour. The agent is easily destroyed by manure micro-organisms. Its actual efficacy is questionable.
- **adsorbers:** There are a large number of substances that have demonstrated an ability to adsorb ammonia. Some types of zeolites called clinoptilolites have shown the best effect, being added either to the manure or to feed on ammonia emission. They are also able to improve soil structure and have the added benefit that they are not toxic or hazardous. Peat gives similar results and is also sometimes used.
- **urease inhibitors:** These compounds stop the reaction described earlier preventing urea from being transformed into ammonia. There are three main types of urease inhibitor:
  1. phosphoramides: applied directly to the soil. Show a good effect. They work better in acid soils, but could affect soil micro-organisms
  2. yucca extracts (Y. schidigera): many trials have been done to assess its potential but the available information is controversial, showing good results in some cases, but no effect at all in other cases
  3. straw: considered as an adsorbant in many references. However besides the absorbing effect, it also increases the C:N ratio. Its use is controversial because in many other works it shows an increase in ammonia emissions.
- **pH regulators:** there are two main types:
  1. acid regulators: usually inorganic acids (phosphoric, hydrochloric, sulphuric). In general they show good effects but their costs are very high and the substances themselves are dangerous. Their use is not recommended at farm level
  2. Ca and Mg salts: these salts interact with manure carbonate, decreasing the pH. They could increase the fertilising value of the manure but could also increase the salinity of the soil (chlorides). They are used sometimes, but mainly in combination with other additives.
- **oxidising agents:** Their effects are through:
  - oxidation of the odour compounds
  - providing oxygen to aerobic bacteria
  - inactivating the anaerobic bacteria that generate odorous compounds.

The most active are strong oxidising agents such as hydrogen peroxide, potassium permanganate or sodium hypochloride. They are hazardous and not recommended for farm use. Some of them (formaldehyde) could be carcinogens. Ozone application has demonstrated its efficacy but operational costs are very high.

- **flocculants:** are mineral compounds (ferric or ferrous chloride and others) or organic polymers. Phosphorus is highly decreased but their use generates waste that is difficult to manage
- **disinfectants and antimicrobials:** chemical compounds that inhibit the activity of the micro-organisms involved in odour generation. They are expensive to use and with sustained use an increase in dosing is needed
- **biological agents:** these can be divided into:
  1. enzymes: their use is to liquefy solids. They are not hazardous. The actual effect depends strongly on the type of enzyme, the substrate and a proper mixing
  2. bacteria:
    - exogenous strains: they have to compete with natural strains which makes getting good results more difficult. Their use is better in anaerobic pits or lagoons to reduce the organic matter producing CH<sub>4</sub> (sowing of methanogens bacteria is more efficient and sensitive to pH and temperature). High efficacy but frequent re-sowing has to be carried out
    - promote natural strains: this is based on adding carbonate substrates (increased C:N ratio). Its effect is based on the use of ammonia as a nutrient, but they need a sufficient source of C to develop an efficient synthesis process, changing ammonia on the organic N of cell tissue. Re-sowing has to be carried out too, to avoid reverting to the starting point. They are not hazardous and no significant cross-media effects have been reported.

**Overall efficacy of manure additives and farm use:** Nowadays there are many manure additives in the market, but the efficacy has not been demonstrated in every case. One of the main problems is the lack of standard techniques to test and analyse the results. Another problem with their use is that many trials have only been developed under experimental conditions in laboratories and not on-farm, where big variations in nutrition, the management of nutrition, pH and temperature can be found. Besides this, there is also sometimes a huge volume of manure to be mixed with the additive in a pit or lagoon, and the results achieved often depend a lot more on the mixing efficiency than on the lack of efficacy of the additive. Improving the flow characteristics seems to be strongly related with a good mixing.

The efficacy of every compound is highly dependent on the correct dosing, right timing and a good mixing. In some cases a small effect has been observed of an increase in the fertilising value, but this effect is related to the type of crop, the time of application and dosing.

It has to be highlighted that in many cases the effects on human or animal health or other environmental effects by using additives are not known and this, of course, limits their applicability.

### 2.6.7 Impregnation with peat

Liquid manure can be converted into solid manure by mixing it with peat. There are mixers for this purpose, which makes this method quite usable in practice. Straw or sawdust can also be used as litter material, but Finnish work has shown that peat absorbs water and ammonia more efficiently, and also prevents the growth of harmful microbes. This method has been recommended especially on farms in Finland, where the storage capacity of the liquid manure tank is not adequate to accommodate all the liquid manure produced but where building a new tank is not considered profitable. Peat manure is good soil improvement material for soil that is poor in humus. Liquid manure mixed with peat produces fewer odours than liquid manure alone, here the carefully mixed liquid manure is pumped into a machine which mixes liquid manure with peat into litter manure.

## 2.7 Manure application techniques

A range of equipment and techniques are used to spread slurry and solid manure to land. These are described in the following sections. Currently much of the slurry is applied to land using machinery which broadcasts the material across the width of spread by throwing it into the air. In some countries (e.g. the Netherlands) the use of band spreaders and injectors for slurry is required to reduce emissions. Solid manures are broadcast after being chopped or shredded into smaller pieces. Sometimes manure is incorporated into soil by ploughing, discing or using other suitable cultivation equipment. Contractors are often used for manure spreading and manure is not always spread on the producer's own land.

Nitrate from agricultural land is the main source of nitrate in rivers and aquifers in Western Europe. High levels of nitrate in certain waters have given rise to environmental and health concerns which are reflected in the EC Nitrate Directive (91/676/EEC), which is aimed at reducing nitrate pollution from agriculture. MSs are required to designate Nitrate Vulnerable Zones and draw measures under an 'Action Programme'. The measures include nitrogen limits for organic manures, closed periods when some manures (high in available N) cannot be spread to grassland and arable land (on sandy and shallow soils), and the identification of other situations when manures should not be applied. In Ireland P-load is used as a limiting factor as well.

Many countries have other legislation governing the landspreading of manures to try and balance the amounts applied with the nutrient requirements of the crop (e.g. the Netherlands - Minerals Accounting System, Denmark - compulsory annual fertiliser plans; and Ireland - nutrient management plans required under Integrated Pollution Control licensing for pig and poultry units). In some cases this is for specific regions but variations can occur (Belgium, Germany and Italy). In many countries manure spreading is not allowed during certain periods in the autumn and winter seasons. Some countries (e.g. Italy, Portugal and Finland) have specific limits on livestock densities expressed in livestock units per hectare.

Landspreading is further regulated by limiting it to certain periods of the year or to maximising it in other periods, e.g. manure application is usually at its maximum in the autumn period after harvesting. In some cases landspreading in spring can be advisable.

In other countries and areas where landspreading is not controlled by specific legislation, reliance is placed on advice, often in published guidelines such as 'Codes of Good Practice' (the UK).

If properly applied, landspreading of manure has benefits in terms of saving mineral fertiliser, improving arid soil conditions as a consequence of the addition of organic matter, and in reducing soil erosion. It is complex to control and regulate manure application, as on many occasions the farmer who has an intensive livestock enterprise may not own the receiving land. However, landspreading is environmentally important because of its potential for odour and ammonia emission during spreading and for emissions of nitrogen and phosphate to soil, groundwater and surface water. Energy consumption of the spreading equipment could also be considered. Application techniques and equipment, which are detailed in the following sections, vary depending on:

- type of manure (slurry or dry manure)
- land use
- structure of the soil.

## 2.7.1 Slurry transport systems

There are four main types of slurry transport systems used in Europe and that can be used in combination with different slurry distribution systems. The features of these transport systems are set out in Table 2.10 and listed below:

### 2.7.1.1 Vacuum tanker

- the slurry is sucked into the tanker by using an air pump to evacuate the air from the tank to create a vacuum; the tanker is emptied using the air pump to pressurise the tanker, thereby forcing the slurry out
- can be used for most slurry transport jobs; versatile applicability.

### 2.7.1.2 Pumped tanker

- the slurry is pumped into and from the tanker using a slurry pump, either a centrifugal (e.g. impeller type) or positive displacement pump (PD pump), such as lobe type pump
- generally have better spreading precision (m<sup>3</sup> or tonnes/ha) than vacuum tankers
- PD pumps require more maintenance.

### 2.7.1.3 Umbilical hose

- the slurry is fed by a drag hose to the distribution system, fitted to the tractor; the hose is supplied with slurry usually directly from the slurry store by a centrifugal or positive displacement pump
- possible crop damage as hose drags across the ground; hose damage and wear can be a problem on abrasive or flinty ground
- tends to be used where high application rates are applicable and on wetter soils where heavier machinery would mark land (with increased potential for run-off).

### 2.7.1.4 Irrigator

- this is a self-propelled machine with flexible or reeled-in hoses usually fed from a network of underground pipes, with a centrifugal or positive displacement pump, situated near the slurry store
- suitable for semi-automatic operation, but anti-pollution safeguards needed (e.g. pressure and flow switches)
- irrigators tend to be associated with high application rates.

Features	Transport system			
	Vacuum tanker	Pumped tanker	Umbilical hose	Irrigator
Range of dry matter	Up to 12 %	Up to 12 %	Up to 8 %	Up to 3 %
Requires separation or chopping	No	No (centrifugal) Yes (PD pump)	No (centrifugal) Yes (PD pump)	Yes
Work rate	→ → →	→ →	→ →	→ → (depends on field size/shape)
Accuracy of application rate	✓	✓✓ (centrifugal) ✓✓✓ (PD pump)	✓✓ (centrifugal) ✓✓✓ (PD pump)	✓✓
Soil compaction	▼▼▼	▼▼▼	▼▼	▼
Capital costs	€	€(centrifugal) €€(PD pump)	€€€	€€
Labour requirement per m <sup>3</sup>	♣♣♣	♣♣♣	♣♣	♣

*Number of arrows, ticks etc. indicates input level or value, e.g. irrigator requires low labour input*

**Table 2.10: Qualitative comparison of characteristics of four slurry-transport systems**  
[51, MAFF, 1999]

## 2.7.2 Slurry application systems

### 2.7.2.1 Broadcast spreader

A distribution system is used to bring the slurry onto the land. A widespread technique to landspread manure is the combination of a tractor with a tank with a spreading device at the rear. The broadcast spreader can be considered as a reference system (Figure 2.36). The untreated slurry is forced under pressure through a discharge nozzle, often onto an inclined splash plate to increase the sideways spread.



**Figure 2.36: Example of a broadcast spreader with a splash plate**  
[51, MAFF, 1999]

Figure 2.37 shows a hose-reel irrigator with a ‘raingun’ attached to a moveable trolley, which is also a broadcast spreader. The trolley is pulled out to about 300 metres with its supply pipe and is wound back to the reel (using the supply hose) where it automatically shuts off. Dilute slurry is pumped to the hose-reel from the slurry lagoon via a main pipe – often buried underground and with valved outlets in a number of places in the field. The applicator in this picture is the ‘raingun’ that operates at a high connection pressure. [220, UK, 2002]



**Figure 2.37: Example of a raingun**  
[220, UK, 2002]

Broadcasting can also be operated with a low trajectory and at a low pressure to produce large droplets, to avoid atomisation and wind drift. Figure 2.38 shows a tractor applying dilute pig slurry (in April) through a boom with 2 splash plates in a crop of winter wheat. The slurry is supplied to the tractor/boom using an umbilical hose from the slurry lagoon. It is possible to apply slurry to winter wheat crops at later dates than April. In Suffolk, England, pig slurry is often very dilute and will run-off the crop onto the soil; therefore leaf scorch is not an issue.



**Figure 2.38: Example of a broadcast technique with low trajectory and low pressure**  
[220, UK, 2002]

Figure 2.39 shows the same type of boom applicator with 2 splash plates, but this time on the back of a tractor and tanker combination, applying slurry to winter wheat in Hampshire, England. Slurry is supplied from the tanker and is spread, again, with a low trajectory and at low pressure.





**Figure 2.39: Example of a broadcast technique with low trajectory and low pressure**  
[220, UK, 2002]

### 2.7.2.2 Band spreader

Band spreaders discharge slurry just above ground level in strips or bands through a series of hanging or trailing pipes attached to a boom. The band spreader is fed with slurry from a single pipe, it thus relies on the pressure at each of the hose outlets to provide an even distribution. Advanced systems use rotary distributors to proportion the slurry evenly to each outlet. The width is typically 12 m with about 30 cm between bands.

The technique is applicable to grass and arable land, e.g. for applying slurry between rows of growing crops. Because of the width of the machine, the technique is not suitable for small, irregularly shaped fields or steeply sloping land. The hoses may also become clogged if the straw content of the slurry is too high.



**Figure 2.40: Example of a band spreader fitted with rotary distributor to improve lateral distribution**  
[51, MAFF, 1999]

### 2.7.2.3 Trailing shoe spreader

This is a similar configuration to the band spreader with a shoe added to each hose allowing the slurry to be deposited under the crop canopy onto the soil. This technique is mainly applicable to grassland. Grass leaves and stems are parted by trailing a narrow shoe or foot over the soil surface and slurry is placed in narrow bands on the soil surface at 20 – 30 cm spacings. The slurry bands should be covered by the grass canopy so the grass height should be a minimum of 8 cm. The machines are available in a range of widths up to 7 – 8 m. Applicability is limited by size, shape and slope of the field and by the presence of stones on the soil surface.



**Figure 2.41: Example of a trailing shoe spreader**  
[51, MAFF, 1999]

#### 2.7.2.4 Injector (open slot)

Slurry is injected under the soil surface. There are various types of injector but each fits into one of two categories; either open slot shallow injection, up to 50 mm deep; or deep injection over 150 mm deep.

This technique is mainly for use on grassland. Different shaped knives or disc coulters are used to cut vertical slots in the soil up to 5 – 6 cm deep into which slurry is placed. The spacing between the slots is typically 20 – 40 cm, with a working width of 6 m. The application rate must be adjusted so that excessive amounts of slurry do not spill out of the open slots onto the soil surface. The technique is not applicable on very stony soil nor on very shallow or compacted soils, where it is impossible to achieve uniform penetration of the knives or disc coulters to the required working depth.



**Figure 2.42: Example of an open-slot shallow injector**  
[51, MAFF, 1999]

#### 2.7.2.5 Injector (closed slot)

This technique can be shallow (5 – 10 cm depth) or deep (15 – 20 cm). Slurry is fully covered after injection by closing the slots with press wheels or rollers fitted behind the injection tines. Shallow closed-slot injection is more efficient than open-slot for decreasing the ammonia emission. To obtain this added benefit, soil type and conditions must allow effective closure of the slot. The technique is, therefore, less widely applicable than open-slot injection.

Deep injectors usually comprise a series of tines fitted with lateral wings or 'goose feet' to aid lateral dispersion of slurry in the soil so that relatively high application rates can be achieved. Tine spacing is typically 25 – 50 cm, with a working width of 2 – 3 m. Although ammonia abatement efficiency is high, the applicability of the technique is severely limited. The use of deep injection is restricted mainly to arable land because mechanical damage may decrease herbage yields on grassland. Other limitations include soil depth and the clay and stone content, the slope and a high draught force requiring a large tractor. Also in some circumstances there is a greater risk of nitrogen losses as nitrous oxide and nitrates.

### 2.7.2.6 Incorporation

Incorporation may be achieved with other equipment such as discs or cultivators depending on soil type and soil conditions. Working the manure spread on the surface into the soil can be an efficient means of decreasing ammonia emissions. The manure must be completely buried under the soil to achieve maximum efficiency. Efficiencies depend on the cultivation machinery; ploughing is mainly applicable to solid manures on arable soils. Where injection techniques are not possible or unavailable, the technique may also be used for slurries.

It is also applicable to grassland when changing to arable land (e.g. in a rotation system) or when reseeded. As ammonia losses take place quickly after spreading the manure on the surface, higher reductions in emissions are achieved when incorporation takes place immediately after spreading. At the same time incorporation will reduce the development of odour in the neighbourhood of the manured land.

To achieve incorporation immediately after spreading, a second tractor is needed for the incorporation machinery, which must follow closely behind the manure spreader. Figure 2.43 shows incorporation equipment combined with a big tanker owned by a contractor, but this combination is also possible with a smaller tanker and separate tractor. In this way the incorporation can be done together with the manure spreading in only one handling. [197, Netherlands, 2002]



**Figure 2.43: Incorporation equipment combined with a big tanker**  
[197, Netherlands, 2002]

### 2.7.3 Solid manure application systems

For spreading solid manure, three main types of solid manure spreaders are commonly used:

- Rotaspreader – a side discharge spreader which features a cylindrical body and a power take-off-driven shaft (PTO-shaft) fitted with flails running along the centre of the cylinder. As the rotor spins, the flails throw the solid manure out to the side.



**Figure 2.44: Example of a rotaspreader**  
[51, MAFF, 1999]

- Rear discharge spreader – a trailer body fitted with a moving floor or other mechanism which delivers solid manure to the rear of the spreader. The spreading mechanism can have either vertical or horizontal beaters, plus in some cases spinning discs.



**Figure 2.45: Example of a rear discharge spreader**  
[51, MAFF, 1999]

- ‘Dual purpose spreader’ – a side discharge spreader with an open top V-shaped body capable of handling both slurry and solid manure. A fast-spinning impeller or rotor, usually at the front of the spreader, throws the material from the side of the machine. The rotor is fed with material by an auger or other mechanism fitted in the base of the spreader and a sliding gate controls the flow rate of the material onto the rotor.



**Figure 2.46: Example of a dual purpose spreader**  
[51, MAFF, 1999]

## 2.8 Transport on-farm

The scale of transport operations on farms depends on farm size, farm layout and the location of fuel stores, feed stores and feed processing, livestock buildings, product processing (for example egg packing and grading), manure storage and fields for applying manures to land.

Feed is usually mechanically or pneumatically handled and on some pig units wet feed is pumped to feeding troughs.

Typically, tractors are used as the prime mover for manure transport and spreading, although on some pig units slurry irrigation using pumps and pipelines is practised, for example in the UK. Many farmers use contractors who typically use larger equipment and occasionally self-propelled vehicles with mounted 'spreader' bodies. Tractor-mounted slurry scrapers or loaders/grabs are used for moving manure around buildings and concrete areas, but in some egg laying systems manure is moved mechanically by belts and conveyors.

Eggs are usually mechanically handled through to packing where forklift trucks assist loading of lorries for road transport. Forklift trucks are used to transfer crates containing birds from broiler housing to road transport vehicles.

General purpose materials handlers (a specialist form of tractor) are used on some sites to undertake a variety of tasks around the farm buildings.

The movement of road transport lorries around the farm site can be extensive on large integrated egg production enterprises dealing with inputs such as birds, feed, fuel, packaging and produce output. Some sites carry out egg grading and packing for other producers.

## 2.9 Maintenance and cleaning

Maintenance and cleaning primarily refers to equipment and housing. Paved areas of the farmyard can also be cleaned by sweeping or by spraying with water.

General building maintenance is necessary, including feed handling systems and other conveying equipment. Ventilation systems are checked for correct operation of fans, temperature controllers, outlets and back-draught shutters and emergency provisions. Drinking water supply equipment will be checked regularly. The provision and maintenance of appropriate conditions for keeping livestock is required to meet welfare legislation and to reduce emissions of odour.

Buildings are usually cleaned and disinfected after batches of livestock and manure have been removed. The frequency of cleaning is therefore equal to the number of production cycles per year. Typically on pig units, wash-down water enters the slurry system, but on poultry units such contaminated water is often collected separately in (below-ground) storage tanks, before being applied to land or treated in some way. Good hygiene practices are required in other building areas where product is handled and packed ready for dispatch.

For cleaning, use is often made of high-pressure washers using only water, but surface active agents are sometimes added. For disinfecting, formaline or other agents are used and they are applied with an atomiser or sprayer. This is applied if, for instance, *Salmonella* has been found in a flock of broilers [125, Finland, 2001].

Regular maintenance (refurbishing and repairs) and cleaning of vehicles, such as tractors and manure spreaders, can also take place. Regular checks should be made during operational periods with appropriate maintenance as described in the manufacturers' instructions. These activities usually involve the use of oil and cleaning agents and can require energy for equipment use.

Many farms have a supply of the faster wearing parts in order to effect repairs and maintenance quickly. Routine maintenance and cleaning is carried out by suitably trained farm staff but more difficult or specialist maintenance work is carried out with specialist assistance help.

### 2.10 Use and disposal of residues

The operation of a pig or poultry unit gives rise to a number of different residues, some of which are identified in the following list:

- pesticides
- veterinary products
- oils and lubricants
- scrap metals
- tyres
- packaging (rigid plastic, film plastic, cardboard, paper, glass, pallets etc.)
- feed residues
- building residues (cement, asbestos and metal).

Processing of manure, carcasses and waste water is subject to special provisions and is dealt with in other sections of this document.

Most of the residues are paper and plastic packaging material. The most common hazardous residues are those from medicines that have been used or are past their expiring date. Small amounts of residues of cleaning material or of chemicals necessary to operate special processes (e.g. air scrubber) may be found on a farm as well.

The way in which residues are dealt with varies widely. Existing European and national legislation on environmental protection and on waste management regulate waste storage and disposal and promote the minimisation of the amount of litter and waste and the use of recyclable materials.

In general, on larger enterprises, residues can be more economically disposed of than on small farms. For collection, the residues are stored in containers or in small bins and collected by municipal or special collection services. Where no public waste collection is organised, farms may be obliged to organise collection and transportation themselves and are responsible for associated costs and treatment (Finland). Collection is difficult to organise or non-existent in remote areas.

A survey on treatment of residues on farms recently carried out in the UK gives the following picture of techniques that are used if the residues are not collected and transported off-farm [146, ADAS, 2000]:

- stockpiling
- burning in the open
- burying
- re-using.

Off-farm disposal includes disposal routes such as:

- landfilling
- storing in dustbin, included in household collection
- collecting by suppliers
- transfer to contractor.

Burning of packing material and used oils is still quite common in some MSs, whereas burning of any kind is strictly forbidden in others. In some MSs, oils are stored in purpose-designed cans/containers and are collected to be treated off-farm. Burning is also the most favoured method of disposal of all kinds of plastic products such as, covers and containers.

Veterinary residues are stored in special boxes and sometimes collected by the veterinary service, although burning and landfill occur as well.

Feed and crop residues can be mixed with farmyard manure or slurry and applied to land, or are re-used in other ways.

Tyres are dealt with in different ways, varying between collection by suppliers, and burning on farm and stockpiling.

## 2.11 Storage and disposal of carcasses

Services to collect carcasses and to process them by contractors are common. In Italy, many farms have equipment to transform carcasses into liquid feed under special pressure and heating conditions [127, Italy, 2001]. Also, in other Member States the processing of carcasses into feed is or has been practised, but this is now declining or completely forbidden.

Burying of carcasses and open burning are still widely practised methods. In some MSs, such as the Netherlands, Germany, Denmark and France burying is strictly forbidden, but in the UK, Italy and Spain authorised burial is allowed. Some farms have an installation for incineration of carcasses. This can be a quite simple burner without provision for the emitted waste gases. In the UK about 3000 small scale incinerators (<50 kg/hr) are operated, mainly on large poultry and pig farms for the incineration of animal carcasses. The ash may be landfilled or disposed of by other routes.

Otherwise carcasses are collected and processed elsewhere. Carcasses can also be composted.

## 2.12 Treatment of waste water

Waste water is the water used by domestic, industrial, agricultural or other usage, and which has undergone changes in its properties as a result and is discharged. Added to this is the water from rainfall, which collects and flows away from built-on or compacted areas (precipitation water).

Cleaning water from livestock farming facilities can contain residues of dung and urine, litter and feedstuffs as well as cleaning agents and disinfectant.

Waste water, also called dirty water, originates from washing water, from facilities for personnel, from yard run-off and particularly from run-off from open concrete areas that are contaminated by manure. The amounts depend very much on the amount of rainfall. Dirty water can be managed in combination with slurry, but can also be treated and handled separately, in which case separate storage will be needed.

On poultry farms, the aim is to keep manure dry to reduce ammonia emissions and to allow easier handling. Waste water is stored in special tanks and dealt with separately.

On pig farms, waste water is commonly added to the slurry and treated in combination or applied directly to land. Various treatment systems for slurry exist and they are described in Section 2.6. On some farms in Finland using solid manure systems, waste water is conducted through a sedimentation tank into soil treatment or from production buildings into a ditch.

If kept separate, waste water (dirty water) may be applied to land through low-rate irrigators (UK) or treated in a communal or on-farm waste water treatment plant.

### 2.13 Installations for heat and power production

Some farms have installed solar or wind-driven generators to cover part of their own power need. Solar power supply depends very much on the weather conditions and therefore cannot serve as a main supply, but rather as an additional energy source or a replacement for energy supply aiming at a reduction of costs. Windmills attached to a generator can supply power, particularly in areas with relatively high wind-speed. The application is even more economical if excess power can be delivered to the general electricity supply network. More detailed information would be needed to assess its applicability and environmental benefits.

In some MSs much attention is given to the use of any biogas that develops during the storage and treatment of manure.

### 2.14 Monitoring and control of consumption and emission

In the IPPC Directive (96/61/EC), article 9.5 gives farmers a special status concerning monitoring. The article says:

‘The permit shall contain suitable release monitoring requirements, specifying measurement methodology and frequency, evaluation procedure and an obligation to supply the competent authority with data required for checking compliance with the permit. For installations under subheading 6.6 in Annex 1, the measures referred to in this paragraph may take account of costs and benefits.’

This text should be seen as a signal to avoid excessive monitoring obligations on pig and poultry farms.

This section gives some ideas on common practice in monitoring. However, not enough information was submitted to assess what the suitable level of monitoring at a farm is, taking into account the costs and benefits.

In some areas, farmers have to keep a register of their phosphate and nitrogen. This is usually where intensive livestock production is responsible for high pressures on the environment. The resulting balance gives a clearer indication of the input and losses of minerals on the farm. The



information can be used to optimise the feeding of minerals to the animals and to the application of manure to land.

Some farmers assess the nutrient status of soils and apply an appropriate amount of organic nutrients and mineral fertiliser according to crop requirements and rotations. The level of precision varies from those who undertake soil and manure analysis and use some form of recognised nutrient management planning to those who estimate requirements using general published information or those just using experience or guesswork. The legislation that applies in some countries is described in Section 2.7, which explains that the extent of record keeping is variable.

Farmers will have records (receipts) of purchased items, although the extent to which they are kept in an organised way will vary. Such records will usually exist for the main items of feed, fuel (including electricity) and water (not all private abstractions) so the amounts used can be identified. Since feed and water are primary inputs to livestock systems their usage may be monitored by farmers irrespective of whether receipts are kept. Most poultry farmers will have bought in bedding material, whereas pig producers who use straw may produce their own or have an agreement with neighbouring farmers exchanging manure for clean straw.

Computerised registration and the administration of costs, inputs and outputs is increasing and is already common on large enterprises. Where measuring is applied, water gauges, electric meters and computers for indoor climate control are used.

There may be requirements to check slurry stores regularly for any signs of corrosion or leakage and to find any faults that need to be put right. Professional help may be required. Checking takes place after completely emptying the stores.

Regular emissions to water occur under specific legislation and within set (discharge) conditions and monitoring requirements (Portugal, Italy).

Currently, farmers do not normally monitor and control emissions to air unless specifically required to do so as a result of complaints from neighbours. These complaints are usually related to noise and odour emissions.

In Ireland, monitoring of emissions and sampling points for air (odour), noise, surface water, groundwater, soil and waste are required under Integrated Pollution Control Licensing arrangements



### 3 CONSUMPTION AND EMISSION LEVELS OF INTENSIVE POULTRY AND PIG FARMS

This chapter presents data on consumption and emission levels associated with activities on farms for the intensive rearing of poultry and pigs, based on the information that has been submitted in the framework of the information exchange. It aims to give an overview of the ranges that apply to these sectors in Europe and so to serve as a benchmark for the performance levels associated with the techniques presented in Chapter 4. The factors that account for the variation of data are briefly described when possible, or sometimes only mentioned. The circumstances under which data have been obtained is described in more detail in the evaluation of applied techniques in Chapter 4.

#### 3.1 Introduction

The major production systems and techniques on an intensive livestock farm have been described in Chapter 2. The consumption and emission levels that were reported were not always clear and easy to comprehend, and major variations occur due to a large number of factors.

Major on-farm activity	Key environmental issue	
	Consumption	Potential emission
Housing of animals: <ul style="list-style-type: none"> <li>the way the animals are stocked (cages, crates, free)</li> <li>the system to remove and store (internally) the manure produced</li> </ul>	energy, litter	air emissions (NH <sub>3</sub> ), odour, noise, manure
Housing of animals: <ul style="list-style-type: none"> <li>the equipment to control and maintain the indoor climate and</li> <li>the equipment to feed and water the animals</li> </ul>	energy, feed, water	noise, waste water, dust, CO <sub>2</sub>
Storage of feed and feed additives	energy	dust
Storage of manure in a separate facility		air emissions (NH <sub>3</sub> ), odour, emissions to soil
Storage of residues other than manure		odour, emissions to soil, groundwater
Storage of carcasses		odour
Unloading and loading of animals		noise
Application of manure on land	energy	air emissions, odour, emissions to soil, groundwater and surface water of N, P and K etc., noise
On-farm treatment of manure	additives, energy, water	air emissions, waste water, emission to soil
Milling and grinding of feed	energy	dust, noise
Treatment of waste water	additives, energy	odour, waste water
Incineration of residues (e.g. carcasses)	energy	air emissions, odour

**Table 3.1: Key environmental issue of the major on-farm activities**

**Structure of information:** It is important to understand the links between the on-farm activities, described in Chapter 2, to be able to interpret the emissions from intensive livestock farming. Obviously, there is a direct link between the input levels of the different resources and the emission levels.

In both sectors, most attention has been given to the emissions related to the metabolism of the animals. The central issue is manure: the amounts produced, the composition, method of removal, storage, treatment and its application on land. This is reflected in the order in which the activities are presented, starting with feed as the major consumption issue and followed by manure production as the most important emission.

**Understanding of data:** The levels of consumption and emission depend on many different factors, such as the animal breed, production phase, and management system. Additionally factors such as climate and soil characteristics also have to be taken into account. Hence, averages have very limited value and where possible are avoided. The tables show the widest possible ranges of reported consumption and emissions. In the accompanying text an attempt is made to explain this variation as far as information allowed, but without being too specific.

Within MSs standard units are applied that may not always be comparable with units used elsewhere. If the data is at levels in the same order of magnitude as other levels that have been reported, then they form part of the data range and are not explicitly distinguished. Consumption and emission levels can be measured in different ways and at different moments involving the factors mentioned above. For the sake of comparison and for reference, relevant factors will be mentioned that influence the character and the level of the consumption or emission level presented.

In the assessment of consumption and emission levels, a distinction can be made between single activities and the farm as a whole. Where possible, data are directly associated with a single on-farm activity, so as to enable a clear link to the reduction techniques described in Chapter 4. For some issues it is not possible to identify emissions on an activity-by-activity basis. In this case it is easier to assess the consumption and emission for the farm site as a whole.

In the assessment of consumption and emission levels of pig farming it is important to know the production system applied. Growing and finishing aim for a slaughter weight of 90 – 95 kg (UK), 100 – 110 kg (other) or 150 – 170 kg (Italy) and can be reached in different periods of time. Poultry production systems seem to be quite similar throughout the EU.

A remark may be made on the use of animal units to standardise data and to achieve comparability. For this purpose EU-countries use the “animal unit” or “equivalent animal”. There is a problem with these standardised units, because in different EU countries they are defined in different ways, e.g. in Sweden 1 unit = 3 sows = 10 finishers = 100 hens, whereas in Ireland 1 unit = 1 finisher and 10 units = 1 sow including progeny. In Portugal the “equivalent animal” for the pig sector has a 45 kg average, whereas for presenting data on heavy pig production in Italy, 85 kg is taken as a representative weight.

## 3.2 Consumption levels

### 3.2.1 Feed consumption and nutritional levels

The amount and composition of feed given to poultry and pigs is an important factor in determining the amounts of manure produced, its chemical composition and its physiological structure. Thus, feeding is an important factor in the environmental performance of an intensive livestock enterprise.

Emissions from livestock farms are predominantly related to the metabolic processes of the housed animals. Two processes are considered to be essential:

- enzymatic digestion of feed in the gastro-intestinal tract
- absorption of nutrients from the gastro-intestinal tract.

An increasing understanding of these processes is responsible for the development of a wide range of feeds and feed additives adapted to the needs of the animal and to the production aims. Improving the utilisation of nutrients in the feed not only leads to a more efficient production, but could also lead to a reduction of the environmental load.

Consumption levels vary with the energy requirements of the individual animal, which involve maintenance requirements, growth rate and production level. The total amount of feed intake is a result of the duration of the production cycle, the daily intake and the type of production purpose and it is also influenced by a number of factors connected with the animal.

Data on consumption levels are reported in kg per head per production cycle or kg per kg of product (eggs or meat). Comparisons are difficult to make with the use of different breeds and the application of different production targets (egg weight or animal weight) and production cycles.

The following sections present an overview of the feed intake levels and nutrient requirements reported and show the existing variation where possible together with the factors that account for that variation.

### 3.2.1.1 Poultry feeding

Indicative feeding levels for different poultry species are presented in Table 3.2.

Poultry species	Cycle	FCR <sup>1)</sup>	Feeding level range (kg/bird/cycle)	Amount in kg/birdplace/year
Laying hens	12 – 15 months	2.15 – 2.5 <sup>2)</sup>	5.5 – 6.6 (up to production)	34 – 47 (during egg production)
Chicken broilers	35 – 55 days (5 – 8 crops/yr)	1.73 – 2.1	3.3 – 4.5	22 – 29
Turkeys	120 (female) – 150 (male) days	2.65 – 4.1	33 – 38	
Ducks	48 – 56	2.45	5.7 – 8.00	
Guinea fowl	56 – 90 days	2	4.5	
1) FCR = feed conversion ratio				
2) FCR kg feed per kg eggs, higher levels in litter based systems				

**Table 3.2: Indication of production time, conversion ratio and feeding level per poultry species [26, LNV, 1994], [59, Italy, 1999], [126, NFU, 2001], [130, Portugal, 2001]**

The purpose of poultry feeding and the components used in poultry feed mixtures have been described in Section 2.2.5.1. The amino acid composition of feeds is based on the “ideal protein” concept for the relevant species. With this “ideal protein” concept, the required amino acids levels are found by indicating the lysine level and relating the other amino acids to the actual lysine level of the feed. Current field practices are (along with their variability) reported in Table 3.3. The recommended amino acid balances are quoted from literature, but the appraisal of current protein and lysine levels result from field observations at a European level.

	Broilers	Layers	Turkeys
<b>Current energy level MJ/kg, ME basis</b>			
phase 1	12.5 – 13.5		11.0 – 12.5
phase 2	12.5 – 13.5		11.0 – 12.5
phase 3	12.5 – 13.5	11 – 12	11.5 – 12.5
phase 4			11.5 – 13.5
phase 5			
<b>Current protein level (CP=N*6.25), total content</b>			
% feed, phase 1	24 – 20		30 – 25
% feed, phase 2	22 – 19		28 – 22
% feed, phase 3	21 – 17	18 – 16	26 – 19
% feed, phase 4			24 – 18
% feed, phase 5			22 – 15
<b>Current lysine levels, total content</b>			
% feed, phase 1	1.30 – 1.10		1.80 – 1.50
% feed, phase 2	1.20 – 1.00		1.60 – 1.30
% feed, phase 3	1.10 – 0.90		1.40 – 1.10
% feed, phase 4			1.20 – 0.90
% feed, phase 5			1.00 – 0.80
mg/day		850 – 900	
<b>Recommended amino acid balance, in percentage of lysine level</b>			
threonine : lysine	63 – 73	66 – 73	55 – 68
methionine +cystine : lysine	70 – 75	81 – 88	59 – 75
tryptophan : lysine	14 – 19	19 – 23	15 – 18
valine : lysine	75 – 81	86 – 102	72 – 80
isoleucine : lysine	63 – 73	79 – 94	65 – 75
arginine : lysine	105 – 125	101 – 130	96 – 110
<i>ME = metabolisable energy</i>			
<i>CP = crude protein</i>			

**Table 3.3: Appraisal of current protein and lysine levels and scope for recommended amino acids balance [171, FEFANA, 2001], with reference for amino acids to references as, Mack et al., 1999; Gruber, 1999**

Indications of the applied levels of calcium and phosphate in feed are given in Table 3.4.

	Poultry species			
	Layers (mg/animal /day)	Broilers (g/kg compound feed)		
		0 – 2 wks	2 – 4 wks	4 – 6 wks
Ca %	0.9 – 1.5	1.0	0.8	0.7
P <sub>av</sub> % <sup>1)</sup>	0.4 – 0.45	0.50	0.40	0.35
<i>1) available phosphate</i>				

**Table 3.4: Applied calcium and phosphorus levels in feed for poultry [117, IPC Livestock Barneveld College, 1998] [118, IPC Livestock Barneveld College, 1999] [26, LNV, 1994] [122, Netherlands, 2001]**

### 3.2.1.2 Pig feeding

For pigs, the feeding strategy and feed formulation vary with factors such as live weight and stage of (re)production. A distinction is made between the feeding of young sows (gilts), mating and gestating sows and farrowing sows and between piglets, weaners, growers and finishers. Feed amounts are expressed in kg per day and in required energy content per kg of feed. A large

number of tables and data on various feeding strategies are available. The following tables in this section merely present the ranges of reported levels applied in Europe, acknowledging that higher or lower nutrient levels may also be applied in certain cases. The final intake depends on the amount consumed and on the nutrient concentration and therefore minimum levels are recommended for the different feeds to meet the pigs' requirements given its average daily intake. The amount of feed given to a sow in production, including dry periods, and depending on energy intake, amounts to about 1300 to 1400 kg per year.

In Table 3.5, average nutritional levels are shown for sows. Lactating sows generally need slightly higher nutritional levels than gestating sows. In particular CP and lysine are required in higher concentrations in the feed ration. The energy requirements increase towards the moment of birth. After farrowing, daily energy requirements increase with increasing size of the litter. Between weaning and first mating, energy levels remain high to help the animal to recover and to prevent loss of its condition. After mating, the energy content of the feed can be reduced. During winter, higher energy levels are applied for gestating sows.

The amino acid composition of feeds is based on the "ideal protein" concept for the relevant species. In this "ideal protein" concept, the required amino acids levels are found by indicating the lysine level and relating the other amino acids to the actual lysine level of the feed. Current field practices are (along with their variability) reported in Table 3.5 and Table 3.8. The recommended amino acid balances are quoted from literature, but the appraisal of current protein and lysine levels result from field observations at a European level.

	Lactating sow	Gestating sow
<b>Current energy level (MJ/kg), ME basis</b>		
phase 1	12.5 – 13.5	
phase 2		12 – 13
<b>Current protein levels (CP=N*6.25), total content</b>		
% feed, phase 1	18 – 16	
% feed, phase 2		16 – 13
<b>Current lysine levels, total content</b>		
% feed, phase 1	1.15 – 1.00	
% feed, phase 2		1.00 – 0.70
<b>Recommended amino acid balance, in percentage of lysine level</b>		
threonine : lysine	65 – 72	71 – 84
methionine +cystine : lysine	53 – 60	54 – 67
tryptophan : lysine	18 – 20	16 – 21
valine : lysine	69 – 100	65 – 107
isoleucine : lysine	53 – 70	47 – 86
arginine : lysine	67 – 70	-
<i>ME = metabolisable energy</i>		
<i>CP = crude protein</i>		

**Table 3.5: Appraisal of current protein and lysine levels and scope for recommended amino acids for sows (1 phase for each major stage of growth) [171, FEFANA, 2001], with reference for amino acids to literature such as, Dourmad, 1997; ARC, 1981.**

Indications of the applied levels of calcium and phosphate in feed for sows are given in Table 3.6.

	Mating and Gestating sows	Lactating sows
Feed (kg/sow/day)	2.4 – 5.0	2.4 – 7.2
Calcium (% feed)	0.7 – 1.0	0.75 – 1.0
Total phosphorus (% feed)	0.45 – 0.80	0.55 – 0.80

**Table 3.6: Applied calcium and phosphorus levels in feed for sows**  
[27, IKC Veehouderij, 1993], [59, Italy, 1999], [124, Germany, 2001]

Pigs are fed according to their body weight, with feed intake increasing with increasing weight. Towards the end of the finishing period (last 20 – 30 kg) the amount of feed given is unchanged. An example is presented in Table 3.7 for finishers in Italy, where a distinction is made between heavy and light pigs. In general, the feeding is ad libitum for light pigs, that are capable of strong muscular development, but rationed for heavy pigs, that have a considerable propensity towards fat accumulation and towards a higher weight level. This changes the feed composition. For example, whey (5 – 6 % of dry matter) can be used for the heavy pig with 13 – 15 litres of whey substituting for 1 kg of dry feed. The whey can be used in increasing quantities, from 3 – 4 litres per head per day at 30 kg of weight up to a maximum of 10 – 12 litres for more than 130 kg (quantities beyond these levels may have negative effects on the utilisation (i.e. FCR) of the total daily ration).

Live weight (kg)	Heavy pig						
	up to 25	30	50	75	100	125	150+
Feed (88 % dm) (kg/day)	Ad lib.	1.2 – 1.5	1.5 – 2.0	2.0 – 2.5	2.5 – 3.0	2.7 – 3.2	3.0 – 3.4
Feed (% of live weight)	--	4 – 5	3 – 4	2.7 – 3.3	2.5 – 3.0	2.2 – 2.5	2.0 – 2.2
Feed (% of metab. weight) ( $w^{0.75}$ )	--	10 – 12	8 – 10	8 – 10	8 – 10	7 – 9	7 – 8
Live weight (kg)	Light pig						
	Ad lib.	1.5	2.2	2.8	3.1	--	--
	13.8	13.4	13.4	13.4	13.4	--	--
	1.20	0.95	0.90	0.85	0.80	--	--

**Table 3.7: Example of rationing used for light and heavy finishers in Italy**  
[59, Italy, 1999]

The total amount of feed consumed during growing and finishing depends on the breed, FCR, daily growth, length of the finishing period and final live weight. For pigs growing from 25 kg up to 110 kg of live weight, about 260 kg of feed is consumed. Obviously, the nutrient levels of the feed are most important. Nutritional levels have to meet the requirements of daily growth or production. For each weight category average requirements can be distinguished, as reported by various sources and summarised in Table 3.9. Increasingly, finishing periods range between 30 kg and final weight and are divided into 2 or 3 feeding phases. In these phases, the nutrient content in the feed varies to meet the varying demand of the pig. The end of the first growing phase ranges between 45 and 60 kg live weight and the second phase between 80 and 110 kg. Where one feed is given between 30 and 110 kg, the content of the feed is equal to the average of the level of the two-phase feeds.



	Pig
<b>Current energy level (MJ/kg), ME basis</b>	
phase 1 (piglet)	12.5 – 13.5
phase 2 (growing pig)	12.5 – 13.5
phase 3 (finishing pig)	12.5 – 13.5
<b>Current protein levels (CP=N*6.25), total content</b>	
% feed, phase 1	21 – 17
% feed, phase 2	18 – 14
% feed, phase 3	17 – 13
<b>Current lysine levels, total content</b>	
% feed, phase 1	1.30 – 1.10
% feed, phase 2	1.10 – 1.00
% feed, phase 3	1.00 – 0.90
<b>Recommended amino acid balance, in percentage of lysine level</b>	
threonine : lysine	60 – 72
methionine +cystine : lysine	50 – 64
tryptophan : lysine	18 – 20
valine : lysine	68 – 75
isoleucine : lysine	50 – 60
arginine : lysine	18 – 45
<i>ME = metabolisable energy</i>	
<i>CP = crude protein</i>	

**Table 3.8: Appraisal of current protein and lysine levels and scope for recommended amino acids for pigs (1 phase for each major stage of growth) [171, FEFANA, 2001], with reference for amino acids to literature such as, Henry, 1993; Wang et Fuller, 1989 and 1990; Lenis, 1992**

Indications of the applied levels of calcium and phosphate in feed for growers/finishers are given in Table 3.9.

Nutritional Parameters	Pig live weight range			
	30 – 55 kg	55 – 90 kg	90 – 140 kg	140 – 160 kg
Calcium (% feed)	0.70 – 0.90	0.65 – 0.90	0.65 – 0.90	0.65 – 0.80
Total phosphorus (% feed)	0.44 – 0.70	0.45 – 0.70	0.50 – 0.70	0.48 – 0.50

**Table 3.9: Calcium and phosphorus levels applied to feed for growers/finishers [27, IKC Veehouderij, 1993], [124, Germany, 2001], [59, Italy, 1999]**

In finishing the heavy weight pig in Italy, different weight ranges are distinguished with their associated nutrient levels (Table 3.10).

Nutritional Parameters	Pigs 35 – 90 kg	Pigs 90 – 140 kg	Pigs 140 – 160 kg
Crude protein (CP, %)	15 – 17	14 – 16	13
Crude fats	4 – 5	<5	<4
Crude fibre	<4.5 – 6	<4.5	<4
Total lysine	0.75 – 0.90	0.65 – 0.75	0.60 – 0.70
Total methionine + cystine	0.45 – 0.58	0.42 – 0.50	0.36 – 0.40
Total threonine	0.42 – 0.63	0.50	0.40
Total tryptophan	0.15	0.15	0.10 – 0.12
Calcium	0.75 – 0.90	0.75 – 0.90	0.65 – 0.80
Total phosphorus	0.62 – 0.70	0.50 – 0.70	0.48 – 0.50
Digestible energy MJ/kg	>13	>13	>13

**Table 3.10: Average nutritional levels applied in Italy for heavy weight pigs for different live weight intervals (as % of raw feed) [59, Italy, 1999]**

### 3.2.2 Water consumption

The total amount of water used includes not only consumption by the animals, but also the water used for the cleaning of housing, equipment and the farmyard. Cleaning water use particularly affects the volume of waste water produced on-farms.

#### 3.2.2.1 Water requirements of poultry farms

##### 3.2.2.1.1 Animal consumption

In the poultry sector, water is required for satisfying the physiological needs of the animals. Water intake depends on a number of factors, such as:

- animal species and age
- animal condition (health)
- water temperature
- ambient temperature
- feed composition and
- the drinking system used.

With increasing ambient temperatures the minimum water intake of broilers increases geometrically ( $x^n$ ). A higher laying percentage also raises daily consumption of layers [89, Spain, 2000]. With respect to drinking systems, nipple drinkers show lower consumption than round drinker systems, due to lower spillages.

Average water consumption levels are shown in Table 3.11. Water/feed ratios were reported for broilers and laying hens only.

Poultry species	Average ratio water/feed (litres/kg)	Water consumption per cycle (l/head/cycle)	Annual water consumption (l/bird place/year)
Laying hens	1.8 – 2.0	10 (up to production)	83 – 120 (egg production)
Chicken broilers	1.7 – 1.9	4.5 – 11	40 – 70
Turkeys	1.8 – 2.2	70	130 – 150

**Table 3.11: Water consumption of different poultry species per cycle and per year [27, IKC Veehouderij, 1993] [59, Italy, 1999] [26, LNV, 1994]**

### 3.2.2.1.2 Use of cleaning water

Waste water primarily results from the cleaning of the animal houses. All water spills from drinking are usually removed as part of the manure. Farms that produce wet manure (no drying in the poultry house) can store this water in the manure storage facility. On farms where dry manure is produced, waste water is stored differently (e.g. in tanks). Table 3.12 shows the estimated cleaning water use for different poultry housing types.

The volume of water used for cleaning purposes is variable and depends on the applied technique and the water pressure of the high-pressure cleaner. Also, using hot water or steam instead of cold water will reduce the volume of cleaning water used.

For laying hens, water use for cleaning varies with the housing system. Cleaning is done after each round of 12 – 15 months. For layers kept in cages, less cleaning water is needed than for layers in deep litter system. The cleaning of housing systems where layers are kept on deep litter, varies with the area covered with slats. The larger the surface with slats the higher the volume. With a fully solid floor the average water use is estimated to be 0.025 m<sup>3</sup> per m<sup>2</sup>.

Cleaning water use for broiler houses varies widely between Finland and the Netherlands, where 10 times more water is used. The application of warm water can reduce the water use by 50 %.

Poultry species	Use in m <sup>3</sup> per m <sup>2</sup> per cleaning	Cycles per year	Use in m <sup>3</sup> per m <sup>2</sup> per year
Layers – cages	0.01	0.67 – 1	0.01
Layers – deep litter	>0.025	0.67 – 1	>0.025
Broilers	0.002 – 0.020	6	0.012 – 0.120
Turkeys	0.025	2 – 3	0.050 – 0.075

**Table 3.12: Estimated water use for cleaning of poultry housing**  
[62, LNV, 1992]

### 3.2.2.2 Water requirements of pig farms

#### 3.2.2.2.1 Animal consumption

Four types of water consumption can be identified:

1. the water necessary for maintaining homeostasis and meeting the growth requirements
2. the water ingested by the animals in excess of what is strictly necessary
3. the water which is wasted at the moment of drinking due to an incorrect structuring of the distribution system
4. the water used by the animals for satisfying behavioural needs, such as the water spillage during the typical behaviours generated by the lack of 'play' objects other than the drinking system.

Animal consumption of water is expressed in litres per kg of feed and depends on:

- animal age and live weight
- animal health
- stage of production
- climatic conditions
- feed and feed structure.

Water consumption of finishers per kg of feed ingested decreases with age but, as the animals have a higher feed intake with increasing live weight towards the end of the finishing period, the absolute daily water intake is higher. In Italy, where finishing of much heavier pigs is common,

feed is administered predominantly in liquid form, with a water/feed ratio of 4:1 and, when whey derived from cheese production is used, the ratio can reach 6:1. With respect to feed content, reduced CP-levels reduce water intake. With a 6 point decrease a 30 % reduction was observed in water intake [134, Spain, 2001].

For sows, water consumption is important for maintaining homeostasis and for the production of piglets or milk. Such high levels of water ingestion also have positive effects on the animal's ingestion capacity during the suckling phase and on maintaining the health of the urogenital organs during pregnancy.

Pig production type	Weight or production period	Ratio water/feed (l/kg)	Water consumption (l/day/head)
Finishers	25 – 40 kg	2.5	4
	40 – 70 kg	2.25	4 – 8
	70 – finish	2.0 – 6.0	4 – 10
Gilts	100 – mating	2.5	
Sows	dry to 85 days gestating		5 – 10
	from 85 days gestating to farrowing	10 – 12	10 – 22
	Lactating	15 – 20	25 – 40 (no limit)

**Table 3.13: Water requirements of finishers and sows in l/head/day with respect to age and stage of production**  
(Derived from [27, IKC Veehouderij, 1993], [59, Italy, 1999], [125, Finland, 2001] and [92, Portugal, 1999])

Water (or fluid) intake is important for the growth of finishers and has a clear influence on manure production and manure quality. For 25 to 60 kg of live weight, the water intake is about 4 to 8 litres per head per day, increasing to 6 to 10 litres per head per day with increasing live weight. In general, manure production increases, but with a simultaneous decrease of its dry matter percentage, due to an increased water intake (Table 3.14). This pattern is similar for pigs, lactating sows (including litter) and dry sows with water including other fluids such as whey, skimmed milk and silage effluent [91, Dodd, 1996].

Water/feed-ratio	Ration (kg/pig/day)	Manure production (m <sup>3</sup> /pig/year)	Dry matter content (%)
1.9:1	2.03	0.88	13.5
2.0:1	2.03	0.95	12.2
2.2:1	2.03	1.09	10.3
2.4:1	2.03	1.23	8.9
2.6:1	2.03	1.38	7.8

**Table 3.14: Example of the effect of water/feed-ratio on the production and dry matter content of manure of growers/finishers**  
[27, IKC Veehouderij, 1993], with reference to Mestbank Overijssel en Midden, the Netherlands, 1991

Water spillage and slurry production are both influenced by the type of drinking system and the speed of water delivery. In Table 3.15 it can be seen that an increase in the speed of the water delivery of the drinking nipples by a factor 2 leads to an increase in the volume of the slurry produced by a factor 1.5, and at the same time a decrease in the dm-content of the slurry.

Water delivery (l/pig/min)	Manure production (m <sup>3</sup> /pig/year)	Dry matter content (%)
0.4	1.31	9.3
0.5	1.45	8.1
0.6	1.60	7.2
0.7	1.81	6.1
0.8	2.01	5.2

**Table 3.15: Effect of water delivery of drinking-nipples on the production and dry matter content of manure of growers/finishers [27, IKC Veehouderij, 1993], with reference to Mestbank Overijssel en Midden the Netherlands, 1991**

### 3.2.2.2 Use of cleaning water

The volume of waste water produced on pig farms is directly related to the amount of cleaning water used. Water consumption on pig farms is affected not only by the applied cleaning technique, but also by the housing system, as a lot of water is used if washing the floors is required for the purpose of slurry removal. For example, the larger the slatted floor surface, the lower the cleaning water use. Not many data are available on cleaning water use. In Table 3.16 some data are reported that have been measured in different farm types or floor systems, but large variations are observed depending on the use of high pressure cleaning and the application of detergents to soak the surface. Variation in use between floor systems can therefore not explain the level and variation between different farm types.

System/farm-type	Consumption
Solid floors	0.015 m <sup>3</sup> /head/day
Partly-slatted floor	0.005 m <sup>3</sup> /head/day
Slatted floors	0
Breeding farm	0.7 m <sup>3</sup> /head/year
Finishing farm	0.07 – 0.3 m <sup>3</sup> /head/year

**Table 3.16: Estimated water use for the cleaning of pig housing [59, Italy, 1999], [62, LNV, 1992]**

### 3.2.3 Energy consumption

Quantification of the energy consumption of livestock farms is a complex undertaking for all the production systems, as their organisation and systems are not homogeneous. Moreover, the technologies applied to the production system, on which the amount of energy consumption depends to a large extent, vary substantially depending on the structural and production characteristics of the farms. Another important factor that influences the energy consumption is the climatic conditions [188, Finland, 2001].

The collection of data on energy consumption is also difficult, as energy consumption is usually variable and often not clearly monitored. Units will differ depending on the type of energy carrier and will thus need converting into kWh or Wh per day to allow comparisons to be made. Data can be expressed per day per head, but if calculated over a year the seasonal effects of weather on ventilation and heat inputs can be averaged out.

Italy, U.K. and Finland reported energy use on poultry and pig farms and their main findings are presented in the following sections [59, Italy, 1999] [72, ADAS, 1999; 73, Peirson, 1999].

### 3.2.3.1 Poultry farms

As regards **layer farms**, artificial heating of the housing is not commonly applied, due to the low temperature needs of the birds and the (still) high stocking density. Application of the minimum standards for the protection of laying hens [74, EC, 1999] may increase the energy consumption on laying farms, but also depends on the saving techniques applied. Activities requiring energy are:

- Heating the water in winter
- feed distribution
- housing ventilation
- lighting, this requires high consumption levels in order to artificially maintain a constant period of high illumination during the year, so as to increase egg production during the periods of the shortest days
- egg collection and sorting: consumption is about 1 kWh per 50 – 60 m of conveyor belt
- operating the sorting and packaging facilities.

On **broiler farms**, the main energy consumption is related to the following areas:

- local heating in the initial phase of the cycle, this is effected with hot air heaters
- distribution, and sometimes preparation, of feed
- housing ventilation, which varies between the winter and summer periods from 2000 to 12000 m<sup>3</sup>/h per 1000 head.

Energy consumption in an Italian layer farms, related to the preparation of feed, housing ventilation and water heating during the winter months (where necessary), can be 30 – 35 % higher than that of the broiler farms; see Table 3.17. The variability of energy consumption during the year is primarily related to the type of farm and the type of systems used. On broiler farms, in which the consumption attributable to climate control is prevalent, seasonal variations can be substantial, i.e. energy consumption for heat production in winter is higher than that used for ventilation in summer. On broiler farms, electrical energy consumption is at a maximum in the summer (ventilation) and thermal consumption is at a maximum in winter (ambient heating). At laying hen farms, where winter heating is not used, the peak of (electrical) energy consumption is in summer, due to the increase in ventilation rate. [59, Italy, 1999]

Table 3.17 shows the energy requirements of some essential activities on broiler and layer farms in Italy, from which it would be possible to calculate their total energy consumption. The daily consumption will be quite variable depending on the size and the equipment used, on energy saving measures, as well as on losses caused by lack of insulation.

Activity	Estimated energy consumption (Wh/bird/day)	
	Broilers	Laying hens
Local heating	13 – 20	
Feeding	0.4 – 0.6	0.5 – 0.8
Ventilation	0.10 – 0.14	0.13 – 0.45
Lighting	--	0.15 – 0.40
Egg preservation (Wh/egg/day)		0.30 – 0.35

**Table 3.17: Indicative levels of daily energy consumption of activities on poultry farms in Italy [59, Italy, 1999]**

The overall energy consumed based on these (Italian) consumption data was reported as ranging between 3.5 and 4.5 Wh per bird per day depending on the type of farm. This range does not correspond with data on the consumption of poultry farms in the UK, where much higher energy consumptions have been reported for both layer and broiler farms (Table 3.18). It was pointed out that the underlying data in the UK study include energy used in other parts of the poultry enterprise as well and may thus overestimate the actual energy use of a poultry unit. For example, where poultry farms may also have an on-site feed production plant, the energy input would be markedly higher than on those farms where feedstock is delivered (for example, the total energy use for a hammer mill with pneumatic meal transfer: 15 – 22 kWh).

Species	Unit size	Energy use (kWh/bird sold)	Production time/bird	Energy use (kWh/bird/day)
Broilers	Up to 200000 birds sold/year	2.12 – 7.37	42 days	0.05 – 0.18
	Over 200000 birds sold/year	1.36 – 1.93		0.03 – 0.046
		Energy use (kWh/bird/year)	Laying period	Energy use (Wh/bird/day)
Layers	Up to 75000 birds in flock	3.39 – 4.73	1 year	9.29 – 12.9
	Over 75000 birds in flock	3.10 – 4.14		8.49 – 11.3
<i>Data include use of all energy carriers (fuel, electricity) and energy consuming activities</i>				

**Table 3.18: Indicative levels of energy use of poultry farms in the UK [73, Peirson, 1999]**

Apart from annual trends, daily trends in electrical energy consumption are also quite variable and related to the type of technical systems used on the farm. Often, there are two daily peaks corresponding to feed distribution.

As far as the energy use for other poultry species concerns, total energy use for turkeys was reported to be about 1.4 to 1.5 kWh per bird per year [124, Germany, 2001] and [125, Finland, 2001].

### 3.2.3.2 Pig farms

Energy use on pig farms is related to illumination, heating and ventilation. Daylight is considered to be desirable, but artificial light is used instead in areas where natural light intensity can be highly variable. Energy requirements for the illumination of pig housing can therefore be quite different for different areas in Europe.

Energy use for heating depends on the type of animal and the housing system. Examples are presented in [72, ADAS, 1999] and show a considerable range in energy input.

For feed preparation total energy use is considered to be between 15 and 22 kWh/tonne of meal produced where a hammer mill with pneumatic transfer is used to mill cereals. Pelletisation or cubing of the feed on-farm will double the input, requiring about 20 kWh per tonne.

Housing type/management	Energy inputs breeder/finisher herd (kWh/finisher produced per year)	Energy inputs weaner/breeder herd (kWh/sow per year)
<b>Heating – Farrowing House Creeps</b>		
Uncontrolled heater lamp (250 W)	15.0	
Heater lamp with 50 % dimmer (half time)	10.2	
Temperature controlled lamp in creep box	7.8	
<b>Heating – Weaner accommodation</b>		
Flatdeck with poor ventilation/heater control	10 – 15	200 – 330
Flatdeck with good ventilation/heater control	3 – 5	70 – 115
Automatically heated/ventilated kennels	3 – 6	130
<b>Ventilation</b>		
Dry sows/service		30 – 85
Farrowing		20 – 50
Fans – Farrowing	1 – 2	
Fans – Flatdeck	1 – 2.25	
Fans – Rearing	2 – 5	
Fans – Finishing	10 – 15	
Automatically Controlled Natural Ventilation (ACNV)	Negligible	
<b>Lighting</b>		
All stages of the housing	2 – 8	50 – 170
<b>Milling and mixing</b>		
Whole herd feed preparation	3 – 4.5	20 – 30

**Table 3.19: Approximate annual energy use for typical pig housing types and systems in the UK [72, ADAS, 1999]**

With these data the total energy use on both farm types was calculated for different herd sizes (Table 3.20).

Weaner/breeder herd farm size	Energy use (kWh/sow/yr)	Breeder/Finisher herd farm size	Energy use (kWh/pig sold/yr)
< 265 sows	457 – 1038	< 1200 pigs	385 – 780
265 – 450 sows	498 – 914	1200 – 2100 pigs	51 – 134
> 450 sows	83 – 124	> 2100 pigs	41 – 147

**Table 3.20: Total annual energy use per head on different farm types of different size in the UK [72, ADAS, 1999]**

Average daily consumption per head was calculated in Italy on different types of farms of the same size with at least 10 head/farm (Table 3.21). A very wide variation was observed. The finishing farms have lower energy use on average than breeding farms and integrated farms. In particular a lower consumption of diesel fuel and electricity accounts for this.



Energy source	Energy consumption per farm type (kWh/head/day)		
	Integrated farms	Breeding	Finishing
Electrical energy consumption	0.117	0.108	0.062
Diesel fuel	0.178	0.177	0.035
Natural gas	0.013	0.017	0
Fuel oil	0.027	0.011	0.077
Liquid gas	0.026	0.065	0.001
Total thermal consumption	0.243	0.270	0.113
<b>Total energy consumption</b>	<b>0.360</b>	<b>0.378</b>	<b>0.175</b>

**Table 3.21: Average daily energy consumption per type of pig farm and by type of energy source used in Italy [59, Italy, 1999]**

The effect of farm size is also illustrated for farms in Italy (Table 3.22). Here, the larger the farm the higher the energy consumption. This was explained by the use of higher technology on larger enterprises, with an associated higher consumption of power (factor 2.5). Interestingly, this is in contrast with the experiences in the UK, where large herds have lower energy inputs per head than small herds [72, ADAS, 1999].

Energy source	Estimated energy consumption per farm size (kWh/head/day)			
	Up to 500 pigs	501 to 1000 pigs	1001 to 3000 pigs	Over 3000 pigs
Electrical energy consumption	0.061	0.098	0.093	0.150
Diesel fuel	0.084	0.107	0.169	0.208
Natural gas	0.002	0.012	0.023	0.010
Fuel oil	0.048	0.029	0.011	0.049
Liquid gas	0.042	0.048	0.018	0.026
Total thermal energy consumption	0.176	0.196	0.221	0.293
<b>Total energy consumption</b>	<b>0.237</b>	<b>0.294</b>	<b>0.314</b>	<b>0.443</b>

**Table 3.22: Average daily energy consumption for farms in Italy by farm size and energy source [59, Italy, 1999]**

Another difference between the surveys was that electrical energy in Italy was considered as the basic energy source, but the survey revealed that the energy requirements of pig farms are predominantly met by fossil fuels, which supply up to 70 % of their total energy requirements. In the UK the majority of the energy supply is consumed as electricity (>57 %).

### 3.2.4 Other inputs

#### 3.2.4.1 Bedding (litter)

The amount of litter used depends on the animal species, the housing system and the farmers' preferences. Use of litter is expressed in m<sup>3</sup> per 1000 birds, or in kg per animal per year (Table 3.23). Amounts used may increase for both layers and pigs, where legislation on animal welfare and market demands will require more litter based housing techniques.

Animal species	Housing system	Litter used	Typical amounts used	
			kg/animal/yr	m <sup>3</sup> /1000 head
Layers	Deep litter	Wood shavings Chopped straw 38 – 50 mm	1.0	3
Broilers	Deep litter	Wood shavings Chopped straw Chopped paper	0.5 kg/bird/crop	2.3
		Peat	0.25 – 0.5 kg/bird/crop	
Turkeys	Deep litter	Wood shavings Chopped straw	14 – 15 (females) 21 – 22 (males) (2.7 batches)	
Finishers	Pens	Straw	102	

**Table 3.23: Typical amounts of bedding material used by pigs and poultry in 1 housing systems [44, MAFF, 1998]**

### 3.2.4.2 Cleaning material

Cleaning material (detergents) are used with water and will end up in waste water treatment facilities or in the slurry.

A variety of detergents are used for cleaning the housing. Very little information is available on the amounts used. For poultry a concentration of 1 litre of disinfectant per m<sup>3</sup> was reported, but for pigs quantification is considered to be very difficult and no representative data have been reported.

## 3.3 Emission levels

The majority of emissions from the main activities on any poultry or pig farm can be attributed to the amount, structure and composition of manure. From an environmental point of view, manure is the most important residue to be managed on-farm. This section therefore starts by presenting an overview of the characteristics of poultry and pig manure before presenting the emission levels of the on-farm activities.

Most information reporting on environmental issues addresses the emission of NH<sub>3</sub>-N and NH<sub>4</sub><sup>+</sup>-N and P<sub>2</sub>O<sub>5</sub>. The different on-farm activities contribute to these emissions to a differing extents. Housing has repeatedly been reported as one of the largest contributors in both sectors (Table 3.24).

Total losses	Poultry		Pigs	
	kt	%	kt	%
Total housing losses	29.21	68.6	20.41	69.9
Total storage losses	0.21	0.5	1.83	6.3
Total landspreading losses	12.40	29.1	6.17	21.1
Total outdoor losses	0.76	1.8	0.80	2.7
<b>Total Loss</b>	<b>42.58</b>	<b>100.0</b>	<b>29.21</b>	<b>100.0</b>

**Table 3.24: Example of contribution to NH<sub>3</sub>-N emissions of different activities in the UK (1999) [139, UK, 2001]**

The characteristics of manure are, in the first place, affected by the quality of feed, expressed in dm-% and the concentration of nutrients (N, P, etc.), and by the efficiency with which the animal can convert it into product (FCR). As feed characteristics vary largely, the concentrations in fresh manure will show similar variations. Measures applied to reduce emissions associated with collection (housing), storage and treatment of manure will affect the structure and composition of manure and in the end will influence the emissions associated with application to land.

Emissions are presented as ranges rather than as single averages (mean values), which would not allow the existing variation to be acknowledged or the lower levels achieved to be identified. The lowest and the highest level that were reported are presented to form the overall European emission range and the factors responsible for this variation are explained. On a national basis, emissions will vary within different ranges, but it is assumed that similar factors apply. Differences have been explained where the data were supported in a way that made this possible.

### 3.3.1 Excretion of manure

This section reports on the excretion levels of manure and nutrient contents that have been submitted. A lot of research has been conducted to understand how manure production and nutrient content vary with the production stage and the composition of the diet. Models have been developed to allow easy calculation of emissions, standardizing metabolic loss or the retention of certain minerals. An example was submitted that is used to calculate minerals excreted by different animal species (Table 3.25). With a known composition of the feed it allows identification of the potential mineral gross production of N and P<sub>2</sub>O<sub>5</sub>. The average losses of N during storage, treatment and spreading are estimated to be 15 % of the gross production [174, Belgium, 2001].

Animal species	Mineral gross production in manure (kg/animal/year)	
	P <sub>2</sub> O <sub>5</sub>	N
Pigs 7 – 20 kg	2.03 x (P uptake) – 1.114	0.13 x (N uptake) – 2.293
Pigs 20 – 110 kg	1.92 x (P uptake) – 1.204	0.13 x (N uptake) – 3.018
>110 kg	1.86 x (P uptake) + 0.949	0.13 x (N uptake) + 0.161
Sows including offspring <7 kg	1.86 x (P uptake) + 0.949	0.13 x (N uptake) + 0.161
Layers	2.30 x (P uptake) – 0.115	0.16 x (N uptake) – 0.434
Broilers	2.25 x (P uptake) – 0.221	0.15 x (N uptake) – 0.455
<i>P-uptake in kg P/animal/year</i>		
<i>N-uptake in kg raw protein/animal/year</i>		

**Table 3.25: Example of models used in Belgium for the calculation of mineral gross production in manure**  
[207, Belgium, 2000], table B17

#### 3.3.1.1 Levels of excretion and characteristics of poultry manure

Depending on the housing system and the way of collecting manure different types of poultry manure are produced:

- wet manure (0 – 20 % dm) from layers in battery housing and from ducks
- dry manure (>45 % dm) from layers in battery housing where drying is applied
- deep litter manure (50 – 80 %) from laying hens, broilers, turkeys and ducks.

Manure with a dm-% between 20 and 45 % is difficult to handle and in practice water is added to enable pumping of the slurry. Deep litter manure is manure mixed with the litter and typically a residue of housing when animals are kept on concrete or slatted floors on litter. The dm-content is important, as with increasing dm-content emission of  $\text{NH}_3$  will decrease. Calculations showed that with quick drying to a dm-content of > 50 % the emissions of  $\text{NH}_3$  (g/hr) were reduced to less than half the emissions a from manure with a dm-content of < 40 %.

The production of poultry manure is reported in various ways with a large variation in the level of aggregation. As far as analyses reported by various sources could be compared, ranges of the composition of manure from different species and different housing systems are very similar.

Dm-content is an important controlling factor for total nutrient levels in [135, Nicholson et al., 1996]. Data in Table 3.26 show the variation of nutrient levels in manure expressed as percentage of dm. The ammonium ( $\text{NH}_4$ )-N and uric acid-N content of poultry manure correspond with the readily available-N supply in plants. Data are based on the work done in the UK [135, Nicholson et al., 1996] and ranges reported were confirmed by other sources. Single values are reported where ranges were not reported or could not be derived from the available information.

Feed type, housing system (application of manure drying and the use of litter) and poultry breeds are factors that account for this variation. With respect to feeding, it is clear that the higher the protein level in feed the higher the N-levels in manure. For the different poultry species, N-concentration levels vary within a similar range. For layers, some of the housing systems show a much higher variation in dm than others, which may be due to the management system, but a single factor was not reported.

Species	Housing system	Manure produced		Nutrients (% of dry weight)						
		kg/birdplace/yr	Dm (%)	Total N	NH <sub>4</sub> -N	Uric acid-N	P	K	Mg	S
Laying hens	Battery – open storage	73 – 75	14 – 25	4.0 – 7.8	no data	no data	1.2 – 3.9	no data	no data	no data
	Deep-pit housing	70	23.0 – 67.4	2.7 – 14.7	0.2 – 3.7	<0.1 – 2.3	1.4 – 3.9	1.7 – 3.9	0.3 – 0.9	0.3 – 0.7
	Stilt housing	no data	79.8	3.5	0.2	0.3	2.9	2.9	0.7	0.7
	Battery – belt scrapers	55	21.4 – 41.4	4.0 – 9.2	0.5 – 3.9	<0.1 – 2.7	1.1 – 2.3	1.5 – 3.0	0.3 – 0.6	0.3 – 0.6
	Battery – manure belt (forced drying)	20	43.4 – 59.6	3.5 – 6.4	no data	no data	1.1 – 2.1	1.5 – 2.8	0.4 – 0.8	no data
	Manure belt (forced drying)/drying afterwards	no data	60 – 70	no data	no data	no data	no data	no data	no data	no data
	Deep litter (free range)	no data	35.7 – 77.0	4.2 – 7.6	0.7 – 2.2	1.7 – 2.0	1.4 – 1.8	1.6 – 2.8	0.4 – 0.5	0.3 – 0.7
	Aviary system	no data	33.1 – 44.1	4.1 – 7.5	0.5 – 0.9	1.9 – 2.3	1.2 – 1.4	1.6 – 1.8	0.4 – 0.5	0.4 – 0.5
Broilers	Deep litter (5 – 8 crops)	10 – 17	38.6 – 86.8	2.6 – 10.1	0.1 – 2.2	<0.1 – 1.5	1.1 – 3.2	1.2 – 3.6	0.3 – 0.6	0.3 – 0.8
Turkeys (meat)	Deep litter (2.3 – 2.7 crops, female and male birds)	37	44.1 – 63.4	3.5 – 7.2	0.5 – 2.3	<0.1 – 1.1	1.3 – 2.5	1.9 – 3.6	0.3 – 0.7	0.4 – 0.5
Ducks	Various (deep litter to fully slatted)	no data	15 – 72	1.9 – 6.6	1.2	<0.1	0.7 – 2.0	2.2 – 5.6	0.2 – 0.7	0.3

**Table 3.26: Range of reported levels of poultry manure production, dm-content and nutrient analysis of fresh poultry manure in different poultry housing systems**  
 [26, LNV, 1994], [127, Italy, 2001], [135, Nicholson et al., 1996]

### 3.3.1.2 Levels of excretion and characteristics of pig manure

The annual amount of pig manure, urine and slurry that is produced varies with pig production category, nutrient content of feed and the drinking system applied, as well as by different production stages with their typical metabolism. During the post-weaning period, feed conversion and live weight gain primarily affect the outputs per animal, whereas growth rate and muscle percentage are less important. For sows, outputs are not influenced by performance when expressed per animal, but can vary a lot when expressed per piglet. The length of the production period and the feed/water-ratio are important factors that further account for the observed variation in amounts of slurry per year (Table 3.27). With higher slaughter weights, higher levels of slurry production are found (UK, 4.5 – 7.2 kg per head per day for baconers).

Pig category	Production (kg/head/day)			Production in m <sup>3</sup> /head	
	Manure	Urine	Slurry	per month	per year
Gestating sow	2.4	2.8 – 6.6	5.2 – 9	0.16 – 0.28	1.9 – 3.3
Farrowing sow <sup>1)</sup>	5.7	10.2	10.9 – 15.9	0.43	5.1 – 5.8
Weaner <sup>2)</sup>	1	0.4 – 0.6	1.4 – 2.3	0.04 – 0.05	0.5 – 0.9
Finisher <sup>3)</sup>	2	1 – 2.1	3 – 7.2	0.09 – 0.13	1.1 – 1.5
Finisher (- 160 kg)	no data	no data	10 – 13	no data	no data
Gilt	2	1.6	3.6	0.11	1.3

<sup>1)</sup> water intake varies with drinking system  
<sup>2)</sup> feeding and drinking system account for variation  
<sup>3)</sup> finishing weight 85 – 120 kg

**Table 3.27: Range of levels reported on daily and annual production of manure, urine and slurry by different pig categories**  
 [27, IKC Veehouderij, 1993], [71, Smith et al., 1999], [137, Ireland, 2001]

The following remarks can be made on the variation of nutrient composition of manure. Feed composition and the level of feed utilisation (FCR) determine the nutrient levels of pig manure. Utilisation may vary, but advances in the understanding of pig metabolism make it possible to manipulate the composition of manure by changing the nutrient content of pig feed. FCRs vary between the different stages of production, e.g. finishing pigs have FCR-levels ranging between 2.5 and 3.1.

Important factors for the level of excretion of N and P are:

- N- and P concentration in feed
- animal production type
- level of animal production.

The relationship between the intake of N and P through feed and their excretion in manure has been analysed to allow estimations of N- and P-outputs through land application. Models have been developed that attempt to give an indication of the excretion levels in pig slurry. A review of excretion by pigs and poultry revealed that these models are in line with data where excreta outputs from pigs have been measured alongside information on feed inputs. At the same time, it was concluded that the information can be used as general guidance, but that at the individual farm level some variation in levels will be observed and different figures for manure output and N excretion will be appropriate [71, Smith et al., 1999].

Many reports clearly show that lower N levels in manure result from lower crude protein levels (CP-levels) in feed. With a lower consumption and an unchanged retention, N-losses are considerably reduced (Table 3.28).

Species	Level of nitrogen (g/d)					
	Consumption		Retention		Losses	
	Low CP	High CP	Low CP	High CP	Low CP	High CP
Grower	48.0	55.6	30.4	32.0	17.5	23.7
Finisher	57.1	64.2	36.1	35.3	21.0	28.9
Total	105.1	119.8	66.5	67.3	38.5	52.6
Relative (%)	88	100	99	100	73	100

**Table 3.28: Example of effect of reduced CP-levels in feed for growers and finishers on daily consumption, retention and losses of nitrogen [131, FORUM, 2001]**

The annual excretion of N and P by farrowing sows is the result of the excretion of both sow and piglets up to weaning, but varying litter size has minor influence as illustrated with an example from the Netherlands Table 3.29. The data show clearly that excretion is influenced by the content of N in the feed, rather than by differences in technical performance (number of pigs). Efficiency in N-utilisation is considered to be highest by farrowing sows and piglets just after weaning.

	Average number of weaned piglets					
	17.1		21.7		25.1	
	N1 <sup>1)</sup>	N2 <sup>2)</sup>	N1 <sup>1)</sup>	N2 <sup>2)</sup>	N1 <sup>1)</sup>	N2 <sup>2)</sup>
<b>N-excretion factor</b>						
Piglet feed	29.0	27.4	29.0	27.4	29.0	27.5
Sow feed – pregnant	22.0	20.4	22.0	20.4	22.0	20.4
Sow feed – lactation	25.5	23.9	25.5	23.9	25.5	23.9
<b>N-excretion</b>						
N-excretion (kg/yr)	28.7	26.2	29.5	26.7	29.5	26.6

1) N1: Higher nitrogen content in feeds  
2) N2: Lower nitrogen content in feeds

**Table 3.29: Average excretion of nitrogen (kg per year) in a housing with a breeding sow (205 kg) and different numbers of piglets (up to 25 kg) at weaning [102, ID-Lelystad, 2000]**

The gestation and growing-fattening areas are comparatively inefficient. This is even truer in Italy, where the Italian heavy pig (final average weight 160 kg) shows even lower protein efficiency than the light pig, due to the low nitrogen retention found at high levels of live weight (Table 3.30). Since growing and fattening alone makes up for the major contribution (77 – 78 %) to the elimination of nitrogen in excretions, measures taken with the diet aimed at improving the balance of this element must be concentrated on this category. The ratio of nitrogen excreted/nitrogen ingested for growers/finishers is generally high, e.g. around 65 % on a closed cycle farm.

Nitrogen balance (g/head/day)	Growing phase (kg)		
	40 – 80	80 – 120	120 – 160
Nitrogen ingested	40.9	69.3	61.3
Nitrogen excreted	25.3	45.7	40.7
Nitrogen retention (%) (N excreted/N ingested)	61.9	65.9	66.4

**Table 3.30: Nitrogen retention in different growing phases of finishers (Italian data) [59, Italy, 1999]**

The applied finishing method is very important. Whereas in Italy 1.5 finishing periods apply, in other European Member States it is common to have between 2.5 and 3 rounds of finishing with different farming systems, leading to weights between 90 and 120 kg. The associated annual levels of N-excretion are reportedly between 10.9 and 14.6 kg N per animal place [102, ID-Lelystad, 2000].

Finishing pigs	Member States			
	France	Denmark	Netherlands	Italy
Finishing period (kg)	28 – 108	30 – 100	25 – 114	40 – 160
Excretion (kg/animal)	4.12	3.38	4.32	-
Annual excretion (kg/place)	10.3 – 12.36	8.45 – 10.14	10.8 – 12.96	15.4 <sup>1)</sup>
1) 1.5 finishing herds/year				

**Table 3.31: Annual excretion of nitrogen for different categories of finishers [102, ID-Lelystad, 2000], [59, Italy, 1999]**

Similarly to N-excretion levels, P-excretion varies with the total phosphorus content in the diet, the genetic type of the animal and the weight class of the animal (see Table 3.32). Availability of phosphorus in the diet is an important factor and measures to improve this (phytase) show reduced P-emissions in manure. Comparing the different pig groups, retention of P is highest in weaners.

	Days	Consumption	Retention	Excretion			
				faeces	urine	Total	%
<b>Sow</b>							
Lactation	27	0.78	0.35	0.34	0.09	0.43	55
Dry + gestating	133	1.58	0.24	0.79	0.55	1.34	85
Total/cycle	160	2.36	0.59	1.13	0.64	1.77	75
Total/year	365	5.38	1.35	2.58	1.46	4.04	75
<b>Pig</b>							
Piglet (1.5 – 7.5 kg) <sup>1)</sup>	27	0.25	0.06	0.12	0.07	0.19	75
Weaner (7.5 – 26 kg)	48	0.157	0.097	0.053	0.007	0.06	38
Finisher (26 – 113 kg)	119	1.16 <sup>2)</sup>	0.43	0.65 <sup>3)</sup>	0.08	0.73	63
1) based on 21.6 piglets/sow/year							
2) feed intake 2.03 kg/day and 4.8 g P/kg feed							
3) feed intake 2.03 kg/day and 2.1 g dP/kg feed							

**Table 3.32: Example of consumption, retention and excretion of phosphorus in pigs (kg per pig) [138, the Netherlands, 1999]**

Next to the nitrogen and phosphorus content, the excretion of potassium, magnesium oxide and sodium oxide are also relevant for application, see Table 3.33.



	DM	OM	N <sub>total</sub>	N <sub>m</sub>	N <sub>org</sub>	P <sub>2</sub> O <sub>5</sub>	K <sub>2</sub> O	MgO	Na <sub>2</sub> O	Density kg/m <sup>3</sup>
<b>Slurry</b>										
Finishers	90	60	7.2	4.2	3.0	4.2	7.2	1.8	0.9	1040
	(32)		(1.8)	(1.1)	(1.3)	(1.5)	(1.9)	(0.7)	(0.3)	
Sows	55	35	4.2	2.5	1.7	3.0	4.3	1.1	0.6	
	(28)		(1.4)	(0.8)	(1.0)	(1.7)	(1.4)	(0.7)	(0.2)	
<b>Liquid fraction of solid manure</b>										
Finishers	20 – 40	5	4.0 – 6.5	6.1	0.4	0.9 – 2.0	2.5 – 4.5	0.2 – 0.4	1.0	1010
Sows	10	10	2.0	1.9	0.1	0.9	2.5	0.2	0.2	
<b>Solid manure</b>										
Pigs (straw)	230 – 250	160	7.0 – 7.5	1.5	6.0	7.0 – 9.0	3.5 – 5.0	0.7 – 2.5	1.0	
<i>N<sub>m</sub></i> metabolic nitrogen										
<i>N<sub>org</sub></i> organic nitrogen										

**Table 3.33: Average composition of manure and standard deviation (between brackets) in kg per 1000 kg of manure [27, IKC Veehouderij, 1993], [49, MAFF, 1999]**

### 3.3.2 Emissions from housing systems

After manure, emissions to air are the major emissions from animal housing. Key emissions to air are ammonia, odour and dust. Dust development is important as it can be a direct nuisance to animals and humans, and as it also plays an important role as a carrier of odorous compounds. The level and variation of air emissions are determined by many factors, these can be linked and can also affect each other. Major factors that influence air emissions from housing are:

- design of the animal housing and manure collection system
- ventilation system and ventilation rate
- applied heating and indoor temperature
- the amount and quality of manure, which also depends on:
  - feeding strategy
  - feed formulation (protein-level)
  - application of litter
  - watering and watering-system
  - number of animals.

The following sections will present the levels of emissions of different substances to air from poultry and pig housing systems. The lowest levels are generally achieved with additional air cleaning techniques (end-of-pipe), such as a chemical scrubber.

Emissions from pig and poultry housing are reported mostly in terms of ammonia (Table 3.30), but other (greenhouse) gases such as methane ( $\text{CH}_4$ ) and nitrous oxide ( $\text{N}_2\text{O}$ ) are emitted as well and are expected to attract more attention [140, Hartung E. and G.J. Monteny, 2000].  $\text{NH}_3$  and  $\text{CH}_4$  primarily result from metabolic reactions in the animal and the slurry and are produced from compounds in the feed.  $\text{N}_2\text{O}$  is a secondary reaction product of the ammonification of urea, and is readily available or can be converted from uric acid in urine.

#### 3.3.2.1 Emissions from poultry housing

An overview is given in Table 3.34 of a number of emissions from poultry housing. A number of data have been reported on ammonia emissions. As far as concentrations and emissions of the other substances have been reported, the following was concluded.

The development of nitrous oxide ( $\text{N}_2\text{O}$ ), methane ( $\text{CH}_4$ ) and non-methane volatile organic compounds (nmVOC) is associated with the internal storage of manure, and their levels in housing can be considered very low when the manure is frequently removed. Hydrogen sulphide ( $\text{H}_2\text{S}$ ) is generally present at very low quantities, i.e. about 1 ppm [59, Italy, 1999].

Quantification of the concentrations and emission rates of  $\text{NH}_3$ ,  $\text{CO}_2$  and dust have been reported for layers in, respectively, a perchery and a deep pit house, and for broilers in a typical broiler house [129, Silsoe Research Institute, 1997]. This highlighted that the ammonia concentration can rise to peaks (for more than an hour) of 40 ppm ( $\text{g}/\text{m}^3$ ) in broiler houses, which was considered to be due to poor litter management. The levels on  $\text{NH}_3$  emissions from broiler houses reported in Table 3.34 are from the Netherlands, reference [179, Netherlands, 2001].

The levels of  $\text{NO}_2$ ,  $\text{CH}_4$ , as found by the Silsoe Research Institute, were slightly above ambient levels. Levels of inspirable dust ranged from 2 to 10  $\text{mg}/\text{m}^3$  and of respirable dust of 0.3 to 1.2  $\text{mg}/\text{m}^3$ . This is high in comparison with long-term exposure limits for inspirable dust of 10  $\text{mg}/\text{m}^3$  for humans, and even more for suggested limits of 3.4  $\text{mg}/\text{m}^3$  for animals. Higher ventilation rates increased the emission concentrations. [129, Silsoe Research Institute, 1997]

In general, dust levels are higher in litter-based systems than in cage systems. As dust functions as a carrier for part of the air emissions, higher levels for gaseous compounds such as  $\text{CH}_4$  and

NO<sub>2</sub> are associated with litter-based systems. This observation was confirmed by data reported in [140, Hartung E. and G.J. Monteny, 2000]. Also, the levels found in that survey showed a large variation: from ten times the levels in the table to levels that were not detectable or just above ambient concentrations.

Poultry	NH <sub>3</sub>	CH <sub>4</sub> <sup>1)</sup>	N <sub>2</sub> O <sup>1)</sup>	Dust <sup>1)</sup>	
				Inspirable	Respirable
Laying hens	0.010 – 0.386	0.021 – 0.043	0.014 – 0.021	0.03	0.09
Broilers	0.005 – 0.315	0.004 – 0.006	0.009 – 0.024	0.119 – 0.182	0.014 – 0.018
Turkeys	0.190 – 0.68	no data	0.015 <sup>2)</sup>	no data	
Ducks	0.210				
Guinea fowls	0.80				

1) approximate values derived from measured results in [129, Silsoe Research Institute, 1997]  
2) average reported by Italy valid for each of the poultry species

**Table 3.34: Indication of reported levels of air emission from poultry housing (kg/bird/yr)** [26, LNV, 1994], [127, Italy, 2001], [128, Netherlands, 2000] [129, Silsoe Research Institute, 1997] [179, Netherlands, 2001]

### 3.3.2.2 Emissions from pig housing

Many factors determine the level of emissions from pig housing, but the effects are not easy to quantify, and can cause large variations. The nutrient content and structure of feed, the feeding technique and water intake are all of major importance. Climate conditions and the level of maintenance of the housing facilities are further possible causes of variation. Care must therefore be taken when interpreting absolute levels. Some reported levels have been summarised in Table 3.35. The levels apply to different housing techniques and different areas. Data on CH<sub>4</sub> and N<sub>2</sub>O are the result of an inventory that concluded that data for pig housing are indicative. Only a few data are available and they can be used to a limited extent. Observed ranges vary and in the table only the lowest and highest observed levels are reported.

Studies showed that planning the position of drinking and feeding areas, social behaviour in a group and reactions to changes in climate all influence the manuring behaviour of the animals and hence can change the emission levels. For example, in designs with solid or partly-slatted floors, temperature increases stimulate animals to find cooling by lying in their manure on the non-slatted part of the floor, thus spreading the manure and enhancing emissions. In another example, in pens for group-housed sows designed with functional areas, it was observed that care must be taken to guarantee the accessibility of these areas, as the social order in the group prevented younger sows from free and easy access, when older sows blocked small passageways to the feeding and dunging area. The young sows then started to manure outside the designed slatted area causing an increase in ammonia emissions.

Species		Housing system	NH <sub>3</sub> <sup>1)</sup>	CH <sub>4</sub> <sup>2)</sup>	N <sub>2</sub> O <sup>2)</sup>
Sows	Mating/Gestating		0.4 – 4.2	21.1	no data
	Farrowing		0.8 – 9.0	no data	no data
Weaners	<30 kg		0.06 – 0.8	3.9	no data
Fatteners	>30 kg	Fully slatted	1.35 – 3.0	2.8 – 4.5	0.02 – 0.15
		Partly slatted	0.9 – 2.4	4.2 and 11.1	0.59 – 3.44
		Solid and litter	2.1 – 4	0.9 – 1.1	0.05 – 2.4

1) lowest NH<sub>3</sub> levels are achieved with the application of end-of-pipe techniques  
2) lowest and highest levels reported

**Table 3.35: Range of air emission from pig housing systems in kg/animal place/year** [10, Netherlands, 1999], [59, Italy, 1999], [83, Italy, 2000], [87, Denmark, 2000], [140, Hartung E. and G.J. Monteny, 2000]

### 3.3.3 Emissions from external manure storage facilities

The storage of solid manure and slurry is a source of emissions of ammonia, methane and other odorous components. The liquid draining from solid manure (e.g. stacks in field) can also be considered as an emission. Emissions of manure storage depend on a number of factors:

- chemical composition of manure/slurry
- physical characteristics (dm %, pH, temp.)
- emitting surface
- climatic conditions (ambient temperature, rain)
- application of cover.

Most important factors are dm-% and nutrient content (N), which depend on the feeding practice. In addition, housing techniques that aim for a reduction of emissions from in-house collection and storage of manure and slurry may affect the manure content as well.

The physical characteristics of pig slurry generally cause low N-emission. No crust is formed on pig slurry, as most of the dry matter of manure sinks to the bottom of the slurry tank. In the beginning some NH<sub>3</sub> is emitted from the surface layer, but later the impoverished surface layer blocks evaporation. Relatively little N is emitted and several sources reported about 5 – 15 % (average 10 %) evaporation from the deeper layers. Low evaporation is probably caused by the neutral pH-value. Stirring will obviously raise the dry matter to the surface and increase the evaporation of NH<sub>3</sub>, thereby causing peaks in air emissions.

As quantification is difficult, few emission data have been reported. In general, reference is made to emission factors (kg/head/yr) or percentages of N lost from manure during an average storage period.

Some storage techniques are listed in Table 3.36, together with their associated emission levels.

Species	Manure and slurry storage technique	Factor <i>kg/head/year</i>	Loss (%)
		NH <sub>3</sub>	NH <sub>3</sub>
Poultry	Open storage of solid manure	0.08	no data
Pig	Solid manure on a stack	2.1	20 – 25
	Storage of urine	no data	40 – 50
	Slurry in above ground tanks	2.1	10
	Slurry in earth banked lagoons	no data	10

**Table 3.36: Emission of NH<sub>3</sub> for different slurry storage techniques**  
[127, Italy, 2001]

### 3.3.4 Emissions from manure treatment

For various reasons manure is treated on farm and several techniques are described in Chapter 4, together with a report on their environmental and technical characteristics. As far as data were reported, consumption and emission levels were indicative and specific for the situation in which they were obtained.

Input levels of manure and slurry vary with the number of animals on the farm. Various additives are used to enhance chemical reaction(s) or to react with unwanted elements in the reaction substrate. These may affect emissions to water or air.

During the treatment processes, liquid fractions may be produced that have to be discharged to (surface) water. Odour may arise due to sub-optimal process conditions, although a number of techniques aim to reduce odorous components. Incineration emits dust and other flue gases. Techniques such as the biogas reactors deliberately form gaseous compounds, which can be used in heaters and engines but from which exhaust gases are then emitted.

### 3.3.5 Emissions from landspreading

The level of emissions from landspreading depends on the chemical composition of slurries and manures and the way they are handled. The composition varies and depends on the diet as well as on the method and duration of storage and the treatment, if any, applied before application. Values of N and  $K_2O$  will be lower for farmyard manure (FYM) stored for long periods in the open. Slurries may become diluted by drainage and wash-water thus increasing in volume, albeit with a decreasing dry matter content.

To obtain representative values of what is going to be landspread, multiple sampling is needed. The analysis includes dry matter (dm) content, total N, P, K, S, and Mg. Also ammonium-N is measured as well as nitrate-N in well-composted FYM and uric-acid-N in poultry manures. The levels are expressed per kg dm, or in kg per tonne for solid manures, or in kg per  $m^3$  for slurries.

Nitrogen is present in manures in mineral and organic forms. The mineral N, largely present as ammonium-N, is readily available for plants, and can be lost to the atmosphere as ammonia gas. Following conversion of ammonium to nitrate N in the soil, further losses may also occur through nitrate leaching and denitrification. [49, MAFF, 1999]

There are two major loss processes that reduce the efficiency of readily available manure N utilisation following land application and they are discussed in the sections below. They are:

- ammonia volatilisation
- nitrate leaching.

#### 3.3.5.1 Emissions to air

Many factors influence ammonia emissions into the air during landspreading, these are shown in Table 3.37.

Factor	Characteristic	Influence
Soil	pH	low pH gives lower emission
	cation exchange capacity of soil (CEC)	high CEC leads to lower emissions
	moisture level of soil	ambiguous
Climate factor	temperature	higher temperature gives higher emissions
	precipitation	causes dilution and better infiltration and therefore lower emissions to air, but increased emissions to soil
	wind speed	higher speed means higher emissions
	humidity of air	low levels give higher emissions
Management	application method	low emission techniques
	manure-type	dm-content, pH and ammonium-concentration affect emission level
	time and dose of application	warm, dry, sunny and windy weather should be avoided; too high doses increase infiltration periods

**Table 3.37: Factors influencing the emission levels of ammonia into air from landspreading [37, Bodenkundige Dienst, 1999]**

If FYM and poultry manure are left on the soil surface following land application, typically 65 % and 35 % of the readily available N they contain can be lost to the atmosphere as ammonia. In the case of slurries, the dm-content has an important influence on ammonia losses, e.g. a 6 % dm slurry typically loses 20 % more N than a 2 % dm slurry. [49, MAFF, 1999]

### 3.3.5.2 Emissions to soil and groundwater

A large amount of the nitrogen (N), phosphorus (P) and potassium (K) in livestock diets is excreted in manure and urine. Manures contain useful amounts of these plant-available nutrients, as well as other major nutrients such as sulphur (S), magnesium (Mg) and trace elements. For a number of reasons not all of these elements can be used and some may cause a pollution of the environment.

Two types of pollution can be distinguished: 'Point source' and 'Diffuse' pollution. Point source water pollution can occur through direct contamination of a watercourse from a burst or overflowing slurry store, yard run-off or immediately after landspreading and during heavy rain. 'Diffuse' pollution can affect water and air and, unlike point source pollution, is not easily seen. The resulting contamination is associated with farming practices over a wide area and over extended time periods, rather than a particular action or event, and may have long-term effects on the environment.

Of the agricultural emissions [5, VMM, 1996] to soil and groundwater, the most important are the residual emissions of N and P. The processes involved in the distribution of N and P are:

- for N – leaching, denitrification (NO<sub>2</sub>, NO, N<sub>2</sub>) and run-off
- for P – leaching and run-off
- also accumulation of N and P occurs in the soil.

In 1993/1994, the amount of manure produced by livestock production across MS, expressed in N-load, ranged from less than 50 kg N/ha (Greece, Spain, Italy, Portugal, Finland and Sweden) to over 250 kg N/ha (Belgium and the Netherlands). This load was due to the excess production of manure, in particular in areas where large numbers of pigs and poultry had been kept. The nitrogen surplus varied across MSs between -3 kg/ha (Portugal) and 319 kg/ha (the Netherlands). The surplus in Portugal was negative since the uptake of nitrogen by harvested

crops was assessed as exceeding the input levels that were available for plant growth. Manure production levels in Belgium, Denmark, Germany, Ireland, Luxembourg and the Netherlands in 1993/1994, exceeded the average level in the EU-15 for total livestock (61 kg N/ha). The average for pigs and poultry was about 15 kg N/ha (Table 3.38). On about 22 % of the area, levels exceed 100 kg N/ha, these areas had concentrated poultry and pig production. [77, LEI, 1999]

Over 1997, DG Environment reported on the amount of manure produced by livestock production, expressed in a total nitrogen production; see Table 3.38. The report showed that the main source of manure is not pigs and poultry, but the other animals (mainly bovine).

Member State	N-production per animal (%)			Total nitrogen (1000 tonnes)
	Pigs (%)	Poultry (%)	Others (%)	
Austria	20.3	4.7	75	158.6
Belgium	23.1	5.9	71	273.5
Denmark	39.0	3.6	57.4	241.8
Finland	15.4	2.9	81.7	81.5
France	8.4	10.1	81.5	1639.0
Germany	17.0	4.3	78.7	1288.5
Greece	4.1	8.0	87.9	201.7
Ireland	2.9	1.2	95.9	517.8
Italy	10.8	10.2	79	695.7
Luxembourg	4.3	0.2	95.5	14.1
Netherlands	22.8	9.4	67.8	490.9
Portugal	15.0	10.6	74.4	136.8
Spain	22.1	6.1	71.8	771.0
Sweden	13.8	4.2	82	141.3
United Kingdom	6.2	6.6	87.2	1132.6
EU-15	13.5	6.9	79.6	7784.9

**Table 3.38: Livestock manure nitrogen pressure (1997)**  
[205, EC, 2001], with reference to Eurostat, ERM, AB-DLO, JRC CIS

### 3.3.5.3 Emissions N, P and K to surface water

Emissions to the surface water are due to leaching and run-off. N-leaching is highest in winter and on sandy soils. This is more evident where landspreading of manure occurs in autumn and with empty fields in winter. P loss in surface run-off following manure application occurs when the soils infiltration capacity is exceeded, or when P attached to soil particles is eroded. It is most likely to occur if heavy rain follows application, or when the soil is already saturated [208, UK, 2001]. On soils with low organic matter content this will rarely occur.

### 3.3.5.4 Emissions of heavy metals

Heavy metals are, according to the common definition, metals that have a density larger than 5 g/cm<sup>3</sup>. Elements that belong to this group are the essential nutrients Cu, Cr, Fe, Mn, Ni and Zn, but also Cd, Hg and Pb, which are not essential. Beyond a certain concentration, which is species-specific, these elements become toxic for micro-organisms, animals and plants, but shortage can lead to deficiencies as well.

There are several sources responsible for the input of heavy metals into agricultural ecosystems, such as:

- indigenous sources, e.g. the weathering of rock
- atmospheric deposition
- manure application, pesticides and irrigation
- artificial fertiliser
- secondary material, such as waste water sludge, compost
- crumbling away of riverbanks
- feed import
- feed additives and animal medication.

In a German study on heavy metals in agriculture, the most important sources of heavy metals appeared to be atmospheric deposition (Cd, Pb, Zn), and organic fertilisers (Cr and Cd) and so-called “diffuse” emissions by manure (Cu, Zn and Ni).

Quantification is difficult and data are scarce. The following levels in pig and poultry manure were reported from a number of sources and are shown in Table 3.39 and Table 3.40. The number of analyses varied or wasn't reported. In some cases only two averages were reported. It is interesting that, particularly in pig manure, very high levels of copper and zinc were found, these were attributed to feed additives (Cu and Zn-salts).

Type of manure	Heavy metals (mg/kg dry matter)					
	Cd	Cr	Cu	Ni	Pb	Zn
Pig slurry	0.50 – 1.8	2.2 – 14.0	250 – 759	11 – 32.5	7.0 – 18.0	691 – 1187
Pig solid manure	0.43	11.0	740	13	-	1220
Layer manure (wet)	0.2 – 0.3	<0.1 – 7.7	48 – 78	7.1 and 9.0	6.0 and 8.4	330 – 456
Layer manure (dry)		-	32 and 50	-	-	192 – 300

**Table 3.39: Heavy metal concentrations in slurry and dry manure [101, KTBL, 1995]**

Type of manure	pH	kg/1000 kg dm	mg/kg dm					
			Cd	Cr	Cu	Ni	Pb	Zn
Pig slurry	8.5	94.2	0.60	12.1	603.0	23.4	<5	1285.0
Pig slurry	7.9	107.9	0.60	11.3	580.8	22.3	“	1164.0
Pig slurry	8.9	99.6	0.63	7.6	292.0	21.9	“	861.6
Pig slurry	7.5	68.5	<0.5	8.3	210.4	29.2	“	747.8
Pig slurry	6.9	95.3	<0.5	19.8	203.8	24.9	“	1447.0
Pig slurry	7.9	45.4	<0.5	8.3	290.0	22.0	“	955.3
Pig slurry	7.9	35.4	<0.5	14.3	720.5	26.7	“	2017.0
Pig slurry	8.4	40.5	0.86	12.3	1226.0	25.4	“	1666.0
Pig slurry	8.4	39.3	0.51	11.3	398.1	26.6	“	1159.0
Pig slurry	8.0	86.9	<0.5	12.4	258.1	22.9	“	1171.0
Layer manure	7.2	722.4	<0.5	<0.5	99.3	14.5	“	543.3
Layer manure	6.5	473.1	“	6.3	48.4	14.5	“	536.0
Broiler	6.4	540.1	“	<0.5	147.1	7.7	“	465.9
Broiler	6.0	518.0	“	“	132.4	16.5	“	454.2
Broiler	6.3	816.6	“	“	53.8	16.9	“	279.9

**Table 3.40: Heavy metal concentrations in slurry and dry matter [174, Belgium, 2001], with reference to Bodemkundige Dienst België, 2001**



These levels are considered to be the potential emission to land during land application. The relative contribution depends on the contribution of the other factors mentioned above. For the German situation, the heavy metal load as a result of the application of pig and poultry manure was estimated, see Table 3.41.

Type of manure	Heavy metals (g/ha/yr)						
	Output (10 <sup>6</sup> tonnes dm)	Cd	Cr	Cu	Ni	Pb	Zn
Pig slurry	1.6	0.09	0.9	38.15	1.76	1.01	88.33
Pig solid manure	2.0	0.05	1.3	87.32	1.53	0.00	143.95
Layer manure (wet)	0.3	0.00	0.14	1.07	0.14	0.13	7.01

**Table 3.41: Estimated average yearly contribution to heavy metal input through pig and poultry manure in Germany**  
[101, KTBL, 1995]

### 3.3.6 Emissions of odour

Emissions of odour originate from the activities described in the previous sections. The contribution of the individual sources to the total odour emission of an enterprise varies and depends on factors such as the general maintenance of the premises, the composition of the manure and the techniques used for handling and storage of the manure. Odour emission is measured in European odour units (OU<sub>e</sub>). As far as odour emissions have been reported, several sources quoted data from experiments with low-protein diets fed to pigs.

Emission	Low protein	“Normal” protein
Odour units (OU <sub>e</sub> per second)	371	949
H <sub>2</sub> S (mg per second)	0.008	0.021

**Table 3.42: Reported odour emission levels from pig slurry**  
Source: various comments TWG

### 3.3.7 Noise

Noise originating from intensive farming units is a local environmental issue and has to be considered particularly in those situations where units are located close to residential areas. On the farm, high noise levels can also affect the animals' condition and the production performance, as well as damaging the hearing capacity of farm personnel.

Equivalent continuous noise (L<sub>aeq</sub>) is the measure used to assess the noise levels of farms, since it makes it possible to compare noise sources of variable intensity or sources that are intermittent.

Typical site levels have not been reported. The equivalent noise level that arises from the site is a combination of the levels of the different activities listed in Table 3.43 and Table 3.44, together with a correction for the time duration. A different combination of activities will obviously lead to a different equivalent noise level.

Background noise is noise which may be experienced in the environment, for example, around a poultry unit. It consists of road traffic, birdsong, aircraft, etc. and may also include existing noises in the poultry unit.

In order to account for all the variable intermittent noises, the background noise level (L<sub>A90</sub>) is taken to be the noise level which is exceeded for 90 % of the time over a period of

measurement. Background noise varies over a 24-hour period as a result of changes in activities. In rural areas typical daytime background noise is 42 dB, but may fall below 30 dB in the early hours of the morning.

The final impact at sensitive objects in the neighbourhood depends on many factors. For instance, land surface, reflecting objects, construction of the receiving object and the number of noise sources determine the sound pressure level that is measured. In the following tables sound pressure levels have been given for only a few sources at the source or very close to it. The noise level at a sensitive object is normally lower further from the farm site.

The data must be seen as reported examples of what has been measured. Total noise levels will vary depending on farm management, the number and species of animals and the equipment used.

### 3.3.7.1 Sources and emissions on poultry farms

Sources of noise from poultry units are associated with:

- livestock
- housing
- feed production and handling
- manure management.

Typical sources of noise for a number of specific activities are shown in Table 3.43. Sound pressure levels are reported next to the source or at a short distance.

Noise Source	Duration	Frequency	Day/Night Activity	Sound pressure levels dB(A)	Equivalent continuous Laeq dB(A)
House ventilation fans	continuous/intermittent	all year	day and night	43	
Feed delivery	1 hour	2 – 3 times every week	day	92 (at 5 metres)	
Mill mix unit – inside building – outside building				90 63	
Gas fuel delivery	2 hours	6 – 7 times per year	day		
Emergency generator	2 hours	every week	day		
Catching chickens (broilers)	6 hours up to 56 hours	6 – 7 times per year	morning/night		57 – 60
Cleaning out (broilers)					
1. Manure handling	1 to 3 days	6 – 7 times per year	day		
2. Power washing etc.	1 to 3 days	year		88 (at 5 metres)	
Cleaning out (laying hens)					
1. Manure handling	up to 6 days	annually	day		
2. Power washing etc.	1 to 3 days			88 (at 5 metres)	

*L<sub>aeq</sub> equivalent continuous noise - unit for noise of variable intensity*

**Table 3.43: Typical sources of noise and example of noise levels on poultry units [68, ADAS, 1999] and [26, LNV, 1994]**

### 3.3.7.2 Sources and emissions on pig farms

Sources of noise from pig units are associated with:

- livestock
- housing
- feed production and handling
- manure management.

Typical sources of noise for a number of specific activities are shown in Table 3.44. Sound pressure levels are reported next to the source or at a short distance.

Description	Duration	Frequency	Day/Night Activity	Sound pressure levels dB(A)	Equivalent continuous Laeq dB(A)
Normal housing levels	continuous	continuous	day	67	
Feeding animals	1 hour	daily	day	93 99	87 91
• pigs					
• sows					
Feed preparation	3 hours	daily	day/night	90 (inside) 63 (outside)	85
Stock movement	2 hours	daily	day	90 – 110	
Feed delivery	2 hours	weekly	day	92	
Cleaning and manure handling	2 hours	daily	day	88 (85 – 100)	
Manure spreading	8 hours/day for 2 – 4 days	seasonal/weekly	day	95	
Ventilation fans	continuous	continuous	day/night	43	
Fuel delivery	2 hours	fortnightly	day	82	

**Table 3.44: Typical sources of noise and examples of noise levels on pig units [69, ADAS, 1999] and [26, LNV, 1994]**

### 3.3.8 Quantification of other emissions

The amounts and composition of waste that arise from poultry and pig farms vary considerably. No representative data of the categories identified in Section 2.10 have been reported. Data estimated on a national scale have been reported by the UK [147, Bragg S and Davies C, 2000].

A waste stream of about 44000 tonnes per year of packaging waste is generated by farms, of which 32000 tonnes is plastic (polyethylene and polypropylene).

The waste water emission is difficult to measure, as it is often part of the slurry fraction. The amounts of dirty water vary with rainfall and cleaning water used. The BOD levels are reported to be 1000 – 5000 mg/l [44, MAFF, 1998].

In summary, emission data for intensive livestock enterprises under natural farming conditions are either scarce or were not available to incorporate in this document. Most data concern ammonia emissions to air or potential emissions from manure to soil and groundwater. Measuring emissions from intensive livestock enterprises is difficult and requires clear protocols to be able to compare data collected in different Member States and under different production circumstances.



## 4 TECHNIQUES TO CONSIDER IN THE DETERMINATION OF BAT

This chapter describes the techniques that are considered to be most relevant for determining BAT. It provides the background information for determining best available techniques in the intensive livestock farming sectors within the scope of IPPC (Chapter 5). However, it is not exhaustive and other techniques or combinations of techniques may be applied as well. Techniques that are generally seen as obsolete are not included. Moreover, it does not include all the systems and techniques that are applied on intensive livestock farms and that are described in Chapter 2.

Each section in this chapter describes systems or techniques, following the same order as in Chapters 2 and 3. However, it has not been possible to identify alternative reduction techniques for every technique that is applied on-farm. As far as possible, production systems and techniques will be described using the format as shown in Table 4.1.

Section	Type of information
Description	Technical description (if not already included in Chapter 2).
Achieved environmental benefits	Main environmental impact(s) to be addressed including emission values achieved and efficiency performance. Environmental benefits of the technique in comparison with others.
Cross-media effects	Any negative side-effects and disadvantages to other media caused by application of the technique. Environmental problems of the technique in comparison with other techniques and how to prevent or solve them.
Operational data	Performance data on consumption (raw materials, water and energy) and emissions/wastes. Other useful information on how to manage, maintain and control the technique, including animal welfare aspects.
Applicability	Consideration of how the technique may be used in practice and any limitations to its use.
Costs	Information on costs (annual investment and operation) and any savings (e.g. reduced consumption, waste charges).
Driving force for implementation	Local conditions or requirements which lead to implementation. Information on reasons other than environmental ones for implementation (e.g. consumer market, animal welfare, financial schemes, etc.).
Reference farms	Farms applying the system in Europe or in a Member State. If a technique has not yet been applied in the sector in Europe or elsewhere, a brief explanation is given.
Reference literature	Literature for more detailed information on the technique.

**Table 4.1: Information provided for each technique included in Chapter 4**

As described in Chapters 1 – 3, the main emphasis in the application of environmental measures in intensive farming is on the reduction of emissions associated with manure production. Techniques that can be applied at different stages of the process are linked. It is clear that the application of reduction measures in the early steps of the animal production chain can influence the effect (and efficiency) of any reduction measures applied in later steps. For example, the nutritional composition of the feed and the feeding strategy are important for the animals' performance, but at the same time they affect the manure composition and therefore influence emissions to air, soil and water from housing, storage and landspreading. The IPPC-directive puts the emphasis on prevention; hence this chapter discusses the effects of nutritional management first, followed by integrated or end-of-pipe techniques.

It is important to note that the performance of a reduction technique is closely linked with the way in which it is operated and simply applying a reduction measure may not achieve the highest achievable reduction. This chapter therefore begins with a description of the elements of good practice for environmental management, before paying more specific attention to technical measures for emission reduction. Aspects of good agricultural practice have been summarised in [105, UK, 1999] and [107, Germany, 2001] and are presented in Section 4.1.

Whenever possible, this chapter provides information from techniques that can be, or are already being implemented on farms, including information on associated costs and the context in which the technique can be used effectively.

### 4.1 Good agricultural practice for environmental management

Agriculture, food production and the use of the countryside are of interest and importance to everyone. Organisations of all kinds are increasingly concerned to achieve and demonstrate sound environmental performance. All organisational activities, products and services interact with and affect the environment and are linked to the health and safety of both the farmer and the animals, and to all the farm operational and quality management systems. In short, good farming management means aiming for a sound environmental performance, which has been shown to be closely linked to increased animal productivity.

The key to good practice is to consider how activities on pig and poultry farms can affect the environment and then to take steps to avoid or minimise emissions or impacts by selecting the best mix of techniques and opportunities for each site. The aim is to put environmental considerations firmly into the decision making process. A business that demonstrates good practice will take into account issues such as education and training, proper planning of activities, monitoring, repairs and maintenance, emergency planning and management. Managers should be able to provide evidence that a system is in place to take account of these issues, many of which are referred to in (so-called) “Codes of Good Practice” developed by (some) Member States [45, MAFF, 1998; 43, MAFF, 1998; 44, MAFF, 1998], [106, Portugal, 2000] and [109, VDI, 2000]. Such action is consistent with many of the steps taken by some businesses aiming for formal accreditation under a recognised Environmental Management System.

Each of the various activities that make up farm management can potentially contribute to the overall achievement of good environmental performance. It is therefore important that someone be identified and given the responsibility to manage and oversee these activities. In larger enterprises in particular, that someone may not necessarily be the owner, but a farm manager, who has to make sure that:

- site selection and spatial aspects are considered
- education and training exercises are identified and implemented
- activities are properly planned
- inputs and waste are monitored
- emergency procedures are in place, and
- a repair and maintenance programme is implemented.

The manager and staff should regularly review and evaluate these activities so that any further development and improvements can be identified and implemented. An appraisal of alternative, new or emerging techniques would be beneficial at this stage.

### 4.1.1 Site selection and spatial aspects

Often the environmental impact of farms is partly due to an unfavourable spatial arrangement of activities on the farm-site. This can lead to unnecessary transport and additional activities, and to emissions close to sensitive areas. Good farming management can compensate for this to a limited extent, but is made easier if attention is paid to spatial planning of farm activities.

The evaluation and selection of a location for a new livestock farming facility, or the planning of a new installation on an existing site, can be considered as part of good farming practice, if:

- unnecessary transport and additional activities are minimised or eliminated
- adequate distances are maintained in respect of sensitive sites requiring protection, e.g. maintaining adequate distances from neighbours to avoid conflicts arising from odour nuisance
- the potential future development capability of the farm is taken into consideration
- any requirements of outline construction planning or village development planning are satisfied.

Apart from the technical appraisal, the evaluation would also consider local meteorological conditions as well as any specific topographic features, such as hills, ridges and rivers [107, Germany, 2001].

For example, for mixed livestock or pig breeding facilities, the low-emission production areas could be located closer to critical sensitive sites whilst housings producing higher emissions may be located further away from those same locations.

Ambient air pollution can be avoided at sensitive sites by effectively arranging, relocating or grouping emission sources, such as in central waste air shafts. For example, it may be possible to increase the distances of the emission source to any critical sensitive sites, or to relocate the sources so that they lie in a subsidiary wind direction, or to discharge waste air through ducting pipelines appropriate distances away [159, Germany, 2001].

### 4.1.2 Education and training

Farm staff should be familiar with production systems and properly trained to carry out the tasks for which they have responsibility. They should be able to relate these tasks and responsibilities to the work and responsibilities of other staff. This can lead to a greater understanding of the impacts on the environment and the consequences of any equipment malfunction or failure. However, staff may require extra training to monitor these consequences. Regular training and updating may be required, particularly when new or revised working practices or equipment are introduced. Development of a training record could provide a basis for a regular review and evaluation of each person's skills and competencies.

### 4.1.3 Planning activities

Many activities can benefit from being planned, to ensure that they run smoothly and carry reduced risks of unnecessary emissions. An example would be the application of slurry to land. This involves a number of tasks or actions that need to be co-ordinated, including:

- assessing the land receiving slurry to identify the risk of causing run-off to watercourses and then deciding whether to spread
- avoiding weather conditions in which the soil could be seriously damaged, as this could have significant knock-on environmental effects
- agreeing safe distances from watercourses, boreholes, hedges and neighbouring properties
- identifying an appropriate application rate
- checking that machinery is in good working order and properly set at the correct application rate
- agreeing travel routes to avoid bottlenecks
- ensuring that there is adequate access to the slurry store and that loading can be done effectively, i.e. by checking the operation of pumps, mixers and sluice gates or valves
- assessing the spread areas at regular intervals to check for any sign of run-off
- ensuring that all staff know what action to take if something goes wrong.

Other activities that will benefit from a planned approach include the delivery of fuel, feed, fertiliser and other materials to site (inputs), production processes, and the removal of pigs, poultry, eggs, other products and waste materials from the site (outputs). Sub-contractors and suppliers also need to be properly briefed.

### 4.1.4 Monitoring

It is essential to understand the level of use of inputs and the creation of waste in order to consider whether and how changes may be made to improve profitability and to benefit the environment. Regular monitoring of water usage, energy usage (gas, electricity, fuel), amounts of livestock feed, waste arising and field applications of inorganic fertiliser and manure will form the basis for review and evaluation. Where possible, the monitoring, review and evaluation should be related to groups of livestock, specific operations or done on a field-by-field basis, as appropriate, to give the best chance of identifying areas for improvement. Also, monitoring should help in identifying abnormal situations and enable the appropriate actions to be taken.

The mineral bookkeeping system, applied in the Netherlands, is an example of how monitoring the input and output flows of minerals at a farm level can help to reduce mineral surpluses and ammonia losses. This allows Dutch agriculture to comply with the objectives and obligations of the Nitrates Directive [77, LEI, 1999].

### 4.1.5 Emergency planning

A contingency plan can help the farmer to deal with unplanned emissions and incidents such as the pollution of water, if they occur. This may also cover any fire risks and the possibility of vandalism. The contingency plan should include:

- a plan of the farm showing the drainage systems and water sources
- details of equipment available on the farm, or available at short notice, which can be used to deal with a pollution problem (e.g. for plugging land drains, damming ditches, or scum boards for holding oil spillages)
- telephone numbers of the emergency services and regulator(s) and others, such as downstream landowners and water abstractors
- plans of action for certain potential events, such as fires, leaking slurry stores, collapsing slurry stores, uncontrolled run-off from manure heaps, and oil spillages.

It is important to review procedures after any incident to see what lessons can be learned and what improvements implemented.



### 4.1.6 Repair and maintenance

It is necessary to check structures and equipment to ensure that they are in good working order. Identifying and implementing a structured programme for this work will reduce the likelihood of problems arising. Instruction books and manuals should be made available and staff should receive appropriate training.

All measures that contribute to the cleanliness of the facility help to achieve a reduction of emissions. These include drying and cleaning the feed store, the dunging, exercise and lying areas, the general and dunging passages, the housing facilities and equipment, and the outlying areas around the housing. Drinking water losses can be avoided by employing low-loss drinking techniques (e.g. nipple drinkers with drip cups in poultry keeping).

Livestock buildings may have insulation, fans, cowls, back-draught shutters, temperature sensors, electronic controls, failsafe arrangements, water supply and feed supply arrangements, and other mechanical or electrical mechanisms which require regular checking and maintenance.

Slurry stores could be checked regularly for any signs of corrosion or leakage and any faults need to be corrected, with professional help if necessary. Stores should preferably be emptied at least once a year, or as frequently as justifiable depending on the quality of the construction and the sensitivity of the soil and groundwater, so that both internal and external surfaces can be checked and any structural problems, damage or degradation put right. In some situations where visual inspection of such constructions is limited it is advisable to monitor the groundwater as an indicator of leakages.

Operating manure spreaders (for both solid and liquid manures) can be improved if they are cleaned and checked after periods of use and any repairs or refurbishment carried out. Regular checks should be made during operational periods and appropriate maintenance carried-out as described in the manufacturers' instructions.

Slurry pumps, mixers, separators, irrigators and control equipment will require regular attention and manufacturers' instructions should be followed.

It is sensible to have a supply of the faster-wearing parts available on-farm in order to carry out repairs and maintenance quickly. Usually routine maintenance can be carried out by suitably trained farm staff but more difficult or specialist work will be carried out more accurately by professional help.

## 4.2 Nutritional management

### 4.2.1 General approach

**Description:** Reducing the excretion of nutrients (N, P) in manure can reduce emissions. Nutritional management covers all techniques to achieve this reduction. The aim is to meet the animals' needs by improving the digestibility of the nutrients and by balancing the concentration of the different essential components with the undifferentiated N-components in order to improve the efficiency of the body's protein synthesis. The techniques try to aim for a practical minimum level of required nutrients (in particular N and P) in feed. Ideally, the excretion levels obtained would then be as low as the natural excretion levels from metabolic processes in the animal which cannot be avoided. In other words, nutritional measures aim to reduce the amount of nitrogen waste from undigested or catabolised nitrogen, which is subsequently eliminated through urine. Two types of techniques can be distinguished and these are:

1. Improving the feed characteristics, e.g. through the:
  - application of low protein levels, use of amino acids and related compounds
  - application of low phosphorus levels, use of phytase and/or digestible inorganic phosphate
  - use of other feed additives
  - sensible application of growth promoting substances
  - increased use of highly digestible raw materials.
2. Formulating a balanced feed with an optimum feed conversion ratio based on digestible phosphorus and amino acids (following the ideal protein concept). [172, Denmark, 2001] [173, Spain, 2001]

Most attention has been given to increasing the digestion of feed, and consequently large quantities of enzymes are used nowadays in the animal feed industry.

Reduction can also be achieved by using different diets during growing/production periods matching the animals' changing requirements (phase feeding).

The combination of both types of techniques is, in practice, the most efficient way to reduce the pollution load. Some of the above-mentioned options have already been successfully implemented, such as phase feeding, but others still need further investigation. Many published studies have illustrated the effects of feed measures and reduced N-intake on the amount of excreted N and their ability to reduce NH<sub>3</sub>-emissions. The information exchange focused on nutritional management for both pigs and poultry, although more data were reported for pigs than for poultry.

**Achieved environmental benefits:** Both, in pig and poultry a 1 %-point protein reduction, e.g. from 18 to 17 %, leads to a 10 % reduction in nitrogen output and ammonia production (see also Table 4.9). Though fewer poultry than pig studies have been carried out evaluating the substitution of supplemented amino acids for intact protein, the data is consistent and shows its feasibility. However given the current level of knowledge available today the scope for substitution is somewhat more restricted in poultry than in pigs. [171, FEFANA, 2001]

Progress in genetics and nutrition has already shown a considerable improvement in the efficient use of feed. The improved utilisation of feed increases the possibilities for reducing feed nitrogen input and reducing N-excretion even further.

For example, in a summary of experimental results, it was reported that low-protein rations (17 %) fed to broilers compared to current use of feed (21 %) showed a considerable reduction of N-excretion, but that this needed compensation with synthetic amino acids due to the increased N-retention (32 %). At the same time, a higher fat level and a reduced N-level was observed in the manure.

Low phosphorus levels in feed can reduce the phosphate levels in the manure. In order to increase digestibility, phytase is added to the feeds (see Section 4.2.4). Also highly digestible inorganic feed phosphates are available and their effects are described in Section 4.2.5.

In general, experience so far shows that considerable reductions in N and P can be achieved. The minimum levels of N- or P- output will vary among different European agricultural regions due to differences in farm practices, species used and nutritional management.

In order to illustrate the achievable reduction levels of excretion of nitrogen and diphosphorus pentoxide, excretion levels under standard conditions (Table 4.2 and Table 4.3) are compared with those achieved by applying reference feeding programmes. The results are shown in Table 4.4 and Table 4.5.

Animal species	Belgium (kg/place/year)	France <sup>1</sup> (g/animal)	Germany <sup>2</sup> (kg/place/year)
Piglets	2.46	440	4.3
Growers/Finishers	13	2880 – 3520	13.0
Boars and sows	24	16.5 kg/place/year	27 – 36
Broilers	0.62	25 – 70	0.29
Laying hens	0.69	0.45 – 0.49 kg/place/year	0.74
Turkeys	2.2	205	1.64
1: 25 % gaseous losses in building and 5 % gaseous losses during storage are already deducted from N excretion. Losses during spreading are not included here.			
2: 10 % gaseous losses during storage and 20 % gaseous losses during spreading to be deducted from this N excretion.			

**Table 4.2: Standard levels of nitrogen (N) excretion in Belgium, France and Germany [108, FEFANA, 2001]**

Animal species	Belgium (kg/place/year)	France (kg/animal)	Germany (kg/place/year)
Piglets	2.02	0.28	2.3
Growers/Finishers	6.5	1.87 – 2.31	6.3
Boars and sows	14.5	14.5 kg/place/year	14 – 19
Broilers	0.29		0.16
Laying hens	0.49		0.41
Turkeys	0.79		0.52

**Table 4.3: Standard levels of excretion of diphosphorus pentoxide (P<sub>2</sub>O<sub>5</sub>) in Belgium, France and Germany [108, FEFANA, 2001]**

Animal species	France CORPEN 1 %	France CORPEN 2 %	Germany RAM %
Piglets	- 9	-18	-14
Finishers	-17	-30	-19
Boars and sows	-17	-27	-19 to -22
Broilers			-10
Turkeys			- 9
Laying hens			- 4

**Table 4.4: Percentage reduction in nitrogen (N) output obtained with the reference feeding programmes compared to the standard level of excretion in France and Germany [108, FEFANA, 2001]**

Animal species	Belgium %	France CORPEN 1 %	France CORPEN 2 %	Germany RAM %
Piglets	-31	-11	-29	-22
Finishers	-18	-31	-44	-29
Boars and sows	-19	-21	-35	-21
Broilers	-38			-25
Turkeys				-36
Laying hens	-24			-24

**Table 4.5: Percentage reduction in diphosphorus pentoxide (P<sub>2</sub>O<sub>5</sub>) output obtained with the reference feeding programmes compared to the standard level of excretion in Belgium, France and Germany [108, FEFANA, 2001]**

**Cross-media effects:** Nutritional management is the most important preventive measure to reduce the pollution load, either by limiting excess nutrient intake and/or improving the nutrient utilisation efficiency of the animal. Reduced mineral output and changes in the structure and characteristics of the manure (pH, dry matter-content) affect the N-emission levels from housing, storage, and application and reduce the polluting load for soil, water, and air, including odours.

However it should be mentioned that genetic selection towards better feed-conversion is also linked with an increasing growth rate. High growth rate may lead to increase lameness in broiler chickens as to systematic underfeed parent breeds (ad libitum feeding of parents create reproductive difficulties). As a consequence a balance need to be obtained between better growth rate and potential welfare problems.

**Operational data:** For each of the three countries (Belgium, France, Germany), the reductions were obtained whilst applying a set of predefined and standardised nutritional specifications (Table 4.7). In Belgium, 3 types of feeds were defined:

1. low-nitrogen feed
2. low-phosphorus feed
3. low-nitrogen-and-phosphorus feed.

The low-phosphorus feed is legally recognised through a contract between feed manufacturers and the government [174, Belgium, 2001].

In Germany, the RAM-feeding programmes of low-nitrogen-and-phosphorus feeds were developed by farmers and feed manufacturers. They also rely on contracts that are controlled by the regional agricultural chambers.

In France, CORPEN recommends a 2-phase feeding programme for each physiological stage (e.g. creep/piglet, lactating/gestating sows, grower/finisher pigs) based on low-protein and/or low-phosphorus diets.

If the feeding system is different from and/or more efficient than the nutritional specifications used, "regression" systems allow the actual level of excretion to be calculated as a function of the feed characteristics (protein and/or phosphorus contents). By example, the set of equations used in Belgium is reported in Table 4.6. In France, the "simplified accounting balance" takes into account the main factors involved in pig excretion, i.e. feeding technique and level of performance. It has been published as a calculation sheet and as a computer model.

Animal species	Nitrogen (N) bruto-excretion (kg/animal/year)	Diphosphorus pentoxide (P <sub>2</sub> O <sub>5</sub> ) excretion (kg/animal/year)
Piglets weighing from 7 – 20 kg	$Y = 0.13 X - 2.293$	$Y = 2.03 X - 1.114$
Other pigs weighing from 20 – 110 kg	$Y = 0.13 X - 3.018$	$Y = 1.92 X - 1.204$
Other pigs weighing more than 110 kg	$Y = 0.13 X + 0.161$	$Y = 1.86 X + 0.949$
Sows, including piglets with a weight <7 kg	$Y = 0.13 X + 0.161$	$Y = 1.86 X + 0.949$
Boars	$Y = 0.13 X + 0.161$	$Y = 1.86 X + 0.949$
Laying hens (including breeders-laying hens)	$Y = 0.16 X - 0.434$	$Y = 2.30 X - 0.115$
Growing pullets laying hens	$Y = 0.16 X - 0.107$	$Y = 2.33 X - 0.064$
Broilers	$Y = 0.15 X - 0.455$	$Y = 2.25 X - 0.221$
Broiler breeders	$Y = 0.16 X - 0.352$	$Y = 2.30 X - 0.107$
Growing pullets of broiler breeders	$Y = 0.16 X - 0.173$	$Y = 2.27 X - 0.098$
<i>Y = production (kg) of N and P<sub>2</sub>O<sub>5</sub> per animal and per year</i>		
<i>X = consumption (kg) of crude protein (CP) and phosphorus (P) per animal per year</i>		

**Table 4.6: Regressions used in Belgium to calculate the actual level of excretion [108, FEFANA, 2001]**

Animal		Belgium MAP	France CORPEN 1	France CORPEN 2	Germany RAM
<b>Piglets</b>	strategy	(7 – 20 kg): low-phosphorus feed	2-phase feeding	2-phase feeding	
	crude protein		creep: 20.0 % piglet (<28 kg): 18.0 %	creep: 20.0 % piglet (<28 kg): 17.0 %	piglet (<30 kg): 18.0 %
	phosphorus	(7 – 20 kg): 0.60 %	creep: 0.85 % piglet (<28 kg): 0.70 %	creep: 0.77 % + phytase piglet (<28 kg): 0.60 % + phytase	piglet (<30 kg): 0.55 %
<b>Growers Finishers</b>	strategy	2-phase feeding	2-phase feeding	2-phase feeding	2-phase feeding
	crude protein		grower (28 – 60 kg): 16.5 % finisher (60 – 108 kg): 15.0 %	grower (28 – 60 kg): 15.5 % finisher (60 – 108 kg): 13.0 %	grower (<60 kg): 17.0 % finisher (>60 kg): 14.0 %
	phosphorus	grower (20 – 40 kg): 0.55 % finisher (40 – 110 kg): 0.50 %	grower (28 – 60 kg): 0.52 % finisher (60 – 108 kg): 0.45 %	grower (28 – 60 kg): 0.47 % + phytase finisher (60 – 108 kg): 0.40 % + phytase	grower (<60 kg): 0.55 % finisher (>60 kg): 0.45 %
<b>Sows</b>	strategy	low-phosphorus feed	2-phase feeding	2-phase feeding	2-phase feeding
	crude protein		lactation: 16.5 % gestation: 14.0 %	lactation: 16.0 % gestation: 12.0 %	lactation: 16.5 % gestation: 14.0 %
	phosphorus	0.60 %	lactation: 0.65 % gestation: 0.50 %	lactation: 0.57 % + phytase gestation: 0.42 % + phytase	lactation: 0.55 % gestation: 0.45 %
<b>Broilers</b>	strategy	2-phase feeding			
	crude protein				starter (1 – 10 days): 22.0 % grower (11 – 29 days): 20.5 % finisher (30 – 40 days): 19.5 %
	phosphorus	grower (<2 weeks): 0.60 % finisher (>2 weeks): 0.55 %			starter (1 – 10 days): 0.70 % grower (11 – 29 days): 0.55 % finisher (30 – 40 days): 0.50 %
<b>Layers</b>	strategy	low-phosphorus feed			
	phosphorus	0.50 %			
<i>MAP</i>		<i>Manure Action Plan (legislation since March 2000)</i>			
<i>CORPEN</i>		<i>French committee studying options for reduction of N and P pollution by agriculture</i>			
<i>RAM</i>		<i>German abbreviation for crude protein adapted feed</i>			

**Table 4.7: Nutritional management in Belgium, France and Germany: characteristics of reference feeds**

**Applicability:** Nutritional management systems are already in place in some Member States and are backed up by practical experience.

- **Monitoring the nutrient input and output**

In those areas where intensive livestock production is responsible for high environmental pressure, farmers have to keep a register of their nitrogen and/or phosphate applications. The "mineral book-keeping systems" monitor the input and output flows at farm level. Examples of regulatory tools are: the Act on Classified Installations for Environmental Protection (ICPE) in France, the Manure Action Plan (MAP) in Belgium, the MINeral Accounting System (MINAS) in the Netherlands, and the Düngerverordnung in Germany.

- **Estimation of mineral output from the slurry on the basis of the feed characteristics**

As mineral output is highly correlated with mineral intake, it should be calculated based on the characteristics of the feeds, as is done in those Member States where nutritional management systems are already being implemented. Indications of the systems used in France (CORPEN), Belgium (MAP) and Germany (RAM) are given in the section on Achieved environmental benefits.

**Costs:** Assessing the costs and benefits of nutritional measures aimed at reducing emissions from intensive livestock farming is complex. The potential economic and environmental benefits of such management measures in reducing nitrogen pollution have been evaluated in a recent report by the Dutch Agricultural Economics Research Institute [77, LEI, 1999]. It evaluates the effect of current and future European policy changes on nitrogen pollution levels at national, regional and farm level using different predictive models and comparing similar approaches.

It draws attention to the fact that, where dietary protein levels decrease with increasing cereal use in feed, then the changes in cereal price are important for the sustainability of the nutritional management measures. In that respect much is expected of the effects of the CAP reforms. However, the EU-determined cereal price is not independent, but has a price relationship with soya, the price of which is set on the world market. These cost levels affect the economic viability of the nutritional management measures, such that low soya prices can lead to high dietary protein levels. With successive CAP-reforms, the inclusion of higher levels of cereals has been favoured and the cost of implementing reduced protein diets compared with current norms has decreased accordingly (Table 4.8).

	Pigs		Poultry	
	Current diet	Reduced protein diet	Current diet	Reduced protein diet
<b>Index of costs</b>				
CAP-1988	100	103	100	101
CAP-1994	89	92	88	88
CAP-2000	73	74	74	74
<b>Index of N content in feed (kg N/tonne feed)</b>				
CAP-1988	100	85	100	96
CAP-1994	97	83	99	95
CAP-2000	88	83	96	93

**Table 4.8: Index of costs for compound feed and nitrogen content according to feeding management [77, LEI, 1999]**

It can be concluded that 'applying preventive nutritional management as a means of reducing nitrogen output at the farm level is economically competitive with the downstream processing of excess manure.' The report considers that rules for manure application are expected to become stricter and treatment of excess manure will become more costly.

In some areas, except for Flanders and the Netherlands, increasing cereal use may be sufficient to reduce the dietary protein to levels that are manageable at a regional level. Additional nutritional management measures will remain beneficial to those intensive livestock holdings that have insufficient land to utilise their manure.

Also the European Federation of Animal Feed Additive Manufacturers, FEFANA, has the opinion that the cost and affordability of the feeding measure depends on the local commodity supply (as cereals affordability), the local land availability for spreading manure (limited availability will enhance the value of the feeding measure), and the world market price for protein-rich feedstuffs (a high price for protein-rich feedstuffs increases the affordability of the feeding measure). Expected world market and EU market trends towards lower prices of cereals, higher prices for protein feedstuffs such as soybean meal, and the availability of increasing amounts of industrial amino acids, all tend to reduce the cost of the feeding measure to control nitrogen emissions from animal production. However, it is not feasible to calculate a single cost figure for evaluating the cost associated with the feeding measures, because the market fluctuations in feedstuff prices are too large to derive a universal estimate. However, as a general rule one can assume that the extra feed cost in pigs and poultry will range from 0 to 3 % of the total feed cost. (FEFAC estimates an increase by 2 – 3 % for poultry and 1 – 1.5 % for fattening pigs [169, FEFAC, 2001]). In periods of extremely low prices of soybean meal, the extra feed cost may increase by up to about 5 %. [171, FEFANA, 2001]

**Driving force for implementation:** The application of nutritional measures is largely influenced by the market prices of grain and soya. A driving force could be the potential cost savings, where nutritional measures may reduce the need to apply later techniques that are aimed at emissions reductions from animal housing, manure storage and application.

**Reference farms:** Many farms located in Nitrate Vulnerable Zones (according to the Nitrate Directive), such as in Brittany, the Netherlands, Belgium and Germany already comply with some nutritional constraints in order to control their pollution load. [171, FEFANA, 2001]

In France, since the publication of CORPEN recommendations for pigs in 1996, 2 phase-feeding with low protein feeds has been much developed, especially for sows. It is reported that by the end of 1997 nearly one third of fattening pigs and nearly 60 % of all sows were fed this way. [169, FEFAC, 2001] (with reference to AGRESTE Bretagne number 27, June 1998)

**Reference literature:** [28, CORPEN, 1996; 29, CORPEN, 1996; 30, CORPEN, 1997], [[37, Bodemkundige Dienst, 1999], [77, LEI, 1999], [81, Adams/Röser, 1998], and [108, FEFANA, 2001].

## 4.2.2 Phase feeding

**Description of phase feeding for poultry:** For poultry, different feeding strategies have been developed which aim at hitting the right balance between energy and amino acid requirements or which aim to influence the nutrient uptake through an improved passage of the feed through the birds' digestion channel.

Phase feeding for layers is a method of feeding which involves adjustment of the levels of Ca and P in the different production stages. A uniform group of animals and a gradual transition from one feed to the next is required.

For broilers, phase feeding is currently applied in some EU countries. This involves dividing their requirements into three phases in which the broilers show a considerable change in their nutritional requirements. In each phase the aim is to optimise the feed conversion ratio (FCR). Applying a slightly restricted feeding regime in the first phase results in a more efficient growth at a later stage. Proteins and amino acids must be fed at a high level and balanced. In Phase 2 the digestive capacity of the bird will have improved so that more feed with a higher energy

content can be fed. In Phase 3, the protein and amino acid content decreases again, but the amount of energy remains the same. In all phases, Ca-P balance remains the same, but the total concentration in the feed decreases.

Compared with broilers, turkeys require large amounts of feed. Their requirements in the different phases vary in the same way as those of broilers. The required concentration of proteins and amino acids decreases with increasing age, but the required feed energy increases. Depending on the type of turkey produced the number of phases applied can vary, with 4 to 5 being normal practice. For instance, in the Netherlands a 5-phase feeding is applied, which means five different feeds, although more phases can be distinguished and rations are adapted accordingly. For turkeys, the shape in which the feed is offered influences the FCR and the growth. Tests have shown that pellets show better FCR and growth than meal.

**Description of phase feeding for pigs:** Phase feeding for pigs consists in successively giving 2 to 4 feeds for pigs with weights 25 kg until 100 – 110 kg (slaughter weight). Feeding programmes vary among countries. The 2-phase feeding programme (25 – 60 kg and 60 – 110 kg) is rather well developed but could be further developed, to include environment concerns as well as economical value. Italian feeding programmes differ substantially from those of other EU countries, because they work with much higher slaughter weights (140 – 150 kg).

Multiphase feeding for pigs consists in providing pigs with a mix of preparations that match the animal requirements of amino acids, minerals and energy. This is achieved by mixing a high nutrient feed with a low nutrient feed, on a regular basis (from daily to weekly). Further developments in multiphase feeding are pending relating to farm equipment for silos and distribution lines. [171, FEFANA, 2001].

Trials with 5-phase low CP/DE (Crude Protein/Digestible Energy) diets for growers/finishers have been done in the UK, which showed in a consistent trend that total nitrogen and ammonium-N in slurry from pigs were reduced compared to levels resulting from the commercial two-diet feeding strategy [110, MAFF, 1999] [111, MAFF, 1999].

For sows, phase feeding consists in giving at least 2 different feeds: one for lactation and one for gestation. Feeding the sow differently in gestation and in lactation is rather well developed across Europe. In some cases, a specific feed might be given before farrowing. [171, FEFANA, 2001]

### **Achieved environmental benefits for:**

- **Broilers:** The application of phase feeding to broilers has been reported as giving a 15 - 35 % reduction in N excreted.
- **Finishers:** Three-phase feeding to finishers reduced nitrogen (3 %) and phosphate (5 %) excretion. Multiphase feeding leads to an extra reduction in excretion of N (5 – 6 %) and of P<sub>2</sub>O<sub>5</sub> (7 – 8 %).
- **Sows:** For sows, the application of 2-phase feeding can lead to a reduction of N-excretion (7 %) and of P<sub>2</sub>O<sub>5</sub>-excretion (2 %), compared to no phase feeding.

**Cross-media effects:** The primary effect of phase feeding is a reduction in the excretion of nutrients (N and P). Reduced levels further contribute to a reduction in emissions from housing and external manure storage. At the same time, water usage and slurry volume can be reduced.

**Applicability:** It has been reported that multi-phase feeding for pigs requires sophisticated and expensive equipment for dry feeding and so is best employed in large scale production enterprises. In practical terms, three-phase feeding may be the most feasible option for growers/finishers. [77, LEI, 1999]



Multiphase feeding is also possible with liquid feeding systems, and indeed liquid feeding systems are increasingly becoming more popular. However, multiphase feeding can be rather complicated to implement in a continuous flow system, such as that normally used in small farms. [173, Spain, 2001]

A computerised system makes it possible to automatically deliver the proper mix of high nutrient feed and low nutrient feed at the requested intervals. Applying such a system requires qualified personnel. [173, Spain, 2001].

**Costs:** No cost data have been reported. However, the costs associated with multiphase feeding are expected to be higher than those for phase-feeding, as, for example, additional costs may need to be included for additional storage facilities for the different feeds and for mixing facilities. [173, Spain, 2001] [171, FEFANA, 2001]

**Reference literature:** [26, LNV, 1994] [27, IKC Veehouderij, 1993] [77, LEI, 1999] [110, MAFF, 1999] [111, MAFF, 1999]

### 4.2.3 Addition of amino acids to make low-protein, amino acid-supplemented diets for poultry and pigs

**Description:** This technique is most often referred to in the literature. The principle is to feed animals with the appropriate level of essential amino acids for optimal performance whilst limiting excess protein ingested (Figure 4.1). The formulation of low-protein diets requires reducing the incorporation of protein-rich feedstuffs (like soya bean meal) whilst balancing the diets with amino acids supplements. Some commercially available and registered amino acids are lysine (L-Lysine), methionine (DL-Methionine and analogues), threonine (L-Threonine) and tryptophan (L-Tryptophan). Other essential amino acids are likely to be developed in the future, which might facilitate a further decrease in dietary protein content. [108, FEFANA, 2001]

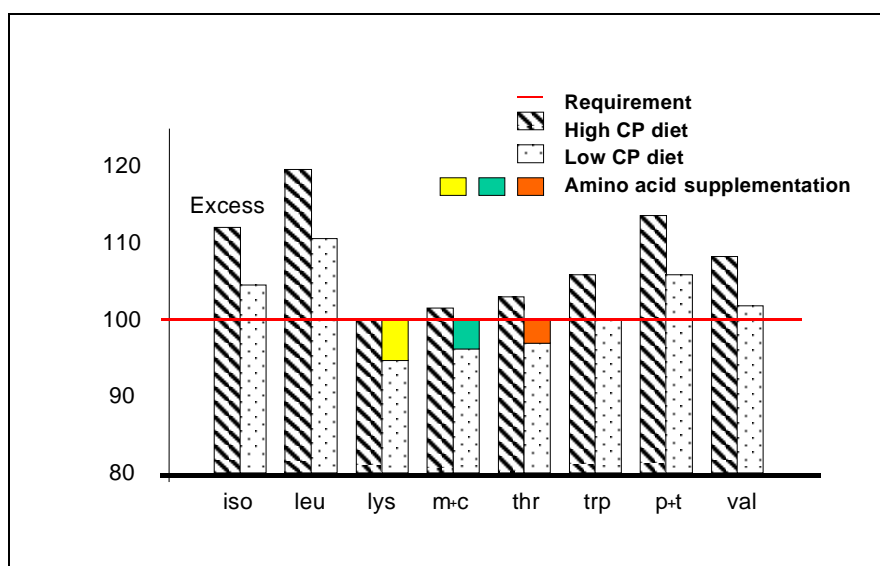

**Figure 4.1:** Amino acid supplementation allows a decrease in the amount of protein intake by animals whilst maintaining an adequate amino acid supply [77, LEI, 1999]

**Achieved environmental benefits:****Poultry**

- a reduction in dietary protein content of 1 percentage point results in a reduction in nitrogen excretion of 10 % for layers and 5 – 10 % for broilers, turkeys and other meat birds
- low-protein diets contribute to a reduction of ammonia emission from poultry houses. In an experiment on growing broilers, a reduction in crude protein of 2 points resulted in a reduction in ammonia emission of 24 %
- a reduction in water consumption of 8 % was found when the protein level in grower feed was decreased by 3 points. [108, FEFANA, 2001]

**Pigs**

In a literature review reported by Ajinomoto Animal Nutrition, data from reported trials on the effects of low protein diets (but supplemented with industrial amino acids) on nitrogen and slurry output from pigs, were selected from a large variety of sources within and outside Europe (see reference [99, Ajinomoto Animal Nutrition, 2000]). In the trials it was found that the excretion of nitrogen dropped by 10 % per 1 percentage point reduction in dietary protein for pigs between 25 and 110 kg.

The trials also showed that it is possible to reduce the protein level in feed by up to 2 percentage points for all categories of pigs, resulting in a decrease in nitrogen excretion of up to 20 % without any specific technical skills. However, it is necessary to add the four essential amino acids (lysine, methionine, threonine and tryptophane) to prevent growth reduction.

The reported trials showed remarkably similar results. They are summarised in Table 4.9.

Parameters	Effect of 1 point reduction of dietary protein (%)	Using low-protein diets	
		Frequent cumulative effect (%)	Best cumulative effect (%)
Total nitrogen excreted	- 10	- 25	- 50
Ammonia content in slurry	- 10	- 30	- 50
Slurry pH	-	- 0.5 points	- 1 point
Ammonia emission to air	- 10	- 40	- 60
Water consumption (ad libitum)	- 2 to - 3	- 10	- 28
Slurry volume	- 3 to - 5	- 20	- 30

**Table 4.9: Summary of the effect of a reduction of dietary protein and the use of low-protein diets on nitrogen excretion and ammonia emission [99, Ajinomoto Animal Nutrition, 2000]**

Low protein diets also reduce the emission of odorous components like H<sub>2</sub>S [108, FEFANA, 2001] (with reference to Hobbs et al., 1996).

The contribution of feeding measures to the actual reduction of emissions from animal housing systems varies with a number of factors, such as air temperature inside the housing, air velocity (ventilation rate) and manure surface area.

Such diets also reduce the animals' water intake. This results in a saving of water and a decreased volume of manure to be handled. With higher dm-contents, the slurry may also gain in value in terms of its fertilising quality.

**Cross-media effects:** Low-protein amino acid fortified diets as supplied in the reviewed trials discussed above did not affect growth, feed conversion or the nitrogen retention in the pig.

**Operational data:** Operational data of the trials on pigs have not been reported. The weight range of the pigs was generally between 25 and 110 kg of live weight and the feeding varied between 2-phase and multi-phase feeding.

**Applicability:** No specific technical requirements are necessary for the application of low-protein feed diets. However, the applied levels of crude protein might differ from country to country.

The feeding of low-protein diets reduced the animals' heat production caused by the growing-process. This is considered to be an advantage, particularly in Mediterranean Member States during hot summers. This effect is even more pronounced with lactating sows.

For UK conditions, poultry nutritionists advise that for laying hens aged 18 to 40 weeks tryptophan, which currently is not added in the feed, will be a limiting amino acid. Therefore a crude protein level of 15.5 – 16.5 (% in feed) (see Table 5.5) is not technically available and under UK conditions a higher crude protein level will be needed for this class of poultry.

For UK pigs, which are kept entire, slaughtered at relatively low weights and have a genotype developed to maximise lean deposition in these circumstances, it is likely that even the higher end of the ranges as reported in Table 5.1 is not technically available. Under UK conditions higher levels of CP can be used and still result in a lower total N input over the life of the pig.

The approach to reducing nitrogen pollution can be implemented very readily on a large scale since:

- little investment is needed and no structural alterations are required on the farm, and
- one feed mill generally covers a large number of farms, therefore reducing individual farm formulation costs.

**Costs:** A general description on cost assessment of nutritional management is given in Section 4.2.1. For feeding low-protein diets no special equipment has to be applied and no new investment needs to be made, although there may be a cost for feed formulation. Cost estimates of nutritional measures take into account the following factors:

- additional feed costs
- savings in water costs
- savings in slurry transport and treatment or spreading costs
- savings in capital investment, e.g. less storage capacity required.

To illustrate the effects of reduced CP diets, calculations have been made, but results depend on the assumptions made for the cost factors. Where one publication assumes an increase of feed costs varying between 1 and 3 % [116, MAFF, 1999], another report mentions cost savings with reduced feed costs of about 3 % [115, Rademacher, 2000].

Portugal has reported an increase of feed costs between 5.5 and 8 % for weaners and finishers when lowering the level of crude protein between 2.0 to 2.5 % and balancing the feed with amino acids. For sows this increase was 2.9 and 4.9 % for gestation and lactation respectively. These calculations were made based on the prices for the raw materials in May 2001. Regarding the variations in costs of raw materials, mainly protein rich ingredients, and the factors involved in the calculation of feed costs, more information from Member State on costs could be helpful. [201, Portugal, 2001]

**Reference farms:** Low-protein, amino acid-supplemented diets are already used to a certain extent in some intensive livestock production areas.

**Reference literature:** [77, LEI, 1999], [82, Gill, 1999], [100, MLC, 1998], [108, FEFANA, 2001], [115, Rademacher, 2000] and [116, MAFF, 1999]

#### 4.2.4 Addition of phytase to make low phosphorus, phytase supplemented diets for poultry and pigs

**Description:** This technique has been often published in scientific as well as practical documents. Phytate-phosphorus is not normally available to pigs and poultry as they lack the appropriate enzyme activity in their digestive tract. Therefore, the principle of the technique is to feed animals with the appropriate level of digestible phosphorus necessary to ensure optimum performance and maintenance, whilst limiting the excretion of non-digestible phytate-phosphorus normally present in plants (Table 4.10). The formulation of a low phosphorus diet can be achieved by:

1. adding phytase
2. increasing the availability of phosphorus in plant feed materials
3. reducing the use of inorganic phosphate in feeds.

Currently four phytase preparations are authorised as feed additives in the European Union (Directive 70/524/EEC category N).

Authorisation of new phytase products depends on an evaluation of the product, which should guarantee their efficiency in the declared animal categories.

New approaches are currently being developed by some plant breeding companies and which involve developing plant varieties with high phytase activity and/or low phytic acid content. [173, Spain, 2001]

Feedstuffs	Total P (%)	Phytate – P (%)	Phytase activity (U/kg)
Maize	0.28	0.19	15
Wheat	0.33	0.22	1193
Barley	0.37	0.22	582
Triticale	0.37	0.25	1688
Rye	0.36	0.22	5130
Sorghum	0.27	0.19	24
Wheat bran	1.16	0.97	2957
Rice bran	1.71	1.1	122
Soya bean meal	0.61	0.32	8
Peanut meal	0.68	0.32	3
Rape-seed meal	1.12	0.4	16
Sunflower meal	1	0.44	62
Peas	0.38	0.17	116

**Table 4.10: Total phosphorus, phytate-phosphorus and phytase activity in selected plant feedstuff [170, FEFANA, 2002] with reference to J. Broz, 1998**

**Achieved environmental benefits:** The data reported below for pigs and poultry can be found in many publications on the use of phytase in feedstuffs. They provide a summary of the results obtained with different feeds and in different situations, with possible reductions presented in relative terms:

**Pigs**

- the inclusion of phytase in feed improves the plant phosphorus digestibility by 20 to 30 percentage points in piglets, 15 to 20 % for growers and finishers, as well as for sows
- as a general rule, a reduction of phosphorus of 0.1 % in feed, by using phytase, results in a reduction in phosphorus excretion of 35 to 40 % for piglets, 25 to 35 % for growers and finishers, and 20 to 30 % for sows.

**Poultry**

- the inclusion of phytase in feed improves the plant phosphorus digestibility by 20 to 30 percentage points in broilers, layers and turkeys. Variations in the results are linked with the level of phytate-phosphorus contained in the plant materials used in the diet formulation
- as a general rule, a reduction of 0.1 % total phosphorus in feed, by using phytase, results in a reduction in phosphorus excretion of more than 20 % for layers and broilers.

Low phosphorus phytase supplemented diets, as supplied in the trials, did not affect growth, feed conversion ratios or egg production when compared with reference diets containing higher phosphorus concentration.

A reduction of phosphorus with the addition of phytase should be applied with a general view of the feed formulation, in order to avoid an uncontrolled modification of the phosphorus-calcium ratio. At farm level, no specific technical skills are needed to use low phosphorus phytase supplemented feed.

**Cross-media effects:** It has been shown quite recently, that phytase improves not only phosphorus digestibility, but also protein digestibility [170, FEFANA, 2002] with reference to (Kies et al., 2001).

**Operational data:** Operational data of the trials have not yet been reported. However phytases are feed additives and their efficiency with regards to phosphorus digestibility has been favourably assessed by SCAN (Scientific Committee on Animal Nutrition).

**Applicability:** Phytase can be incorporated in feedstuffs in powder, granulated or liquid form. Powder and granulated forms are used in production processes, only where the temperature is not too high (up to 80 – 85 °C). Note the stability performance may vary from one product to another; information on stability is usually supplied or requested from the supplier.

Liquid phytase is applicable when processes lead to high temperature in the dye. In this case, specific liquid equipment is necessary to supply the liquid product post-pelleting. Some feed mills are already equipped with such systems for enzyme application.

On farm, no specific additional requirements are needed for the application of low phosphorus phytase supplemented diets compared to a high phosphorus diet, when applied under the same conditions (one-phase or multiphase feeding programme).

This approach to reducing phosphorus pollution can be implemented very readily on large-scale as:

- no investment is needed for powder and granulated phytase, although some investment is needed in feed mills using liquid phytase
- no structural alterations are required on the farm
- one feed mill generally covers a large number of farms. [170, FEFANA, 2002]

**Costs:** A general description on the cost assessment of nutritional management is given in Section 4.2.1. For feeding low phosphorus phytase supplemented diets, there is no need for any special equipment at the farm level or any additional investment. Furthermore, adaptation of the feed, by adding phytase and adaptation of the nutrient levels, can lead to a reduction of the feed costs. [170, FEFANA, 2002]

**Reference farms:** Since the introduction of the first phytase product on the market over ten years ago, the feed industry has been producing low phosphorus phytase supplemented diets, especially (but not only) in areas with intensive livestock production. Since the prohibition of the use of meat and bone-meal, this kind of diet for pigs and poultry has been developing at a high rate both in the EU and in third world countries. [170, FEFANA, 2002]

**Reference literature:**

- FEFANA, 2000 – WP ‘Enzymes and Micro-organisms’ contribution to BREF document
- Broz J. 1998 - Feeding strategies to reduce phosphorus excretion in poultry – in: 5. Tagung Schweine und Geflügelernährung – 01-03-12-1998 – pp. 136-141
- Kies, A.K., K.H.F. van Hemert and W.C. Sauer, 2001 - Effect of phytase on protein and amino acid digestibility and energy utilisation. World's Poultry Science Journal, 57, 109-126.

#### 4.2.5 Highly digestible inorganic feed phosphates

**Description:** Inorganic feed phosphates are classified as mineral feed ingredients. In Directive 96/25/EC, part B, Chapter 11 several types of feed phosphates are included. These feed phosphates differ in respect of their mineral content and their chemical composition and as a result they have different phosphorus digestibilities. The use of the more digestible inorganic feed phosphates will have a favourable impact on nutrient excretion, and thus the environment. [198, CEFIC, 2002]

**Achieved environmental benefits:** The inclusion of highly digestible feed phosphates in animal feed will result in lower phosphorus levels in animal feed and thus a reduction of nutrient excretion into the environment. An example is given in Table 4.11.

Feed phosphate	Digestibility (%)	Inclusion rate (%)	Inclusion rate (gram P)	Absorbed P <sup>1)</sup> (gram)	Excreted P <sup>1)</sup> (gram)
Defluorinated phosphate	59	1.56	28.0	16.5	11.5
Monocalcium phosphate	84	0.87	19.6	16.5	3.1

*1) originated from the inorganic feed phosphate*

**Table 4.11: Calculated reduction of phosphorus excretion based on the digestibility of poultry [198, CEFIC, 2002] with reference to van der Klis and Versteegh (1996) on % digestibility**

From the calculation it is obvious that there is a huge environmental benefit in using highly digestible feed phosphates instead of lower quality feed phosphates. The same calculation can be applied for pigs, resulting in the same reduction in phosphorus excretion.

**Applicability:** Feed phosphates are incorporated in animal feed either in the powder, or in granulated form, depending on the physical properties of the end-product. Inorganic feed phosphates are predictable in chemical composition and in their digestible phosphorus content, partly because they are not susceptible to process conditions (such as heat or moisture). The use of highly digestible feed phosphates can be implemented very easily. Since phosphates need to be used either in complete feed or mineral feed used on the farm, highly digestible feed phosphates are available. No investments are needed, either at the farm level or at the feed compounder. [198, CEFIC, 2002]

**Costs:** A general description on cost assessment of nutritional management is given in Section 4.2.1. No cost increases for the farmer are involved for the change to the use of highly digestible inorganic feed phosphates. Feed phosphates are normally sold based on the total

phosphorus content. Highly digestible inorganic feed phosphates are in fact, calculated on digestible phosphorus content, and economy of use over other feed phosphates. Lower inclusion rates will lead to savings both at the farm level and with the feed compounder. Less phosphorus is excreted, resulting in lower manure processing costs for the farmer. [198, CEFIC, 2002]

**Reference farms:** Some feed producers and farms in regions which have environmental problems because of the high level of intensive animal breeding, have already started to use more digestible inorganic feed phosphates. Notably, this has taken place in the Netherlands, where there was no negative impact on animal performance but there was a positive effect on phosphorus excretion. [198, CEFIC, 2002]

**Reference literature:**

- Phosphorus Nutrition of Poultry. In: Recent Advances in Animal Nutrition, Nottingham University Press. Pages 309-320 by van der Klis, J.D., and Versteegh, H. A. J. (1996)
- A guide to feed phosphates by Sector Group Inorganic Feed Phosphates of CEFIC
- Feed phosphates in animal nutrition and the environment by Sector Group Inorganic Feed Phosphates of CEFIC

#### 4.2.6 Other feed additives

**Description:** Other feed additives that are added in small amounts to the feed of poultry and pigs are:

- enzymes
- growth stimulators
- micro-organisms.

The use and drawbacks of antimicrobials are described in Section 2.3.3.1.

**Achieved environmental benefits:** Enzymes and growth stimulators are used to reduce the feed whilst still achieving the same rate of growth. As a consequence, a reduction of total nutrient excreted by pigs (as a general approximation) of 3 % can be achieved; for poultry this can be approximately 5 %. These reductions are expected at an improvement in the Feed Conversion Rate (FCR) of 0.1 units. [199, FEFANA, 2002]

The use of feed enzymes often reduces the digestibles' viscosity by degrading Non Starch-Polysaccharides (NSP), thereby decreasing the moisture content of the faeces. Subsequently this results in a reduction of the potential development of fermentation in poultry litter, and thus a decrease in ammonia emissions. [199, FEFANA, 2002]

**Operational data:** Operational data of the trials have not yet been reported. However the efficacy of those feed additives (see the annex to Directive 70/524/EEC) has been favourably assessed by SCAN (Scientific Committee on Animal Nutrition).

**Applicability:** Feed additives are incorporated in feedstuffs in powder, granulated or liquid form. Powder and granulated forms are to be used in production processes, only where the temperature is not too high (up to 80 – 85 °C). Stability performance may vary from one product to another, information on the stability may be supplied or requested from the supplier.

Liquid feed additives are applicable when processes lead to high temperatures in the dye. In this case, specific liquid equipment is necessary to supply the liquid product post-pelleting. Some feed mills are already equipped with such systems.

There are no specific additional requirements for the application of feed additives on the farm.

This approach to reducing nutrient excretion can be implemented very readily on a large scale as:

- no investment is needed for powder and granulated feed additives, although some investment is needed in feed mills using liquid additives
- no structural alterations are required on-farm
- one feed mill generally covers a large number of farms. [199, FEFANA, 2002]

**Costs:** A general description of the cost assessment of nutritional management is given in Section 4.2.1. The introductory cost is generally covered by better animal performance. [199, FEFANA, 2002]

**Reference farms:** Feed additives are generally used in intensive animal production and shown good results in performance and reductions in nutrient excretion. [199, FEFANA, 2002]

### Reference literature:

- FEFANA, 2000 – WP ‘Enzymes and Micro-organisms’ contribution to BREF document
- Geraert P.R., Uzu G., Julia T., 1997 – Les Enzymes NSP: un progrès dans l’alimentation des volailles – in 2<sup>o</sup> Journées de la Recherche Avicole 08-09-10-04-1997 – pp.59-66
- Eric van Heugten and Theo van Kempen – Understanding and applying Nutrition concepts to reduce nutrient excretion in swine – NC State University College of Agriculture and Life Sciences – 15 pages document published by North Carolina Co-operative Extension Service
- A.J. Moeser and T. van Kempen – Dietary fibre level and xylanase affect nutrient digestibility and excreta characteristics in grower pigs – NC State University Annual Swine report 2002.

## 4.3 Techniques for the efficient use of water

**Description:** A reduction of water use on farms can be achieved by reducing spillage when watering the animals and by reducing all other uses not immediately related to nutritional needs. Sensible use of water can be considered to be part of good farming practice and may comprise the following actions:

- cleaning animal housing and equipment with high-pressure cleaners at the end of each batch of livestock. It is important however to find a balance between cleanliness and using as little water as possible
- regularly calibrating the drinking-water installation to avoid spillages
- keeping a record of water use through metering the consumption
- detecting and repairing leakages
- separately collecting rainwater and using it for cleaning purposes.

Reduction of the animals’ water consumption is not considered to be practical. It will vary in accordance with their diet and, although some production strategies include restricted water access, permanent access to water is generally considered to be an obligation.

For poultry, in principle three types of drinking systems are applied (see also Section 2.2.5.3):

1. low capacity nipple drinkers or high capacity drinkers with a drip-cup
2. water troughs
3. round drinkers.

For pigs, three types of drinking systems are commonly applied are (see also Section 2.3.3.3):



1. nipple drinkers in a trough or cup
2. water troughs
3. biting nipples.

All of these, for pigs and poultry, have some advantages, as well as disadvantages. Nutritional measures which aim to reduce nutrient levels in manure have been described in Section 4.2. Their use has side-effects on water intake, which in fact can be considered as a cross-media effect associated with these nutritional measures.

**Achieved environmental benefits:** Section 4.2 presents the effects of nutritional measures on water consumption and consequently on the volume of slurry produced. For poultry, it was demonstrated that a reduced protein level of 3 percentage points resulted in an 8 % reduction of water intake.

When water is given ad libitum to pigs, they naturally reduce their water intake. Literature shows that reduced-protein diets contribute to a decrease in water consumption. The results are summarised in Figure 4.2.

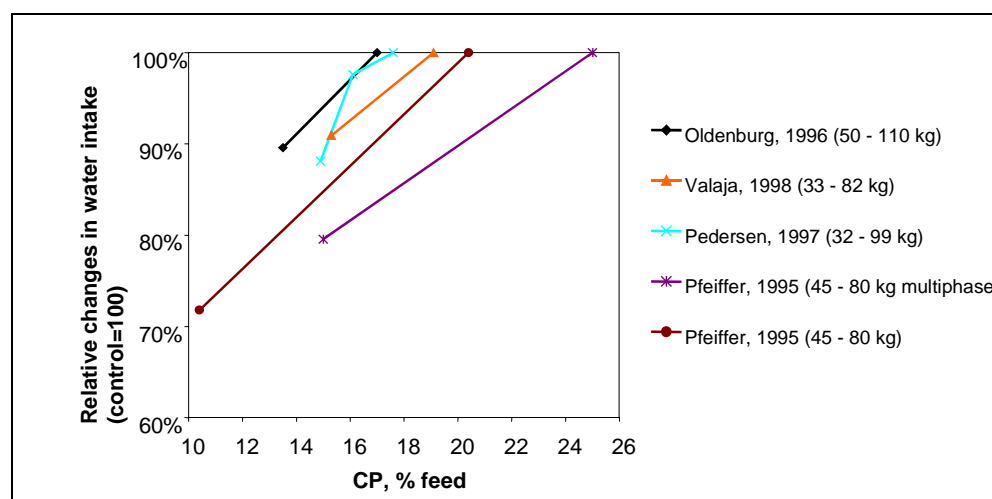

**Figure 4.2:** Effect of reduced crude-protein diets on the intake of water by pigs [99, Ajinomoto Animal Nutrition, 2000]

**Cross-media effects:** Typically in pig housing, the wash-down water enters the slurry system which means that a reduced water intake will lead to a reduction of slurry volumes to be applied.

**Operational data:** Results were obtained under different conditions and weight ranges.

**Applicability:** See Section 4.2. There are no serious limitations to the application of the nutritional measures reported.

**Costs:** See Section 4.2.

**Reference literature:** [99, Ajinomoto Animal Nutrition, 2000] [112, Middelkoop/Harn, 1996]

## 4.4 Techniques for the efficient use of energy

Measures to improve the efficient use of energy involve good farming practice as well as the selection and application of proper equipment and proper design of the animals' housing. Measures taken to reduce the level of energy usage also contribute to a reduction of the annual

operating costs. In this section, a number of general measures are described followed by a few specific examples of reduction techniques. Energy saving methods are also closely related to the ventilation of livestock housing.

Control of ventilation rates is the simplest method of controlling the internal temperature of animal housing. Factors that affect the house temperature are: [176, UK, 2002]

- heat output from the pigs
- any heat input (e.g. heat pads or lamps for piglets)
- ventilation rate
- heat absorbed by the air in the house
- heat used to evaporate water from drinkers, feed troughs, spilt water and urine
- heat loss through walls, roof and floor
- external temperature
- stocking rate.

The ventilation system should be designed so that it has sufficient capacity to control the house temperature in the warm summer months when it is fully stocked with the heaviest animals, and to also have sufficient control to provide a minimum ventilation rate in colder winter months when the house is stocked with the lightest animals. For animal welfare reasons, minimum ventilation rates should be sufficient to provide fresh air and to remove unwanted gases.

Energy demand can be significantly reduced if houses are equipped with natural ventilation rather than with forced ventilation systems. However, this is not always possible or desirable for every livestock type and for all farming objectives.

### **4.4.1 Good practice for the efficient use of energy on poultry farms**

#### **4.4.1.1 Fuels for heating**

A considerable reduction in energy consumption for heating can be achieved by paying attention to the following points:

- fuel consumption can be reduced by separating heated spaces from other spaces, and by limiting their size
- in the heated space fuel use can be reduced by correct regulation of the equipment and by promoting equal distribution of warm air through the housing, i.e. by spatially distributing the heating equipment adequately. An equal distribution would also prevent a sensor from being located within a cold spot in the housing, which would unnecessarily activate the heating installation
- control sensors should be checked regularly and kept clean so that they are able to detect the temperature at the stock level
- warm air from just below the roof level can be circulated down to floor level
- minimising the ventilation rates, as far as the indoor climate requirements allow, further reduces heat losses
- placing ventilation vents low down on the walls (as heat tends to rise) will reduce heat losses
- putting down further insulation on the floor, i.e. on top of the material-specific insulation already applied in the floor construction, will reduce heat losses and therefore fuel input (esp. with high groundwater levels)
- cracks and open seams in the housing construction should be repaired
- in a layer house heat may be recovered with a calorifier between the incoming and outgoing air. This type of system is used to warm the air to dry the manure on the belts under the cages to reduce emissions of ammonia.

Control of minimum ventilation also requires well-sealed buildings. If heating is required to maintain the moisture content of litter, all sources of unnecessary wetness should be rectified (e.g. spillage from drinkers). Fans that operate intermittently should be fitted with back-draught shutters to reduce heat loss.

Savings have been reported of up to 0.9 kWh per bird sold per year where ventilation was 10 % higher than necessary.

For north-western Europe, U-values of 0.4 W/m<sup>2</sup>/°C or better are recommended for building insulation where new poultry houses are planned.

#### 4.4.1.2 Electricity

General measures to reduce electricity use are:

- to select the correct type of fans and to consider their position in the building
- to install fans with a low energy use per m<sup>3</sup> of air
- to use the fans efficiently, e.g. operating one fan on full capacity is more economical than operating two on half their capacity
- to apply fluorescent lights instead of glowing bulbs (although note that their “biological” suitability is reported to be uncertain)
- to apply lighting schemes, for example, using a variable lighting period such as an intermittent illumination of 1 period of light to 3 periods of darkness instead of 24 hours light per day reduces the amount of electricity to one third.

Research has been done by the Applied Research Station in Spelderholt, the Netherlands, to dry manure from layers in cage systems by applying intermitting air drying. This involved three trials, the results of which are shown in Table 4.12.

**Reference literature:** [26, LNV, 1994] and [73, Peirson, 1999] and [107, Germany, 2001]

Ammonia emission and dry matter of manure									
Continuous air drying <sup>1)</sup>					Schemes				
	Air temp. (°C)	Relative humidity (%)	Dry matter manure (%)	NH <sub>3</sub> (g/animal place/year)	Method	Energy saving <sup>2)</sup> (%)	Dry matter (%)	NH <sub>3</sub> (g/animal place/year)	Emission compared to continuous drying <sup>3)</sup>
<b>Trial 1 (1996)</b>	19.6	70	62	9	15 minutes 0.7 m <sup>3</sup> / 15 minutes off	50	51	11	122
<b>Trial 2 (1997/1998)</b>	18	88	55	18	1 day off / 4 days 0.7 m <sup>3</sup>	20	52	21	117
					4 days 0.5 m <sup>3</sup> / 1 day 0.7 m <sup>3</sup>	10	52	22	122
<b>Trial 3 (1999)</b>	15.6	91	59	14	1 day off / 3 days 0.5 m <sup>3</sup> and 1 day 0.7 m <sup>3</sup>	28	53	23	164

1) continuous air drying and schemes: 0.7 m<sup>3</sup> air per layer per hour; dry matter of all manure (continuous and schemes) is sampled after 5 days of drying  
2) estimated in comparison to continuous air-drying method  
3) emissions from continuous drying is 100

**Table 4.12: Intermitting air drying of manure in layer cage systems**

Source: Applied Research Station, Spelderholt, the Netherlands. Article in *Pluimveehouderij*, 22 December 2000

#### 4.4.1.3 Low-energy illumination

**Description:** The use of different types of lamps than bulb lights in poultry houses can reduce energy consumption. Instead of the filament bulb, fluorescent lights (TL-lamps) can be applied in combination with a device to adjust the frequency of microflashes (>280000), so the animals will not be able to register the rapid fluctuations typical for this light.

There are different types of fluorescent lights on the market (type of code depending on the manufacturer). Some examples are:

- TL-lights (Ø 38 mm), range 20, 40 60 Watt, not adjustable
- TLM-lights (Ø 38 mm), 40 and 60 Watt, adjustable, application with low temperatures, high relative humidity, and quick ignition without starter
- TLD-lights (Ø 26 mm), 18, 36 and 58 Watt
- TLD HF (high frequency), 16, 32 and 50 Watt, always in combination with electronic switch, dimmable
- SL-lights, 9, 13, 18 and 25 Watt, fluorescent lights with bent tube, can be used in bulb socket, not adjustable.

**Achieved environmental benefits:** In Table 4.13 a number of lights are compared. Fluorescent lights have a higher light capacity per energy unit (lumen/Watt) than conventional bulbs. Power rating and the number of hours used will determine the annual energy use. The replacement of filament bulbs by compact fluorescent lights could save up to 75 % of the energy used. The replacement of 38 mm fluorescent with 26 mm tubes of lower wattage could save up to 8 % of energy used.

Type of light	Capacity (Watt)	Stream of light (lumen)	Specific stream of light (lumen/Watt)	Adjustability
Light bulb	40	385	10	yes
Light bulb	60	650	11	yes
Light bulb	100	1240	12	yes
SL-lights	9	425	47	no
SL-lights	13	600	46	no
TL M	20	1200	60	yes
TL M	40	2900	73	yes
TL D	15	960	64	no
TL D	30	2300	77	no
TL D HF	16	1400	87	yes
TL D HF	32	3200	100	yes

**Table 4.13: Specific stream of light and adjustability of different types of light bulbs and fluorescent lamps**  
[26, LNV, 1994]

**Applicability:** The non-adjustability of some types makes them less suitable for the housing of animals. Within this group TLM type are easily adjustable, but the TLD are not. However the high frequency version (TLD HF) has the highest specific “stream of light” and is adjustable, but needs an adapting device. Most of the lights can be applied in existing housing, except for the TLD HF type. An indication of longevity is given in the following table. Longevity is defined for filament bulbs as the moment when 50 % has broken down and for fluorescent lights when they give 20 % less light and 10 % has broken down. Dimming affects longevity and reduces economic life (of filament bulbs particularly).

The effect of the application of different types of light on the animals’ health has not been assessed, but should be taken into account, now and in the future.

Type of light	Longevity (hours)
Filament bulb	1000
TLM-lights	6000
TLD-lights	6000 – 8000
TLD HF-lights	125000
SL-lights	8000

**Table 4.14: Indication of longevity of different types of light for poultry housing [26, LNV, 1994]**

**Costs:** Fluorescent lamps are generally more expensive than filament bulbs. TLD/HF is 2 to 3 times more expensive than the TL-D type. Annual operating costs (including amortisation of a new installation) clearly depend on electricity prices as well as on the number of replacements that need to be purchased.

It has been observed that the SL-type or similar has been applied in many installations, as this type can be easily applied in an existing filament bulb installation.

**Reference farms:** Energy saving illumination is known to have a wide application.

**Reference literature:** [26, LNV, 1994]

#### 4.4.1.4 Heat recovery in broiler housing with heated and cooled littered floor (combideck system)

**Description:** Normally, there is a system for heating the air in broiler houses. The “combideck system” heats the floor and the substances (such as litter) on top of it. The system consists of a heat pump, an underground storage facility made of tubes, and a layer of isolated hollow strips (intermediate space 4 cm) 2 – 4 metres below the floor. The system uses two water cycles: one serving the house and the other acting as the underground storage. Both cycles are closed and connected through a heat pump.

In the broiler house, the hollow strips are put in an insulated layer below the concrete floor (10 - 12 cm). Depending on the temperature of the water that flows through the strips, the floor and the litter will either be warmed up or cooled down.

Heat can be taken from the warm water that leaves the housing and can be returned to warm the water cycle in the floor. The heat dissipated by the heat pump is stored in underground insulated tubes and can be pumped up whenever required.

When the broilers enter on the first day of the production cycle, water is warmed up and fed through the strips below the floor to warm the floor. Broilers need some heat until about day 21 (about 28 °C). After a short period of equilibrium, the growing process generates a lot of heat and this heat is normally radiated into the soil below the building. This heat is now absorbed by a cold water stream and led back to a heat pump. The heat pump moves the heat from the water cycle of the house to the second water cycle that stores the heat underground. At the same time, the broilers are cooled down and the temperature is maintained at about 25 °C.

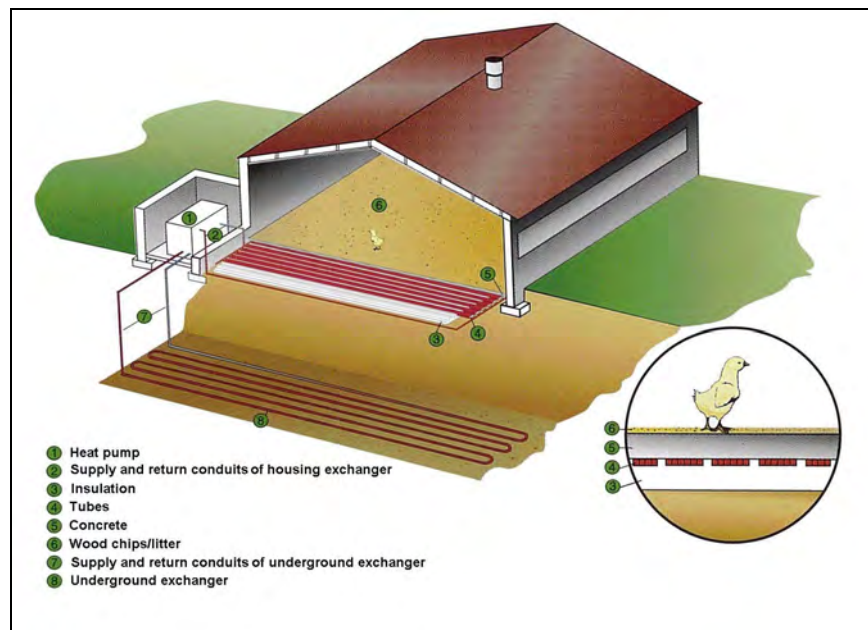

Figure 4.3: Schematic representation of the installation of the heat recovery system in a broiler house

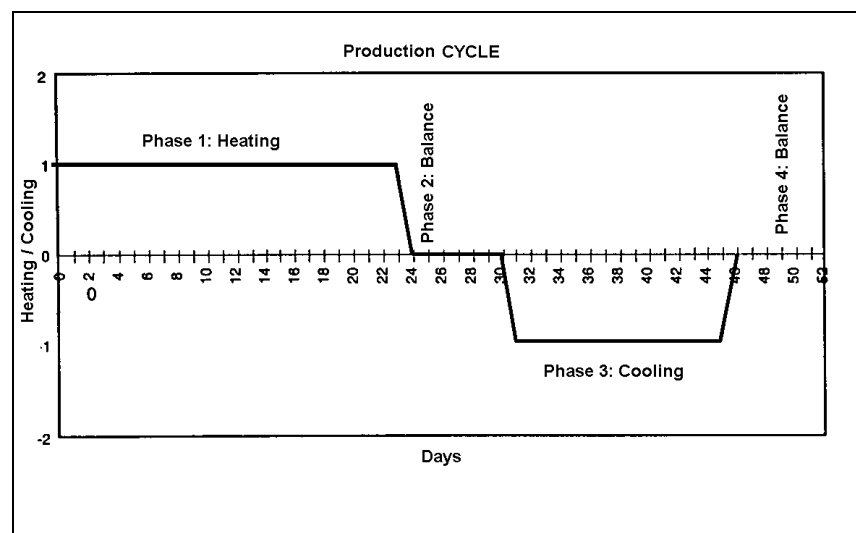

Figure 4.4: Graphic representation of the working principle of the “combi-deck-system” during one broiler production cycle

After the broilers leave the housing, it is emptied and cleaned. Once ready for the next production round, the warm water from the underground storage is pumped up and is run through the heat pump, warming the water in the water cycle that serves the house. The floor is preheated and now less energy will be needed to warm the floor to the temperature required for housing young broilers. Once the broilers are in the house (Phase 1), the stored heat is used and only a little extra heating may be required.

After the short intermediate phase (Phase 2), cooling is required again (Phase 3) and the heat dissipated from the housing will be stored underground and will be available for the next production cycle.

**Achieved environmental benefits:** The reduction of energy use is the main achieved benefit. The re-use of heat generated in an earlier production cycle reduces ventilation rate (14 %). The amount depends on the installation, but up to 50 % reduction in energy used has been achieved. Data to illustrate the results are presented in Table 4.15.

**Cross-media effects:** The average ammonia emission over 4 production cycles was 0.045 kg NH<sub>3</sub> per broiler place per year. The reference installation emitted 0.066 kg NH<sub>3</sub> per broiler place per year. The reduction of the NH<sub>3</sub> emission of this system with heated and cooled air is about 32 %.

Preheating prior to littering and introducing poultry will avoid condensate from forming on the floor and moistening the litter. The dung-litter mixture is not shredded, e.g. at the end of a housing period, as this leads to high emissions.

The system has a better performance on broiler production (reduction of mortality, higher meat price, better feed ratio) and a positive effect on animal welfare (less heat stress, lower mortality, less veterinary services needed). [178, Netherlands, 2002]

	Fuel type/ fuel use	Input	Energy- equivalent (MWh/yr)	Costs <sup>2</sup> (euros)	CO <sub>2</sub> (tonne) <sup>3</sup>
Reference situation	Fuel oil	49.5 m <sup>3</sup>	549	6273	65.0
	Natural gas	36.1 m <sup>3</sup>	321	9277	158
	Electricity	40 MWh	40	3757	14.8
	<b>Total</b>		<b>910</b>	<b>19307</b>	<b>237</b>
Combideck system applied	Heating	63.6 MWh	63.6		23.5
	Ventilation	34.4 MWh	34.4		12.7
	Heat pump <sup>1</sup>	189 MWh	189		44.4
	<b>Total</b>		<b>287</b>	<b>9194</b>	<b>80.6</b>
<b>Reduction (as percentage of reference)</b>			<b>623 (70 %)</b>	<b>10113 (52 %)</b>	<b>156.4 (66 %)</b>
<sup>1</sup> coefficient of performance heat pump: 4.4 <sup>2</sup> reference year 1999, corrected for low and peak tariffs on electricity prices in the Netherlands <sup>3</sup> CO <sub>2</sub> -equivalents: oil 3.2, gas 1.8, electricity 0.37					

**Table 4.15: Results of the application of the combideck system**  
[113, R&R Systems BV, 1999]

**Operational data:** For 80000 broilers three heat pumps were used, each of 0.1 kW<sub>e</sub>. Broilers were stocked at a density of 18 birds/m<sup>2</sup>. Percentage of mortality over 6 cycles averaged 2.34 % (range 1.96 – 3.24). The housing conditions did not cause any problems. At the start a little condensation developed on the cold floor surface, but this disappeared quickly and did not cause a wet floor or wet litter. An existing house would not need any change to apply the combideck system, except that the ventilation rate would be reduced. Modular build-up of a system is possible.

In 2001, the performances of raising broilers on one farm in two different housings were sampled and compared. One house was equipped with the Combideck system (House 2) and the other house without (House 1). The results are shown in Table 4.16. They show that the mortality rate and the energy costs are lower in House 2, i.e. the house equipped with the Combideck system. However, the surplus payment per kilogram broiler is higher.



	<b>House 1</b>	<b>House 2 (Combideck)</b>
Total birds	33000	34000
Mortality (%)	4.97	2.85
Harvesting weight (grams) 1 <sup>st</sup> time with 35 days	1681	1692
Harvesting weight (grams) 2 <sup>nd</sup> time with 42 days	2250	2236
Surplus payment per kg (euro-cents)	0.2	0.4
Feed ratio (1500 grams)	1.55	1.40
Heating costs (per broiler in euro-cents)	3.13	2.10

**Table 4.16: Farm levels at Henk Wolters, Dalfsen, the Netherlands [178, Netherlands, 2002]**

**Applicability:** This system can be applied in both new and existing houses. If constructed in existing houses, the costs are slightly higher because of the insulation needed. Construction and ground works will be needed in the farmyard, depending on the position of the broiler house.

With several broiler houses, it may be possible to use heated water from one house (being emptied) to warm another (to be stocked), which may even further reduce the energy needed for pumping. However, this idea has not yet been put into practice.

Soil condition must allow the installation of closed underground storages of circulated water. The technique is less suitable in areas with hard and rocky soils. The system is applied in the Netherlands and in Germany at a depth of 2 – 4 metres.

So far no information has been presented on the application of the combideck system in climates where the frosts are longer and harder and penetrate the soil.

**Costs:** Investment costs are EUR 2 per broiler place with 20 broilers per m<sup>2</sup>. Operational costs (depreciation, interest and maintenance) are EUR 0.20 per broiler place year. The annual increased yields reportedly outweighed the yearly operational costs by a factor of about 3. For instance, veterinarian costs were reduced by about 30 %. Energy costs were reduced by about 52 %. The payback time is about 4 – 6 years. [178, Netherlands, 2002]

Where low electricity prices apply during certain parts of the day, a further cost reduction may be possible.

**Reference farms:** In 2001, five enterprises applied this system with a total of 500000 broilers (4 enterprises in the Netherlands and 1 in Germany). In 2002, a system for 500000 broiler places is currently under construction. By the end of 2002 the total available broiler places in the Netherlands with this system is expected to be 1 – 1.5 million, equating to about 2 – 3 % of the total production in the Netherlands. [178, Netherlands, 2002]

**Reference literature:** IMAG, Rapport 98-1004

#### 4.4.2 Good practice for the efficient use of energy on pig farms

The biggest opportunities for savings in energy use can be ranked in priority order as:

1. heating
2. ventilation
3. lighting
4. feed preparation.

General operational measures to reduce the energy consumption in pig farms are:

- better use of the available housing capacity
- optimising animal density
- lowering the temperature as far as animal welfare and production allow.

Some possibilities for reducing energy consumption are:

- reducing ventilation, taking into account the minimum levels required for animal welfare reasons
- insulating the building, particularly lagging the heating pipes
- optimising the position and adjustment of heating equipment
- considering heat recovery
- considering using high-efficiency boilers in new housing systems.

For forced ventilation systems, emission concentrations and specific energy requirements increase with increasing airflow rates, such as in summer. Forced ventilation systems are designed, built and operated so that the flow resistance of the ventilation system is kept as low as possible, e.g.:

- having short air ducts
- incorporating no sudden changes in air duct cross-sections
- limiting the changes in duct direction, or application obstructions (e.g. baffles)
- removing any dust deposits in the ventilation systems and on the fans
- avoiding having rain protection covers above the discharge points.

The elevation of exhaust air plumes through the application of high discharge speeds may be specified where absolutely necessary for odour control. Bypass systems intended to ensure high air velocities throughout the year result in a doubling of the energy requirement.

Fans with the lowest possible power consumption for a given air rate and air pressure rise should be selected. Fans with low-rated rpm (low-speed units) use less energy than those that operate at high rpm (high-speed units). Low-speed fans can, however, only be used if the ventilation system exhibits a low flow resistance (<60 Pa).

Fans designed on the basis of EC (electronic commutation) technology exhibit a significantly lower power requirement, particularly over the regulated speed range, than transformer-regulated or electronically regulated fans. New energy-saving fans have a 30 % lower power requirement so that the investment is amortised relatively quickly in spite of the higher purchase prices. If a series of fans is operated in order to ventilate a house, a multiple-series gang switching arrangement of fans may be advisable. It means that successive activation or de-activation of each individual fan controls the volume of the airflow. For maximum efficiency, in such an arrangement each fan operates and contributes to the required ventilation volume at its full capacity. The volume of the airflow corresponds with the number of activated fans.

Significant reductions in power consumption can be achieved by a combined system for controlling heating and ventilation systems that is optimally aligned to the requirements of the livestock.

Systems for exhaust air cleaning can significantly increase the flow resistance of forced ventilation systems. In order to deliver the requisite air rates, particularly in summer, higher-capacity fans with a higher specific power requirement may be necessary. In addition, power is required to operate the pumps for water circulation in bioscrubbers and for humidifying operations in biofilters (Section 4.6.5).

In sow keeping, a zone heating system is installed for heating the piglet creep area. Hot water floor heating is more energy efficient than an electric floor heating system or the use of infrared radiators. For houses with natural ventilation, the lying area is located in heat-insulated boxes (so-called box and bed stalls) to avoid the need for additional heating.

In the operation of biogas facilities, the energy generated (power and heat) from the biogas produced can be used (recovered) to replace that generated from fossil fuels. However, it is reported that only swine nurseries and agricultural distilleries are capable of utilising the heating energy throughout the year.

Energy use in feed preparation can be reduced by about 50 % when meal is transferred mechanically, rather than pneumatically (blown) from the mill to mixing or meal storage.

Examples show that the use of improved heater lamps in farrowing houses could reduce energy use from 330 kWh per sow per year down to 200 kWh per sow per year.

**Reference literature:** [27, IKC Veehouderij, 1993] and [72, ADAS, 1999]

## 4.5 Techniques for the reduction of emissions from poultry housing

This section reflects the information submitted and focuses on measures to reduce emissions to air from poultry housing. These emissions can be reduced by reducing the amount of droppings, by changing their composition and/or by removing them from the housing, and either storing them elsewhere or immediately applying them onto land. Reduction of NH<sub>3</sub>-emission by drying prevents N escaping from the droppings and thus maintains the N-concentration in the droppings. Consequently more N is available in the droppings and thus applied on land and may potentially be emitted during subsequent landspreading.

A technical description of a number of techniques has been given in Section 2.2, but in this section integrated techniques, improved designs and end-of-pipe techniques will be assessed through a number of characteristics, such as their performance and their applicability.

Quantified data mainly originates from the Netherlands, Italy and Germany. Other sources have reported on applied techniques, but without giving associated environmental performance levels. With respect to emission levels, the Dutch levels have been obtained following a specific protocol (see Annex 7.5) applying requirements to housing and housing conditions, feeding etc. The Italian data have been calculated or measured, but the protocol applied has not been reported. The German information does not contain emission factors or reduction percentages, whereas the housing techniques and management system are well described.

Note, cost data must be interpreted with caution. For instance, the Italian data on costs take into account the benefits or the negative costs that result from applying a technique, whereas data from other countries typically do not. The German cost data were reported along with the factors used for the calculation of labour costs and depreciation costs.

### 4.5.1 Techniques for cage housing of laying hens

These system-integrated techniques can be considered as a variety of designs of housing facilities, types of cages, manure removal systems and manure storage facilities. Most techniques are an improvement of the open manure storage under cages. This technique is not considered to be a potential BAT, but serves as a reference system and is not further described. The associated ammonia emissions from this type of housing (housing and storage combined) have been reported to vary from 0.083 (NL) to 0.220 (Italy) kg NH<sub>3</sub> per bird place per year.

Techniques are firstly applied to remove manure from the cage area to a storage facility, which is connected with the cage area or which can be a separate on-farm storage building. To compare these systems, both the emission from the cages and the emission from the storage area must be assessed. Emissions from storage depend on the dry matter content (dm-%) of the manure that leaves the housing and on the air temperature in the storage area and in the manure heap itself. Emissions of ammonia from layer droppings result from chemical reactions in the manure and is enhanced by its moisture content, although adding water to form a slurry will reduce ammonia emissions. Adding water for easier pumping of the slurry is still practised, but it is declining due to the smell and excess volume. Drying manure is a way to inhibit the chemical reactions and thus reduce the emissions. The quicker the manure is dried the lower the emission of ammonia. Various techniques are applied that create an airstream over the manure belt, which enhances the drying of the droppings. A combination of frequent removal and the drying of manure gives the best reduction of ammonia emissions from the housing and also reduces emissions from the storage facilities, but at an associated energy cost.

As explained in Section 2.2, a distinction is made between caged and non-caged housings. Application of techniques to existing laying houses must be evaluated in the light of new European legislation on the welfare of laying hens [74, EC, 1999], which will phase out the commonly used cage systems and allow only the enriched cage designs or alternative systems (free range or barn). It is suggested that with a current phase out period ending at 01-01-2012 the costs of application techniques to new and existing houses may have to be assessed with a limited amortisation period of 10 years.

Cage systems	NH <sub>3</sub> reduction (%)	Cross-media effects	Applicability	Extra investment <sup>2)</sup> (EUR/bird place)	Operating cost (EUR/bird place/year)
<b>Reference:</b> Open manure storage under cages	0.083 – 0.220 (kg NH <sub>3</sub> /birdplace/yr)				
Section 4.5.1.1 Aerated open manure storage (deep-pit or high rise systems and canal house)	-443 to 30 <sup>1)</sup>	<ul style="list-style-type: none"> <li>energy for fans</li> </ul>	<ul style="list-style-type: none"> <li>low labour</li> <li>specific construction</li> </ul>	0.8	0.03 (energy) 0.12 (total)
Section 4.5.1.2 Stilt house	n.d.	<ul style="list-style-type: none"> <li>low energy input</li> </ul>	<ul style="list-style-type: none"> <li>specific construction</li> <li>open storage</li> </ul>	n.d.	n.d.
Section 4.5.1.3 Manure removal by way of scrapers to closed storage	0 (excludes emission from storage)	<ul style="list-style-type: none"> <li>energy for scraper</li> <li>odour</li> </ul>	<ul style="list-style-type: none"> <li>needs separate storage</li> </ul>	n.d.	n.d.
Section 4.5.1.4 Manure removal by way of belts to closed storage	58 – 76	<ul style="list-style-type: none"> <li>energy for belts</li> <li>emission from storage</li> </ul>	<ul style="list-style-type: none"> <li>needs separate storage</li> <li>specific construction on feed hopper required for higher reduction</li> </ul>	+1.14	+ 0.17 (total)
Section 4.5.1.5.1 Vertical tiered cages with manure belts and forced air drying	58	<ul style="list-style-type: none"> <li>energy for belts and drying</li> <li>low emission from storage (45 % dm)</li> </ul>	<ul style="list-style-type: none"> <li>needs separate storage</li> </ul>	0.39 (I) 2.05 (NL)	0.193 (I) 0.570 (NL)
Section 4.5.1.5.2 Vertical tiered cages with manure belt and whisk-forced air drying	60	<ul style="list-style-type: none"> <li>energy for whisk moving and belt</li> <li>low emission from storage (45 % dm)</li> </ul>	<ul style="list-style-type: none"> <li>needs separate storage</li> </ul>	2.25 (I)	0.11 (energy) 0.310 (total)
Section 4.5.1.5.3 Vertical tiered cages with manure belts and improved forced air drying	70 – 88	<ul style="list-style-type: none"> <li>high energy input</li> <li>low odour levels</li> </ul>	<ul style="list-style-type: none"> <li>needs separate storage</li> <li>preheating for increased reduction</li> </ul>	0.65 (I) 2.50 (NL)	0.36 (I) 0.80 (NL)
Section 4.5.1.5.4 Vertical tiered cages with manure belt and drying tunnel over the cages	80	<ul style="list-style-type: none"> <li>high energy input</li> <li>very low emission from storage (80 % dm)</li> </ul>	<ul style="list-style-type: none"> <li>needs separate storage</li> <li>special construction overhead drying tunnel</li> </ul>	2.79 (I)	0.23 – 0.28 (energy) 0.48 total (I)
Section 2.2.1.1.6 Enriched cage	58	<ul style="list-style-type: none"> <li>energy input depending on belt system (25 – 50 % dm)</li> </ul>	<ul style="list-style-type: none"> <li>full replacement of cage system</li> <li>obligatory system from 1-1-2012</li> </ul>	n.d.	n.d.
1) negative reduction means an increased emission compared with the reference					
2) cost differences partly due to inclusion of benefits (I); extra cost compared with reference					
n.d. no data					

Table 4.17: Summary of characteristics of system integrated techniques for battery housing of laying hens

### 4.5.1.1 Cage systems with aerated open manure storage (deep-pit or high rise systems and canal house)

**Description:** These housing systems have already been described in Section 2.2.1.1.2. The vertical tiered cages in the upper part of the house have an open connection to the storage area in the lower part underneath.

**Achieved environmental benefits:** An extractor fan pulls air through the housing past the cages and manure heap. Although the manure is dried with air, some anaerobic fermentation can occur that can cause high ammonia emissions. Reported data on the emission at the outlet of the fans vary between 0.154 (estimated in Italy) and 0.386 (measured in the Netherlands) kg NH<sub>3</sub> per laying hen-place per year. The difference is significant but is probably due to the different climatic conditions. This system shows a better performance in Mediterranean climates than in climates with much lower temperatures [182, TWG, 2002].

A canal house is assumed to have the same emission levels as a deep pit house. Particularly in winter, when the ventilation rate is lower, ammonia concentrations in the bird area may be reduced, but emissions from the manure storage are not.

Providing additional aeration of the manure using perforated polyethylene tubes could achieve lower emissions, but no results have been reported.

**Cross-media effects:** The application of these systems requires energy for the fans, but it must be noted that the fans will serve both the manure storage and the layer housing areas.

**Operational data:** This housing system results in manure with a dry matter of 50 – 60 %. Because the manure is dried so quickly, there is little odour from the cages. The emission appears at the outlets of the open storage. Usually, manure is stored for a full cycle (13 – 15 months). No separate storage facility is needed.

In practice, problems are encountered with canal and deep-pit houses because of the level of ammonia concentrations, which can be so high that it is difficult to work in these areas. Flies and dirty eggs may also cause problems, but good maintenance should be able to control this.

In the Netherlands this system is being phased out because of the problems with the ammonia emissions, flies and odour [179, Netherlands, 2001].

**Applicability:** In Italy, this system is applied on large farms, as the labour input required is low. However, the system can only be applied in new houses, since it needs sufficient height for the manure storage, although it is possible that an appropriate existing building, such as an existing two-storey layer house, could possibly be converted into a high-rise house, but no information has been submitted to demonstrate this.

**Costs:** The extra investment costs of an additional ground floor are reported to be partially offset by the fact that no external storage is necessary [127, Italy, 2001]. Extra investment costs compared with an open storage system amount to EUR 0.8 per bird place. Extra costs for energy are EUR 0.03/year per bird place. The total extra annual costs are EUR 0.12 per bird place per year. This means that with a reduction from 0.220 to 0.154 kg NH<sub>3</sub> per bird place per year (i.e. 30 %) approximately EUR 1.84 per kg NH<sub>3</sub> is abated.

**Reference farms:** Deep pit houses are used in several Member States (UK, Netherlands (2.5 million hens) and Italy (8 – 9 million hens)).

**Reference literature:** [10, Netherlands, 1999], [119, Elson, 1998] [179, Netherlands, 2001]

#### 4.5.1.2 Cage system in a stilt house

**Description:** A short description is given in Section 2.2.1.1.3. In this system, the vertical tiered cages in the upper floor and the storage area underneath have no open connection. However, the storage area is open to the climate.

**Achieved environmental benefits:** Emissions (odour, ammonia) from housing and storage should be assessed together to properly evaluate this housing system. Emissions from the housing are considered to be very low. It is believed that the stilt house performs better than the deep pit system in terms of waste handling, manure drying and ammonia emission levels, but no quantified data have been submitted to support these observations. Emissions are difficult to measure in view of the open-sided design of the manure store. It is reported that ammonium nitrogen levels in the manure remain at a high level and thus it is assumed that the ammonia emission is low. The emission, and hence the environmental performance, will vary depending on the climatic conditions.

**Cross-media effects:** Energy is needed for the ventilation of the layer house and to open the automatic valves (if applied).

**Operational data:** All the manure is passed from the cage slot to the store by gravity. Scrapers should be run two or three times a day to ensure that the manure is sticky enough to build up into steep sided heaps, with a high surface area for drying. Drying is gradual, although it is greatest in spring and summer in warm conditions when maximum ventilation is operated. In tests, manure moisture levels have been below 20 % (or more than 80 % dm) at the year-end and ammonia levels in the bird area have not exceeded 3 ppm.

**Applicability:** Old deep pit houses can be changed into stilt houses but other designs might need to be raised. This technique requires different management from the deep pit system. The design of the valve is critical, since its opening must vary according to the ventilation rate, and it must be *fully* open for manure removal and in the fail-safe mode. Well-designed valves increase manure drying and exclude wind entry into the stock section.

**Reference farms:** Stilt houses have been developed and applied in the UK.

**Reference literature:** [119, Elson, 1998]

#### 4.5.1.3 Cage system with manure removal by way of scrapers to a closed storage

**Description:** This system is an alternative to the open storage system, but here a shallower pit is used and manure is frequently removed. Manure is frequently removed and transported off-farm or stored on-farm in separate storage.

**Achieved environmental benefits:** Emissions from this system are a combination of emissions from the housing area and the separate storage facility. The emission from the layer housing has been reported to be equal to that from the reference system, i.e. 0.083 kg NH<sub>3</sub> per bird place per year. Odorous emissions are considered to be less than those of the reference system, because fewer anaerobic hotspots can develop.

**Cross-media effects:** These depend on the difference between the energy input for operating a frontloader once or twice a year to the energy required for operating a scraper every couple of days.

**Operational data:** There are no specific requirements for operating this system, other than for the scraper operation.

**Applicability:** It is a simple system but its application needs a separate storage facility. It is not expected that this system will be applied to any further new housing.

**Costs:** This is considered a low cost system.

**Reference farms:** Data on the application from the Netherlands, show that less than 1 % of layer farms apply this system.

**Reference literature:** [10, Netherlands, 1999], [26, LNV, 1994], [122, Netherlands, 2001]

### 4.5.1.4 Cage system with manure removal by way of manure belts to a closed storage

**Description:** The system incorporating belt removal of the manure is described in Section 2.2.1.1.5. Having clean belts and effecting frequent manure removal to a closed storage ensures low ammonia emissions from the housing area. A modification to the cage system ensures the removal of manure, through adding extensions on the feed hopper that sweep the droppings onto the belt that runs between the cages. This system needs an additional storage facility.

**Achieved environmental benefits:** The environmental performance of this system depends on the frequency of manure removal, although it is certainly better than the scraper system (Section 4.5.1.3), which usually leaves some manure behind. The higher the frequency of removal the lower the emission from the housing, e.g. if manure is removed at least twice a week a reduced emission of 0.035 kg NH<sub>3</sub> per bird place per year is reported. With a removal frequency of twice a day, the ammonia emission is reported to drop to 0.020 kg NH<sub>3</sub> per bird place per year.

Because the manure is transported out of the house and there is no manure residue on the manure belts, a lower odour level is obtained, which improves the climate in the house. With this system no manure drying occurs and wet manure leaves the housing to be stored elsewhere or to be immediately applied on land.

**Cross-media effects:** Application of this system needs additional energy to run the belts. The lowest emission is achieved by both applying the scraping device to the feed hopper and by running the manure belt more frequently. It is assumed that any extra energy required is only due to running the manure belt more frequently.

**Operational data:** Wet manure is produced instead of dry manure.

In the Netherlands this system is being phased out because of the high costs for selling this 'wet' manure and due to the relatively high ammonia emissions [179, Netherlands, 2001].

**Applicability:** Cages with manure belts can be used in new and existing buildings. They are usually applied with vertical tiered cages. The reference system would need full replacement. It is questionable whether the more frequent removal method can be considered an improvement compared to the more sophisticated systems available.

**Costs:** The extra investment costs of operating a twice-weekly removal compared with the open storage system are EUR 1.14 per bird place. The hopper construction required for a more frequent removal would require extra costs. These costs have not been reported. With a 58 % reduction of the emission (compared with the reference system) the relative costs are about EUR 23.6 per kg NH<sub>3</sub> abated. The extra operating costs per laying hen per year are EUR 0.17.



**Reference farms:** In the Netherlands about 3.524 million hens are kept in these systems. This system is only occasionally installed in a new building. Data on the application of the system with the feed hopper construction have not been submitted.

**Reference literature:** [10, Netherlands, 1999], [128, Netherlands, 2000] [179, Netherlands, 2001]

#### 4.5.1.5 Vertical tiered cages with manure belts and manure drying

In this section various designs that have been developed to dry the manure which is collected on the belt underneath the cages, inside the house, are presented, together with their associated environmental benefits.

##### 4.5.1.5.1 Vertical tiered cages with manure belts with forced air drying

**Description:** The manure from the laying hens is collected on a manure belt, of which there is one for each tier. Over the belt a perforated tube is placed which blows air (which may be preheated) over the manure on the belt. The manure is removed from the house once a week to a covered storage outside the house, where the manure can be stored for longer. On some farms, manure is put into a container and removed from the farm within two weeks.

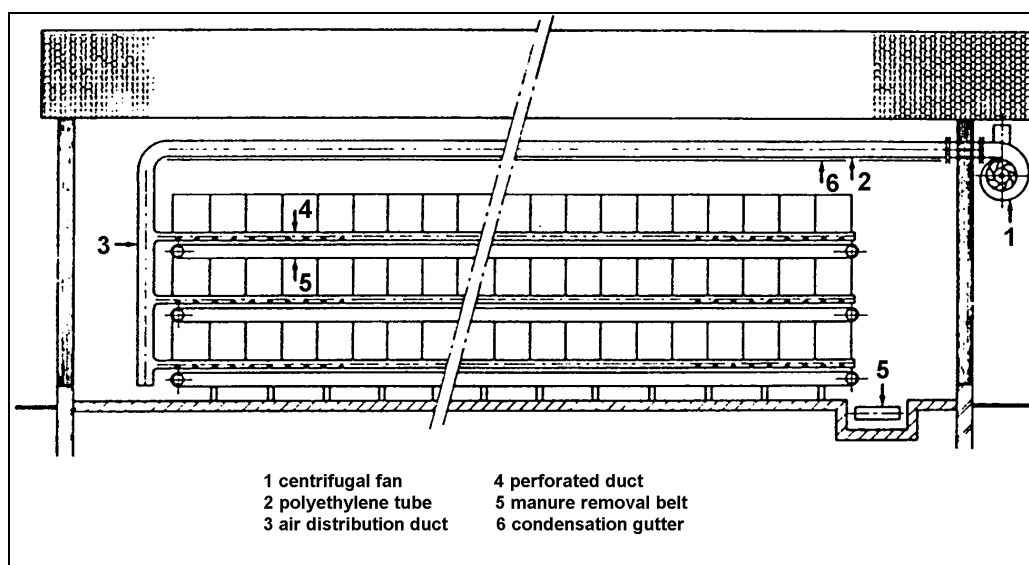
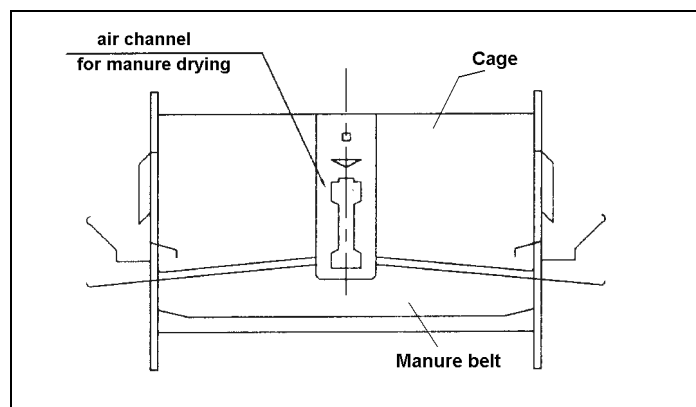

Figure 4.5: Schematic picture of a cage with forced (pneumatic) drying installation [10, Netherlands, 1999]



**Figure 4.6: Schematic picture of a design incorporating two cages and with a manure belt and a drying channel**  
[10, Netherlands, 1999]

**Achieved environmental benefits:** When a forced drying system is installed with a drying capacity of  $0.4 \text{ m}^3$  of air per laying hen per hour, then over a drying period of 7 days a dry matter content of the manure of at least 45 % is achieved. The  $\text{NH}_3$  emission is  $0.035 \text{ kg NH}_3$  per laying hen-place per year. No manure is left on the belts after removal.

**Cross-media effects:** Energy is required for operating the belts and the fans used to blow the air over the manure. Additional energy input is also required if preheating is applied. In modern cage houses, preheating is achieved by the application of a heat exchanger, in which outside air is drawn in and warmed up by the ventilation air that is emitted from the house. The level of extra energy input will vary; reported data show an extra  $1.0 - 1.6 \text{ kWh}$  per hen place per year used compared with the reference system, leading to a total energy use of 2 to 3 kWh per layer bird place per year.

**Operational data:** With this system it is possible to get a very low  $\text{NH}_3$  emission and to reduce odour in the house. The preheated air dries the manure, but an additional benefit is that the climate in the cages close to the animals is very good. This allows better production results to be achieved than with the reference system.

**Applicability:** This system can be applied in new and existing buildings with 3 tiers or more. The aeration installation could possibly even be added to an existing belt cage system which does not have drying equipment, but no practical example has been submitted.

**Costs:** The cost when compared with the reference system, must take into account that external manure storage may be simpler (no slurry, but dry manure) and that in vertical tiered cages more birds can be housed. Depending on inclusion of these cost factors, the extra investment costs vary and are reported to be between EUR 0.39 (I) and EUR 2.05 (NL) per bird place per year.

Additional energy costs will vary, as will the annual costs. Annual costs have been reported of EUR 0.193 (I) and EUR 0.57 (NL) per bird place per year.

Cost efficiencies vary widely. For a 60 % reduction compared with the reference system, its application in Italy would cost EUR 1.45 per kg  $\text{NH}_3$  abated, whereas in the Netherlands it would cost EUR 42.70 per kg  $\text{NH}_3$  abated.

**Reference farms:** In the Netherlands 14.598 million hens are kept in this system. The system with the  $\text{NH}_3$  emission of  $0.035 \text{ kg}$  per laying hen per year was developed about 12 years ago. Nowadays, this system is implemented in most new buildings and reconstructions.

**Reference literature:** [10, Netherlands, 1999]

#### 4.5.1.5.2 Vertical tiered cages with manure belt with whisk-forced air drying

**Description:** This system has the same design principle as the previous system (Section 4.5.1.5.1). A series of whisks are situated above the belt, with one whisk per set of two cages (back to back). Each whisk is operated by a connecting rod, which drives all the whisks in the row simultaneously, moving the air onto the manure on the belt (Figure 4.7). The difference from before is that the drying air is not collected from the outside, but is just the internal air moved over the manure belt. This can be an advantage because there is no need to preheat the air or to use heat exchangers, as is the case with air recirculators (subsequently there is also no dust clogging problems as on the exchangers or in the air ducts). The manure is removed from the house once a week, with a dry matter content of at least 50 %.

**Achieved environmental benefits:** The emission from this system is about 0.089 kg NH<sub>3</sub> per bird place per year (I). This represents a 40 % reduction in comparison with the reference system, with an emission level of 0.220 kg NH<sub>3</sub> per bird place per year (I).

**Cross-media effects:** The energy consumption of moving the whisks is lower than the energy consumption of the perforated duct system. However, there is some noise associated with the whisk movement.

**Operational data:** As with the previous system (Section 4.5.1.5.1), it is also possible to get low NH<sub>3</sub> emissions with this system. Because of the continuous air recirculation the climate in the house is good and the temperature throughout the house is uniform. Also, there appears to be less odour in the house in comparison with the previous technique.

**Applicability:** This system can be applied in new and existing buildings. It can be built in tiers, from 4 to 8. The whisk installation could possibly be added to an existing belt cage system which does not have drying equipment, but no practical example has been submitted.

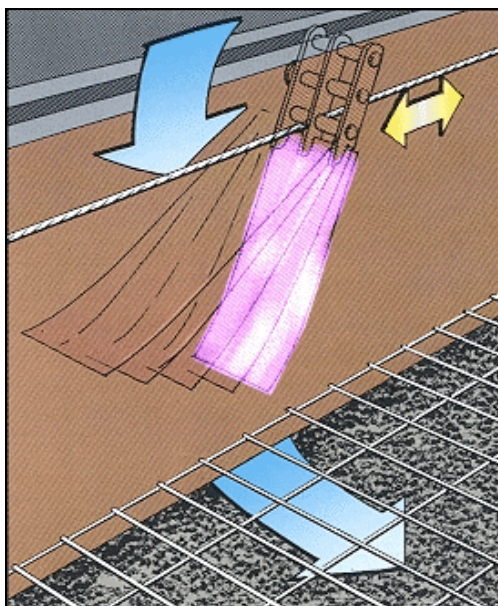

**Figure 4.7: Principle of whisk-forced air drying**  
[127, Italy, 2001]

**Costs:** Compared with the reference system, the extra investment is EUR 2.25 per bird place. The extra energy costs are 1.0 – 1.2 kWh per year per hen, which equates to 0.11 – 0.14 euros per year per bird place. The total extra costs (capital + running costs) are EUR 0.31 per bird place per year. This means, with a 60 % reduction of NH<sub>3</sub>-emission compared with the reference, costs of EUR 2.32 per kg NH<sub>3</sub> abated.

**Reference farms:** The system is currently being implemented on some large poultry farms in Italy. Approximately 700000 to 800000 laying hens are kept in this system.

**Reference literature:** [127, Italy, 2001]

### 4.5.1.5.3 Vertical tiered cages with manure belts with improved forced air drying

**Description:** The principle is as described in 4.5.1.5.1. The manure is removed from the house once every five days to a covered container that must be removed from the farm within two weeks. Drying manure in this system requires the installation of a forced drying system with a drying capacity of 0.7 m<sup>3</sup> per laying hen per hour and an air temperature of 17 °C. The maximum drying period is 5 days, and the manure must have a dry matter content of at least 55 %.

**Achieved environmental benefits:** The NH<sub>3</sub> emission from this system is 0.010 kg NH<sub>3</sub> per laying hen-place per year (NL) to 0.067 kg NH<sub>3</sub> per laying hen-place per year (I).

**Cross-media effects:** Odour levels in the house are perceived to be relatively low. Noise levels are considered to be similar to that of the system described earlier in Section 4.5.1.5.1. A high input of energy is required to dry the manure compared with the other air drying systems, but this can be reduced by preheating the incoming air. Dust levels are lower than in the other housing systems.

**Operational data:** With this system it is possible to get very low NH<sub>3</sub> emissions from the housing. Where the air is preheated, the manure becomes drier and the climate in the cages close to the animals improves, also leading to better production results. In modern laying houses preheating the drying air is done with a heat exchanger, in which the outgoing drying air warms the incoming air.

**Applicability:** This system can be applied in new and existing buildings. It can be built in tiers, from 3 to 10. There is no information about existing belt-systems being additionally equipped with this drying system.

**Costs:** This system is a low-cost system aimed at sites with large numbers of birds wanting to make efficient use of the available space with high stocking densities. However, large differences in costs have been reported. The lower costs reported by Italy are partly due to the extra revenue generated by the higher egg prices which were applied to help offset the costs of applying the improved system.

The extra investment compared to the reference system varies between EUR 0.65 (I) and EUR 2.50 (NL) per laying hen-place. Annual costs per laying hen per year vary between EUR 0.365 and 0.80 (including electricity costs). With a 70 – 88 % reduction of ammonia emission compared to the reference system, the cost efficiency varies between EUR 2.34 and 34.25 per kg NH<sub>3</sub> abated.

**Reference farms:** The system was developed in the late nineties. Currently, in the Netherlands about 2 million laying hens are kept in this system. Nowadays, these systems employing forced drying on the manure belts are implemented on large enterprises in new buildings, and in building conversions.

**Reference literature:** [10, Netherlands, 1999], [124, Germany, 2001], [127, Italy, 2001]

#### 4.5.1.5.4 Vertical tiered cages with manure belt with drying tunnel over the cages

**Description:** The design of the installation is similar to the previous air-dried belt systems in principle. The manure is collected on the belts under the cages and taken to one end of the row of cages. From here it is lifted up to drying belts within a drying tunnel above the cages, the drying tunnel running along the whole length of the row of cages. The manure is spread on the belts in the tunnel, where it dries. At the end of a complete run from one end of the tunnel to the other, the manure is discharged from each belt to the lowest belt inside the tunnel, which collects all the dried droppings and makes a last run to the opposite end. This action means that by the end of a full run the manure has a high dry matter content. The tunnel is ventilated by a centrifugal fan, which emits the air out of the roof through a chimney. The drying air is taken from inside the house, at the two opposite ends of the tunnel. The belts are moved every few minutes and the whole run inside the tunnel takes 24 – 36 hours.

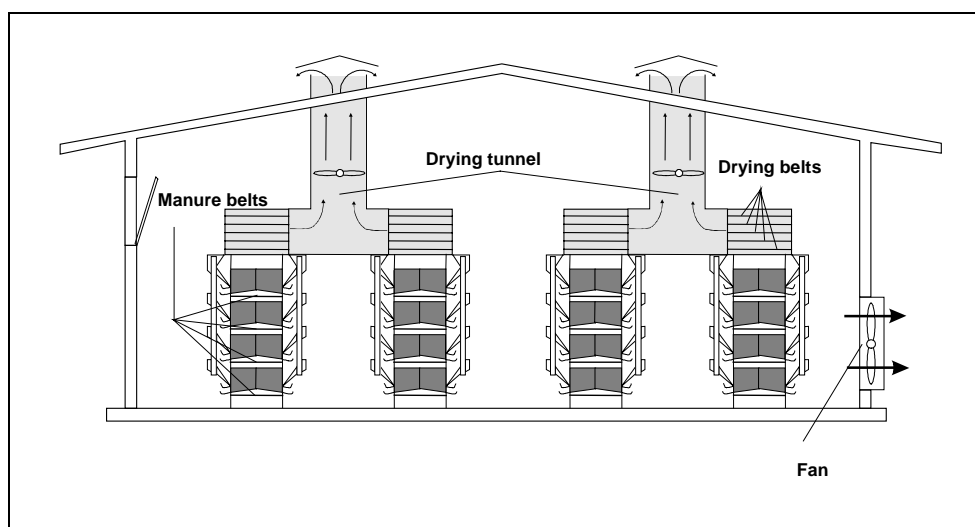

**Figure 4.8:** Schematic picture of a drying tunnel over vertical tiered cages

**Achieved environmental benefits:** Ammonia emission has been reported to be 0.015 (NL) to 0.045 (I) kg NH<sub>3</sub> per bird place per year. The manure can reach a very high dry matter content of close to 80 %.

**Cross-media effects:** Energy is required for ventilating the drying tunnel. The actual energy input will depend on the size of the installation (number of cages) and the resistance to airflow in the tunnel itself. Further information is needed to assess how changes in the design and operation might affect the energy requirements. By drawing away the inside air, the level of odour is thought to be very low.

**Operational data:** This system is typically operated in combination with house ventilation. Both ventilation systems will have to be synchronised so as to avoid any interference, as this could affect the operation of the tunnel system.

**Applicability:** It has been applied to cage systems with 4 to 6 tiers. The refurbishing or conversion of existing cage systems has not been reported, but application in existing buildings will require adaptations to the roof to add chimneys to exhaust the drying air. The height of the chimneys will affect the fan capacity and the energy input. Also, external storage of the dried manure is required (containers or other).

**Costs:** Costs are reported from Italy. The extra investment is EUR 2.79 per bird place. The extra costs for energy are 2.0 – 2.5 kWh per year per hen, equalling EUR 0.23 – 0.28 per bird place per year. The total extra costs (capital + running costs) are EUR 0.48 per bird place per year.

This means, that for a 80 % reduction of NH<sub>3</sub>-emission compared to the reference system, EUR 2.74 per kg NH<sub>3</sub> abated.

**Reference farms:** In Italy, approximately 1 million laying hens are kept in this system.

**Reference literature:** [127, Italy, 2001]

## 4.5.2 Techniques for non-cage housing of laying hens

Non-cage housing systems require a different management regime to egg production, and therefore need to be considered separately from the caged housing systems. There is little reported experience of any of these systems, so they are all given equal consideration. Therefore, no reference system has been identified, but the basic design described in Section 4.5.2.1.1 is used. A summary of the results is presented in Table 4.18.

Non-cage systems	NH <sub>3</sub> reduction (%)	Cross-media effects	Applicability	Costs <sup>1)</sup> (EUR/kg NH <sub>3</sub> reduced)
<b>Reference:</b> Section 4.5.2.1.1 Deep litter system for layers	0.315 (kg NH <sub>3</sub> /bird place/yr)	natural ventilation 80 % dm; dust	commonly applied	
Section 4.5.2.1.2 Deep litter with forced manure drying	60	<ul style="list-style-type: none"> <li>energy for airflow and air heating</li> </ul>	<ul style="list-style-type: none"> <li>floor construction requirements</li> </ul>	16.13
Section 4.5.2.1.3 Deep litter with perforated floor and forced drying	65	<ul style="list-style-type: none"> <li>energy for airflow and air heating</li> </ul>	<ul style="list-style-type: none"> <li>floor construction requirements</li> </ul>	n.d.
Section 4.5.2.2 Aviary system	71	<ul style="list-style-type: none"> <li>high dust levels</li> <li>energy depends on belt system</li> </ul>	<ul style="list-style-type: none"> <li>application special equipment</li> </ul>	n.d.
1) cost difference includes benefits (I) n.d. no data				

**Table 4.18:** Summary of the characteristics of techniques for non-cage housing of laying hens

### 4.5.2.1 Deep litter or floor regime systems

#### 4.5.2.1.1 Deep litter system for layers

**Description:** The deep litter system for layers has been described in Section 2.2.1.2.1.

**Achieved environmental benefits:** The ammonia emission is approximately 0.315 kg NH<sub>3</sub> per bird place per year.

**Cross-media effects:** If natural ventilation is applied, the energy input is relatively low. As manure is obtained with a dm-content of up to 80 %, a lot of dust can develop in the house as the birds move around freely.

**Operational data:** In the Dutch deep-litter houses, the stocking density is about 7 birds per m<sup>2</sup> and forced ventilation is applied. Given the high dust levels present, it is advisable for the farmer to use a face mask. Droppings and litter are removed from the pit at the end of the laying period.

For the birds, this system offers an almost full opportunity to display natural behavioural patterns. The house interior is structured in such a way that it has different functional areas. This makes the system more bird-friendly than cage confinement. Also from a technical perspective, uniform house ventilation and lighting can be achieved more easily than in a cage house, and bird observation is simple. However, a lesser performance (i.e. rate of lay) has been observed compared to cage and aviary regimes, and also the feed consumption is somewhat higher than under cage management, because the bird activity is higher whilst the stocking density is lower.

Reduced stocking density can also give rise to problems with moist litter material and a moist house climate in the winter season. This in turn results in higher energy requirements compared to cage and aviary houses. Large group sizes tend to encourage aggressive bird behaviour (occurrences of feather pecking and cannibalism). Occasional problems can also occur as eggs can be laid on the floor instead of in the laying nest. Intestinal parasites can also be a hazard as the birds have contact with the droppings and the litter material. When in-house manure storage is practised, ammonia concentrations in the inside air are higher than would have been if manure belts had been used to move the droppings regularly into an external storage pit.

**Applicability:** The system has been installed in existing constructions. A change from a cage system to this floor regime would require a complete revision of the system.

**Costs:** Higher costs are expected due to the lower performance of this system compared to other systems. Cost estimates [124, Germany, 2001] are reported to total EUR 20.90 per bird place and consist of:

- labour                      EUR 2.70 (at EUR 12.5/hr)
- capital investment      EUR 4.20 (11 % annual cost: 5 % depreciation, 2.5 % repair & maintenance, 7 % interest)
- operating cost            EUR 14.00
- Total costs:            EUR 20.90 per bird place

**Reference farms:** In the Netherlands, about 1000 of these houses have been built to accommodate 6 million layers, out of a total of 30 millions layers (i.e. about 20 %).

**Reference literature:** [128, Netherlands, 2000], [124, Germany, 2001] [179, Netherlands, 2001]

#### 4.5.2.1.2 Deep litter system with forced air manure drying

**Description:** This is based on the previous system but here the ammonia emission is reduced by applying forced ventilation. Forced ventilation is applied through tubes that blow 1.2 m<sup>3</sup> of air per bird place per hour at a temperature of 20 °C over the manure stored under the slats or over the manure being removed by the (aerated) belts.

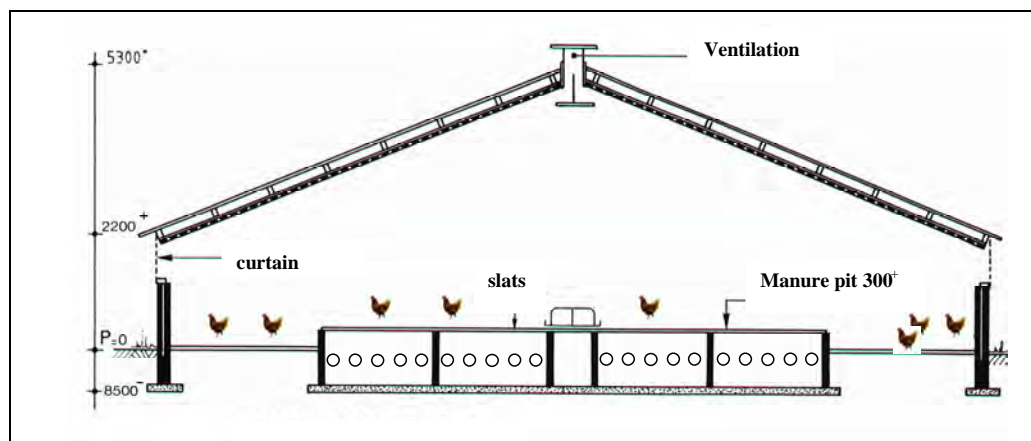

**Figure 4.9: Deep litter systems with forced drying via tubes under the slatted floor [128, Netherlands, 2000]**

**Achieved environmental benefits:** The application of forced ventilation and quick drying of the manure reduces emissions to 0.125 kg NH<sub>3</sub> per bird place per year for the pit storage. The ammonia reduction of this system is 60 % compared to the reference system (0.315 kg NH<sub>3</sub>). Frequent removal with (aerated) manure belts can be expected to give even lower emission levels.

**Cross-media effects:** Reduced odour levels can be expected compared to the reference system. The energy input in this system is high, because a heating system must be installed to achieve the 20 °C temperature necessary in the tubes. Extra energy is also required to maintain the airflow. Air is drawn in through inlets in the sidewalls and through an open ridge construction in the roof.

**Operational data:** Management of this system is principally the same as of the reference deep litter design.

**Applicability:** The system can only be used in laying hen houses with enough space underneath the slats. Traditionally the manure pit has a depth of 80 cm, but when using this system it is necessary to add an extra 70 cm. The experience from farmers already using the deep floor system is that they like this type of system because it requires very little change to the traditional design.

**Costs:** Compared with the reference system (Section 4.5.2.1), the extra investment costs are EUR 1.10 per bird place. The extra annual costs are EUR 0.17 per bird place. This means that with a 60 % ammonia reduction (0.315 to 0.125 kg NH<sub>3</sub>), the cost is about EUR 5.78 per kg NH<sub>3</sub> abated.

**Reference laying hen-places:** This system is very new; only one farm (40000 laying hens) in the Netherlands uses this system and about 5 % of the farms in Germany. It is expected that application of this system will increase in the future.

**Reference literature:** [122, Netherlands, 2001], [124, Germany, 2001] [181, Netherlands, 2002]

#### 4.5.2.1.3 Deep litter system with perforated floor and forced drying

**Description:** The layer house is traditional (walls, roof, etc.) The ratio of litter to “slatted floor” is 30:70. The laying nest area is included in the slatted floor area. There is a perforated floor underneath the manure and the slats, which allows transportation of the air used to dry the manure on top of it (Figure 4.10). The maximum load of this perforated floor is 400 kg/m<sup>2</sup>. The



distance between the bottom of the pit and the perforated floor (air-channel) must be 10 cm. The perforated floor has a total area of air openings of 20 % of the surface area.

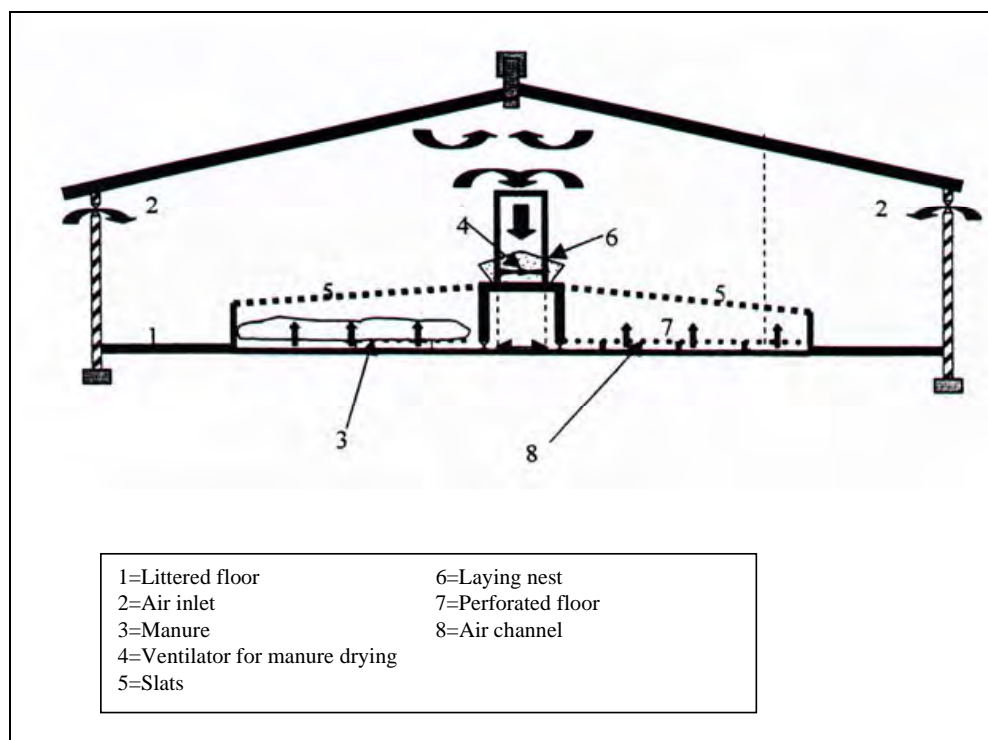

**Figure 4.10: Deep litter system with perforated floor and forced manure drying**  
[128, Netherlands, 2000]

**Achieved environmental benefits:** It is possible to obtain a 65 % reduction in  $\text{NH}_3$ -emissions (0.110 kg compared to the 0.315 kg  $\text{NH}_3$  per bird place per year of the reference system).

**Cross-media effects:** Higher energy input is required because of the forced ventilation.

**Operational data:** The layer droppings fall through the slats onto the perforated floor. At the beginning of the laying period the perforated floor is provided with a 4 cm thick bed of woodshavings. The (preheated) air is blown from beneath through the small openings in the perforated floor under the manure. To dry the manure properly, ventilators with a total capacity of 7 m<sup>3</sup> air/hour at 90 Pascal are installed. The manure stays on the perforated floor for about 50 weeks (laying period) and is then taken out of the house. The minimum distance between the perforated floor and the slats is 80 cm. The manure is dried constantly by the continuous flow of air. The dry matter content of the manure is about 75 %. The farmer should protect himself with a face mask.

The drinking facilities must be installed on top of the slats, but good design of the tubes should avoid loss of water.

**Applicability:** Application in new situations is more likely, but it could also be installed in existing houses, but at an additional cost.

**Costs:** Investment costs are EUR 1.20 per birdplace and annual costs are EUR 0.18 per bird.

**Reference farms:** In the Netherlands, about 10 farms (year 2001) are currently applying this system.

**Reference literature:** [128, Netherlands, 2000] [179, Netherlands, 2001] [181, Netherlands, 2002]

### 4.5.2.2 Aviary system

**Description:** Description is given in Section 2.2.1.2.2.

**Achieved environmental benefits:** Data on ammonia emissions have only been reported by the Netherlands, with values of 0.09 kg NH<sub>3</sub> per bird place per year, which is 71 % less than the reference non-cage system. This emission reduction is related to the manure removal, where about 90 % of all the manure is removed by belts at a frequency of at least once a week. The other 10 % of the manure is removed from the litter area after one cycle. [179, Netherlands, 2001]

**Cross-media effects:** When compared to the cage regime, a distinctly higher dust content in the in-house air is reported. This gives a higher stress effect on the mucous membranes of humans and animals. Energy requirements depend particularly on the ventilation and vary between 2.70 kWh per bird place per year for non-belt systems to 3.70 kWh per bird place per year for aerated manure belt systems.

**Operational data:** Hens enjoy more freedom of movement than their counterparts under cage management, but replacement pullets must come from aviary grower houses. Aviary systems are more bird-friendly than, by comparison, conventional floor management systems, since the hens' living space is more heavily structured. More favourable temperature conditions in winter are observed due to a higher stocking density. Feed conversion and the rate of lay are also better than in floor regimes. The available in-house space can be supplemented by providing an outside scratching area.

However, the birds can have contact with faeces, which creates a hazard from intestinal parasites. Also, the system shows a higher percentage of soiled and/or "laid-away" eggs. Another negative effect is that having larger groups and introducing natural daylight also promotes aggressive bird behaviour and incidences of feather pecking and cannibalism are possible, resulting in a higher potential loss rate. Bird observation is more difficult and medication requirements tend to be higher.

**Applicability:** Aviary housing systems are still little used compared with cage or floor regimes, but a reasonable amount of practical experience has been gathered. Since there is no significant demand for eggs from house-confined aviary systems, in Germany this housing system is currently only practised in combination with outdoor ranges.

**Costs:** Costs for the design with aerated manure belt removal total EUR 16.5 to 22.0 per bird place per year:

- labour                      EUR 1.2 – 2 (at EUR 12.5/hr)
- capital investment      EUR 2.4 – 5.6 (11 % annual cost: 5 % depreciation, 2.5 % repair and maintenance, 7 % interest)
- operating cost            EUR 12.9 – 14.4 [124, Germany, 2001]
- Total costs              EUR 16.5 – 22.0

**Driving force for implementation:** The implementation of aviary systems may increase for animal welfare reasons. Another driving force might be the decision of the EC (Commission Regulation No 1651/2001) that, in order to indicate the farming method, no terms may be used on eggs other than 'free range', 'barn' or 'cage'. [179, Netherlands, 2001].

**Reference farms:** In general, the number of houses with aviary systems is small. Data reported by the Netherlands show that about 3 % (649000) of the layers are kept in aviaries and on less than 1 % of the farms.

**Reference literature:** See fact sheets [124, Germany, 2001]

### 4.5.3 Techniques for housing of broilers

Traditionally, broilers are kept in houses with a fully littered floor (see Section 2.2.2). Both for animal welfare reasons and to minimise ammonia emissions wet litter must be avoided. The dry matter content of the litter depends on:

- the drinking system
- length of the growing period
- the stocking density
- the use of floor insulation.

In the Netherlands a new housing technique was designed to avoid or minimise wet litter. In this improved design (known as VEA-system, the Dutch abbreviation for “broiler low emission housing”) attention is paid to the insulation of the building, to the drinking system (to avoid spillage) and to the application of wood shavings/sawdust. However, accurate measurements in fact show that both the traditional system and the VEA-system have the same ammonia emissions of 0.08 kg NH<sub>3</sub> per broiler place per year (NL).

The emission level 0.08 kg NH<sub>3</sub> per broiler place per year is considered as the reference level.

In the Netherlands, where a number of techniques have been developed, only a few new low-ammonia systems are being installed at the moment. All newly developed systems that are presented in this section originate from the Netherlands and have a forced drying system that blows air through a layer consisting of litter and droppings [10, Netherlands, 1999] [35, Berckmans et al., 1998]

It is obvious that as the ventilation rate depends on the natural airflow, design of the house and both the air inlets and outlets is crucial. Energy consumption (and costs) is lower than with the fan-ventilated house.

Housing technique	NH <sub>3</sub> reduction (%)	Cross-media effects	Applicability	Annual costs (EUR/kg NH <sub>3</sub> reduced)
<b>Reference:</b> Deep litter fan ventilated house	0.080 (kg NH <sub>3</sub> / bird place/year)	<ul style="list-style-type: none"> <li>• dust levels</li> <li>• energy input depends on ventilation system</li> </ul>	<ul style="list-style-type: none"> <li>• commonly applied</li> </ul>	
Section 4.5.3.1 Perforated floor with forced air drying system	83	<ul style="list-style-type: none"> <li>• high energy input</li> </ul>	<ul style="list-style-type: none"> <li>• based on reference</li> </ul>	2.73
Section 4.5.3.2 Tiered floor-system with a floating floor and forced drying	94	<ul style="list-style-type: none"> <li>• high energy input</li> <li>• increased dust levels</li> </ul>	<ul style="list-style-type: none"> <li>• requires tiered installation</li> </ul>	2.13
Section 4.5.3.3 Tiered cage with removable cage sides and forced air drying of manure	94	<ul style="list-style-type: none"> <li>• high energy input</li> <li>• similar dust levels</li> <li>• low dust levels if no litter is applied</li> </ul>	<ul style="list-style-type: none"> <li>• requires tiered installation</li> <li>• limited for welfare reasons</li> </ul>	2.13

**Table 4.19: Summary of characteristics of system-integrated techniques for the housing of broilers**

### 4.5.3.1 Perforated floor with forced air drying system

**Description:** The housing system is similar to the reference broiler house (Section 2.2.2). This system has a double floor. The upper floor has perforations with a minimum surface area of 4 % of the total floor area. The perforations are protected by a plastic or metal grid. A continuous upward air stream flows through the perforated floor with a minimum capacity of 2 m<sup>3</sup> per hour per broiler place. The perforated floor is covered with litter. Manure and litter remain on the floor for the whole growing period (about 6 weeks). The continuous airflow dries the litter (>70 % dry matter) and this results in reduced ammonia emissions. Improved designs can improve the distribution of the drying air by channelling the air stream. See Figure 4.11.

**Achieved environmental benefits:** Aeration of the litter and droppings leads to a large reduction in ammonia emissions, achieving an emission level of 0.014 kg NH<sub>3</sub> per broiler place per year (compared to the reference with 0.080 kg NH<sub>3</sub> per broiler place per year).

**Cross-media effects:** High energy input is required because of the forced ventilation, which doubles the power use and costs compared with the reference.

**Operational data:** Species-specific behavioural patterns are possible, but in these large groups this also means that social ranking fights will also occur. This system is applied in closed housing systems. In summertime the temperature of the inside air is lower due to the effect of air being cooled down in the double layer concrete floor. As this air stream is close to the animals it will improve the in-house conditions. If the power is interrupted, then no ventilation can occur, which in conditions with high temperatures may lead to a rapid rise in indoor temperatures (with a subsequent increase in ammonia and emission levels and a possible loss of birds).

As the dry matter content of the manure is high at 80 %, there is a lot of dust in the broiler house. The animals are cleaner, but the farmer needs to protect himself with an air mask. Mucking out and cleaning between growing periods requires more labour.

**Applicability:** The system can only be used in new buildings, as a sufficient pit depth (2 m) under the perforated floor is necessary and that will not normally be available in existing buildings. With an improved design a lower depth will be required.

**Costs:** Compared with the reference, this system has an extra investment cost of about EUR 3 per broiler place, which means that it is about 25 % more expensive. This is equal to an extra investment per kg NH<sub>3</sub> reduced emission of EUR 45.5 ((1000 gram/(80 gram-14 gram)\* EUR 3). A further calculation can be made including the extra investment costs for the perforated floor of EUR 65.90 per m<sup>2</sup> and a stocking density of 20 broilers per m<sup>2</sup>. In this case the extra running costs are EUR 0.37 per broiler place per year.

Only a few farms are currently applying this system because of the high costs and because the benefits are limited to a reduction in the NH<sub>3</sub> emission only [179, Netherlands, 2001].

**Reference farms/broiler places:** In the Netherlands about 450000 broilers are kept in this type of system. The system is still new. In some central European countries it is applied experimentally.

**Reference literature:** [23, VROM/LNV, 1996], [124, Germany, 2001], [128, Netherlands, 2000].

A.

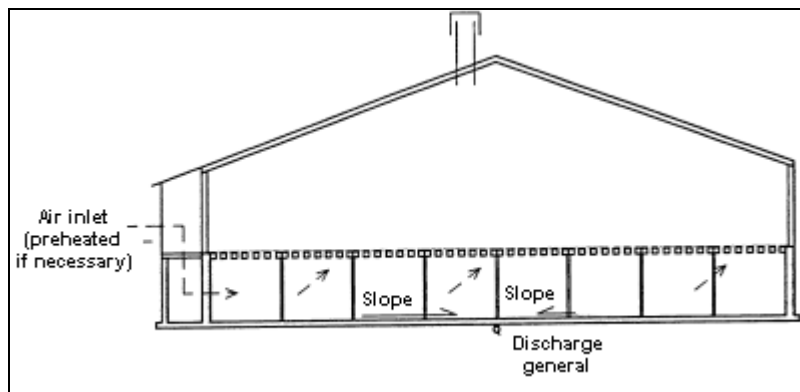

B.

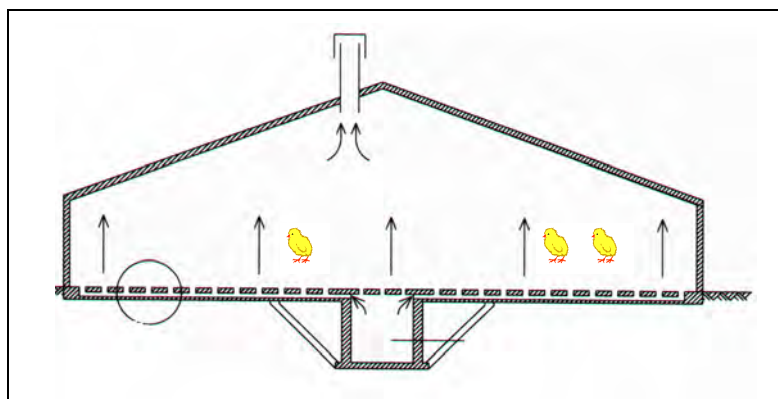

C.

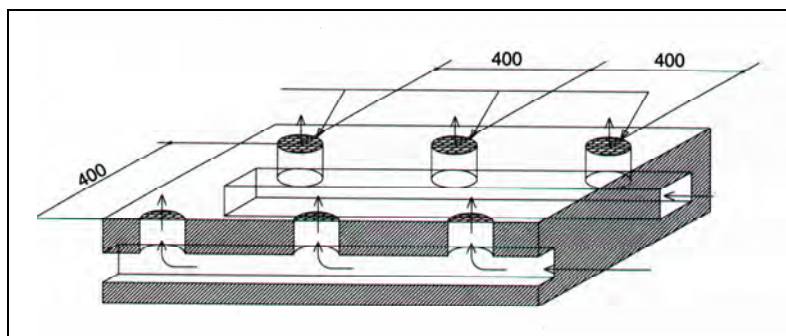

**Figure 4.11: Schematic representation of a forced drying system with a perforated floor for broilers (A), an improved design (B), and a detail of the floor of the improved design (C) [128, Netherlands, 2000]**

#### 4.5.3.2 Tiered floor system with forced air drying for broilers

**Description:** The system is characterised by a continuous downward or upward draught through a tiered floor arrangement that is covered with litter. The ventilation air is removed through dedicated ventilation ducts under the tiered floor ( $4.5 \text{ m}^3$  per hr per broiler place). The floating floor is made of a perforated polypropylene belt. The compartments in which the animals live have a width of 3 m and a length according to the length of the house. The floor system is composed of tiers (3 or 4). After the growing period the moveable floor can transport the broilers to the end of the house where the animals are placed in containers for transport to the slaughterhouse.

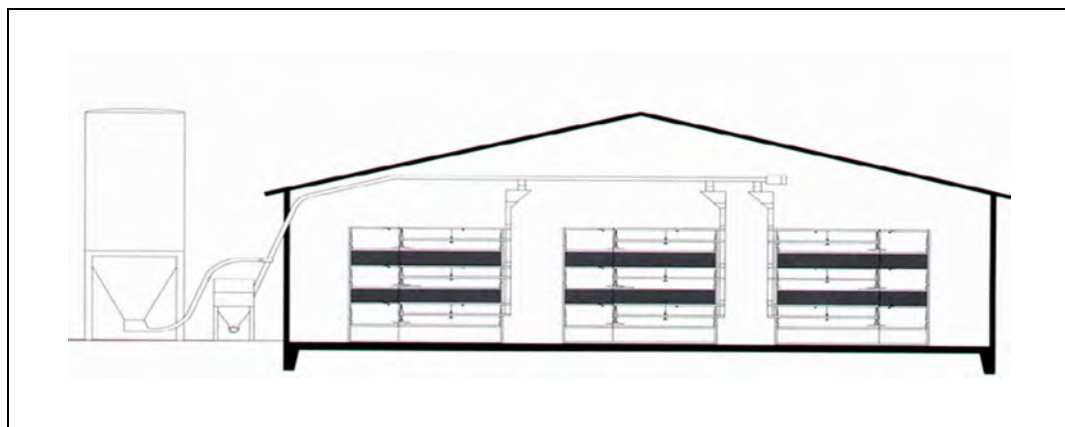

**Figure 4.12: Schematic cross-section and principle of a tiered floor system with forced drying (upward flow) for broilers [10, Netherlands, 1999]**

**Achieved environmental benefits:** Ammonia emission is reduced to 0.005 kg NH<sub>3</sub> per broiler place per year (94 % compared to the reference system, which has an emission of 0.080 kg NH<sub>3</sub> per broiler place per year).

**Cross-media effects:** More electricity is needed to operate the ventilation air fans.

**Operational data:** In summer there is less heat-stress on the animals because there is an air stream close to them. The animals are clean because the litter is dry. With the upward movement of the air and a manure dm-content of 80 %, dust problems might arise and the use of a face mask is recommended for farmers. Dust is less of a problem with the downward flow design.

**Applicability:** This system can be applied in new and existing broiler houses. As the system is built up in tiers, the building must have sufficient height to install the system.

**Costs:** Compared to the reference, costs for the downward flow design need an extra investment of EUR 2.27 per broiler place, which means EUR 36 per kg NH<sub>3</sub>. The extra annual costs are EUR 0.38 per broiler place.

**Reference farms:** This system has been recently developed. In the Netherlands about 45000 broilers are kept in this system on one farm. In some central European countries it is still under experimentation.

**Reference literature:** [23, VROM/LNV, 1996], [128, Netherlands, 2000].

#### **4.5.3.3 Tiered cage system with removable cage sides and forced drying of manure**

**Description:** This system is a modification of the system described in Section 4.5.3.2. See also Figure 4.13 and Figure 4.14 shown below. The system is a cage system with several tiers. The broiler house itself is a conventional housing construction, fan ventilated. The system has tiers 1.5 metres wide, in 6-metre-long sections. Each tier has coated slats that allow the air to pass through over their full length. A layer of woodshavings covers the slats allowing the broilers to scratch and to defecate.

Air tubes are situated at the sides of the system for fresh air and to dry the manure on the belts. In the middle of every tier is an additional tube for fresh air for the broilers. At the end of every 6 weeks growing period the sides of the cages are taken away and the broilers are taken out via

a moving belt. The manure is transported on the same belt to a closed container and transported from the farm. This system has also been applied without litter.

**Achieved environmental benefits:** The ammonia emission is reduced by 94 % and is similar to the emission from the tiered floor system, i.e. 0.005 kg NH<sub>3</sub> per broiler place per year. The application of litter does not seem to effect the ammonia emission.

**Cross-media effects:** Compared with the reference, more energy is required; this is because of the forced ventilation. It can be expected that dust levels in the non-litter system are lower than in the littered system. It is also assumed that the energy input for forced drying is similar. It is speculated that the frequent removal of manure may have a considerable effect on the emission reduction. In the previous system the droppings remain on the belt for the whole growing period and this may require a more reliable high airflow to achieve the same reduction.

**Operational data:** Also, the odour in the broiler house is strongly reduced. Different from the floating floor system, is that there is more dust in the house as the dry manure is up to 80 % dry matter. The farmer may have to protect himself with an air mask.

In the non-litter design, conditions for both the birds and the farmer are better with a lower dust level, but at the same time, the lack of litter may have adverse effects on the bird behaviour. Possibly less labour is involved for mucking out and cleaning in the non-litter type housing system.

**Applicability:** This system does not require changes to the construction of a broiler house. The cage system is specific and would have to be newly installed. The technical and environmental results are very good, but welfare considerations may limit further application.

**Costs:** The extra investment cost is EUR 3 (ca. 25 %) on a total investment of EUR 12 per broiler place. The broiler sale price increased by about 15 %. The extra investment compared to the reference is EUR 40 per kg NH<sub>3</sub> reduced ( $((1000 \text{ gram}/(80 \text{ gram}-5 \text{ gram})) * \text{EUR } 3)$ ).

**Reference farms/broiler places:** Very few farms in the Netherlands (less than 1 %) apply these systems. No other applications in Europe have been reported.

**Reference literature:** [23, VROM/LNV, 1996], [128, Netherlands, 2000]

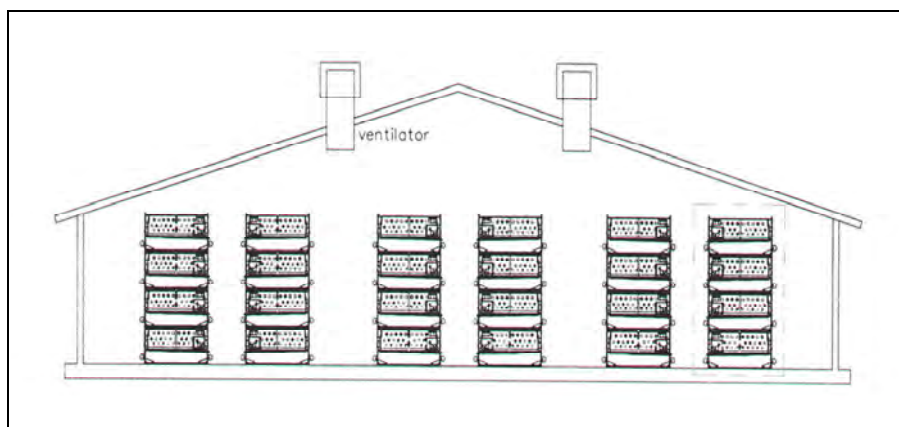
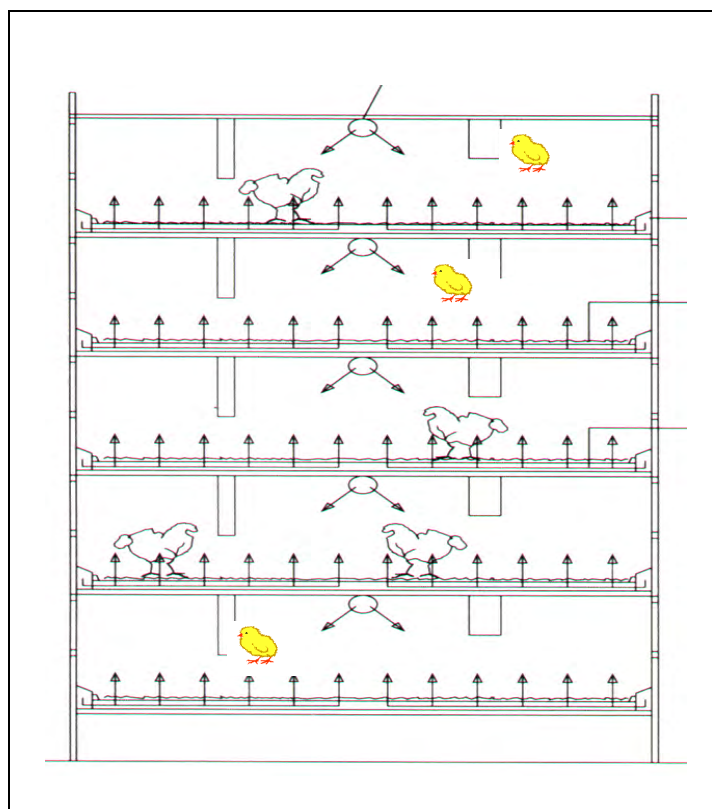

Figure 4.13: Schematic representation of a littered tiered cage system in a broiler house [128, Netherlands, 2000]



**Figure 4.14: Schematic cross-section of a cage in a littered tiered cage system [128, Netherlands, 2000]**

#### 4.5.4 Techniques for housing of turkeys

**Description:** The commonly applied techniques for the housing of turkeys are described in Section 2.2.3.1.1.

**Achieved environmental benefits:** The ammonia emissions has been measured under practical conditions in a commonly used turkey house with a fully littered floor and has been found to be 0.680 kg NH<sub>3</sub> per turkey place per year. The associated feeding regime has not been reported. Naturally ventilated or open housing may have lower emissions and odour levels, but getting accurate measurements will be difficult.

**Cross-media effects:** As the house can either be closed or an open house with or without forced ventilation, the energy use will vary. For an open house (100 x 16 x 6 m<sup>3</sup>) without forced ventilation, the energy use was reported to be approximately 1.50 kWh per bird place per year. For forced ventilation this will be higher.

**Operational data:** Housing and management regimes are adapted to the turkeys' requirements. Checking the birds and equipment regularly is a 'must' in order to operate at the maximum efficiency. Turkeys enjoy freedom of movement, and the placement of feeders and drinkers is such that the birds can locate them rapidly. Numerous turkey-specific behavioural patterns can be displayed, e.g. scratching, dust bathing, stretching of limbs and fluttering of wings; contact with housemates is not restricted. Groups with a stable social (pecking) order are established. Quality of the in-house environment is considered to be better in open than in closed houses.

**Applicability:** Most of the houses on commercial turkey farms apply this type of house without any limitations to constructions or special requirements other than those described in Section 2.2.3.1.1.



**Costs:** The open-house naturally-ventilated house is considered to be a cheaper system than the closed housing system. Total costs estimates from Germany [124, Germany, 2001] have been reported (50/50 male/female-ratio) as EUR 34.71 per bird place per year:

- labour costs           EUR on average 1.8 (at EUR 12.5/hr)
- capital investment    EUR 4.46 (11 % annual cost: 5 % depreciation, 2.5 % repair and maintenance, 7 % interest)
- operating costs        EUR 28.45
- Total costs         EUR 34.71

**Reference farms:** In Germany many farms apply closed housing systems, but there is a tendency to apply open housing in new units. In the Netherlands, 120 turkey houses (99 %) apply this (closed) system.

**Reference literature:** [128, Netherlands, 2000], [124, Germany, 2001]

## 4.5.5 End-of-pipe techniques for the reduction of air emissions from poultry housing

### 4.5.5.1 Chemical wet scrubber

**Description:** In this system (see Figure 4.15) all the ventilation air from the housing is passed through a chemical-scrubbing unit before being emitted into the environment. In the chemical wet scrubber unit an acid scrubbing liquid is pumped around, and absorbs ammonia on contact with the ventilation air. After the absorption the clean air leaves the system. Diluted sulphuric acid is mostly used in this system as the scrubbing liquid, but hydrochloric acid may also be used instead. Ammonia absorption takes place following the reaction:

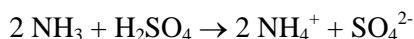

**Achieved environmental benefits:** The percentage reduction of ammonia for a commonly applied deep litter system for layers and for a commonly applied broiler housing system are presented in Table 4.20.

**Cross-media effects:** This system requires the storage of chemicals. A possible limiting factor to the application of this technique is that a higher sulphate or chloride level, depending on the acid used, can be expected in the effluent. Applying scrubbing also raises the energy consumption level of the farm.

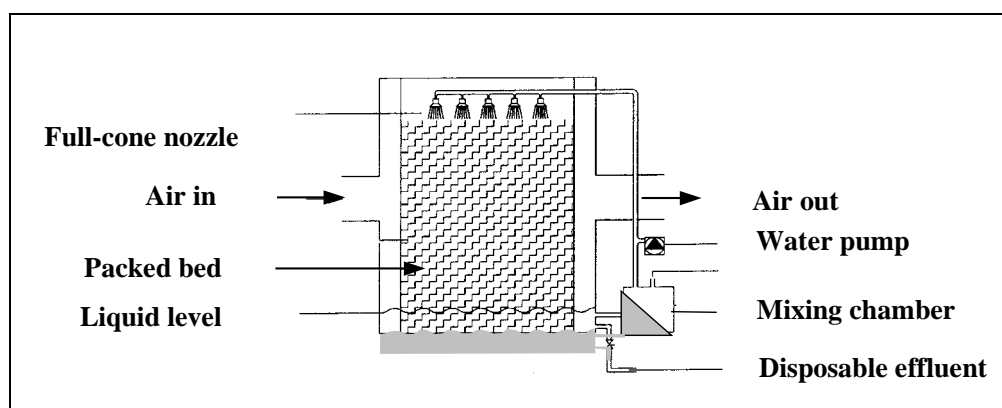

Figure 4.15: Schematic picture of a chemical wet scrubber design [10, Netherlands, 1999]

**Applicability:** This system, as an end-of-pipe technique, can be implemented to any house, new or existing, in which the airflow can be directed towards a single point where the air enters the scrubber. This technique is not suitable for naturally ventilated houses.

High dust levels in the exhaust air from the housing can affect the scrubbing performance. This will make it less suitable for housing systems that produce high dm-levels in the manure or for applications in dry climates. A dust filter may be necessary, which will increase pressure in the system and raise the energy use. The system requires frequent monitoring and control, which will increase labour costs.

**Costs:** See information in Table 4.20 shown below. The explanation of the data is as follows: for broilers the reference ammonia emission is 0.08 kg per bird per year, the reduction by applying a wet scrubber is 81 %, resulting in an emission of 0.015 kg per bird per year. Per broiler place the cost for this reduction is EUR 3.18 and per kilogram of ammonia the costs are:  $(1000/65) * 3.18 = \text{EUR } 48.92$ . This explanation is also valid for calculating the costs for layers. [181, Netherlands, 2002]

Performance	Type of poultry	
	Layers (deep litter)	Broilers
Emission NH <sub>3</sub> kg/ bird place/year	0.095	0.015
Reduction percentage (%) <sup>1)</sup>	70	81
Extra investment costs (EUR/place)	3.18	3.18
Extra investment costs (EUR/kg NH <sub>3</sub> )	145.50	48.92
Extra annual costs (EUR/place)	6.70	0.66
<i>1) for layers the reference ammonia emission is 0.032 kg/bird/year and for broilers this is 0.080 kg/bird/year</i>		

**Table 4.20: Summary of operational and cost data of a chemical wet scrubber for emissions from layer and broiler housing**

**Reference farms/broiler places:** In the Netherlands about 1 million layers and 50000 broilers are kept in housing equipped with chemical wet scrubbers.

**Reference literature:** [10, Netherlands, 1999]

#### 4.5.5.2 External drying tunnel with perforated manure belts

**Description:** The manure is extracted on belts from the laying hen house and sent to the upper belt of a drying tunnel, essentially formed from the spaces in between several tiers of the punched belt, with the manure carried along the belt from one end to the other and then in the reverse direction in the lower tiers (see Figure 4.16). At the end of the run on the lower belt, the manure has a 65 – 75 % dry matter content and is discharged to a covered storage or to a container. The tunnel is ventilated, extracting the air from the hen house, so limited additional electric power is necessary. The tunnel is usually built at the side of the hen house.

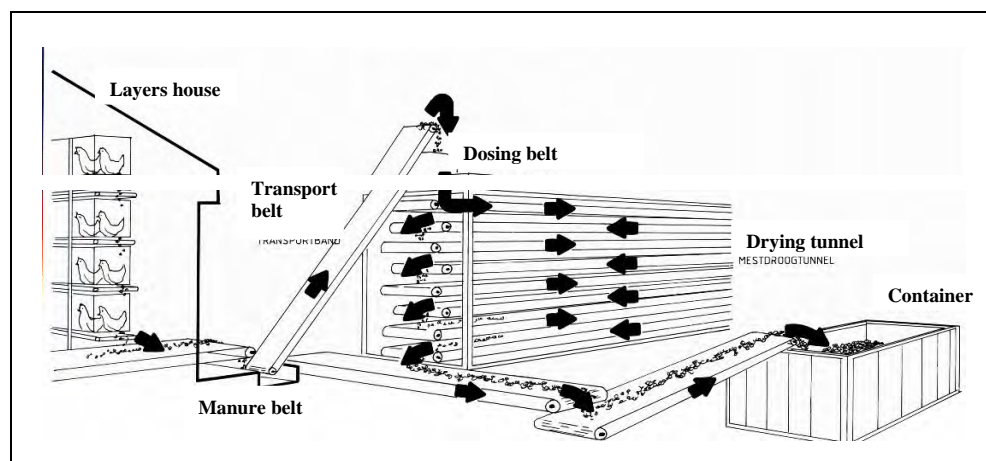

**Figure 4.16: Principle of external drying tunnel with perforated manure belts**  
[128, Netherlands, 2000]

**Achieved environmental benefits:** The reported emission from the housing is 0.067 kg NH<sub>3</sub> per bird place per year, but it is not clear whether this represents the emission of the total system, i.e. including the emission from the drying tunnel.

**Cross-media effects:** Only limited extra energy (electricity) is needed to ventilate this system, because the fans for the drying tunnel are the same as those used for the ventilation of the hen house. Although at the same time more belts have to be operated, so extra energy is required to operate the extra belts. The odour levels in the cage house are likely to be lower than where manure is dried within the house.

**Operational data:** It is possible to get a very low dry matter content manure in a short time. If regular container transport cannot be operated, a separate storage facility will be necessary for the dried manure

**Applicability:** This system can be applied to new houses, but it is particularly suitable for existing houses because it hardly interferes with the existing structures. It just requires a means of extracting warm air to supply the drying tunnel.

**Costs:** Cost data relate to its application in Italy. Although investment costs have not been reported, the extra investment costs for the tunnel may be offset by the fact that the cost for the external manure storage is lower. The extra costs for energy are limited, equal to only EUR 0.03 per bird place per year. The total extra running cost (including capital + running costs) is EUR 0.06 per bird place per year. This means that with a 70 % NH<sub>3</sub> reduction, the cost is EUR 0.37 per kg NH<sub>3</sub> abated.

**Reference farms:** A few applications in Italy have been reported.

**Reference literature:** [127, Italy, 2001], [128, Netherlands, 2000]

## 4.6 Techniques for reducing emissions from pig housing

This section reflects the information submitted on techniques that aim to reduce emissions from pig housing facilities. The information available entirely focuses on the emission to air of NH<sub>3</sub>. Techniques can be divided into the following categories:

- integrated techniques
  - nutritional measures to reduce the amount and the N-content of manure (Section 4.2)
  - control of the indoor housing climate
  - optimisation of pig housing design
- end-of-pipe techniques.

Nutritional measures were described in Section 4.2 for preventing the emissions from the housing by reducing the concentration of nitrogen in manure. Although many more factors influence the level of emissions to air, differences in diets should be clear to allow a correct interpretation of the performance data of alternative housing techniques.

In many cases, the information submitted on housing designs and their associated ammonia emission levels did not indicate whether reduced N-diets had been applied. It is therefore not always clear, whether the performance of housing could be attributed entirely to the change in design or whether it could also have been partly due to other factors, such as feeding techniques. It is assumed that in general phase feeding has been applied and that emission levels (factors) can be compared. To eliminate such effects or to allow interpretation of differences in measurements, it is important to use defined measuring protocols that standardise conditions of feeding and other management aspects to allow comparison of emissions (see e.g. Annex 7.5).

Control of the indoor housing, in terms of reducing the air velocity at the manure surface and having low indoor temperatures (less fouling of floors), can reduce emissions even more. Optimum control of the housing environment, particularly during summer, can contribute to ensuring that the animals drop their excrement in the dunging area while the lying and exercise areas remain clean and dry. Low volume flows, low air inlet temperatures, and low air velocities in the livestock area and above the housing floors all reduce the occurrence and release of air-polluting substances in the housing. The flow pattern of the air in the housing can be favourably influenced by the position and dimensioning of the supply and waste air apertures (e.g. side wall or gable extraction, or linear extraction through waste air ducting). Incoming air conduction through perforated ducts and porous ceilings results in low air velocities in the livestock area. Air inlet temperatures and volume flows can be reduced by, for example, locating the fresh air intake in shady zones, or ducting the air via the feeding passage or via an earth (or water) heat exchanger.

These factors must be controlled to meet the pigs' needs and often require a certain energy input. The evaluation and quantification of emission reductions through the application of these techniques are complex and clear conclusions have not been reported.

A lot of attention is paid to housing design, i.e. the combination of the floor-system, manure collection and the manure removal system. The housing systems described basically involve some or all of the following principles:

- reducing emitting manure surfaces
- removing the manure (slurry) from the pit to external slurry store
- applying an additional treatment, such as aeration, to obtain flushing liquid
- cooling the manure surface
- changing the chemical/physical properties of the manure, such as decreasing the pH
- using surfaces which are smooth and easy to clean.

A few general remarks can be made. The reduction of fully-slatted to 50 % slatted floor surface reduces the emitting manure surface by approximately 20 %, where any manure remaining on the solid floor part also has to be taken into account. The 50 % slatted floor system works well in the winter, but not so well in the summer [183, NFU/NPA, 2001]. Also the effect of slatted floors was found to be larger when the ratio of the slat width and the opening between the slats was closer to 1. The application of a softer material for these floors was reported to reduce ammonia evaporation by nearly 30 %. In underfloor extraction, higher emissions occur if the distance between the slurry surface and the bottom edge of the slatted floor is less than 50 cm.

In principle, the emission is smaller with a smaller slatted surface and a smaller emitting surface of the manure, but it is important to choose the optimum ratio between slatted and non-slatted surface area. Increasing the non-slatted area will result in more manure remaining on the solid part and possibly a rise in ammonia emissions. Whether this happens or not depends largely on the amount of urine and the speed with which it can run off, as well as with the distance to the pit. A convex smooth floor will enhance urine removal, but the animal safety needs to be taken into account.

Manure removal is considered to be effective (e.g. by scrapers (80 % reduction) or flushing (70 % reduction)), but in some categories the effect is not always clear (e.g. with finishers and gestating sows). The physical structure of the manure and the smoothness of the pit floor surface may affect the reducing effect on the ammonia emissions that the removal through scraping usually provides.

With respect to litter, it is expected that the use of litter in pig housing will increase throughout the EU due to the raised awareness of animal welfare. Litter can be applied in conjunction with (automatically) controlled naturally ventilated housing systems, where the litter would allow the animals to control their own temperature, and would thereby reduce the amount of energy needed for ventilation and heating. The production of solid manure instead of slurry manure is considered an advantage from the agronomic point of view, in so far as organic matter incorporated in the fields improves the physical characteristics of the soil, thereby reducing run-off and the leaching of nutrients to water bodies.

To enable easy comparison, techniques are described per IPPC pig category. The reductions achieved, the costs of application and the main important characteristics are summarised in a table preceding the descriptions of housing for each pig category. For comparing the performance and the cost data of reduction techniques it is considered practical to select a reference technique for each pig category. This approach selects the technique associated with the highest ammonia emission levels and allows other techniques to be assessed for their relative environmental performance (reduction percentage). Relative values then merely give an indication of the achievable level, rather than an absolute value, which depends on many more factors than just the housing configuration.

Although CH<sub>4</sub>, nmVOC and N<sub>2</sub>O are worth considering, NH<sub>3</sub> has been given most attention as the key air pollutant as it is emitted in the highest quantities. Nearly all the information provided on the reductions of emissions from animal pig housing reported on the emission reduction of NH<sub>3</sub>. It is assumed that techniques that reduce NH<sub>3</sub> emissions will also reduce emissions of the other gaseous substances [59, Italy, 1999]. It is also important to realise that the reduction of emissions from housing can potentially lead to an increase in NH<sub>3</sub>-emissions from manure storage and application.

Note that not all submitted data are measured data. Some have been calculated or derived from available information, in which case this has been indicated. For instance, in the case of the Italian data, calculated values use a constant ratio of 1.23:1 between ammonia emission from the housing of sows kept in collective pens and the emission from the housing of fatteners. This is because data for individually housed sows were not always available.

Cost calculations depend on the factors included. For example, cost data from Italy show negative costs, which actually expresses a net benefit of applying the housing system. In this case, the application of the reference system would be more costly than the application of the alternative housing system. With the exception of Italy, cost data do not include cost benefits.

Potential reduction techniques are described and compared in this section. Chapter 5 presents the result of the assessment of the technical and economic merits of their application. In some countries, the application of certain types of housing is limited or will not be allowed, because of health regulations or market requirements.

All integrated measures to reduce emissions of NH<sub>3</sub> from pig housing will lead to a higher amount of nitrogen in the slurry to be applied and in the amount that may potentially be emitted during landspreading.

### 4.6.1 System-integrated housing techniques for mating and gestating sows

**Description:** The performances of the housing techniques for mating and gestating sows are summarised in Table 4.21. Many of the housing techniques are also applied for growers/finishers (see Section 4.6.4) and for these the performance levels are summarised in Table 4.24.

Currently, mating and gestating sows can be housed either individually or in a group. However, EU legislation on pig welfare (91/630/EEC) provides minimum standards for the protection of pigs and will require sows and gilts to be kept in groups, from 4 weeks after service to 1 week before the expected time of farrowing, for new or rebuilt houses from 1 January 2003, and from 1 January 2013 for existing housing.

It is clear that some techniques have more reducing potential than others, but even with the same technique different levels have been achieved in different MSs. Factors such as group or individual housing, use of straw, and climatic conditions during measurement all affect the emission levels.

In the same EU legislation on pig welfare as mentioned above (91/630/EEC amended by Council Directive 2001/88/EC), requirements for flooring surfaces are included. For gilts and pregnant sows, a specified part of the floor area must be continuous solid floor of which a maximum of 15 % is reserved for drainage openings. These new provisions apply to all newly built or rebuilt holdings from 1 January 2003, and to all holdings from 1 January 2013. The effect of these new flooring arrangements on emissions compared to a typical existing fully slatted floor (which is the reference system) has not been investigated. The maximum 15 % void for drainage in the continuous solid floor area is less than the 20 % void for the concrete slatted floor area in the new provisions (a maximum 20 mm gap and a minimum slat width of 80 mm for sows and gilts). Therefore the overall effect is to reduce the void area.

**The reference technique:** For sows, this is a deep pit under a fully-slatted floor with concrete slats. The slurry manure is removed either in frequent intervals, only after every fattening period, or even less frequently. Artificial ventilation removes gaseous components emitted by the stored slurry manure.

**Achieved environmental benefits:** The associated emission level varies with the housing conditions. Group (loose) housed sows are reported to have emissions between 3.12 (DK) and 3.70 (I) kg NH<sub>3</sub> per sow place per year, whereas individual housing is associated with higher levels at 4.2 (NL) kg NH<sub>3</sub> per sow place per year.

**Cross-media effects:** The energy required for artificial ventilation is variable, but on average in Italy this has been estimated at 42.2 kWh per sow per year [185, Italy, 2001].

**Operational data:** The circumstances under which the emission data have been obtained were standardised. This means that no particular techniques were applied that could have affected the emissions or that are largely different from the general farmers' practice (such as feeding, watering, control of housing climate).

**Applicability:** This system has been commonly applied throughout Europe.

**Costs:** The costs for a new installation are estimated to be more than EUR 600 per sow place per year, including both investment costs (interests, allowances, etc) and running costs (energy, maintenance, etc.) [185, Italy, 2001].

**Reference farms:** An estimated 2381000 mating sows (74 % of the EU total) and 4251000 gestating sows (70 % of the EU total) are kept individually. It is assumed that a large number is housed on fully-slatted floors.

Section number	Housing system	NH <sub>3</sub> -reduction (%)	Energy input (kWh/place/yr)
4.6.1	Group or individually housed sows on fully-slatted floor, artificial ventilation and underlying deep collection pit (reference)	3.12 (DK) to 3.7 (I) and 4.2 (NL) kg NH <sub>3</sub> /sow place/yr	42.2
<i>Fully-slatted floors (FSF)</i>			
4.6.1.1	FSF with vacuum system	25	same as reference
4.6.1.2	FSF with flush canals	no aeration	22.8 <sup>1)</sup>
		aeration	40.3 <sup>1)</sup>
4.6.1.3	FSF with flush gutters/tubes	no aeration	18.5 <sup>1)</sup>
		aeration	32.4 <sup>1)</sup>
<i>Partially slatted floors (PSF)</i>			
4.6.1.4	PSF with reduced manure pit	20 – 40	same as reference
4.6.1.5	PSF with manure surface cooling fins	52	more than reference
4.6.1.6	PSF with vacuum system	concrete slats	25
		metal slats	35
4.6.1.7	PSF with flush canals	no aeration	21.7 <sup>1)</sup>
		aeration	38.5 <sup>1)</sup>
4.6.1.8	PSF with flush gutters/tubes	no aeration	14.4 <sup>1)</sup>
		aeration	30 <sup>1)</sup>
4.6.1.9	PSF with scraper (gestating sows)	concrete slats	15 – 40
		metal slats	50
<i>Solid concrete floor (SCF)</i>			
4.6.1.10	SCF full litter	0 to - 67 <sup>2)</sup>	less than reference
4.6.1.11	SCF with straw and electronic feeders	38	less than reference
1) relates to energy required for flushing, not for ventilation			
2) a negative reduction indicates an increase in emissions			

**Table 4.21: Performance levels of system-integrated housing techniques for new installations for mating and gestating sows**

#### 4.6.1.1 Fully-slatted floor with vacuum system (FSF vacuum)

**Description:** On the bottom of the pit under a fully-slatted floor, outlets are placed every 10 m<sup>2</sup> and that are connected to a sewerage system. Slurry is discharged by opening a valve in the main slurry pipe. A slight vacuum develops and allows the slurry removal. The pit can be emptied once or twice a week, depending on the capacity of the pit itself.

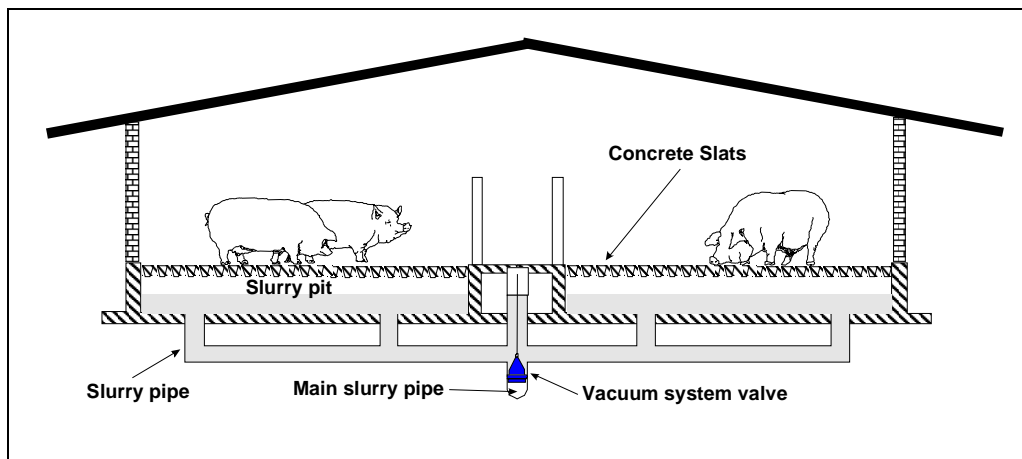

**Figure 4.17: Fully-slatted floor with vacuum system**  
[185, Italy, 2001]

**Achieved environmental benefits:** Reduction of  $\text{NH}_3$ -emission by about 25 % due to frequent removal of slurry. Italian data reported about 2.77 kg  $\text{NH}_3$  per sow place per year.

**Cross-media effects:** As the system is manually operated, no additional energy is required. Less water is needed to clean the floor compared to with partly-slatted or solid concrete floors. It is suggested that any aerosols which develop during the discharge of the slurry are removed by the vacuum created when opening the valves.

**Operational data:** This technique is easy to operate compared to the reference technique [184, TWG ILF, 2002].

**Applicability:** In existing houses, this technique may be applicable with:

- solid concrete floors and with sufficient height to build on top of the existing floor
- renovation of a FSF with a storage pit underneath.

**Costs:** Italy reported a negative extra cost (i.e. a benefit) of EUR 8.60 per sow place per year, when applied in new housing, compared to the costs of the reference system.

**Reference farms:** An increasing number of farms in Italy are adopting this technique in new housing for gestating sows, e.g. Sartori farm, Parma.

**Reference literature:** [185, Italy, 2001]

#### 4.6.1.2 Fully-slatted floor with flushing of a permanent slurry layer in channels underneath (FSF Flush channels)

**Description:** A fully-slatted floor with canals underneath filled with a 10 cm layer of slurry manure. The canals are flushed with the fresh or aerated liquid fraction of slurry at least once a day. The aerated liquid contains 5 % dm. The canals have a slight inclination to enhance removal of the slurry and the flushing liquid is pumped from one side of the unit or house to the other side, where it is collected in a channel to be removed to an external slurry store.



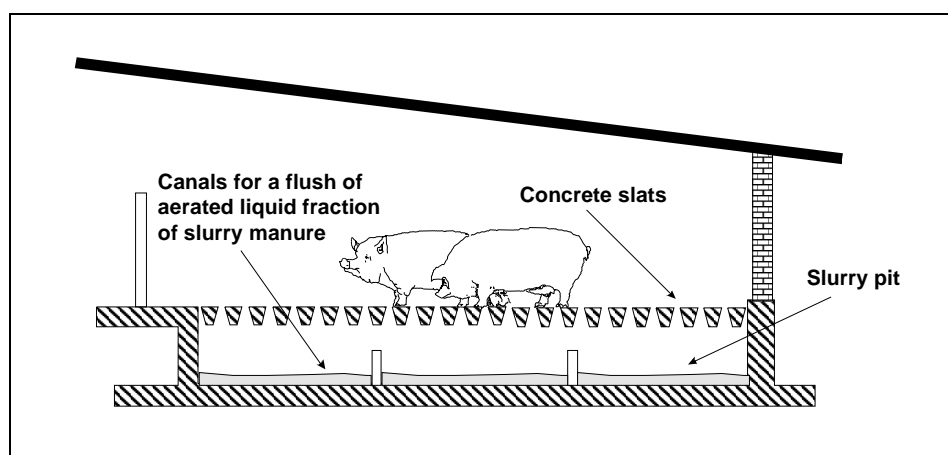

**Figure 4.18: Fully-slatted floor with flushing of a permanent slurry layer in canals underneath [185, Italy, 2001]**

**Achieved environmental benefits:** The combined effect of the reduced manure surface and of the slurry removal by flushing reduces  $\text{NH}_3$ -emissions by 30 % when flushing with fresh liquid, and 55 % when flushing with aerated liquid.

**Cross-media effects:** The energy required for operating this system depends on the distance from the pit to the treated slurry store. Flushing needs extra energy, which is estimated to be:

- 8.2 kWh per sow per year for flushing
- 14.6 kWh per sow per year for liquid separation
- 17.5 kWh per sow per year for aeration.

The total energy consumption is less than or equal to the reference system because artificial ventilation is not required.

Aerosols may also be reduced by the frequent flushing.

Odour peaks due to flushing may cause a nuisance when receptors are living near the farm. The peaks are higher if flushing is done without aeration rather than if it is done with aeration. On a case by case basis it has to be decided whether an overall load (thus applying a no-flushing system) or peak values are more important. [184, TWG ILF, 2002]

**Operational data:** No artificial ventilation is applied in these houses, on the assumption that sufficient ventilation is achieved from natural ventilation and from the frequent flushing of the slurry.

Application of this system needs an installation to separate the liquid fraction from the slurry before, in the case of aeration, it can be treated and pumped back for flushing.

**Applicability:** The design (e.g. depth) of the existing manure pit may allow application in existing houses. Examples exist of applications on existing solid concrete floors, where gutters can be placed on the existing floor, but sufficient height must be available.

**Costs:** Its application in new housing has a negative extra cost (i.e. a benefit) of EUR 4.82 per sow place per year. In flushing without aeration, the negative extra costs (i.e. benefits) are EUR 12.16 per sow place per year. In existing houses, costs are variable and depend on the design of the existing building, see the introduction to Section 4.6.1.

**Reference farms:** This system is increasingly applied in housing for gestating sows (and finishers), e.g. Borgo del Sole farm, Parma.

**Reference literature:** [185, Italy, 2001]

#### 4.6.1.3 Fully-slatted floor with flush gutters or flush tubes (FSF flush gutters)

**Description:** Small plastic or metal gutters are placed under a fully-slatted floor. Urine continuously drains due to a slight fall (decline slope) in these gutters. Slurry is removed once or twice a day by flushing with the liquid fraction of slurry manure, see Figure 4.19. Urine drains continuously into a drain towards the slurry store.

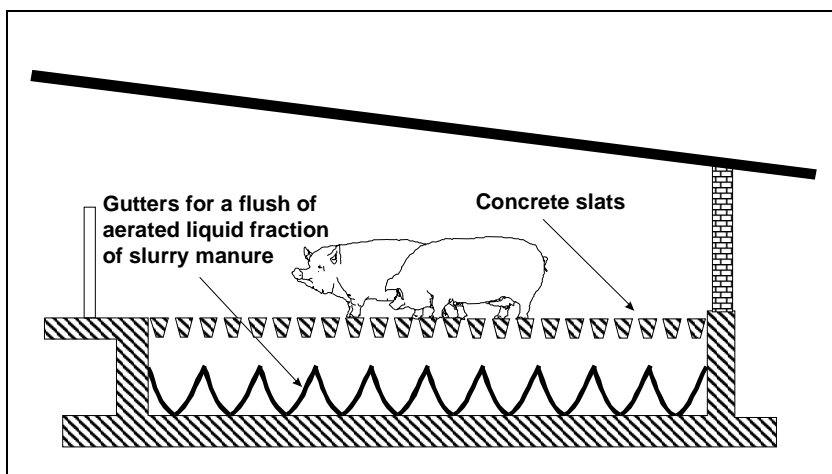

**Figure 4.19: Fully-slatted floor with flushing gutters**  
[185, Italy, 2001]

An alternative system consists of pens with fully-slatted floors with PVC tubes incorporated in the concrete under each slat, see Figure 4.20. A slope allows the urine to drain continuously. Once a day or even more frequently a recirculation of separated and aerated slurry is made in order to remove the manure and clean the tubes.

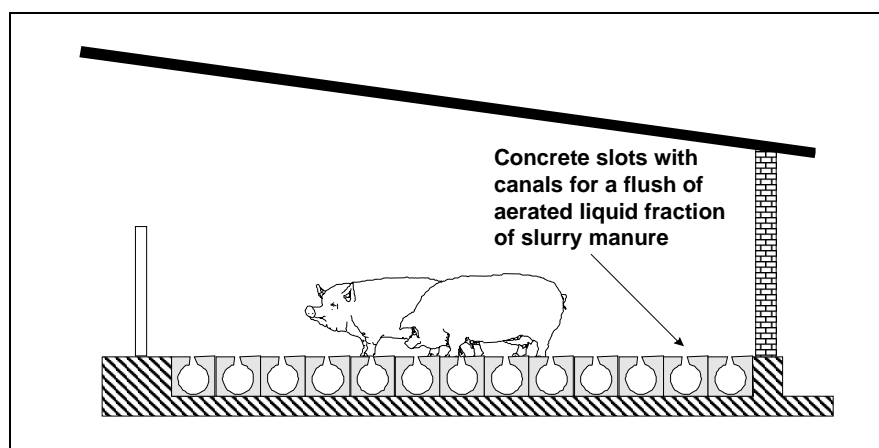

**Figure 4.20: Fully-slatted floor with flushing tubes**  
[59, Italy, 1999]

**Achieved environmental benefits:** Reduction of the slurry surface, frequent removal of the slurry and continuous draining of the urine all help to reduce  $\text{NH}_3$  emissions by 40 % when flushing with fresh slurry, and 55 % when flushing with aerated slurry. No difference is reported between using tubes and gutters.

**Cross-media effects:** Flushing needs energy, which is estimated to be:

- 3.9 kWh per sow per year for flushing
- 14.6 kWh per sow per year for liquid separation
- 13.9 kWh per sow per year for aeration.

Where artificial ventilation is not applied in this system, e.g. in Italy, the total energy used is less than with the fully-slatted floor with artificial ventilation.

Aerosols may also be reduced by the frequent flushing.

Odour peaks due to flushing may cause a nuisance when receptors are living near the farm. The peaks are higher if flushing is done without aeration rather than if it is done with aeration. On a case by case basis it has to be decided whether an overall load (thus applying a no-flushing system) or peak values are more important. [184, TWG ILF, 2002]

**Operational data:** See Section 4.6.1.2.

**Applicability:** See Section 4.6.1.2. In Italy, gutters and tubes are applied for gestating sows and an increasing number of farms are adopting the tube system for finishers.

**Costs:** Application in new housing ranges from an extra cost of EUR 0.56 per sow place per year (gutters) to a negative extra cost of (i.e. a benefit) EUR 5.54 per sow place per year (tubes). In flushing without aeration, the negative extra costs (i.e. benefits) are EUR 2.44 – 8.54 per sow place per year. The annual extra operational costs show a benefit of EUR 1.22 – 4.27 per sow place without aeration, and with aeration this ranges from an extra cost of EUR 0.28 to a benefit of EUR 2.77 [184, TWG ILF, 2002]. Costs are slightly higher than for the flush canal system, given the lower benefit data. Gutters with aeration have a net cost compared with the canal system.

In existing houses, costs are variable and depend on the design of the existing building, see the introduction to Section 4.6.1.

**Reference farms:** In Italy, about 5000 sows (Bertacchini farm) are kept on FSF with gutters and 7000 sows on FSF with tubes.

**Reference literature:** [185, Italy, 2001]

#### 4.6.1.4 Partly-slatted floor with a reduced manure pit (SMP)

**Description:** Ammonia emissions can be reduced by applying the principle of reducing the manure surface area, in particular by applying a small manure pit with a maximum width of 0.60 m. The manure pit is equipped with triangular iron slats or concrete slats. The sows are individually housed.

In Italy a loose-housing design is applied with a fully-slatted external alley with the slurry pit underneath; the slurry not being removed very frequently. Indoors, the animals are kept on a solid concrete floor, a hatched opening giving access to the external alley (see Figure 4.22). This design can not be compared with the systems for loose-housed sows with the partly-slatted floors inside the housing. The applied reduction techniques show similar environmental performances and operating conditions, but may differ slightly in costs.

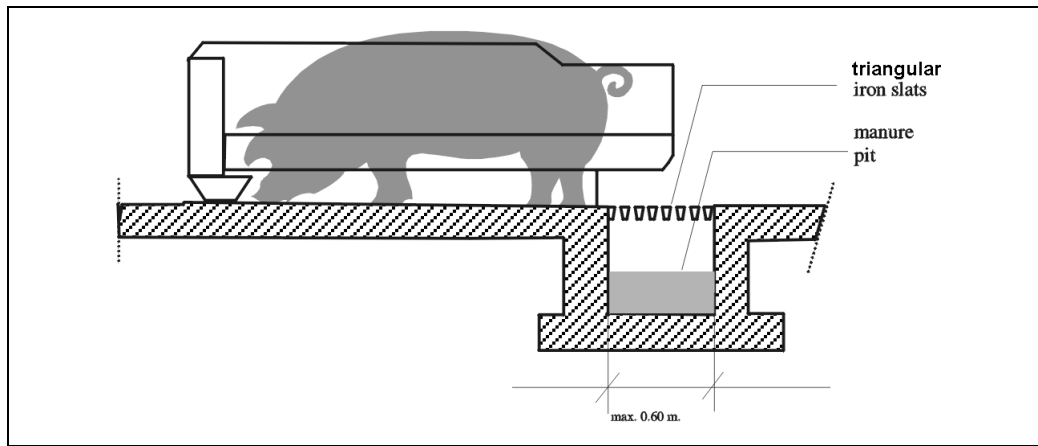

**Figure 4.21: Individual housing with a small manure pit**  
[10, Netherlands, 1999]

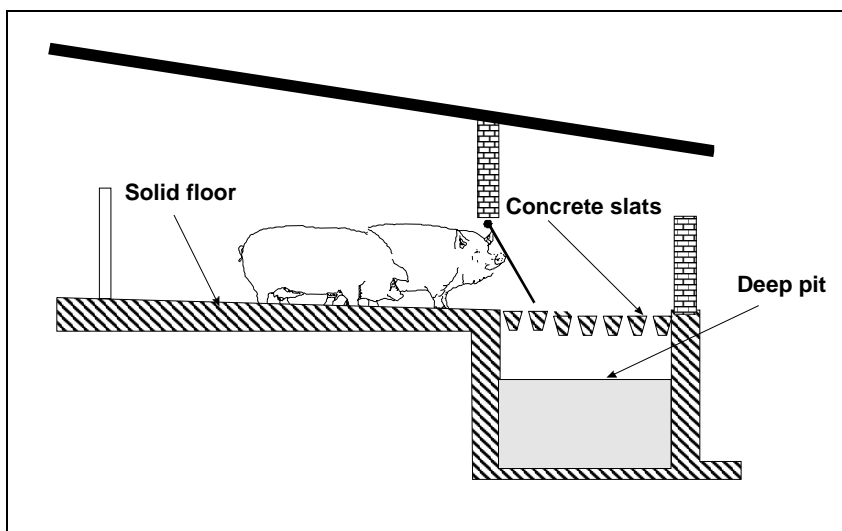

**Figure 4.22: Solid concrete floor and fully-slatted external alley with storage pit underneath**  
[185, Italy, 2001]

**Achieved environmental benefits:** The combination of the reduction of the manure pit and slurry surface and the fast discharge of manure by using triangular slats reduce  $\text{NH}_3$ -emissions by 20 to 40 %.

In a system, individual housing and group housing show different emissions due to the differences in manure emitting surface per sow. With loose housing of sows, levels are reported to be 2.96 kg  $\text{NH}_3$  per sow place per year (Italy). For the individual housing of sows levels of 1.23 (Denmark) and 2.40 (Netherlands)  $\text{NH}_3$  per sow place per year respectively have been reported.

**Cross-media effects:** These houses can be naturally or mechanically ventilated. In Denmark mechanical ventilation is applied and dimensioned for an output of a maximum of 100  $\text{m}^3$  per hour per sow place. In areas with low outdoor temperatures these units can also be equipped with auxiliary heating. Energy input is unchanged.

In the case of the external slurry pit, a reduced emission will not benefit the internal environment, which can be considered as one of the advantages of the reduced pit inside.

In Italy energy savings are possible because artificial ventilation is not required [185, Italy, 2001].

**Operational data:** The slurry is usually removed via a central sewer system by opening a valve and using inclination of the manure pipe. Some systems are equipped with scrapers (see Section 4.6.1.9).

**Applicability:** In existing houses, the applicability depends on the design of the existing manure pit, but it is mostly difficult, if not impossible, to apply. For existing housings with an internal concrete solid floor an extension with an external alley with a storage pit might be possible [185, Italy, 2001].

The application of a maximum width of 0.60 m may require more pit depth or more frequent removal and then outside manure storage. If a minimum pit size is imposed then by relation, a reduction will not be applicable, (e.g. Ireland: > 0.90 m).

In some European countries (e.g. DK) the individual housing of sows will decline because of changing legislation stipulating loose-housing systems.

**Costs:** The remaining ammonia emission compared with a fully-slatted floor depends on the reference. With a 40 % reduction (4.2 to 2.4 kg NH<sub>3</sub>), the additional investment is about EUR 17.75 per sow place or EUR 9.85 per kg NH<sub>3</sub> abated. Additional annual operating costs are EUR 5.80 per sow place or EUR 3.25 per kg NH<sub>3</sub>. With a 20 % reduction, an additional investment of EUR 1.76 per sow place was reported. The system with the external manure pit and slatted floor reportedly had an additional investment of EUR 8.92 per sow place per year [185, Italy, 2001].

**Reference farms:** This is a very common housing system for mating and gestating sows in many European Member States. In Italy 40 % of the growers/finishers are kept in these kind of installations [185, Italy, 2001].

**Reference literature:** Rosmalen, Research Institute for Pig Husbandry, rapport PV P1.158 [10, Netherlands, 1999] [59, Italy, 1999] and [185, Italy, 2001].

#### 4.6.1.5 Partly-slatted floor with manure surface cooling fins

**Description:** Floating fins on the manure will cool the surface of the manure, see Figure 4.23. Groundwater is used as a coolant. A number of fins are installed in the manure pit. These fins are filled with water and float on the manure. The total surface of the fins has to be at least 200 % of and compared to the manure surface. A heat exchanger is used as a coolant. The heat obtained can be used for a floor heating system. The temperature of the top layer of the manure should be no higher than 15 °C. Application is also possible in pens with a convex floor. The convex floor separates both channels. Slats are made of concrete. [186, DK/NL, 2002]

**Achieved environmental benefits:** The achieved ammonia emission is 2.2 kg NH<sub>3</sub> per sow place per year. Compared to a fully-slatted floor the ammonia emission is reduced by about 50 % (individually housed sows).

**Cross-media effects:** Although there is an energy reduction due to the heat exchanger, the overall energy requirement is thought to be higher than the reference [184, TWG ILF, 2002].

**Applicability:** The experience in the Netherlands is that this system is very easy to implement in both new buildings and with the reconstruction of existing buildings. The design and the size of the pen are not critical for the applicability of the system. However, other MSs do not share this experience and consider that this technique is not so easy to operate or to apply [184, TWG ILF, 2002].

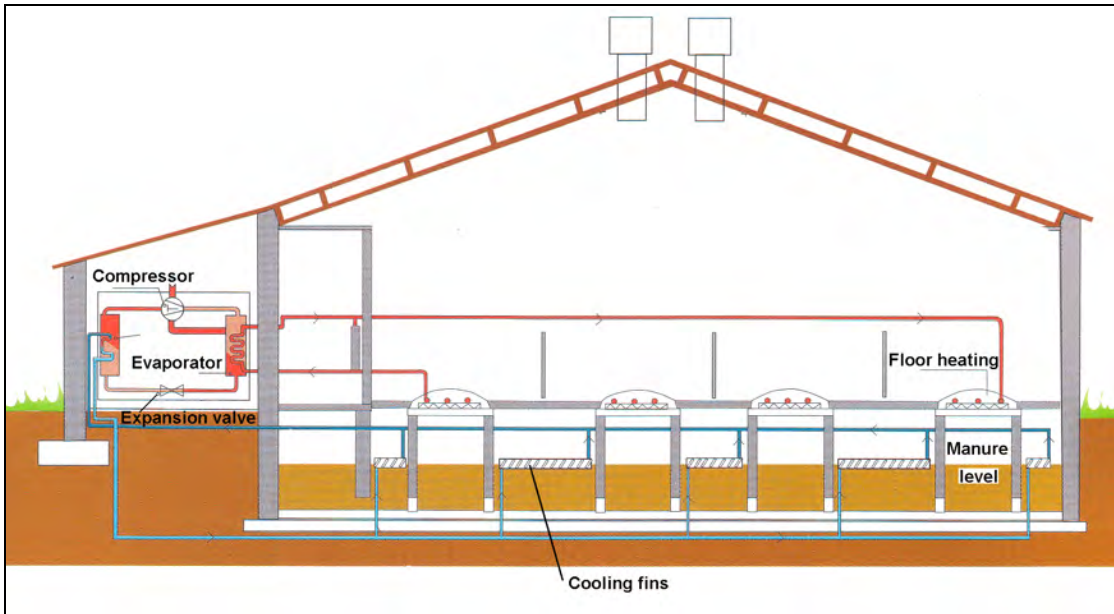

**Figure 4.23: Manure surface cooling fins**  
 [186, DK/NL, 2002] with reference to Wageningen, IMAG-DLO, rapport 96-1003

**Costs:** The extra investment costs are EUR 112.75 per sow place. This means with a 50 % reduction, i.e. 4.2 to 2.2 kg NH<sub>3</sub>, costs are EUR 56.35 per kg NH<sub>3</sub> abated. The extra costs per year are EUR 20.35 per sow place. This means EUR 9.25 per kg NH<sub>3</sub> abated.

**Reference farms:** In the Netherlands, about 3000 mating and gestating sow places are equipped with this system. Currently, this system is being implemented in many rebuild situations and in some new buildings.

**Reference literature:** [186, DK/NL, 2002] with reference to Wageningen, IMAG-DLO, rapport 97-1002.

#### 4.6.1.6 Partly-slatted floor with vacuum system (PSF Vacuum System)

**Description; cross-media effects:** See Section 4.6.1.1.

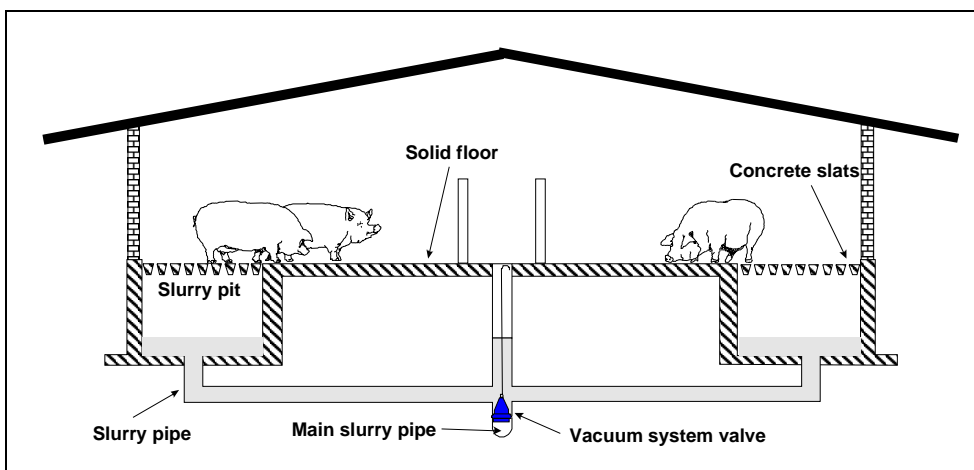

**Figure 4.24: Partly-slatted floor with vacuum system**  
 [185, Italy, 2001]

**Achieved environmental benefits:** With a partially slatted floor and a vacuum system the  $\text{NH}_3$ -emission is reduced to 2.77 kg  $\text{NH}_3$  per sow place per year on concrete slats, and to 2.40 kg  $\text{NH}_3$  per sow place per year on metal slats for loose housed sows. This compares with the reference as relative reductions of 25 % and 35 % respectively.

**Operational data:** This technique is easy to operate compared to the reference technique [184, TWG ILF, 2002].

**Applicability:** In existing housing application, its applicability is limited to housing with partially slatted floors and a storage pit with sufficient depth.

**Costs:** There are no data available on capital costs, but the annual operational costs are thought to be the same as for growers/finishers and this is an estimated negative extra cost (i.e. a benefit) of EUR 4 when concrete slats are applied and EUR 1.50 (also a benefit) when metal slats are applied in a new housing [184, TWG ILF, 2002].

**Reference literature:** [185, Italy, 2001]

#### 4.6.1.7 Partly-slatted floor with flushing of a permanent slurry layer in channels underneath (PSF Flush channels)

**Description and operational data:** See Section 4.6.1.2 and the remark on external alley designs in Section 4.6.1.4. Figure 4.25 shows the design with an external alley, but the same design is also applied with the slatted floor and the canal inside the building.

**Achieved environmental benefits:** Flushing with aerated slurry reduced emissions to 1.48 kg  $\text{NH}_3$  per sow place per year (60 %), and with fresh slurry to 1.85 kg  $\text{NH}_3$  per sow place per year (50 %). The effect on  $\text{NH}_3$ -emission of different slat materials has not been reported.

**Applicability:** This system can be applied in existing housing with a partly-slatted floor with a storage pit underneath.

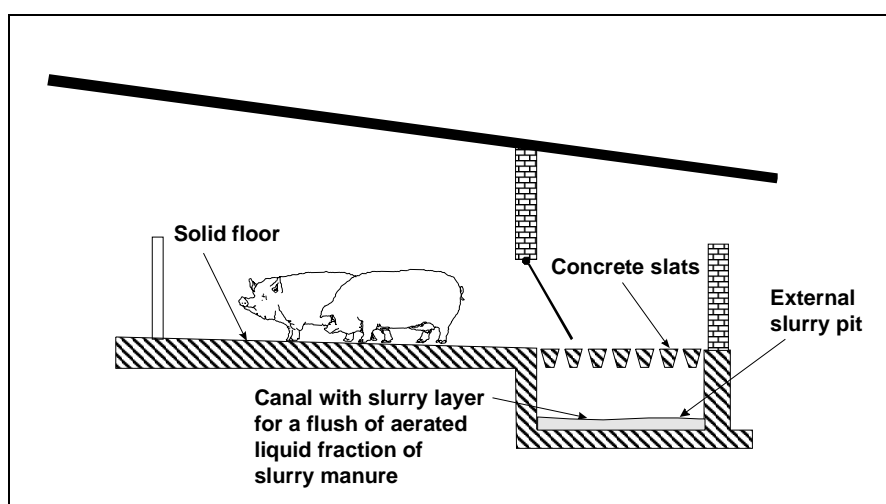

**Figure 4.25:** Partly-slatted floor and external alley with flushing of a permanent slurry layer in canals underneath

**Cross-media effects:** The energy required for operating this system depends on the distance from the pit to the treated slurry store. Indications for required energy are:

- 3.4 kWh per sow per year for flushing
- 18.3 kWh per sow per year for liquid separation
- 16.8 kWh per sow per year for aeration.

The total energy consumption is less or equal to the reference system because the artificial ventilation is not required.

It is considered that aerosols are reduced by the frequent flushing.

Odour peaks due to flushing may cause a nuisance when receptors are living near the farm. The peaks are higher if flushing is done without aeration rather than if it is done with aeration. On a case by case basis it has to be decided whether an overall load (thus applying a no-flushing system) or peak values are more important. [184, TWG ILF, 2002]

**Costs:** There are no data on capital costs, but operational costs are estimated as a negative extra cost (i.e. a benefit) of EUR 6.07 when no aeration is applied, or EUR 2.89 (also a benefit) when aeration is applied and when applied to new housing. [184, TWG ILF, 2002]

**Reference farms:** An increasing number of farmers are adopting this technique in new buildings for gestating sows in individual stalls (and for growers/finishers).

**Reference literature:** [185, Italy, 2001]

### 4.6.1.8 Partly-slatted floor with flushing gutters or flush tubes (PSF flush gutter)

**Description:** Application is possible in individual stalls and in group-housing systems. The manure surface should not be larger than 1.10 m<sup>2</sup> per sow. The manure will be removed frequently by a flushing system. The slats are made of concrete. The gutter sides should have a slope of 60 degrees. The gutters should be flushed twice a day. The flushing will be done by the fresh or aerated liquid fraction of the manure (after separation) and the dry matter content should not be higher than 5 % (see also Section 4.6.1.3).

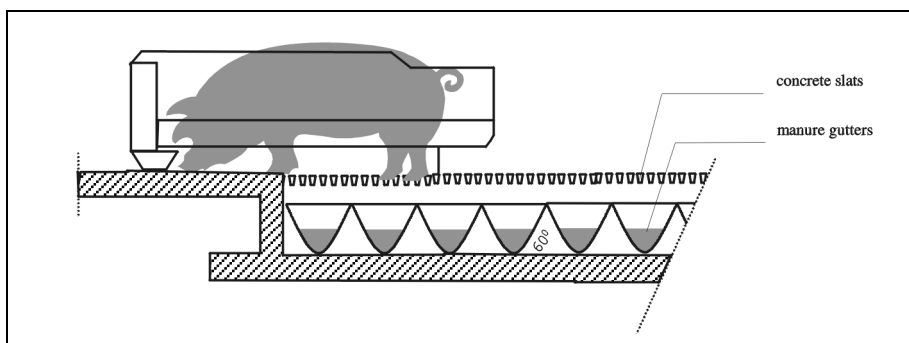

**Figure 4.26: Partly-slatted floor with flushing gutter in individual housing situation [10, Netherlands, 1999]**

For group housing the same description applies as that given in Section 4.6.1.3. The pictures are only different in the sense that the concrete floor surface is larger and the slatted part with the slurry gutters/tubes underneath is smaller.

**Achieved environmental benefits:** The emission from a reduced manure surface and from flushing in gutters or tubes is reduced in individual housing on concrete slats to 2.50 kg NH<sub>3</sub> per sow place per year (NL, B). In the case of loose housed sows, emission levels are reported to be 1.48 kg NH<sub>3</sub> per sow place per year (I) without aeration and 1.11 kg NH<sub>3</sub> per sow place per year (I) with aeration. In the Italian situation concrete slats were also used. These three figures represent reduction percentages of respectively 40 %, 60 %, and 70 % compared to the reference.



**Cross-media effects:** The energy requirements for these systems show large variations, which could not be explained by the available information. Energy consumption levels are reported to be:

- 2.4 kWh per sow per year for flushing
- 12.0 kWh per sow per year for liquid separation
- 15.6 kWh per sow per year for aeration.

These levels vary slightly from those reported in Section 4.6.1.3. The pumping energy varies with the distance to the flushing liquid store. An extra energy consumption of 0.5 kWh per sow place is required for extra pumping when flushing twice a day. Also, in the case of sow manure, it was commented that the flushing fluid could be run back to a receiving tank by gravity. Settling of the low dry matter in the sow manure (5 %) would allow pumping of the clean fluid from the top of the tank and would therefore not require mechanical separation. After some time, a layer will have settled on the bottom of the tank and this may have to be pumped out for further handling.

Where artificial ventilation is not applied in this system, e.g. in Italy, the total energy used is less than with the fully-slatted floor with artificial ventilation.

Odour peaks due to flushing may cause a nuisance when receptors are living near the farm. The peaks are higher if flushing is done without aeration rather than if it is done with aeration. On a case by case basis it has to be decided whether an overall load (thus applying a no-flushing system) or peak values are more important. [184, TWG ILF, 2002]

**Operational data:** Application of this system needs an installation (tank) to separate the liquid fraction from the slurry before it can be used or further treated, in the case of aeration, and then pumped back for flushing.

**Applicability:** In existing houses the applicability depends on the design of the existing manure pit. Only a few alterations are needed to implement this system in a manure pit with a sufficient depth.

**Costs:** The implementation costs of the system for individual housing, as reported by the Netherlands, are significant. With a remaining ammonia emission of 2.5 kg NH<sub>3</sub> per sow place per year the extra investment costs (for the system with aeration) are EUR 161.80 per sow place. This is equal to EUR 95.20 per kg NH<sub>3</sub> abated. The extra costs per year are EUR 57.40 per pig place. This means EUR 34.05 per kg NH<sub>3</sub>. For the system without aeration the extra investment costs are EUR 59 per sow place, and extra annual costs of EUR 9.45 per sow place.

Italy reported much lower cost figures, although these were related to growers and finishers, for the group housing system which is of course cheaper per pig place. These cost figures are in the same range as reported in Section 4.6.1.3 for the fully-slatted floor system. [185, Italy, 2001]

**Reference farm:** Examples are found in Italy, e.g. Bertacchini farm. In the Netherlands 2000 pig places are equipped with this system.

**Reference literature:** [10, Netherlands, 1999], [59, Italy, 1999] [127, Italy, 2001].

#### 4.6.1.9 Partly-slatted floor with scraper (PSF scraper)

**Description:** The pen is divided into a slatted concrete part (dunging area) and a solid concrete part (laying area) with a slope towards the slats. Slurry manure is collected in a pit underneath the slats, from which the solid manure is removed very frequently by a scraper to the manure pit outside. Urine can drain directly to a collection pit through a drain in the bottom of the manure channel. See also the remark on external alley designs in Section 4.6.1.4.

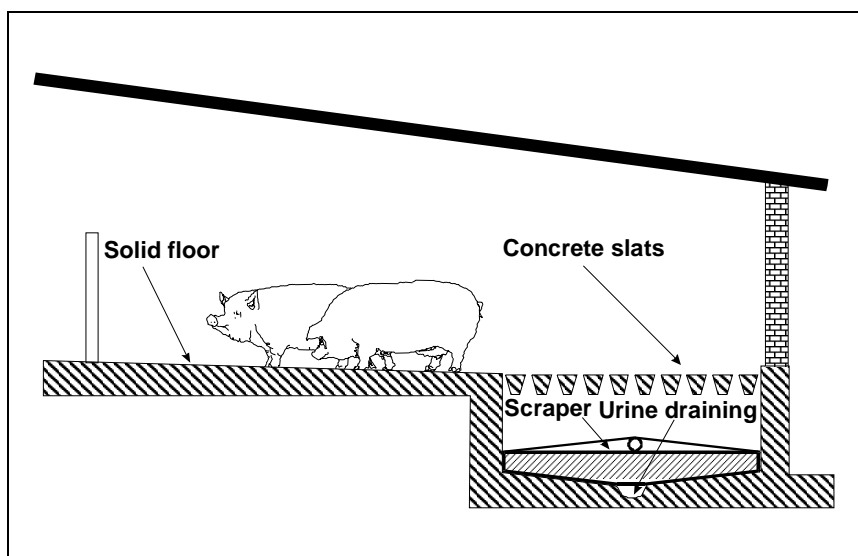

**Figure 4.27: Partly-slatted floor with a scraper (PSF scraper)**  
[185, Italy, 2001]

**Achieved environmental benefits:** A reduced slurry surface and frequent removal of slurry to an external store reduces  $\text{NH}_3$  emissions to levels reported by Italy of 1.85 (on metal slats) and 2.22 (on concrete slats) to 3.12 (DK, concrete slats)  $\text{kg NH}_3$  per sow place per year. These levels represent a reduction of 50 % for metal slats and 15 to 40 % for concrete slats compared to the reference. Clearly, the frequency of scraping and the smoothness of the pit floor surface are factors which help determine what reduction can be achieved.

Interestingly, data reported by Denmark show no effect from scraping a reduced manure pit compared with a fully-slatted floor, each having similar associated emissions levels of 3.12  $\text{kg NH}_3$  per sow place per year.

**Cross-media effects:** Operating the scraper requires energy.

**Operational data:** Emissions have been obtained under average conditions. The frequency of scraping was once a day. In general this system works well, but operability is difficult because crystals can be formed on the pit floor which hinder the scraper [184, TWG ILF, 2002]. More research is required to optimise the operability of this system.

Application of metal slats gives lower emissions as slurry is removed faster into the pit.

**Applicability:** This technique is considered to be difficult to apply and is highly dependent on the design of the slurry pit.

**Costs:** Data on capital costs are not available, but the operational costs per pig per year are considered to be high [184, TWG ILF, 2002].

**Reference farm:** There are very few applications with the external alley design in Italy. This system is also applied in Denmark and in the Netherlands.

**Reference literature:** [59, Italy, 1999] [127, Italy, 2001].

#### 4.6.1.10 Solid concrete floor and full litter (SCF full litter)

**Description:** Sows are kept on a fully concrete floor almost completely covered with a layer of straw or other ligno-cellulosic materials to absorb urine and incorporate faeces (see Figure 2.15). Solid manure is obtained, which has to be removed frequently in order to avoid the litter becoming too moist.

**Achieved environmental benefits:** Reported levels vary and either show no difference compared with the applied reference (fully-slatted floor) 3.7 kg NH<sub>3</sub> per sow place per year (Italy) or report a considerable increase of 67 % (5.20 kg NH<sub>3</sub> per sow place per year (Denmark)).

**Cross-media effects:** The production of solid manure instead of slurry manure is considered an advantage from the agronomic point of view. Organic matter incorporated in the fields improves the physical characteristics of the soil; reducing run-off and the leaching of nutrients to water bodies.

Raised dust levels can be expected. High NO and N<sub>2</sub>O emissions are reported for fattening the pigs and in pig production in the references listed below [188, Finland, 2001].

**Operational data:** In Denmark, this housing type can have either natural or mechanical ventilation. Naturally ventilated houses have air inlets in the front and with an air outlet through an open ridge in the roof. In insulated houses the air inlets and outlets are often adjustable. Mechanically ventilated buildings often have either negative-pressure or balanced-pressure systems.

Ventilation is dimensioned for a maximum output of 100 m<sup>3</sup> per hour per sow place. Although the sows are capable of compensating for low temperatures by hiding in the deep litter mat, auxiliary heating is applied in colder parts of Europe to reduce humidity during reduced ventilation.

**Applicability:** As regards the existing housing of sows, application depends on the existing situation and design. This system may receive more attention in future in view of developments in European legislation on animal welfare.

**Reference farms:** This system can be found in several Member States.

**Reference literature:** [87, Denmark, 2000], [127, Italy, 2001]. On high NO and N<sub>2</sub>O levels:

- Groenstein, Oosthoek, Faasen; 'Microbial processes in deep-litter systems for fattening pigs and emissions of ammonia, nitrous oxide and nitric oxide', 1993
- Verstegen, Hartog, Kempen, Metz; 'Nitrogen flow in pig production and environmental consequences', EAAP publication number 69, 1993.

#### 4.6.1.11 Solid concrete floor system with straw and electronic sow feeders

**Description:** The units consist of a bedding area, a central manure area and a feeding area with electronic sow feeders. The dunging area consists of a concrete solid floor. A tractor-mounted scraper is used to daily remove the manure from the solid floor area. The litter in the deep straw littered lying area is removed only 1 – 2 times per year.

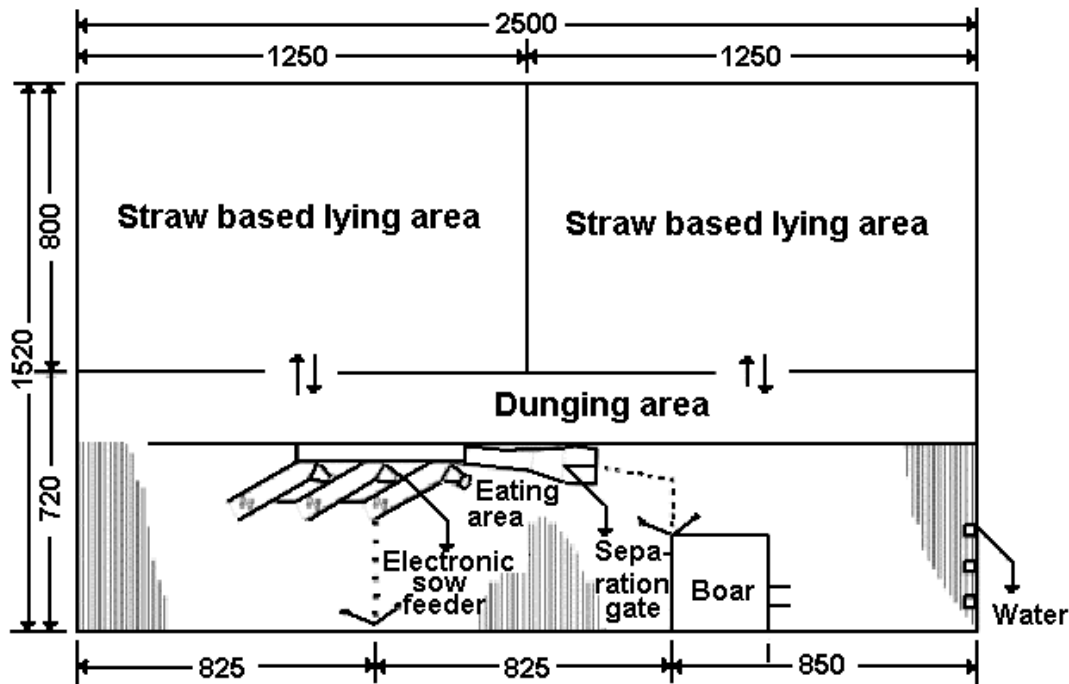

Figure 4.28: Solid concrete floor system with straw and electronic sow feeders [175, IMAG-DLO, 1999]

**Achieved environmental benefits:** The benefit of applying this system depends on the animal behaviour, which is influenced by the pen design. The available lying area per sow is at least 1.3 m<sup>2</sup> per sow and must be easily accessible, especially for young gilts, by making the passages between the lying and dunging areas wide (min. 2 metres, max. 4 metres). The distance from the entrance of the lying area to the farthest (separation) wall should be no longer than 16 metres. The emitting dunging area should be no higher than 1.1 m<sup>2</sup> per sow. The manure pit under the slatted floor is provided with a vacuum system. The ammonia emission reduction is 38 % (2.6 kg NH<sub>3</sub> per sow place per year, NL).

**Cross-media effects:** Energy use is very low, because this system does not need a heating system and is normally equipped with a natural ventilation system. The emission of nitrous oxide is negligible. The emission of methane is 39 grams per day per sow, but further research is needed to establish how this compares to the reference system.

**Applicability:** This system is very good when applied in new houses and in some of the existing houses. In existing houses, the applicability depends on the design of existing manure pits, but it is usually difficult to apply.

**Costs:** The costs for this system are not higher than the reference system. However, there are no costs calculated for extra labour and these costs are therefore unknown.

**Reference farms:** According to EU-legislation, farms are obliged to keep sows in groups. In the Netherlands more than 50 % of new buildings apply this system, this system is also implemented in retrofit situations.

**Reference literature:** [175, IMAG-DLO, 1999]

## 4.6.2 System-integrated housing techniques for farrowing sows

**Description:** For farrowing sows the performance data of the reference and alternative techniques are summarised in Table 4.22. Farrowing sows are also kept in group pens on a solid concrete floor with plenty of litter for the sows to build their nest. In this system manure is hovelled dry.

The **reference system** is described and illustrated in Section 2.3.1.2.1 as the most commonly applied system, including in new housing. Its design can vary in the position of the piglet area and the applied slats, but in principle the designs and emissions are assumed to be in the same range. The housing design for loose housing of sows (as described in Chapter 2) is also considered as an alternative to the reference.

For the reference system, reported emission levels of sows including piglets are between 8 and 9 kg NH<sub>3</sub> per sow place per year. Artificial ventilation is applied.

Costs vary considerably and are independent of the achieved reduction. For example, a 50 % reduction of NH<sub>3</sub> can be achieved at very little extra cost in comparison to the reference system.

Section	Housing system	NH <sub>3</sub> -reduction (%)	Extra investment cost (EUR/place) <sup>1)</sup>	Extra annual operational cost (EUR/place/yr) <sup>1)</sup>	Energy input (kWh/place/yr)
2.3.1.2.1	Crates with fully-slatted floor and underlying deep collection pit ( <b>reference</b> )	8.70 (I) 8.30 (NL, B) kg NH <sub>3</sub> /sow place/yr			
	<i>Crates on fully-slatted floors</i>				
4.6.2.1	FSF and board on a slope	30 to 40	260	29.50	same as reference
4.6.2.2	FSF and combination of a water and manure channel	52	60	1.00	same as reference
4.6.2.3	FSF and flushing system with manure gutters	60	535	86	more than reference
4.6.2.4	FSF and manure pan	65	280	45.85	same as reference
4.6.2.5	FSF and manure surface cooling fins	70	302	54.25	more than reference
	<i>Crates with partly-slatted floor</i>				
4.6.2.6	PSF and crates	34	no data	about 0	same as reference-
4.6.2.7	PSF and manure scraper	35	785	147.20	more than reference
<i>() Member State from which the data originate</i>					
<i>1) sources: [10, Netherlands, 1999] [185, Italy, 2001] [37, Bodemkundige Dienst, 1999] [184, TWG ILF, 2002]</i>					

**Table 4.22: Performance levels of system-integrated housing techniques for new installations for farrowing sows**

#### 4.6.2.1 Crates with fully-slatted floor and a board on a slope

**Description:** A board (concrete or other material) with a very smooth surface is placed under the slatted floor. The size can be adapted to the dimensions of the pen. The board has a slope of at least  $12^\circ$  towards a central slurry pit, which is connected with a sewerage system. The slurry is removed weekly to a store by gravity or by pumping. The slats are made of iron or plastic.

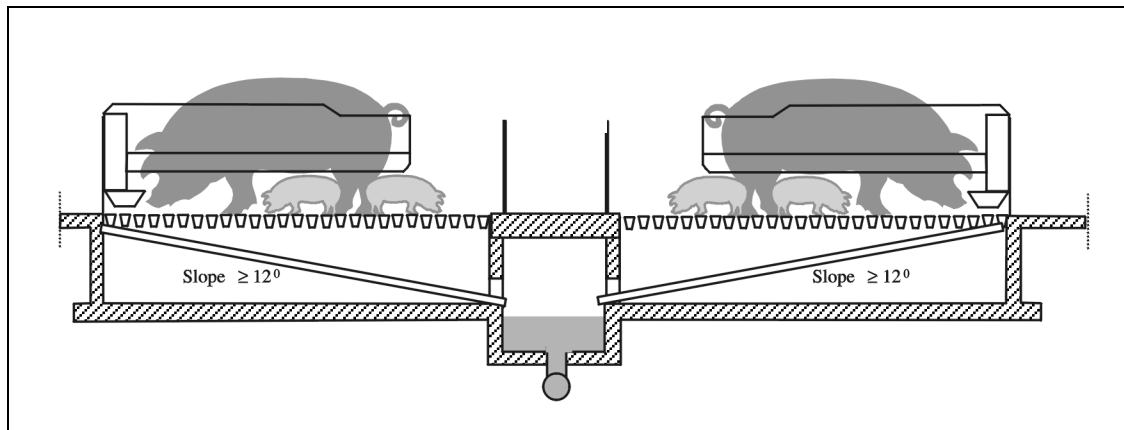

**Figure 4.29: Board on a slope under the slatted floor**  
[10, Netherlands, 1999]

**Achieved environmental benefits:** The benefit of applying this system depends on the smoothness of the board surface to allow the urine to drain continuously and the slurry to move towards the central pit. Also, frequent emptying of the central slurry channel will enhance the reduction. Emissions predominantly come from any slurry remaining on the board. Reductions will vary but reductions of 30 % (6.0 kg  $\text{NH}_3$  per sow place per year (I)) and 40 % (5.0 kg  $\text{NH}_3$  per sow place per year (NI and B)) have been reported.

**Cross-media effects:** There are a lot of problems with flies and therefore this technique is considered as obsolete.

**Applicability:** This system is easy to implement in both new buildings and in the reconstruction of existing buildings. The design of the pen is not critical for the applicability of the system. A new system has also been developed (see Section 4.6.2.2) which is based on the same principles as the described system. The new system, a combination of a water and manure channel, has a higher ammonia reduction and is not more expensive than this system.

**Costs:** The extra investment costs are EUR 260 per pig place. This means that with a 40 % reduction costs are EUR 78.80 per kg  $\text{NH}_3$ . Extra annual operational costs are EUR 29.50 per pig place or EUR 8.95 per kg  $\text{NH}_3$ . Lower investment costs than the reference system are reported from Italy.

**Reference farms:** In the Netherlands and Italy just a few sow places are equipped with this system. This system is being superceded by a new system (see Section 4.6.2.2), which is based on the same principles, but has a different design.

**Reference literature:** [10, Netherlands, 1999] [185, Italy, 2001] [37, Bodemkundige Dienst, 1999]

#### 4.6.2.2 Crates with fully-slatted floor and combination of a water and manure channel

**Description:** The sow has a fixed place and as a result it is clear where the dunging area will be. The manure pit is split up into a wide water channel at the front and a small manure channel at the back. This greatly reduces the manure surface, which in turn reduces the ammonia emission. The front channel is partly filled with water. The slats are made of iron or plastic.

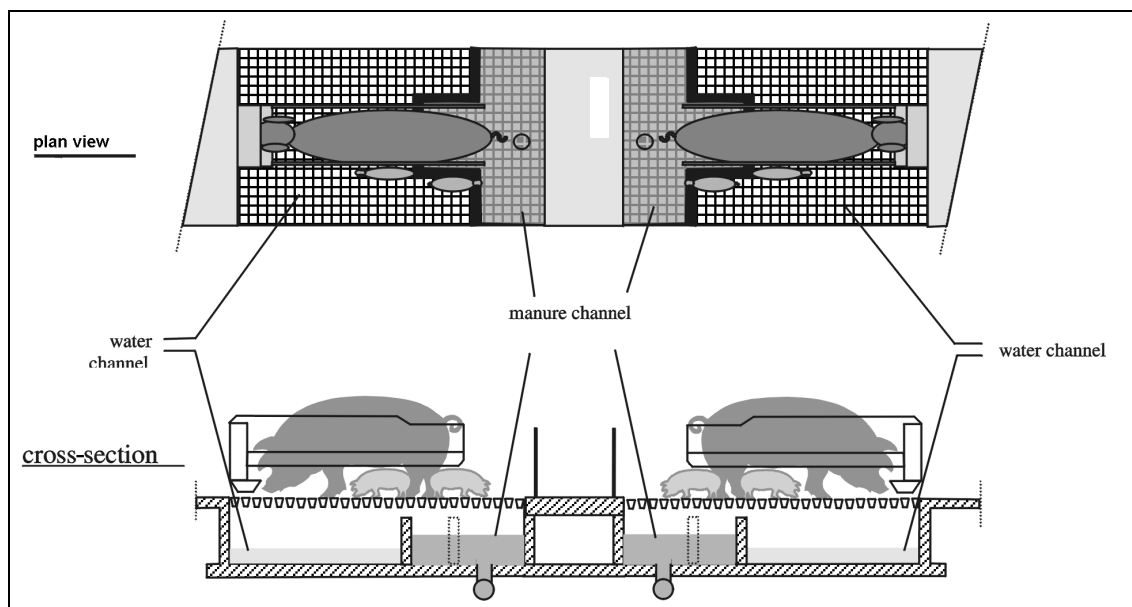

**Figure 4.30: Combination of a water and manure channel**  
[10, Netherlands, 1999]

**Achieved environmental benefits:** It limits the manure surface and has frequent removal of the slurry by a sewerage system. A reduction of 52 % (4.0 kg NH<sub>3</sub> per sow place per year (NL, B)) can be achieved.

**Cross-media effects:** The frequent removal of the slurry may require extra energy. Water is needed to fill the front pit.

**Applicability:** This system is easy to implement in the reconstructions of existing buildings with the reference technique, as the design of the pen is not critical for the applicability of the system. Very simply, all that would be needed would be separation of the two pits.

**Operational data:** Supposedly the two pits are emptied into the same slurry sewerage system towards the slurry store. Water is changed after each round (approximately 4 weeks). The front section is drained completely, cleaned, disinfected and then filled up again with fresh water.

**Costs:** The extra investment costs are EUR 60 per pig place. This means for a 52 % reduction about EUR 13.85 per kg NH<sub>3</sub> abated. The extra annual operational costs are EUR 1.00 per pig place or EUR 0.25 per kg NH<sub>3</sub>.

**Reference farms:** In the Netherlands 5000 sow places are equipped with this system.

**Reference literature:** [10, Netherlands, 1999] [37, Bodemkundige Dienst, 1999]

### 4.6.2.3 Crates with fully-slatted floor and flushing system with manure gutters

**Description:** Small gutters limit the manure surface. This reduces the ammonia emission. Application is possible in pens with a partly or fully-slatted floor. The manure is removed frequently by a flushing system. The slats are made of triangular iron slats. The gutter sides should have a slope of 60 degrees. The gutters should be flushed twice a day. The flushing will be done by the liquid fraction of the manure (after separation), where the dry matter content should not be higher than 5 %.

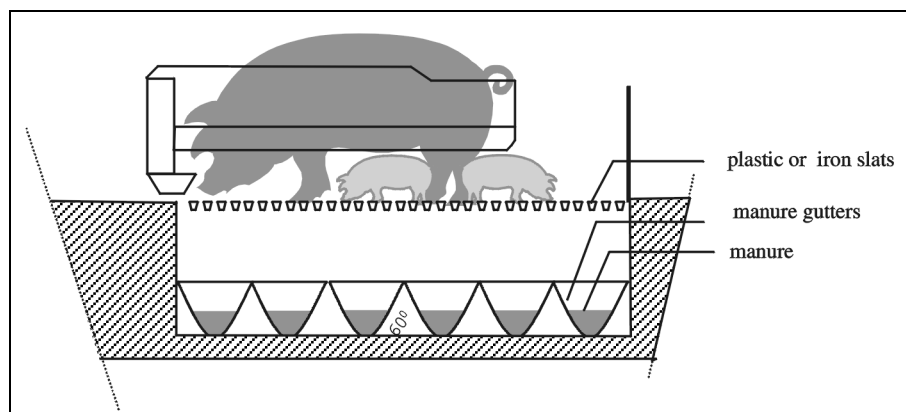

**Figure 4.31: Flushing system with manure gutter**  
[10, Netherlands, 1999]

**Environmental benefit:** Limiting the manure surface in the manure channel, in combination with fast discharging of the manure from the slatted area by using plastic or iron triangular bars, and removing the manure twice a day by flushing reduces  $\text{NH}_3$  emissions by 60 % (3.3 kg  $\text{NH}_3$  per sow place per year (NL, B))

**Cross-media effects:** This system has an extra energy consumption of 8.5 kWh per sow place per year, related to the flushing of the gutters.

Odour peaks due to flushing may cause a nuisance when receptors are living near the farm. On a case by case basis it has to be decided whether an overall load (thus applying a no-flushing system) or peak values are more important. [184, TWG ILF, 2002]

**Applicability:** In existing houses the applicability depends on the design of the existing manure pit, but it does not seem difficult with the reference system.

**Costs:** The extra investment costs are EUR 535 per sow place. This means with a 60 % reduction, i.e. 8.3 to 3.3 kg  $\text{NH}_3$ , costs are EUR 107 per kg  $\text{NH}_3$  abated. The extra operational costs per year are EUR 86.00 per pig place. This means EUR 17.20 per kg  $\text{NH}_3$ .

To achieve a slightly better reduction extra costs are considerably higher than those reported for the system with a separated water and manure channel. This difference could not be explained from the submitted information.

**Reference farms:** In the Netherlands, about 500 farrowing sow places are equipped with this system.

**Reference literature:** [10, Netherlands, 1999] [37, Bodemkundige Dienst, 1999]



#### 4.6.2.4 Crates with fully-slatted floor and manure pan

**Description:** A prefabricated pan is placed under the slatted floor and can be adapted to the dimensions of the pen. The pan is deepest at one end of the pen and the pan has a slope of at least  $3^\circ$  towards a central slurry channel. The pan is connected with a sewerage system. Every three days the manure should be removed by the sewerage system. The application does not depend on the pen design, or on whether it is with a fully or a partly-slatted floor. The slats are made of iron or plastic.

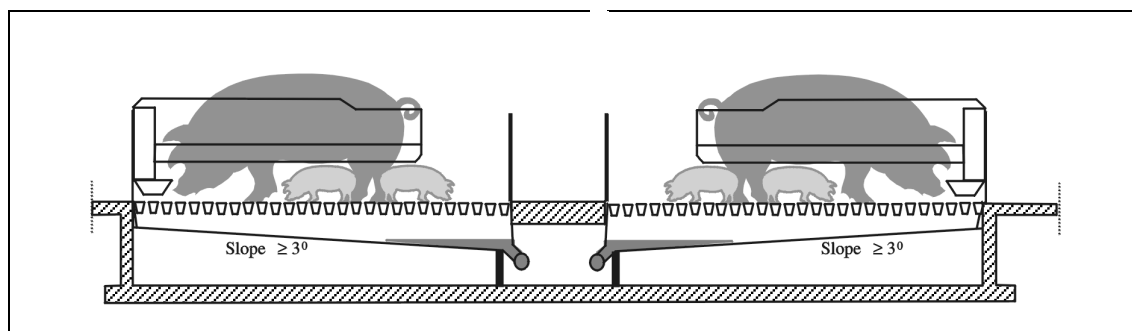

**Figure 4.32: Fully-slatted floor with manure pan**  
[10, Netherlands, 1999]

**Environmental benefit:** Limiting the manure surface and frequent removal of the slurry by a sewerage system achieves a 65 % reduction of  $\text{NH}_3$ -emissions (2.9 kg  $\text{NH}_3$  per sow place per year). An increased reduction of 50 % compared with the sloped board construction is achieved, although both designs seem to be very similar. A lower emitting surface and a more frequent removal of the slurry is considered to be the most important factors determining the difference.

**Applicability:** This system is easy to implement in reconstructions of existing buildings. The design of the pen is not critical for the applicability of the system.

**Costs:** The extra investment costs are EUR 280 per pig place. This means with a 65 % reduction, i.e. 8.3 to 2.9 kg  $\text{NH}_3$ , costs are EUR 53.85 per kg  $\text{NH}_3$  abated. The extra operational costs per year are EUR 45.85 per pig place. This means EUR 8.80 per kg  $\text{NH}_3$ .

**Reference farms:** In the Netherlands, about 10000 sow places are equipped with this system. This system has only recently been developed (1998). Currently this system is being implemented in many reconstructions as well as in new buildings.

**Reference literature:** [10, Netherlands, 1999]

#### 4.6.2.5 Crates with fully-slatted floor and manure surface cooling fins

**Description, cross-media effects, applicability:** see Section 4.6.1.5.

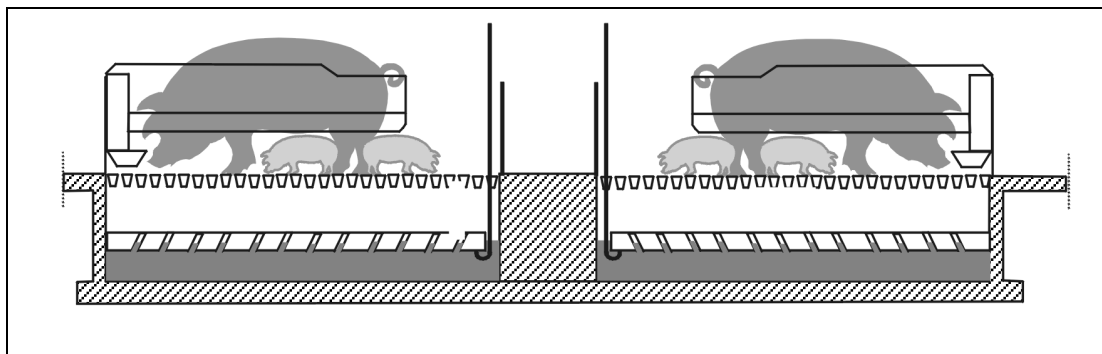

**Figure 4.33: Farrowing pen with floating cooler fins**  
[10, Netherlands, 1999]

**Achieved environmental benefits:** Cooling the manure surface achieves a 70 % reduction (i.e. from 8.3 to 2.4 kg NH<sub>3</sub> per pig place per year (NL, B)). From the achieved reduction it seems that the surface temperature is one of the most important factors determining the NH<sub>3</sub> emission. It is recommended to keep the housing as cool as possible with respect to the animals welfare and production.

**Costs:** The extra investment cost is estimated at EUR 302 per sow place or, with a 70 % reduction, costs are EUR 51.20 per kg NH<sub>3</sub> abated. The extra annual operational costs are EUR 54.25 per sow place. This means EUR 9.20 per kg NH<sub>3</sub> abated.

**Reference farms:** In the Netherlands, about 10000 farrowing pens are equipped with this system. Nowadays this system is being implemented in many reconstruction situations and in some new buildings.

**Reference literature:** [10, Netherlands, 1999] [37, Bodemkundige Dienst, 1999]

#### 4.6.2.6 Crates with partly-slatted floor

**Description:** In all systems manure is handled in the form of slurry. It is often drained by means of discharge pipes, in which the individual sections of the manure channels are emptied via plugs in the discharge pipes. The manure channels can also be drained by means of gates. The channels are cleaned after each farrowing when the farrowing crates are disinfected, i.e. at intervals of about 4 – 5 weeks.

The design of this system is comparable with the design of the reference system (Section 2.3.1.2) and with Figure 4.34, only without the scraper. The reduced surface reduces the ammonia emission.

**Achieved environmental benefits:** A reduction of NH<sub>3</sub>-emission by 34 % is reported, this is due to reducing the emitting slurry surface area.

**Cross-media effects:** There has been no change in the use of energy reported compared with the fully-slatted design.

For animal welfare reasons a solid floor is better than a slatted floor, however the benefits are only for the pigs and not for the sows [184, TWG ILF, 2002].

**Operational data:** This housing type is fitted with mechanical ventilation either in the form of negative-pressure or balanced-pressure plants. Ventilation is dimensioned for a maximum output of 250 m<sup>3</sup> per hour per farrowing crate. Its operation is described in Chapter 2.

**Applicability:** This technique is widely practised in Denmark. It is assumed that in existing houses the applicability will depend on the design of the existing manure pit, but that it is generally difficult if not impossible to apply.

**Reference farms:** Applied in Denmark.

**Reference literature:** [87, Denmark, 2000]

#### 4.6.2.7 Crates with partly-slatted floor and manure scraper

**Description:** See previous Section 4.6.1.9 and Figure 4.34. The slats can be made of iron or plastic (no concrete slats).

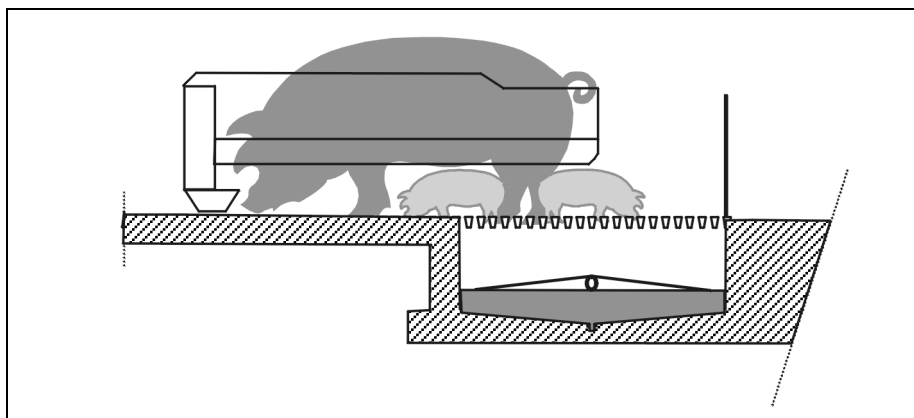

**Figure 4.34: Partly-slatted floor with a manure scraper**  
[10, Netherlands, 1999]

**Achieved environmental benefits:** A reduction in NH<sub>3</sub>-emissions is achieved by reducing the slurry surface and by the frequent scraping of slurry and draining of the urine. Results for the partly-slatted design are 35 % (5.65 kg NH<sub>3</sub> per sow place per year (I)) to 52 % (4.0 kg NH<sub>3</sub> per sow place per year (NL, B))

**Cross-media effects:** The power consumption of scraping varies with the frequency, with consumption being reported as 2.4 (I) and 3.5 (NL) kWh per sow per year.

**Operational data:** The working of the system is vulnerable due to the wear of the top floor. Reductions of 35 – 52 % have been reported.

**Applicability:** The system with a partly or fully-slatted floor can be applied in new houses. Although to implement this system some alterations are needed in the manure pit, and in existing houses the applicability depends on the design of the existing manure pit. However, in general it is mostly difficult to apply.

**Costs:** Relatively high costs have been reported, although Italian information reports lower costs than the reference (no data). Compared to a fully-slatted floor the ammonia reduction can be 52 %, but requires extra investment of EUR 785 per sow place or EUR 182.55 per kg NH<sub>3</sub> abated. The extra annual costs are EUR 147.20 per sow place or EUR 34.20 per kg NH<sub>3</sub>.

**Reference farms:** A few in the Netherlands.

**Reference literature:** [10, Netherlands, 1999], [59, Italy, 1999] [127, Italy, 2001].

### 4.6.3 System-integrated housing techniques for weaned piglets

The data on weaned piglets are summarised in Table 4.23. Weaners are group-housed. Pens and flatdecks are comparable designs (Section 2.3.1.3). The **reference system** for weaned piglets is a combination of the classic crate with a fully-slatted floor made of plastic or metal elements and an underlying pit, with manure removal at the end of the cycle. Ammonia emissions from this type of housing are estimated to be about 15 % of the total amount of nitrogen excreted by the piglets, corresponding to 0.6 and 0.8 kg NH<sub>3</sub> per weaner place per year. This type of housing is equipped with mechanical ventilation, either negative-pressure or balanced-pressure ventilation plants. Ventilation is dimensioned for maximum output of 40 m<sup>3</sup> per hour per place. Auxiliary heating is also applied in the form of electric fan heaters or by a central heating plant with heating pipes.

In the following sections reference will be made to the principles of the applied slurry pit designs and removal techniques that have previously been described in earlier sections.

Extra costs compared to the reference system have been reported for some alternatives. For others an indication is given whether the alternative is more or less expensive than the reference system.

Section	Housing system	NH <sub>3</sub> -reduction (%)	Extra investment cost (EUR/place) <sup>1)</sup>	Extra annual operational cost (EUR/place/yr) <sup>1)</sup>	Energy input (kWh/place/yr)	
	Pens or flatdecks with fully-slatted floor and underlying deep collection pit (reference)	0.6 (NL, I) 0.80 (DK) kg NH <sub>3</sub> /sow place/yr				
	<i>Fully-slatted floor (FSF)</i>					
4.6.1.1	Pens or flatdecks with FSF and vacuum system	25	no data	no data	less than reference	
4.6.3.1	Pens or flatdecks with FSF and concrete sloped floor to separate faeces and urine	30	less	less	same as reference	
4.6.3.2	Pens or flatdecks with FSF and manure pit with scraper	35	68.65	12.30	0.24 <sup>2)</sup>	
4.6.3.3	Pens or flatdecks with FSF and flush gutters or flush tubes	non aerated	40	25	4.15	1.9 <sup>2)</sup>
		aerated	50	very high	very high	3.1 <sup>2)</sup>
	<i>Partly-slatted floor (PSF)</i>					
4.6.1.6	Pens or flatdecks with PSF and vacuum system	25 – 35	no data	no data	less than reference	
4.6.3.4	Pens with PSF and two-climate system	34	same as reference	same as reference	same as reference	
4.6.3.5	Pens with PSF and sloped or convex solid floor	43	same as reference	same as reference	same as reference	
4.6.3.6	Pens with PSF and shallow manure pit and channel for spoiled drinking water	57	2.85	0.35	same as reference	
4.6.3.7	Pens with PSF with triangular iron slats and manure channel with gutters	65	25	4.15	0.75 <sup>2)</sup>	
4.6.3.8	Pens with PSF and manure scraper	40 to 70	68.65	12.30	0.15 <sup>2)</sup>	
4.6.3.9	Pens with PSF with triangular iron slats and manure channel with sloped side wall(s)	72	4.55	0.75	same as reference	
4.6.3.10	Pens with PSF and manure surface cooling fins	75	24	9.75	higher than reference	
4.6.3.11	PSF with triangular slats and covered box	55	same as reference	no data	less than reference	
	<i>Solid concrete floor and straw based (SCF)</i>					
4.6.3.12	SCF with straw and natural ventilation	no data	same as reference	higher than reference	less than reference	
<p>(<sup>1)</sup> Member State from which the data originate</p> <p>1) source: [10, Netherlands, 1999] [37, Bodemkundige Dienst, 1999] [185, Italy, 2001] [87, Denmark, 2000] [187, IMAG-DLO, 2001] [184, TWG ILF, 2002] [189, Italy/UK, 2002]</p> <p>2) the number only relates to energy required for flushing or scraping, not for ventilation</p>						

**Table 4.23: Performance levels of system-integrated housing techniques for new installations for weaned piglets**

#### 4.6.3.1 Pens or flatdecks with fully-slatted floor and concrete sloped floor to separate faeces and urine

**Description:** The principle is described in Section 4.6.2.1. At the end of the weaning period, dry faeces are easily removed by water jets.

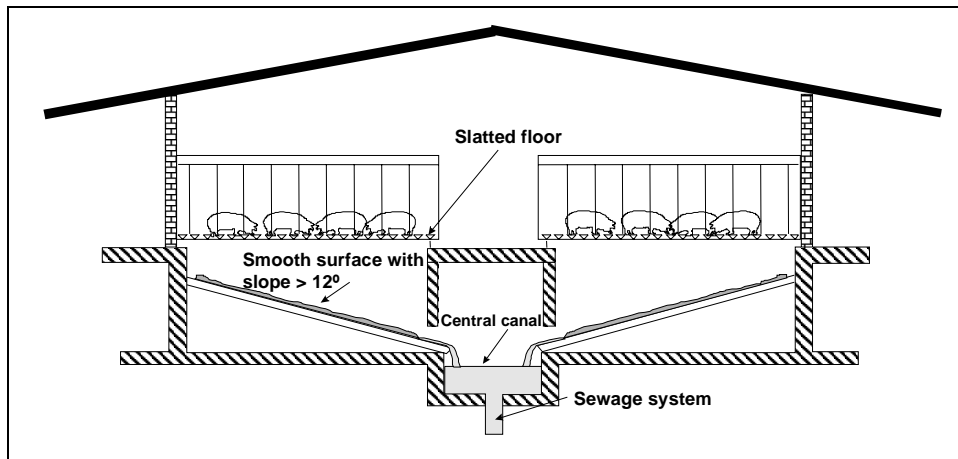

Figure 4.35: Flatdecks or pens with concrete sloped floor underneath to separate faeces and urine [59, Italy, 1999]

**Achieved environmental benefits:** Immediate removal of manure to central channel and immediate draining of urine achieves reduction of 30 % (0.42 kg NH<sub>3</sub> per pig place per year (I)).

**Cross-media effects:** There is no additional energy required.

**Applicability:** With a manure pit of sufficient depth, this technique can be easily applied in existing housing.

**Costs:** Investment costs are estimated to be less than the reference, if the benefits are included in costs calculation.

**Reference farms:** A few applications in Italy.

**Reference literature:** [59, Italy, 1999] [185, Italy, 2001].

#### 4.6.3.2 Pens or flatdecks with fully-slatted floor and manure pit with scraper

**Description:** See for the principle Section 4.6.1.9 and Figure 4.36. Slats can be made of iron or plastic, but not of concrete.

**Achieved environmental benefits:** Frequent removal of the manure to the manure pit outside the building and a separate urine drain allows a slightly better reduction of 35 % (0.39 kg NH<sub>3</sub> per pig place per year) to be achieved.

**Cross-media effects:** The energy required for operating the scraper is estimated to be 0.24 kWh per weaner place per year.

**Operational data:** The operability of the system is vulnerable due to the wear of the top coating on the floor. More research is required to optimise the operability.

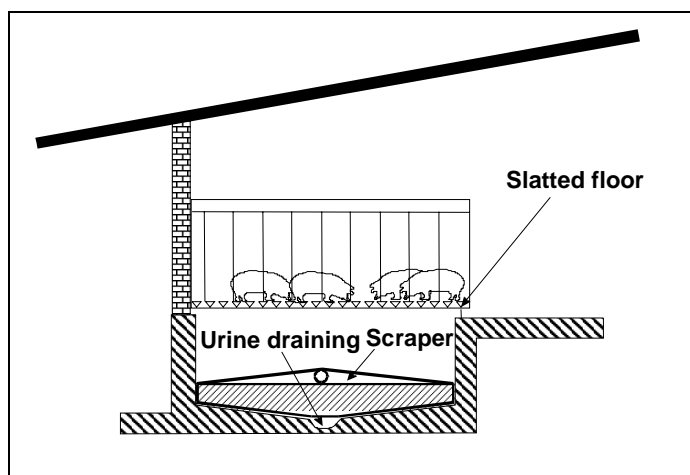

**Figure 4.36: Flatdeck system with a scraper under a fully-slatted floor**  
[185, Italy, 2001]

**Applicability:** The system has not been described as a possible alteration of existing weaner housing systems, where it requires changes to be made to the manure pit.

**Costs:** The extra investment costs are EUR 68.65 per pig place, and extra annual operating costs are EUR 12.30 [184, TWG ILF, 2002].

**Reference literature:** [59, Italy, 1999].

#### 4.6.3.3 Pens or flatdecks with fully-slatted floor and flush gutters or flush tubes

**Description:** See Section 4.6.1.3 for the description of the pit design.

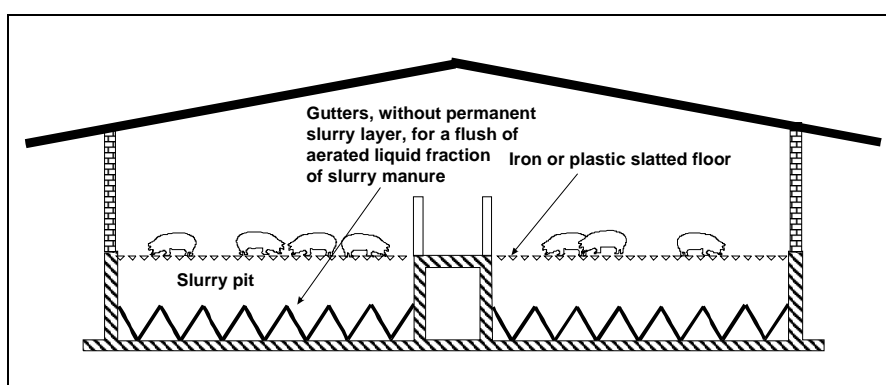

**Figure 4.37: Pens with fully-slatted floor with flush gutters or flush tubes**  
[185, Italy, 2001]

**Achieved environmental benefits:** Limiting the manure surface in the manure channel and removing the manure twice a day by flushing achieves a reduction of 40 % (0.36 kg NH<sub>3</sub> per pig place per year) with fresh slurry, and of 50 % (0.30 kg NH<sub>3</sub> per pig place per year) with aerated slurry.

**Cross-media effects:** This system needs energy for flushing twice a day, amounting to 1.9 kWh per weaner per day with fresh liquid, and to 3.1 kWh per weaner per day for aerated slurry.

Odour peaks due to flushing may cause a nuisance when receptors are living near the farm. The peaks are higher if flushing is done without aeration rather than if it is done with aeration. On a case by case basis it has to be decided whether an overall load (thus applying a no-flushing system) or peak values are more important. [184, TWG ILF, 2002]

**Operational data:** To operate this system outside of the housing an installation must be available to separate the liquid from the slurry manure and in some cases to aerate this before it can be used as flushing fluid.

**Applicability:** The system with flushing gutters can be applied in new houses. In existing houses the applicability depends on the design of the existing manure pit. To implement this system only a few alterations (to the floor) are needed.

**Costs:** For the system without aeration, the extra investment costs are EUR 25 per pig place and the extra annual operational costs are EUR 4.15 per pig place. The system with aeration is considered to be very expensive [184, TWG ILF, 2002].

**Reference literature:** [59, Italy, 1999].

### 4.6.3.4 Pens with partly-slatted floor; the two climate system

**Description:** Manure is handled as a slurry. It is often drained through a pipe discharge system where the individual sections of the manure channels are drained via plugs in the discharge pipes. The channels can also be emptied via gates. The channels are drained after the removal of each group of pigs, often in connection with disinfecting the pens, i.e. at intervals of 6 - 8 weeks.

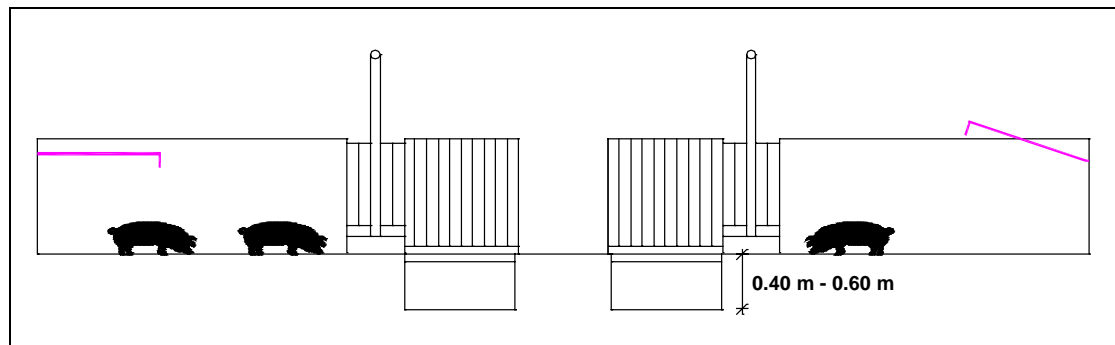

**Figure 4.38: Cross-section of rearing unit with partly-slatted floor, two-climate**  
[87, Denmark, 2000]

**Achieved environmental benefits:** A reduction in ammonia emissions by 34 % (0.53 kg NH<sub>3</sub> per pig place per year) is achieved when applying this technique. This technique has been applied in Denmark and its performance is therefore compared with the emission level of the reference obtained in Denmark (0.8 kg NH<sub>3</sub> per pig place per year).

**Cross-media effects:** The naturally ventilated design uses less energy compared to the reference [184, TWG ILF, 2002].

**Operational data:** This housing type is normally equipped with mechanical ventilation, either in the form of negative-pressure or balanced-pressure ventilation. The ventilation is dimensioned for a maximum output of 40 m<sup>3</sup> per hour per place. Auxiliary heating is available in the form of either electric fan heaters or a central heating plant with heating pipes. Naturally ventilated designs are also applied.



Windows are installed in the housing to allow the pigs to be easily checked.

**Applicability:** This system is applicable in new and existing installations.

**Costs:** The extra investment costs and operational costs are estimated to be equal to the reference system [184, TWG ILF, 2002].

**Reference farms:** It is estimated that in Denmark 30 – 40 percent of the weaners, corresponding to about 1600000 places, are housed on partly-slatted floors weighing from 7.5 to 30 kg. This figure is expected to increase.

**Reference literature:** [87, Denmark, 2000]

#### 4.6.3.5 Pens with partly-slatted floor and sloped or convex solid floor

**Description:** Using a partly solid concrete floor reduces the manure surface. Limiting the manure surface reduces the ammonia emission. Application is possible in pens with a convex floor. The convex floor separates the two channels. Application is also possible in pens with a partly-slatted floor consisting of a solid concrete floor on a slope in front of the pen. The slats can be iron or plastic (not concrete slats).

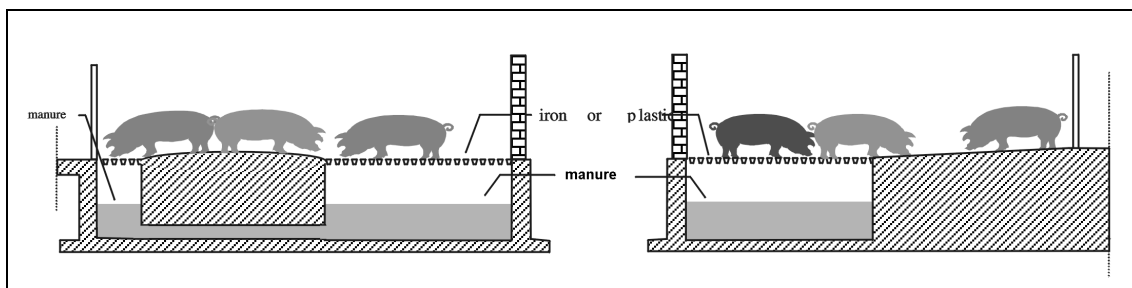

**Figure 4.39: Partly-slatted floor with iron or plastic slats and convex or sloped concrete floor** [10, Netherlands, 1999]

**Achieved environmental benefits:** Limiting the manure surface in the manure channel achieves a reduction of 43 % (0.34 kg NH<sub>3</sub> per pig place per year). The reduction can in fact only be achieved by changing the design of the pen. This design is similar to the previous design, although a higher reduction is achieved, which is attributed to the convex or sloped floor.

**Operational data:** It is assumed that this is similar to the reference system.

**Applicability:** The system with partly-slatted floor or a convex floor can be applied in new houses. In existing houses the applicability depends on the design of the existing manure pit.

**Costs:** Extra investment is not needed if this alternative could be applied instead of a fully-slatted floor. Annual costs are also similar.

**Reference farms:** At least 10000 piglet places have been equipped with this system in the Netherlands.

**Reference literature:** [10, Netherlands, 1999].

#### 4.6.3.6 Pens with partly-slatted floor and shallow manure pit and channel for spoiled drinking water

**Description:** Using a partly solid concrete floor reduces the manure surface. Limiting the manure surface reduces the ammonia emission. Application is possible in pens with a convex floor. The convex floor separates the two channels. The front channel is partly filled with water, as the pigs don't normally use the front area as a dunging area. Only spoiled feed concentrates come into the front channel. The main function of the water is to prevent flies breeding.

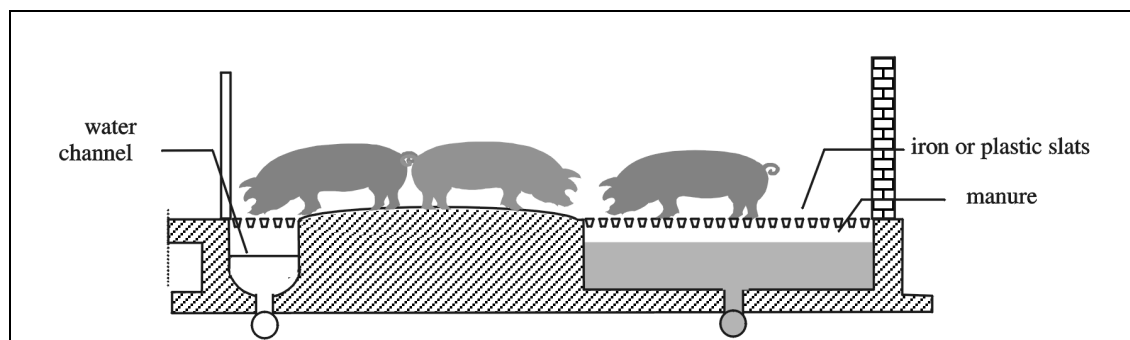

**Figure 4.40: Shallow manure pit with a channel for spoiled drinking water in front in combination with a convex floor with iron or plastic slats [10, Netherlands, 1999]**

**Achieved environmental benefits:** Limiting the manure surface in the manure channel, together with quickly discharging the manure on the slatted area by using iron triangular bars and removing the manure frequently by a sewerage system reduces emissions by 57 % (0.26 kg NH<sub>3</sub> per pig place per year (NL, B)).

**Cross-media effects:** No extra energy required.

**Operational data:** It is assumed to be similar to the reference system.

**Applicability:** In existing houses the applicability depends on the design of the existing manure pit.

**Costs:** The extra investment is EUR 2.85 per pig place. The extra annual operational costs are EUR 0.35 per pig place.

**Reference farms:** In the Netherlands, about 250000 weaner places have been equipped with this system.

**Reference literature:** [10, Netherlands, 1999]

#### 4.6.3.7 Pens with partly-slatted floor with triangular iron slats and manure channel with gutters

**Description:** See the previous descriptions of flushed gutter systems in Section 4.6.3.3 and Figure 4.41. The difference is a separate water channel. Small gutters limit the manure surface. The manure will be removed frequently by a flushing system. The slats are made of triangular iron slats or plastic bars. The gutter sides should have a slope of 60 degrees. The gutters should be flushed twice a day. The flushing will be done by the liquid fraction of the manure (after separation) and the dry matter content should not be higher than 5 %.

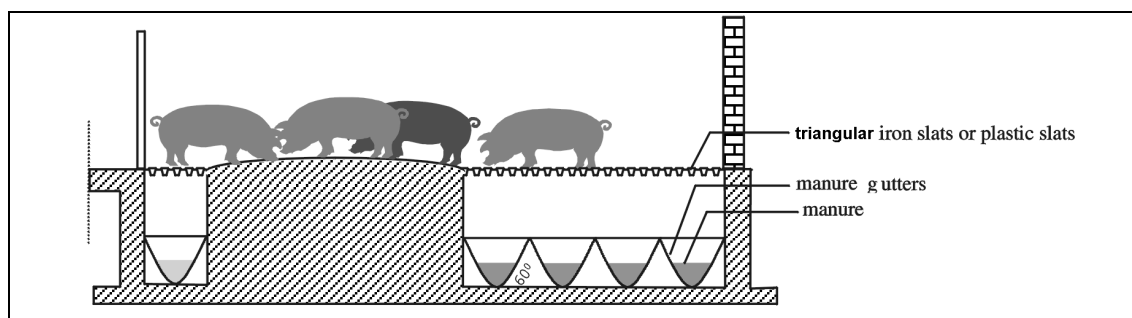

**Figure 4.41: Convex floor with triangular iron slats in combination with a gutter system** [10, Netherlands, 1999]

**Achieved environmental benefits:** Limiting the manure surface in the manure channel, removing the manure twice a day by flushing and fast discharging of the manure on the slatted area by using iron triangular bars achieves a 65 % reduction (0.21 kg NH<sub>3</sub> per pig place per year (NL, B)).

**Cross-media effects:** This system has an extra energy consumption due to flushing (twice a day) of 0.75 kWh per weaner place per year.

Odour peaks due to flushing may cause a nuisance when receptors are living near the farm. On a case by case basis it has to be decided whether an overall load (thus applying a no-flushing system) or peak values are more important. [184, TWG ILF, 2002]

**Operational data:** To operate this system outside of the housing an installation must be available to separate the liquid from the slurry manure before it can be used as the flushing fluid.

**Applicability:** In existing houses the applicability depends on the design of the existing manure pit. This system is easily applicable in pens with a central convex or a partly-slatted floor with a sloped concrete floor (Section 4.6.3.5). To implement this system only a few alterations are needed.

**Costs:** The extra investment cost is EUR 25 per pig place. This means that with a 65 % reduction (0.60 to 0.21 kg NH<sub>3</sub>), costs are EUR 64.10 per kg NH<sub>3</sub> abated. The extra annual operational costs are EUR 4.15 per pig place. This means EUR 10.64 per kg NH<sub>3</sub> abated.

**Reference farms:** In the Netherlands, about 75000 weaned piglet places have been equipped with this system.

**Reference literature:** [10, Netherlands, 1999] [37, Bodemkundige Dienst, 1999]

#### 4.6.3.8 Pens with partly-slatted floor and manure scraper

**Description and application:** See Section 4.6.1.9 and Figure 4.42. The design of the slats can be iron or plastic (not concrete slats).

**Environmental benefit:** Frequently removing the manure from the manure pit outside the building reduces emissions by between 40 % (0.36 kg NH<sub>3</sub> per pig place per year (I)) and 70 % (0.18 kg NH<sub>3</sub> per pig place per year (NL, B)). Slat material, frequency of removal and smoothness of the pit floor all contribute to the reduction that can be achieved.

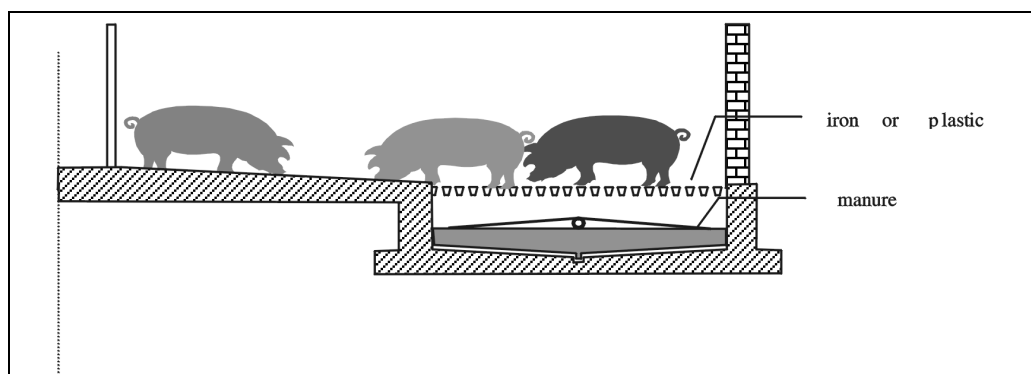

**Figure 4.42: Partly-slatted floor with a manure scraper**  
[10, Netherlands, 1999]

**Cross-media effects:** Energy is required for scraping, and is about 0.15 kWh per weaner place per year.

**Operational data:** The working of the system is vulnerable due to the wear of the top coating on the floor. More research is required to improve the operability of the system.

**Costs:** Extra investment costs are EUR 68.65 per weaner place. This means that with a 70 % reduction (0.60 to 0.18 kg NH<sub>3</sub>), costs are EUR 163.5 per kg NH<sub>3</sub> abated. The extra annual operational costs are EUR 12.30 per weaner place or EUR 29.30 per kg NH<sub>3</sub>.

**Reference farms:** A few piglet places (40000) have been equipped in the Netherlands.

**Reference literature:** [10, Netherlands, 1999] [37, Bodemkundige Dienst, 1999]

#### 4.6.3.9 Pens with partly-slatted floor with triangular iron slats and manure channel with sloped side wall(s)

**Description:** Side wall(s) on a slope reduce the manure surface, see Figure 4.43. This in turn reduces the ammonia emission. Application is possible in pens with a convex floor. The convex floor separates the two channels. The front channel is partly filled with water, as the pigs don't normally use the front area as a dunging area. Only spoiled feed concentrates come into the front channel. The main function of the water is to prevent flies breeding. Application is also possible in pens with a partly-slatted floor consisting of a solid concrete floor on a slope in front of the pen. The manure will be removed frequently by a sewerage system. The slats are made of triangular iron bars. The manure surface in the manure channel should not be larger than 0.07 m<sup>2</sup> per pig place. The surface of the sloping wall(s) should be made of a smooth material to the manure adhering to the surface. A sloping wall at the back is not required, but when a sloping wall is present, then this wall should have a slope between 60 and 90 degrees. The wall next to the solid concrete floor should have a slope of between 45 and 90 degrees.

**Achieved environmental benefits:** Limiting the manure surface in the manure channel, together with a fast discharge of the manure from the slatted area by using iron triangular bars and a frequent removal of the manure by means of a sewerage system achieves a 72 % reduction (0.17 kg NH<sub>3</sub> per pig place per year).

**Cross-media effects:** This system doesn't need extra energy compared with the reference.

**Operational data:** This is similar to the reference system.

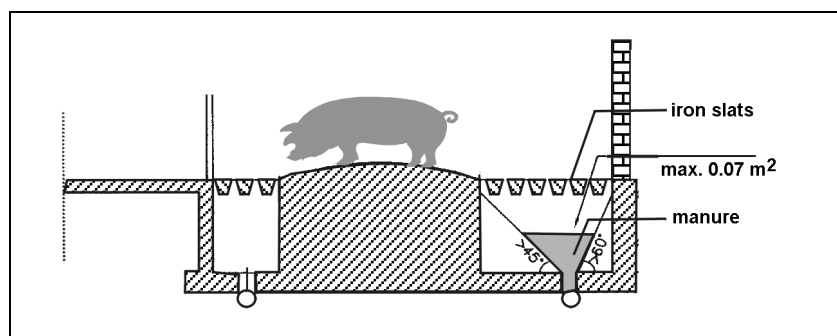

**Figure 4.43: Convex floor with triangular iron slats in combination with sewerage system and side walls on a slope in the manure channel**  
[10, Netherlands, 1999]

**Applicability:** The system with side wall(s) on a slope can be applied in existing houses, with only a few alterations.

**Costs:** Extra investment costs are EUR 4.55 per pig place. With a 72 % reduction, this means about EUR 10.58 per kg NH<sub>3</sub> abated. Extra annual operational costs are EUR 0.75 per pig place or EUR 1.74 per kg NH<sub>3</sub>.

**Reference farms:** This system is a recent development (1998). Currently this system is being implemented in most new buildings and alterations in the Netherlands.

**Reference literature:** [10, Netherlands, 1999].

#### 4.6.3.10 Pens with partly-slatted floor and manure surface cooling fins

**Description, cross-media effects and applicability:** See Section 4.6.1.5.

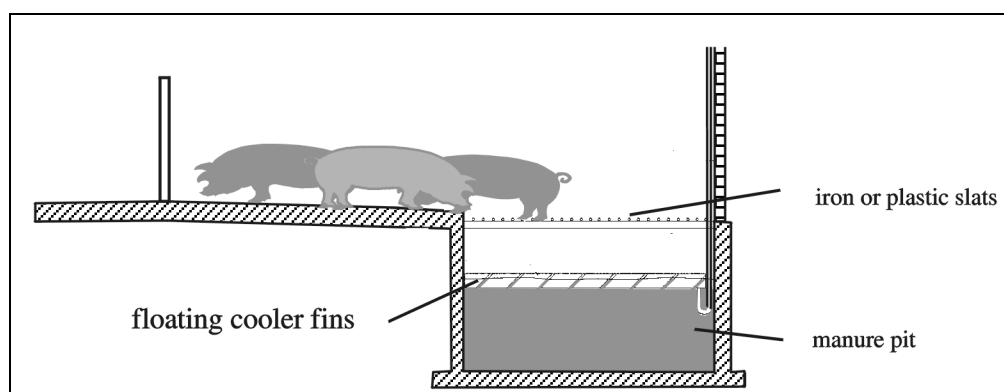

**Figure 4.44: Pen for weaners, partly-slatted floor and manure surface cooling**  
[10, Netherlands, 1999]

**Achieved environmental benefits:** Cooling the manure in combination with a partly-slatted floor gives the best reduction, at 75 % (0.15 kg NH<sub>3</sub> per pig place per year (NL, B)).

**Costs:** The extra investment costs are EUR 24 per pig place. With a 75 % reduction, this means 0.6 to 0.15 kg NH<sub>3</sub>, i.e. about EUR 53.30 per kg NH<sub>3</sub> abated. The extra operational costs per year are EUR 4.40 per pig place. This means EUR 9.75 per kg NH<sub>3</sub> abated.

**Reference farms:** This system was developed just a few years ago. Nowadays this system is being implemented in many rebuild situations and in some new buildings in the Netherlands.

**Reference literature:** [10, Netherlands, 1999] [37, Bodemkundige Dienst, 1999]

#### 4.6.3.11 Partly-slatted floor with covered box: the kennel housing system

**Description:** In the middle of the area is a solid floor with feeders. The floor is littered with a small amount of straw for the enrichment (animal welfare). The dunging areas are situated on the short sides of the pen. The covered lying area is situated along the width of the pen. The emitting surface of the (metal triangular) slats is a maximum of 0.09 m<sup>2</sup> per piglet.

Due to the covered lying boxes the room temperature can be lower as normal. This system is also well applicable in naturally ventilated houses.

The working principle is that ammonia reduction compared to the reference is brought about due to the small emitting manure pit. Providing some straw on the solid concrete floor in the middle will prevent the floor getting dirty.

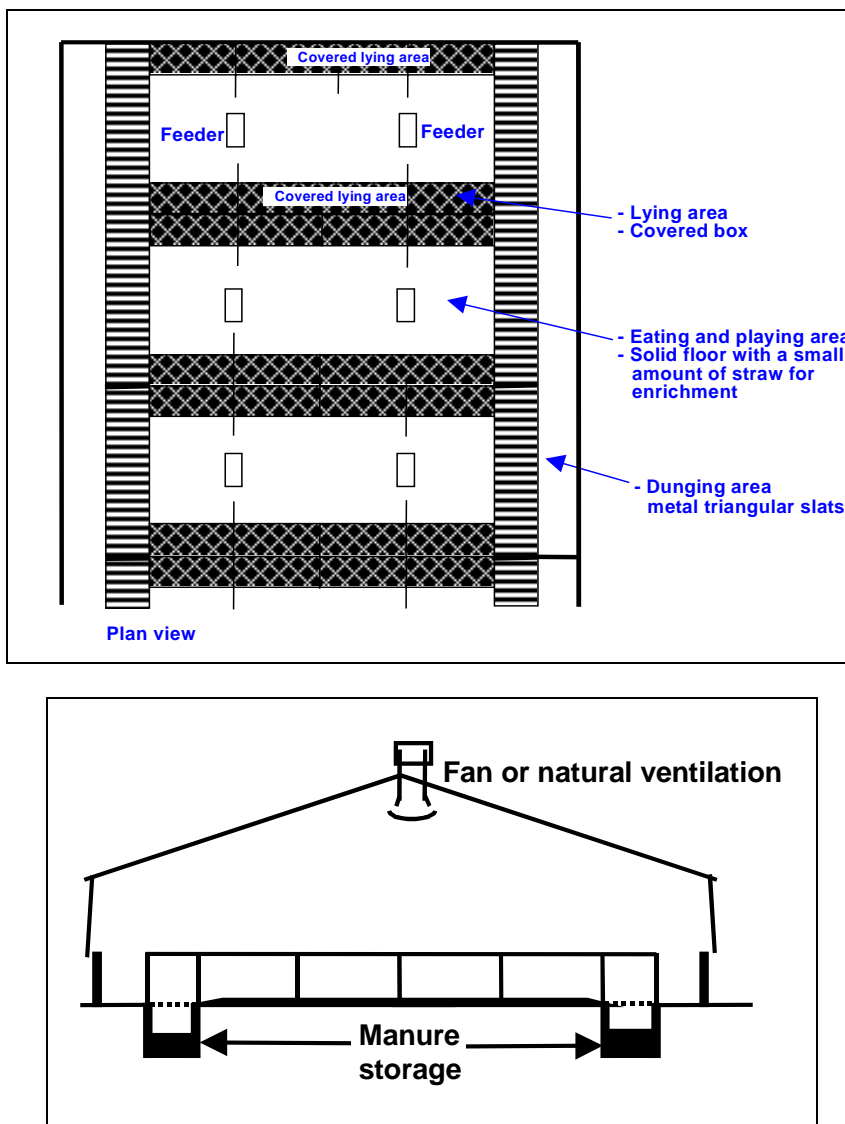
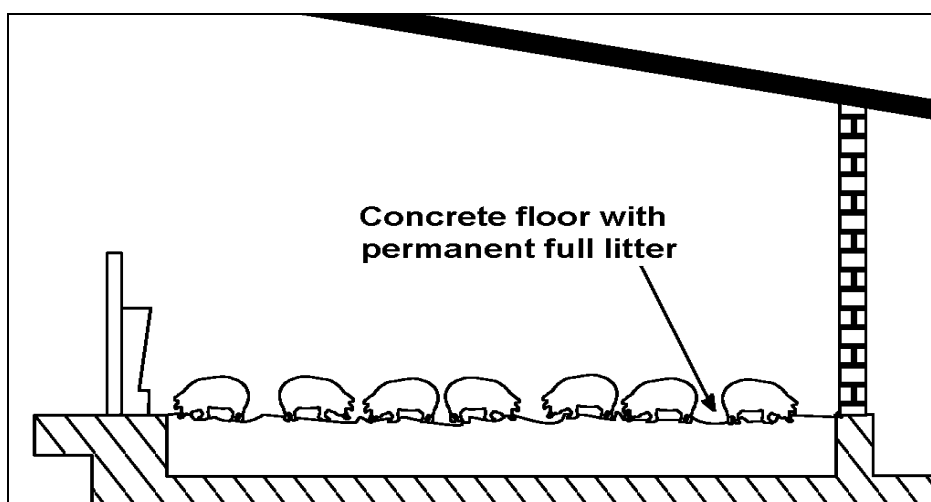

Figure 4.45: Kennel housing system [187, IMAG-DLO, 2001]

#### 4.6.3.12 Pens with solid concrete straw-bedded floor: natural ventilation

**Description:** The concrete solid floor is almost completely bedded with a layer of straw or other ligno-cellulose materials to absorb urine and to incorporate faeces. Solid manure is obtained, which has to be frequently removed in order to avoid the litter becoming too wet. In cooler climatic regions, the floor area may be divided such that a fully insulated kennel or creep (heated) provides a lying area for the weaned pigs with access to a fully bedded dunging area. Some straw is provided in the kennel or creep. The system is applied to weaning pigs up to 25 kg LW.



**Figure 4.46: pens with solid concrete straw-bedded floor: natural ventilation**  
[189, Italy/UK, 2002]

**Achieved environmental benefits:** The ammonia emission is not known.

**Applicability:** The system can be applied in all new housings. For existing housing it may be applicable in buildings with concrete solid floors. Design details will vary.

**Operational data:** It is expected that the use of straw will allow the weaners to control the temperatures themselves in systems where insulated kennels or creeps are not used, thus requiring no additional energy for heating.

**Cross-media issues:** The system is recommended on welfare grounds. The production of solid manure instead of liquid manure (slurry) is considered an advantage from the agronomic point of view. Organic matter incorporated in the fields improves the physical characteristics of the soils, reducing run-off and the leaching of nutrients to water bodies.

Odour might be a problem if not enough straw is used [184, TWG ILF, 2002].

**Costs:** Capital costs are expected to be in the same range as with the reference technique. The annual operational costs are expected to be higher [184, TWG ILF, 2002].

**Reference farms:** Sartori farm (Parma) in Italy. About 4 % of the weaning pigs in Italy are kept on fully bedded systems. In the UK, kennels & creeps (with heat) in association with a fully bedded system are common, with group sizes around 100 pigs from 7 kg (weaning) up to 15 or 20 kg.

**Reference literature:** [185, Italy, 2001] [189, Italy/UK, 2002]

#### 4.6.4 System integrated housing techniques for growers/finishers

In Table 4.24 potential BAT housing techniques for finishers are presented. Most of the alternatives presented have been described in the section on the housing of mating and gestating pigs.

**Reference technique:** the reference technique for growers/finishers is a fully-slatted floor with a deep pit with an associated emission level ranging between 2.39 and 3.0 kg NH<sub>3</sub> per pig place per year. Italy reported an energy requirement for artificial ventilation estimated at 21.1 kWh per grower/finisher place per year [185, Italy, 2001], Germany reported a range of 20 to 30 kWh per grower/finisher place per year for artificial ventilation [124, Germany, 2001]

It is the most commonly applied system and described in Section 2.3.1.4.1.

For descriptions and pictures of techniques, reference is made to the earlier sections in Section 4.6.1. In this section only the relevant paragraphs for each technique are presented if data are different from what has been described in Section 4.6.1. This is valid for:

- Fully-slatted floor with vacuum system (Section 4.6.1.1)
- Fully-slatted floor with flushing of a permanent slurry layer in canals (Section 4.6.1.2)
- Fully-slatted floor with flush gutters or flush tubes (Section 4.6.1.3).

The following partly-slatted floor designs for growers/finishers have been described and discussed in Section 4.6.1:

- Partly-slatted floor with deep pit underneath (Section 4.6.1.4)
- Partly-slatted floor with vacuum system (Section 4.6.1.6)
- Partly-slatted floor with flushing of a permanent slurry layer in canals underneath (Section 4.6.1.7)
- Partly-slatted floor with scraper (Section 4.6.1.9).

In Germany, pens with partly-slatted floors with a shallow manure pit on either side of a convex floor are also applied (see Section 4.6.3.6). Reportedly this system does not lead to a reduced emission compared with the reference, as ammonia emissions are about 3 (2 – 5) kg NH<sub>3</sub> per pig place per year. The costs of this design (floor in centre or on one side) are in the same order of magnitude.



Section number	Housing system		NH <sub>3</sub> -reduction (%)		Energy input (kWh/place/yr)
	Group-housed pigs on fully-slatted floor, artificial ventilation and underlying deep collection pit ( <b>reference</b> )		2.39 (DK) to 3.0 (I, NL, D) kg NH <sub>3</sub> /pig place/yr		21.1 (I) 20 to 30 (D)
4.6.1.1	FSF with vacuum system		25		same as reference or less
4.6.1.2	FSF with flush channels	no aeration	30		22.8 <sup>1)</sup>
		aeration	55		40.3 <sup>1)</sup>
4.6.1.3	FSF with flush gutters /tubes	no aeration	40		18.5 <sup>1)</sup>
		aeration	55		32.4 <sup>1)</sup>
4.6.1.4	PSF with reduced manure pit		20 to 33		same as reference
4.6.4.4	PSF with manure surface cooling fins	concrete slats	50		more than reference
		metal slats	60		more than reference
4.6.1.6	PSF with vacuum system	concrete slats	25		same as reference
		metal slats	35		same as reference
4.6.1.7	PSF with flush canals	no aeration	50		21.7 <sup>1)</sup>
		aeration	60		38.5 <sup>1)</sup>
4.6.4.1	PSF with flush gutters/tubes	no aeration	concrete slats	60	14.4 <sup>1)</sup>
			metal slats	65	14.4 <sup>1)</sup>
		aeration	70		30 <sup>1)</sup>
4.6.4.2	PSF channel with slanted side walls	concrete slats	60		same as reference
		metal slats	66		same as reference
4.6.4.3	PSF with slanted walls and vacuum system	concrete slats	60		same as reference
		metal slats	66		same as reference
4.6.1.9	PSF with scraper	concrete slats	40		more than reference
		metal slats	50		more than reference
4.6.4.5	PSF + external area/litter		30		12.6 <sup>1)</sup>
4.6.4.6	PSF triangular slats and box		36		far less than reference
4.6.4.7	SCF full litter/open front		- 33 <sup>2)</sup>		far less than reference
4.6.4.8	SCF + EA litter		20 to 30		2.43
1) only for manure removal (as ventilation is not applied)					
2) a negative reduction indicates an increase in emissions					

**Table 4.24: Performance levels of system-integrated housing techniques for new installations for growers/finishers**

#### 4.6.4.1 Partly-slatted floor with flushing gutters or flush tubes (PSF flush gutter)

**Description:** (see also Section 4.6.1.8): Small gutters limit the manure surface. This reduces the ammonia emission. Application is possible in pens with a convex floor. The convex floor separates the two channels. Application is also possible in pens with a partly-slatted floor consisting of a solid concrete floor on a slope in front of the pen. The manure will be removed frequently (once or twice a day) by a flushing system. The slats are made of concrete or of iron triangles. The manure channel has a width of at least 1.10 metre. The gutters should have a

slope of 60 degrees. The gutters are flushed with the fresh liquid fraction of the manure or with aerated slurry.

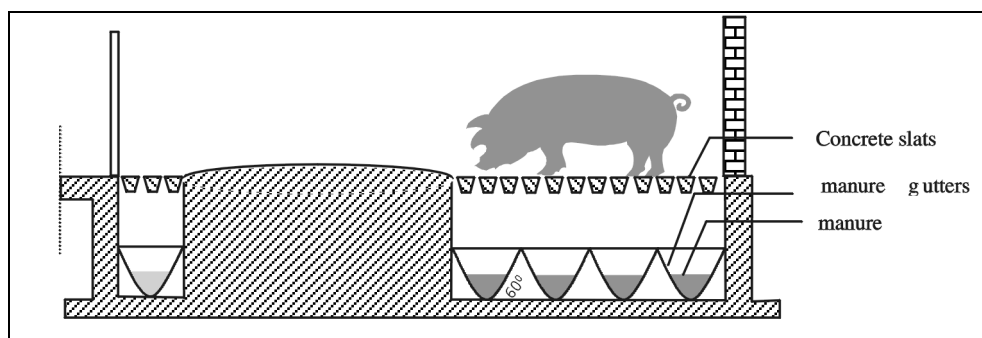

**Figure 4.47: Convex floor with concrete (or triangular iron) slats in combination with a gutter system**

[10, Netherlands, 1999]

**Achieved environmental benefits:** Limiting the manure surface in the manure channel, removing the manure twice a day by flushing and fast discharging of the manure on the slatted area if triangular iron bars are used achieves a reduction 60 – 65 %. Flushing with aerated slurry can achieve a reduction in ammonia emissions of 70 %.

Various figures reported are:

- 0.9 kg NH<sub>3</sub> per pig place per year (I) on concrete slats, flushing with aerated slurry
- 1.0 kg NH<sub>3</sub> per pig place per year (NL, B) on triangular iron slats, flushing with fresh slurry
- 1.2 kg NH<sub>3</sub> per pig place per year (NL, B, I) on concrete slats, flushing with fresh slurry.

**Cross-media effects:** Energy consumption levels are:

- 1 to 1.5 kWh per pig place per year for flushing
- 5.1 kWh per pig place per year for liquid separation
- 7.2 kWh per pig place per year for aeration.

Where artificial ventilation is not applied in this system, e.g. in Italy, the total energy used is less than with the fully-slatted floor with artificial ventilation.

Odour peaks due to flushing may cause a nuisance when receptors are living near the farm. The peaks are higher if flushing is done without aeration rather than if it is done with aeration. On a case by case basis it has to be decided whether an overall load (thus applying a no-flushing system) or peak values are more important. [184, TWG ILF, 2002]

**Operational data:** Application of this system needs an installation (tank) to separate the liquid fraction from the slurry before it can be used or further treated, in the case of aeration, and then pumped back for flushing.

**Applicability:** The system with flushing gutters can be applied in new houses. In existing houses the applicability depends on the design of the existing manure pit.

**Costs:** The implementation costs of the system with concrete slats are reported to be significant, but seem to vary. Dutch data report extra investment costs of EUR 59 per pig place. This means with a 60 % reduction costs are about EUR 32.77 per kg NH<sub>3</sub> abated. Extra annual operational costs per year are EUR 9.45 per pig place or EUR 5.25 per kg NH<sub>3</sub>. Italian data give negative costs (i.e. benefits) compared with the reference system amounting to EUR (-/-) 2.96 per kg NH<sub>3</sub> abated.

The implementation costs of the system with triangular iron slats are reported to be slightly higher than the systems with concrete slats, but give a relatively higher reduction percentage. The extra investment costs are EUR 79 per pig place. This means at 65 % reduction EUR 40 per kg NH<sub>3</sub>. The extra annual costs are EUR 12.50 per pig place or EUR 6.25 per kg NH<sub>3</sub> abated.

**Reference farms:** This system is applied in Italy and in the Netherlands (about 50000 rearing pig places). It has only recently been developed (early 1999) for finishers.

**Reference literature:** [10, Netherlands, 1999], [59, Italy, 1999] and [185, Italy, 2001].

#### 4.6.4.2 Partly-slatted floor with manure channel with slanted side wall(s)

**Description:** Side wall(s) on a slope reduce the manure surface. This reduces ammonia emissions. Application is possible in pens with a convex floor. The convex floor separates the two channels. The front channel is partly filled with water, as the pigs don't normally use the front area as a dunging area. Only spoiled feed concentrates come into the front channel. The main function of the water is mainly to prevent flies breeding. Application is also possible in pens with a partly-slatted concrete floor consisting of a solid concrete floor on a slope in front of the pen. The manure will be removed frequently by a sewerage system. The manure channel has a width of at least 1.10 metre. The manure surface in the manure channel should not be larger than 0.18 m<sup>2</sup> per pig place. The surface of the sloping wall(s) should be made of a smooth material to the manure adhering to the surface. A sloping wall at the back is not required, but when a sloping wall is present, then this wall should have a slope of between 60 and 90 degrees. The wall next to the solid concrete floor should have a slope of between 45 and 90 degrees. The slats are made of concrete.

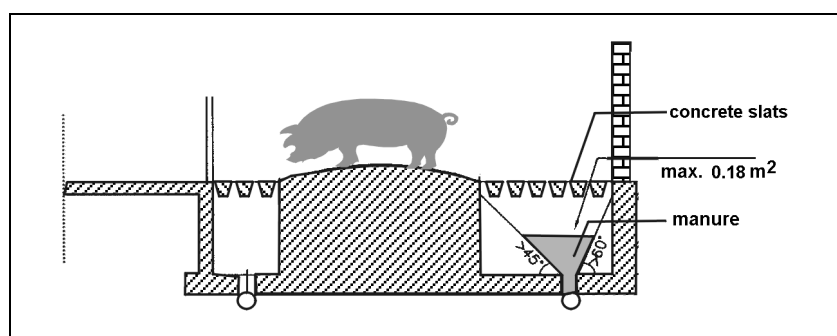

**Figure 4.48: Convex floor with concrete slats and side walls on a slope in the manure pit [10, Netherlands, 1999]**

**Achieved environmental benefits:** Limiting the manure surface in the manure channel and removing manure frequently by a sewerage system reduces the emission by 60 % (1.2 kg NH<sub>3</sub> per pig place per year) with concrete slats and by 66 % (1.0 kg NH<sub>3</sub> per pig place per year) in the case of triangular iron bar slats.

**Cross-media effects:** This system does not require any extra energy.

**Operational data:** Similar to the reference system.

**Applicability:** The system with slanted side wall(s) can be applied in new houses. In existing houses the applicability depends on the dimensions of the existing manure pit. To implement this system only a few alterations are needed and hardly any change in management technique or regime are needed. The manure surface should be a maximum of 0.18 m<sup>2</sup> per pig place.

**Costs:** The extra investment costs are EUR 3.00 per pig place. This means with a 60 % reduction (i.e. 3.0 to 1.2 kg NH<sub>3</sub>), costs are about EUR 1.65 per kg NH<sub>3</sub> abated. The extra operational costs per year are EUR 0.50 per pig place. This means EUR 0.28 per kg NH<sub>3</sub> abated. For the iron bars cost data are slightly different. The extra investment costs are EUR 23 per pig place. This means with 65 % reduction about EUR 12 per kg NH<sub>3</sub> abated. The extra annual operational costs are EUR 15 per pig place or EUR 2.70 per kg NH<sub>3</sub> abated.

**Reference farms:** The system with iron triangular bars was developed in the mid-nineties and has been implemented in many new buildings and alterations in the Netherlands.

**Reference literature:** [10, Netherlands, 1999].

### 4.6.4.3 Partly-slatted floor with a reduced manure pit, including slanted walls and a vacuum system

**Description:** See Section 4.6.4.2, where the system applying slanted walls is described and Section 4.6.1.1 where the vacuum system is described. Combining the positive effects of these two techniques results in the PSF with a reduced manure pit, including slanted walls and a vacuum system.

**Achieved environmental benefits:** Due to limiting the manure surface in the manure channel and removing manure frequently by a vacuum system, it is estimated that the emission could be reduced by at least 60 % with concrete slats and by 66 % in the case of triangular iron slats.

**Cross-media effects:** As the system is manually operated, no additional energy is required. It is suggested that the vacuum created when opening the valves removes aerosols developing during discharge of the slurry.

**Operational data:** Similar to the reference system.

**Applicability:** The system with slanted side wall(s) can be applied in new houses. In existing houses the applicability depends on the dimensions of the existing manure pit. To implement this system only a few alterations are needed and hardly any change in management technique or regime are needed. The manure surface should be a maximum of 0.18 m<sup>2</sup> per pig place.

**Costs:** The extra investment costs are EUR 3.00 per pig place. The extra operational costs per year are EUR 0.50 per pig place. The additional vacuum system might require some extra costs.

For the iron bars, cost data are slightly different. The extra annual investment costs are EUR 23 per pig place.

**Reference farms:** This combination of techniques has not been applied yet.

**Reference literature:** [185, Italy, 2001] [10, Netherlands, 1999] [184, TWG ILF, 2002]

### 4.6.4.4 Partly-slatted floor with manure surface cooling fins

**Description, cross-media effects and applicability:** See Section 4.6.1.5.

**Additional description:** The system is also applied with triangular iron slats instead of concrete slats [186, DK/NL, 2002].

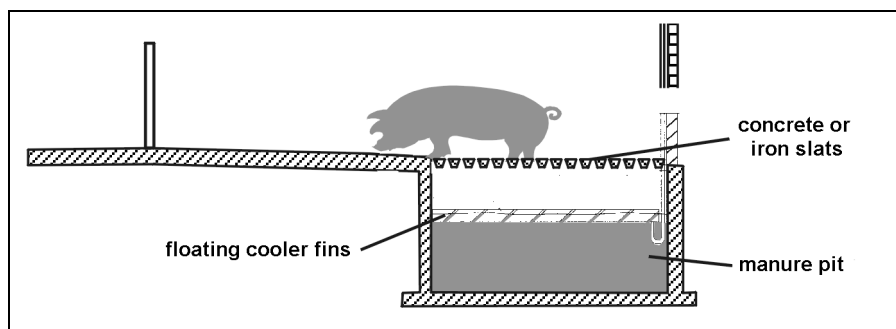

**Figure 4.49: Rearing pen, partly-slatted floor with concrete or triangular iron slats and manure surface cooling**  
[10, Netherlands, 1999]

**Achieved environmental benefits:** Cold water flowing through fins on top of the manure cool the manure surface to reduce the ammonia evaporation by similar percentages as the previous system, 50 – 60 % depending on the material and the type of slats applied (1.2 – 1.5 kg NH<sub>3</sub> per pig place per year).

**Costs:**

**Concrete slats:** The extra investment costs are EUR 30.40 per pig place. This means with a 50 % reduction (i.e. 3.0 to 1.5 kg NH<sub>3</sub>), costs are EUR 20 per kg NH<sub>3</sub> abated. The extra annual operational costs are EUR 5.50 per pig place. This means EUR 3.65 per kg NH<sub>3</sub> abated.

**Triangular iron slats:** For triangular iron slats, the extra investment costs were calculated to be EUR 43 per pig place. This means with a 60 % reduction, costs are EUR 24 per kg NH<sub>3</sub> abated. The extra annual operational costs are EUR 8 per pig place or EUR 4.50 per kg NH<sub>3</sub> abated.

**Reference farms:** In the Netherlands, about 20000 rearing pig places are equipped with this system. This system has been developed just recently (early 1999). It is now being implemented in some reconstruction situations and in some new buildings.

**Reference literature:** [10, Netherlands, 1999] [186, DK/NL, 2002]

#### 4.6.4.5 Partly-slatted floor with fast removal of slurry and littered external alley (PSF + EA litter)

**Description:** In addition to a partly-slatted floor an external littered alley is applied, see Figure 4.50. The inside manure pit allows pigs to dung, if they are not able to go out to reach the external alley already occupied by their dominant fellows. The manure collected in the pit underneath the slats is removed with some of the removal systems as described before.

**Achieved environmental benefits:** Emissions are reduced to 2.1 kg NH<sub>3</sub> per pig place per year, which is about 30 % of the figure for the fully-slatted floor.

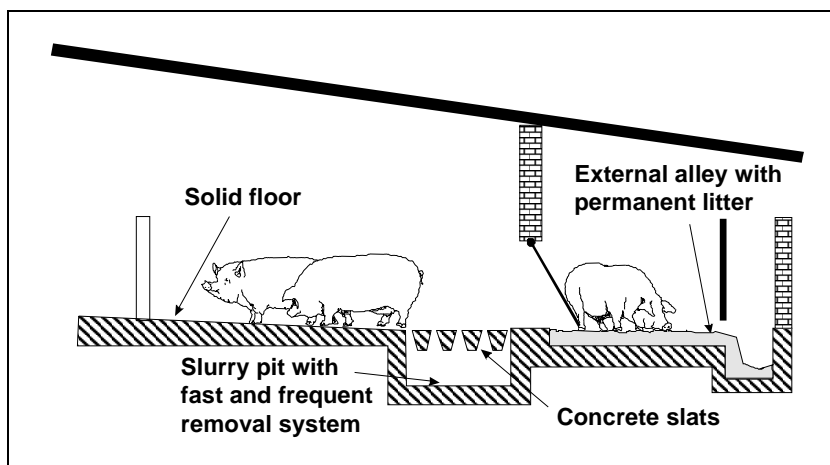

**Figure 4.50: Partly-slatted floor with fast removal of slurry and littered external alley** [185, Italy, 2001]

**Cross-media effects:** Energy is necessary for slurry removal from the pit underneath the slatted floor and for removal of the solid manure from the external alley pit. The energy consumption for manure removal has been estimated to be 12.6 kWh per pig place per year. The overall energy consumption is less than the reference because no artificial ventilation is applied [184, TWG ILF, 2002].

The use of litter in all the functional areas is not considered as common practice for the Italian heavy pigs, normally fed with liquid feed, because the litter becomes too moist in a very short time. Using litter only in the external alley avoids this negative effect and at the same time maintains the solid manure production. The solid manure is applied to land as a fertiliser where it has a positive effect on soil structure.

Odour might be a problem if not enough straw is used [184, TWG ILF, 2002].

**Costs:** For new buildings, the investment costs are estimated to be equal to the reference system. The annual operational costs are estimated to be somewhat higher than the reference system. In retrofit situations the costs are expected to be much higher than the reference. [184, TWG ILF, 2002].

**Reference literature:** [59, Italy, 1999] [185, Italy, 2001]

#### 4.6.4.6 Partly-slatted floor with covered box: the kennel housing system

**Description, applicability, operational data, costs:** see Section 4.6.3.11.

**Additional description:** The system differs from the system applied to weaners only in the emitting surface of the (metal triangular) slats, which for finishers is a maximum of 0.14 m<sup>2</sup> for pigs up to 50 kg, and 0.29 m<sup>2</sup> for pigs weighing over 50 kg. This system has a low energy input due to the low room temperature.

**Achieved environmental benefits:** Ammonia emissions are reduced by 36 % compared to the reference, leaving an ammonia emission of 1.9 kg NH<sub>3</sub> per pig place per year.

**Reference literature:** [187, IMAG-DLO, 2001]

#### 4.6.4.7 Solid concrete floor with litter and outdoor climate

**Description:** Pigs are kept in one large pen or two smaller ones with a central alley in between for feeding and control. The house has an open front and is fully naturally ventilated. Straw is supplied in abundance for the pigs and offers protection against low temperatures. Manure (mixed with straw) is removed as dry manure by front-end loaders after each growing cycle.

**Achieved environmental benefits:** Emissions of ammonia are either similar to or higher than the reference system (fully slatted) by 33 % (3 – 4 kg NH<sub>3</sub> per pig place per year).

**Cross-media effects:** There is no energy requirement for ventilation. Odour levels are low in the direct vicinity of the housing facility, if enough straw is applied. It produces a straw mixed manure, which may provide a well-structured manure.

The system can cause large heaps in dunging areas that are not favourable for either indoor climatic conditions or outdoor emissions.

**Operational data:** This system clearly needs extra labour, but bedding and removal of manure can be efficiently mechanised. The amounts of straw applied are approximately 1.2 kg per pig per day. The system is spacious but needs clear concrete areas in summer at feeding places for the pigs to cool down. In regions with hot climates full litter is normally not applied.

**Costs:** Compared with the reference, the additional operational costs are about EUR 8 per pig place per year, but this depends on the price of litter. The capital investment for the housing is much less than the reference system.

**Reference place:** Applied in some farms in e.g. UK and Germany. Not widely applied yet, but might get more attention because of animal welfare considerations.

**Reference literature:** fact sheets (Model 6) in [124, Germany, 2001]

#### 4.6.4.8 Solid concrete floor with littered external alley (SCF + EA litter)

**Description:** See Figure 2.28. A small door allows the pigs to go out to dung in an external alley with a concrete floor that is covered with straw (0.3 kg straw per pig per day) and that has a slight slope (4 %) that ends in a manure alley with a scraper. By moving around in the external alley the animals push the straw with the manure into the lateral channel. All the manure falls into the channel and is scraped one step down, and once a day it is scraped on to a manure belt. The lateral channel is fenced off, allowing space for the sludge to pass.

A scraper removes the sludge (3 – 7 kg solid per pig per day) to a solid manure heap. The sludge is moved along a channel that has a perforated area just before where the sludge is dragged upwards towards the manure heap and this allows most of the fluid to be drained. The manure heap itself is also drained and underneath the storage the liquid is collected in a suitable basin (approximately 0.5 – 2 litres of liquid per pig per day)

**Achieved environmental benefits:** A reduction in ammonia emissions of 20 to 30 % is achieved compared to the fully-slatted system.

**Cross-media effects:** The energy use of the system is about 6 kWh, operating 0.5 hour per day in a housing unit for 450 pigs.

The use of litter on the solid floor inside the house is not recommended for the Italian heavy pigs because they are normally fed with liquid feed, and the litter becomes too moist in a very short time. Using litter only in the external alley avoids this negative effect and at the same time

maintains the solid manure production. The solid manure is applied to land as fertiliser where it has a positive effect on soil structure.

Odour might be a problem if not enough straw is used [184, TWG ILF, 2002].

**Operational data:** Ventilation is natural and operated manually. Automatic (phase) feeding and watering is applied. Heating is not required.

**Costs:** Investment costs for new housings are estimated to be equal to the reference system. Operating costs range from an extra cost of EUR 6.00 per pig per year to a benefit of EUR 1.09 per pig per year compared to the reference. [184, TWG ILF, 2002]

**Reference literature:** [185, Italy, 2001]

#### 4.6.5 End-of-pipe measures for reduction of air emissions from housing of pigs

##### 4.6.5.1 Bioscrubber

**Description:** In this systems all the ventilation air of the pen is fed through a biofilter unit. A biolayer formed on the surfaces of the packed material absorbs ammonia that in turn is reduced by microbes. Water circulation keeps the biolayer moist and the nutrients available for the micro-organisms.

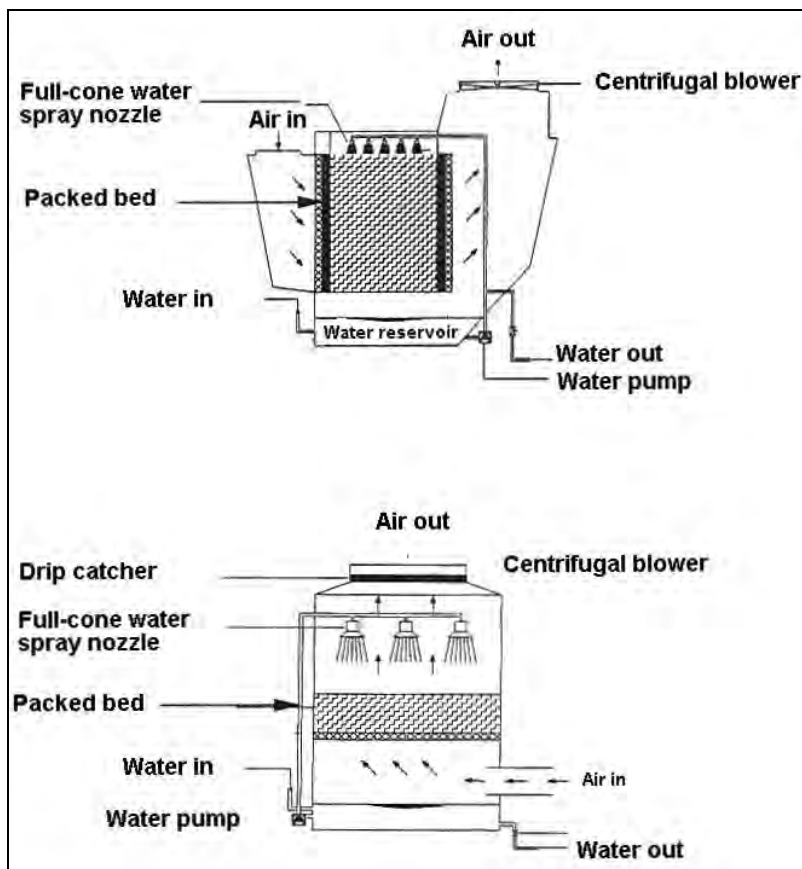

Figure 4.51: Two bioscrubber designs [10, Netherlands, 1999]



**Achieved environmental benefits and costs:** Summarised in Table 4.25.

**Cross-media effects:** The water consumption is increased by about 1 m<sup>3</sup> per pig place per year and in accordance with this an extra effluent is produced that has to be discharged. The requirement to discharge may limit the application of this system. This system has a higher energy consumption (extra 35 kWh per pig place). For weaners, the extra energy input was reported to be lower, i.e. at about 8 kWh per pig place.

Systems for waste air cleaning can significantly increase the flow resistance of forced ventilation systems. In order to ensure the requisite air rates, particularly in the summer, higher-capacity fans with a higher specific power requirement may be necessary. In addition, power is required to operate the pumps for water circulation in bioscrubbers and for humidifying operations in biofilters.

Performance bioscrubber	Pig categories			
	Mating/gest. sows	Farrowing sows	Weaners	Finishers
Reduction percentage (%)	70 (50 – 90)	70 (50 – 90)	70 (50 – 90)	70 (50 – 90)
Extra investment costs (EUR/place)	111.35	111.35	10	49
Extra investment costs (EUR/kg NH <sub>3</sub> )	38.4	19.2	23.8	22.25
Extra annual operation costs (EUR/place)	16.7	32.75	3.35	16.7
Extra annual abatement costs (EUR/kg NH <sub>3</sub> )	5.50	5.61	5.58	8.9
References (places)	1000	no data	no data	100000 (NL)

*Note: costs are calculated with 70 % abatement efficiency*

**Table 4.25: Summary of the reductions in ammonia emissions and of the costs of a bioscrubber for different pig categories**

**Applicability:** This system is very easy to implement in addition to new buildings and to reconstructions of existing buildings already applying artificial ventilation under a negative air pressure. The design and the size of the pen are not critical for the applicability of the system. There are no adaptations needed inside the building, but this system cannot be applied in naturally ventilated pig houses, without channelling the airflow in the building, and typically applies to housing with forced ventilation (under a negative air pressure). A dust filter may be necessary where dust levels are higher (straw systems), which will increase pressure in the system and also raise energy use.

**Reference farms:** This system was developed just a few years ago in the Netherlands. It is now being implemented in some reconstruction situations.

**Reference literature:** [10, Netherlands, 1999]

#### 4.6.5.2 Chemical wet scrubber

**Description:** All the ventilation air of the pen is fed through a chemical scrubbing unit. An acid scrubbing liquid is pumped around this unit. When the ventilated air is brought into contact with the scrubbing liquid, ammonia is absorbed and the clean air leaves the system. Diluted sulphuric acid is mostly used in this system. Hydrochloric acid may also be used.

**Working principle:** Ammonium absorption:  $2 \text{NH}_3 + \text{H}_2\text{SO}_4 \rightarrow 2 \text{NH}_4^+ + \text{SO}_4^{2-}$ . (For picture see Figure 4.15)

**Achieved environmental benefits and costs:** See Table 4.26.

**Cross-media effects:** The effluent from the scrubber contains increased levels of sulphate or chloride, depending on the type of acid used. The effluent must be discharged and this may limit application. This system has a higher energy consumption compared with the previous air cleaning system. Again, levels vary with the pig category.

Performance chemical wet scrubber	Pig categories			
	Mating/gest. sows	Farrowing sows	Weaners	Finishers
Maximum reduction percentage (%)	90	90	90	90
Extra investment costs (EUR/place)	62.75	83.65	9	43
Extra investment costs (EUR/kg NH <sub>3</sub> )	16.5	11.15	16.65	15.95
Extra annual operation costs (EUR/place)	25.05	28	3	14
Extra annual abatement costs (EUR/kg NH <sub>3</sub> )	6.96	3.89	5.56	5.19
Extra energy (kWh/ pig place)	52.5	100	10	55
References (places)	2000	no data	no data	100000 (NL)

*Note: costs are calculated with 90 % abatement efficiency*

**Table 4.26: Summary of the reduction of ammonia emissions and of the costs of a chemical wet scrubber for different pig categories**

**Applicability:** This system is very easy to implement in addition to new buildings and in the reconstruction of existing buildings already applying artificial ventilation under a negative air pressure. The design and the size of the pen are not critical for the applicability of the system. There are no adaptations needed inside the building, but this system cannot be applied in naturally ventilated pig houses without first channelling the airflow in the building. It typically applies to housing with forced ventilation (under a negative air pressure).

**Reference farms:** This system was developed just a few years ago. It is now being implemented in some reconstruction situations.

**Reference literature:** [10, Netherlands, 1999]

## 4.7 Techniques for the reduction of odour

Data suggest that low-protein diets reduce emissions of both ammonia and odorous compounds. Odour can be reduced in a number of other ways also, including:

- by good housekeeping
- by storing the manure outside under a cover
- by avoiding an air stream passing over the manure.

For reasons of odour, application times and techniques have been developed for landspreading. Some additional techniques to reduce odour in the vicinity of the farm are applied on-farm to animal housing with forced ventilation. However, applicability, cross-media effects and costs might limit the adoption of the following techniques:

- scrubber, see bioscrubber and chemical wet scrubber in Sections 4.6.5.1 and 4.6.5.2
- biodegradation – by leading the air from the housing through a biofilter of fibrous plant material, odorous elements are broken down by bacteria. The effectiveness depends on moisture content, composition, airflow per square metre of filter bed, and filter height. In particular, dust can be a problem, creating high air resistances
- horizontal air outlet channel – this does not mean a reduction of odour, but diverting the emission point of air from the housing to a different side of the farm, so as to reduce the potential impact for odour-sensitive objects (residential areas)
- dilution of the concentration, which is explained below and is based on proper design of the housing and dimensioning of the ventilation.

**Dilution of odorants:** The odorant concentration at a sensitive site depends, essentially, on the degree of dilution of the odorants emitted during atmospheric transport in the air-stream. Important factors affecting pollutant concentration are:

- the odorant flow rate
- the distance from the source
- the effective source height.

In addition, atmospheric dilution increases with the degree of turbulence in the atmosphere and the air-stream. Mechanical turbulences can be achieved through the effective placement of flow barriers (e.g. vegetation).

**Discharge conditions:** The principles of natural ventilation and forced ventilation result in different waste air discharge conditions. While the exit apertures for the housing air are limited to a narrow cross-section in the case of force-ventilated housings, with naturally ventilated housings they are occasionally quite large. In those housings, the cross-sections through which air enters and exits are adjustable in accordance with the meteorological and local climatic conditions outside the housing, and with the livestock-specific ventilation requirements inside the housing. Common to both systems are thermal upcurrents in the housing caused by the heat output of the livestock and the possible presence of heating equipment.

Essentially, an unimpeded incoming and outgoing flow of outside air must be ensured in the immediate vicinity of the housings (approx. 3 to 5 times building height). With forced ventilation, the use of the area in the immediate vicinity of the housing determines the discharge conditions to be selected, e.g. side wall ventilation leading into the yard, or high discharge stacks above the ridge. In the case of naturally ventilated housings, a local odour may be regarded as acceptable, where the emphasis is predominantly on the effect of the housing emissions further afield.

**Forced ventilation:** As a rule, with force-ventilated housings the focus in terms of impact reduction is on achieving sufficient dilution of the waste air with the wind. In order to protect the local neighbourhood, it may be advisable to ensure that the emission air streams pass at a certain minimum height over this area. In order to discharge over and beyond local dwellings, the waste air must be transferred into an undisturbed external air stream by raising the source height so that entrainment of the waste air plume in the wake zone of the building (downwash effect) can be kept to a minimum. This effect can be achieved by increasing the waste air exit velocity and/or raising the height of the waste air discharge stack.

The waste air should be discharged through sufficiently high stacks vertically upwards over the roof ridge and into the atmosphere without any flow-inhibiting hoods or covers. To this end, the local area and the site location should be examined to determine whether, for example, the waste air discharge stack could be raised to a higher level at the gable of e.g. a barn building where this barn towers over the livestock building.

The waste air plume can be given a further upward boost by imparting to it greater mechanical momentum by increasing the waste air discharge velocity. The waste air velocity can, for

example, be increased throughout the year e.g. by gang-switching multiple series of fans in a central waste airshaft.

The installation of an additional bypass fan is effective as an impact-reducing measure only in certain cases and for the local area, and tends usually to have no effect. Apart from the increase in investment outlay and energy consumption, the additional noise emissions also have to be taken into account.

When planning a waste air discharge system, it is important to consider the influences of livestock buildings and flow barriers in the immediate environment on both the windward and lee sides of the facility (e.g. the roof ridge of neighbouring buildings, and trees). Livestock buildings and flow barriers give rise to a plume downwash effect.

In the case of a single livestock building, the downwash effect depends on the relationship between the effective source height and the building height. The downwash effect describes the influence of the building on the waste air plume and the subsequent reduction in the effective source height. Undisturbed airflow is attained at a height which corresponds to twice the building height.

Side wall ventilation apertures may be regarded as desirable in individual cases if they are provided with a deflector cover which directs the waste air towards the ground, and if the air is dispersed at the housing side which faces away from the sensitive site requiring protection. When comparing the effects caused by side wall ventilation on the one hand and waste air discharge via the ridge on the other, the ambient air pollution encountered in locations further afield tends to be similar.

In the case of facilities with several livestock buildings, the position and height of the waste air sources play a subordinate role in relation to their impact in terms of ambient air pollution at remote locations. In such cases, the total area of the facility may be so large that the waste air plumes descend to ground level within the facility site, even if the original source heights are large. The overall facility is then considered to have the same effect as a single ground-level surface source.

**Natural ventilation:** In order to ensure sufficient functional efficiency with natural ventilation, certain requirements have to be met, for example the following:

- roof pitch angle of at least 20° for eaves-ridge ventilation in order to generate the necessary thermal upcurrent
- mean height difference of at least 3 m between the inlet air apertures and the waste air apertures with shaft ventilation
- dimensioning of the air inlet and waste air apertures to be in accordance with livestock occupancy and thermal upcurrent lift height
- guaranteed disturbance-free flows of incoming fresh air and outgoing waste air into and from the housing
- ridge axis aligned transverse to the prevailing wind direction.

If buildings are located upstream and/or downstream of an open housing system, it must be ensured that the livestock building is not located in zones with very low or significantly accelerated air movement. The distance from the housing to the neighbouring buildings should be at least 3 to 5 times the height of the neighbouring buildings.

In the case of pig and poultry housings, the installation of devices for changing the air inlet and waste-air aperture cross-sections has proven to be successful.

By aligning the livestock building in relation to the prevailing wind direction, a decisive influence can be exerted on both the internal environmental conditions of the housing and the emissions emanating from it. Different concentration and velocity fields occur, depending on

whether the housing is subjected to transverse, diagonal or ridge-parallel through-flow. With ridge-parallel flow patterns in particular, the degree of ventilation compared with cross-flow patterns is reduced by approx. 50 %. It is under these conditions that the highest odorant and ammonia concentrations arise in the housing.

In order to combat this effect, apertures in the gable wall can enhance the wind-induced volume flow. Apertures at the centre of the ridge additionally assist thermal upcurrent flow. With a slot aperture running along the entire ridge, higher throughput rates are achieved than with shafts. The ridge axis of the housing should therefore be aligned to the wind so that in the course of the year the prevailing direction of wind flow produces the best possible through-ventilation effect. The air inlet and waste air apertures of housings with eaves-ridge ventilation have to be dimensioned so that in times of high outdoor temperatures there is still sufficient air circulation. Otherwise, doors must be opened, which generally results in the emissions dispersing at ground level and in an uncontrolled fashion.

According to the current state-of-the-art, housing systems of open design with large lateral cross-sections, ridge slots and gable-end apertures, located in a free-standing position, can be regarded as desirable in terms of the impact effects encountered further afield (e.g. box stalls with separate function areas).

## **4.8 Techniques for the reduction of emissions from storage**

The Nitrates Directive (91/676/EEC) lays down minimum provisions on storage in general with the aim of providing all waters with a general level of protection against pollution, and additional provisions on storage in designated Nitrates Vulnerable Zones. Some of the techniques are described in the sections below, but others mentioned in this Nitrates Directive are not addressed because of a lack of data.

### **4.8.1 Reduction of emissions from storage of solid manure**

#### **4.8.1.1 General practice**

The storage of solid manure on a solid impermeable floor will prevent leakage to soil and groundwater. Equipping the storage with drains and connecting these with a pit allows collection of the liquid fraction and of any run-off caused by rainfall. It is common practice for farmers to have storage facilities for solid manure, to hold sufficient capacity until further treatment or application is carried out, see also Section 2.5. The capacity depends on the climate, which determines the periods in which the application to land is not possible or not allowed.

To reduce odour, the location of the storage on the farm is important and should take into account the general wind direction. The preferred position of the storage is away from sensitive objects in the vicinity of the farm, also taking advantage of natural barriers such as trees or height differences. Also, walls (wood, bricks or concrete) can be erected to surround storage heaps. These can serve as windscreens, with the opening of the storage on the lee-side of the prevailing wind direction.

Dry poultry droppings must be stored dry in a covered area. In enclosed sheds, condensation can be avoided by proper ventilation. Re-moistening of the droppings should be prevented as this will lead to a release of odorants. Droppings storage sheds should not be built so high as to allow pyrolysis to occur in the stored droppings.

Temporary stacks in the field should be located sufficient distances from watercourses. In Finland, for example, the stack must be at least 100 metres away from watercourses, main ditches or household wells and 5 metres from (small) ditches [125, Finland, 2001]. In the UK,

the applied distances are 10 metres from watercourses and 50 metres from springs, wells, boreholes or other sources intended for human consumption [190, BEIC, 2001].

For field stacks that are made in the same place every year, impermeable floors could also be applied. Where clay soils prevail and stacks change location, no accumulation of harmful amounts of nutrients is expected and special measures do not need to be applied to the bottom of the stack. To prevent water entering the manure heap, the accumulation of rainwater at the base of the stack needs to be avoided.

The covering of manure heaps is also applied to reduce run-off and evaporation of ammonia (and odour).

### 4.8.1.2 Application of a covering to solid manure stacks

**Description:** This technique mainly applies to broiler manure and dried layer droppings. Covering materials are applied to solid manure heaps and stacks in the field. These can be peat, sawdust, wood chips or a tight UV-stabilised plastic cover. The purpose of the cover is to reduce evaporation of ammonia and to prevent run-off of rainwater.

The principle behind the application of peat was reported by [125, Finland, 2001]: The use of peat (as a 10 cm layer) is based on its ability to bind cations. Ammonia is absorbed into the peat in a chemical reaction in which the  $\text{NH}_3$ -molecule is transformed into a fixed  $\text{NH}_4$ -ion. The higher the acidity of the peat, the more ammonia it can absorb.

If a cover is to be applied, stacks must be covered immediately after they are made, since most of the ammonia evaporates during the first few days.

**Cross-media effects:** Dry peat and sawdust absorb rainwater. However, straw is not a good covering material because it does not absorb ammonia and also it prevents a natural crust from forming on the surface of the manure. A crust prevents the evaporation of ammonia from the fresh surface of the manure under it better than a covering of straw does. However, peat is a non-renewable resource, which might be grounds for not using peat for the coverage of manure heaps [190, BEIC, 2001]

It is clear that tight covers can be re-used if properly applied, whereas other covering materials will need to be purchased for each new stack. These other covering materials, such as peat, will be incorporated and then treated (applied) as part of the manure. Peat will not create a hazard for grazing animals.

It is not clear whether a plastic cover causes (anaerobic) reactions in the stack that may lead to a reduction in the quality of the manure or that may affect emissions during application.

**Operational data:** The information was obtained under normal farming and climatic conditions. The use of covering materials such as, wood chips or sawdust might be less effective in dry and windy weather [192, Germany, 2001]

**Applicability:** In many areas, it is common practice, for practical reasons, to create temporary manure heaps in the field. Applying the covers is relatively easy as no complex equipment or machinery is involved. The peat littered manure of broilers is very suitable for depositing in stacks on the field, because liquid does not seep from it and nearly all rainwater is absorbed in the stack. Peat used as litter absorbs ammonia effectively.

**Costs:** Costs are thought to be very low. Costs consist of purchasing the covering material and applying it on the heap (labour, energy).

**Reference farms in EU:** Applied in trials.

**Reference literature:** [125, Finland, 2001]

#### 4.8.1.3 Storage of poultry manure in a barn

**Description:** Solid poultry manure is normally stored in a barn. It is removed from the animal housing by front-end loaders or by means of a belt and transported to the shed, where it can be stored for a longer period of time. The barn is usually a simple straightforward closed construction with an impermeable floor and a roof. It is equipped with ventilation openings and an access door for transport.

**Environmental benefits:** Drying poultry manure in the housing reduces the emissions to air of gaseous compounds (ammonia) from the housing. To keep emission of gaseous compounds low the relatively high dry matter percentage of solid manure has to be maintained. This is helped by keeping solid poultry manure protected against outdoor influences such as rain and sunlight.

**Cross-media effects:** Odour levels may be kept low, but aerobic and anaerobic conditions can affect this. It is important to have sufficient ventilation to avoid anaerobic conditions.

If a new barn is planned it is a potential source of odour, so thought should be given to its location with respect to sensitive objects in the vicinity of the farm.

**Operational data:** The manure is protected against the outdoor climate by the barn construction.

**Applicability:** If sufficient space on the farmyard is available there are no limits to the construction of a new barn for the storage of solid manure. Existing barns may be used, but attention must be paid to the impermeability of the floor.

**Costs:** Costs consist of the costs for the construction and maintenance of a barn. For an existing barn, renovation of the flooring may be needed.

**Reference farms in EU:** The storage of poultry droppings in barns is applied in nearly all Member States.

**Reference literature:** [26, LNV, 1994], [125, Finland, 2001]

### 4.8.2 Reduction of emissions from storage of slurry

#### 4.8.2.1 General aspects

It is common practice for farmers to have storage facilities for pig slurry, to have sufficient capacity until further treatment or application is carried out, see also Section 2.5. The capacity depends on the climate, which determines the periods in which the application to land is not possible or not allowed. For example, the capacity can differ from the manure that is produced on a farm over a 4 to 5 month period in a mediterranean climate, to that produced over a 7 to 8 month period in atlantic or continental conditions, and again to that produced over a 9 to 12 month period in boreal areas. [191, EC, 1999]

Slurry stores can be constructed in such a way that the risk of leakage of the liquid fraction can be minimised, see also Section 2.5.4.1. They are built using the appropriate concrete mixtures, and applying a lining to a concrete tank wall or by applying an impermeable layer to steel sheets. After emptying a slurry store, inspection and maintenance will prevent a further risk of leakage.

The application of double valves in pipes used for emptying the tank will minimise the risk of an unwanted discharge of slurry onto the farmyard and surrounding premises (surface water).

Air emissions during the storage period can be reduced via:

- having a smaller container diameter and/or a reduced wind contact area at the liquid manure interface
- operating a lower level of fill (works due to the wind shielding effect created by the freeboard).

The discharge of liquid manure in open storage containers should be performed as close to the base of such containers as possible (infilling below the liquid surface level).

Homogenisation and the circulation pumping of liquid manure should preferably be performed when the wind is blowing away from any sensitive sites requiring protection.

To reduce air emissions from slurry storage it is important to reduce the evaporation from the slurry surface. A low evaporation rate can be maintained if the stirring of slurry is kept to a minimum and is done only before emptying the slurry tank for the homogenisation of the suspended matter.

Various types of covers are applied to reduce the emissions of ammonia and odorous components from slurry storage, see Sections 4.8.2.2, 4.8.2.3 and 4.8.2.4. Care must be taken to prevent the temperature of the slurry rising to a point at which biochemical reactions can occur, otherwise these may result in an unwanted odorant production and a degradation of the quality of the slurry.

Generally, the covering of slurry stores is effective, but may pose problems in application, operation and safety. Surveys have been conducted to assess these problems, but they only concluded that more data was needed. Quantified data on environmental aspects (emissions, nutrient content) and on costs are also scarce and do not easily allow an evaluation of the alternatives.

### 4.8.2.2 Application of a rigid cover to slurry stores

**Description:** Rigid covers are tight concrete covers or fibreglass panels with a flatdeck or conical shape. They fully cover the slurry surface, preventing rain and snow from entering. Covering small slurry stores is in general more straightforward than covering larger ones. If the cover is made of a lighter material then the span can be larger than for concrete covers exceeding 25 m and with a central support.

**Environmental benefits:** The covering of store surfaces is well documented and is known to significantly reduce ammonia emissions. Purpose-built (rigid) covers give a 70 to 90 % reduction [142, ADAS, 2000]. A dilution of the manure can occur in uncovered manure pits due to rain lowering the solid matter and the nutrients contents.

**Cross-media effects:** Development of toxic gases may occur. They may not have an immediate environmental relevance, but must be considered for safety reasons.

**Applicability:** Rigid covers are usually installed at the same time as the store. Retrofitting a cover to an existing store is reported to be expensive. The minimum lifetime of these covers is 20 years.

**Costs:** Cost indications were reported in a survey carried out by the UK [142, ADAS, 2000]: for concrete stores with diameters of 15 – 30 m the cost range is EUR 150 – 225 /m<sup>2</sup> (1999). For



rigid covers made of glass fibre-reinforced plastic (GRP) costs range between EUR 145 and 185 per m<sup>2</sup>. This cost is generally considered to be too high.

**Reference literature:** [125, Finland, 2001], [142, ADAS, 2000]

#### 4.8.2.3 Application of a flexible cover to slurry stores

**Description:** Flexible covers or tent covers have a central supporting pole with spokes radiating from the top. A fabric membrane is spread over the spokes and is tied to a rim-bracing. This is a circular pipe that is located on the outside around the circumference just below the top of the store. The cover is tightened over the store by evenly spaced vertical straps between the rim-bracing and the tent-rim

The pole and spokes are designed to withstand wind and snow loads. Vents are applied to release any gases that build up under the cover. The cover also incorporates an opening for an inlet pipe and a hatch that can be opened for inspecting the store's contents.

**Environmental benefits:** Reductions of ammonia emissions of 80 – 90 % have been reported.

**Cross-media effects:** Development of toxic gases may occur. They may not have environmental relevance, but must be considered for safety reasons. The development of H<sub>2</sub>S may cause some corrosion that can affect the construction. Recovery and utilisation of methane from the biogas may be a possibility but at an extra cost.

**Applicability:** From a UK survey it appeared that tent type covers can be applied to 50 – 70 % of the existing steel type stores with only modest modifications needed. Typically this consists of fitting an additional stiffening angle strip around the rim of the store. Tent covers can be fitted to existing concrete stores without modifications for diameters under 30 m, but a technical survey is recommended beforehand. It is important to calculate the required strength of the construction to ensure it can withstand wind and snow loads, for both the store and the store with cover. The larger the diameter of the store the more difficult the application of the cover will be, as the cover must be evenly taut in all directions to avoid uneven loads.

A tent cover cannot be applied to square or rectangular existing concrete stores, which are common in many EU countries [193, Italy, 2001]

**Costs:** The costs for tent covers for stores with diameters of 15 – 30 m have been reported to be about EUR 54 – 180 per m<sup>2</sup> (1999).

**Reference farms:** Applications have been reported in the UK.

**Reference literature:** [142, ADAS, 2000]

#### 4.8.2.4 Application of a floating cover to slurry stores

**Description:** Floating covers have the primary objective of reducing odour. There are different types of floating covers, such as:

- light gravel
- straw (crust)
- peat
- rapeseed oil
- plastic pellets
- blankets and foil.

Straw is a floating cover that is not suitable for very thin pig slurry as it may sink immediately or if it floats it will be easily affected by wind and rain. It may also lead to blocked pumps and drains. However, when the pig slurry has a dry matter content of 5 % or higher, it is then possible to obtain a straw-induced crust that performs well [142, ADAS, 2000] [193, Italy, 2001].

Canvas or plastic floating covers rest directly on the slurry surface. They are equipped with an inspection hatch, ventilation openings, and openings for filling and mixing the slurry. Also, a pump is used to drain any rainwater collected on top of the cover. The canvas can be fixed, or kept in place by counterweights hanging over the rim of the store.

Peat and light expanded clay aggregate (LECA) covers have been more extensively researched and, from literature, appear to be easily applied. These covers cannot be re-used and have to be replenished every year.

**Environmental benefits:** Although the covering of the slurry storage is carried out for odour reduction, actual measurements of the odour emissions or reductions are inherently unreliable due to a lack of unambiguous and dependable methods for measuring odour and for interpreting results. However it is clear that there is an effect on evaporation of ammonia. In combination with the effect of reducing ammonia emissions, an inventory reported in [125, Finland, 2001] showed considerable effects from floating covers. The reduction achieved though varies with the cover type applied and is generally higher in summer than in winter, see Table 4.27.

Canvas, floating foil, peat and rapeseed oil show high reductions of about 90 % or more; other techniques show lower reductions or their reducing effect is variable (gravel or LECA). Smaller particles reduce less, although no significant difference between gravel of 5 cm and 10 cm was reported. Also, the results with 10 cm gravel were not consistent.

The maximum emission reduction of LECA is about 80 %, but it does not increase above a layer thickness of 5 mm. In practice, rain will reduce a LECA layer and increase emissions, but a higher thickness could compensate for this loss.

A crust created by floating straw can achieve a reduction in ammonia emissions of between 60 – 70 %. [142, ADAS, 2000], with reference to Bode, M de, 1991.

**Cross-media effects:** The primary objective is odour reduction, but ammonia evaporation is reduced at the same time. Obviously, some floating covers that mix with or are dissolved in the slurry may affect the quality of the slurry or be harmful to grazing animals.

Other effects due to a reaction between the floating cover and the slurry may increase emissions of methane (rape oil by about 60 %). In the case of rapeseed oil, anaerobic reactions may produce surfaces with a strong, rancid odour.

A development of gases under closed (plastic) covers is common, hence the necessity for vents. The gases may be used in a biogas installation, but the efficiency and economics of this depend largely on factors such as daily gas production, distance to biogas installation and use.

LECA reportedly reduced methane emissions in one experiment, but, at the same time, higher emissions of nitrous oxide from LECA covered slurry were also reported.

**Operational data:** In general the covering is 10 cm thick. In the case of LECA, peat and plastic pellets, smaller layers have been applied as well. Smaller particles are generally more effective than larger particles. They can be relatively effective with a 3 – 5 cm layer, whereas layer particles need 10 – 20 cm. The layer immediately above the surface is the most relevant for emission reductions.

Type of cover	Reduction in ammonia evaporation from pig slurry (%)			
	Average	Spring/Summer	Autumn	Winter
Canvas	90	94	n.d.	84
Corrugated sheet	n.d.	84	n.d.	54
Floating foil	n.d.	85 – 94	n.d.	73
Floating board	79	85	n.d.	89
Peat (8 – 9 cm)	92	85	n.d.	n.d.
LECA 9 – 10 cm	75 – 79	47 – 98	41	n.d.
LECA 5 cm	79 – 82	n.d.	34	n.d.
LECA 2 cm	72	n.d.	17	n.d.
Rape seed oil	92	n.d.	n.d.	n.d.
Chopped straw	71	43	n.d.	n.d.
EPS granules -2.5 cm (small) -5 cm	n.d.	37 74	n.d.	n.d.
EPS granules -2.5 cm (large) -5 cm	n.d.	52 54	n.d.	n.d.
EPS crush	n.d.	39	n.d.	n.d.
<i>n.d. no data</i>				

**Table 4.27: Reductions of ammonia evaporation from pig slurry storage achieved by applying different types of floating covers [125, Finland, 2001]**

**Applicability:** Although the results from using floating covers vary widely, they are generally good enough to make their application to slurry tanks an attractive option. The following observations from tests were reported [143, ADAS, 2000].

Rape oil (or derivatives with high percentages of rape oil) is very easy to apply and does not easily mix with pig slurry. However, it is biodegradable, loses its surface integrity over time and also it greatly increases methane emissions. Material that floats well and does not have to be added every year may have the disadvantage of being blown away and may therefore need an additional cover as replacement. Very low-density minerals absorb water, or can be rapidly blown away by wind, or they are dusty and unpleasant to use. An example is expanded polystyrene (EPS).

LECA is suitable for tanks and lagoons. LECA granules are heavier than EPS. Observations have reported that it tends to sink to the bottom of the store and therefore more has to be added, but other sources do not report this. Because of its higher density, however, LECA does not have all of its layer floating on top of the slurry surface. To get LECA in place and evenly distributed may be difficult with large tanks and lagoons, but could be done by mixing it with water or slurry and pumping it onto the surface.

Peat mixes with slurry during stirring, gets waterlogged and has to be renewed after each stirring. However, peat is a natural product and does not create a waste problem.

The application to existing stores does not require complex adaptations for any of the different types of floating cover.

The filling outlet should be very close to the bottom of the tank.

**Costs:** Costs for floating sheets for stores with diameters of 15 – 30 m. are reported to range from EUR 15 – 36 /m<sup>2</sup> (1999).

**Reference farms in EU:** Floating covers have been applied, but reported results are mainly derived from laboratory and field trials, rather than from actual farm applications in practice.

**Reference literature:** [125, Finland, 2001], [142, ADAS, 2000], [143, ADAS, 2000] [193, Italy, 2001] and M. de Bode, "Odour and ammonia emissions from manure storage", pp. 55-66 in "Ammonia and Odour Emissions from Livestock Production (Eds C.D. Nielson, J.H. Voorburg & P.L Hermite, Elsevier, Londen, 1991.

### 4.8.2.5 Application of covers to earth-banked slurry stores

**Description:** Covers for earth-banked slurry stores are based on flexible impermeable UV-stabilised plastic sheets that are secured at the bank tops and supported on floats. LECA is also possible for smaller lagoons, but it is considered to be better for application to a tank. Other applied covers are chopped straw or a natural crust.

**Environmental benefits:** Reductions in ammonia and odour emissions can be achieved. Ammonia emission reductions of about 95 % or more have been reported. Application of LECA reduced ammonia emissions by 82 %.

**Cross-media effects:** For covering a lagoon a large amount of plastic is needed, this can measure up to 70 % more than the actual lagoon surface area, depending on the depth and inclination of the edges. A benefit is that the cover can be re-used, whereas other covers are consumables.

Lagoon coverings keep out the rain, but they also prevent evaporation, which means that the total volume of slurry to be applied will slightly increase. It has been suggested that where no cover has been applied it is cheaper to discharge the relatively clean rainwater to a watercourse and to only apply the slurry, rather than applying the larger volume of combined slurry and rainwater. There is a potential to apply the rainwater for irrigation, but it would require careful monitoring of the water for slurry leakage or other contamination. Farmers are not in favour of recycling, for reasons of hygiene and disease control.

Stirring of the slurry would mix the slurry and its LECA layer, which then increases the ammonia emissions temporarily. It has been observed that the LECA cover re-established itself very quickly after stirring and that emissions again dropped to the reduced level. However, LECA as a cover does create problems with landfilling.

Covering will reduce or (in the case of a plastic covering) eliminate oxygen transfer from air to the slurry and will raise the temperature of the slurry by about 2 °C. These effects create an anaerobic condition in which methane will rapidly be formed. Methane emissions are increased by mixing and stirring of the slurry. The lack of oxygen reduces nitrification (and consequently) denitrification, and hence nitrous oxide emissions could be significantly reduced or prevented. With LECA, oxygen can still enter the slurry, which means that (de-)nitrification processes can occur and hence emissions of nitrous oxide are likely to increase.

**Applicability:** It was concluded that purpose-designed covers can be fitted to existing pig slurry lagoons, unless:

- access is very poor
- a lagoon is very large (cost)
- the banks are uneven.

The lagoon must be emptied completely of slurry and sludge to allow fitting of the cover. Wind damage is not a problem if the cover is well fixed on the sides and if some rainwater is kept on top to weigh it down. Modifications to current agitation and emptying methods may be necessary but, with the relatively low dry matter content of pig slurry, mixing is not a problem.

Durabilities of covers of 10 years have been reported, but the vulnerability to wear and damage from animals is unknown.

It was suggested that plastic covers could effectively increase the capacity of a lagoon by as much as 30 %, by keeping rainwater out. This would either give more storage flexibility over time or provide a larger capacity in case of an expansion in farm stocking.

LECA can be blown onto the slurry surface or pumped with the slurry. The latter technique would cause less dust and loss of material and would have a higher rate of distribution. Mixing and pumping with slurry may damage the material and must be performed gently.

**Costs:** Costs of floating covers are likely to be EUR 15 – 25 /m<sup>2</sup> of exposed slurry surface. Costs of LECA are EUR 225 – 375 per tonne. Abatement costs vary between EUR 0.35 and 2.5 per kg NH<sub>3</sub>-N for plastic covers and EUR 2.5 and 3.5 per kg NH<sub>3</sub>-N for LECA. Additional costs will be incurred on sites where modifications are needed to the structure, or to emptying and agitation methods. Efficient rainwater management determines the differences in running costs, where LECA covered lagoons may coincide with higher slurry application costs and where application costs will be higher where rainwater can enter the slurry. With plastic coverings, net costs depend on the possibilities for re-use of water for irrigation. The use of biogas (methane) depends on the purpose (heating or engine) and on the installation requirements. It might be profitable, but the cost recovery period might be quite long (over 20 years).

**Reference farms:** In 2000, one farm applied a cover that had recently been fitted under a MAFF-funded project. In the Netherlands, covers on lagoons have already been in use for ten years. [142, ADAS, 2000]

**Reference literature:** [142, ADAS, 2000] [143, ADAS, 2000].

### 4.8.3 Feed storage

No particular techniques have been reported for a reduction of air emissions from feed storage. In general, dry matter storage facilities might cause dust emissions, but regular inspection and maintenance of the silos and the transport facilities, such as valves and tubes, can prevent this. Blowing dry feed into closed silos minimises dust problems.

Every few months a silo should be fully emptied to allow inspection and to prevent any biological activity in feed. This is particularly important in summer to prevent deterioration of feed quality and to prevent a development of odorous compounds.

## 4.9 Techniques for on-farm processing of manure

In the following sections a number of manure treatment techniques are described as far as they can be applied on-farm.

A number of individual basic techniques for manure treatment have been evaluated by VITO [17, ETSU, 1998]. These techniques were derived from a large number of initiatives for treating the manure of cattle, pigs or poultry on-farm or in a stand-alone installation. In general, systems that require a lot of technological expertise and/or that are only viable for large scale applications are performed at stand-alone installations. All the techniques mentioned in Section 2.6 have been tested on farm installations in Denmark, the Netherlands, Germany, Belgium or France. Some techniques have still not been fully developed or still need a wider application to allow a proper validation of their performance.

Often, manure treatment is not a single technique, but forms a sequence of different treatments, where the technical and environmental performances can be affected by:

- the characteristics of the manure
- the features of the individual treatments applied
- the way techniques are operated.

The focus is primarily on the control of losses of nitrogen and phosphate to the environment. This can be quantified as the relative nutrient loss, expressed as the quotient of the loss of N and P to air, water and soil compared to the total input of these nutrients. The higher this quotient the higher the losses into the environment.

An evaluation of a treatment should include the potential for using the product on-farm (biogas, landspreading) or for marketing the resulting product (compost, ash) for application elsewhere. The data reported do not allow such an evaluation, as it involves many factors and also depends on the reasons treatment is applied (e.g. odour reduction or volume reduction for transport).

The application of some treatment techniques may be restricted by national or regional legislation, such as is the case with anaerobic digestion in the Netherlands. In this section only an environmental/technical appraisal is made. It is to be expected that this assessment will include some of the elements on which legal restrictions are based. Those (national) restrictions will not prevent a technique from being considered BAT.

Although the on-farm treatment of manure is certainly not widespread in Europe, several systems are applied or under testing. However, in the framework of this BREF it is not possible to give a complete overview of all the systems of interest. Sometimes treatment is an integrated part of another reduction technique. For example, poultry housing systems incorporate manure drying, which can also be considered as a kind of on-farm manure treatment (Section 4.5).

The list of combinations described in the following paragraphs is not exhaustive and by no means is it suggested that other combinations are not equally viable and applicable on-farm. Both basic manure treatment techniques and combinations of techniques are described as far as submitted data allow. Some key performance characteristics are summarised in Table 4.28. In fact, for an integrated assessment, these emissions should be compared to those from landspreading (e.g. emissions to surface water of 24 % of nutrients, NH<sub>3</sub> emissions of 25 % of N-content [17, ETSU, 1998], page 94, table 33). This exercise is very site-specific and therefore beyond an assessment of general BAT.

Although nitrogen reduction has been given the most attention, a reduction of phosphate levels in manure is also important. A recovery of phosphate from incinerated chicken litter is considered as the most likely route through which phosphate could be economically recovered from animal wastes for industrial use [86, CEEP, 1998]. Chicken litter can be readily incinerated for its high dry matter and energy content, but the ash, which is high in phosphate content, is difficult to use for landspreading. Currently, to make recovery of the phosphate from the resulting ash economically viable for industrial phosphate producers they would require a minimum incineration volume and a competitive price compared with phosphate rock.

Section	Techniques	Prod. <sup>1)</sup>	RNL (%) <sup>2)</sup>	Additional abatement	Emissions		Energy <sup>3)</sup> (kWh/t)	Costs <sup>4)</sup> (EUR/m <sup>3</sup> )	Applicability
					Air	Water (mg/l)			
4.9.1	Mechanical separation	n.d.	n.d.	no	negligible	negligible	0.5 – 4 (kWh/m <sup>3</sup> )	1.4 – 4.2	wide experience
4.9.2	Aeration of liquid manure	n.d.	n.d.	no	odour, CH <sub>4</sub> NH <sub>3</sub> , N <sub>2</sub> O	negligible	10 – 38	0.7 – 4	wide experience
4.9.3	Biological treatment of pig slurry	n.d.	20.8	- air treatment - activated sludge treatment	odour NH <sub>3</sub> N <sub>2</sub> O	N-kj: 80 P : 260 COD: 1800 BOD: 90	16 (5.6 % dm)	6.1	large farms
4.9.4	Composting of solid manure	Y	n.d.	no	NH <sub>3</sub> (10 – 15 % of N) odour	negligible	5 – 50	12.4 – 37.2	no farm size limit
4.9.5	Composting of poultry manure with pine bark	Y	x	n.d.	n.d.	n.d.	n.d.	8.1 EUR/tonne	experimental
4.9.6	Anaerobic treatment of manure	6.5 kWh/ kg dm	n.d.	H <sub>2</sub> S-removal from biogas.	odour NH <sub>3</sub>	n.d.	yield	see Section 4.9.6	minimum farm size is 50 LU
4.9.7	Anaerobic lagoons	N	n.d.	no	odour NH <sub>3</sub> N <sub>2</sub> O	effluent	low	n.d.	limited
4.9.8	Evaporation and drying of pig slurry	n.d.	n.d.	- air treatment (e.g. condensers, acid washers, biofilters)	odour NH <sub>3</sub>	COD: 120	30 (kWh/m <sup>3</sup> water)	>2.3	experimental
4.9.9	Incineration of broiler manure	Y	n.d.	dust filtration (Teflon cloth)	odour dust: 30 mg/m <sup>3</sup> SO <sub>2</sub> NO <sub>x</sub> N <sub>2</sub> O	n.d.	yield	18 EUR/tonne	130000 broilers
4.9.10	Pig manure additives	Y	n.d.	no	no	no	yield	0.5 – 1 EUR/pig	routine

1) product for market: Y = yes, N = no; n.d. = not reported  
2) RNL = relative nutrient loss; n.d. = not reported  
3) energy per tonne raw manure  
4) annual operating costs (including return on investment)  
x : not quantified

Table 4.28: Summary of performance data of on-farm manure treatment techniques

### 4.9.1 Mechanical separation of pig slurry

**Description:** Common techniques and aims have been described in Section 2.6.

**Environmental benefits:** The achieved benefits of separation depend on a further treatment of the solid and liquid fractions. The dry matter percentage should be as low as possible in the liquid fraction and as high as possible in the solid fraction. Application of a flocculant can improve the separation achieved by techniques using a press or a centrifuge. With the separation of the solid fraction, a separation of the nutrients also occurs.

Technique	Type of manure	Percentage in solid fraction				
		Mass	dm	N	P <sub>2</sub> O <sub>5</sub>	K <sub>2</sub> O
Sedimentation	Sows	28	68	44	90	28
Press-auger	Finishers	13	35	11	15	53
Straw filter	Sows	11	79	23	>90	5
Centrifuge	Finishers	13	47	21	70	13
Centrifuge +flocculant	Finishers	24	71	35	85	24
Roll press	Finishers	33	83	47	90	30

**Table 4.29: Results of mechanical separation techniques expressed as percentages of raw manure in solid fraction**  
[3, Vito, 1998]

**Cross-media effects:** Straw filtering gave rise to water evaporation in amounts equal to about 12 % of the manure liquid. About 45 % of the nitrogen was emitted as ammonia. It is assumed that other techniques show hardly any emissions, as they are applied in closed systems. Energy use is considered to be low, at between 0.5 kWh/m<sup>3</sup> (sedimentation) and 4 kWh/m<sup>3</sup> (centrifuge).

**Operational data:** Filter media can get clogged or damaged during operation. Foaming may occur during centrifugal separation because of the excess air.

Austria reported the following operational data of a screw-press for pig slurry:

- capacity: 4.8 – 5.2 kg/s
- energy consumption: 320 – 380 J/kg
- dm-content achieved: 60 – 75 %
- total N separated: 22 – 42 %

The given ranges depend on the dm-content of the treated slurry. [194, Austria, 2001]

**Applicability:** Minimum capacities are often 1 m<sup>3</sup> per hour and can be applied on most farms (including smaller ones). Centrifugal separation is more costly and needs a minimum capacity to be applied economically. Mobile filters and centrifuges are available and can be applied on different parts of the farm.

**Costs:** Austria reported the following detailed data on costs of applying the screw-press for pig slurry described under ‘operational data’: [194, Austria, 2001]

- purchase costs: EUR 16000
- annual capital costs: EUR 2800
- operational costs: EUR 0.45/m<sup>3</sup>



Costs reported by Vito are summarised in the following table.

Technique	Investment (EUR)	Treatment costs (EUR/m <sup>3</sup> )	Capacity (m <sup>3</sup> /year)
Settling	Low, but not reported	1.36 (1994)	2000 (with flocculant)
Screw-press	13139	2.92 – 3.07 (1992)	1000 – 5000
Straw filter	89244	4.21 (1995)	4500
Centrifuge	180966	3.59 (1994)	10000 (10 m <sup>3</sup> /h)
Bandseparator	76849	3.25 (1988)	

**Table 4.30: Cost data for some mechanical separation techniques [3, Vito, 1998]**

**Driving force for implementation:** Mechanical separation yields a solid fraction that is easier to transport and/or is used for subsequent treatments such as, composting and evaporation and drying. [174, Belgium, 2001]

**Reference literature:** [3, Vito, 1998]

## 4.9.2 Aeration of liquid manure

**Description:** The description of aeration is given in Section 2.6.2.

**Environmental benefits:** Aerated liquid manure may be used for application on grass or for the flushing of manure gutters, tubes or canals to reduce ammonia emissions from housing. Ammonia nitrogen may be completely removed from the manure and emitted into the air.

**Cross-media effects:** Aerobic decomposition of the nutrients reduces odour. Additives may be needed for the sedimentation of floating substances. Depending on the additives applied, a residue (sludge) that is difficult to dispose of may remain after filtering of the condensate.

NH<sub>3</sub> and N<sub>2</sub>O are emitted to the air [174, Belgium, 2001], as well as methane [194, Austria, 2001].

Aeration requires energy, but the levels vary with the equipment applied and the size of the installation. Levels of 10 – 38 kWh per m<sup>3</sup> of aerated liquid manure have been reported.

**Operational data:** Aeration of pig manure may lead to a sludge that is difficult to precipitate and dosage of chalk may then be necessary. The temperature is an important factor, particularly in colder regions where it may be difficult to maintain the required aeration level during winter. However, intermittent aeration (15 minutes/hour) in combination with an achieved BOD<sub>5</sub> reduction of about 50 %, results in a good deodourisation and a very limited sludge production [193, Italy, 2001] (with reference to Burton et al., 'Manure management – Treatment strategies for sustainable agriculture', Silsoe Research Institute, 1997).

**Applicability:** There is wide experience with this technique. Aeration is probably more widely applied than composting solid manure, as it requires less input than composting solid manure, which needs the manure stacks to be turned.

**Costs:** Costs, reported by Finland, ranged from EUR 0.7 – 2 per m<sup>3</sup> of aerated liquid manure in a storage tank to EUR 2.7 – 4 per m<sup>3</sup> of aerated liquid manure in a separate tank.

**Reference farms:** This technique is applied in a number of Member States, e.g. Finland and Italy.

**Reference literature:** [3, Vito, 1998] [125, Finland, 2001]

### 4.9.3 Mechanical separation and biological treatment of pig slurry

**Description:** The manure is taken from a storage facility or directly from the animal housing and - by means of a sieve, sedimentation installation or centrifuge - the solid, undissolved components are removed. The purpose of this separation is:

- to avoid possible obstruction of equipment by sedimentation and clogging during the process
- to reduce oxygen demand, and thereby energy costs.

The liquid is pumped through an aeration tank or basin where it remains for 2 to 3 weeks. In the basin, micro-organisms (activated sludge) transform organic matter into mainly carbon dioxide and water. At the same time, part of the organic nitrogen is transformed into ammonium. Ammonium is oxidised by nitrifying bacteria into nitrite and nitrate. By applying anaerobic periods using basins without aeration, the nitrate can be transformed by denitrification into  $N_2$ .

Activated sludge and cleaned liquid then flow from the aeration basin into another (secondary) settling basin. In this basin the sludge settles, with part of it being re-used in the aeration basin. The residue is captured in a storage basin to concentrate it further. This concentrated residue, can be used as fertiliser (sometimes it is composted first).

**Environmental benefit:** The clean liquid (or effluent) contains very low levels of N and P. It leaves the secondary settling basin via its overflow. It can be discharged or stored for use on land as a fertiliser.

**Cross-media effects:** Electrical energy is required to operate the aeration, pumps, and pre-separation of the solids. In the applied system an energy use was measured of 16 kWh/m<sup>3</sup> raw manure.

A disadvantage is that part of the nitrogen emitted into the air is not  $N_2$  but  $NH_3$  or  $N_2O$ . The design and proper functioning of this technique is very important to prevent environmental problems being transferred from the water to the air component.

Also, an effluent must be discharged, which in many cases is not possible or allowed.

**Operational data:** Data are shown for a farm in Brittany with 250 sows and 5000 finishers per year with a yearly manure production of about 5000 m<sup>3</sup>. The solids are sieved from the liquid. The results in terms of mass balance, quantities and composition of the products and the costs of the installation for mechanical separation and biological treatment at this specific farm are summarised in Table 4.31, Table 4.32, Table 4.33 and Table 4.34.

Component	In	Out				
	Manure	Sieved residue	Sludge	Effluent	Leaked air emissions	Total
Mass	1000	57	260	580	103	897
Dry matter	56	20	21	5	10	46
Susp. Solids	48			0.3		
Water	944	37	239	575	93	851
COD	52			1		
BOD	6.6			0.05		
N	4.4	0.5	0.7	0.05	3.15	1.25
P <sub>2</sub> O <sub>5</sub>	3.3	0.6	2.0	0.4	0.3	3
K <sub>2</sub> O	3.5	0.2	0.9	1.8	0.6	2.9
Cl	1.9			0.8		

**Table 4.31: Mass balance of the mechanical separation and biological treatment of pig slurry [3, Vito, 1998]**

Component	Sieved residue	Sludge	Effluent	Leaked emissions
Mass	6	26	58	10
Dry matter	35	38	9	18
Susp. Solids			0.6	
COD			2	
BOD			0.8	
N	10	16	1	73
P <sub>2</sub> O <sub>5</sub>	18	61	11	10
K <sub>2</sub> O	5	26	50	19
Cl			42	

**Table 4.32: Relative distribution of a number of components over different product streams [3, Vito, 1998]**

Component	Manure	Sieved residue	Influent	Sludge	Effluent
Dry matter	56	350	39	80	8.5
Susp. Solids	48		29		0.5
Water	944	650	961	920	991.5
COD	52		36		1.8
BOD	6.6		6.1		0.09
N	4.4	8.1	4.2	2.7	0.08
P <sub>2</sub> O <sub>5</sub>	3.3	9.9	2.9	7.5	0.6
K <sub>2</sub> O	3.5	3.4	3.4	3.4	3.0
Cl	1.9		1.9		1.4

**Table 4.33: Composition of manure and products in g/kg [3, Vito, 1998]**

The sieve removes a small mass with a relatively high dm-content and phosphate level. The residue contains about 35 % dry matter and can be stacked.

The tables show that much of the N (72 %) disappears into the environment due to nitrification and denitrification. Only about 1 % of the N appears in the effluent. Most of the P<sub>2</sub>O<sub>5</sub> is retained in the activated sludge. It should be noted that the information source did not report if BOD was measured over 5, 7 or 20 days.

The residual concentrations in the effluent need to be compared with the locally accepted discharge levels. This may be a problem and application on land might be the only option available for the effluent. The amount and composition of the different products can vary widely. Important factors are:

- the water content of the manure
- the variability of the treatment.

Usually the aeration tanks are open and considerable emissions to the air can be expected of gaseous components (such as odour, ammonia, N<sub>2</sub>O). However, in this example, the emissions have not been quantified. Covering of the basins and extraction and treatment of the air or adequate process control will reduce those emissions. Also, an emission of N<sub>2</sub>O can be expected.

**Applicability:** The technique is applicable on both new and existing farms. Due to its costs it may only be applicable on (very) large pig farms. It is based on the applied biological treatment for municipal and industrial waste water. Proper process control is essential, but may be difficult on-farm, outsourcing could thus be a solution. Particularly in colder areas in winter the minimum temperatures required for sufficient biological activity to occur may be difficult to maintain. Ammonia levels can rise and lead to inhibited nitrification.

With more solid types of manure, such as the manure of finishers, large amounts of residual sludge can be expected. In practice this limits the application of this technique to the treatment of sow manure with a dm-content of not more than 6 %.

**Costs:** Costs have been estimated for the installation in Brittany described earlier with a capacity of 5 kilotonnes manure per year. The investment was EUR 134000 (1994). In Table 4.34 operating costs (including external technological support) are presented, although excluding the costs and returns of marketing the products.

Cost factor	Cost basis	EUR/tonne manure
Capital	10 yrs, 7 %	3.6
Maintenance	3 % of investment	0.8
Electricity	16 kWh/t and 0.08 EUR/kWh	1.3
Technological support		0.4
Total		6.1

**Table 4.34: Estimation of the operating costs of an installation for the mechanical separation and biological treatment of sow manure with a capacity of 5 ktonnes per year in EUR/tonne manure [3, Vito, 1998]**

**Driving force for implementation:** From other examples of where this technique is applied it is concluded that manure with a high water content is preferred. Also, it seems most cost effective in application on farms of generally more than about 500 sows.

**Reference farms:** Brittany (France).

**Reference literature:** [3, Vito, 1998] [145, Greece, 2001]

### 4.9.4 Composting of solid manure

**Description:** Composting (see Section 2.6.3) can be applied after the drying of fresh (poultry) manure, after mechanical separation of the solid fraction of pig slurry or after the addition of dry organic material to a relatively solid wet fraction.

**Environmental benefits:** The benefits in terms of the fertiliser product obtained depend on the type of manure, the pretreatment technique, the additives and on the composting technique, and cannot be quantified in a general sense.

**Cross-media effects:** Composting leads to losses of nitrogen, potassium and phosphorus. In partly aerobic conditions, such as in unsealed manure stacks, 10 – 55 per cent of the nitrogen is lost. Most of the nitrogen evaporates into the air as ammonia, while a small fraction sinks into the soil in water. The evaporation of nitrogen can be prevented by means of a cover. Peat is suggested as the cover, as it is reported that acid sphagnum peat (*Sphagnum fuscum*) has a better N-binding capacity than e.g. straw, sawdust or cutter chips. However, peat is a non-renewable resource and this might be grounds for not using peat for the coverage of manure heaps [190, BEIC, 2001]

If the stack is put on soil, part of the nitrogen that sinks into the soil evaporates, and plants use part of it after the stack is removed. Depending on the amount of run-off, soil surface and soil type, part of the nitrogen may also leach into the surface waters or groundwater.

About half of the potassium in manure may be lost due to composting. Potassium is lost only in run-off water, and these emissions can be reduced by means of a watertight cover over the compost. The cover prevents the leaching caused by rainwater, but it does not prevent the water produced in the compost from sinking into the ground.

If composting is performed in a barn, losses to the soil or from leaching during the composting process are non-existent.

Composting may give rise to odour, but quantification is difficult.

**Operational data:** The energy use depends on the composting technique applied. Without aeration and turning of the stacks, the energy use would be negligible. Consumption varied between 5 kWh/tonne for turning only to between 8 and 50 kWh/tonne for installations that apply ventilation through or over the stacks as well.

Heat produced by a properly operated composting process will evaporate the humidity in a compost heap, which will then escape as water vapour.

Composting periods may last up to 6 months or more, but can be shortened by frequent stirring (turning) and aeration.

**Applicability:** The process is relatively simple and can be applied on a small scale, but it needs control to avoid anaerobic processes that could lead to an odour nuisance. If process control and emission reduction are required, then the composting installation needs to be larger for (cost-) efficient operation.

**Costs:** Costs depend on the scale of application and so vary largely. A cost indication has been given of EUR 12.4 – 37.2 per tonne of manure [3, Vito, 1998].

**Driving force for implementation:** Composted solid manure has low odour, is more stable, contains less pathogens and is relatively dry. This allows easier transportation without the risk of transferring diseases. [174, Belgium, 2001]

**Reference farms:** The technique is applied in several Member States, e.g. Portugal, Greece and Sweden.

**Reference literature:** [3, Vito, 1998] [125, Finland, 2001], [145, Greece, 2001]

#### 4.9.5 Composting of poultry manure using pine bark

**Description:** To control the composting system and to achieve a better quality, substances such as straw and grass can be added to raise the C-content. The application of additives aims to increase the porosity and binding of the N, thereby avoiding emissions into the air.

In this example, poultry manure is mixed with pine bark, at a ratio of excreta/bark of 3/1 on a total weight basis. In a comparison with other kinds of auxiliary substances the pine bark showed the best results for pH-level, N-evaporation and C-content (organic material).

The composting system takes place at a temperature of 55 – 60 °C. A minimum porosity of the manure/bark mixture is maintained for adequate oxygen supply.

**Cross-media effects:** NH<sub>3</sub> emission is considerable [174, Belgium, 2001].

**Operational data:** The compost produced with the addition of pine bark showed an unchanged 70 % organic matter (on dm-basis) after 90 days. The nitrogen losses reached about 35 % (on dm-basis) at 90 days and this increased by 1 – 2 % over the next 90 days. The pH at 90 days was below 8, and reached 7.5 at 180 days.

**Applicability:** The composting technique is applicable to new and existing farms. Sufficient availability of the required additive, in this case pine bark, is necessary. The bark needs to be dried and ground before it can be added to the manure.

**Costs:** Costs for the amount of manure produced by 200000 layers have been calculated (1997) and are summarised in the table below:

Cost factors	EUR/tonne of manure processed	EUR/tonne of compost obtained
Additive	2.4	5.4
Manual work	1.2	2.8
Maintenance and repair	0.8	1.7
Energy	3.7	8.3
Total	8.1	18.2

**Table 4.35: Cost data for the composting of the poultry manure of 200000 layers by means of mechanical turning**

**Driving force for implementation:** There was a local market for alternatives to the fertilisers normally used.

**Reference farms:** Application beyond experimental level has not been reported.

**Reference literature:** [75, Menoyo et al., 1998]

### 4.9.6 Anaerobic treatment of manure in a biogas installation

**Description:** This technique has been briefly described in Section 2.6.4.

**Achieved environmental benefits:** The benefits can be expressed in terms of a reduced organic dry matter (to 30 – 40 % of the original amount), biogas production (25 m<sup>3</sup> per m<sup>3</sup> of slurry) and methane concentration (65 %). With pig slurry, it is common to calculate a specific methane production of about 200 litres per kg of dry matter (or about 6.5 kWh). The primary effect is therefore a reduction of fossil fuel use and of CH<sub>4</sub> emissions.

**Cross-media effects:** Additionally, the application of anaerobic fermentation in a biogas installation has a number of other effects:

- a reduction of pathogen in manure
- a reduction of odour emission
- transformation of N into NH<sub>3</sub>
- improved characteristics for separation and further treatment or application
- a reduction of greenhouse gas emissions.

Emissions arise from burning the biogas in the heaters or engines.

**Operational data:** To get the required temperature, manure can be warmed up by using part of the produced biogas or by heat exchange with the water cooling the gas engines. In farm-scale applications heating of the manure is not always applied.

The required amount of heat for the mixers and pumps is estimated to be about 10 – 20 % of the gross energy production of the installation.

The gas is stored in a gas buffer before being used in a heater or a gas engine. Before the gas can be used, sulphur must be removed by a biological, adsorptive (active coal or ferrochloride) or chemical technique (quenching) in larger installations.

**Applicability:** There are no technical restrictions to the on-farm application. The cost efficiency is likely to increase with an increasing volume of fermented slurry. The minimum farm size according to literature (see reference literature) is 50 LU [194, Austria, 2001].

Different kinds of manure can be treated, but poultry manure (grit) requires frequent cleaning and removal of the sediment in the reactor, despite the intensive mixing of the biomass.

**Costs:** The investment costs for an anaerobic treatment plant with a capacity of 100 LU is within the range EUR 180000 to 250000. Annual operational costs (running costs) are:

- technical support: EUR 12500
- maintenance and repair: EUR 1800 – 2500 (1 % of the investment costs)
- insurance: EUR 450 – 650 (0.25 % of the investment costs)

The annual profits are:

- power generation: EUR 42400
- heat generation: EUR 13300
- an upgrade of the value of the organic manure (N value): EUR 7000 [194, Austria, 2001]

**Driving force for implementation:** The high prices for energy and the availability of financial support schemes for sustainable energy production were responsible for the application of this technique. In some Member States the use of biogas in connection with the covering of the pig slurry store is stimulated by financial incentives (e.g. Italy).

**Reference farms:** Germany has the largest number of biogas installations on farms (ca. 650 in 1998), but most other countries have <100 and some have only a few. Italy has installed about 50 low-cost digesters using gas which develops under the covers on slurry stores operating at low temperatures. Some centralised anaerobic digesters, which take livestock manures and other wastes, have been constructed in some countries, e.g. Denmark and Germany.

**Reference literature:** [17, ETSU, 1998] [124, Germany, 2001] [144, UK, 2000], and: Amon Th.; Boxberger J.; Jeremic D., 2001, “Neue Entwicklungen bei der Biogaserzeugung aus Wirtschaftsdüngern, Energiepflanzen und organischen Reststoffen”, Die 5 Internationale Tagung, “Bau, Technik und Umwelt in der Nutztierhaltung”, 6-7 March 2001, Universität Stuttgart/Hohenheim, ISBN 3-9805559-5-X, pp 140-145.

#### 4.9.7 Anaerobic lagoon system

**Description:** This technique has been described in Section 2.6.5. Anaerobic treatment can be followed by a final aerobic stage before the fluid fraction is applied or discharged.

**Achieved environmental benefits:** The environmental benefit of anaerobic treatment depends on the quality of the liquid and its application after treatment. The aim is to improve the quality of both solid and liquid manure fractions so that they can be used as fertiliser.

Information on anaerobic lagoons also refers to the discharge option or to application in situations where otherwise this would have had an unwanted environmental impact. It is questioned whether in these cases anaerobic lagoons solve or add to the problem of manure application.

**Cross-media effects:** Odour may develop from the lagoons, as well as NH<sub>3</sub> and N<sub>2</sub>O [174, Belgium, 2001]. After separating out the liquid fraction a solid fraction remains, this then has to be treated (e.g. composting).

Energy is required for separation of the solid fraction and for pumping the liquid between basins. In some Member States, natural height differences in the countryside are used to make the liquid flow by gravity from one lagoon to the other. At the end of the separation a liquid fraction remains that has to be disposed of.

**Operational data:** The lagoon system is considered to be relatively easy to operate. Generally, an installation separates the solid fraction mechanically. The liquid manure that remains can stay in the different lagoons for up to a year. The final aerobic step is optional, consequently some installations have an aeration installation, and some don't.

Analyses of the liquid during the different stages of treatment may be applied.

**Applicability:** Anaerobic lagoons are applied to farms with a large number of animals and with sufficient land to allow a series of lagoons to be applied to cover the different treatment steps. Lagoons are particularly suitable for large capacities. Note however, that the temperature requirements for the anaerobic process make the technique less suitable for areas that have cold winters.

**Costs:** Costs vary, depending on the geophysical characteristics of the soil and on the size of the installation.

**Driving force for implementation:** Legislation on waste waters to be applied to land or discharged to surface waters has contributed to the application of anaerobic lagoons in some Member States, such as in Portugal and Greece.

**Reference farms:** Farms in Portugal, Greece and Italy.

**Reference literature:** [145, Greece, 2001]

### 4.9.8 Evaporation and drying of pig manure

**Description:** The manure is ground and mixed first. Using a heat exchanger the manure is heated to 100 °C by means of warm condensate and kept at this temperature for about 4 hours, while degassing occurs. Any foam that has been formed is degraded. The gases are processed into by-products.

In the next step the manure is brought into a drying machine and compressed (1.4 bar). Any water vapour that is formed is compressed, which raises its temperature to 110 °C. This hot vapour is then used in a heat exchanger, thereby drying the manure using the sensitive heat of the vapour. There is a thin tube wall between the manure and the vapour on which the vapour condenses before being discharged.

**Achieved environmental benefits:** Allows the drying of pig manure with only a low energy level and with reduced emissions to air and water.

**Cross-media effects:** The application of mechanical vapour compression has an energy consumption of about 30 kWh per tonne of water evaporated.

**Operational data:** The products of this technique are pulverised manure with 85 % dm-content and an effluent, which is the residual condensate. This condensate is low in N and P and has a COD of less than 120 mg/l.

The system is affected by the heterogeneity of the manure, foam formation and corrosion.

**Applicability:** This has been developed for use on large farms. The maximum capacity is 15 – 20 m<sup>3</sup> per day. Application is possible for new and existing farms.



**Costs:** The costs for an installation (excl. housing) were estimated at EUR 160000 – 200000 (1994). The operating costs were calculated as EUR 2.3 per m<sup>3</sup>.

Cost factor	Cost basis	EUR/m <sup>3</sup> (1994).
Investment	installation of 15 – 20 m <sup>3</sup>	10000
Energy	30 kWh	1.3
Additional components		0.6
Technical assistance		0.4

**Table 4.36:** Costs for an installation for evaporating and drying pig manure with a capacity of 15 - 20 m<sup>3</sup> per day [3, Vito, 1998]

**Reference literature:** [3, Vito, 1998]

#### 4.9.9 Incineration of poultry manure

**Description:** The installation described has a capacity of 0.5 tonne manure (55 % dm) per hour and is operated for 5000 hours per year.

Broiler manure is automatically fed from a manure store into a first combustion chamber at a temperature of 400 °C. From this chamber the gas/ash mixture enters a second combustion chamber. In this chamber the mixture is rapidly heated, i.e. within three seconds, up to a temperature of 1000 to 1200 °C under controlled oxygen supply. As a result of the high temperature all the odorous components are eliminated. The hot flue gases leaving the second chamber go through a heat exchanger, in which water is heated to a temperature of about 70 °C. The heated water is used for the floor heating of two broiler houses with a total surface of about 5000 m<sup>2</sup>.

**Achieved environmental benefit:** The benefit of this technique is the production of an ash that can be used as a fertiliser and of hot water which is used for heating the housing, and which therefore saves fossil fuel use.

**Cross-media effects:** Once the installation has started, no additional fuel is necessary to incinerate the manure given its dm-content of 55 %.

The flue gases are emitted to the atmosphere through a Teflon dust filter. The dust filter reduces the dust concentration in the flue gas from 1000 to 30 mg/m<sup>3</sup>. The separated dust is added to the remaining ash of the combustion chambers.

Odour emissions are low due to the high temperature. SO<sub>2</sub> emission is limited as a result of added chalk.

**Operational data:** The raw material used is broiler manure with a dm-content of 55 % and a low litter content. For each production cycle about 1 tonne of wood shavings is spread on the surface of the shed floor of 5000 m<sup>2</sup>. To fix the sulphur components small amounts of chalk are added to the manure.

Of this mixture only 10 % remains after incineration. This residue can be sold as fertiliser.

In the reported example an installation with a potential capacity for the manure of 200000 broilers was installed. If the installation was operated at full capacity, it would be able to incinerate 500 kg manure per hour. However, the installation is operated at a reduced capacity, with an input from 130000 broiler places, treating 6 to 7 tonnes per day, which also serves the energy demand for heating.

**Applicability:** The installation can be applied on new and existing farms. The capacity can be adjusted to the available manure production. There were no technical limitations reported to its application on a farm scale.

**Costs:** Costs are summarised in the following table.

<b>Cost factor</b>	<b>Costs (EUR/tonne)</b>
Investment (incl. filters)	205751
Dust filters only	76847
Operation (capital, maintenance, etc.)	45860
Returns (energy saving and manure)	-59494

**Table 4.37: Cost data for the on-farm incineration of poultry manure [3, Vito, 1998]**

Costs depend on the material used and can be much higher if more durable materials are applied. Operating costs and returns are calculated on a yearly basis and give a positive balance. For an installation that is operated for about 5000 hours per year and a yearly input of 2.5 kilotonnes of manure, the gross costs will be about 18 EUR/tonne of manure based on the above given cost data. Costs depend very much on the application of a flue gas treatment. This may be too costly for farm scale application.

**Reference farms:** Applied in Germany

**Reference literature:** [3, Vito, 1998]

#### **4.9.10 Pig manure additives**

Source: [196, Spain, 2002]

**Description:** Of all the additives described in Section 2.6.6, only those for changing the physical properties of the manure to make it easier to handle, such as biological agents, are commonly used at the farm level, and give in most cases a positive effect. These additives are not hazardous and no significant cross-media effects have been reported

Their use results in an increase in manure flowing, elimination of superficial crusts, reduction of soluble and suspended solids and a reduction in the stratification of the manure. However, these effects were not demonstrated in all – comparable – cases.

Their application might make the cleaning of the manure pits easier and quicker, and lead to savings in water and energy consumption. Moreover, since the manure is more homogeneous, it facilitates the manure's agricultural use (i.e. allowing better dosing).

**Achieved environmental benefits:** A better use and management of manure on the farm can be achieved with a more homogenous manure, namely because having greater homogeneity makes it easier to dose the manure in the landspreading. A lesser volume of manure will be produced due to using less water in the easier cleaning of the pits. In some cases, a decrease in ammonia emissions could be achieved.

**Costs:** Costs may vary widely but most of the commercial products sold nowadays are between EUR 0.5 and 1 per pig.

**Cross-media effects:** A saving of energy is possible because of a lower use of cleaning machines, a saving in water is also achieved.

**Reference farms:** There are many commercial products registered in the EU. Many farms in different Member States use them as routine.

**Reference literature:** [202, Institute of Grassland and Environmental Research, 2000]

## 4.10 Techniques for the reduction of emissions from application of manure to land

The landspreading of slurry and solid manure and the irrigation of dirty water are commonly applied techniques. Essentially, the quantities of elements emitted, such as N, P and K, are a function of the amount of manure and its nutrient concentration. The amount and concentrations can be reduced by the application of nutritional techniques and by the efficient use of water (Sections 4.2 and 4.3). They are increased as a result of the reduction in air emissions brought about by the application of reduction techniques to manure collection and storage systems (Sections 4.5, 4.6 and 4.8). Techniques have been developed to treat these organic wastes before they are applied to land. The aims of these techniques are to reduce the amount of organic wastes to be applied, to reduce the environmental impact during and after their application or to produce a good quality fertiliser (Section 4.9).

Techniques to reduce the emissions from landspreading could be divided into two categories:

1. techniques to reduce the emissions after or as a consequence of landspreading; this concerns emissions to soil and surface- and groundwater (N, P, etc.) and to some extent to air
2. techniques that reduce the emissions that occur during the landspreading activity; these are predominantly air emissions (ammonia and odour) and noise.

In practice, the distinction between these two techniques is not that clear-cut, as application of a reduction technique in one category also has reducing effects in the other.

### 4.10.1 Balancing spreading of manure with the available land

**Description:** Essentially, emissions from manure application to soil and groundwater can be prevented by balancing the application rate with the requirements of the soil expressed in terms of the capacity of nutrient uptake by soil and vegetation. The application rate is the ratio between the concentration of nutrients in the manure and the manure volume, and the area available for landspreading (kg/ha/year). Typically, crops demand for P<sub>2</sub>O<sub>5</sub> is 3 – 4 times lower than for N, but their level is equivalent in pig and poultry manure, so a balanced fertilisation would include both, N and P inputs in order to avoid progressive saturation of the soil by phosphorus.

Nutrient uptake by soil and vegetation is complex and depends on the soil and weather conditions during application, the season and the type of grass or crop that is grown. Ideally, to prevent the application of excess nutrients, no more manure should be applied than soil/crop requirements allow. Given a certain nutrient concentration and manure volume, a crop/soil combination should be determined whose requirements match the amount of nutrients available. In other words, maximum application rates for N and P may change certain types of land use or a certain type of land use may have an impact on the livestock production (including numbers of animals that can be reared).

Tools (see also Section 2.7) that can be applied for balancing the manure spreading with the available land are:

- a soil nutrient balance
- a rating system, i.e. rating the number of animals to the available land.

(see also Section 2.7). The nutrient balance calculates the difference between the total input of nutrients into the soil and the total output of nutrients. A universal model has been developed to calculate this balance for national purposes. This shows any excess of nutrients (N and P) applied and gives an indication of the efficiency of nutrients use in the agricultural sector. The calculation has inputs for the use of mineral fertiliser, manure and other organic wastes, the atmospheric deposition of N and biological N-fixation, as well as crop use.

At the farm level a derived version is applied, which keeps a record of all the minerals that enter and leave the animal production system, in connection with the application of nutritional management techniques. This indicates the efficiency of nutrient use. A further step is the use of required crop nutrient levels to calculate the area available for the spreading of organic manure.

Rating the number of animals to the available land is a more pragmatic approach, and is applied in, for example, Italy, Portugal and Finland. The EC has calculated the N balance and Nitrogen Production Standards for different animal categories and has presented this in the given reference: [195, EC, 1999].

**Achieved environmental benefit:** It is difficult to quantify the effect of the use of the soil nutrient balance. The aim is to avoid having an excess of nutrients in the soil from the application of manure. Sometimes it is possible to deliberately cause a temporary excess of a nutrient, such as P, to make it available to crops to be grown on the same land.

**Cross-media effects:** Balancing the nutrients can reduce the environmental costs from soil and groundwater being contaminated by extended periods of application of excess nutrient levels.

If it results in lower application concentrations, the use of a soil nutrient balance will also affect other emissions associated with manure application, such as air emissions (ammonia).

**Applicability:** The nutrient balance is used to calculate national scenarios on necessary reductions of nutrient inputs from manure (and other sources). It can provide data for recommendations on policy instruments for reducing nutrient loads. These recommendations will affect the application of techniques used to reduce nutrient concentrations and will encourage the development of new application techniques.

The administration of minerals is conducted in at least one Member State and can be considered as a system derived from the nutrient balance but to be used at a farm level. Its application would need a detailed knowledge of the amounts of feed, the concentration of the nutrients, the characteristics of the animals' production, and an analysis of the manure output. This kind of administration is applied on-farm, but one of the drawbacks is considered to be the amount of administrative work and the time required to keep record of all the data.

Rating the number of animals to the available land is a more pragmatic tool.

**Costs:** Costs can be approached in two ways: (1) costs associated with the administrative tasks of the application of a mineral balance on-farm and (2) costs associated with the effects of applying the mineral balance, in terms of amounts of manure to be distributed elsewhere. Costs in the second category were estimated to increase by 60 % under the application of CAP 2000 and the mineral balance.

**Driving force for implementation:** In the Netherlands, the application of a mineral balance has been made obligatory by legislation. The designation of Nitrate Vulnerable Zones (NVZ) as defined in the Nitrate Directive (91/676/EEC) has promoted an increased use of nutrient balances (N-balance).

**Reference farms:** In the Netherlands, a mineral balance system is applied. The rating of the number of animals to the available land is applied in, for example, Italy, Portugal and Finland.

**Reference literature:** [7, BBL, 1990], [40, MAFF, 1998], [27, IKC Veehouderij, 1993] [195, EC, 1999]

### 4.10.2 Groundwater protection schemes

**Description:** The components of a groundwater protection scheme as applied in Ireland are:

- the vulnerability of an area to contamination; i.e. the definition of groundwater sources and resources (aquifers), which together define groundwater protection zones
- the responses of a location to the potentially polluting activities, depending on factors such as risk (hazard) and aquifer category.

**Achieved environmental benefits:** By defining the vulnerability of an area, the contamination of groundwaters by N, P, K, microbial pollutants or metals is prevented. The schemes are considered as tools that can direct the landspreading (e.g. advise on distances to vulnerable zones) to less vulnerable areas and define the appropriate landspreading management.

**Cross-media effects:** The application of groundwater protection schemes is likely to restrict the land surface area where application of manure is allowed, and by doing so may lead to manure production levels rising above the amount that can now be applied. If applying groundwater protection schemes it would be opportune to develop a programme in parallel that deals with the possible ways to treat the excess manure, such as on-farm treatment as discussed in Section 4.9.

**Applicability:** Groundwater schemes can be applied wherever a potential risk of groundwater contamination exists.

**Driving force for implementation:** Schemes have been developed based on European and national legislation for the protection of groundwater.

**Reference farms:** Groundwater protection schemes are applied in several counties in Ireland.

**Reference literature:** [60, EPA, 1999]

### 4.10.3 Management of landspreading of manure as applied in the UK and Ireland

**Description:** The management of landspreading of manure takes account of the nutrient balance and surface- and groundwater protection schemes. It combines the following aspects:

- application on suitable areas
- defining and observing buffer zones
- proper timing of application
- defining of spreading rate.

Codes of practice advise setting up an application plan and distinguishing between different planning stages [44, MAFF, 1998]. In the first stage, suitable areas are selected. Land is excluded, where manure should not be spread at any time or where there is a considerable risk of run-off, such as (very) steep slopes and surroundings sensitive to smell. Buffer zones should be defined and observed, in particular to avoid contamination of watercourses or the farmyard. Specific rules apply, such as minimum distances (50 – 100 m) to springs, wells or boreholes. These distances increase when the springs or shallow wells are downhill.

In the second stage, the amount of nutrients supplied by the manure must be matched with the capacity of the land it is applied to and the needs of the crop to be grown. Spreading rate (kg/ha)

should be matched to the amount of land available and the requirements of the crop (or grass) to be grown, the nutrient status of the crop and other organic manures and chemical fertilisers applied. In most reports, reference is made to the leaching of nitrate and a maximum of 250 kg of total N/ha/year is recommended for land outside NVZ. This amount can be lower where phosphorus amounts are a limiting factor. The timing of the application aims at further optimising the use of the available nutrients in manures. Manure should be spread as shortly as possible before maximum crop growth so that a maximum nutrient uptake will occur.

The third stage estimates the risk of pollution from spreading and aims to minimise run-off. Land with a very high risk of run-off (flooded, watercourses, etc.) should be avoided. Limits to the spreading rate are suggested at 50 m<sup>3</sup>/ha for slurry and 50 tonnes/ha for dry manure (UK) to high-risk land. For poultry, this usually means 5 – 15 tonnes/ha.

Weather conditions and the crop growing season must be taken into account when planning the application. The application of manure should be avoided in periods that are too dry and windy, such as in the summer months. However, in some areas where heavy winter rains occur, the soil has a reduced bearing capacity and will compact faster in those periods, so the drier season needs to be taken advantage of. Manure should not be applied on snow-covered and hard frozen fields, on fields that are cracked, or on fields that have been drained within the last year.

To reduce losses and to take advantage of the fertilising qualities of manure, manure should be applied just before the start of crop growth. For example in the UK, late winter-spring application is recommended for maximum nitrogen use.

Of the many complaints about unpleasant odours from farms, most relate to landspreading. The following points should, therefore, be considered before spreading:

- do not spread in the evenings or at weekends (bank holidays), when people are more likely to be at home, unless it is absolutely necessary
- pay attention to wind direction in relation to neighbouring houses
- avoid spreading under warm humid conditions
- use spreading systems, which minimise the production of dust or fine droplets
- apply a light cultivation of land within 24 hours after the application of manure.

**Achieved environmental benefits:** The planning of the application of manure reduces emissions of odour, loss of nutrients due to leaching, and run-off.

**Applicability:** The management of manure application can be applied without any limitation or requirements. The planning of manure application should play a role in the planning of new units and should consider any limitations that already exist.

**Costs:** It is considered that planned manure application can save costs rather than generate costs. Legal procedures from neighbouring residential areas and fines for pollution of watercourses can be avoided by properly planning the application.

**Reference farms:** Some farms in UK and Ireland apply 'Codes of Good Practice' describing farm waste management.

**Reference literature:** [1, EPA, 1996; 2, EPA, 1996], [45, MAFF, 1998; 43, MAFF, 1998; 44, MAFF, 1998], [51, MAFF, 1999; 49, MAFF, 1999; 50, MAFF, 1999]

### 4.10.4 Manure application systems

**Description:** Nitrogen is preserved better during the storage and spreading of liquid manure than in the solid manure handling chain. To reduce losses, which are largest during spreading,

the following slurry application systems are applied (described in Section 2.7 except high-pressure injection):

1. low-pressure broadcast spreader
2. bandsreader
3. trailing shoe
4. injector (open slot)
5. injector (closed slot)
6. high-pressure injection
7. irrigators
8. incorporation.

Techniques 1 to 5 are spreading systems for slurry, that can each be fitted onto a vacuum tanker or pumped tanker or used with an umbilical system as described in Section 2.7. Self-propelled irrigators cannot be used with injectors.

High-pressure injection is mentioned here but not much experience has been gained so far and no detailed information has been reported.

Incorporation is a technique that involves an immediate ploughing-in of the manure spread by techniques 1 – 3, and needs additional machinery. Incorporation can be done with different equipment, such as discs or cultivators, depending on the soil type and soil conditions. Usually the incorporation is carried out by a second person working with the plough, but it could also be done by one person: in which case the manured field (one tank load) is incorporated before reloading the tank.

Incorporation can also be carried out by direct injection or by incorporation equipment on the tank (see Figure 2.43).

A summary of the characteristics (achievable environmental benefit, cross-media effects, operational data, applicability, costs) of the slurry distribution systems (excluding irrigators because of the lack of data) is presented in Table 4.38 and a few notes are added in the text.

Section 2.7.3 describes the following three main types of spreaders used for spreading solid manure:

- rota spreader
- rear discharge spreader
- dual purpose spreader.

The latter two show much better performances in getting an even spread distribution. However, for reducing ammonia emissions from landspreading solid manure, the important factor is not the technique on how to spread but the incorporation.

**Achievable environmental benefit:** Emissions vary according to the slurry dry matter content, the prevailing weather conditions, the soil type and the crop conditions.

**Cross-media effects:** The energy needed for the transport tankers will depend on the volume transported and on the soil condition and the slope. Reducing the losses of ammonia through landspreading not only reduces the emissions to air and groundwater, but at the same time increases the amount of nitrogen available for grass and crop uptake. Several reports describe a number of applied techniques to reduce emissions from landspreading that focus on a reduction of emissions of N and ammonia to air.

**Operational data:** See Table 4.38. The conditions during application very much affect the performance of the techniques. The emission reduction increases with an increasing infiltration of the slurry into soil. This is enhanced by dilution of the slurry or by removing the solids. Dilution needs water and creates a larger volume to be applied, whereas removing solids

requires handling of a solid fraction and a liquid fraction as well. The higher the accuracy of application the lower the dry matter content of the slurry can be, thus requiring chopping or separation to some extent before the slurry can be applied.

**Applicability:** A number of factors must be taken into account in determining the applicability of each technique. These factors include:

- soil type and condition (soil depth, stone content, wetness, travelling conditions)
- topography (slope, size of field, evenness of ground)
- manure type and composition (slurry or solid manure).

Some techniques are more widely applicable than others. As the manure in techniques 3 to 5 is distributed through relatively narrow pipes, they are not suitable for very viscous slurries or those containing large amounts of fibrous material (e.g. straw), even though most machines incorporate a device for chopping and homogenising the manure. Injection techniques are potentially very efficient, but they do not work well on shallow, stony soils, which may result in damage to grass sward and increase the risk of soil erosion. All techniques may be applicable to arable land, but incorporation is limited on permanent grassland. Also, direct incorporation at greater depth may have the negative effect of leaching the nitrates toward the water table.

Research results on benefits in terms of crop yield were not unequivocal and could not contribute to selecting application techniques.

**Operational data:** Currently in the Netherlands, the technique of incorporating the manure within 4 hours is being applied more commonly. A good matching of logistics (tank spreading capacity and incorporation capacity) is a very important factor for achieving incorporation within 4 hours. In this instance, while a tank is reloading slurry, the person responsible for the incorporation catches up with the work. It is common practice to have a good logistic plan, for example in harvest time, for grain or other crops, it is good practice to combine the unloading of the combine harvester or other harvest machinery with the transport of the grain or the other crops to the storehouses in a short time. [197, Netherlands, 2002]

In some other Member States, incorporation within 4 hours is thought to be difficult to organise because the farmers do not usually own all the machinery required and do not have enough personnel. The farmers therefore need to rely on contractors and therefore the timing of operations is not completely under their control.

**Costs:** The investment costs of slurry spreading systems vary considerably depending on the specifications for each machine, whether they have hydraulic/electric controls, single/double axles or other extras. Slurry tankers constructed to take attachments will have a stronger chassis or special brackets fitted compared to stand-alone slurry tankers.

Investment costs for spreading techniques other than the reference (broadcast spreader) do not include costs associated with the attached slurry transport system. These prices can vary considerably and EUR 13000 or more could be added. Annual operating costs depend on the application rate per hectare and were based on the use of contractors. [9, UNECE, 1999]

**Driving force for implementation:** Application has been subject to legislative forces, e.g. in the Netherlands incorporation during spreading (i.e. within 4 hours) is required. [197, Netherlands, 2002]

**Reference farms:** All techniques are applied in Europe.

**Reference literature:** [9, UNECE, 1999] [10, Netherlands, 1999] [49, MAFF, 1999; 51, MAFF, 1999] [197, Netherlands, 2002]



Features	Broadcast spreader	Band spreader (Trailing hose)	Trailing shoe	Injector		Incorporation	
				Open slot (shallow)	Closed slot (deep)	Immediate (<4 hrs.)	Within same working day
Reduction of NH <sub>3</sub> -emission (%)	reference	30 (grassland; grass <10 cm) 30 (arable land)	40 (grassland)	60 (grassland)	80 (mainly arable land and grassland)	80 (arable land)	40 (slurry) 60 – 70 (solid pig) 90 (solid poultry) (arable land)
Range of dry matter	up to 12 %	up to 9 %	up to 6 %	up to 6 %	up to 6 %	slurry and solid manure	slurry and solid manure
Applicability		slope (tankers <15 %, umbilical <25 %), not for slurry that is viscous or has a high straw content, size and shape of the field, possibility of applying to growing crop between rows.	slope (tankers <20 %, umbilical <30 %), not viscous slurry, size and shape of the field, grass height should be about 8 cm	slope <12 %, greater limitations for soil type and conditions, not viscous slurry	slope <12 %, greater limitations for soil type and conditions, not viscous slurry.	only for land that can be easily cultivated	only for land that can be easily cultivated
Requires separation or chopping	no	up to 6 % no over 6 % yes	yes	yes	yes		
Relative work rate	→→→	→→	→→	→→	→		
Uniformity across spread width	✓	✓ (simple) ✓✓✓ (advanced)	✓✓✓	✓✓✓	✓✓✓		
Crop damage	✓✓	✓✓✓	✓✓✓	✓✓✓	✓✓✓		
Investment cost indication (10 <sup>3</sup> EUR per 10 m <sup>3</sup> )	18.6	11.4 <sup>a)</sup>	11.4 <sup>a)</sup>	8.6 <sup>a)</sup>	21.4 <sup>a)</sup>		
Operational cost indication (in EUR per m <sup>3</sup> ) <sup>b)</sup>	n.d.	0.7.	1.3	2.5	2.5	pig slurry 1.05 pig manure 1.47 layer manure 3.19 broiler manure 6.19	as previous
<i>a) only the application system, still requires additional costs of slurry transport</i>							
<i>b) see text for remarks</i>							

**Table 4.38: Characteristics of four different slurry distribution systems and incorporation techniques [10, Netherlands, 1999] [49, MAFF, 1999; 51, MAFF, 1999] [9, UNECE, 1999]**

### 4.10.5 Low-rate irrigation system for dirty water

**Description:** Dirty water is considered to be all the water from a farm that contains residues of cleaning (milking parlours) or other installations and farmyard run-off, and generally has a high BOD level (1000 – 5000 mg/l). Low-rate irrigation is applied on farms in the UK to bring dirty water onto land as far as the available land is suitable. The same restrictions on application apply as for the application of slurry.

This technique uses settlement tanks or lagoons to collect the dirty water before it is pumped onto land. Particles can settle to prevent the system from clogging, or solids removal can be done in the machine itself. This fraction will have to be disposed of.

The water is pumped from the stores and brought into a pipeline that goes to a sprinkler or travelling irrigator, which sprays the water onto land.

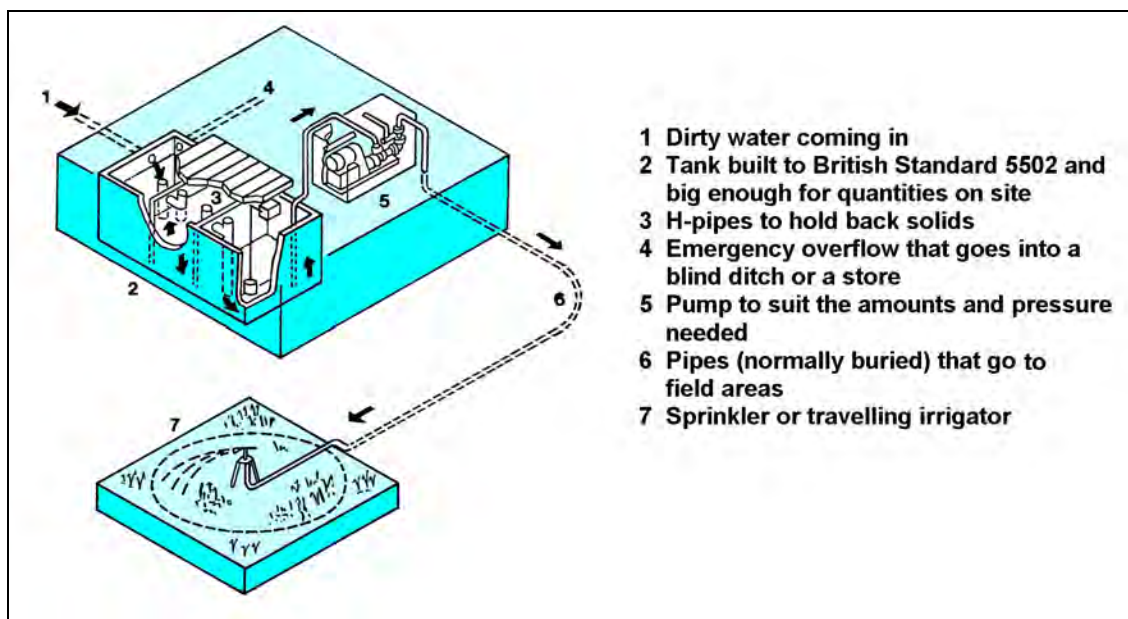

Figure 4.52: Example of low rate irrigation system [44, MAFF, 1998]

**Environmental benefit:** It is considered to have benefits in avoiding dirty water entering the sewer system or being discharged into nearby surface waters. However, low-rate irrigation should be carried out within the capacity limits of the receiving soil and should follow the general rules of good landspreading management (Section 4.10.3).

**Cross-media effects:** Energy is required to operate the system. Sufficient land must be available for spreading. However it may reduce the amount of land available for applying slurry. Odour can arise during spreading, and weather and soil conditions must be taken into account.

**Operational data:** The system needs an emergency overflow to store water in excess of its capacity (in case of heavy rainfall). The pump must be designed for the required pressure, depending on distance to the sprinkling system and the life inside the system. The capacity is variable and adapted to the average volume expected.

**Applicability:** Sufficient land adjacent to the farm is preferred, as it avoids the use of long pipelines covering large distances. The sprinkler system will have to be moved regularly to prevent contamination of the soil. The system requires regular maintenance to avoid clogging of the pipes and to prevent odour from residues collecting in the system.

**Reference farms:** Widely applied in the UK.

**Reference literature:** [44, MAFF, 1998]

## 4.11 Techniques to reduce noise emissions

Limited information has been submitted on techniques for reducing noise emissions from intensive livestock farming. Noise is still not considered an issue of high environmental importance, but with rural areas becoming increasingly populated noise (as well as odour) emissions may become more relevant. At the same time, reduced on-farm noise levels are considered to be relevant to the animal production, which itself requires a quiet and peaceful environment.

In general, noise reduction can be achieved by:

- planning of activities on the farm premises
- using natural barriers
- applying low-noise equipment
- applying technical measures to equipment (limited)
- applying additional noise abatement measures.

The impact of activities with potentially high noise levels can be reduced considerably by avoiding nights and weekends. Unnecessary disturbance of the animals during feeding and inter-house transfer should also be avoided, as this generally gives rise to increased noise levels. However, it is less stressful for birds to be handled in the dark and this is why bird catching and subsequent transport, often take place during night-time or in the early morning [183, NFU/NPA, 2001].

In ventilation systems, preference should be given, wherever possible, to low-noise fans. Noise radiation increases with impeller diameter and speed. For a given diameter, a low-speed fan is quieter than a high-speed fan.

In order to reduce noise emissions from machinery and implements, it is possible in certain cases to adopt passive noise abatement measures (encapsulation or sound screens, e.g. made from straw bales which absorb and deflect the radiated sound). Silencers/sound attenuation devices in waste airshafts have not proven successful, as they quickly become ineffective due to dust deposits.

Potential techniques to control or reduce noise emissions from a number of on-farm activities are described in the sections below.

### 4.11.1 Control of noise from ventilation fans

**Description:** Fans may be the cause of nuisance complaints, not least because they are often run more or less continuously, both day and night, in the warmer (summer) months.

By choice of system or equipment:

One method of eliminating noise from fans is to employ natural ventilation systems, including ACNV (Automatically Controlled Natural Ventilation), which also have energy saving benefits. A wide range of welfare and production factors governs the application of natural ventilation systems but these systems are not universally applicable. The problem with ACNV systems is that they do not allow accurate control of the air movement in the animal housing.

Fans can be selected to minimise noise. High-speed fans with 2-pole motors should be avoided because they tend to be very noisy. In addition, the smaller dimensions of these fans are also associated with smaller openings and cowls that have higher resistance to airflow. Generally, the slower the fan the less noise it will make. Particularly for poultry, cowls and air inlets can be designed with sufficient area so as to avoid any unnecessary pressure drops.

In certain circumstances, fan noise can be reduced by inlet-silencers. The nature of the exhaust air from livestock units makes this option suitable only for fan-pressurised ventilation systems, which are not commonly applied.

By design and construction:

The location of the fans is a significant factor. Employing low-level extract fans on sidewalls will be more effective for reducing the propagation of noise from within buildings than roof-mounted units, as the noise can be better absorbed by the building structure or by the earth or vegetation.

For poultry farms, low-level fans can also facilitate dust control, but they may be less effective at dispersing odour than high-level fans.

System resistance affects fan and ventilation system performance. Fan installations should be designed with adequate inlet and outlet areas to ensure optimum performance. An efficient design will enable the minimum number of fans to be employed in ventilating the buildings.

Fan outlet cowls and stacks provide some noise reduction capability. They should be rigidly constructed of timber or purpose-built pre-fabricated plastic or GRP. The use of un-stiffened sheet metal, which can vibrate, should be avoided.

The characteristics of a building structure affect the noise pattern. The build up of noise in and around a building is determined by its absorption properties. Smooth reflective surfaces cause noise levels to build by multiple reflection. By contrast, rough surfaces, such as straw bales, absorb sound.

Woodland and hedges absorb noise from pig farm buildings. A deep belt of tree planting will both reduce noise and mask noise generated by the wind. Noise reduction is relatively low at about 2 dB for 30 m of plantation.

By operational measures:

For the minimum required ventilation of poultry housing, a small number of fans operating continuously is less noticeable than a large number of fans operating intermittently to achieve the same ventilation rate. An increase of 3 dB as a result of twice as many fans running will be highly significant with night-time background noise levels below 30 dB.

**Achieved environmental benefits:** See Table 4.39.

Category	Reduction measure	Reduction effect (dB(A))
Technical	natural ventilation	variable
	low-noise fans	n.d.
	application of silencers	n.d.
Design and construction	low-level sidewalls	n.d.
	hedge/vegetation barrier	2
Operational	small number/continuous operation	3
<i>n.d. : no data</i>		

**Table 4.39: Reducing effect of different noise measures**

**Cross-media effects:** The application of low-noise fans, design measures to reduce airflow resistance, and operational measures (intermittent operation) can all reduce energy consumption. However, low-level wall-mounted fans are considered to be less efficient than roof-mounted fans so additional fan capacity would be required. In addition, it was reported that low-level wall-mounted fans create more odour around the unit than roof-mounted fans with “rain-rings”.

**Applicability:** New piggery and new poultry developments should take account at the design stage of the noise control benefits of low-level and side-mounted fans and of acoustic barriers. The applicability of natural ventilation systems should also be considered.

**Reference literature:** [68, ADAS, 1999] and [69, ADAS, 1999]

#### 4.11.2 Control of noise from discontinuous on-farm activities

**Description:** Many on-farm activities are carried out in a discontinuous way. Measures to reduce noise emissions from these activities generally relate to proper timing and careful location of the activity on site. The measures apply to the following activities:

##### Feed preparation:

On-farm milling and mixing feed preparation plants are a source of noise. Typical external noise levels of 63 dB(A) have been measured, with mills giving particular cause for concern. Mills are often automated so that they can be used during the night hours to reduce operating costs by using lower cost “off-peak” night rate electricity. If complaints are likely then this option should be reconsidered. There may be a need to consider housing mills and other noisy equipment within an acoustically insulated enclosure or building. Mills which use mechanical rather than pneumatic meal transfer systems are likely to be both quieter and substantially more energy efficient.

The main noise-generating units, such as hammer mills and pneumatic conveyors, should be operated at times when background noise is known to be highest.

##### Use of feed conveying equipment:

Pneumatic conveyors generate high-pitched noise. Noise can be minimised by minimising the length of the delivery pipe runs so that the installed power is low. Low-capacity systems, which operate for longer, are likely to generate less overall noise than large, high output units.

Conveyors, including augers, are quietest when full of material. Avoid conveyors or augers running empty.

##### Feed delivery:

Many units do not prepare feed on site. Feed delivered to a site is usually pneumatically conveyed into holding bins. Noise from feed delivery vehicles comes from:

- vehicles moving around the site
- pneumatic conveying equipment.

The impact of these sources of noise can be minimised by:

1. locating feed bins or feed storage silos as far away as practical from residential and other sensitive properties
2. organising feed bin locations to reduce delivery vehicle movement on site
3. avoiding long conveyor distances, and minimising the number of bends on fixed pipes so that the maximum unloading rates can be achieved (to minimise noise duration).

### Feeding operations on pig units:

Noise levels within pig buildings can be very high. As an example, peak noise levels of 97 dB and higher have been measured from excited stock in anticipation of feeding. This excitement is often associated with manual feeding or noisy conveyor systems delivering feed at feeding time. These peaks of animal noise can be reduced by the use of appropriate mechanical feeding systems. If stock are to be hand fed then they should be in small batches (separate from other batches) or, if noise is inevitable, stock should be fed at times of higher background noise levels.

Feeders can be used that have holding hoppers, which can be filled at a different time from feeding. The hopper is then emptied instantly at the programmed feeding time so the pigs have no pre-feeding stimulus to create excitement and noise.

Passive ad lib feeders can be used for some classes of stock and they greatly reduce stress and minimise noise. For new feeding equipment installations this should be considered as the preferred option.

For sites where feeding noise still causes a problem, it is essential that, where practical, all doors and other major openings of the pig buildings are closed at feeding time.

### Fuel delivery:

To reduce the effect of noise from the delivery tanker, fuel storage tanks should be located as far away as practical from other property such as residential housing. Locating fuel storage tanks at a position where the livestock buildings lie between gas/oil storage and other property can reduce sound propagation.

### Manure and slurry handling on pig farms:

1. scraped manure systems often include a large number of opening gates along scraped passages. These gates and others to which pigs have access should be designed and maintained so that the pigs are unable to rattle gates and their fittings
2. covered scraped dunging areas indoors should present fewer problems because scraper tractor noise is contained within the structure
3. scraped areas outside the buildings should be kept to a minimum to help reduce noise from scraper tractors operating outside
4. slurry and manure storage areas should ideally be located at the end of the site furthest away from nearby dwellings. The building layout should, where practical, be organised so that slurry tanker filling points are located on the side of buildings away from the site boundary or residential property. This uses the effect of distance and the sound reducing qualities of the building to absorb and deflect the noise
5. pressure washers and compressors generate considerable noise and should normally be used inside buildings. Their use outside, e.g. to clean vehicles, should be avoided on sensitive sites. Wherever possible, machinery should be washed under cover and in locations away from residential housing and other sensitive properties.

Manure and slurry handling on poultry farms:

1. when cleaning out poultry buildings, some loader noise is contained within the building. The movement and manoeuvring of loaders filling trailers outside the building should be organised to minimise the amount of machinery movement. If there is sufficient headroom, trailers should be loaded inside the building
2. always ensure that loaders and tractors are well maintained. Particular attention should be given to vehicle exhaust systems and silencers
3. the instruction and training of staff in the operation of loaders can significantly reduce machinery noise
4. for new buildings, consider their orientation and placement with regard to manure and product handling so that, where practical, machinery movement is concentrated at the ends of buildings furthest away from other property such as residential housing
5. on some egg production units, manure is conveyed directly to a separate storage building. This enables trailers to be loaded mainly within the building
6. conveyors used for manure handling are a source of noise, emitting squeaks and clicks. They should be located within the building structure as much as possible. Where they pass between buildings the length of run should be as short as possible and the provision of sound absorbing barriers such as straw bales or more permanent panelling should be considered. Fully loaded conveyors reduce vibration and noise. They should not be allowed to run empty
7. pressure washers and compressors generate considerable noise and should normally be used inside buildings. Their use outside, to clean vehicles, should be avoided on sensitive sites. Wherever possible, machinery should be washed under cover and in locations away from residential housing and other sensitive properties.

**Cross-media effects:** Some measures are also expected to reduce energy requirements.

**Applicability:** In the case of new farms, many of the siting measures can be applied as part of the site planning. In that case use should be made of any natural contours. For existing systems the relocation of activities may technically be possible for some activities only, but relocation of large constructions, such as animal housing, may be constrained as it requires relatively high investments.

Measures related to operator's practice and timing can be applied at any time, for both new and existing farms.

**Reference literature:** [68, ADAS, 1999] and [69, ADAS, 1999].

### 4.11.3 Application of noise barriers

**Description:** Control of noise from a site can be achieved by the use of barriers. These are most effective against high frequency noise. Long wavelength, low frequency noise will pass around or over the barriers. Barriers must be absorptive of the noise, otherwise it will be reflected.

Earth banks can be used to combine the effect of barriers with the absorption of vegetation, and can be useful when constructed along the boundaries of pig units. Straw bales can be used to provide a tall, effective, temporary noise barrier because of their thickness and mass, and because of their absorptive surfaces. Straw bales should not be used in or near pig buildings where they may increase the risks of fire or where the consequences of a fire would be a greater

danger to pigs or farm workers. Tall, solid, wooden fences reduce noise propagation. These can be sited on top of earth banks to increase the overall height of the obstacle.

**Achieved environmental benefits:** The achievable reduction depends on the type of barrier.

**Applicability:** Barriers can be applied in any situation. The local situation will determine, whether a structural barrier, such as wooden fences or earth banks, can be applied.

**Reference literature:** [68, ADAS, 1999] and [69, ADAS, 1999].

### 4.12 Techniques for the treatment and disposal of residues other than manure and carcasses

The types of residues that arise on intensive livestock farms and the ways in which these residues are being treated have been described in Section 2.10. In several reports waste management refers to the separation of residues into categories that can be re-used, treated on the farm, or that finally have to be disposed of. Residues that must be disposed of elsewhere can be further separated, allowing treatment off-site. An important requirement for such a waste management plan is a cost-effective way of collecting and removing residues.

Wastes can be divided into two categories:

- liquid residues
- solid residues.

#### 4.12.1 Treatment of liquid residues

With respect to liquid residues, the mixing of waste water with slurry followed by further treatment or separate treatment through low rate irrigation is common practice. The reduction of emissions from those techniques is described in Section 4.10.

A few actions can be applied to reduce the amount and harmfulness of waste water on a farm. Precipitation water from uncovered exercise yards, outdoor feeding areas and dung slabs should be collected and used. When dimensioning the storage capacity for liquid manure and dung water, the volume of precipitation water to be taken into account has to match the average precipitation volumes and the size of the areas involved, less any evaporative loss. Uncontaminated precipitation water from roofs and roadways can, as a rule, be allowed to soak away locally or be discharged into drainage ditches or main outfalls. Any possibilities for re-use (such as cleaning) involving collection and separate storage could be considered.

Domestic waste water and sanitation waste water (washing and shower water, toilet and kitchen waste water) can either be discharged via the local sewerage system or collected and subsequently transported away or otherwise treated (e.g. in plant-based sewage treatment facilities) followed by direct discharge into surface waters.

By extensively employing dry cleaning methods with a subsequent use of jet cleaners, water consumption and waste water accumulation can be significantly reduced.

Only allowing the use of tested cleaning agents and disinfectants can reduce the harmfulness of waste water.



## 4.12.2 Treatment of solid residues

**Description:** There are various ways to dispose of solid residues. In general, the burning of residues (packaging material and plastics) in the field, although still allowed in many places, is not considered an environmentally sound technique. Incineration is a difficult process to control and temperatures may not reach the levels required for proper incineration, resulting in air emissions of substances associated with incomplete burning (e.g. cancerous substances). It may be an option to burn the residues to provide energy for heating, but no data have been submitted allowing an assessment of this. The burning of plastics, rubber, tyres and other materials in the open should not be allowed.

On-farm burying or landfilling of residues is also widely practised and may be an option in the short term, but may not serve this purpose in the long term. Soil and groundwater contamination may occur, depending on the characteristics of the residues that are being buried. Initial cost savings may then turn into a financial burden, i.e. for cleaning and renovation of the site. Residues that are buried include building materials, such as asbestos cement roof sheets.

There is an awareness that both burning in the open and burying may still be the only options for some residues in the absence of adequate alternative means of disposal. It is expected that these practices will have to end due to environmental regulation.

It is suggested that the so-called Best Practicable Environmental Option (BPEO) be followed. This approach follows the waste hierarchy framework (reduction, re-use, recovery, disposal) and it applies principles of proximity (treatment of waste as close as possible) and of precaution (immediate application of cost-effective measures to prevent environmental degradation).

Within this framework the following on-farm options have been reviewed:

- re-use of residues
- composting of residues
- energy recovery.

Re-use focuses on re-usable or refillable packaging. Possibilities for the on-farm composting of residues other than manure appear very limited; with secondary cardboard packaging having the most opportunity. Energy recovery includes the already applied oil burners, but other materials may be applied with the new developing energy recovery technologies. Techniques typically applied on intensive poultry and pig farms have not been reported.

**Achieved environmental benefits:** There will be various environmental benefits but these depend on the type of residue and the way it is treated. Options for re-use, collection or central treatment will reduce the necessity to burn or landfill the residues or to stockpile residues pending collection (which may give rise to problems such as odour and soil contamination through run-off liquid).

**Applicability:** In the application of best practicable environmental options farmers will depend on the availability of a suitable infrastructure logistic to dispose of non-usable residues or residues that cannot be re-used on farm.

Lack of information, low awareness and high equipment costs currently make application of the suggested on-farm residue treatment techniques difficult. It is reported that more research and development will be needed to increase applicability.

**Costs:** Some costs are associated with the treatment techniques applied. In particular, incineration and landfill of residues will have to observe increasing legislative requirements that will raise the costs of applying and operating these techniques.

Costs for other ways of disposal or recovery include:

- collection and transport costs
- disposal and recovery costs
- landfill tax (if disposed by landfill).

Costs to the farmer will depend on a number of factors including:

- farm location and distance to suitable facilities
- quantity of the residues
- nature and classification of the residues
- final treatment method
- market demand for secondary materials.

**Driving force for implementation:** It is expected that agricultural residues will increasingly be considered as industrial waste. Requirements laid down in various directives concerning waste, such as the EU Landfill Directive and the Waste Incineration Directive, will form major forces to change the treatment of agricultural residues.

Other forces that drive the change in the treatment of residues are considered to be the demands from retailers and consumers, growing public concern about the environmental and human health impacts of products, increasing costs for disposal, and developing EU Directives applying the 'polluter pays' principle.

**Reference literature:** Most of the information can be found in a UK report presenting ways towards sustainable agricultural waste management [147, Bragg S and Davies C, 2000].

## 5 BEST AVAILABLE TECHNIQUES

In understanding this chapter and its contents, the attention of the reader is drawn back to the preface of this document and in particular the fifth section of the preface: “How to understand and use this document”. The techniques and associated emission and/or consumption levels, or ranges of levels, presented in this chapter have been assessed through an iterative process involving the following steps:

- identification of the key environmental issues for the sector: ammonia emissions to air, nitrogen and phosphorus emissions to soil, to surface water and groundwater and associated environmental aspects, such as emissions of odour and dust and the use of energy and water
- examination of the techniques most relevant to address those key issues
- identification of the best environmental performance levels, on the basis of the available data in the European Union and worldwide. A characteristic of this sector is that few parameters are routinely monitored with respect to environmental emissions. Typically the level of ammonia has been used as a measurable indicator to assess the effectiveness of a technique. In assessing BAT however, the TWG considered many other potential environmental impacts, using their expert judgement where data was not available
- examination of the conditions under which these performance levels were achieved; such as costs, cross-media effects, main driving forces involved in implementation of these techniques
- selection of the best available techniques (BAT) and the associated emission and/or consumption levels for this sector in a general sense, all according to Article 2(11) and Annex IV of the Directive.

Expert judgement by the European IPPC Bureau and the relevant Technical Working Group (TWG) has played a key role in each of these steps and in the way in which the information is presented here.

On the basis of this assessment, techniques, and as far as possible emission and consumption levels associated with the use of BAT, are presented in this chapter that are considered to be appropriate to the sector as a whole and in many cases reflect current performance of some installations within the sector. Where emission or consumption levels “associated with best available techniques” are presented, this is to be understood as meaning that those levels represent the environmental performance that could be anticipated as a result of the application, in this sector, of the techniques described, bearing in mind the balance of costs and advantages inherent within the definition of BAT. However, they are neither emission nor consumption limit values and should not be understood as such. In some cases it may be technically possible to achieve better emission or consumption levels but due to the costs involved or cross-media considerations, they are not considered to be appropriate as BAT for the sector as a whole. However, such levels may be considered to be justified in more specific cases where there are special driving forces.

The emission and consumption levels associated with the use of BAT have to be seen together with any specified reference conditions (e.g. averaging periods).

The concept of “levels associated with BAT” described above is to be distinguished from the term “achievable level” used elsewhere in this document. Where a level is described as “achievable” using a particular technique or combination of techniques, this should be understood to mean that the level may be expected to be achieved over a substantial period of time in a well maintained and operated installation or process using those techniques.

Where available, data concerning costs have been given together with the description of the techniques presented in the previous chapter. These give a rough indication about the magnitude of costs involved. However, the actual cost of applying a technique will depend strongly on the specific situation regarding, for example, taxes, fees, and the technical characteristics of the

installation concerned. It is not possible to evaluate such site-specific factors fully in this document. In the absence of data concerning costs, conclusions on economic viability of techniques are drawn from observations on existing installations.

It is intended that the general BAT in this chapter are a reference point against which to judge the current performance of an existing installation or to judge a proposal for a new installation. In this way they will assist in the determination of appropriate "BAT-based" conditions for the installation or in the establishment of general binding rules under Article 9(8). It is foreseen that new installations can be designed to perform at or even better than the general BAT levels presented here. It is also considered that existing installations could move towards the general BAT levels or do better, subject to the technical and economic applicability of the techniques in each case.

While the BREFs do not set legally binding standards, they are meant to give information for the guidance of industry, Member States and the public on achievable emission and consumption levels when using specified techniques. The application of techniques and the appropriate limit values for any specific case will need to be determined taking into account the objectives of the IPPC Directive and the local considerations.

In order to complement this general introduction, the paragraphs below introduce the sector-specific issues, the assessment of BAT, and will give guidance on how to read this chapter.

The main environmental impacts relate to ammonia emissions to air, and nitrogen and phosphorus emissions to soil, to surface water and groundwater, and result from the manure from the animals. Measures to decrease these emissions are not limited to how to store, treat or apply the manure once it arises, but comprise measures throughout a whole chain of events, including steps to minimise the production of manure. This starts with good housekeeping and measures in feeding and housing, followed by the treatment and the storage of manure, and finally the spreading on land. To prevent the benefits of a measure taken in the beginning of the chain being cancelled out by poor handling of the manure further down the chain, it is important to apply the concept of BAT.

The concept of BAT for a farm means always applying good agricultural practice and nutritional measures together with BAT in housing design. Additionally, BAT in the reduction of water and energy use can also be relevant. Storage of manure and on-farm manure processing are sources of emissions where applying BAT will result in an important reduction in emissions. Even after applying nutritional measures and on-farm manure processing there will still be manure (i.e. treated manure) left that is normally spread on land. For this activity BAT includes management tools and choice of equipment. However, given the variance in local climate across the Community and coupled with local preferences for breeds and finishing weights of the animals in question, there is some doubt over whether a housing technique well developed in one country will be equally viable or effective in another. It is a fact of this sector that many housing systems are developed and tested within single countries only and have not been assessed outside that country. It would be scientifically wrong to assume that some techniques could achieve equal performance across the whole Community.

A characteristic in this sector is that the design and operation of the animal housing system is itself a fundamental technique which also contributes to the overall environmental performance. When refurbishing existing buildings, the currently applied housing system will affect the choice of new techniques which can be applied. Changing from one housing system to another usually means a complete substitution of the system, but usually only minor changes to the building in which the system is installed would be needed. Typically the housing system is a long-term investment and this has to be considered when prioritising the implementation of BAT in every case.

Under the framework of the exchange of information a subgroup of the TWG worked out a methodology for assessing BAT for intensive livestock farming systems (see Annex 7.7). This

methodology should be considered as a first attempt to identify BAT in a general sense. The methodology has been applied as far as possible to arrive at the BAT conclusions detailed in this chapter.

The following considerations underpin the assessment of techniques:

- there is only limited data available
- animal welfare aspects<sup>1</sup> are respected, but the focus of the evaluation is on environmental performance
- investment costs are of only limited use to the evaluation; annual operational costs would provide more information as they generally include depreciation cost. However costs have not always been reported or clearly justified. This shortfall precluded a full financial evaluation
- additional requirements in terms of energy and labour to operate a system should be acceptable if a technique is proposed as BAT.

In the subsequent three sections (Sections 5.1 – 5.3) of this chapter, the BAT conclusions for the intensive rearing of pigs and poultry are described. Section 5.1 deals with generic BAT conclusions on good agricultural practice that are generally applicable to both sectors; pigs and poultry. Section 5.2 describes the general BAT conclusions for the pig sector and Section 5.3 describes the general BAT conclusions for the poultry sector. Sections 5.2 and 5.3 have the same structure and describe BAT conclusions on:

- nutritional techniques
- air emissions from housing
- water
- energy
- manure storage
- on-farm manure processing, and
- techniques for landspreading of manure.

## 5.1 Good agricultural practice in the intensive rearing of pigs and poultry

Good agricultural practice is an essential part of BAT. Although it is difficult to quantify environmental benefits in terms of emission reductions or reductions in the use of energy and water, it is clear that conscientious farm management will contribute to an improved environmental performance of an intensive poultry or pig farm.

For improving the general environmental performance of an intensive livestock farm, BAT is to do all of the following:

- identify and implement education and training programmes for farm staff (Section 4.1.2)
- keep records of water and energy usage, amounts of livestock feed, waste arising and field applications of inorganic fertiliser and manure (Section 4.1.4)
- have an emergency procedure to deal with unplanned emissions and incidents (Section 4.1.5)
- implement a repair and maintenance programme to ensure that structures and equipment are in good working order and that facilities are kept clean (Section 4.1.6)
- plan activities at the site properly, such as the delivery of materials and the removal of products and waste (Section 4.1.3), and
- plan the application of manure to land properly (Section 4.1.3).

---

<sup>1</sup> Community legislation in particular prohibits to keep animals in permanent darkness

With respect to applying manure to land properly, detailed BAT conclusions are shown below.

The Nitrate Directive lays down minimum provisions on the application of manure to land with the aim of providing all waters a general level of protection against pollution from nitrogen compounds, and additional provisions for applying manure to land in designated vulnerable zones. Not all provisions in this Directive are addressed in this document because of a lack of data, but when they are addressed, the TWG agreed that BAT on landspreading is equally valid inside and outside these designated vulnerable zones.

There are different stages in the process, from pre-production of the manure, to post-production and finally spreading on land, where emissions can be reduced and/or controlled. The different techniques that are BAT and that can be applied at the different stages in the process are listed below. However, the principle of BAT is based on doing all the following four actions:

- applying nutritional measures
- balancing the manure that is going to be spread with the available land and crop requirements and – if applied – with other fertilisers
- managing landspreading of manure, and
- only using the techniques that are BAT for the spreading of manure on land and – if applicable – finishing off.

These principles are elaborated in further detail below.

BAT is to apply nutritional measures at source by feeding pigs and poultry lower amounts of nutrients; see Sections 5.2.1 and 5.3.1.

BAT is to minimise emissions from manure to soil and groundwater by balancing the amount of manure with the foreseeable requirements of the crop (nitrogen and phosphorus, and the mineral supply to the crop from the soil and from fertilisation). Different tools are available to balance the total nutrient uptake by soil and vegetation against the total nutrient output of the manure, such as a soil nutrient balance or by rating the number of animals to the available land.

BAT is to take into account the characteristics of the land concerned when applying manure; in particular soil conditions, soil type and slope, climatic conditions, rainfall and irrigation, land use and agricultural practices, including crop rotation systems.

BAT is to reduce pollution of water by doing in particular all of the following:

- not applying manure to land when the field is:
  - water-saturated
  - flooded
  - frozen
  - snow covered
- not applying manure to steeply sloping fields
- not applying manure adjacent to any watercourse (leaving an untreated strip of land), and
- spreading the manure as close as possible before maximum crop growth and nutrient uptake occur.

BAT is managing the landspreading of manure to reduce odour nuisance where neighbours are likely to be affected, by doing in particular all of the following:

- spreading during the day when people are less likely to be at home and avoiding weekends and public holidays, and
- paying attention to wind direction in relation to neighbouring houses.

Manure can be treated to minimise odour emissions which can then allow more flexibility for identifying suitable sites and weather conditions for land application.

BAT concerning the equipment for landspreading pig manure and poultry manure is discussed in Sections 5.2.7 and 5.3.7 respectively.

## 5.2 Intensive rearing of pigs

BAT for improving the general environmental performance of an intensive livestock farm is described in Section 5.1 “Good agricultural practice in the intensive rearing of pigs and poultry.”

### 5.2.1 Nutritional techniques

Preventive measures will reduce the amounts of nutrients excreted by the animals and thereby reduce the need for curative measures further down the production cycle. The following nutritional BAT are therefore preferably applied before downstream BAT.

Nutritional management aims at matching feeds more closely to animal requirements at various production stages, thus decreasing the wasted nutrient excretion in the manure.

Feeding measures cover a wide variety of techniques that can be implemented individually or simultaneously to achieve the highest reduction of nutrient output.

Feeding measures include phase-feeding, formulating diets based on digestible/available nutrients, using low protein amino acid-supplemented diets (see Section 4.2.3) and using low phosphorus phytase-supplemented diets (see Section 4.2.4) and/or highly digestible inorganic feed phosphates (see Section 4.2.5). Furthermore the use of feed additives described in Section 4.2.6 may increase feed efficiency, thereby improving nutrient retention and diminishing the amount of nutrients left over in the manure.

Further techniques are currently being investigated (e.g. sex-feeding, further reduction of dietary protein and/or phosphorus contents) and might be additionally available in the future.

#### 5.2.1.1 Nutritional techniques applied to nitrogen excretion

BAT is to apply feeding measures.

As far as nitrogen and consequently nitrates and ammonia outputs are concerned, a basis for BAT is to feed animals with successive diets (phase-feeding) with lower crude protein contents. These diets need to be supported by an optimal amino acid supply from adequate feedstuffs and/or industrial amino acids (lysine, methionine, threonine, tryptophan, see Section 4.2.3).

A crude protein reduction of 2 to 3 % (20 to 30 g/kg of feed) can be achieved depending on the breed/genotype and the actual starting point. The resulting range of dietary crude protein contents is reported in Table 5.1. The values in the table are only indicative, because they, amongst others, depend on the energy content of the feed. Therefore levels may need to be adapted to local conditions. Research on further applied nutrition is currently being carried out in a number of Member States and may support further possible reductions in the future, depending on the effects of changes in genotypes.

Species	Phases	Crude protein content (% in feed)	Remark
Weaner	<10 kg	19 – 21	With adequately balanced and optimal digestible amino acid supply
Piglet	<25 kg	17.5 – 19.5	
Fattening pig	25 – 50 kg	15 – 17	
	50 – 110 kg	14 – 15	
Sow	gestation	13 – 15	
	lactation	16 – 17	

**Table 5.1: Indicative crude protein levels in BAT-feeds for pigs**

### 5.2.1.2 Nutritional techniques applied to phosphorus excretion

BAT is to apply feeding measures.

As far as phosphorus is concerned, a basis for BAT is to feed animals with successive diets (phase-feeding) with lower total phosphorus contents. In these diets, highly digestible inorganic feed phosphates and/or phytase must be used in order to guarantee a sufficient supply of digestible phosphorus.

A total phosphorus reduction of 0.03 to 0.07 % (0.3 to 0.7 g/kg of feed) can be achieved depending on the breed/genotype and the actual starting point by the application of highly digestible inorganic feed phosphates and/or phytase in the feed. The resulting range of dietary total phosphorus contents is reported in Table 5.2. The values in the table are only indicative, because they, amongst others, depend on the energy content of the feed. Therefore levels may need to be adapted to local conditions. Further applied nutrition research is currently being carried out in a number of Member States and may support further possible reductions in the future, depending on the effects of changes in genotypes.

Species	Phases	Total phosphorus content (% in feed)	Remark
Weaner	<10 kg	0.75 – 0.85	With adequate digestible phosphorus by using e.g. highly digestible inorganic feed phosphates and/or phytase
Piglet	<25 kg	0.60 – 0.70	
Fattening pig	25 – 50 kg	0.45 – 0.55	
	50 – 110 kg	0.38 – 0.49	
Sow	gestation	0.43 – 0.51	
	lactation	0.57 – 0.65	

**Table 5.2: Indicative total phosphorus levels in BAT-feeds for pigs**

### 5.2.2 Air emissions from pig housing

A number of general points are made concerning the evaluation of pig housing which are followed by a detailed description of BAT for mating and gestating sows, growers/finishers, farrowing sows and weaners.

Designs to reduce ammonia emissions to air from pig housing systems, as presented in Chapter 4, basically involve some or all of the following principles:

- reducing emitting manure surfaces
- removing the manure (slurry) from the pit to an external slurry store
- applying an additional treatment, such as aeration, to obtain flushing liquid
- cooling the manure surface
- using surfaces (for example, of slats and manure channels) which are smooth and easy to clean.



Concrete, iron and plastic are used in the construction of slatted floors. Generally speaking and given the same slat width, manure dropped on concrete slats takes longer to fall into the pit than when using iron or plastic slats and this is associated with higher emissions of ammonia. It is worth noting that iron slats are not allowed in some Member States.

Frequent removal of manure by flushing with slurry may result in a peak in odour emissions with each flush. Flushing is normally done twice a day; once in the morning and once in the evening. These peaks in odour emissions can cause a nuisance to neighbours. Additionally treatment of the slurry also requires energy. These cross-media effects have been taken into account in defining BAT on the various housing designs.

With respect to litter (typically straw), it is expected that the use of litter in pig housing will increase throughout the Community due to a raised awareness of animal welfare. Litter may be applied in conjunction with (automatically-controlled) naturally ventilated housing systems, where litter would protect the animals for low temperatures, and thus require less energy for ventilation and heating. In systems where litter is used, the pen can be divided into a dunging area (without litter) and a littered solid floor area. It is reported that pigs do not always use these areas in the correct way, i.e. they dung in the littered area and use the slatted- or solid dunging area to lie on. However, the pen design can influence the behaviour of the pigs, although it is reported that in regions with a warm climate this might not be sufficient to prevent the pigs dunging and lying in the wrong areas. The argument for this is that in a full litter system the pigs do not have the possibility of cooling down by lying on an uncovered floor.

An integrated evaluation of litter use would include the extra costs for litter supply and mucking out as well as the possible consequences on the emissions from storage of manure and for the application onto land. The use of litter results in solid manure which will increase the organic matter of the soils. In some circumstances therefore this type of manure is beneficial to soil quality; this is a very positive cross-media effect.

### **5.2.2.1 Housing systems for mating/gestating sows**

Currently mating and gestating sows can be housed either individually or in a group. However, EU legislation on pig welfare (91/630/EEC) provides minimum standards for the protection of pigs and will require sows and gilts to be kept in groups, from 4 weeks after service to 1 week before the expected time of farrowing, for new or rebuilt houses from 1 January 2003, and from 1 January 2013 for existing housing.

Group-housing systems require different feeding systems (e.g. electronic sow feeders) to individual housing systems, as well as a pen design that influences sow behaviour (i.e. the use of dunging- and lying areas). However, from an environmental point of view, the submitted data (Section 4.6) seems to indicate that group-housing systems have similar emission levels to individual housing systems, if similar emission reduction techniques are applied.

In the same EU legislation on pig welfare as mentioned above (Council Directive 2001/88/EC amending 91/630/EEC), requirements for flooring surfaces are included. For gilts and pregnant sows, a specified part of the floor area must be continuous solid floor of which a maximum of 15 % is reserved for drainage openings. These new provisions apply to all newly built or rebuilt holdings from 1 January 2003, and to all holdings from 1 January 2013. The effect of these new flooring arrangements on emissions compared to a typical existing fully slatted floor (which is the reference system) has not been investigated. The maximum 15 % void for drainage in the continuous solid floor area is less than the 20 % void for the concrete slatted floor area in the new provisions (a maximum 20 mm gap and a minimum slat width of 80 mm for sows and gilts). Therefore the overall effect is to reduce the void area.

In the following section on BAT, techniques are compared against a specific reference system. The reference system (described in Section 4.6.1) used for the housing of mating and gestating sows is a deep pit under a fully-slatted floor with concrete slats. The slurry is removed at frequent or infrequent intervals. Artificial ventilation removes gaseous components emitted by the stored slurry manure. The system has been applied commonly throughout Europe.

### **BAT is:**

- a fully- or partly-slatted floor with vacuum system for frequent slurry removal (Sections 4.6.1.1 and 4.6.1.6, or
- a partly-slatted floor and a reduced manure pit (Section 4.6.1.4).

It is generally accepted that concrete slats give more ammonia emissions than metal or plastic slats. However, for the BAT mentioned above no information was available on the effect of different slats on the emissions or costs.

### **Conditional BAT**

‘New to build housing systems with a fully- or partly-slatted floor and flush gutters or tubes underneath and flushing is applied with non-aerated liquid (Sections 4.6.1.3 and 4.6.1.8)’ are conditional BAT. In instances where the peak in odour, due to the flushing, is not expected to give nuisance to neighbours these techniques are BAT for new to build systems. In instances where this technique is already in place, it is BAT (without condition).

### **BAT for housing systems that are already in place**

‘A housing system with manure surface cooling fins using a closed system with heating pumps (Section 4.6.1.5)’ performs well but is a very costly system. Therefore manure surface cooling fins are not BAT for new to build housing systems, but when it is already in place, it is BAT. In retrofit situations this technique can be economically viable and thus can be BAT as well, but this has to be decided on a case by case basis.

‘Partly-slatted floor systems with a manure scraper underneath (Section 4.6.1.9)’ generally perform well, but the operability is difficult. Therefore a manure scraper is not BAT for new to build housing systems, but it is BAT when the technique is already in place.

‘Fully- or partly-slatted floor systems and flushing gutters or tubes underneath with flushing applied with non-aerated liquid (Sections 4.6.1.3 and 4.6.1.8)’ is, as already mentioned earlier, BAT when it is already in place. The same technique operated with aerated liquid is not BAT for new to build housing systems because of odour peaks, energy consumption and operability. However, in instances where this technique is already in place, it is BAT.

### **Split view of one MS**

One Member State supports the conclusions on BAT, but in their view the following techniques are also BAT in instances where the techniques are already in place and are also BAT when an extension (by means of a new building) is planned to operate with the same system (instead of two different systems):

- a fully- or partly-slatted floor with flushing of a permanent slurry layer in channels underneath with non-aerated or aerated liquid (Sections 4.6.1.2 and 4.6.1.7)

These systems, often applied in this Member State, can achieve a higher ammonia emission reduction than those systems previously identified as BAT (Sections 4.6.1.1, 4.6.1.6 and 4.6.1.4) or conditional BAT (Sections 4.6.1.3 and 4.6.1.8). The argument then is that the high cost of retrofitting existing systems by any of these BATs is not justified. When an extension is added, for example by means of a new building, to a plant already adopting these systems,

implementation of BAT or conditional BAT would reduce operability by making the operator use two different systems at the same farm. Therefore, the Member State considers these systems are BAT because of their good emission reduction capability, their operability and cost considerations.

### **Littered systems**

On systems using litter very variable emission reduction potentials are reported to date, and further data must be acquired to allow better guidance on what is BAT for litter based systems. However, the TWG concluded that when litter is used, along with good practices such as having enough litter, changing the litter frequently, designing the pen floor suitably, and creating functional areas, then they cannot be excluded as BAT.

#### **5.2.2.2 Housing systems for growers/finishers**

Growers/finishers are always housed in a group and most of the systems for group housing of sows apply here as well.

In the following section on BAT, techniques are compared against a specific reference system. The reference system for growers/finishers is a fully-slatted floor with a deep manure pit underneath and mechanical ventilation (Section 2.3.1.4.1).

#### **BAT is:**

- a fully-slatted floor with a vacuum system for frequent removal (Section 4.6.1.1), or
- a partly-slatted floor with a reduced manure pit, including slanted walls and a vacuum system (Section 4.6.4.3), or
- a partly-slatted floor with a central, convex solid floor or an inclined solid floor at the front of the pen, a manure gutter with slanted sidewalls and a sloped manure pit (Section 4.6.4.2).

It is generally accepted that concrete slats give more ammonia emissions than metal or plastic slats. However, the reported emission data show only a difference of 6 %, but the costs are significantly higher. Metal slats are not allowed in every Member State and they are not suitable for very heavy pigs.

#### **Conditional BAT**

‘New to build housing systems with a fully- or partly-slatted floor and flush gutters or tubes underneath and flushing is applied with non-aerated liquid (Sections 4.6.1.3 and 4.6.1.8)’ are conditional BAT. In instances where the peak in odour, due to the flushing, is not expected to give nuisance to neighbours these techniques are BAT for new to build systems. In instances where this technique is already in place, it is BAT (without condition).

#### **BAT for housing systems that are already in place**

‘A housing system with manure surface cooling fins using a closed system with heating pumps (4.6.1.5)’ performs well but is a very costly system. Therefore manure surface cooling fins are not BAT for new to build housing systems, but when it is already in place, it is BAT. In retrofit situations this technique can be economically viable and thus can be BAT as well, but this has to be decided on a case by case basis. It has to be noted that energy efficiency can be lower in situations where the heat that arises from the cooling is not used, e.g. because there are no weaners to be kept warm.

‘Partly-slatted floor systems with a manure scraper underneath (4.6.1.9)’ generally perform well, but the operability is difficult. Therefore a manure scraper is not BAT for new to build housing systems, but it is BAT when the technique is already in place.

'Fully- or partly-slatted floor systems and flushing gutters or tubes underneath with flushing applied with non-aerated liquid (Sections 4.6.1.3 and 4.6.1.8)' is, as already mentioned earlier, BAT when it is already in place. The same technique operated with aerated liquid is not BAT for new to build housing systems because of odour peaks, energy consumption and operability. However, in instances where this technique is already in place, it is BAT.

### **Split view of one MS**

One Member State supports the conclusions on BAT, but in their view the following techniques are also BAT in instances where the techniques are already in place and are also BAT when an extension (by means of a new building) is planned to operate with the same system (instead of two different systems):

- a fully- or partly-slatted floor with flushing of a permanent slurry layer in channels underneath with non-aerated or aerated liquid (Sections 4.6.1.2 and 4.6.1.7).

These systems, often applied in this Member State, can achieve a higher ammonia emission reduction than those systems previously identified as BAT or conditional BAT (Sections 4.6.1.3 and 4.6.1.8). The argument then is that the high cost of retrofitting existing systems by any of these BATs is not justified. When an extension is added, for example by means of a new building, to a plant already adopting these systems, implementation of BAT or conditional BAT would reduce operability by making the operator use two different systems at the same farm. Therefore, the Member State considers these systems are BAT because of their good emission reduction capability, their operability and cost considerations.

### **Littered systems**

On systems using litter very variable emission reduction potentials are reported to date, and further data must be acquired to allow better guidance on what is BAT for litter based systems. However, the TWG concluded that when litter is used, along with good practices such as having enough litter, changing the litter frequently, designing the pen floor suitably, and creating functional areas, then they cannot be excluded as BAT.

The following system is an example of what may be BAT:

- a solid concrete floor with littered external alley and a straw flow system (Section 4.6.4.8).

### **5.2.2.3 Housing systems for farrowing sows (including piglets)**

Farrowing sows in Europe are generally housed in crates with iron and/or plastic slatted floors. In the majority of the houses sows are confined in their movement, with piglets walking around freely. Most houses have controlled ventilation and often a heated area for the piglets during the first few days. This system with a deep manure pit underneath is the reference system (Section 2.3.1.2.1).

The difference between fully- and partly-slatted floors is not so distinct in the case of farrowing sows, where the sow is confined in its movement. In both cases dunging takes place in the same slatted area. Reduction techniques therefore focus predominantly on alterations to the manure pit.

#### **BAT is a crate with a fully-slatted iron or plastic floor and with a:**

- combination of a water and manure channel (Section 4.6.2.2), or
- flushing system with manure gutters (Section 4.6.2.3), or
- manure pan underneath (Section 4.6.2.4).

### **BAT for housing systems that are already in place**

‘A housing system with manure surface cooling fins using a closed system with heating pumps (Section 4.6.2.5)’ performs well but is a very costly system. Therefore manure surface cooling fins are not BAT for new to build housing systems, but when it is already in place, it is BAT. In retrofit situations this technique can be economically viable and thus can be BAT as well, but this has to be decided on a case by case basis.

‘Crates with a partly-slatted floor and a manure scraper underneath (Section 4.6.2.7)’ generally perform well, but the operability is difficult. Therefore a manure scraper is not BAT for new to build housing systems, but it is BAT when the technique is already in place.

For new installations the following techniques are not BAT:

- crates with a partly-slatted floor and a reduced manure pit (Section 4.6.2.6), and
- crates with a fully-slatted floor and a board on a slope (Section 4.6.2.1).

However, when these techniques are already in place it is BAT. It has to be noted that with the latter system flies can easily develop if no control measures are undertaken.

### **Littered systems**

Data must be acquired to allow better guidance on what is BAT for litter based systems. However, the TWG concluded that when litter is used, along with good practices such as having enough litter, changing the litter frequently, and designing the pen floor suitably then they cannot be excluded as BAT.

#### **5.2.2.4 Housing systems for weaners**

Weaners are housed in a group in pens or flatdecks. In principle, manure removal is the same for a pen as for a flatdeck (raised pen) design. The reference system is a pen or flatdeck with a fully-slatted floor made of plastic or metal slats and a deep manure pit (Section 2.3.1.3).

It is assumed, that in principle, reduction measures applicable to conventional weaner pens can also be applied to the flatdeck, but experiences with such a change have not been reported.

#### **BAT is a pen:**

- or flatdeck with a fully-slatted- or partly-slatted floor with a vacuum system for frequent slurry removal (Sections 4.6.1.1 and 4.6.1.6), or
- a pen or flatdeck with a fully-slatted floor beneath which there is a concrete sloped floor to separate faeces and urine (Section 4.6.3.1), or
- with a partly-slatted floor (two-climate system) (Section 4.6.3.4), or
- with a partly-slatted iron or plastic floor and a sloped or convex solid floor (Section 4.6.3.5), or
- with a partly-slatted floor with metal or plastic slats and a shallow manure pit and channel for spoiled drinking water (Section 4.6.3.6), or
- with a partly-slatted floor with triangular iron slats and a manure channel with sloped side walls (Section 4.6.3.9).

### Conditional BAT

'New to build housing systems with a fully-slatted floor and flush gutters or tubes underneath and flushing is applied with non-aerated liquid (Section 4.6.3.3)' are conditional BAT. In instances where the peak in odour, due to the flushing, is not expected to give nuisance to neighbours these techniques are BAT for new to build systems. In instances where this technique is already in place, it is BAT (without condition).

### BAT for housing systems that are already in place

'A housing system with manure surface cooling fins using a closed system with heating pumps (Section 4.6.3.10)' performs well but is a very costly system. Therefore manure surface cooling fins are not BAT for new to build housing systems, but when it is already in place, it is BAT. In retrofit situations this technique can be economically viable and thus can be BAT as well, but this has to be decided on a case by case basis.

'Fully-slatted and partly-slatted floor systems with a manure scraper underneath (Section 4.6.3.2 and 4.6.3.8)' generally perform well, but the operability is difficult. Therefore a manure scraper is not BAT for new to build housing systems, but it is BAT when the technique is already in place.

### Littered systems

Weaners are also kept on solid concrete floors with part- or full litter. No ammonia emission data is reported for these systems. However, the TWG concluded that when litter is used, along with good practices such as, having enough litter, changing the litter frequently, and designing the pen floor suitably, then they cannot be excluded as BAT.

The following system is an example of what is BAT:

- a natural ventilated pen with a fully littered floor (new Section 4.6.3.12).

### 5.2.3 Water

Reduction of the animals' water consumption is not considered to be practical. It will vary in accordance with their diet and, although some production strategies include restricted water access, permanent access to water is generally considered to be an obligation. Reduction of water use is a matter of awareness and is primarily a matter of farm management.

BAT is to reduce water use by doing all of the following:

- cleaning animal housing and equipment with high-pressure cleaners after each production cycle. Typically wash-down water enters the slurry system and therefore it is important to find a balance between cleanliness and using as little water as possible
- carry out a regular calibration of the drinking-water installation to avoid spill
- keeping record of water use through metering of consumption, and
- detecting and repairing leakages.

In principle three types of animal drinking systems are applied: nipple drinkers in a trough or cup, water troughs and biting nipples. All of these have some advantages and some disadvantages. However, there is not enough data available to come to a BAT conclusion.

## 5.2.4 Energy

BAT is to reduce energy use by application of good farming practice, starting with animal housing design and by adequate operation and maintenance of the housing and the equipment.

There are many actions that can be taken as part of the daily routine to reduce the amount of energy required for heating and ventilation. Many of these points are mentioned in Section 4.4.2. Some specific BAT measures are mentioned here.

BAT for pig housing is to reduce energy use by doing all of the following:

- applying natural ventilation where possible; this needs proper design of the building and of the pens (i.e. microclimate in the pens) and spatial planning with respect to the prevailing wind directions to enhance the airflow; this applies only to new housing
- for mechanically ventilated houses: optimising the design of the ventilation system in each house to provide good temperature control and to achieve minimum ventilation rates in winter
- for mechanically ventilated houses: avoiding resistance in ventilation systems through frequent inspection and cleaning of ducts and fans, and
- applying low energy lighting.

## 5.2.5 Manure storage

### *General*

The Nitrates Directive lays down minimum provisions on storage of manure in general with the aim of providing all waters a general level of protection against pollution, and additional provisions on storage of manure in designated Nitrate Vulnerable Zones. Not all provisions in this Directive are addressed in this document because of a lack of data, but where they are addressed, the TWG agreed that BAT for slurry storage tanks, solid manure heaps or slurry lagoons is equally valid inside and outside these designated Nitrate Vulnerable Zones.

BAT is to design storage facilities for pig manure with sufficient capacity until further treatment or land application can be carried out. The required capacity depends on the climate and the periods in which application to land is not possible. For example, the capacity can differ from the manure that is produced on a farm over a 4 – 5 month period in Mediterranean climate, a 7 – 8 month period in the Atlantic or continental conditions, to a 9 – 12 month period in boreal areas.

### *Stack/heap*

For a stack of pig manure that is always situated on the same place, either on the installation or in the field, BAT is to:

- apply a concrete floor, with a collection system and a tank for run-off liquid, and
- locate any new to build manure storage areas where they are least likely to cause annoyance to sensitive receptors for odour, taking into account the distance to receptors and the prevailing wind direction.

For a temporary stack of pig manure in the field, BAT is to position the manure heap away from sensitive receptors such as, neighbours, and watercourses (including field drains) that liquid run-off might enter.

### *Storage tanks*

BAT on the storage of slurry in a concrete or steel tank comprises all of the following:

- a stable tank able to withstand likely mechanical, thermal and chemical influences
- the base and walls of the tank are impermeable and protected against corrosion
- the store is emptied regularly for inspection and maintenance, preferably every year
- double valves are used on any valved outlet from the store
- the slurry is stirred only just before emptying the tank for, e.g., application on land.

It is BAT to cover slurry tanks using one of the following options:

- a rigid lid, roof or tent structure, or
- a floating cover, such as chopped straw, natural crust, canvas, foil, peat, light expanded clay aggregate (LECA) or expanded polystyrene (EPS).

All of these types of covers are applied but have their technical and operational limitations. This means that the decision on what type of cover is preferred can only be taken on a case by case basis.

### *Storage lagoons*

A lagoon used for storing slurry is equally as viable as a slurry tank, providing it has impermeable base and walls (sufficient clay content or lined with plastic) in combination with leakage detection and provisions for a cover.

It is BAT to cover lagoons where slurry is stored using one of the following options:

- a plastic cover, or
- a floating cover, such as chopped straw, LECA or natural crust.

All these types of covers are applied but have their technical and operational limitations. This means that the decision on what type of cover is preferred can only be taken on a case by case basis. In some situations it might be very costly, or technically not even possible to install a cover to an existing lagoon. The cost for installing a cover can be high for very large lagoons or lagoons that have unusual shapes. It might technically be impossible to install a cover when, for example, embankment profiles are not suitable to attach the cover to.

## **5.2.6 On-farm manure processing**

In general, on-farm processing of manure is BAT only under certain conditions (i.e. is a conditional BAT). The conditions of on-farm manure processing that determine if a technique is BAT relate to conditions such as the availability of land, local nutrient excess or demand, technical assistance, marketing possibilities for green energy, and local regulations.

The following Table 5.3 gives some examples on the conditions for BAT for manure processing. The list is not exhaustive and other techniques may also be BAT under certain conditions. It is also possible that the chosen techniques are also BAT under other conditions.



Under the following conditions	an example of what is BAT:
<ul style="list-style-type: none"> <li>the farm is situated in an area with nutrient surplus but with sufficient land in the vicinity of the farm to spread the liquid fraction (with decreased nutrient content), and</li> <li>the solid fraction can be spread on remote areas with a nutrient demand or can be applied in other processes</li> </ul>	mechanical separation of pig slurry using a closed system (e.g. centrifuge or press-auger) to minimise the ammonia emissions (Section 4.9.1)
<ul style="list-style-type: none"> <li>the farm is situated in an area with nutrient surplus but with sufficient land in the vicinity of farm to spread treated liquid fraction, and</li> <li>the solid fraction can be spread on remote areas with a nutrient demand, and</li> <li>the farmer gets technical assistance for running the aerobic treatment installation properly</li> </ul>	mechanical separation of pig slurry using a closed system (e.g. centrifuge or press-auger) to minimise the ammonia emissions, followed by aerobic treatment of the liquid fraction (Section 4.9.3) and where the aerobic treatment is well-controlled so that ammonia and N <sub>2</sub> O production are minimised
<ul style="list-style-type: none"> <li>there is a market for green energy, and</li> <li>local regulations allow co-fermentation of (other) organic waste products and landspreading of digested products</li> </ul>	anaerobic treatment of manure in a biogas installation (Section 4.9.6)

**Table 5.3: Examples of conditional BAT on on-farm manure processing**

Besides treatment on farm, manure may also be (further) treated off-site in e.g. industrial installations. The assessment of off-site treatment is outside the scope of this BREF.

### 5.2.7 Techniques for landspreading pig manure

The emissions of ammonia to air caused by landspreading can be reduced through the selection of the right equipment. Table 4.38 shows that the alternatives to the reference for processing slurry achieve different reductions in ammonia emissions. The reference technique is a conventional broadcast spreader, not followed by fast incorporation, and is described in Section 2.7.2.1. Generally, landspreading techniques that reduce ammonia emissions also reduce odour emissions.

BAT on the management of landspreading manure is discussed in Section 5.1.

Each technique has its limitations and is not applicable in all circumstances and/or on all types of land. Techniques that inject slurry show the highest reduction, but techniques that spread slurry on top of the soil followed by incorporation shortly afterwards can achieve the same reduction. However, this requires extra labour and energy (costs) and only applies to arable land that can easily be cultivated. BAT conclusions are shown in Table 5.4. The achieved levels are very site-specific and serve only as an illustration of potential reductions

No reduction techniques for the spreading of solid pig manure have been proposed. However, for reducing ammonia emissions from the landspreading of solid manure, incorporation is the important factor not the technique on how to spread. For grassland, incorporation is not possible.

The majority of the TWG agreed that either injection or bandspreading and incorporation (if the land can be easily cultivated) within 4 hours is BAT for applying slurry to arable land, however there was a split view on this conclusion (see below).

The TWG also agreed that, for applying slurry to land, the conventional broadcast spreader is not BAT. However, four Member States proposed that where broadcasting is operated with a low spread trajectory, and at low pressure (to create large droplets; thereby avoiding atomisation and wind drift), and slurry is incorporated into the soil as soon as possible (at least within 6 hours), or is applied to a growing arable crop, these combinations are BAT. The TWG has not reached consensus on this latter proposal.

**Split views:**

- 1 Two Member States do not support the conclusion that bandspreading of pig slurry on arable land followed by incorporation is BAT. In their view applying bandspreading on its own, which has an associated emission reduction of 30 – 40 % is BAT for spreading pig slurry on arable land. Their argument is that bandspreading already achieves a reasonable emission reduction and that the extra handling required for incorporation is difficult to organise and the extra reduction that can be achieved does not outweigh the extra costs.
- 2 Another split view on incorporation involves solid pig manure. Two Member States do not support the conclusion that incorporation of solid pig manure as soon as possible (at least within 12 hours), is BAT. In their view incorporation within 24 hours, which has an associated emission reduction of around 50 %, is BAT. Their argument is that the extra ammonia emission reduction that can be achieved does not outweigh the extra costs and difficulties involved in organising the logistics for incorporation within a shorter time.

Land use	BAT	Emission reduction	Type of manure	Applicability
grassland and land with <u>crop height</u> below 30 cm	trailing hose (bandspreading)	30 % this may be less if applied on grass height >10 cm	slurry	slope (<15 % for tankers; <25 % for umbilical systems); not for slurry that is viscous or has a high straw content, size and shape of the field are important
mainly grassland	trailing shoe (bandspreading)	40 %	slurry	slope (<20 % for tankers; <30 % for umbilical systems); not viscous slurry, size and shape of the field, grass less than 8 cm high
grassland	shallow injection (open slot)	60 %	slurry	slope <12 %, greater limitations for soil type and conditions, not viscous slurry
mainly grassland, arable land	deep injection (closed slot)	80 %	slurry	slope <12 %, greater limitations for soil type and conditions, not viscous slurry
arable land	bandspreading and incorporation within 4 hours (*)	80 %	slurry	incorporation is only applicable for land that can be easily cultivated, in other situations BAT is bandspreading without incorporation
arable land	incorporation as soon as possible, but at least within 12 hours	within: 4 hrs: 80 % 12 hrs: 60 – 70 %	solid pig manure	only for land that can be easily cultivated

**Table 5.4: BAT on landspreading equipment**

## 5.3 Intensive rearing of poultry

BAT for improving the general environmental performance of an intensive livestock farm is described in Section 5.1 “Good agricultural practice in the intensive rearing of pigs and poultry.”

### 5.3.1 Nutritional techniques

Preventive measures will reduce the amounts of nutrients excreted by the animals and thereby reduce the need for curative measures further down the production cycle. The following nutritional BAT are therefore preferably applied before downstream BAT.

Nutritional management aims at matching feeds more closely to animal requirements at various production stages, thus decreasing the wasted nutrient excretion in the manure.

Feeding measures cover a wide variety of techniques that can be implemented individually or simultaneously to achieve the highest reduction of nutrient output.

Feeding measures include phase-feeding, formulating diets based on digestible/available nutrients, using low protein amino acid-supplemented diets (see Section 4.2.3) and using low phosphorus phytase-supplemented diets (see Section 4.2.4) and/or highly digestible inorganic feed phosphates (see Section 4.2.5). Furthermore the use of feed additives described in Section 4.2.6 may increase feed efficiency, thereby improving nutrient retention and diminishing the amount of nutrients left over in the manure.

Further techniques are currently being investigated (e.g. single sex-feeding, further reduction of dietary protein and/or phosphorus contents) and might be additionally available in the future.

#### 5.3.1.1 Nutritional techniques applied to nitrogen excretion

BAT is to apply feeding measures.

As far as nitrogen and consequently nitrates and ammonia outputs are concerned, a basis for BAT is to feed animals with successive diets (phase-feeding) with lower crude protein contents. These diets need to be supported by an optimal amino acid supply from adequate feedstuffs and/or industrial amino acids (lysine, methionine, threonine, tryptophan, see Section 4.2.3).

A crude protein reduction of 1 to 2 % (10 to 20 g/kg of feed) can be achieved depending on the breed/genotype and the current starting point. The resulting range of dietary crude protein contents is reported in Table 5.5. The values in the table are only indicative, because they, amongst others, depend on the energy content of the feed. Therefore levels may need to be adapted to local conditions. Further applied nutrition research is currently being carried out in a number of Member States and may support further possible reductions in the future, depending on the effects of changes in genotypes.

Species	Phases	Crude protein content (% in feed)	Remark
Broiler	starter	20 – 22	With adequately balanced and optimal digestible amino acid supply
	grower	19 – 21	
	finisher	18 – 20	
Turkey	<4 weeks	24 – 27	
	5 – 8 weeks	22 – 24	
	9 – 12 weeks	19 – 21	
	13+ weeks	16 – 19	
	16+ weeks	14 – 17	
Layer	18 – 40 weeks	15.5 – 16.5	
	40+ weeks	14.5 – 15.5	

**Table 5.5: Indicative crude protein levels in BAT-feeds for poultry**

### 5.3.1.2 Nutritional techniques applied to phosphorus excretion

BAT is to apply feeding measures.

As far as phosphorus is concerned, a basis for BAT is to feed animals with successive diets (phase-feeding) with lower total phosphorus contents. In these diets, highly digestible inorganic feed phosphates and/or phytase must be used in order to guarantee sufficient supply of digestible phosphorus.

A total phosphorus reduction of 0.05 to 0.1 % (0.5 to 1 g/kg of feed) can be achieved depending on the breed/genotypes, the use of feed raw materials and the current starting point by the application of highly digestible inorganic feed phosphates and/or phytase in the feed. The resulting range of dietary total phosphorus contents is reported in Table 5.6. The values in the table are only indicative, because they, amongst others, depend on the energy content of the feed. Therefore levels may need to be adapted to local conditions. Further applied nutrition research is currently being carried out in a number of Member States and may support further possible reductions in the future, depending on the effects of changes in genotypes.

Species	Phases	Total phosphorus content (% in feed)	Remark
Broiler	starter	0.65 – 0.75	With adequate digestible phosphorus by using e.g. highly digestible inorganic feed phosphates and/or phytase
	grower	0.60 – 0.70	
	finisher	0.57 – 0.67	
Turkey	<4 weeks	1.00 – 1.10	
	5 – 8 weeks	0.95 – 1.05	
	9 – 12 weeks	0.85 – 0.95	
	13+ weeks	0.80 – 0.90	
	16+ weeks	0.75 – 0.85	
Layer	18 – 40 weeks	0.45 – 0.55	
	40+ weeks	0.41 – 0.51	

**Table 5.6: Indicative total phosphorus levels in BAT-feeds for poultry**

## 5.3.2 Air emissions from poultry housing

### 5.3.2.1 Housing systems for layers

The evaluation of housing systems for layers should consider the requirements laid down by the Directive 1999/74/EC on layer housing. These requirements will prohibit the installation of new conventional cage systems by 2003 and lead to a total ban on the use of such cage systems by

2012. However, it will be decided in 2005 whether the above-mentioned Directive will be reviewed, depending on the results of several studies and negotiations. One specific ongoing study focuses on the various systems of rearing laying hens, and in particular on those covered by that Directive, taking into account, amongst others, the health and environmental impact of the various systems.

The banning of conventional systems will require farmers to use of the so-called enriched cage or of the non-cage systems (alternative systems). This has consequences for evaluating investments in refurbishing existing conventional cage systems and in the installation of new systems. For any investment in systems that will be banned by the Directive, it would be advisable to allow an amortisation period of 10 years for the associated costs.

### *Cage housing*

Most laying hens are still housed in conventional cages so most of the information on ammonia emission reductions addresses this type of housing. In this section on cage housings, techniques are compared against a specific reference system. The reference system used for the housing of layers in cage systems is open manure storage under the cages (Section 4.5.1).

#### **BAT is:**

- a cage system with manure removal, at least twice a week, by way of manure belts to a closed storage (Section 4.5.1.4), or
- vertical tiered cages with manure belt with forced air drying, where the manure is removed at least once a week to a covered storage (Section 4.5.1.5.1), or
- vertical tiered cages with manure belt with whisk-forced air drying, where the manure is removed at least once a week to a covered storage (Section 4.5.1.5.2), or
- vertical tiered cages with manure belt with improved forced air drying, where the manure is removed from the house at least once a week to a covered storage (Section 4.5.1.5.3), or
- vertical tiered cages with manure belt with drying tunnel over the cages; after 24 – 36 hours the manure is removed to a covered storage (Section 4.5.1.5.4).

The drying of manure on the belts requires energy. Although energy requirements have not been reported for all techniques, a higher emission reduction generally requires a higher energy input (in kWh/bird/year). One exception is whisk-forced drying (Section 4.5.1.5.2), which achieves, with lower energy input, a similar emission reduction to forced drying (Section 4.5.1.5.1).

#### **Conditional BAT**

The deep pit system (Section 4.5.1.1) is a conditional BAT. In regions where a Mediterranean climate prevails this system is BAT. In regions with much lower average temperatures this technique can show a significantly higher ammonia emission and is not BAT unless a means of drying the manure in the pit is provided.

### *Enriched cage concept*

Different techniques applying the enriched cage concept are under development and little information is yet available to allow BAT assessment. However, these designs will form the only alternative cage system allowed for new installations from 2003 onwards (if the Directive is not going to be changed on this aspect).

### *Non-cage housing*

In the EU, non-cage layer housing is expected to attract more attention because of animal welfare considerations. In this section on non-cage housing, techniques are compared against a specific reference system (Section 4.5.2.1.1). The reference system used for the housing of layers in non-cage housing is the deep litter system without aeration.

### **BAT is:**

- a deep litter system with forced air drying (Section 4.5.2.1.2), or
- a deep litter system with a perforated floor and forced air drying (Section 4.5.2.1.3), or
- an aviary system with or without range and/or outside scratching area (Section 4.5.2.2).

A drawback of the aviary system is the high dust level, which may lead to high dust emissions from the house. High dust levels within the house causes a number of animal health issues and also has a negative effect on labour conditions.

Based on the information on currently available layer housing systems, BAT assessment shows that improving the animal welfare would have a negative effect of limiting the achievable reduction of ammonia emissions from layer housing.

### **5.3.2.2 Housing systems for broilers**

#### **BAT is:**

- the naturally ventilated house with a fully littered floor and equipped with non-leaking drinking systems (Sections 2.2.2 and 4.5.3), or
- the well-insulated fan ventilated house with a fully littered floor and equipped with non-leaking drinking systems (VEA-system) (Section 4.5.3).

#### **Conditional BAT**

The combideck system (Section 4.4.1.4), also proposed as a technique to reduce energy is a conditional BAT. It can be applied if local conditions allow; e.g. if soil conditions allow the installation of closed underground storages of the circulated water. The system is only applied in the Netherlands and in Germany on a depth of 2 – 4 metres. It is not yet known if this system performs equally well in locations where the frosts are longer and harder and penetrate the soil or where the climate is much warmer and the cooling capacity of the soil might not be sufficient.

#### **BAT for housing systems that are already in place**

Although the following techniques can achieve very high ammonia emission reductions, they are not considered to be BAT because they are too expensive. However, these techniques are BAT when they are already in place. These techniques are:

- a perforated floor system with forced air drying system (Section 4.5.3.1), or
- a tiered floor with forced air drying system (Section 4.5.3.2), or
- a tiered cage system with removable cage sides and forced drying of manure (Section 4.5.3.3).

### **5.3.3 Water**

Reduction of the animals' water consumption is not considered to be practical. It will vary in accordance with their diet and, although some production strategies include restricted water access, permanent access to water is generally considered to be an obligation. Reduction of water use is a matter of awareness and is primarily a matter of farm management.

BAT is to reduce water use by doing all of the following:

- cleaning animal housing and equipment with high-pressure cleaners at the end of each batch of livestock. It is important to find a balance between cleanliness and using as little water as possible
- regularly calibrating the drinking-water installation to avoid spill
- keeping record of water use through metering of consumption, and
- detecting and repairing leakages.

In principle three types of animal drinking systems are applied: low capacity nipple drinkers or high capacity drinkers with a drip-cup, water troughs and round drinkers. All of these have some advantages and some disadvantages. However, there is not enough data available to come to a BAT conclusion.

### 5.3.4 Energy

BAT is to reduce energy use by application of good farming practice starting with animal housing design and by adequate operation and maintenance of the housing and the equipment.

There are many actions that can be taken as part of the daily routine to reduce the amount of energy required for heating and ventilation. Many of these points are mentioned in Section 4.4.1. Some specific BAT measures are mentioned here.

BAT for poultry housing is to reduce energy use by doing all of the following:

- insulating buildings in regions with low ambient temperatures (U-value 0.4 W/m<sup>2</sup>/°C or better)
- optimising the design of the ventilation system in each house to provide good temperature control and to achieve minimum ventilation rates in winter
- avoiding resistance in ventilation systems through frequent inspection and cleaning of ducts and fans, and
- applying low energy lighting.

### 5.3.5 Manure storage

#### *General*

The Nitrates Directive lays down minimum provisions on storage of manure in general with the aim of providing all waters a general level of protection against pollution, and additional provisions on storage of manure in designated Nitrate Vulnerable Zones. Not all provisions in this Directive are addressed in this document because of a lack of data, but where they are addressed, the TWG agreed that BAT for storage of manure is equally valid inside and outside designated Nitrate Vulnerable Zones.

BAT is to design storage facilities for poultry manure with sufficient capacity until further treatment or application to land can be carried out. The required capacity depends on the climate and the periods in which application to land is not possible.

#### *Stack/heap*

If manure needs to be stored, BAT is to store dried poultry manure in a barn with an impermeable floor and with sufficient ventilation.

For a temporary stack of poultry manure in the field, BAT is to position the heap away from sensitive receptors such as, neighbours, and watercourses (including field drains) that liquid run-off might enter.

### 5.3.6 On-farm manure processing

In general, on-farm processing of manure is BAT only under certain conditions (conditional BAT). The conditions in on-farm manure processing that determine if a technique is BAT are related with conditions such as the availability of land, local nutrient excess or demand, marketing possibilities for green energy, local regulations, and the presence of abatement techniques.

An example of a conditional BAT is:

- applying an external drying tunnel with perforated manure belts (Section 4.5.5.2), when the housing system for layers does not incorporate a manure drying system or another technique for reducing ammonia emissions (Section 5.3.2.1).

Besides treatment on-farm, manure may also be (further) treated off-site in industrial installations such as, poultry litter combustion, composting or drying. The assessment of off-site treatment is outside the scope of this BREF.

### 5.3.7 Techniques for landspreading poultry manure

Poultry manure has a high available nitrogen content and it is therefore important to get an even spread distribution and an accurate application rate. In this respect the rota-spreader type is poor. The rear-discharge spreader and dual-purpose spreader are much better. For wet poultry manure (< 20 % dm) from caged systems such as described in Section 4.5.1.4, broadcasting with a low trajectory at low pressure is the only applicable spreading technique. However, no conclusion about which spreading technique is BAT has been drawn.

BAT on the management of landspreading manure is discussed in Section 5.1.

For reducing ammonia emissions from landspreading poultry manure, incorporation is the important factor not the technique on how to spread. For grassland, incorporation is not possible.

BAT on landspreading – wet or dry – solid poultry manure is incorporation within 12 hours. Incorporation can only be applied to arable land that can be easily cultivated. The achievable emission reduction is 90 %, but this is very site-specific and serves only as an illustration of a potential reduction.

#### **Split view:**

Two Member States do not support the conclusion that incorporation of solid poultry manure within 12 hours is BAT. In their view incorporation within 24 hours, which has an associated ammonia emission reduction of around 60 – 70 %, is BAT. Their argument is that the extra ammonia emission reduction that can be achieved does not outweigh the extra costs and difficulties involved in organising the logistics for incorporation within a shorter time.



## 6 CONCLUDING REMARKS

A feature of this work is that the ammonia emission reduction potential, associated with the techniques described in Chapter 4, are given as relative reductions (in %) against a reference technique. This is done because consumption and emission levels of the livestock depend on many different factors, such as the animal breed, the variation in feed formulation, production phase and management system applied, but also on other factors such as climate and soil characteristics. The consequence of this is that the absolute ammonia emissions from applied techniques, such as the housing systems, the storage of manure, and manure application to land, will cover a very wide range and make interpretation of absolute levels difficult. Therefore, the use of ammonia-reduction levels expressed in percentages has been preferred.

### 6.1 Timing of the work

The work on this BAT Reference document started with a kick-off meeting on 27 and 28 May 1999. Two drafts were issued to the Technical Working Group for consultation. The first draft of this BREF was sent out for consultation in October 2000. The second draft was issued in July 2001 and at this stage there was a change of BREF author. On 10 and 11 January 2002 an intermediate meeting was organised. This was done for mainly two reasons: firstly because of complaints about the second draft from the TWG about lack of transparency and secondly because of the change of author. The second TWG meeting was on 25 – 27 February 2002. After this meeting there were short consultation periods on the revised Chapters 1 to 5 and on the new Chapter 6, Concluding remarks, and the Executive summary. After this the final redrafting took place. The final draft was presented to Environment DG in the Information Exchange Forum meeting of 12 and 13 November 2002.

### 6.2 Sources of information

Many reports from mainly authorities and also from research centres have been used as sources of information in the drafting of this BREF. On housing techniques for pigs and poultry the documents submitted by Italy and the Netherlands can be considered as the general building blocks. On landspreading there are the documents from the UK, and the main contributor on manure treatment is Belgium. The industry group FEFANA submitted valuable information on nutritional management.

Most of the information submitted focused on the reduction of ammonia emissions, especially from the housing of pigs and poultry and from the landspreading of manure. Nutritional management, as a mean of preventing ammonia emissions, is also well addressed. However little information was made available on noise, waste and waste water. Also hardly any information was submitted on monitoring.

### 6.3 Level of consensus

This BREF has the support of most of the TWG members, although on five BAT conclusions the following split views had to be noted:

- |         |   |
|---------|---|
| 1 and 2 | The whole TWG agreed on the BAT conclusions for the housing systems of mating/gestating sows and of growers/finishers. However, the view of experts representing one Member State was that another system described in Chapter 4 is BAT in instances where the techniques are already in place, and is also BAT when an extension is planned to operate with the same system. |
|---------|---|

3. Two Member States do not support the conclusion that bandspreading of pig slurry on arable land followed by incorporation is BAT. In their view applying bandspreading on its own is BAT.
- 4 and 5. Another split view was on the timing of incorporation of solid pig and poultry manure. Two Member States do not support the conclusion that incorporation of solid pig manure as soon as possible (at least within 12 hours), is BAT. In their view incorporation within 24 hours is BAT. The same Member States do not agree on incorporation of poultry manure within 12 hours being BAT; in their view this is within 24 hours.

### 6.4 Recommendations for future work

Limited data were made available on the current emission and consumption levels and on the performance of techniques to be considered in the determination of BAT, especially on the achievable emission and consumption levels and on economics. Where data were made available, for example on ammonia emissions, they have to be interpreted with care because the circumstances under which the data were gathered were different or not known. In Annex 7.6 recommendations on the future reporting of comparable cost data are reported.

The work of this TWG also found that the quality and quantity of the information submitted by the Member States in order to describe the relevant production processes varied widely, with the consequence that the information was only partly or not at all comparable. Therefore, to achieve an efficient updating of this BREF in the future, it is recommended that a harmonised approach should be developed concerning the description and assessment of the techniques applied in intensive livestock farming.

Concerning specific areas where very little information was made available, monitoring should be mentioned in particular and considered to be one of the key issue in the future review of the BREF. A subgroup of this TWG compiled a document that identifies the areas where information is missing. This working document also addresses the activities subject to monitoring and proposes monitoring techniques. This document with [200, ILF, 2002] might be a good starting point to gather information on monitoring that can be used in the future review of the BREF. A document with the reference [218, Czech Republic, 2002] describes how ammonia concentrations can be measured in stables. Reference [219, Denmark, 2002] is a reaction on the earlier mentioned document from the Czech Republic. Both references should be considered in the future of the BREF. Other specific areas where data and information are missing are the following:

- on the housing systems for layers, the enriched cage has been proposed as a BAT technique, as it will be the only cage design allowed from 2003 for new systems (if the Directive on animal welfare is not going to be changed on this aspect). This system is still under development and practical experience is only now being obtained. Only one design could be presented, but it has been reported that alternative designs will become available later. Information on this will be useful for the future review of the BREF
- turkey housing with an improved management, has the potential for emission reduction, but further work is needed to validate the environmental performance. A further analysis of, for example, labour input would be useful to assess operating costs against environmental benefits
- for poultry, a lot of information was made available on layers and broilers, however very little information was submitted on ducks and Guinea fowls and only limited information on turkeys; more information should be gathered for the future review

- it is expected that the use of litter in pig housing will increase throughout the Community due to a raised awareness of animal welfare. However the effect on, for example, (ammonia) emissions is not well known at the moment but practical experience is being obtained. More information is necessary for a further assessment in the future BREF review
- multiphase feeding for pigs and poultry is considered an improved method to reduce the nitrogen content of manure. The associated costs and feeding equipment requirements have not been reported. These data would be needed for a further assessment in the future BREF review
- the techniques for the on-farm processing of manure need further qualification and quantification to allow a better assessment for BAT considerations
- the use of additives in manure is commonly applied, however more information, for example, on reference plants and actual performance data are necessary to conclude on BAT
- on noise, energy, waste water and waste more information is necessary to allow a full assessment of BAT
- landspreading of manure is considered to be an important issue and some detailed BAT conclusions are reported in this document. However, issues such as (the reduction of) the dry matter content of manure and irrigation are not addressed sufficiently and need to be considered in the future review of the BREF
- in this BREF, the principle of not spreading manure near to watercourses is agreed, however the distances could not be quantified. This is the same for the principle of not applying manure on steeply sloping fields; the slope could not be quantified. Information on these issues, taking into account soil conditions (e.g. arable or growing crop) and type of manure (e.g. slurry or solid), is necessary to allow an assessment of these issues in the next review of the BREF
- sustainable drainage techniques (see reference [217, UK, 2002]) needs assessment in the future BREF review.

Animal welfare has been considered in this document. However, it would be useful to develop assessment criteria regarding animal welfare aspects of housing systems.

## 6.5 Suggested topics for future R&D projects

The following topics might be considered for future Research and Development projects:

- research on what techniques are available and which are most reliable in monitoring gas concentrations in buildings with housing systems for pigs and poultry
- research on measuring emission rates, especially from naturally ventilated buildings (which has proven to be difficult so far)
- research on covering solid manure heaps, including testing different types of covering material, the associated emission reduction, cost and applicability
- research on the effect of litter on the performance of (existing) housing systems for pigs
- in many cases the effects on human or animal health or other environmental effects by using additives in pig slurry are not known; research on this topic might be useful
- research on measurement of ammonia and odour emissions from biological animal housing systems (use of straw, exercise yards)
- development of measurement systems and strategies for complex sources of gaseous emissions on farm level (houses, storages)

- development of a measurement technique for N<sub>2</sub>-emissions from straw bed systems
- research on monitoring of gaseous emissions from farming systems with improved/advanced nutrient management
- where solid manure storage is concerned, determining the liberation levels of methane and nitrous oxide. On the pig farming side, the most cost-efficient measures to reduce ammonia liberation levels and odour emissions come in the form of artificial floating-lid covers. Here again, more research is needed into the behaviour of climate-effective gases.
- development of a trace gas based system for measurement of gaseous emissions from covered slurry storages
- assessment of gaseous emission, including mitigation options, from storage and handling solid wastes/Farm Yard Manure
- research and development towards reduced emissions of ammonia and methane during storage, transport and application of animal slurries
- Life Cycle Analysis of gaseous N-losses in 'traditional' and 'future' farming systems
- research on sustainable farming (monitoring, management tools)
- research on odour abatement through management (diets, climatisation, etc.)
- research on the impact of farm-surrounding trees on the perception of odour nuisance by neighbouring residents
- research on the dust component in odour nuisance
- research on distribution of dust emitted by straw and litter based animal housing systems, including options for reduction by management and technology
- research and development of process models for ammonia emissions (housing, storage, land application) as a basis for the assessment of ammonia emission, concentration and deposition
- research on animal nutrition related monitoring (e.g. manure composition) to reduce ammonia emissions
- research on solid manure treatment (e.g. composting, straw addition, anaerobic digestion) and the associated emission rates of NH<sub>3</sub>, N<sub>2</sub>O and CH<sub>4</sub>
- research on slurry treatment (e.g. separation, straw cover, anaerobic digestion) and the associated emission rates of NH<sub>3</sub>, N<sub>2</sub>O and CH<sub>4</sub>
- research on the effect of litter on the performance of (existing) housing systems for pigs, optimising design and performance of littered systems for pigs (emission level, work rate, costs)
- research on litter for animal housing, especially on new/other materials for improving environmental performances of littered systems
- optimising design and performance of alternative systems for poultry (emission level, work rate, costs)
- research on the applicability of low emission slurry spreading techniques under different circumstances
- research on cross media effects and the applicability of slurry injection (N<sub>2</sub>O emissions, fuel consumption, impacts on soils and vegetation)
- research on emission levels, not only on ammonia but on odour, climate-impacting gases (methane and nitrous oxide), and on what reciprocal influences they may exercise under various emission-reducing measures, as well as on the subject of dust and germ (bio-aerosol) emissions
- with a view to requirements regarding both pig and laying bird management regimes compatible with animals' natural needs, more emission-reducing housing systems must be researched and the technological development of reducing emission levels needs to be improved so that the target conflict between animal and environment protection can be resolved.

The EC is launching and supporting, through its RTD programmes, a series of projects dealing with clean technologies, emerging effluent treatment and recycling technologies and management strategies. Potentially these projects could provide a useful contribution to future BREF reviews. Readers are therefore invited to inform the EIPPCB of any research results which are relevant to the scope of this document (see also the preface of this document).

---

**REFERENCES**

- 1 EPA (1996). "Batneec Guidance Note for the Pig Production Sector".
- 2 EPA (1996). "Batneec Guidance Note for the Poultry Production Sector".
- 3 Vito (1998). "Beste beschikbare technieken voor het be- en verwerken van dierlijke mest", 90-382-0161-3.
- 5 VMM (1996). "Landbouw, Par. 1.3 of Milieu- en natuurrapport Vlaanderen 1996: Leren om te keren".
- 7 BBL (1990). "De mineralenboekhouding in de landbouwbedrijfsvoering. Hoofdstuk 3. Mineralen en milieu-effecten."
- 8 Technologisch Instituut, (1999). "Krachtlijnen en uitdagingen van het nieuwe meststoffen-decreet".
- 9 UNECE, (1999). "Control techniques for preventing and abating emissions of ammonia", EB.AIR/WG.5/1999/8/Rev.1.
- 10 Netherlands, t., (1999). "Dutch notes on BAT for pig- and poultry intensive livestock farms".
- 11 Italy, (1999). "Italian contribution to BATs Reference Document (draft April 1999)".
- 13 EC, D. A. u. B. (1996). "Report on the welfare of laying hens, Chapter 3.6 Environment".
- 14 BGBI.II 349/97 (1997). "Verordnung des Bundesministers für Land- und Forstwirtschaft über die Begrenzung von Abwasseremissionen aus der Massentierhaltung; (AEV Massentierhaltung)".
- 15 Austria, (1997). "Gesetzliche Begrenzung von Abwasseremissionen aus der Massentierhaltung".
- 17 ETSU, (1998). "Energy savings in industrial water pumping systems", Good practice guide 249.
- 21 VROM (1998). "Wet bodembescherming: Besluit gebruik dierlijke meststoffen (Bgdm) Besluit Overige Organische Meststoffen".
- 23 VROM/LNV (1996). "Uitvoeringsregeling Interimwet Ammoniak en Veehouderij".
- 24 VROM/LNV (1996). "Richtlijn Veehouderij en Stankhinder".
- 26 LNV (1994). "Handboek voor de pluimveehouderij", 90-800999-4-5.
- 27 IKC Veehouderij (1993). "Handboek voor de varkenshouderij", 90-800999-3-7.
- 28 CORPEN, (1996). "Estimation des rejets d'azote et de phosphore des élevages de porcs (Impact des modifications de conduite alimentaire)/Estimation of nitrogen and phosphorus outputs in the environment from pig farms (Impact of the modifications of feeding practices and technical performances)".
- 29 CORPEN, (1996). "Estimation des rejets d'azote par les élevages avicoles/Estimation of nitrogen outputs in the environment from poultry farms".

## References

---

- 30 CORPEN, (1997). "Estimation des rejets de phosphore par les élevages avicoles/ Estimation of phosphorous output in the environment from poultry farms".
- 31 EAAP, (1998). "Pig housing systems in Europe: current trends" 49th Annual Meeting of the European Association for Animal Production, 26.
- 32 Vito, (1999). "Environmental aspects of antimicrobial growth promotors in feed".
- 33 Provincie Antwerpen, (1999). "Invloed van klimaat op de groei van vleeskuikens" Studienamiddagen Pluimveehouderij.
- 35 Berckmans et al. (1998). "Emissie en impact van ammoniak in varkensstallen, Hoofdstuk III. Reductietechnieken".
- 36 EC, (1999). "Opinion of the steering committee on antimicrobial resistance".
- 37 Bodemkundige Dienst, (1999). "Bijdrage tot de uitbouw van beleidsmaatregelen voor de reductie van de ammoniakuitstoot door de landbouw in Vlaanderen".
- 39 Vito (1999). "Overview of regulatory material".
- 40 MAFF, M. o. A., Fisheries and Food, (1998). "Guidelines for farmers in nitrate vulnerable zones".
- 43 MAFF, M. o. A., Fisheries and Food, (1998). "Code of good agricultural practice for the protection of air".
- 44 MAFF, M. o. A., Fisheries and Food, (1998). "Code of good agricultural practice for the protection of water".
- 45 MAFF, M. o. A., Fisheries and Food, (1998). "Code of good agricultural practice for the protection of soil".
- 49 MAFF (1999). "Making better use of livestock manures on arable land".
- 50 MAFF (1999). "Making better use of livestock manures on grassland".
- 51 MAFF (1999). "Spreading systems for slurries and solid manures".
- 59 Italy, (1999). "Italian Contribution to BATs Reference Document (BREF) (draft June 1999)".
- 60 EPA, a. o., (1999). "Groundwater protection schemes", ISBN 1-899702-22-9.
- 61 EPA, (1997). "Environmental quality objectives and environmental quality standards, The aquatic environment (Discussion document).", ISBN 1-899965-51-3.
- 62 LNV, (1992). "Afvalwater in de Veehouderij", 28.
- 63 Commissie van Deskundigen, (1999). "Beoordelingsprotocol emissies uit stalsystemen, Bijlage landbouwkundige randvoorwaarden en te registreren gegevens (draft)".
- 68 ADAS, (1999). "Guidance on the control of noise on poultry units".
- 69 ADAS, (1999). "Guidance on the control of noise on pig units".

- 70 K.U. Laboratorium voor Agrarische Bouwkunde, (1999). "Nieuwe stalconcepten voor een rendabele veeteelt in de context van de huidige milieuregeling".
- 71 Smith et al., (1999). "Nitrogen excretion by farm livestock with respect to landspreading requirements and controlling nitrogen losses to ground and surface waters. Part 2: pigs and poultry" Bioresource Technology, , pp. 183-194.
- 72 ADAS, (1999). "Guidance on the control of energy on pig units".
- 73 Peirson, (1999). "Guidance on the control of energy on poultry units".
- 74 EC (1999). "Council Directive 1999/74/EC of 19 July 1999 laying down minimum standards for the protection of laying hens".
- 75 Menoyo et al., (1998). "Compostaje de gallinaza para su uso como abono orgánico (Composting of poultry manure to be applied as organic fertiliser)".
- 76 BMU (1995). "Vorläufige Richtlinie zur Beurteilung von Immissionen aus der Nutztierhaltung in Stallungen".
- 77 LEI, (1999). "Managing nitrogen pollution from intensive livestock production in the EU", 2.99.04.
- 81 Adams/Röser, (1998). "Digestion of feed and absorption of nutrients influence animal performance and the environment" Feed Magazine.
- 82 Gill, B. P., (1999). "Phase-feeding. Converting science into commercial practice." Feed Compounder, pp. 4.
- 83 Italy, (2000). "Description of the candidate BATs for pig intensive farming".
- 85 Oele, (1999). "The Dutch mineral policy 1984-2008/2010" Regulation of animal production in Europe (KTBL).
- 86 CEEP, (1998). "Recovery of phosphates for recycling from sewage and animal wastes - summary and conclusions" Recovery of phosphates for recycling from sewage and animal wastes.
- 87 Denmark, (2000). "Danish BAT notes concerning intensive pig production".
- 89 Spain, (2000). "Information exchange on Intensive Livestock Farming. Spanish contribution to BATs Reference Document."
- 91 Dodd, V. A., (1996). "The pig production cycle (a concise report, July 1996)".
- 92 Portugal, (1999). "Overview of intensive livestock farming in Portugal".
- 98 FORUM, (1999). "Pigs, pollution and solutions".
- 99 Ajinomoto Animal Nutrition, (2000). "Prevention of nitrogen pollution from pig husbandry through feeding measures", 22.
- 100 MLC, (1998). "Phase-feeding. Matching the protein requirements of growing and finishing pigs for lean growth at least cost."
- 101 KTBL, (1995). "Schwermetalle in der Landwirtschaft (Heavy metals in agriculture)", 217.

## References

---

- 102 ID-Lelystad, (2000). "De forfaitaire excretie van stikstof door landbouwhuisdieren (The standardised excretion of nitrogen by livestock)", 00-2040.
- 105 UK (1999). "Text proposal for good practice for environmental management.
- 106 Portugal (2000). "Code of good agricultural practices for the protection of water against pollution by nitrates of agricultural origin (Draft)".
- 107 Germany, (2001). "Good Agricultural practice: Possibilities for avoiding and reducing emissions and immissions/Animal disease and farm hygiene (Comment to 1st Draft of BREF document)".
- 108 FEFANA, (2001). "FEFANA "Amino Acid Working Party" Input to the BREF Document (Comment to 1st Draft of BREF document)".
- 109 VDI (2000). "VDI 3474 - Emission control livestock farming - Odorants (draft 09)".
- 110 MAFF, (1999). "Phase feeding pigs to reduce nutrient pollution - N in pig slurry.", Scientific report WA0309.
- 111 MAFF, (1999). "Phase feeding pigs to reduce nutrient pollution - ammonium-N emission from application", WA0317.
- 112 Middelkoop/Harn, (1996).
- 113 R&R Systems BV, (1999). "Kombideksysteem (Combidecksystem)".
- 115 Rademacher, M., (2000). "How can diets be modified to minimise the impact of pig production on the environment?" AminoNews.
- 116 MAFF, (1999). "Update on available knowledge of pig diets to reduce pollution and estimate of costs of reducing ammonia emissions by changing diets.", WA310.
- 117 IPC Livestock Barneveld College (1998). "Broiler Nutrition".
- 118 IPC Livestock Barneveld College (1999). "Layer Nutrition".
- 119 Elson, A., (1998). "Poultry buildings" Poultry Producers' Study Days.
- 120 ADAS, (1999). "An assessment of the feasibility of a range control measures intended to minimise ammonia emissions from pig housing".
- 121 EC (2001). "Proposal for a Council directive amending Directive 91/630/EEC laying down minimum standards for the protection of pigs".
- 122 Netherlands, (2001). "Comments Netherlands to first draft".
- 123 Belgium, (2001). "Standaardomstandigheden in Vlaanderen (Standard conditions in Flanders) - Comment B7 to first draft".
- 124 Germany, (2001). "Comments Germany to first draft".
- 125 Finland, (2001). "BAT report. Methods and techniques for reducing the environmental load due to intensive rearing of pigs and poultry".
- 126 NFU, (2001). "Comments UK National Farmers' Union to first draft".



- 127 Italy, (2001). "Comments Italy to first draft".
- 128 Netherlands, (2000). "Technical descriptions of systems for the housing of different poultry species. Prepared for the exchange of information on BAT."
- 129 Silsoe Research Institute, B., England, (1997). "Concentrations and emission rates of aerial ammonia, nitrous oxide, methane, carbon dioxide, dust and endotoxin in UK broiler and layer houses." British Poultry Science, pp. 14-28.
- 130 Portugal, (2001). "Comments Portugal to first draft".
- 131 FORUM (2001). "Comments Forum to first draft".
- 132 EC (1991). "Council Directive 91/630/EEC of 19 November 1991 laying down minimum standards for the protection of pigs."
- 133 Peirson/Brade, (2001). "Flatdeck pig housing - a summary description".
- 134 Spain, (2001). "Comments Spain to first draft".
- 135 Nicholson et al., (1996). "Nutrient composition of poultry manures in England and Wales" Bioresource Technology, , pp. 279-284.
- 137 Ireland, (2001). "Comments Ireland to first draft".
- 138 Netherlands, (1999). "Nitrogen and phosphorous consumption, utilisation and losses in pig production".
- 139 UK (2001). "Comments UK-MAFF to first draft".
- 140 Hartung E. and G.J. Monteny, (2000). "Methane (CH<sub>4</sub> and Nitrous Oxide (N<sub>2</sub>O) emissions from animal husbandry" Agrartechnische Forschung, pp. E 62 - E 69.
- 141 ADAS, (2000). "Guidance on construction, repair and maintenance - Farm waste structures", CGN 100 and CGN 001 - 009.
- 142 ADAS, (2000). "The practicability of fitting various types of emission control cover to above-ground prefabricated and earth-banked slurry stores."
- 143 ADAS, (2000). "Low-cost covers to abate gaseous emissions from slurry stores", WA0641.
- 144 UK (2000). "Text proposal - Activities applicable to all farms".
- 145 Greece, (2001). "Comments Greece to first draft".
- 146 ADAS, (2000). "Disposal of waste materials arising on farms".
- 147 Bragg S and Davies C, (2000). "Towards sustainable agricultural waste management (Final draft)".
- 150 SCOPE, (1997). "SCOPE Newsletter 21 - Agricultural phosphorus", 21.
- 152 Pahl, (1999). "Environmental factors in pig production - Description of potential emissions, causes, abatement and legislation".
- 153 Eurostat, (2001). "Eurostat: Agriculture and Fisheries, Yearbook 2001".

## References

---

- 154 Germany, (2001). "Legal framework in Germany".
- 159 Germany, (2001). "Good agricultural practice - Comment to first draft".
- 161 MAFF, (2000). "Calculating the cost of best available techniques for the intensive rearing of poultry and pigs (draft)".
- 166 Tank manufacturer, (2000). "Pollution control - Slurry management".
- 169 FEFAC (2001). "Comments on draft 2 ILF BREF".
- 170 FEFANA, (2002). "FEFANA WP Enzymes proposal for the part Phytase (Chapter 4 of BREF document draft 2, on the intensive farming of poultry and pigs)".
- 171 FEFANA (2001). "Comments on draft 2 ILF BREF".
- 172 Denmark (2001). "Comments on draft 2 ILF BREF".
- 173 Spain (2001). "Comments on draft 2 ILF BREF".
- 174 Belgium (2001). "Comments on draft 2 ILF BREF".
- 175 IMAG-DLO, (1999). "Environmental aspect of a group housing system for sows with feeding stations and straw".
- 176 UK, (2002). "Thoughts on ventilation and air control".
- 177 Netherlands, (2002). "Energy saving by a frequency-converter".
- 178 Netherlands (2002). "Additional information about Combideck system in broiler houses".
- 179 Netherlands (2001). "Comments on the second draft of the ILF BREF (poultry)".
- 180 ASEPRHU, (2001). "Comments on 2nd draft ILF BREF".
- 181 Netherlands (2002). "(additional) Comments on the 2nd draft ILF BREF".
- 182 TWG, (2002). "Proposal for conditional BAT poultry (laying hens)".
- 183 NFU/NPA, (2001). "Comments on 2nd draft of the ILF BREF".
- 184 TWG ILF (2002). "Emission control measure assessment matrices".
- 185 Italy, (2001). "Appendix to Description of the candidate BATs for pig intensive farming", 2nd version.
- 186 DK/NL, (2002). "Manure surface cooling channel in combination with a closed heat exchanger".
- 187 IMAG-DLO, (2001). "Nürtinger system", 2001-09.
- 188 Finland, (2001). "Comments draft 2 ILF BREF".
- 189 Italy/UK, (2002). "Pens with straw bedded floor; natural ventilation".
- 190 BEIC (2001). "Comments on 2nd draft ILF BREF".

- 
- 191 EC (1999). "Storage vessels for manure (5)".
- 192 Germany (2001). "Comments on 2nd draft BREF".
- 193 Italy (2001). "Comments on 2nd draft BREF".
- 194 Austria (2001). "Comments on 2nd draft BREF".
- 195 EC (1999). "Livestock Manures - Nitrogen Equivalents".
- 196 Spain, (2002). "Manure additives".
- 197 Netherlands, (2002). "Remarks on landspreading".
- 198 CEFIC, (2002). "Highly digestible inorganic feed phosphates".
- 199 FEFANA, (2002). "Addition of specific feed additives".
- 200 ILF, T. (2002). "Integrated Pollution Prevention and Control (IPPC) Reference Document on Best Available Techniques in the Intensive livestock farming; Monitoring of Emissions".
- 201 Portugal (2001). "Comments on 2nd draft BREF".
- 202 Institute of Grassland and Environmental Research, (2000). "Treatment of livestock wastes through the use of additives", CSG 15 (rev. 12/99).
- 203 EC (2001). "Comments on draft 2 BREF".
- 204 ASPHERU (2002). "Enriched cage for laying hens".
- 205 EC, (2001). "Communication from the Commission to the Council and the European Parliament on the Implementation of Council Directive 91/676/EEC concerning the protection of waters against pollution caused by nitrates from agricultural sources".
- 206 Netherlands, (2002). "Drinker systems".
- 207 Belgium (2000). "Comments on first draft BREF".
- 208 UK (2001). "Comments on 2nd draft BREF".
- 209 Environment DG, (2002). "report on Nitrates Directive".
- 216 UK, (2002). "Integrated Pollution Prevention and Control, Intensive Livestock BREF, Assessing the Affordability of Best Available Techniques".
- 217 UK (2002). "Sustainable surface water drainage techniques".
- 218 Czech Republic (2002). "Methodology for continual measuring of ammonia concentrations in stables".
- 219 Denmark (2002). "Comments on monitoring ammonia concentrations in stables; reference number 218".
- 220 UK (2002). "Slurry spreading".



---

## GLOSSARY OF TERMS

<b>Antibiotic</b>	a substance produced by or derived from a micro-organism, which destroys or inhibits the growth of other micro-organisms.
<b>Animal place or head</b>	unit referring to one animal in production. Both units refer to the same production unit, generally used to express consumption and emission levels in this document.
<b>Antimicrobial</b>	a drug which, at low concentrations, exerts an action against microbial pathogens and exhibits selective toxicity towards them.
<b>Application rate</b>	the ratio between manure volume, and the available hectares for landspreading.
<b>Biochemical oxygen demand (BOD)</b>	measure of the amount of oxygen consumed by micro-organisms in breaking down organic matter.
<b>Dessication</b>	process of becoming completely dried out; as in consumption of groundwater in excess to the natural supply.
<b>Dry matter percentage (dm %)</b>	is the ratio between the initial weight of a defined substance and the final (constant) weight, obtained after drying at 110 °C.
<b>Feed conversion ratio</b>	the ratio expressing the amount of feed (kg) needed for 1 kg growth of live weight; the smaller the ratio the more efficient feed is converted into product or growth; FCR depends on feed, animal species and type of production. In Finland the ratio expresses the amount of feed per kg of slaughter weight.
<b>Growers/finishers</b>	category referring to pigs from approximately 25 - 30 kg of live weight up to 170 kg of live weight; also called fatteners or rearing pigs.
<b>Hen egg production</b>	term used to indicate the production of chicken eggs to distinguish from other egg laying poultry species (e.g. ducks)
<b>Manure application</b>	the activity of spreading manure or slurry onto land (unless otherwise stated).
<b>Manure treatment</b>	all potential ways of processing manure, including manure application
<b>Non-methane volatile organic compounds (nmVOC)</b>	all those compounds other than methane which can produce photochemical oxidants as a result of the reaction with nitrogen oxides in the presence of solar radiation.

<b>Poultry</b>	is the general term used to indicate the sector producing eggs or meat of chicken, turkeys, ducks and guinea fowl. Where only chicken layers and chicken broilers are addressed, the term layer or broiler will be used.
<b>Rearing pigs</b>	term used for growers/finishers.
<b>Replacement sows</b>	sows that replace sows in the breeding herd to maintain the required genetic material
<b>Slurries</b>	consist of excreta produced by livestock whilst in a yard or building mixed with rainwater and wash-water and, in some cases, waste bedding and feed. Slurries can generally be pumped or discharged by gravity.
<b>Solid manures</b>	include farmyard manure (FYM) and comprise material from covered straw yards, excreta containing a lot of straw, or solids from mechanical slurry separators. Solid manure can generally be stacked.
<b>Sow</b>	technical term for the female pig from the beginning of the first service period, or from the first moment of the first gestation. This includes replacement sows (gilts).
<b>Stag</b>	male turkey.
<b>Stocking density</b>	number of animals per surface area (m <sup>2</sup> or km <sup>2</sup> ).
<b>Vitamin H (Biotin)</b>	Biotin, a common biochemical substance (C <sub>10</sub> H <sub>16</sub> N <sub>2</sub> O <sub>3</sub> S) that functions as an enzyme for reduction of amino acids and formation of long-chained fatty acids and as a co-enzyme in the formation of carbohydrates from fat and protein in the absence of sufficient carbohydrate intake.
<b>Weaners</b>	pigs kept separate from the sow after weaning at a live weight of around 7 kg up to approximately 25 - 30 kg.

## ABBREVIATIONS

Abbreviation	Explanation
<b>ACNV</b>	Automatically controlled natural ventilation
<b>BAT</b>	Best available technique
<b>BPEO</b>	Best practicable environmental option
<b>BREF</b>	BAT Reference Document
<b>CAP</b>	Common Agricultural Policy
<b>CAPEX</b>	Capital Expenditure
<b>CP</b>	Crude protein
<b>SCF</b>	Concrete slatted floor
<b>Dm or dm</b>	Dry matter
<b>ECE</b>	Economic Commission for Europe
<b>EPS</b>	Expanded polystyrene
<b>EU</b>	European Union
<b>EU-15</b>	15 Member States of the European Union
<b>EUR</b>	Euro – European currency
<b>FAO</b>	World Food and Agricultural Organisation
<b>FCR</b>	Feed conversion ratio
<b>FSF</b>	Fully-slatted floor
<b>FYM</b>	Farmyard manure
<b>IPPC</b>	Integrated prevention and pollution control, referring to European Directive 96/61 EC
<b>LECA</b>	Light expanded clay aggregate
<b>LW</b>	Live weight
<b>µg</b>	Microgram (10 <sup>-6</sup> grams)
<b>MAP</b>	Belgian indication for pig feed with reduced protein and phosphorus levels
<b>MLC</b>	Meat and Livestock Commission of United Kingdom
<b>MS</b>	Member State of the European Union
<b>Mt</b>	Megatonnes
<b>NVZ</b>	Nitrate vulnerable zones
<b>OM (or om)</b>	Organic matter content
<b>OPEX</b>	Operational Expenditure
<b>Pa</b>	Pascal, measure of pressure, also Newton/m <sup>2</sup>
<b>PSF</b>	Partly-slatted floor
<b>RAM</b>	German indication for pig feed with reduced protein and phosphorus levels
<b>RH</b>	Relative humidity
<b>TWG</b>	European technical working group for the exchange of information in the framework of the IPPC-directive
<b>UAA</b>	Utilised Agricultural Area
<b>USDA</b>	United States Department of Agriculture





## 7 ANNEXES

### 7.1 Animal species and livestock units (LU)

In the evaluation of the environmental impact of intensive livestock farms the term “place” may lead to confusion. A place can be considered equal to one animal, but there is a difference in the extent of environmental effects from keeping different kinds of animals belonging to the same species but different kinds and stages of production. For example hens, broilers, ducks and turkeys all belong to the species “poultry“, but environmental effects of installations with these kinds of animals and the same number of places are considerably different. In addition it makes a difference whether young animals are reared or older animals are fattened.

To overcome these problems, animal places can be expressed in terms of animal masses (Livestock Units - LU, 1 LU = 500 kg animal mass), as environmental effects depend strongly on the average animal mass during a production period. Animal masses equate approximately with manure production and emissions. They may be defined as the time-integrated average animal mass over a production period or cycle on the basis of the animal-specific growth-function, which is available for every kind of animal (Table 7.1). This enables different kinds (breeding, fattening) and stages (weaning, growing-finishing) of production, housing periods and changing production processes to be taken into consideration.

Animal species	Animal mass (LU)
<b>Pigs</b>	
- boar or pregnant sows	0.3
- sows with piglets ( $\leq 10$ kg)	0.4
- sows with piglets ( $\leq 20$ kg)	0.5
- rearing of piglets (7 – 35 kg)	0.03
- young sows (30 – 90 kg)	0.12
- fattening pigs (20 – 105 kg)	0.13
- fattening pigs (35 – 120 kg)	0.16
<b>Poultry</b>	
- laying hens (average mass 2 kg)	0.004
- laying hens (average mass 1.7 kg)	0.0034
- young hens (average mass 1.1 kg)	0.0022
- broiler (fattening period 25 days, average mass 0.41 kg)	0.0008
- broiler (fattening period 36 days, average mass 0.7 kg)	0.0014
- young ducks (average mass 0.65 kg)	0.0013
- ducks (average mass 1.1 kg)	0.0022
- ducks (average mass 1.9 kg)	0.0038
- rearing of turkeys (average mass 1.1 kg)	0.0022
- turkeys (hens, average mass 3.9 kg)	0.0079
- turkeys (male, average mass 8.2 kg)	0.0164

**Table 7.1: Animal species expressed in livestock units**  
[124, Germany, 2001]

## 7.2 References to European legislation

Intensive pig and poultry farms have the potential, if not properly managed and controlled, to lead to deterioration in the environment and to cause environmental pollution. The potential pollutants range from direct to accidental emissions to water, soil and air as well as the waste generated and to a lesser extent noise emissions. There is a comprehensive body of EU legislation designed to reduce and avoid pollution from various sectors. The legislation is generally aimed at protecting water, air, soil and the environment rather than limiting emissions from the various sources. There is also legislation on animal health and welfare that must be taken into consideration.

Many European directives directly or indirectly impose requirements on agricultural activities and they can be found, for example, on the following web pages:

- [http://europa.eu.int/eur-lex/en/lif/ind/en\\_analytical\\_index\\_15.html](http://europa.eu.int/eur-lex/en/lif/ind/en_analytical_index_15.html)
- <http://europa.eu.int/comm/environment/agriculture/index.htm>
- [http://europa.eu.int/comm/food/index\\_en.html](http://europa.eu.int/comm/food/index_en.html)

### 7.3 National legislation of European Member States

In the national legislation of individual Member States a large number of European directives and their requirements are translated into emission limit values, quality standards and measures at national or farm level. Regulation of agricultural activities at farm level is fairly recent. In some countries general binding rules are applied, but the licensing of an individual farm is common practice in very few Member States.

This Annex presents an overview of some of the national environmental legislation that is currently applied to intensive farming installations.

#### Austria

Controlled emissions of waste water to surface water are regulated for intensive livestock farming. Discharge of slurry or liquid manure into surface water is not allowed [15, Austria, 1997; 14, BGB1.II 349/97, 1997].

Odour emissions from intensive livestock installations are regulated and will affect for the spatial planning of installations. The required distance between a farm building and an odour sensitive object is calculated by including a number of factors:

- an odour factor associated with the type of animal and its production phase
- a ventilation factor, combining the ventilation technique, air speed and position of emission point
- a factor associated with the manure removal system
- a factor associated with the type of feed system
- a meteorological factor representing the characteristics of the surrounding area, such as hills and mountains, and the effect on speed and direction of the wind
- a factor representing the purpose (use) of the surrounding area. [76, BMU, 1995]

#### Belgium

A national environmental action plan forms the framework for the legislation on intensive livestock. Within this framework, plans for ammonia reduction have been developed.

In Flanders, VLAREM is the Flemish regulation concerning environmental licensing including activities such as intensive livestock farming; it follows the definition in the IPPC Directive. VlareM contains general and sectoral requirements for the operation of installations. For intensive livestock installations the sectoral requirements concern regulation for the construction of housing and manure storage, and the treatment of manure.

Flanders is the most important region for intensive livestock farming with a concentration of animals per hectare comparable with the Netherlands. A decree concerning protection of the environment against contamination by manure has been issued, requiring low-emission application of manure. The task is to reduce the excess of minerals and to achieve for nitrate the quality standard of 50 mg NO<sub>3</sub> per litre of ground- or surface-water. Belgium has to reduce ammonia emissions by 31 %. Flanders has to apply to the national ammonia reduction programme and has to reduce 42.4 % of the national ammonia emissions and Wallonia 1.2 %.

A mixture of measures is proposed: measures at the source, such as feed measures (25 %), application of manure to appropriate soils or after previous treatment to achieve the required ratio (25 %) and further elimination by end-of-pipe measures without causing cross-media problems (50 %) [8, Technologisch Instituut, 1999].

Emissions to air are regulated in the VLAREM in terms of ammonia from housing and manure storage, emissions of dust from other storage equipment and manure drying facilities and emissions of NH<sub>3</sub>, NO<sub>x</sub> and H<sub>2</sub>S from on-farm incineration installations [39, Vito, 1999].

Planning of pig farms with respect to odour emissions assesses both the existing and future situation, using a system that rates the applied housing system and the number of animals in it or the installation to store manure. The rating is linked to the required minimum distance between the farm (or the emitting installation) and the nearest residential area, nature reserve or other sensitive object. For poultry the same system applies, combining housing design and manure storage facility with the number of bird places [39, Vito, 1999].

### **Denmark**

All commercial livestock farms in Denmark, including pig farms, are subject to a wide range of demands as to manure handling systems in the housing facilities, storing facilities as well as the location of the production units.

Pig houses and similar facilities, e.g. outside yards, have to be laid out so that ground-water and surface water do not run off. Flooring and manure channels have to be made of materials which are difficult for moisture to penetrate. At the same time there must be a discharge system. In practice, this means that all pig houses have cast concrete flooring.

Manure stores, i.e. manure pits, liquid manure stores and slurry silos as well as silage storing facilities, are subject to demands similar to those relating to housing facilities as the farmers have to see to it that no run-off occurs to the surroundings. Simultaneously, storage capacities must be large enough to comply with the rules concerning the spreading and utilisation of nutrients. For pig farms this normally means 9 months' storage capacity.

The location of commercial livestock farms in Denmark is subject to a number of restrictions. Generally, commercial livestock farming is not allowed in urban zones and summerhouse areas. Farms located in rural zones have to comply with a number of restrictions as to distance to neighbours, urban zone etc. These distances increase with increasing production volume. By way of example, pig farms with more than 120 LUs have to be located at least 300 m from urban zone. The distance applying to farms with less than 120 LUs is 100 m.

The purpose of these demands as to distance is to reduce the nuisances of neighbours, meaning that mainly nuisances in the form of odour and noise are to be reduced. For farms who are exempt from the general rules concerning distance the municipality may tighten the demands for livestock farming and layout of housing facilities, manure stores etc.

Livestock farms with more than 250 LUs (more than 210 LUs for broilers) are subject to special demands. These farms have to be approved in accordance with the Environmental Protection Act and in this connection an environmental impact assessment (EIA) has to be made before establishing or extending the premises.

The EIA rules imply a broader appraisal of the location and layout of the production facilities in relation to landscape, cultural history and biology compared to the environmental approval. The EIA rules are basically not to a tightening of the environmental control measures but the pollution from the farm is appraised together with other impacts on the environment. All this is done in one procedure where the county provides a special annex to the regional plan with an EIA statement and simultaneously the municipality works out an environmental approval. [87, Denmark, 2000]

**Germany**

[154, Germany, 2001]

Germany reported a large number of laws, decrees and administrative and technical guidelines that are related to the operation of an intensive livestock farm.

To control environmental problems related to livestock farming, in Germany activities such as the construction, enlargement or substantial alteration and operation of livestock building installations (e.g. housings, manure stores) require a permission. The term "substantial alteration" includes the change of utilisation (e.g. keeping pigs instead of cattle), the change of ventilation or manure removal system (e.g. slurry instead of manure) or any other alteration that might have serious impact on the environment. Approval depends on the location, type and number of animals kept and the environmental impact. With respect to the environmental impact, odour nuisance is the key issue.

Dependent on the type and number of animals kept, either an approval according to the Federal Building Code (Baugesetzbuch - BauGB) by the district authorities or according to the Federal Emission and Ambient Pollution Control Act (Bundes-Immissionsschutzgesetz - BImSchG) by the state intermediate authorities (regional government) or the district authorities is required. The latter is more strictly and obligate for farms with more than e.g. 750 sows and 2000 fattening pigs. Participation of public is possible. Capacity figures are laid down in the Fourth Ordinance Implementing the Federal Emission and Ambient Pollution Control Act – On Installations Requiring Permission – 4 BImSchV. This ordinance has been amended in March 1997 according to EC Directive (96/61/EC) on Integrated Pollution Prevention and Control (IPPC). Besides these figures IPPC is not yet transposed into national law.

In addition facilities for storing slurry with a capacity of 2500 m<sup>3</sup> or more are subject to permission according to BImSchG by the way of a simplified procedure without participation of public.

During permitting procedures authorities will check whether the farmer has met crucial obligations according to the BImSchG. Additionally establishment and operation must not conflict with any other provision under public law (e.g. water resources protection, nature conservation, building law) and labour protection concerns. If prerequisites are given, there is a legal obligation to grant the permission.

In the case of a permitting procedure according to the BImSchG application according to the Federal Building Code is included. Application forms include in particular general information on design and operation and a detailed description of the project (e.g. type and number of animals, housing systems and management of the livestock, amount of livestock wastes to be stored), the project and ground plans, evidence of proper structural engineering, a calculation of cost, a description of the sewerage system, information on type and quantity of emissions, and of location and dimension of sources. Measures to reduce emissions and to avoid environmental effects must be specified. Usually an assessment of odour immissions is carried out. Referring to livestock waste management, amount and composition (nitrogen content) of manure and slurry have to be estimated and a detailed inventory of agricultural land for manure application including cadastral maps is necessary. Type of soil must be indicated.

During the permitting procedure the enforcement authority will involve other authorities, e.g. for nature conservation, for preservation of historical monuments, for air pollution control and for the prevention of water pollution. Their statements get part of the permission. Not only other involved authorities must be informed, but also the public if serious effects on the environment are expected to arise. Documents must be open to the public. A meeting must be summoned to give public opportunity to discuss the project. Statements of authorities and public shall be taken into account when deciding upon approval. This permitting procedure lasts regularly 4 - 6 months, in some (problematic) cases up to one year and more.

Permitting according to BImSchG is very extensive, but it provides legal certainty. For the neighbours have the opportunity to take care for their interests during the permitting procedure, nobody has the right to request cessation of operation of an animal husbandry with a private prosecution subsequent if the permission has become final. Even if somebody is prejudiced by immissions, he may only insist on measures that are necessary to prevent effects. If such measures are technically not feasible according to the state of the art or economically not viable, compensation may only be claimed for the actual damage suffered.

Cost of permitting procedures (charges, preparation of documents for application) amount up to 1 % of expenses (EUR 3000 – 8000). Extra cost can be expected if an expert's report is required, e.g. for the prognosis and assessment of odour immissions (EUR 2000 – 5000). When an environmental impact assessment is required, the cost of permission might increase to up to EUR 15000. Although there are detailed regulations, requirements during permitting procedures will differ from federal state to state for they are responsible for enforcement.

### **Legislation with respect to the emissions to air**

Installations subject to permission according to BImSchG shall be constructed and operated in such a way that:

- they do not involve harmful effects on the environment or other hazards, considerable disadvantages and considerable nuisance to the general public and the neighbourhood (principle of protection). Referring to animal husbandry neighbourhood must be safe from odour nuisance. A safety distance between a certain livestock building and the next dwelling house usually guarantees this. In addition, poultry farms must keep this distance towards woodlands. These distances are recognised as immission standards
- precautions are taken to prevent harmful effects on the environment, in particular by such emission control measures as are appropriate according to the state of the art (Stand der Technik). According to the precautionary principle harmful emissions must be reduced by technical means below a certain limit. Limits depend on the hazardousness of the emissions, the technical feasibilities and the economic efficiency. In this context, odour emissions are usually regarded as less serious. In practice, if distances as mentioned above are too short and if environment is likely to be affected by the emissions, an assessment is necessary. Probably supplementary measures to reduce emissions and immissions must be taken
- waste is avoided, unless provision is made for its orderly and safe re-use and recycling, or if such avoidance and re-use or recycling is technically not feasible or not reasonable, is disposed without impairing the public welfare. Storing and application of manure is concerned by this regulation. Manure is not classified as waste, as long as its application complies with the Fertiliser Act (Düngemittelgesetz) and the Fertilisation Ordinance (Düngeverordnung) respectively. The latter is based on the Council Directive (91/676/EEC) of 12 December 1991 concerning the Protection of Waters against Pollution Caused by Nitrates from Agricultural Sources. Manure shall be applied according to site conditions and the demand of the plants in order to reduce nitrate leaching and run-off. For this reason the amount of manure applied to land each year shall not exceed 170 kg N/ha. A storing capacity of 6 months or more is obligatory. By technical and/or organisational measures ammonia emissions should be reduced (e.g. by band spreader, ploughing instantly after spreading or waiting with spreading for favourable weather conditions). Maximum losses of ammonia from slurry should not exceed 20 % during application. Further regulations concern the duty to estimate fertiliser demand of the land and to draw up a balance of nutrients. Additional regulations may include the duty to keep a minimum distance to surface waters, nature reserves or settlements while spreading. States are authorised to regulate application in detail by administrative rules.

During the permitting procedure authorities will check whether a project complies with obligations described above. For large-scale farms subject to permission according to BImSchG corresponding requirements (distance regulation, technical requirements) are laid down in the First General Administrative Guideline Pertaining to the Federal Emission and Ambient Pollution Control Act - Technical Instructions on Air Pollution Control (Technische Anleitung zur Reinhaltung der Luft - TA Luft). In addition, special guidelines on odour abatement in livestock farming published by the Association of German Engineers (VDI) (VDI 3471 - Emission Control Livestock Management Pigs, VDI 3472 - Emission Control Livestock Management Hens) describe livestock farming techniques in general, the sources of odour emissions, feasibilities to reduce emissions and immissions and a method for odour assessment in form of a minimum distance regulation as well. Those guidelines are accepted by the authorities and courts as so-called "anticipated expertise", because experts from various fields of knowledge worked together and established them.

### ***Distance regulations***

#### **Odour**

Both TA Luft and VDI Guidelines prescribe a distance regulation to avoid odour nuisance. Regulation of the TA Luft is based on VDI Guidelines. But in contrast to VDI Guidelines the minimum distance is only a function of the number of animal places and distances are valid only between livestock units and dwelling houses under optimal emission and dispersion conditions. It is not given special attention neither to the fact that the neighbourhood in villages has to tolerate higher levels of nuisance compared to residential areas nor that emissions from pig breeding are only half of that from fattening pigs. In addition natural ventilated housing systems are not considered. Though distance regulation has been established with odour in mind, it applies for the distance of poultry housings to woodlands too. If distances are too short, waste gas should be treated in biofilters or bioscrubbers. For these installations are almost too costly, a special odour assessment is conducted.

The distance regulation of VDI Guidelines allows a more detailed assessment than that of the TA Luft. It proved successful in practice in thousands of cases. The distance is determined in three steps:

1. Calculation of the average animal masses (livestock units LU, 1 LU = 500 kg; e.g. pigs 0.12 LU) corresponding to the number of animals kept. If there are different kinds of animals on a farm, animal masses can be multiplied by an animal-specific odour-equivalent-factor (e.g. feq = 0.5 for sows, 0.17 for cattle, 0.39 for turkeys and 0.94 for ducks). This factor is a function of the animal-specific odour emissions referred to fattening pigs (feq = 1).
2. A point-system is used to rate the emission potential of various livestock parameters such as manure removal and storage, ventilation system and other criteria (feeding, slurry storage capacity, influences by the site). Parameters leading to lower emissions are rated better than those causing higher emissions. The maximum rate is 100 points.
3. From a distance diagram the minimum distance between the livestock farm and the neighbourhood can be read.

### **Technical requirements in practice**

Besides a distance regulation TA Luft prescribes technical requirements for livestock farming installations. These are the same as the preconditions for the use of the distance regulations of VDI Guidelines. The following measures shall usually be applied:

- animal housings should be as clean and dry as possible. This affords especially a high standard of hygiene, to use always enough bedding of high quality, the regular removal of manure, no overstocking and sufficient ventilation
- the ventilation system should be designed according to the German Standard on "Thermal insulation for closed livestock buildings; Thermal insulation and ventilation; Principles for planning and design" (DIN 18910) to guarantee an air exchange rate suitable to the animal needs. Naturally ventilated housings are not affected by this requirement
- if slurry is drained-off the housings, provisions have to be made to prevent noxious gas and odour migration
- manure is to be stored on a liquid-tight concrete base. In the case of a slurry system, the area where the tanker is filled should be liquid-tight. In both cases precipitation should be collected and drained-off in appropriately closed collection tanks to avoid water pollution
- slurry should be stored outside the housings only in closed tanks or equivalent measures to reduce emissions must be taken
- a storing capacity of 6 months is prescribed. A smaller capacity is sufficient if slurry is treated (e.g. aerobic treatment by composting, forced drying or anaerobic digestion).

There is sometimes discussion about the term "equivalent measures to reduce emissions" from storing tanks. In practice besides concrete or light construction roofs floating covers consisting of natural floating crusts, of straw, burnt clay pellets and plastic are used. The build up of an artificial floating cover is supported by mixing chopped straw (7 kg/m<sup>2</sup> surface area) into the slurry. Several investigations revealed, that even with floating covers made of straw emissions can be reduced up to 90 %. For this reason floating covers made of straw are not only equivalent to closed tanks but also most cost effective. Annual cost are about 30 % - 50 % lower than for covers made of clay pellets or plastic and 60 - 70 % lower than for light construction roofs.

### **Water conservation regulations**

When discussing the water legislation requirements, it is necessary to differentiate between the requirements in dependency of:

- the site of operation affecting the structural condition of animal housings and slurry stores
- the livestock management, especially in areas which are sensitive referring to management of water resources, such as water conservation areas and medicinal spring conservation areas or areas subjected to flooding.

The legislation governing the environment in Europe which is essentially codified in directives and which includes the laws governing water is only partly regulated uniformly in the individual states in Germany's federal legal system. The states are authorised to fill in details of the system of standards under federal law, which is largely designed as a skeleton law, so that different requirements may be made of agricultural livestock production in the individual federal states.

### ***Water conservation in regulations under federal law***

On the federal level the Water Resources Management Act (WHG) contains both rules on the nature of facilities for storing and filling liquid manure, slurry and silage effluents (§ 19 g WHG) and the obligation to apply the due care necessary according to the circumstances to prevent pollution of the water or any other negative change in its properties when implementing measures which can be connected with effects on a water body (§ 1 a WHG). In water conservation areas it may additionally be necessary, for reasons of precautionary averting of danger, to prohibit certain actions or to declare them only allowable to a restricted extent when bodies of water are to be protected against negative influences in the interest of currently existing or future public water supplies, or when rain-washing or discharge of fertilisers into bodies of water are to be prevented (§ 19 WHG).



In addition, in facility permit procedures for large-scale livestock and poultry management operations, the Federal Emission and Ambient Pollution Control Act (BImSchG) stipulates that these facilities are to be constructed and operated in such a fashion that wastes - which also include slurry, liquid manure and silage effluents - are properly and safely utilised (§ 5 BImSchG). Details of this proper utilisation are governed in the Fertiliser Act (§ 1 a) and in the Fertilisation Ordinance issued on the basis of the Fertiliser Act, which are detailed below.

### *Regulations under state law*

The requirements under federal law are set out in more concrete terms at the level of state law. Thus the obligation contained in § 19 g WHG to construct and maintain facilities for storing and filling liquid manure, slurry and silage effluents in such a manner that bodies of water are protected in the best possible manner against pollution is specified in detail in orders decreed by the states. These orders, which are similar in principle but which differ in detail, are based on the fundamental requirements that facilities must be tight, stable and sufficiently resistant to thermal, mechanical and chemical incidents. Leaks and any spillage of water-hazardous substances must be identified quickly and reliably. The generally recognised rules of the art for the construction of slurry tanks and fermenting silos are contained in the German Standard on "Silage and liquid manure containers" (DIN 11622), which is valid on a federal basis. General requirements made of collecting and filling facilities include:

- pipes must be made of corrosion-resistant material. The return line from the storage tank to the preliminary pit or the pumping station must be equipped with two gate valves for safe shut-off. One of these should be a quick-acting gate valve
- gate valves and pumps must be easily accessible. They are to be arranged over a water-impermeable area
- pits, ducts and channels must be constructed in a fashion impermeable to water
- places at which liquid manure or slurry are filled into containers must be paved in a fashion impermeable to water. Rainwater is to be discharged into the preliminary pit, liquid manure pit or the pumping station of the filling facility
- facilities for storing solid manure are to be equipped with a tight and water-impermeable bottom plate. In order to discharge the liquid manure, the bottom plate is to be contained at the side and be protected against the penetration of surface water from the surrounding terrain
- if it is not possible to discharge the liquid manure into an existing liquid manure or slurry pit, it must be collected separately
- the capacity of the facilities must be adjusted to the requirements of the relevant farm unit and of water conservation. The capacity must be greater than the capacity necessary during the longest period in which application on agricultural land is prohibited, unless it can be proven to the competent administrative authority that the quantity exceeding the stated capacity will be disposed of in an environmentally sound fashion. Proper agricultural use or spreading of the contents must be assured. In the case of open tanks, a minimum freeboard and a safety margin for rainfall must be maintained at each place
- facilities in water conservation areas and medicinal spring conservation areas must be additionally equipped with a leak identification device.

However, there are deviations between the states regarding e.g. the determination of the necessary storage capacity. For instance in the case of slurry channels, consideration ranges from crediting of the complete volume as storage space to complete disregard of the channel volume. Different leak identification systems apply for monitoring tightness. For instance, in some states soil samples, in others ground water examinations are necessary in addition to a visual inspection. These different requirements lead in part to substantial differences in costs for farms, without objective construction-specific justifications for this applying in all cases.

### ***Special regulations in protected water grounds***

In areas requiring special protection such as water conservation areas and medicinal spring conservation areas, livestock production is subjected to far-reaching restrictions. Thus on the one hand requirements extending beyond the general state of the art apply for the structural condition of storage tanks. Buried liquid manure reservoirs in water conservation areas without sufficient covering layers are just as inadmissible (Higher Administrative Court Lüneburg, ZfW 93, 117) as buried reservoirs with sealing strips made of plastic (Higher Administrative Court Lüneburg, ZfW 97, 249). In the area covered and the inner protected zone, facilities for storing and filling liquid manure, slurry and silage effluents and for storing solid manure are generally prohibited completely, and in the extended protected zone they are only admissible if equipped with special leak identification devices.

In some rules governing conservation areas, grazing is also forbidden in the inner protected zone and there is a ban on spreading non-hygiene-treated slurry in the inner and extended protected zones.

Since such restrictions on land-use lead to substantial extra economic burdens for the farms affected, in 1987 the legislator included a rule in the Water Resources Management Act (§ 19 Para. 4 WHG) according to which reasonable compensation is to be paid for the economic disadvantages caused by the more stringent requirements. The rule reflects the ‘burden-sharing’ principle which applies in environmental legislation alongside the ‘polluter-must-pay’ principle, according to which the rules issued in the interest of the general public for protection of bodies of water may not be solely for the account of an occupational group particularly affected by them. The nature and extent of the obligation to pay compensation vary widely in part in the state water legislation. However, the ban on water-hazardous storing of fertiliser or field silage with fermentation juices, as well as the ban on spreading liquid manure or on nitrogen fertilisation outside the growth period, do not represent higher burdens for farm units which give rise to compulsory compensation, since these bans apply generally and not only in conservation areas. The extra construction costs for slurry and farmyard manure storage resulting on the basis of water conservation orders do not lead to a claim for financial compensation either, since only the direct agricultural use is covered by the obligation to pay compensation under § 19 Para. 4 WHG, but not non-recurrent construction conditions (Federal High Court of Justice, NJW 1998, 2450 ff.).

### **Fertilisation and waste management law**

German law on fertilisation limits the quantities of farm and secondary resource fertilisers which may be spread, on the basis of the nutrient content of fertilisers. When secondary resources are utilised, for instance fermentation residues from agricultural co-fermentation (simultaneous fermentation of farm manures of animal origin with organic wastes), the provisions of the German Organic Waste Ordinance (Bioabfallverordnung, BioAbfV) also come into play in addition to the fertiliser regulations.

The following survey provides an overview of the statutory provisions to be observed in the spreading of solid organic manure and secondary resource fertilisers.

#### ***Waste management law***

Due to the German Waste Management Act of September 27, 1994 (Gesetz zur Vermeidung, Verwertung und Beseitigung von Abfällen) a new set of regulations in waste management law and related areas of the law was provided.

Article 1 contains the German Closed-Loop Materials and Waste Management Act (Kreislaufwirtschafts- und Abfallgesetz, KrW-/AbfG), which makes it mandatory to promote the closed-loop management approach, so as to conserve natural resources and ensure the

environmentally sound disposal of waste. The KrW-/AbfG confers delegated powers to issue an array of statutory ordinances (Arts. 7 and 8; sub-statutory regulations 1996, BioAbfV 1998).

Article 4 covers the simultaneously required amendments to the German fertilisers legislation: the 1999 Fertiliser Ordinance (Düngemittel-verordnung), the 1996 Fertilisation Ordinance (Düngeverordnung), and the 1998 Sewage Sludge Compensation Fund Ordinance (Klärschlamm-Entschädigungsfondsverordnung).

Where farm manures are utilised exclusively, the provisions of waste management law only come into play when application is carried out contrary to the provisions of the Fertiliser Ordinance, i.e. not carried out with regard for the appropriateness of the site and the nutrient needs of the crops, but with the primary purpose of disposing of farm manure. Waste management law also has a bearing on the biological treatment and agricultural utilisation of mixtures of farm manures and organic waste, such as arise in the form of process residues from agricultural co-fermentation facilities.

The Ordinance on the Recycling of Organic Wastes on Agricultural, Silvicultural and Horticultural Soils (BioAbfV) regulates the agricultural, silvicultural and horticultural utilisation of organic wastes (including those mixed with farm manures). Annex 1 of the BioAbfV lists the organic waste materials that may be treated in a biogas plant. Furthermore the responsible waste authority may permit additional materials if they are suitable for biological treatment and agricultural utilisation.

The BioAbfV also details the obligatory documentation to be obtained by facility operators (e.g. hygiene clearance, low pollutant content). The quantity of organic waste which may be landspread per hectare within a three-year period is limited and depends on soil heavy metal content. A soil analysis for heavy metals and pH value is to be carried out prior to first spreading. Repeat spreading of organic wastes is prohibited if levels in the soil are found to exceed the limits prescribed in the Ordinance.

### ***Fertiliser law***

The Fertiliser Act specifies that fertilisers may only be applied in line with agricultural ‘good practice’ (Art. 1a: gute fachliche Praxis). This entails criteria for fertilisation including adjusting the type, quantity and timing of nutrient applications according to the needs of the crops and the soil, taking account of the nutrients and organic matter available in the soil and the site and cultivation conditions. The nutrient needs of crops are determined by their potential yields in the given site and cultivation conditions and the produce quality standards expected (Art. 1a, para 2).

The permitted fertilisers are regulated in Article 2, under which fertilisers may only be put into circulation if they correspond to a fertiliser type permitted by statutory provision. According to the Ordinance on Good Practice in Fertilisation (Verordnung über die Grundsätze der guten fachlichen Praxis beim Düngen – Düngeverordnung) Fertilisers are to be spread at times and in quantities that allow crops to take maximum advantage of the nutrients, and in a way ensuring that in cultivation nutrient losses and associated harmful inputs into water resources are prevented to the greatest possible extent. Nitrogenous fertilisers may only be applied so as to make the nutrients they contain available to plants essentially during the growing season and in quantities corresponding to their needs. Any direct inputs into surface water are to be avoided by maintaining an adequate safety distance, among other measures. Nitrogenous fertilisers may only be spread when the soil is receptive to them. A soil is not receptive when it is waterlogged, frozen solid or has a heavy covering of snow.

To calculate the quantity of nitrogenous fertilisers to be spread, the principles of establishing the fertilisation requirements are to be observed. This entails taking into account:

- the nutrients needed by particular crops to attain their expected yields and quality given the site and cultivation conditions
- the quantities of nutrients available in the soil and additional quantities of nutrients likely to become available to the crops during the growing season
- nutrient fixation.

In the case of farm manures of animal origin, taking account of the other principles of the Ordinance, the average application per holding should not exceed 210 kg total nitrogen per hectare per year on grassland, and 170 kg total nitrogen per hectare on arable land (net values, i.e. after deduction of permitted storage and spreading losses); set-aside land must be excluded for the purposes of calculating the average for the holding. Furthermore farm manures of animal origin which are high in phosphates or potassium may only be spread up to the level of the net phosphate or potassium uptake of the crop, taking into account the expected yield and quality, and only if no harmful impact on water resources is anticipated.

In line with the Ordinance, nitrogen inputs following harvest, in autumn or in early winter, on fallow fields which are not to be cultivated until the spring, are not normally permitted. The Fertiliser Ordinance (Düngemittelverordnung) regulates the licensing and putting into circulation of fertilisers. Where the intention is to put into circulation fermentation residues containing organic wastes (even without charge) these must correspond to a permitted type of secondary resource fertiliser. In this regard, restrictions must be observed pertaining to the permitted feedstock substances for producing secondary resource fertilisers, e.g. in this case no rendered animal fat, food wastes etc. may be included in the fermentation process.

Under the German Soil Protection Act (Bundesbodenschutzgesetz, BBodSchG) agricultural use of the soil must be in accordance with agricultural 'good practice', i.e. soil must be worked and soil structure maintained or improved appropriately given the climate and the site, soil compaction must be avoided (as far as possible) and soil erosion prevented by site-appropriate utilisation.

### **Animal welfare and animal diseases law**

The Animal Welfare Act (Tierschutzgesetz) constitutes the central provision regarding animal welfare in Germany. The Act is based on ethical animal welfare and aims at protecting animals from pain, suffering or harm. The Act applies to all animals, irrespective of their uses, i.e. to productive livestock, to domestic animals as well as to laboratory animals. It regulates the keeping of these animals as well as their use.

Source: [154, Germany, 2001] with reference to:

- Grimm, E., Kypke, J., Martin, I., Krause, K.-H. (1999): German Regulations on Air Pollution Control in Animal Production. In: Regulation of animal production in Europe. KTBL-Arbeitspapier 270, Darmstadt, 234-242
- Schepers, W., Martin, I., Grimm, E. (2000): Bau- und umweltrechtliche Rahmenbedingungen. In: Zukunftsweisende Stallanlagen. KTBL-Schrift 397, 11-33
- Nies, V., Hackeschmidt, A. (1999): Water Conservation Regulations in Germany – Differences between the Federal States and Impacts on Livestock Production. In: Regulation of animal production in Europe. KTBL-Arbeitspapier 270, Darmstadt, 129-132
- KTBL e.V. (Hrsg.): Bau- und umweltrechtliche Rahmenbedingungen der Veredelungsproduktion. KTBL-Arbeitspapier 265, Darmstadt 1998
- Bauförderung Landwirtschaft e.V. (Hrsg.): Hilfestellung bei Genehmigungsverfahren für Tierhaltungen. Baubrief Landwirtschaft 38, Landwirtschaftsverlag Münster-Hiltrup 1998
- Schwabenbauer, K. (1999): Animal Welfare Provisions and their Practical Application in Germany. In: Regulation of animal production in Europe. KTBL-Arbeitspapier 270, Darmstadt, 90-92
- InfoService Tierproduktion (IST): Network on information about laws and permitting relevant for agricultural building projects – Informationsnetzwerk zu Rechts- und Genehmigungsfragen bei landwirtschaftlichen Bauvorhaben; <http://www.ist-netz.de>

## **Greece**

Greek legislation for intensive farming is primarily concerned with the protection of water resources. Limited storage in earth “tanks” is allowed if the soil is not porous. The re-use of treated waste waters is allowed (1) for land application only if they have  $BOD_5 \leq 1200$  mg/l, and (2) for disposal to carry out surface waters only if they have  $BOD_5 \leq 40$  mg/l. Application is allowed in combination with the substitution of chemical fertilisers.

## **Finland**

The Environmental Protection Act (86/2000) and other legislation based on this document came into effect on 1 March 2000. The new Act repealed the Acts on Air Protection and Noise Prevention, Environmental Permit Procedures Act and the decrees based on these as well as on the Decree on Preventive Measures in Water Protection. Various acts, such as the Water, Waste, Adjoining Properties and Health Protection Acts were amended. Water rights courts were closed, and most of their duties were transferred to the environmental permit authority established on 1 March 2000. The harmonisation of the environmental protection legislation lays the foundations for the integrated study of environmental damages.

The environmental permit for livestock stables concerns the keeping of animals in production buildings. Livestock stables comprise the storage of manure produced by the animals as well as processing and storage of feed in connection with the production buildings. Manure spreading and arable farming are not subject to licence. However, the surface area available for manure spreading is taken into consideration in the permit procedure.

At the moment, there are no spatial planning regulations or guidelines concerning odour.

A government decree on preventing the passing of agricultural nitrates into bodies of water applies Council Directive 91/676. It concerns all agricultural activities and imposes requirements for storage time of manure, for manure stores, the time of spreading of fertilisers (i.e. manures) and the amounts allowed [125, Finland, 2001].

## **Ireland**

IPPC legislation under the Environmental Protection Agency Act (1992) introduced a licensing system controlling emissions from pig and poultry installations in an integrated manner.

One of the most generally applied approaches to ensure that odour is not a nuisance is to use a setback approach, which means that units are not allowed within a specified distance of residences or odour sensitive locations. These distances may be measured based on an odour dispersion model. Limit criteria in terms of odour units are set. [61, EPA, 1997]

## **The Netherlands**

The Netherlands has high densities of pigs and poultry. Much attention is therefore paid to the application of manure and contamination of soil and groundwater, as well as the emission of ammonia and odour. A permitting system as operated under the responsibility of the local governments (municipality) is currently in use. Stricter rules will apply in the coming years. Although standards are applied equally to all farmers, stricter requirements will apply in the south and the east of the country where most of the ammonia-emitting farming is.

The Dutch government has adopted a policy in three stages to reduce the mineral losses to the environment. This programme is now in its third stage. The objective is to achieve an acceptable level of nitrogen and phosphate losses to the environment. One of the tools to achieve this is the

use of a Minerals Accounting System, which allows a better understanding of mineral input and output on a livestock installation [85, Oele, 1999].

Emissions to air from manure application are regulated by the Use of Livestock Manure Decree obliging the use of low-emission application techniques [21, VROM, 1998].

Planning regulations allow manure application only during autumn and winter, which means that requiring sufficient storage capacity is needed. Manure storage built after 1 June 1987 has to be covered.

Ammonia emissions, mainly from housing, are reduced by obligatory use of certain types of housing (Green Label housing units). Under a government inspection scheme, systems can qualify for a Green Label. Farmers with Green Label housing are exempt for a certain period of time from new ammonia reduction measures to encourage them to invest in low-emission housing. Developments in housing techniques and increasing knowledge will head to stricter animal housing requirements.

For regulation of odour emissions and spatial planning, a complicated model is applied that categorises sensitive objects around a farm or a number of farms and identifies their distance from the point of emission. For each farm, a ratio of the number of animals housed and the number of animals allowed (considering legislation and given the local circumstances) is calculated. Per sensitive object the relative individual contributions to the odour nuisance of all farms are aggregated and should not exceed a certain value for each sensitive object. If they do, measures must be taken, including reduction of stocking density [24, VROM/LNV, 1996].

Noise standards for intensive livestock farms are set on an individual basis and laid down in the environmental permit for a farm. The Dutch Environmental Management Act and the Dutch Noise Nuisance Act form the basis for setting of noise standards in the permit. New intensive livestock farms will have to comply with the noise level defined for the area. Use can be made of an instrument called 'zoning' where a number of different agricultural and industrial activities take place in the same area. The noise 'zone' combines the noise emissions of all activities in that area.

Extension of existing farms must take place within the existing limits set in the permit. Any additional noise associated with the extension of farming activities will have to be compensated by reduction measures (e.g. insulation) or relocation of activities.

## **Portugal**

In Portugal, there is no specific legislation for protection of waters caused by nitrates from agricultural origin. In the same way, it was published the "Code of Good Practices for Protection of Water against Pollution by Nitrates of Agricultural Origin". Apart from this "Code" there is specific legislation for the designated NVZs and respective associated Action Programme Rules.

A specific decree sets emission limit values for discharges of waste water to surface water from pig installations, expressed in terms of BOD<sub>5</sub> and TSS. There is no similar decree for poultry installations. The emissions of other substances (e.g. N, P and heavy metals) via waste water are regulated through separate decrees, either for discharges to surface water, or to agricultural soil. The emission of heavy metals to agricultural soil via application of slurries and/or manure are regulated through again another decree

Air emissions are regulated by limiting the emissions of NO<sub>x</sub> (as mg N<sub>2</sub>), VOC (as mg C), H<sub>2</sub>S and dust. Noise is regulated for both sectors in a general way by limiting the immission to 5 dB during day-time and 3 dB during night-time, compared with the background noise. New regulations also uses another criterion, based on maximum noise exposure.

Several decrees lay down rules for the operation of pig farms. The most recent one is Decree Law N° 163/97 with rules on the registration, authorisation, classification, designation and operation of pig farms. Similar laws exist for poultry farming.

### **Spain**

In Spain, Royal Decree 324/2000, adopts an integrated approach to the sanitary and environmental aspects of pig production. By means of this Royal Decree, minimum sanitary distances from sensitive objects such as other pig units, residential areas, public thoroughfare, etc. are fixed. These distances are linked to the number of LU in the installation. In addition, this is the first Royal Decree that fixes the maximum capacity of pig production units.

### **United Kingdom**

Currently there is no 'permitting' of farms in the UK, although this will change with the implementation of IPPC for large pig and poultry installations. In the Nitrate Vulnerable Zones, farmers must comply with the mandatory Action Programme Rules. There is no national legislation concerning landspreading except in NVZs. Guidelines and information on manure planning for farmers in NVZs has been issued.

On a more general basis, a large number of rules are listed in Codes of Practice, which have been issued to inform the farmer about measures to take to reduce emissions to water and soil. Emissions to surface water can be allowed under a 'discharge consent' with appropriate conditions (volume and emission limit levels) attached. Legislation makes it an offence to knowingly pollute surface or groundwater.

Reduction of emissions to air of odour and dark smoke are described in the Air Code [43, MAFF, 1998]. There are no emission controls on ammonia.

There are regulations dealing with planning consents. Planning permission is required for new or extended livestock buildings and slurry or manure storage facilities within 400 metres of any protected building such as houses and schools etc.

## 7.4 Examples of emission limit values and manure spreading limits in Member States

The following tables show the estimated average emission values and the tolerated spreading limits applied to pig and poultry farms in the environmental permits of Belgium.

Type of crop	P <sub>2</sub> O <sub>5</sub>	Total N	N from animal and other manure	N from chemical fertiliser
Grassland	130	500	250	350
Maize	100	275	250	150
Crop with low N demand	100	125	125	100
Other crops	100	275	200	200

**Table 7.2: Maximum tolerated limits to organic N- and P<sub>2</sub>O<sub>5</sub> application (kg/ha) by landspreading of manure in Flanders from 1-1-2003**  
[8, Technologisch Instituut, 1999]

Type of crop	P <sub>2</sub> O <sub>5</sub>	Total N	N from animal and other manure	N from chemical fertiliser
Grassland	100	350	170	250
Maize	100	275	170	150
Crop with low N demand	80	125	125	70
Other crops	100	275	170	170

**Table 7.3: Maximum tolerated limits to organic N and P<sub>2</sub>O<sub>5</sub> application (kg/ha) by landspreading of manure in Flanders in sensitive zones concerning water**  
[8, Technologisch Instituut, 1999]

Parameter	Emission limit value (mg/Nm <sup>3</sup> ) <sup>1)</sup>
Emission of dust particles from grinding, drying or cooling of mineral manure (dry gas)	75
Emission in flue gas of on-farm incineration installations	NH <sub>3</sub> 50 H <sub>2</sub> S 5 NO <sub>x</sub> 200

*1) mg/Nm<sup>3</sup> with 0°C, pressure 101.3 kPa*

**Table 7.4: Examples of emission limit values for certain on-farm activities**  
[39, Vito, 1999]



## 7.5 Example of protocol for monitoring of ammonia emissions from housing systems

In Europe, data on the consumption and emissions of intensive livestock farms are collected in different ways. It is not always clear under what circumstances data have been collected; where many factors account for the variation in the observed levels.

In the Netherlands, a protocol has been developed to measure emissions of NH<sub>3</sub> from housing systems for all production species to allow comparison of the emissions of alternative housing techniques. The protocol standardises the factors thought to be relevant for emission variation, such as indoor climate, feed and occupancy rate [63, Commissie van Deskundigen, 1999].

For poultry and pig housing, several factors have been summarised in Table 7.5 and Table 7.6.

Factor	Layers	Broilers	Turkeys <sup>1)</sup>	Ducks	Guinea fowl
Housing (cm <sup>2</sup> )	450 – 600	20/m <sup>2</sup>	2000 – 2500	6 – 8/m <sup>2</sup>	20/m <sup>2</sup>
Minimum indoor temp. (°C)	20 – 25	35 – 20	26 – 15	34 – 12	35 – 20
Feed	see text	see text	see text	see text	See text
Production (kg)	see text	1.825 in 43 days	18 in 20 wk (m.) 9 in 16 wk (f.)	2.95 in 47 days	1.5 in 43 days
Health (loss %)	<5	<10	<10	<5	<10
Minimum number per unit	750	1000	250	400	1000
Measuring periods	2	2	2	2	2
Correction factor	61/63	6/8	21/23	47/56	6/8
<i>1) (m) = male; (f) = female</i>					

**Table 7.5: Examples of factors to include in the measurement of emissions from poultry housing [63, Commissie van Deskundigen, 1999]**

The indoor temperature is very important and is lowered with increasing weight. With the exception of layers, the temperature is maintained at a constant level, the temperatures mentioned in the table are the maximum to the minimum temperatures for a production period.

With respect to feed it is important to consider the nutrients (raw proteins), the cation/anion-balance and the effects on the emissions of urea, and to exclude feed additives that may affect the pH of urine. Water is given ad lib, except for layers, where water can be rationed.

To assess the emission levels, a comparable growth rate is important: hence the given estimated end weight and the associated growing periods. For layers, egg production and egg quality must be recorded to enable adjustment if needed.

There should be two periods of measuring, with one period in summer when emission levels are potentially at their highest. In the calculation the emissions have to be adjusted for periods of empty housing between two production periods, also called occupancy rate, which for layers is about 3 % and for broilers can be up to 25 % of the time. The average measured emission over two periods per animal per day multiplied by the correction factor and 365 gives the emission per animal place per year.

For pigs a similar protocol can be applied. The factors and their values are summarised in Table 7.6.

Factor	Mating/ gestating sows	Farrowing sows	Weaners	Finishers
Housing (m <sup>2</sup> )	2.25	4.0	0.4	variable
Indoor climate (°C)	15	see text	see text	see text
Feed	see text	see text	see text	see text
Production (kg)	n.a.	n.a.	8 – 11 to 23 – 27 (350 g/day)	23 – 27 to 80 – 90 (700 g/day)
Health (loss %)	n.a.	n.a.	<5	<5
Minimum number in group	20	6	30	50
Measuring periods	2	2	2	
Correction factor	100/105	100/110	100/110	110/110
n.a.	not applicable			

**Table 7.6: Example of factors to include in the measurement of emissions from pig housing**

The slatted surface area per finisher is not constant but increases with increasing weight. Each minimum surface requirement is associated with a minimum surface requirement for the unslatted part. The surface requirements increase from 0.4 m<sup>2</sup> (0.12 unslatted) at 30 kg to 1.3 m<sup>2</sup> (0.40 unslatted) for animals above 110 kg.

The indoor temperature should be kept at a minimum which varies with age and production stage. The higher the weight the lower the temperature. The minimum temperature of the thermo-neutral zone is applied, except for finishers, where the minimum temperature is at maximum 2 °C lower than the minimum temperature of the thermo-neutral zone.

With respect to feed it is important to consider the nutrients (raw proteins), cation/anion-balance and the effects on the emissions of urea, and to exclude feed additives that may affect the pH of urine.

For finishers it must be noted that average growth per day and the finisher weight apply to the most common finishing practice in the EU. If finishers are grown to 160 kg of live weight before slaughter, the average daily growth will be different and may affect the emission level.

For finishers, there should be two measuring periods also with one period in summer at the moment of potentially elevated emission levels.

In the calculation the emissions have to be compensated for periods of empty housing between two production periods. Except for weaners this is assumed to be 10 % of the total production time. The average measured emission over two periods per animal per day, multiplied by the correction factor and 365 gives the emission per animal place per year.

## 7.6 Example of calculation of costs associated with the application of emission reduction techniques

The scope of this annex is limited to describing an approach that can be used for calculating the cost of individual techniques proposed under the framework of the IPPC Directive. The approach described relates to the 'unit' cost of techniques; it has also been adopted by UNECE for part of the process of calculating the compliance costs of reducing ammonia emissions from livestock production

This annex further implies that for this approach to be adopted, all techniques to be considered in the determination of BAT should be presented with the required technical and financial data as listed in the tables. As regards the cost data that are needed for assessment of BAT in a general sense, this annex can therefore be considered a proposal for a future updating of this BREF.

This annex is largely based on work done by DEFRA, UK, in turn based on work by an expert-group within the TWG on cost assessment and BAT [161, MAFF, 2000] [216, UK, 2002]

### Methodology

This section comprises the following topic areas:

- overview
- type of measure
- calculation of 'unit' costs.

### Overview

The calculation of unit cost requires a clear understanding of:

- the proposed technique to be introduced to reduce emissions
- the whole range of systems of production and management that are found on relevant farms
- the impact that the introduction of the technique will have on farm production and management systems in both physical and financial terms as well as in terms of costs and benefits.

the calculation will result in an annual cost, which may comprise an allowance for capital expenditure amortised over the life of the investment.

Once calculated, these costs can be used in:

- the calculation of the cost of individual, or a combination of, techniques per kilogram of pollutant abated
- the determination of general BAT
- the relationship between the costs of BAT implementation and the economic viability or profitability of the intensive livestock industry
- the cost to the industry of compliance.

### Categories of technique

Techniques applicable to the intensive livestock sector may be categorised as follows:

- feed
- housing
- manure storage
- treatment of manure
- application of manure to land.

(Note: 'Manure' may be liquid slurry or solid manure)

A technique should be identified under one of the above categories, and according to livestock category affected; for example, laying hens or breeding pigs. The categories are subsequently used to identify how 'unit' costs should be calculated.

### **Calculation of Unit Costs**

Unit costs are the annual increase in costs that a typical farmer will bear as a result of introducing a technique. The general approach to the calculation of unit costs is as follows:

- define the physical and husbandry changes resulting from implementation of the abatement technique based on a thorough understanding of current farming systems
- for each technique identify those areas where cost or performance changes will be associated with the introduction of that technique
- in all cases, only those costs directly associated with the technique should be considered
- additional costs associated with any technical enhancements should be ignored.

The category that techniques fall into will determine the physical units that are used to define the population or quantities of manure, and form the basis of subsequent calculations. The relationship can be seen in the following table.

Category	'Units'	Details
Feed	per head	Per head of livestock
Housing	places	Building capacity
Manure storage, treatment and land application	m <sup>3</sup> or tonnes	Liquid slurry (including dilution) and solid manure (including bedding)

**Table 7.7: 'Units' used for assessing costs**

Unit costs should be calculated according to the general approach described below:

- current costs should be used for all calculations
- capital expenditure, after deducting any grants, should be annualised over the economic life of the investment
- annual running costs should be added to the annualised cost of capital
- changes in performance have a cost and should be taken into account as part of the annual costs
- this total sum is divided by the annual throughput to determine the 'unit cost'. The throughput should be described using the 'units' shown in Table 7.7.

The approach is detailed in the following sections.

### ***Capital Costs***

Capital expenditure needs to be assessed under the headings shown in Table 7.8.

Primary consideration	Notes
Capital for fixed equipment <sup>1)</sup> or machinery <sup>2)</sup> .	Use national costs. If these are unavailable use international costs including delivery cost and convert the cost to national currency at the appropriate rate
Labour cost of installation.	Use contract charges if these are normal. If farm staff are normally used to install the conversion, employed staff should be costed at typical hourly rates. Farmers' input should be charged at the opportunity cost.
Grants	Subtract the value of capital grants available to farmers.
<i>Note 1): Fixed equipment includes buildings, conversions of buildings, feed storage bins, or manure storage.</i>	
<i>Note 2): Machinery includes feed distribution augers, field equipment for manure application or equipment for manure treatment.</i>	

**Table 7.8: Capital expenditure considerations**

### *Annual Costs*

The annual cost associated with the introduction of a technique needs to be assessed in the following steps.

Step	Consideration	Notes
<b>A</b>	Annualised cost of capital should be calculated over the life of the investment.	Use standard formula. The term will depend on the economic life. Conversions need to take account of remaining life of original facility. See Appendix 1.
<b>B</b>	Repairs associated with the investment should be calculated.	See Appendix 2.
<b>C</b>	Changes in labour costs.	Additional hours × cost per hour.
<b>D</b>	Fuel and energy costs.	Additional power requirements may need to be taken into account. See Appendix 2.
<b>E</b>	Changes in livestock performance.	Changes in diets or housing can affect performance, with cost implications. See Appendix 3.
<b>F</b>	Cost savings and production benefits.	In certain cases the introduction of techniques will result in the saving of costs for the farmer. These should be taken into account only when they are the direct result of the measure.  The avoidance of fines for pollution should be excluded from any costed benefits for these purposes.

**Table 7.9: Annual cost considerations**

### Worked examples in the UK

#### *Liquid manure application by soil injection*

Basis for the costs:

1. the costs are based on the purchase of an injector attachment for fitting to either the slurry tanker or the tractor. The capital cost of such equipment is EUR 10000
2. additional tractor power of about 35 kW is needed compared to surface application
3. work rates of about 14 m<sup>3</sup> per hour may be achieved compared to 17 m<sup>3</sup> (2½ loads per hour of 7 m<sup>3</sup>) per hour using a tanker and splash plate system. This is based on a 6 minute discharge for a splash plate operation being extended to 12 minutes when injecting
4. annual throughput 2000 m<sup>3</sup>
5. capital cost amortised over 5 years at 8.5 %
6. emission reduction: e.g. reduction of ammonia emission expressed in mg NH<sub>3</sub>/Nm<sup>3</sup>.

Step	Consideration	Calculation	Total (EUR/yr)
		Use formula given at Appendix 1 and shown below.	
<b>A</b>	Annual Cost of Capital	$C \times (r(1+r)^n) / ((1+r)^n - 1)$ $C = \text{EUR } 10000$ $r = 8.5\% \text{ inserted into formula as } 0.085$ $n = 5 \text{ years}$ $\text{EUR } 10000 \times (0.085(1+0.085)^5) / ((1+0.085)^5 - 1)$	<b>2540</b>
<b>B</b>	Repairs	At 5 % of capital cost of injector (EUR 10000).	<b>500</b>
<b>C</b>	Changes in labour costs	Slower application rates ( $2000\text{m}^3 \div 14 \text{ m}^3/\text{hr}$ less $2000\text{m}^3 \div 17 \text{ m}^3/\text{hr}$ ) = 25 hours times EUR 12 per hour	<b>300</b>
<b>D</b>	Fuel and energy costs.	Additional tractor costs - 35 kW for $2000\text{m}^3 \div 14 \text{ m}^3/\text{hr}$ = 143 hrs at 10 litres per hour at EUR 0.35 per litre	<b>500</b>
<b>E</b>	Changes in livestock performance.	Not applicable	<b>0</b>
<b>F</b>	Cost savings and production benefits.	Not included, although there may be better use of manure nitrogen	<b>0</b>
	<b>Total extra annual costs</b>		<b>3840</b>
	<b>Total extra cost per m<sup>3</sup> based on an annual throughput of 2000 m<sup>3</sup></b>		<b>1.92</b>

Table 7.10: Additional costs incurred with liquid manure application by soil injection in the UK

*Solid manure incorporation by ploughing (example calculation without capital expenditure)*

Basis for the costs:

- contractors will need to be used to incorporate solid manure in many situations, as employed labour and machinery will be fully utilised on other tasks
- the method of incorporation will normally be by ploughing
- there will be a marginal cost saving, as this operation (ploughing) will not need to be carried out by farm staff at a later time
- manure spread up to the equivalent of 250 kg total N per hectare per year.

Step	Consideration	Calculation	Total (EUR/ha)
<b>A</b>	Annual cost of capital	Not applicable	<b>0</b>
<b>B</b>	Repairs	Not applicable	<b>0</b>
<b>C</b>	Changes in labour costs	Employment of a contractor to carry out ploughing	<b>65</b>
<b>D</b>	Fuel and energy costs.	Not applicable (included in contractor charge)	<b>0</b>
<b>E</b>	Changes in livestock performance.	Not applicable	<b>0</b>
<b>F</b>	Cost savings and production benefits.	Savings in farmer's own marginal machinery costs	<b>10</b>
	<b>Total extra annual costs</b>		<b>55</b>
	<b>Extra cost per tonne of manure:</b>		<b>EUR/tonne</b>
	Pig manure applied at 36 tonnes/ha		<b>1.53</b>
	Laying hen litter applied at 16.5 tonnes/ha		<b>3.33</b>
	Broiler litter applied at 8.5 tonnes/ha		<b>6.47</b>

Table 7.11: Additional costs incurred in solid manure incorporation by ploughing in the UK

**Calculations with changes to a building: 1. air ducts in deep pit poultry housing**

Basis for the costs:

1. simple polythene pipe air ducts are installed in the pit under the manure and fan ventilated. The capital cost is EUR 0.32 per bird place
2. such systems have additional running costs of EUR 0.16 per bird place per year (electricity and repairs)
3. the capital costs of the system are amortised over 10 years at 8.5 %.

Step	Consideration	Calculation	Total EUR/bird place
<b>A</b>	Annual cost of capital	Cost of pipes and fan	<b>0.05</b>
<b>B</b>	Repairs	Additional repair cost	<b>0.08</b>
<b>C</b>	Changes in labour costs	Not applicable	<b>0</b>
<b>D</b>	Fuel and energy costs.	Additional electricity costs	<b>0.08</b>
<b>E</b>	Changes in livestock performance.	Not applicable	<b>0</b>
<b>F</b>	Cost savings and production benefits.	Not applicable	<b>0</b>
	<b>Total extra annual costs per bird place</b>		<b>0.21</b>

**Table 7.12: Additional costs incurred with changes of a building in the UK**

**Calculations for changes to a building: 2. Metal grid replacement floors in pig buildings**

Basis for the costs:

1. capital cost of replacement slats EUR 78 per m<sup>2</sup> (*Tri-bar*) plus EUR 16 installation
2. installation is uncomplicated
3. the cost of capital is amortised over 10 years at 8.5 %. This allows for fitting the slats in existing accommodation, which has a part-expired life
4. cost per pig place is based on a total allowance of 0.63 m<sup>2</sup> per pig place, see below. Of this area normally 25 % or 0.156 m<sup>2</sup> per pig place is slatted in part-slatted accommodation
5. repair costs are considered to be similar to other types of floor.

Step	Consideration	Calculation	Total EUR/pig place
<b>A</b>	Annual cost of capital	Capital cost of EUR 94/m <sup>2</sup> for 0.156 m <sup>2</sup> amortised over 10 years at 8.5 %	<b>2.23</b>
<b>B</b>	Repairs	No extra costs	<b>0</b>
<b>C</b>	Changes in labour costs	Not applicable	<b>0</b>
<b>D</b>	Fuel and energy costs.	Not applicable	<b>0</b>
<b>E</b>	Changes in livestock performance.	Not applicable	<b>0</b>
<b>F</b>	Cost savings and production benefits.	Not applicable	<b>0</b>
	<b>Total extra annual costs per pig place</b>		<b>2.23</b>
<i>Notes: Data provided by Kirncroft Engineering (U.K.).</i>			

**Table 7.13: Additional costs incurred with metal grid floor replacement in the UK**

	Space requirement (m <sup>2</sup> )	Weighted average (m <sup>2</sup> )
30 – 50 kg	0.4	0.132
50 – 90 kg	0.65	0.436
<i>Subtotal</i>		0.568
Allowance for 90 % occupancy		0.057
Total space requirement		0.057
<i>Data provided by ADAS (U.K.)</i>		

**Table 7.14: Finishing pig space requirement in the UK**

### Useful reporting of cost data

A number of issues and presentational factors make assimilation of cost data easier for the reader and could support future assessment.

Any report on costs should contain sufficient information to enable the uninformed reader to follow the logic and calculations. A mixture of explanatory narrative and tables allows the reader to follow the thought processes of the author(s).

In all cases, the sources of data should be identified. Where professional judgement has been used to derive certain figures or assumptions, this should be acknowledged.

It is suggested that a report should contain the following sections and format:

- Introduction
- Summary *Text and tables showing unit cost of techniques*
- Cost of technique *Text and tabular presentation for each technique showing the basis and calculation of the unit cost, drawing on supplementary data contained in appendices*

### Appendices

#### *Appendix 1: Calculation of annual charge for capital*

Capital expenditure on abatement techniques should be converted to an annual charge. Capital may be for buildings, fixed equipment or machinery. It is important to include only the additional or marginal capital associated with the abatement techniques.

Amortisation should be used to calculate the annual cost of capital. When using this method, an additional allowance for depreciation of the asset should **not** be included in the calculation. Factors derived from appropriate tables can be applied to the capital invested or the standard formula, shown below, can be used.

#### Formula:

The formula for calculating the annual charge is:

$$C \times \left[ \frac{r(1+r)^n}{(1+r)^n - 1} \right]$$



Where: C = capital investment

r = rate of interest expressed as a decimal of 1. For example an interest rate of 6 % is entered in the equation as 0.06.

n = term in years

#### Rate of interest:

The rate of interest that is applied should reflect that commonly paid by farmers and will vary by country and by investment term. For guidance, the UK calculations are based on finance available to farmers through the Agricultural Mortgage Corporation (AMC). Their interest rates, as at September 2000, for fixed interest loans are quoted below.

Term in years	Fixed interest rates (%)	Annual charge <sup>1)</sup> EUR per EUR 1000 of capital
5	8.5	254
10	8.5	152
20	8.25	104
<i>Source: AMC. September 2000</i>		
<i>1) Based on amortisation formula shown above including interest and capital.</i>		

**Table 7.15: Interest on agricultural mortgage in the UK**

#### Term:

The term will depend on the type of investment and whether it is a new facility or a conversion.

In the case of new facilities the following economic lives are given as a guide. In particular circumstances it may be necessary to vary these figures.

Type of investment	Economic life in years
Buildings	20
Fixed equipment	10
Machinery	5

**Table 7.16: Economic life of facilities**

In the case of conversions it is necessary to annualise the capital cost over the remaining life of the original facility.

In many cases the facility may have a productive life in excess of the economic life, though it is the economic life that must be used in these calculations.

### ***Appendix 2: Repair and fuel costs***

#### Repairs:

Repair costs associated with any investment will vary greatly. The type of investment, original build quality, operating conditions, age in relation to design life and amount of use all play their part in influencing costs.

The following figures can be used for guidance:

Type of investment	Annual repair costs as a percentage of new cost
Buildings	0.5 – 2
Fixed Equipment	1 – 3
Tractors	5 – 8
Manure and slurry spreaders	3 – 6

**Table 7.17: Repair costs as a percentage of new costs**

### Fuel:

The following general formulae can be used to calculate fuel costs:

Electricity:

$$\text{Fuel cost} = \text{kWh} \times \text{Hours of use} \times \text{Fuel price}$$

Tractor Fuel:

$$\text{Fuel cost} = \text{kWh} \times \frac{\text{Fuel consumption}}{\text{per kWh}} \times \text{Hours of use} \times \text{Fuel price}$$

### *Appendix 3: Unit costs – Some detailed considerations*

The following detailed factors should be considered in relation to each technique:

### Feed:

Changes to diets can be applied to many classes of livestock to reduce ammonia emissions. The following implications need consideration in each case.

Capital costs	Annual costs to consider
Additional feeding systems	Annual charges, repairs and power inputs.
	Changes to carcass value.
	Relative costs of diets.
	Changes to livestock performance and feed consumption.
	Changes in excreta output.
	Changes in labour requirements.

**Table 7.18: Annual costs to consider in capital costs of feeding systems**

### Housing:

For those techniques requiring capital expenditure by farmers, it is necessary to consider the elements in the following table:

Capital costs	Annual costs to consider
Changes to housing systems	Annual charges, repairs and power inputs.
	Changes in house capacity.
	Changes in labour requirements.
	Changes in bedding requirements
	Changes to livestock performance and feed consumption.
	Changes in excreta storage capacity in the building.
<p><i>Note:</i>  Capital costs may refer to either the modification of existing facilities or the <b>additional</b> costs of replacement facilities. The choice will depend on building condition and suitability for conversion, normally related to age and remaining economic life. Only the additional costs of providing those facilities that relate to the facilities' pollution abatement capabilities should be included.</p>	

**Table 7.19: Annual costs to consider in capital costs of housing systems**

Manure storage:

For those techniques requiring capital expenditure by farmers, it is necessary to consider the elements in the following table.

Capital costs	Annual costs to consider
Additional storage	Annual charge, repair costs.
Permanent covers	Annual charge, repair costs.
	Cost of temporary covers on an annual basis
All covers	Changes in labour requirements.
	Reductions in rainwater dilution.

**Table 7.20: Annual costs to consider in capital costs of manure storage systems**

Application of manure to land:

Capital costs	Annual costs to consider
Low emission spreaders (compared to splash plate spreaders)	Annual charge, repair costs.
	Changes in tractor power requirement
	Changes in work rates
	Changes in labour requirements.

**Table 7.21: Annual costs to consider in capital costs of manure storage systems**

## 7.7 Procedure for BAT-assessment of techniques applied on intensive poultry and pig farms

The assessment procedure described in this annex has been developed by a subgroup of the TWG on Intensive Livestock Farming. The primary objective of this annex is to promote a better understanding of the evaluation behind the BAT proposed in Chapter 5.

Each assessment depends on the quantity and quality of the information available. A solution must be developed for comparing techniques where the information is poor or difficult to assess. This will need to cover validation and comparison of the different characteristics of potential reduction techniques.

This BREF document presents, the conclusions of an exchange of information on environmental techniques in the intensive rearing of pigs and poultry. It can be regarded as the first inventory of the available data. Although a large amount of data is available, the information needed to support the decision-making process can still be improved in terms of both the quality and quantity of data.

To allow the assessment to be made in a transparent way, all these data should be presented in a specific format and (even more importantly) should have a high degree of comparability. Therefore, the data should be made available with a clear explanation on how they have been collected, measured and analysed and under what circumstances. Ideally, they should have been collected according to the same protocol and presented with the same level of detail. Comparing sets of data collected in this way promotes an easy understanding of any differences, such as large variations in performance levels, that can be expected in the intensive livestock sectors. These variations may be caused by differences between farming practices and/or by specific regional or local conditions.

Chapter 4 aims to present this kind of information as far as possible for each activity or group of techniques. Where such information is limited or not available expert judgement will play an important role.

### *The assessment and selection of BAT*

Techniques are considered on an individual basis by assessing their emission reduction potential, operability, applicability, the animal welfare, and their associated costs, all in comparison to a reference technique. The approach carried out for the applied assessment consists of the following steps:

1. create an assessment matrix of all the relevant factors for each **group of techniques**
2. identify the reference technique for each **group of techniques**
3. identify the key environmental issues for each **group of techniques**
4. give a qualitative rating (-2, -1, 0, 1 2) for **each technique**, where quantitative data are not available
5. rank **techniques** by their environmental performance in terms of the reduction of, for example, ammonia emissions
6. assess the technical applicability, the operability and the animal welfare aspects of **each technique**
7. assess the environmental cross-media effects caused by **each technique**
8. assess the costs (CAPEX and OPEX) of applying **each technique** in new build and in retrofit situations
9. discuss the qualifications -2 and -1 to see if it is possibly a conditional BAT or to decide that it is a knock-out criterion, for example a technique with -2 on animal welfare can never be BAT
10. identify (conditional) BAT and decide if it is BAT for new and/or for retrofit situations.

Table 7.22 on the next page shows the assessment matrix used to assess housing techniques as used by the TWG in the discussion on BAT for housing systems.

POSSIBLE ECM's	Emission reduction potential (%)	Operability	Applicability	Animal Welfare	N <sub>2</sub> O, CH <sub>4</sub> emission	Odours emission	PM10	Energy cons.	Water cons.	Noise	CAPEX (new)	CAPEX (retrofit)	OPEX (Ops & Main & Investment) new	OPEX (Ops & Main & Investment) retrofit
	A	B	C	D	E	F	G	I	J	K	L	M	N	O
Housing with confined movement (2.3.1.2.1)														
FSF/crates and board on a slope (4.6.2.1)	30 %													
FSF/crates, water + manure channel (4.6.2.2)	50 %													
FSF/crates, flush + manure gutters (4.6.2.3)	60 %													
FSF/crates, manure pan (4.6.2.4)	65 %													
FSF/crates, surface cooling fins (4.6.2.5)	70 %													
Partial slatted floors (PSF) + crates (4.6.2.6)	30 %													
PSF/crates and manure scraper (4.6.2.7)	35 %													
<b>Scoring definitions</b>														
scores range: -2 ; -1; 0 ; 1 ; 2														
a 0 score means equal to reference														
a 2 score on emission reduction potential indicates the highest reduction potential														
a 2 score on operability means easiest to operate														
a 0 score on applicability indicates that the technique is as often used as the reference														
a 2 score on animal welfare indicates the highest welfare standard														
a 2 score on cross-media indicates no cross-media effects														
a 2 score on all CAPEX/OPEX columns indicates lowest costs														

Table 7.22: Assessment matrix

In an intermediate meeting with the TWG, the following groups of techniques were assessed using the matrix shown in Table 7.22:

- cage housing of laying hens
- non-cage housing of laying hens
- housing of broilers
- housing techniques for mating and gestating sows
- housing techniques for farrowing sows
- housing techniques for weaned piglets
- housing techniques for growers/finishers
- end-of-pipe techniques, air emissions from poultry and pigs housing.

It was concluded in this meeting that the assessment matrix could be a very useful tool in the discussion on BAT. However the meeting also concluded that a completed assessment matrix should not act as a stand-alone instrument and always has to be seen in the context of the meeting that carried out the assessment. The reason for this is that the argument for a certain qualification cannot be found in the matrix, and the exact reasoning behind a qualification is a very important factor in the decision on BAT, especially with regards to transparency of the assessment process.

Other groups of techniques such as, landspreading and storage were – of course – also assessed by the TWG, but not using this tool because of a lack of time.

### ***Evaluation of emission reduction potential***

The emphasis of the assessment and the selection of BAT is on their ammonia emission reduction potential compared to the associated ammonia emission of the reference technique.

The ammonia emission reduction potential of the techniques presented in Chapter 4 are given in units expressed as an absolute emission range and as relative reductions (% against a reference technique). Working with livestock and a large variation in feed formulation, the absolute ammonia emissions from manure, or from housing, etc. will cover a very wide range and make interpretation of absolute levels difficult. Therefore, the use of ammonia-reduction levels expressed in percentages has been preferred, particularly for animal housing, manure storage and manure application to land.

### ***Assessment of technical applicability, operability and animal welfare***

The applicability of a technique is whether and how often it is used compared to the reference technique. The operability of a technique is affected by factors such as the complexity of a construction and the creation of extra labour. The effects on the welfare of animal are also assessed, again in comparison to the reference technique. As far as possible, these factors have been described in Chapter 4.

### ***Assessment of cross-media effects***

The cross-media effects assessed in housing techniques include factors such as N<sub>2</sub>O and CH<sub>4</sub> emissions, odour emissions, dust, energy consumption, water consumption and noise.

### ***Assessment of costs***

The costs of techniques were not always been reported and, where cost indications were given, factors on which these calculations were based were often not clarified. The number of applications and the number of Member States from which applications are reported then take on more significance in the evaluation.

The costs on housing techniques reported in Chapter 4 are expressed as the extra costs compared to the reference technique. These data are used in the assessment and where these figures were not available, experts from the TWG gave a qualification. The fact that costs are expressed in comparison to the reference housing system presents problems in the assessment in retrofit situations. This is because retrofitting is not only applied on the reference system, but

also on other existing housing systems. The costs for retrofitting depend very much on the existing housing system and to compare the extra costs only with the reference system is not realistic in all situations.

Some techniques may incur no extra costs compared to the currently applied reference technique. Obviously, there should be no financial argument not to apply these techniques, but there may be other reasons why such techniques may not be BAT. Where techniques have extra costs, a cost level was identified beyond which it would not be reasonable to expect their application by the sector.

It was very difficult to identify such a standard at a European level, against which the real costs of a technique could be compared. Often, there are other rationale behind the decision-making at the farm level. Also, local, regional or national (financial) incentives may encourage farmers to change their practices. Cost data for applying a reduction technique (as presented in Chapter 4) are often for a specific situation. However, for almost all the techniques that were assessed the meeting was able to agree the qualification of the costs and able to identify the cost level beyond which application by the sector was not considered to be reasonable.