

JRC SCIENCE FOR POLICY REPORT

Best Available Techniques (BAT) Reference Document for the Intensive Rearing of Poultry or Pigs

*Industrial Emissions Directive
2010/75/EU
(Integrated Pollution Prevention
and Control)*

Germán Giner Santonja, Konstantinos Georgitzikis,
Bianca Maria Scalet, Paolo Montobbio,
Serge Roudier, Luis Delgado Sancho

2017



Best Available Techniques (BAT)
Reference Document for the
Intensive Rearing of Poultry or
Pigs

Industrial Emissions Directive 2010/75/EU
Integrated Pollution Prevention and control

Authors:

Germán Giner Santonja
Konstantinos Georgitzikis
Bianca Maria Scalet
Paolo Montobbio
Serge Roudier
Luis Delgado Sancho

2017

EUR 28674 EN

This publication is a Science for Policy report by the Joint Research Centre (JRC), the European Commission's science and knowledge service. It aims to provide evidence-based scientific support to the European policy-making process. The scientific output expressed does not imply a policy position of the European Commission. Neither the European Commission nor any person acting on behalf of the Commission is responsible for the use which might be made of this publication.

Contact information

Name: European IPPC Bureau
Address: Joint Research Centre, Edificio Expo c/ Inca Garcilaso 3, E-41092 Seville, Spain
E-mail: JRC-B5-EIPPCB@ec.europa.eu
Tel.: +34 95 4488 284

JRC Science Hub

<https://ec.europa.eu/jrc>

Legal Notice

Under the Commission Decision of 12 December 2011 on the Re-use of Commission Documents (2011/833/EU), the present BREF document is subject to free re-use, except for parts covered by any third-party rights which may be present in the document (such as images, tables, data, written material, or similar, the rights to which need to be acquired separately from their respective rights-holders for further use). The European Commission is not liable for any consequence stemming from the re-use of this publication. Any re-use is subject to the acknowledgement of the source and non-distortion of the original meaning or message.

JRC107189

EUR 28674 EN

PDF ISBN 978-92-79-70214-3 ISSN 1831-9424 doi: 10.2760/020485

Luxembourg: Publications Office of the European Union, 2017

© European Union, 2017

How to cite this report: Germán Giner Santonja, Konstantinos Georgitzikis, Bianca Maria Scalet, Paolo Montobbio, Serge Roudier, Luis Delgado Sancho; *Best Available Techniques (BAT) Reference Document for the Intensive Rearing of Poultry or Pigs*; EUR 28674 EN; doi:10.2760/020485

All images © European Union, 2017, except cover pictures credits, from left to right: 1. Pig nose in the pen. Focus is on nose. Shallow depth of field. © fotolia.com - Dusan Petkovic (www.color24.com); 2. Daily three yellow chicken at the poultry farm © fotolia.com - kharhan (stock.adobe.com); 3. A group of entertaining Indian running ducks © fotolia.com - daseaford (stock.adobe.com); 4. Piglets suckling sow © fotolia.com - Budimir Jevtic (stock.adobe.com); 5. Grassland after mechanical slurry injection © fotolia.com - Ruud Morijn; 6. Hen house © fotolia.com - Nicole Gonzalez; 7. Flock of Turkeys in the farm ranch © fotolia.com - Tertman (stock.adobe.com); 8. Ammonia emissions from irrigation of dilute pig slurry © Institute of Grassland and Environmental Research

Title Best Available Techniques (BAT) Reference Document for the Intensive Rearing of Poultry or Pigs

Abstract

The BAT reference document (BREF) entitled 'Intensive Rearing of Poultry or Pigs' forms part of a series presenting the results of an exchange of information between EU Member States, the industries concerned, non-governmental organisations promoting environmental protection, and the Commission, to draw up, review and, where necessary, update BAT reference documents as required by Article 13(1) of the Directive 2010/75/EU on industrial emissions. This document is published by the European Commission pursuant to Article 13(6) of the Directive. This BREF for Intensive Rearing of Poultry or Pigs concerns the activities specified in Section 6.6 of Annex I to Directive 2010/75/EU, namely '6.6. Intensive rearing of poultry or pigs':

- (a) with more than 40 000 places for poultry
- (b) with more than 2 000 places for production pigs (over 30 kg), or
- (c) with more than 750 places for sows.

In particular, this document covers the following on-farm processes and activities:

- nutritional management of poultry and pigs;
- feed preparation (milling, mixing and storage);
- rearing (housing) of poultry and pigs;
- collection and storage of manure;
- processing of manure;
- manure landspreading;
- storage of dead animals.

Important issues for the implementation of Directive 2010/75/EU in the intensive rearing of poultry or pigs are ammonia emissions to air, and total nitrogen and total phosphorus excreted. This BREF contains 10 chapters. Chapter 1 provides general information on pig and poultry production in Europe. Chapter 2 describes the major activities and production systems used in intensive poultry or pig production. Chapter 3 contains information on the environmental performance of installations in terms of current emissions, consumption of raw materials, water and energy. Chapter 4 describes in more detail the techniques to prevent or, where this is not practicable, to reduce the environmental impact of operating installations in this sector that were considered in determining the BAT. This information includes, where relevant, the environmental performance levels (e.g. emission and consumption levels) which can be achieved by using the techniques, the associated monitoring and the costs and the cross-media issues associated with the techniques. Chapter 5 presents the BAT conclusions as defined in Article 3(12) of the Directive. Chapter 6 presents information on 'emerging techniques' as defined in Article 3(14) of the Directive. Chapter 7 is dedicated to concluding remarks and recommendations for future work.

Printed in Ispra (Italy)

Acknowledgements

This report was produced by the European Integrated Pollution Prevention and Control Bureau (EIPPCB) at the European Commission's Joint Research Centre – Directorate B: Growth and Innovation under the supervision of Serge Roudier (Head of the EIPPCB) and Luis Delgado Sancho (Head of the Circular Economy and Industrial Leadership Unit).

The authors of this BREF were Mr Germán Giner Santonja, Mr Konstantinos Georgitzikis, Ms Bianca Maria Scalet and Mr Paolo Montobbio.

This report was drawn up in the framework of the implementation of the Industrial Emissions Directive (2010/75/EU) and is the result of the exchange of information provided for in Article 13 of the Directive.

Major contributors of information were:

- among EU Member States: Austria, Belgium, Denmark, Finland, France, Germany, Ireland, Italy, the Netherlands, Spain and the United Kingdom;
- among farmers' associations: DAFC (Danish Agriculture & Food Council), FEFANA (EU Association of Specialty Feed Ingredients and their Mixtures), IFA (Irish Farmers' Association), and NFU (UK - National Farmers' Union).

Other contributors to the review process were Portugal, Poland, Sweden, COPA-COGECA (Committee of Professional Agricultural Organisations and General Committee for Agricultural Cooperation in the European Union), the Danish Committee for Pig Production, EEB (European Environmental Bureau), IFIP (French Pork and Pig Institute), ITAVI (France - Technical Institute of Aviculture), KTBL (Germany - Association for Technology and Structures in Agriculture), and UFU (Ulster Farmers' Union).

The whole EIPPCB team provided contributions and peer reviewing.

This document is one from the series of foreseen documents listed below (at the time of writing, not all documents have been drafted):

Best Available Techniques Reference Document	Code
Ceramic Manufacturing Industry	CER
Common Waste Water and Waste Gas Treatment/Management Systems in the Chemical Sector	CWW
Common Waste Gas Treatment in the Chemical Sector	WGC
Emissions from Storage	EFS
Energy Efficiency	ENE
Ferrous Metals Processing Industry	FMP
Food, Drink and Milk Industries	FDM
Industrial Cooling Systems	ICS
<i>Intensive Rearing of Poultry or Pigs</i>	<i>IRPP</i>
Iron and Steel Production	IS
Large Combustion Plants	LCP
Large Volume Inorganic Chemicals – Ammonia, Acids and Fertilisers	LVIC-AAF
Large Volume Inorganic Chemicals – Solids and Others Industry	LVIC-S
Large Volume Organic Chemical Industry	LVOC
Management of Tailings and Waste-rock in Mining Activities	MTWR
Manufacture of Glass	GLS
Manufacture of Organic Fine Chemicals	OFC
Non-ferrous Metals Industries	NFM
Production of Cement, Lime and Magnesium Oxide	CLM
Production of Chlor-alkali	CAK
Production of Polymers	POL
Production of Pulp, Paper and Board	PP
Production of Speciality Inorganic Chemicals	SIC
Production of Wood-based Panels	WBP
Refining of Mineral Oil and Gas	REF
Slaughterhouses and Animals By-products Industries	SA
Smitheries and Foundries Industry	SF
Surface Treatment of Metals and Plastics	STM
Surface Treatment Using Organic Solvents (including Wood and Wood Products Preservation with Chemicals)	STS
Tanning of Hides and Skins	TAN
Textiles Industry	TXT
Waste Incineration	WI
Waste Treatment	WT
Reference Document	
Economics and Cross-media Effects	ECM
Monitoring of Emissions to Air and Water from IED installations	ROM

Electronic versions of draft and finalised documents are publicly available and can be downloaded from <http://eippcb.jrc.ec.europa.eu/>.

PREFACE

1. Status of this document

Unless otherwise stated, references to ‘the Directive’ in this document refer to Directive 2010/75/EU of the European Parliament and the Council on industrial emissions (integrated pollution prevention and control) (Recast).

This document is a working draft of the European IPPC Bureau (of the Commission's Joint Research Centre). It is not an official publication of the European Union and does not necessarily reflect the position of the European Commission.

2. Participants in the information exchange

As required in Article 13(3) of the Directive, the Commission has established a forum to promote the exchange of information, which is composed of representatives from Member States, the industries concerned and non-governmental organisations promoting environmental protection (Commission Decision of 16 May 2011 establishing a forum for the exchange of information pursuant to Article 13 of Directive 2010/75/EU on industrial emissions (2011/C 146/03), OJ C 146, 17.05.2011, p. 3).

Forum members have nominated technical experts constituting the technical working group (TWG) that was the main source of information for drafting this document. The work of the TWG was led by the European IPPC Bureau (of the Commission's Joint Research Centre).

3. Structure and contents of this document

Chapters 1 and 2 provide general information on the intensive rearing of poultry or pigs and on the industrial processes and techniques used within this sector.

Chapter 3 provides data and information concerning the environmental performance of farms within the sector, and in operation at the time of writing, in terms of current emissions, consumption and nature of raw materials, water consumption, and use of energy and the generation of waste.

Chapter 4 describes in more detail the techniques to prevent or, where this is not practicable, to reduce emissions from pig or poultry farms that were considered in determining the BAT. This information includes, where relevant, the environmental performance levels (e.g. emission and consumption levels) which can be achieved by using the techniques, the associated monitoring and the costs and the cross-media issues associated with the techniques.

Chapter 5 presents the BAT conclusions as defined in Article 3(12) of the Directive.

Chapter 6 presents information on 'emerging techniques' as defined in Article 3(14) of the Directive.

Concluding remarks and recommendations for future work are presented in Chapter 7.

4. Information sources and the derivation of BAT

This document is based on information collected from a number of sources, in particular through the TWG that was established specifically for the exchange of information under Article 13 of the Directive. The information has been collated and assessed by the European IPPC Bureau (of the Commission's Joint Research Centre) who led the work on determining BAT, guided by the principles of technical expertise, transparency and neutrality. The work of the TWG and all other contributors is gratefully acknowledged.

The BAT conclusions have been established through an iterative process involving the following steps:

- identification of the key environmental issues for the sector;
- examination of the techniques most relevant to address these key issues;
- identification of the best environmental performance levels, on the basis of the available data in the European Union and worldwide;
- examination of the conditions under which these environmental performance levels were achieved, such as costs, cross-media effects, and the main driving forces involved in the implementation of the techniques;
- selection of the best available techniques (BAT), their associated emission levels (and other environmental performance levels) and the associated monitoring for this sector according to Article 3(10) of, and Annex III to, the Directive.

Expert judgement by the European IPPC Bureau and the TWG has played a key role in each of these steps and the way in which the information is presented here.

Where available, economic data have been given together with the descriptions of the techniques presented in Chapter 4. These data give a rough indication of the magnitude of the costs and benefits. However, the actual costs and benefits of applying a technique may depend strongly on the specific situation of the farm concerned, which cannot be evaluated fully in this document. In the absence of data concerning costs, conclusions on the economic viability of techniques are drawn from observations on existing farms.

5. Review of BAT reference documents (BREFs)

BAT is a dynamic concept and so the review of BREFs is a continuing process. For example, new measures and techniques may emerge, science and technologies are continuously developing and new or emerging processes are being successfully introduced into the industries. In order to reflect such changes and their consequences for BAT, this document will be periodically reviewed and, if necessary, updated accordingly.

6. Contact information

All comments and suggestions should be made to the European IPPC Bureau at the Joint Research Centre (JRC) at the following address:

European Commission
JRC Directorate B – Growth and Innovation
European IPPC Bureau
Edificio Expo
c/Inca Garcilaso, 3
E-41092 Seville, Spain
Telephone: +34 95 4488 284
Fax: +34 95 4488 426
E-mail: JRC-B5-EIPPCB@ec.europa.eu
Internet: <http://eippcb.jrc.ec.europa.eu>

Best Available Techniques (BAT) Reference Document for the Intensive Rearing of Poultry or Pigs

PREFACE	I
SCOPE	XXXI
1 GENERAL INFORMATION	1
1.1 INTENSIVE LIVESTOCK FARMING	1
1.2 THE POULTRY PRODUCTION SECTOR IN EUROPE	5
1.2.1 Egg production and consumption.....	5
1.2.2 Poultry meat production and consumption.....	8
1.2.2.1 Alternative poultry meat production	11
1.2.3 Economics of the poultry sector.....	12
1.2.3.1 Economics of the egg production sector	12
1.2.3.2 Economics of the poultry meat production sector	15
1.3 THE PIG PRODUCTION SECTOR IN EUROPE.....	19
1.3.1 Structure, trends and geographical distribution of the pig production sector in Europe	19
1.3.2 Production and consumption of pork	22
1.3.3 Economics of the pig sector	25
1.4 ENVIRONMENTAL ISSUES OF INTENSIVE POULTRY OR PIG FARMING.....	30
1.4.1 Emissions to air	32
1.4.2 Emissions to soil and water	37
1.4.3 Other emissions	39
2 APPLIED PROCESSES AND TECHNIQUES	41
2.1 INTRODUCTION	41
2.2 POULTRY PRODUCTION.....	43
2.2.1 Production of eggs.....	43
2.2.1.1 Cage systems for laying hens	44
2.2.1.2 Non-cage systems for laying hens.....	46
2.2.1.2.1 Deep litter system.....	47
2.2.1.2.2 Aviary system.....	48
2.2.1.2.3 Additional structures for non-cage housing.....	50
2.2.1.3 Pullet rearing	51
2.2.2 Production of broiler meat.....	51
2.2.3 Other poultry production sectors.....	53
2.2.3.1 Rearing of broiler breeders.....	53
2.2.3.2 Production of turkeys	53
2.2.3.3 Production of ducks.....	54
2.2.3.4 Production of guinea fowl.....	55
2.2.4 Control of poultry indoor environment	56
2.2.4.1 Temperature control	56
2.2.4.2 Ventilation of poultry housing	58
2.2.4.3 Water fogging	59
2.2.4.4 Pad cooling.....	60
2.2.4.5 Lighting of poultry housing.....	60
2.2.4.6 Control of dust	61

2.2.5	Poultry feed and drink supply	62
2.2.5.1	Poultry feed formulation	62
2.2.5.2	Feeding systems	64
2.2.5.3	Drinking water supply systems	65
2.3	PIG PRODUCTION	67
2.3.1	Pig housing and manure collection	67
2.3.1.1	Housing systems for mating and gestating sows	71
2.3.1.1.1	Individual housing with a fully or partly slatted floor for mating and gestating sows	72
2.3.1.1.2	Sow crates with a solid floor for mating and gestating sows	74
2.3.1.1.3	Group housing with or without straw for mating and gestating sows	75
2.3.1.1.4	Group housing with electronic feeders	77
2.3.1.2	Housing systems for farrowing sows	78
2.3.1.2.1	Housing for farrowing sows with confined movement	79
2.3.1.2.2	Housing of farrowing sows allowing sow movement	80
2.3.1.3	Housing systems for weaners	81
2.3.1.4	Housing of fattening pigs	83
2.3.1.4.1	Housing of fattening pigs on a fully slatted floor	84
2.3.1.4.2	Housing of fattening pigs on a partly slatted floor	84
2.3.1.4.3	Housing of fattening pigs on a solid concrete floor and straw	86
2.3.2	Control of indoor environment in pig housing systems	88
2.3.2.1	Heating of pig housing	90
2.3.2.2	Ventilation of pig housing	91
2.3.2.3	Lighting of pig housing	97
2.3.2.4	Water fogging	97
2.3.3	Pig feed and drink supply	97
2.3.3.1	Pig feed formulation	97
2.3.3.2	Feeding systems	99
2.3.3.3	Drinking water supply systems	101
2.4	END-OF-PIPE TECHNIQUES FOR AIR CLEANING	103
2.4.1	Wet scrubbers	103
2.4.2	Biofilters	104
2.5	PROCESSING AND STORAGE OF ANIMAL FEED	105
2.6	COLLECTION AND STORAGE OF MANURE	106
2.6.1	General requirements	106
2.6.2	Poultry manure	110
2.6.3	Pig manure	111
2.6.4	Storage systems for solid manure	112
2.6.5	Storage systems for slurry	114
2.6.5.1	Slurry storage in tanks	114
2.6.5.2	Slurry storage in earth-banked stores (or lagoons)	116
2.6.5.3	Other types of slurry storage	117
2.7	ON-FARM MANURE PROCESSING	118
2.7.1	Mechanical separators	120
2.7.2	Aerobic digestion (aeration) of liquid manure	121
2.7.3	Composting of solid manure	122
2.7.4	Anaerobic digestion of manure in a biogas installation	123
2.7.5	Anaerobic lagoon system	124

2.7.6	Manure additives	124
2.7.7	Slurry acidification.....	126
2.8	MANURE LANDSPREADING TECHNIQUES.....	127
2.8.1	Slurry transport systems	129
2.8.2	Slurry landspreading systems.....	130
2.8.2.1	Broadcast spreader	130
2.8.2.2	Irrigators.....	132
2.8.2.3	Low-pressure irrigator.....	133
2.8.2.4	Band spreader (or trailing hose).....	133
2.8.2.5	Trailing shoe spreader.....	134
2.8.2.6	Injector (open slot).....	134
2.8.2.7	Injector (closed slot).....	135
2.8.3	Solid manure landspreading systems	136
2.8.4	Incorporation	138
2.9	ON-FARM TRANSPORT	140
2.10	MAINTENANCE AND CLEANING	141
2.11	USE AND DISPOSAL OF RESIDUES.....	142
2.12	STORAGE AND DISPOSAL OF DEAD ANIMALS.....	143
2.13	TREATMENT OF WASTE WATER	144
2.14	INSTALLATIONS FOR HEAT AND POWER PRODUCTION AND ENERGY RECOVERY	145
2.14.1	Renewable energy production	145
2.14.2	Heat recovery by heat exchangers.....	145
2.14.3	Heat pumps.....	146
2.14.4	Biogas energy production.....	146
2.14.5	Energy production from biomass	147
2.15	MONITORING OF EMISSIONS AND CONTROL OF PROCESS PARAMETERS	148
3	CURRENT CONSUMPTION AND EMISSION LEVELS OF INTENSIVE POULTRY OR PIG FARMS.....	149
3.1	INTRODUCTION	149
3.2	CONSUMPTION LEVELS.....	151
3.2.1	Feed consumption and nutritional levels.....	151
3.2.1.1	Poultry feeding.....	151
3.2.1.2	Pig feeding	153
3.2.2	Water consumption	156
3.2.2.1	Water requirements of poultry farms	156
3.2.2.1.1	Birds' water consumption.....	156
3.2.2.1.2	Use of cleaning water.....	157
3.2.2.1.3	Use of cooling water	157
3.2.2.2	Water requirements of pig farms.....	158
3.2.2.2.1	Animals' water consumption.....	158
3.2.2.2.2	Use of cleaning water.....	160
3.2.2.2.3	Use of cooling water	161
3.2.2.2.4	Use of water for air cleaning systems.....	161
3.2.3	Energy consumption.....	161
3.2.3.1	Poultry farms.....	161
3.2.3.2	Pig farms	164

3.2.4	Other inputs	168
3.2.4.1	Bedding (litter)	168
3.2.4.2	Cleaning material.....	169
3.3	EXCRETION AND EMISSION LEVELS.....	170
3.3.1	Excretion of nutrients and manure generation.....	170
3.3.1.1	Levels of excretion and characteristics of poultry manure	171
3.3.1.2	Levels of excretion and characteristics of pig manure.....	174
3.3.2	Emissions from housing systems.....	180
3.3.2.1	Emissions from poultry housing.....	182
3.3.2.2	Emissions from pig housing	185
3.3.3	Emissions from manure storage facilities.....	188
3.3.3.1	Emissions from solid manure storage.....	189
3.3.3.2	Emissions from slurry storage	191
3.3.4	Emissions from manure processing	193
3.3.5	Emissions from landspreading.....	193
3.3.5.1	Emissions to air	194
3.3.5.2	Emissions to soil and water	197
3.3.5.3	Emissions of metals	199
3.3.6	Emissions from the whole farm.....	200
3.3.6.1	Emissions from the whole-farm process chain for the rearing of poultry.....	200
3.3.6.2	Emissions from the whole-farm process chain for the rearing of pigs.....	202
3.3.7	Noise.....	203
3.3.7.1	Sources and emissions on poultry farms.....	204
3.3.7.2	Sources and emissions on pig farms	204
3.3.8	Solid waste from poultry and pig farms.....	205
3.3.9	Emissions of odour	205
4	TECHNIQUES TO CONSIDER IN THE DETERMINATION OF BAT	207
4.1	GOOD AGRICULTURAL PRACTICE FOR ENVIRONMENTAL MANAGEMENT	209
4.1.1	Storage and disposal of dead animals	212
4.2	ENVIRONMENTAL MANAGEMENT SYSTEMS.....	215
4.3	NUTRITIONAL MANAGEMENT.....	218
4.3.1	Nutritional measures	218
4.3.2	Multiphase feeding	225
4.3.2.1	Poultry	225
4.3.2.2	Pigs	227
4.3.3	Low-protein, amino-acid-supplemented diets	231
4.3.4	Addition of phytase to achieve phosphorus-balanced diets for poultry and pigs.....	243
4.3.5	Highly digestible inorganic feed phosphates	246
4.3.6	Other feed additives	248
4.3.6.1	Benzoic acid	249
4.3.6.2	Probiotics.....	252
4.3.6.3	Enzymes.....	254
4.3.6.4	Phytogenic feed additives	257
4.4	TECHNIQUES FOR THE EFFICIENT USE OF WATER.....	259
4.5	TECHNIQUES FOR THE EFFICIENT USE OF ENERGY	263
4.5.1	Introduction.....	263

4.5.1.1	General energy-saving measures	264
4.5.1.2	Energy management approach	264
4.5.2	Insulation.....	266
4.5.2.1	Insulation in poultry housing.....	267
4.5.2.1.1	Heat-reflecting membranes	269
4.5.2.2	Insulation in pig housing	270
4.5.3	Low-energy lighting.....	272
4.5.3.1	Lighting in poultry housing.....	274
4.5.3.2	Lighting in pig housing	275
4.5.4	Optimisation of heating/cooling and ventilation systems and management in poultry and pig farms	276
4.5.4.1	Efficient use of energy for heating.....	276
4.5.4.1.1	General measures for the efficient use of energy for heating in poultry farms.....	276
4.5.4.1.2	General measures for the efficient use of energy for heating in pig farms ...	277
4.5.4.1.3	Gas-fired infrared heaters and air blowers	278
4.5.4.1.4	Wood- and biomass-fired boilers	279
4.5.4.2	Efficient use of energy for ventilation.....	282
4.5.4.2.1	Management of ventilation in poultry houses	282
4.5.4.2.1.1	Circulating fans	282
4.5.4.2.1.2	Circulating fans in combination with heat exchangers.....	283
4.5.4.2.1.3	Equal spreading of recirculated air by indoor fans and heaters	284
4.5.4.2.1.4	Energy-saving fans.....	284
4.5.4.2.2	Management of ventilation in pig houses.....	285
4.5.4.2.3	Use of high-efficiency ventilation systems	288
4.5.5	Heat recovery	289
4.5.5.1	Heat exchangers	289
4.5.5.2	Heat pumps for heat recovery	293
4.5.5.3	Heat recovery in broiler housing with heated and cooled littered floor (combideck system)	295
4.5.6	Natural ventilation.....	298
4.6	TECHNIQUES FOR THE REDUCTION OF EMISSIONS FROM POULTRY HOUSES.....	301
4.6.1	Techniques for cage housing of laying hens	301
4.6.1.1	Enriched cages	303
4.6.1.2	Small groups in enriched cages.....	306
4.6.2	Techniques for non-cage housing of laying hens.....	307
4.6.2.1	Deep litter or floor regime systems	310
4.6.2.1.1	Forced ventilation system and infrequent manure removal (in case of deep litter with a manure pit).....	310
4.6.2.1.2	Manure belt or scraper (in case of deep litter with a manure pit).....	311
4.6.2.1.3	Forced air drying of manure via tubes (in case of deep litter with a manure pit).....	314
4.6.2.1.4	Forced air drying of manure using perforated floor (in case of deep litter with a manure pit)	315
4.6.2.2	Manure belts (in case of aviary).....	317
4.6.2.2.1	Manure belts (in case of aviary), with or without a veranda and free-range system.....	317
4.6.2.2.2	Underfloor manure drying (in case of aviary)	322
4.6.2.3	Forced air drying of litter using indoor air (in case of solid floor with deep litter).....	323
4.6.3	Techniques for housing of pullets	324
4.6.3.1	Group cage with manure belts and forced manure drying.....	326

4.6.3.2	Small groups in enriched cages	326
4.6.3.3	Aviaries.....	327
4.6.3.4	Deep litter with or without a manure pit.....	329
4.6.4	Techniques for housing of broilers	330
4.6.4.1	Natural or forced ventilation with a non-leaking drinking system (in case of solid floor with deep litter)	333
4.6.4.2	Forced drying system of litter using indoor air (in case of solid floor with deep litter)	336
4.6.4.2.1	Litter-based systems with circulating fans	336
4.6.4.2.2	Litter-based systems with circulating fans and a heat exchanger	338
4.6.4.2.3	Litter-based systems with air recirculated (equally spread) by indoor fans and heaters	340
4.6.4.3	Perforated floor with a forced air drying system	342
4.6.4.4	Litter on manure belt and forced air drying (in case of tiered floor systems)	344
4.6.4.5	Separate hatching and growing of broiler chicks for a limited time (in case of tiered floor systems)	346
4.6.4.6	Heated and cooled littered floor (combideck system).....	348
4.6.5	Techniques for housing of broiler breeders	348
4.6.5.1	Manure removal by belts, forced manure drying (in case of cage systems)	349
4.6.5.2	Manure belt or scraper (in case of deep litter with a manure pit)	350
4.6.5.3	Forced air drying of manure via tubes (in case of deep litter with a manure pit)	351
4.6.5.4	Forced air drying of manure using perforated floor (in case of deep litter with a manure pit).....	353
4.6.5.5	Litter-based systems with circulating fans	354
4.6.5.6	Manure belts (in case of aviary)	355
4.6.6	Techniques for housing of turkeys.....	356
4.6.6.1	Forced ventilation and a non-leaking drinking system (in case of solid floor with deep litter).....	356
4.6.6.2	Natural ventilation with a non-leaking drinking system (in case of solid floor with deep litter).....	358
4.6.7	Techniques for housing of ducks	360
4.6.7.1	Frequent litter addition (in case of solid floor with deep litter)	360
4.6.7.2	Frequent litter addition (in case of deep litter combined with slatted floor)	362
4.6.7.3	Frequent manure removal (in case of fully slatted floor).....	363
4.7	TECHNIQUES FOR THE REDUCTION OF EMISSIONS FROM PIG HOUSES	365
4.7.1	Common housing systems for various categories of pigs.....	369
4.7.1.1	Deep pit (in case of a fully slatted floor)	369
4.7.1.1.1	Deep pit (in case of a partly slatted floor).....	370
4.7.1.2	Vacuum system for frequent slurry removal (in case of a fully slatted floor)	372
4.7.1.3	Vacuum system for frequent slurry removal (in case of a partly slatted floor).....	374
4.7.1.4	Slanted walls in the manure channel (in case of a fully or partly slatted floor)	376
4.7.1.5	Scraper for frequent manure removal (in case of a partly or fully slatted floor).....	376
4.7.1.6	Convex floor and separated manure and water channels (in case of partly slatted pens)	378
4.7.1.7	Slurry cooling channels	379
4.7.1.8	Slurry surface cooling fins	380
4.7.1.9	Frequent slurry removal by flushing (in case of a fully or partly slatted floor)	383
4.7.1.10	Kennel or hut housing (in case of a partly slatted floor).....	386
4.7.2	Housing systems for mating and gestating sows	387
4.7.2.1	Deep pit (in case of a fully or partly slatted floor).....	390
4.7.2.2	Vacuum system for frequent slurry removal (in case of a fully slatted floor)	391
4.7.2.3	Vacuum system for frequent slurry removal (in case of a partly slatted floor).....	391
4.7.2.4	Slanted walls in the manure channel (in case of a fully or partly slatted floor)	392

4.7.2.5	Scraper for frequent slurry removal (in case of a fully or partly slatted floor).....	395
4.7.2.6	Frequent slurry removal by flushing (in case of a fully or partly slatted floor)....	395
4.7.2.7	Reduced manure pit (in case of a partly slatted floor).....	397
4.7.2.8	Kennel or hut housing (in case of a partly slatted floor)	400
4.7.2.9	Slurry cooling.....	402
4.7.2.10	Full litter system (in case of a solid concrete floor)	403
4.7.2.11	Feeding/lying boxes on a solid floor (in case of litter-based pens)	407
4.7.3	Housing systems for farrowing sows	409
4.7.3.1	Deep pit (in case of a fully or partly slatted floor)	411
4.7.3.1.1	Reduced manure pit (in case of a partly slatted floor).....	413
4.7.3.2	Vacuum system for frequent slurry removal (in case of a fully or partly slatted floor)	414
4.7.3.3	Slanted walls in the manure channel (in case of a fully or partly slatted floor) ...	414
4.7.3.4	Scraper for frequent slurry removal (in case of a fully or partly slatted floor)....	414
4.7.3.5	Frequent slurry removal by flushing (in case of a fully or partly slatted floor)....	415
4.7.3.6	Slurry cooling.....	416
4.7.3.7	A combination of water and manure channels (in case of a fully slatted floor) ...	417
4.7.3.8	Manure pan (in case of a fully or partly slatted floor).....	420
4.7.3.9	Littered pens with combined manure generation (slurry and solid manure)	422
4.7.4	Housing systems for weaners	423
4.7.4.1	Deep pit (in case of a fully or partly slatted floor)	426
4.7.4.2	Vacuum system for frequent slurry removal (in case of fully slatted floor).....	427
4.7.4.3	Vacuum system for frequent slurry removal (in case of partly slatted floor).....	427
4.7.4.4	Slanted walls in the manure channel (in case of a fully or partly slatted floor) ...	428
4.7.4.5	Scraper for frequent slurry removal (in case of fully or partly slatted floor)	429
4.7.4.6	Frequent slurry removal by flushing (in case of a fully or partly slatted floor)....	430
4.7.4.7	Kennel or hut housing (in case of a partly slatted floor)	431
4.7.4.8	Straw flow housing system (in case of a solid concrete floor)	433
4.7.4.9	Convex floor and separated manure and water channels (in case of partly slatted pens).....	433
4.7.4.10	Slurry cooling.....	435
4.7.4.11	Pens for weaning pigs with partly slatted floor	436
4.7.4.12	Pens or flat decks with a fully slatted floor and a concrete sloped underground floor to separate faeces and urine	438
4.7.4.13	Manure collection in water.....	439
4.7.4.14	Full litter system (in case of solid concrete floor).....	441
4.7.5	Housing systems for growing and finishing pigs (fattening pigs).....	445
4.7.5.1	Deep pit (in case of a fully or partly slatted floor)	449
4.7.5.2	Vacuum system for frequent slurry removal (in case of a fully slatted floor).....	452
4.7.5.3	Vacuum system for frequent slurry removal (in case of a partly slatted floor)	453
4.7.5.4	Fully or partly slatted floor with slanted walls in the manure channel	454
4.7.5.5	Scraper for frequent slurry removal (in case of a fully or partly slatted floor)....	455
4.7.5.6	Frequent slurry removal by flushing (in case of a fully or partly slatted floor)....	456
4.7.5.7	Reduced manure pit (in case of a partly slatted floor).....	458
4.7.5.8	Kennel or hut housing (in case of partly slatted floor)	459
4.7.5.9	Straw flow system (in case of a solid concrete floor).....	461
4.7.5.10	Partly slatted pens with a convex floor and separated manure and water channels.....	463
4.7.5.11	Manure collection in water.....	465
4.7.5.12	Slurry cooling.....	465
4.7.5.13	Full litter system (in case of a solid concrete floor)	468
4.7.5.14	Littered external alley (in case of a solid concrete floor)	474
4.7.5.15	V-shaped manure belts (in case of a partly slatted floor).....	475

4.8	TECHNIQUES FOR THE REDUCTION OF EMISSIONS TO AIR WITHIN HOUSING.....	478
4.8.1	Introduction.....	478
4.8.2	Ionisation	478
4.8.3	Water fogging	480
4.8.3.1	Misting of capturing and reactive agents	482
4.8.4	Oil spraying	484
4.8.5	Floating balls in slurry channels	486
4.8.6	Biological additives in poultry litter	487
4.9	END-OF-PIPE MEASURES FOR THE REDUCTION OF EMISSIONS TO AIR FROM HOUSING.....	489
4.9.1	Introduction.....	489
4.9.2	Water scrubber.....	492
4.9.3	Bioscrubber (or biotrickling filter).....	493
4.9.4	Wet acid scrubber	501
4.9.5	Biofilter.....	507
4.9.6	Multi-stage scrubber	509
4.9.6.1	Two-stage scrubber: wet acid scrubber combined with bioscrubber	509
4.9.6.2	Three-stage scrubber: water scrubber combined with wet chemical scrubber and biofilter	513
4.9.7	Partial air treatment in air cleaning systems	518
4.9.8	Dry filters.....	519
4.9.9	Water trap	521
4.10	TECHNIQUES FOR THE REDUCTION OF ODOUR EMISSIONS	522
4.10.1	General measures for odour prevention.....	522
4.10.1.1	Dilution of odorants.....	522
4.10.1.2	Discharge conditions	523
4.10.1.3	Dietary effects.....	525
4.10.1.4	Air cleaning systems.....	526
4.10.1.5	Odour management plan.....	526
4.10.2	Good operational practice in pig housing.....	528
4.10.3	Good operational practice in poultry housing.....	529
4.10.4	Slurry storage.....	529
4.10.5	Manure processing.....	530
4.10.6	Landspreading.....	530
4.11	TECHNIQUES FOR THE REDUCTION OF EMISSIONS FROM MANURE STORAGE.....	531
4.11.1	Reduction of emissions from storage of solid manure.....	531
4.11.1.1	General practice for the batch storage of solid manure in the field	531
4.11.1.2	Application of a covering to solid manure heaps.....	533
4.11.1.3	Storage of dried solid manure in a barn	536
4.11.1.4	Concrete silo for solid manure storage	537
4.11.2	Reduction of emissions from the storage of slurry	539
4.11.2.1	General aspects	539
4.11.2.2	Application of a rigid cover to slurry stores	542
4.11.2.3	Application of a flexible cover to slurry stores.....	546
4.11.2.4	Application of a floating cover to slurry stores.....	548
4.11.2.5	Application of covers to earth-banked slurry stores (lagoons)	557
4.11.2.6	Techniques to protect soil and water against emissions from slurry storage	560

4.11.2.6.1	Storage tank construction and auxiliary equipment for slurry collection and transfer.....	560
4.11.2.6.2	Measures to prevent and inspect leakage from slurry stores	562
4.11.2.6.3	Impermeable lining for earth-banked slurry lagoons.....	565
4.12	TECHNIQUES FOR THE ON-FARM PROCESSING OF MANURE	566
4.12.1	Introduction	566
4.12.2	Mechanical separation of slurry	570
4.12.2.1	Introduction.....	570
4.12.2.2	Screw press separator.....	574
4.12.2.3	Decanter-centrifuge separator	576
4.12.2.4	Coagulation-flocculation.....	578
4.12.2.5	Sieve separation	580
4.12.2.6	Filter presses	582
4.12.3	Biological treatment of slurry	584
4.12.3.1	Aerobic digestion (aeration) of slurry	584
4.12.3.1.1	Aerobic biological manure processing in a serial tank configuration.....	586
4.12.3.2	Nitrification-denitrification of slurry.....	587
4.12.4	Composting of solid manure	591
4.12.4.1	Composting	591
4.12.4.2	Co-composting of poultry manure with green residues.....	597
4.12.4.3	Composting of poultry manure with a biological inoculum.....	599
4.12.5	Anaerobic digestion of manure in a biogas installation	600
4.12.6	Anaerobic lagoon system	606
4.12.7	Evaporation and thermal drying of manure.....	608
4.12.8	External tunnel for manure drying	610
4.12.9	Slurry acidification.....	613
4.12.10	Combustion of poultry litter for energy recovery	618
4.12.11	Ammonia stripping.....	622
4.12.12	Manure additives.....	624
4.12.13	Slurry and wet manure belt dryer	629
4.13	TECHNIQUES FOR THE REDUCTION OF EMISSIONS FROM MANURE LANDSPREADING	632
4.13.1	Balancing the spreading of manure with the available land and soil/crop requirements.....	633
4.13.1.1	Phosphorus fertilisation norms.....	636
4.13.2	Groundwater protection schemes	636
4.13.3	Manure landspreading management practices	637
4.13.4	Manure application systems	641
4.13.4.1	Use of low-emission manure (solid or liquid) application techniques	641
4.13.4.2	Slurry dilution	648
4.13.4.2.1	Low-pressure water irrigation systems.....	648
4.13.4.2.2	Pulse-jet irrigator.....	650
4.13.4.2.3	Landspreading of diluted slurry using drip lines	652
4.13.4.3	Band spreader (or trailing hoses) and trailing shoes.....	653
4.13.4.4	Shallow injector (open slot)	657
4.13.4.5	Deep injector (closed slot).....	660
4.13.5	Incorporation of solid manure or slurry	663
4.14	TECHNIQUES TO REDUCE NOISE EMISSIONS.....	670

4.15	TECHNIQUES FOR THE TREATMENT AND DISPOSAL OF RESIDUES OTHER THAN MANURE AND DEAD ANIMALS	676
4.15.1	Solid residues	676
4.15.2	Generation, segregation and treatment of liquid residues	677
4.15.2.1	Segregation, collection and prevention of waste water generation	677
4.15.2.2	Treatment of waste water	679
4.15.2.3	Landspreading of waste water by using an irrigation system	684
4.16	OPTIMISATION OF THE WHOLE-FARM ENVIRONMENTAL IMPACT – ADOPTION OF AN INTEGRATED APPROACH	686
4.17	TECHNIQUES FOR THE REDUCTION OF DUST EMISSIONS	691
4.17.1	Techniques to reduce dust generation inside livestock buildings	691
4.17.2	Techniques to reduce the dust concentration inside animal houses	693
4.17.3	Air cleaning systems	693
4.18	MONITORING	694
4.18.1	Excretion of nitrogen and phosphorus	694
4.18.1.1	Mass balance	694
4.18.1.2	Manure analysis	695
4.18.2	Ammonia emissions	696
4.18.2.1	Mass balance	696
4.18.2.2	Ammonia emission measurements	698
4.18.2.3	Emission factors	700
4.18.3	Ventilation rate	700
4.18.4	Odour emissions	701
4.18.5	Dust emissions	702
4.18.6	Air cleaning systems	702
4.18.6.1	Verification of air cleaning systems	703
4.18.6.2	Monitoring of process parameters of air cleaning systems	703
4.18.7	Emissions to water	705
4.18.8	Process parameters	705
5	BAT CONCLUSIONS	707
	SCOPE	707
	DEFINITIONS	708
	GENERAL CONSIDERATIONS	710
5.1	GENERAL BAT CONCLUSIONS	711
5.1.1	Environmental management systems (EMS)	711
5.1.2	Good housekeeping	712
5.1.3	Nutritional management	713
5.1.4	Efficient use of water	714
5.1.5	Emissions from waste water	715
5.1.6	Efficient use of energy	716
5.1.7	Noise emissions	716
5.1.8	Dust emissions	718
5.1.9	Odour emissions	719
5.1.10	Emissions from solid manure storage	720
5.1.11	Emissions from slurry storage	721

5.1.12	On farm processing of manure	723
5.1.13	Manure landspreading	724
5.1.14	Emissions from the whole production process	725
5.1.15	Monitoring of emissions and process parameters	725
5.2	BAT CONCLUSIONS FOR THE INTENSIVE REARING OF PIGS	728
5.2.1	Ammonia emissions from pig houses	728
5.3	BAT CONCLUSIONS FOR THE INTENSIVE REARING OF POULTRY	731
5.3.1	Ammonia emissions from poultry houses	731
5.3.1.1	Ammonia emissions from houses for laying hens, broiler breeders or pullets	731
5.3.1.2	Ammonia emissions from houses for broilers	732
5.3.1.3	Ammonia emissions from houses for ducks	733
5.3.1.4	Ammonia emissions from houses for turkeys	733
5.4	DESCRIPTION OF TECHNIQUES	734
5.4.1	Techniques for reducing emissions from waste water	734
5.4.2	Techniques for efficient use of energy	734
5.4.3	Techniques for reducing dust emissions	735
5.4.4	Techniques for reducing odour emissions	736
5.4.5	Techniques for reducing emissions from the storage of solid manure	736
5.4.6	Techniques for reducing emissions from slurry storage	737
5.4.6.1	Techniques for reducing ammonia emissions from slurry stores and earth-banked storage	737
5.4.6.2	Techniques for reducing emissions to soil and water from slurry stores	738
5.4.7	Techniques for on farm manure processing	738
5.4.8	Techniques for manure landspreading	739
5.4.8.1	Techniques for slurry landspreading	739
5.4.9	Techniques for monitoring	740
5.4.9.1	Techniques for monitoring N and P excretion	740
5.4.9.2	Techniques for ammonia and dust monitoring	741
5.4.9.3	Techniques for monitoring of air cleaning systems	742
5.4.10	Nutritional management	743
5.4.10.1	Techniques for reducing nitrogen excreted	743
5.4.10.2	Techniques for reducing phosphorus excreted	743
5.4.11	Techniques to treat emissions to air from animal housing	744
5.4.12	Techniques for pig houses	744
5.4.12.1	Description of floor types and techniques for reducing ammonia emissions in pig houses	744
5.4.12.2	Techniques for cooling slurry	747
5.4.12.3	Techniques for reducing the pH of slurry	747
5.4.13	Techniques for poultry housing	747
5.4.13.1	Techniques for reducing ammonia emissions from houses for laying hens, broiler breeders or pullets	747
5.4.13.2	Techniques for reducing ammonia emissions from broiler houses	749
5.4.13.3	Techniques for reducing ammonia emissions from duck houses	749
5.4.13.4	Techniques for reducing ammonia emissions from turkey houses	749
6	EMERGING TECHNIQUES	751
6.1	REARING OF POULTRY	751
6.1.1	Low-litter flooring system for broilers	751

6.1.2	Sequential feeding in poultry	752
6.2	REARING OF PIGS.....	753
6.2.1	Air cleaning of underfloor exhaust airflow with fully slatted floors	753
6.2.2	Air cleaning of underfloor exhaust flow with partly slatted floors with a scraper and urine separation	755
6.2.3	Near-zero-emission stall housing system.....	757
6.2.4	Photocatalytic titanium dioxide coating paints	760
6.2.5	Alternative farrowing pens	760
6.3	MANURE PROCESSING	763
6.3.1	Combined biological manure processing and ammonia stripping	763
6.3.2	Phosphorus separation by gypsum-based precipitate	765
6.3.3	Electro-oxidation/electro-coagulation.....	766
6.3.4	Struvite precipitation.....	768
6.4	MANURE LANDSPREADING.....	770
6.4.1	P Index	770
7	CONCLUDING REMARKS AND RECOMMENDATIONS FOR FUTURE WORK	773
8	GLOSSARY.....	777
I.	ISO COUNTRY CODES	777
II.	MONETARY UNITS	777
III.	UNIT PREFIXES, NUMBER SEPARATORS AND NOTATIONS.....	778
IV.	UNITS AND MEASURES	778
V.	CHEMICAL ELEMENTS	779
VI.	CHEMICAL FORMULAE COMMONLY USED IN THIS DOCUMENT	780
VII.	ACRONYMS.....	781
VIII.	TECHNICAL TERMS	783
9	ANNEXES	795
9.1	ANIMAL SPECIES AND LIVESTOCK UNITS (LU).....	795
9.2	EXAMPLES OF PHASE FEEDING PROGRAMMES	798
9.2.1	Multiphase feeding for poultry	798
9.2.1.1	Pullets	798
9.2.1.2	Laying hens.....	799
9.2.1.3	Broilers	800
9.2.1.4	Turkeys	801
9.2.1.5	Ducks	802
9.2.2	Multiphase feeding for pigs	803
9.2.2.1	Gestating sows	803
9.2.2.2	Farrowing sows.....	803
9.2.2.3	Weaners	804
9.2.2.4	Fattening pigs	804
9.2.2.5	Multiphase feeding in France	806
9.3	EXAMPLE OF CALCULATION OF COSTS ASSOCIATED WITH THE APPLICATION OF EMISSION REDUCTION TECHNIQUES	807

9.3.1	Methodology	807
9.3.2	Examples in the UK	810
9.3.3	Examples in Spain.....	812
9.3.4	Appendices.....	816
9.4	REFERENCE TECHNIQUES.....	820
9.5	DATA COMPILATION FOR EXCRETION.....	821
9.5.1	Total nitrogen excreted from pig rearing	821
9.5.2	Total phosphorus excreted from pig rearing	823
9.5.3	Total nitrogen excreted from poultry rearing.....	824
9.5.4	Total phosphorus excreted from poultry rearing.....	826
9.6	DATA COMPILATION FOR AMMONIA EMISSIONS.....	828
9.6.1	Ammonia emissions to air from an animal house for pigs	828
9.6.2	Ammonia emissions to air from an animal house for poultry	831
10	REFERENCES.....	835

List of figures

Figure 1.1:	Animal density in the European Union expressed as number of livestock units per hectare of utilised agricultural area in 2010	2
Figure 1.2:	Example of the production chain of the egg production sector	7
Figure 1.3:	Example of the production chain of the broiler production sector	11
Figure 1.4:	Evolution of the weekly EU average price for Class A eggs in packing stations for the period 2009 to 2014	15
Figure 1.5:	Market prices for eggs from caged hens (average for categories L and M) for the period 2011 to 2013.....	15
Figure 1.6:	Evolution of monthly EU average selling price in slaughter plants for broilers (wholesale price for class A chicken) for the period 2006 to 2012	17
Figure 1.7:	Market prices for broilers for the period 2011 to 2013	18
Figure 1.8:	Pig density by region (in average number per km ²) in 2013	21
Figure 1.9:	Production of meat by type of animal (in tonnes) in the EU-28.....	23
Figure 1.10:	Evolution of pig meat market prices on weekly basis (EUR/100 kg deadweight) in the EU-28, January 2009 - February 2015	28
Figure 1.11:	Market prices for pig meat	29
Figure 1.12:	Illustration of the potential negative environmental aspects related to intensive livestock farming.....	31
Figure 1.13:	Nitrogen consumption, utilisation and losses in the production of a pig for slaughter with a final live weight of 108 kg.....	32
Figure 1.14:	Emissions of ammonia to air by industry sector/activity in Europe in 2014.....	34
Figure 1.15:	Nitrogen cycle showing the main transformations and losses to the environment after manure landspreading	38
Figure 2.1:	Schematic representation of activities carried out on farms for the intensive rearing of poultry or pigs	42
Figure 2.2:	Possible placement of the equipment in enriched cages.....	45
Figure 2.3:	Schematic drawing of two large enriched cages	45
Figure 2.4:	Schematic cross section of a single-tiered non-cage system	48
Figure 2.5:	Common aviary configurations	50
Figure 2.6:	Example of schematic cross section of a common broiler house	52
Figure 2.7:	Effect of dust attraction caused by ionisation on the roof of a poultry shed	61
Figure 2.8:	Schematic view of a housing design for mating sows.....	73
Figure 2.9:	Individual housing of mating sows (service centre).....	74
Figure 2.10:	Floor design for sow crates with a solid concrete floor for mating and gestating sows	74
Figure 2.11:	Example of a housing system for group housing of gestating sows with individual feeding stalls and shared lying and defecating area	75
Figure 2.12:	Example of group housing for gestating sows with individual feeding stalls in combination with full litter.....	76
Figure 2.13:	Example of group housing for mating and gestating sows with perforated lying area (perforation in the lying area < 15 %).....	76
Figure 2.14:	Layout of a pen for gestating sows fed with an electronic feeder	78
Figure 2.15:	Example of confined housing of farrowing sows on a fully slatted floor with a storage pit underneath.....	79
Figure 2.16:	Farrowing pens allowing sow movement.....	80
Figure 2.17:	Schematic picture of a fully slatted floor pen for weaners	81
Figure 2.18:	Schematic picture of a weaner pen with a partly slatted floor.....	82
Figure 2.19:	Design of a partly slatted floor system for fattening pigs.....	85
Figure 2.20:	Pen design for fattening pigs with partly slatted (convex) floor and solid area in the centre.....	85
Figure 2.21:	Solid concrete floor with slatted external alley and scraper underneath	86
Figure 2.22:	An example of a solid concrete floor system for fattening pigs	87
Figure 2.23:	Solid concrete floor with external littered alley and manure channel	87
Figure 2.24:	Schematic view of airflow in an exhaust ventilation system.....	93
Figure 2.25:	Schematic view of airflow in a pressure ventilation system.....	93
Figure 2.26:	Schematic view of airflow in a neutral ventilation system.....	94
Figure 2.27:	Schematic representation of a wet scrubber	103
Figure 2.28:	Example of above-ground slurry tank with an underground receiving pit	116
Figure 2.29:	Example of earth-banked slurry store, and design features	117
Figure 2.30:	Placement of the manure when applying manure with different application and incorporation methods.....	128
Figure 2.31:	Example of a broadcast spreader with a splash plate	130

Figure 2.32:	Example of a raingun.....	131
Figure 2.33:	Example of a broadcast technique with low trajectory and low pressure	131
Figure 2.34:	Example of a broadcast technique with low trajectory and low pressure	132
Figure 2.35:	Rear view of a horizontal boom with splash plate for slurry application.....	133
Figure 2.36:	Side view of a horizontal boom with splash plate for slurry application	133
Figure 2.37:	Example of a band spreader fitted with rotary distributor to improve lateral distribution	134
Figure 2.38:	Example of an open slot injector	135
Figure 2.39:	Example of a rotaspreader	136
Figure 2.40:	Example of a rear discharge spreader	136
Figure 2.41:	Example of a dual-purpose spreader	137
Figure 2.42:	Vertical drum manure spreader.....	138
Figure 2.43:	Operating principle of a heat pump	146
Figure 3.1:	Evolution of water consumption with the live weight of post-weaning piglets	159
Figure 3.2:	Breakdown of electricity consumption on pig farms in France	167
Figure 3.3:	Evolution over time of ammonia volatilisation (percentage of total nitrogen) for different pig categories	177
Figure 3.4:	Nitrogen losses from manure landspreading.....	194
Figure 3.5:	Cumulative ammonia volatilisation losses during storage and following landspreading of broiler litter.....	202
Figure 4.1:	Continuous improvement in an EMS model.....	215
Figure 4.2:	Example of reduced protein intake by animals achieved by synthetic amino acid supplementation to a low-protein diet, while maintaining an adequate amino acid supply.....	232
Figure 4.3:	Fluctuation of synthetic amino acids and high-protein feedstuff (soya) prices from 2004 to 2008	241
Figure 4.4:	Example of the cost difference between a low-protein diet and a conventional diet in Spain	242
Figure 4.5:	Effect of reduced crude protein diets on the intake of water by pigs.....	261
Figure 4.6:	Schematic representation of feed, water and heat distribution by a biomass burner in a broiler house	280
Figure 4.7:	Schematic representation of a heat recovery system installed in a broiler house	296
Figure 4.8:	Graphic representation of the working principle of the combideck system during one broiler production cycle	296
Figure 4.9:	Scheme of rows of enriched cages for laying hens	303
Figure 4.10:	Schematic representation of a deep litter system with a manure pit for laying hens	311
Figure 4.11:	Schematic representation of a deep litter system with a manure pit, a veranda and a free-range system for laying hens	312
Figure 4.12:	Deep litter systems with forced drying via tubes under the slatted floor	314
Figure 4.13:	Deep litter system with perforated floor and forced manure drying	316
Figure 4.14:	Scheme of a litter-based aviary for laying hens	318
Figure 4.15:	Combinations of slatted floors in aviaries	319
Figure 4.16:	Scheme of the underfloor manure drying system in aviary with a deep pit	322
Figure 4.17:	Cross section of the housing system with deep litter and a manure pit	329
Figure 4.18:	Examples of layouts for systems of circulating fans and a heat exchanger	339
Figure 4.19:	Plan and cross section of horizontal ventilation with air recirculated by indoor fans.....	340
Figure 4.20:	Schematic representation of a forced drying system with a perforated floor for broilers (A), an improved design (B), and a detail of the floor of the improved design (C).....	343
Figure 4.21:	Schematic overview of the tiered floor system with two rows and six floors.....	345
Figure 4.22:	Schematic cross section and principle of a tiered floor system with forced drying for broilers.....	345
Figure 4.23:	Example of a time flow pattern synchronising the patio hatching/raising cycle (19 days) with the finishing cycle in the different houses	347
Figure 4.24:	Cross section of system with forced air drying by vertical tubes.....	352
Figure 4.25:	Scheme of an additional tier over the nests in an aviary system.....	355
Figure 4.26:	Scheme of a naturally ventilated house for turkey fattening.....	359
Figure 4.27:	Principle of operation of the overflow slurry channel	371
Figure 4.28:	Vacuum system in case of a fully slatted floor	372
Figure 4.29:	Vacuum system in case of a partly slatted floor	374
Figure 4.30:	Example of PE pipes ready to be cast in concrete	379
Figure 4.31:	Slurry surface cooling fins.....	381
Figure 4.32:	Fully slatted floor with flushing gutters.....	383
Figure 4.33:	Fully slatted floor with flushing tubes	384
Figure 4.34:	Fully slatted floor with flushing of a permanent slurry layer in channels underneath	384

Figure 4.35: Cross section and plan view of the floor in a housing system for gestating sows with a manure channel with slanted walls.....	393
Figure 4.36: Flushing gutters in individual mating/gestating sow housing (in case of a partly slatted floor).....	396
Figure 4.37: Individual housing with a small manure pit	398
Figure 4.38: Solid concrete floor and fully slatted external alley with a storage pit underneath	398
Figure 4.39: Kennel housing system for gestating sows.....	400
Figure 4.40: Kennel housing for mating and gestating sows with individual feeding stalls	401
Figure 4.41: Littered floor with a slatted feeding area.....	404
Figure 4.42: Solid concrete floor system with straw and electronic sow feeders	405
Figure 4.43: Scheme of the floor levels in litter-based pens with feeding/lying boxes	408
Figure 4.44: Farrowing crate with a partly slatted floor (solid floor in the lying areas)	411
Figure 4.45: Farrowing crate with a manure scraper (in case of a partly slatted floor)	415
Figure 4.46: Flushing system with a manure gutter.....	416
Figure 4.47: Combination of water and manure channels	418
Figure 4.48: Shallow slurry pits separating manure and water channels during construction	418
Figure 4.49: A manure pan (in case of fully slatted floor).....	420
Figure 4.50: Littered farrowing pens with a yard	422
Figure 4.51: Flat deck system with a scraper under a fully slatted floor	429
Figure 4.52: Kennel housing system for weaners.....	431
Figure 4.53: Partly slatted floor with a shallow manure pit and a water channel for spoiled drinking water in combination with a convex floor	434
Figure 4.54: Convex floor with triangular metal slats in combination with a discharge system and slanted walls in the manure channel.....	434
Figure 4.55: Partly slatted floor with a convex or sloped concrete floor	436
Figure 4.56: Flat decks or pens with an underground concrete slope to separate faeces from urine	438
Figure 4.57: Cross section of a variation of a system for rearing weaners with manure collection in water.....	440
Figure 4.58: Housing system with deep litter for weaners	441
Figure 4.59: Housing system with a littered floor and a yard (with or without a covered lying area) for weaners.....	442
Figure 4.60: Convex floor in combination with a gutter system.....	456
Figure 4.61: Partly slatted floor and external alley with the flushing of a permanent slurry layer in channels underneath.....	457
Figure 4.62: Kennel housing system for fattening pigs	460
Figure 4.63: Design of the straw flow system for fattening pigs	462
Figure 4.64: Effect on costs of heat utilisation for different levels of slurry cooling	467
Figure 4.65: Pens with a solid concrete straw-bedded floor and natural ventilation	469
Figure 4.66: Schematic plans and sections of housing systems equipped with V-shaped belts	475
Figure 4.67: Effect of dust attraction caused by ionisation on the roof of a poultry shed	478
Figure 4.68: Schematic view of an oil spraying system	485
Figure 4.69: Schematic representation of the functioning principle of floating balls.....	486
Figure 4.70: Ammonia removal efficiency as a function of the proportion of the treated air by the air cleaning system.....	491
Figure 4.71: Bioscrubber workflow.....	494
Figure 4.72: Ammonia emissions from a broiler house.....	504
Figure 4.73: Two-stage scrubber: acid scrubber combined with bioscrubber	510
Figure 4.74: Three stage scrubber: water scrubber combined with wet acid scrubber and biofilter	514
Figure 4.75: Schematic of a dry filter installed in a broiler house.....	520
Figure 4.76: Scheme of the water trap.....	521
Figure 4.77: Rigid cover for slurry storage, with conical shape	543
Figure 4.78: Geometrical plastic tiles in a slurry tank	550
Figure 4.79: Underground slurry tank with liquid-tight geomembrane.....	561
Figure 4.80: Inspection shaft for area drainage pipes from a slurry store.....	563
Figure 4.81: Examples of manure processing strategies.....	567
Figure 4.82: Screw press scheme.....	574
Figure 4.83: Schematic of a decanter centrifuge for slurry separation	576
Figure 4.84: Schematic representation of a coagulation-flocculation pretreatment for slurry separation	578
Figure 4.85: Illustration of a rotating (drum) sieve separator used for slurry	581
Figure 4.86: Schematic representation of a filter-pressing separator.....	583

Figure 4.87:	Mass balance and composition of the different streams resulting from a combination of a mechanical separation stage with flocculation and a biological aeration treatment with serial tank configuration	587
Figure 4.88:	Example of biogas installation, following anaerobic treatment of manure, located in Denmark	601
Figure 4.89:	Principle of external drying tunnel with perforated manure belts.....	611
Figure 4.90:	Schematic representation of a slurry acidification system.....	613
Figure 4.91:	Systems for slurry acidification directly in the storage tank.....	614
Figure 4.92:	Equipment for slurry acidification during spreading	614
Figure 4.93:	Whole-farm assessment of the slurry acidification effect on the nitrogen available for plant uptake.....	616
Figure 4.94:	Scheme of a manure belt dryer	630
Figure 4.95:	Irrigation boom fitted with hanging nozzles to spray the water-slurry mixture close to the soil surface	649
Figure 4.96:	Pulse-jet irrigator in operation	651
Figure 4.97:	Example of trailing hoses mounted on a bar.....	654
Figure 4.98:	Scheme of a trailing shoe spreader	654
Figure 4.99:	Scheme of an open slot injector	658
Figure 4.100:	Scheme of a closed slot injector	661
Figure 4.101:	Incorporation equipment combined with a big tanker	664
Figure 4.102:	Scheme of a first flush system	680
Figure 4.103:	Location of a system of swales and wetland for a poultry farm	681
Figure 4.104:	Layout of a system for purifying slurry based on constructed wetlands.....	682
Figure 4.105:	Example of a sprinkler or travelling irrigation system.....	684
Figure 6.1:	Layout of the ventilation system (left) and the floor design (right) with reduced slat openings.....	753
Figure 6.2:	Drawing of the partly slatted floored 'Perstrup' pens	756
Figure 6.3:	Scheme of slurry cooling in the shallow manure channels and heated piglet area	758
Figure 6.4:	Gestating sow room of the near-zero-emission pig housing system showing the 'roof-ceiling' construction principle.....	758
Figure 6.5:	An illustration of a design for an alternative farrowing sow pen.....	761
Figure 6.6:	Schematic representation of the combined treatment system including the solid separation step, biological treatment procedure and ammonia stripping stages	764
Figure 9.1:	Total nitrogen excreted by weaners	821
Figure 9.2:	Total nitrogen excreted by fattening pigs (1 of 2)	821
Figure 9.3:	Total nitrogen excreted by fattening pigs (2 of 2)	822
Figure 9.4:	Total nitrogen excreted by sows	822
Figure 9.5:	Total phosphorus excreted by weaners	823
Figure 9.6:	Total phosphorus excreted by fattening pigs	823
Figure 9.7:	Total phosphorus excreted by sows	824
Figure 9.8:	Total nitrogen excreted by laying hens.....	824
Figure 9.9:	Total nitrogen excreted by broilers.....	825
Figure 9.10:	Total nitrogen excreted by ducks.....	825
Figure 9.11:	Total nitrogen excreted by turkeys	826
Figure 9.12:	Total phosphorus excreted by laying hens.....	826
Figure 9.13:	Total phosphorus excreted by broilers.....	827
Figure 9.14:	Total phosphorus excreted by turkeys	827
Figure 9.15:	Ammonia emissions to air from an animal house for mating and gestating sows (1 of 2)	828
Figure 9.16:	Ammonia emissions to air from an animal house for mating and gestating sows (2 of 2)	828
Figure 9.17:	Ammonia emissions to air from an animal house for farrowing sows.....	829
Figure 9.18:	Ammonia emissions to air from an animal house for weaners (1 of 2)	829
Figure 9.19:	Ammonia emissions to air from an animal house for weaners (2 of 2)	830
Figure 9.20:	Ammonia emissions to air from an animal house for fattening pigs (1 of 2).....	830
Figure 9.21:	Ammonia emissions to air from an animal house for fattening pigs (2 of 2).....	831
Figure 9.22:	Ammonia emissions to air from an animal house for laying hens (1 of 2)	831
Figure 9.23:	Ammonia emissions to air from an animal house for laying hens (2 of 2)	832
Figure 9.24:	Ammonia emissions to air from an animal house for broilers (1 of 2)	832
Figure 9.25:	Ammonia emissions to air from an animal house for broilers (2 of 2).....	833

List of tables

Table 1.1:	Animal density in the EU-28 expressed as number of livestock units per hectare of utilised agricultural area for the years 2007, 2010 and 2013.....	3
Table 1.2:	Summary of existing farms requiring a permit by category of activities in Annex I to Directive 2010/75/EU (reference period 2012–2013).....	4
Table 1.3:	Typical poultry rearing data.....	5
Table 1.4:	Balance sheet for total egg production in the EU-27 for the years 2010–2013.....	5
Table 1.5:	Number of laying hens and usable production of eggs (total eggs) in EU-27 Member States.....	6
Table 1.6:	Balance sheet for poultry meat production (in carcass weight) in the EU-27 for the years 2011–2013.....	8
Table 1.7:	Poultry meat production in the EU-27 (in thousand tonnes of carcass weight) in 2012.....	9
Table 1.8:	Number of utility chicks of table strains hatched (in thousands of heads) in EU-27 Member States.....	10
Table 1.9:	Marketing terms and conditions for production of alternative broilers, according to Regulations (EC) 543/2008 and 834/2007 (organic).....	11
Table 1.10:	Comparison of production costs for rearing systems for laying hens at EU level.....	13
Table 1.11:	Prices, technical performance and production costs for egg production in selected EU countries in 2010.....	14
Table 1.12:	Average performance data and production costs for egg production in France for the year 2011.....	14
Table 1.13:	Average performance data and production costs for meat poultry species in France for the year 2009.....	16
Table 1.14:	Prices, technical performance and production costs for broiler production in selected EU countries in 2011.....	16
Table 1.15:	Pig population in the EU-28 in 2015 (in thousands).....	19
Table 1.16:	Pig population and changing structure of pig farms by herd size class in the EU-28, 2005-2010.....	22
Table 1.17:	Balance sheet for pig meat production (in carcass weight) in the EU-27 for the years 2010–2013.....	24
Table 1.18:	Summary of physical performance data for the production of pigs for selected EU countries (year 2009).....	25
Table 1.19:	Summary of financial performance in the year 2014 in selected countries (in EUR per kg deadweight ⁽¹⁾).....	27
Table 1.20:	Changes in total production costs in the EU for the years 2009–2014 (in EUR per kg deadweight).....	28
Table 1.21:	Emissions to air from the intensive rearing of poultry or pigs.....	32
Table 1.22:	Overview of processes and factors involved in ammonia release from animal houses.....	33
Table 1.23:	Total fluxes of greenhouse gas emissions for the EU-27 pig and poultry production.....	35
Table 2.1:	Summary of the main characteristics of enriched cages.....	44
Table 2.2:	Range of weights of duck breeds for meat and egg production.....	55
Table 2.3:	Examples of required indoor temperature for broiler rearing.....	57
Table 2.4:	Indoor temperature for rearing turkeys, applied in France.....	57
Table 2.5:	Examples of lighting programmes for broiler production.....	60
Table 2.6:	Number of birds serviced by each type of drinking equipment in France.....	66
Table 2.7:	Absorbency and characteristics of different bedding types.....	69
Table 2.8:	Manure and bedding management in litter-based systems for fattening pigs in France (from 30 kg to 115 kg live weight).....	88
Table 2.9:	General indicative levels of indoor environment for pigs.....	89
Table 2.10:	Example of temperature requirements in heated housing for different pig categories in healthy conditions.....	90
Table 2.11:	Ventilation rates and indoor temperatures for pig housing, in France.....	95
Table 2.12:	Ventilation rates and indoor temperatures for pig housing, in the Netherlands.....	96
Table 2.13:	Ventilation rates for thermally insulated pig houses according to DIN 18910-1, in Germany and Austria.....	96
Table 2.14:	Number of animal serviced by each type of drinking equipment in France.....	102
Table 2.15:	Storage times of poultry and pig manure in a number of Member States.....	107
Table 2.16:	Examples of national regulations (2013) prohibiting manure application during certain periods of the year.....	108
Table 2.17:	Advantages and disadvantages of solid manure- and slurry-based systems.....	109
Table 2.18:	Factors used for calculating storage dimensions for pig slurry, in Belgium-Flanders and Spain.....	111

Table 2.19:	Factors for calculating the dimensions of the manure store for cage-reared laying hens in France (1 000 bird places)	113
Table 2.20:	Examples of requirements applied for temporary field heaps in different Member States	114
Table 2.21:	Qualitative comparison of four slurry transport systems	129
Table 2.22:	Comparison of solid manure spreading systems	137
Table 3.1:	Key environmental issues of the major on-farm activities	149
Table 3.2:	Indication of feed conversion ratio and feed consumption per poultry category	151
Table 3.3:	Appraisal of protein and lysine levels and scope for recommended amino acid balances	152
Table 3.4:	Applied calcium and phosphorus levels in commercial feeds for poultry	152
Table 3.5:	Appraisal of protein and lysine levels and scope for recommended amino acid balances for sows (one phase for every physiological stage)	153
Table 3.6:	Applied calcium and phosphorus levels in commercial feeds for sows	154
Table 3.7:	Appraisal of protein and lysine levels and scope for recommended amino acid balances for pigs (one phase for each major stage of growth)	154
Table 3.8:	Calcium and digestible phosphorus standard levels applied to feed for pigs, in total amount per kg of feed	155
Table 3.9:	Example of rationing used for conventional and heavy fattening pigs in Italy	155
Table 3.10:	Average nutritional levels applied in Italy for heavyweight pigs for different live weight intervals (as % of raw feed)	156
Table 3.11:	Water consumption of different poultry species per cycle and per year	156
Table 3.12:	Estimated water use for cleaning of poultry housing	157
Table 3.13:	Average water requirements of pigs in Spanish farms with respect to pig category	158
Table 3.14:	Example of the effect of water to feed ratio on the production and dry matter content of manure of fattening pigs	159
Table 3.15:	Effect of water delivery of drinking nipples on the production and dry matter content of manure of fattening pigs	160
Table 3.16:	Estimated average water use for the cleaning of pig housing in Denmark	160
Table 3.17:	Annual average gas consumption reported for poultry production in France	162
Table 3.18:	Annual average electricity consumption for poultry production in France	163
Table 3.19:	Distribution of electricity consumption for two poultry farms in France	163
Table 3.20:	Indicative levels of daily energy consumption of activities on poultry farms in Italy	163
Table 3.21:	Indicative levels of energy use in poultry farms in the UK	164
Table 3.22:	Estimates of energy consumption (kWh/bird) for pullets and laying hens, in France	164
Table 3.23:	Energy consumption allocation in a broiler house in Finland	164
Table 3.24:	Share of energy sources and total average energy consumption for different types of pig farms in France	165
Table 3.25:	Distribution of energy consumption in integrated farms in France, for each physiological stage (average values from 15 farms)	165
Table 3.26:	Shares of energy consumption for each consuming process, in integrated farms in France	165
Table 3.27:	Average annual energy consumption per type of pig farm and by type of energy source used and operation in Italy	166
Table 3.28:	Average daily energy consumption for farms in Italy by animal capacity and energy source	166
Table 3.29:	Electric energy consumption for different rearing stages in pig farms in the UK (data from 11 farms)	167
Table 3.30:	Typical amounts of bedding materials applied in France in pig housing systems	168
Table 3.31:	Typical amounts of bedding material used in poultry and pigs housing systems	169
Table 3.32:	Nitrogen excretion standards calculated for different animal categories	171
Table 3.33:	Excretion levels of different elements in poultry manure, in France	172
Table 3.34:	Examples of excretion levels for total N and P, from Italy, Ireland and Belgium (Flanders)	172
Table 3.35:	Standard values for excretion of broilers in Denmark (reference year 2014)	172
Table 3.36:	Calculated excretion levels for different poultry categories, in the Netherlands (reference year 2008)	173
Table 3.37:	Nitrogen and excreta production by poultry type in the UK (reference year 2012)	173
Table 3.38:	Composition and production of manure from different poultry species and manure management in France	174
Table 3.39:	Range of levels reported for daily and annual production of manure, urine and slurry by different pig categories	175
Table 3.40:	Example of effect of reduced CP levels in feed for growers and finishers on daily consumption, retention and losses of nitrogen	175

Table 3.41:	Average excretion of nitrogen (kg per year) in housing with a breeding sow (205 kg) and different numbers of piglets (up to 25 kg) at weaning.....	176
Table 3.42:	Nitrogen retention in different growing phases of fattening pigs (Italian data)	176
Table 3.43:	Standard level of nitrogen excretion in kg/animal place/year, in France	177
Table 3.44:	Example of consumption, retention and excretion of phosphorus in pigs (kg per pig)	178
Table 3.45:	Average composition of different types of pig manure and standard deviation (in brackets) in kg per 1 000 kg of manure	178
Table 3.46:	Pig excreta and nitrogen produced in relation to different pig categories and nutritional measures, in the UK	179
Table 3.47:	Calculated annual excretion of nutrients per pig category, in the Netherlands (reference year 2008)	179
Table 3.48:	Annual excretion rates and slurry generation for pig rearing units and different pig categories, in Ireland and Belgium (Flanders)	180
Table 3.49:	Annual excretion rates for different pig categories, in Denmark (reference year 2014)	180
Table 3.50:	Examples of national ammonia emission factors for poultry housing.....	183
Table 3.51:	Ammonia emission factors for different poultry types, in Denmark	183
Table 3.52:	Estimated emissions from fan ventilated littered duck housing in the UK.....	184
Table 3.53:	Range of reported air emission levels from poultry houses	185
Table 3.54:	Ammonia emission factors for pig housing, used in the UK.....	186
Table 3.55:	Ammonia emission factors for pig housing by pig category, in Germany	187
Table 3.56:	Range of emissions to air from housing systems for sows (mating/gestating, farrowing) ..	188
Table 3.57:	Range of emissions to air from housing systems for weaners.....	188
Table 3.58:	Range of emissions to air from housing systems for fattening pigs	188
Table 3.59:	Average ammonia and nitrous oxide emissions during storage of solid pig manure in heaps.....	189
Table 3.60:	Ammonia and nitrous oxide emissions during storage of solid poultry manure in heaps ..	190
Table 3.61:	Range of ammonia emission factors for solid poultry manure storage as reported by Member States.....	190
Table 3.62:	Emission factors reported by the UK for solid manure storage.....	190
Table 3.63:	Ammonia emissions from uncovered stored pig slurry	191
Table 3.64:	Ammonia emission factors for covered and uncovered slurry storage in Denmark	191
Table 3.65:	Range of ammonia emission factors for pig slurry storage as reported by Member States ..	192
Table 3.66:	Factors influencing the emission levels of ammonia into air from landspreading	194
Table 3.67:	Emissions from solid manure landspreading, with or without incorporation, reported from the UK	195
Table 3.68:	Range and average values of ammonia emissions measured after landspreading of solid manure without incorporation	196
Table 3.69:	Ranges of national ammonia emission factors for slurry landspreading, as reported by Member States.....	196
Table 3.70:	Average NH ₄ -N emission factors and ranges of measured values, expressed as percentage of total ammoniacal nitrogen applied.....	196
Table 3.71:	Emissions of N ₂ O-N from landspreading of solid manures	197
Table 3.72:	Reported N ₂ O-N emissions from pig manure landspreading	197
Table 3.73:	Emissions of metals associated with landspreading of poultry manure	200
Table 3.74:	Examples of the nitrogen flow through the whole farm chain for broiler manure	200
Table 3.75:	Examples of the nitrogen flow through the whole farm chain for laying hen manure	201
Table 3.76:	Nitrogen losses through all stages of poultry manure management by type of manure produced, in France	201
Table 3.77:	Nitrogen losses through all stages of pig manure management (without manure processing), in France	202
Table 3.78:	Examples of ammonia emission factors used as a reference for housing, storage and landspreading of slurry in Spain.....	203
Table 3.79:	Typical sources of noise and examples of noise levels in poultry units	204
Table 3.80:	Typical sources of noise and examples of noise levels in pig units	204
Table 3.81:	Odour emission factors for different animal categories and housing systems in the Netherlands, Germany and Denmark	206
Table 4.1:	Information for each technique	207
Table 4.2:	Examples of emission concentrations in flue-gases from small-scale on-farm incinerators	214
Table 4.3:	Examples of total emissions per operating cycle from small-scale on-farm incinerators ..	214
Table 4.4:	Standard levels of nitrogen (N) and diphosphorus pentoxide (P ₂ O ₅) excretion in Germany, Finland and France	220

Table 4.5:	Examples of the influence of nutrition measures on excreted nitrogen, phosphorus and potassium for the rearing of pigs	220
Table 4.6:	Regressions used in Belgium (Flanders) to calculate the actual level of excretion	222
Table 4.7:	Contract prices for raw materials and estimates of raw material costs for balanced feed formulations for pigs.....	223
Table 4.8:	Examples of multiphase feeding regimes and associated emissions in the poultry sector ..	226
Table 4.9:	Reduction potential for ammonia emissions in fattening pig production with different crude protein adjusted feeding.....	228
Table 4.10:	Examples of excreted nitrogen reductions for two-phase feeding programmes in the pig sector compared to the one-phase feeding	228
Table 4.11:	Example of the influence of multiphase feeding on excreted nitrogen and phosphorus for fattening pigs.....	229
Table 4.12:	Example of the influence of multiphase feeding with amino acid and phytase addition on excreted nitrogen and phosphorus for sows and weaners	230
Table 4.13:	Indicative crude protein levels in low-protein feeds for pigs.....	233
Table 4.14:	Indicative crude protein levels in low-protein feeds for poultry	234
Table 4.15:	Environmental and economic benefits of formulating a low-crude-protein diet with synthetic amino acid supplementation	235
Table 4.16:	Effects of two low-protein diets with partial or total substitution of soybeans by essential amino acids on fattening pigs (finishers)	236
Table 4.17:	Summary of the effect of a reduction of dietary protein and the use of low-protein diets on nitrogen excretion and ammonia emission.....	236
Table 4.18:	Effects of reduced crude protein levels with amino acid supplementation in one-phase feeding of fattening pigs	237
Table 4.19:	Examples of emissions and costs reductions for two-phase feeding schemes after transition from a one-phase feeding scheme for fattening pigs	237
Table 4.20:	Effectiveness of transition from two-phase feeding to three-phase feeding for fattening pigs and different crude protein reductions	238
Table 4.21:	Effect of the protein content of fattening pigs' feed on slurry characteristics and nitrogen emissions	239
Table 4.22:	Example of extra costs calculation for low-protein feeding strategies for fattening pigs ..	241
Table 4.23:	Total phosphorus, phytate-phosphorus and phytase activity in selected plant feedstuffs ..	243
Table 4.24:	Examples of excreted phosphorus reduction for different feeding programmes in the pig sector, applying a low-phosphorus diet with or without addition of phytase.....	245
Table 4.25:	Calculated reduction of phosphorus excretion based on digestibility, for the poultry sector.....	247
Table 4.26:	Measured results of benzoic acid effects by rate of addition and by the characteristics of the tests in growing and finishing pigs	251
Table 4.27:	Reductions in excretion with the direct-fed microbial strains in pigs.....	253
Table 4.28:	Reductions in excretion with the direct-fed microbial strains of lactobacillus in finishing broilers.....	253
Table 4.29:	Gains in FCR and value of ingested feed with the use of probiotics in broilers	253
Table 4.30:	Average daily balance of nitrogen in broilers with and without the addition of feed additives (enzymes)	255
Table 4.31:	Effect of different additives in poultry at various feeding stages	255
Table 4.32:	Examples of the effect of drinking equipment on the water consumption and slurry generation of fattening pigs	260
Table 4.33:	Examples of the effect of drinking equipment on the water consumption and slurry generation of gestating sows.....	260
Table 4.34:	Benchmark figures for energy use in a pig farm.....	265
Table 4.35:	Benchmark figures for energy use in a weaning house.....	265
Table 4.36:	Heat transfer coefficients (U) for different poultry house insulation materials with a thickness of 2.54 cm	267
Table 4.37:	Estimations of heat losses during one production cycle from roofs in laying hen housing, and the requirements for energy replacement (building area: 1 200 m ²).....	268
Table 4.38:	Costs for the renovation of insulation and sealing in a standard poultry house of 1 200 m ²	269
Table 4.39:	Recommended heat transfer coefficients (U) for two different temperatures, applied in France	271
Table 4.40:	Effect of insulation thickness on heat consumption in weaner houses	271
Table 4.41:	Principal lighting sources for animal houses	273
Table 4.42:	Example of a mixed farm benefitting from warm water heating served by a wood boiler ..	281

Table 4.43:	Operating conditions and energy consumption of a broiler housing system equipped with energy-saving fans, in Finland	285
Table 4.44:	Heat consumption according to minimum ventilation flows and added insulation, for weaners at an early post-weaning age	287
Table 4.45:	Ammonia emissions and germs concentration in relation to the ventilation rate	287
Table 4.46:	Example of operational data of an air-air heat exchanger	290
Table 4.47:	Propane and electricity consumption and costs, in three different poultry farms applying heat recovery by air-air heat exchangers	292
Table 4.48:	Results of the application of the combideck system.....	297
Table 4.49:	Comparison of performance for identical houses with and without the combideck system.....	297
Table 4.50:	Different natural ventilation configurations	299
Table 4.51:	Summary of relevant reported achievable emissions in cage systems for laying hens.....	302
Table 4.52:	Effect of increasing the manure removal frequency, without manure drying, on ammonia emissions from enriched cages in comparison with weekly manure removal	304
Table 4.53:	Effect of manure removal frequency, with manure drying on ventilated belts, on ammonia emissions from enriched cages, and associated costs	304
Table 4.54:	Economic consequences of removing manure two or three times per week compared to only once per week.....	305
Table 4.55:	Summary of relevant reported achievable emissions in deep-litter-based non-cage systems for laying hens	308
Table 4.56:	Summary of relevant reported achievable emissions in aviary-based non-cage systems for laying hens.....	309
Table 4.57:	Ventilation rates applied in deep litter housing systems for laying hens.....	313
Table 4.58:	Cost data associated with different deep litter systems with a manure pit	313
Table 4.59:	Resource demand associated with the different deep litter systems with a manure pit	313
Table 4.60:	Reported ventilation rates for aviary systems for laying hens equipped with manure belts	320
Table 4.61:	Summary of cost data in Germany for different configurations of aviary systems for laying hens	321
Table 4.62:	Summary of reported achievable emissions in systems for rearing pullets	325
Table 4.63:	Emissions associated with combinations of slatted floor extension, characteristics of the drying air and frequency of manure removal, for the rearing of pullets.....	328
Table 4.64:	Summary of reported emissions from broiler housing with different system configurations.....	331
Table 4.65:	Effects on emissions of controlling mechanical ventilation in deep litter broiler housing systems	334
Table 4.66:	Breakdown of resource demand in kWh per bird place/year in deep litter broiler houses (cycles of 38–42 days).....	335
Table 4.67:	Investment costs for deep litter houses for broilers	336
Table 4.68:	Reported emissions from broiler production in deep litter housing systems with circulating fans	337
Table 4.69:	Summary of emissions in systems for rearing broiler breeders.....	349
Table 4.70:	Cost data for deep litter systems equipped with manure pit aeration through pipes	353
Table 4.71:	Extra costs for manure pit aeration through pipes (in case of deep litter systems), in comparison with a reference system	353
Table 4.72:	Ventilation parameters in turkey rearing	357
Table 4.73:	Emissions from turkey rearing systems, with forced or natural ventilation (in case of deep litter)	357
Table 4.74:	Ventilation rate range for forced ventilated Pekin duck rearing houses.....	360
Table 4.75:	Reported emission data from deep litter systems for the rearing of ducks.....	361
Table 4.76:	Reported ventilation rates applied in vacuum systems for frequent slurry removal (in case of a fully slatted floor).....	373
Table 4.77:	Consumption related to the management of FSF systems equipped with vacuum slurry removal.....	373
Table 4.78:	Costs for the implementation of cooling fins for different animal categories and expected ammonia emissions reduction, in the Netherlands	382
Table 4.79:	Emission levels of system-integrated housing techniques for mating and gestating sows	388
Table 4.80:	Emission levels associated with slanted walls in the manure channel (in case of partly slatted floors).....	394
Table 4.81:	Ammonia emissions from mating/gestating sow houses with frequent slurry removal by flushing.....	396
Table 4.82:	Energy requirements for flushing systems applied in gestating sow houses	397

Table 4.83:	Emissions from housing systems for gestating sows with a reduced manure pit.....	399
Table 4.84:	Calculated extra costs for installing a reduced manure pit for gestating sows in existing houses with a fully slatted floor.....	399
Table 4.85:	Consumption and labour requirements for kennel housing systems for mating and gestating sows.....	401
Table 4.86:	Expected electricity consumption depending on the cooling programme applied.....	402
Table 4.87:	Emissions of mating and gestating sows housed in littered systems.....	406
Table 4.88:	Resources demand associated with solid floor housing systems covered with litter for mating/gestating sows, in Germany.....	406
Table 4.89:	Extra costs for the implementation of straw-littered solid floors with weekly replacement of bedding, in Spain.....	407
Table 4.90:	Emission levels of system-integrated housing techniques for farrowing sows.....	410
Table 4.91:	Investment costs reported for a fully slatted floor housing system with water and manure channels, in comparison with a fully slatted floor system with a deep pit.....	419
Table 4.92:	Extra costs for installing in FSF a combination of water and manure channels compared to a deep pit.....	419
Table 4.93:	Extra costs for installing in a FSF a manure pan in comparison to a deep pit, in Spain....	421
Table 4.94:	Emission levels of system-integrated housing techniques for weaners.....	424
Table 4.95:	Ventilation rates (m ³ /h per animal place) applied to weaner houses with fully slatted floors.....	426
Table 4.96:	Consumption and labour requirements for kennel housing systems for weaners.....	432
Table 4.97:	Emissions of housing systems equipped with a convex solid floor and separate manure and water channels.....	434
Table 4.98:	Odour emission factors for weaners, in Germany.....	437
Table 4.99:	Extra costs associated to the retrofitting of partly slatted floors in existing fully slatted floored pens for weaners, in Spain.....	438
Table 4.100:	Resources demand for two different variations of solid concrete floor housing systems with litter for weaners (8–28 kg).....	443
Table 4.101:	Emission levels associated with straw-littered systems for rearing of weaners.....	444
Table 4.102:	Emission levels of system-integrated housing techniques for fattening pigs.....	446
Table 4.103:	Emissions associated with a deep pit (in case of a fully slatted floor) or with an overflow channel for various categories of pigs.....	450
Table 4.104:	Resources demand for the rearing of fattening pigs in houses with a fully slatted floor with an overflow channel.....	450
Table 4.105:	Ventilation rates (m ³ /h per animal place) applied to fattening pig houses with fully slatted floors.....	451
Table 4.106:	Emissions from partly slatted floor systems for fattening pigs with infrequent manure removal.....	451
Table 4.107:	Investment and operating costs for fattening pig houses with a fully slatted floor with an overflow channel.....	452
Table 4.108:	Emission levels associated with slanted walls in the manure channel.....	454
Table 4.109:	Ammonia emissions from fattening pig houses with frequent slurry removal by flushing.....	457
Table 4.110:	Emissions from housing systems for fattening pigs with a reduced manure pit.....	459
Table 4.111:	Calculated extra costs for installing a reduced manure pit in existing houses with a fully slatted floor, in Spain.....	459
Table 4.112:	Consumption and labour requirements for kennel housing systems for fattening pigs.....	460
Table 4.113:	Emission levels from straw flow systems for fattening pigs.....	463
Table 4.114:	Emissions of housing systems equipped with a convex solid floor and separated manure and water channels.....	464
Table 4.115:	Ammonia emission values achieved by slurry cooling channels for different fattening pig housing systems and cooling effect levels.....	466
Table 4.116:	Electricity consumption of cooling channels in partly slatted floors by the cooling effect applied.....	466
Table 4.117:	Emission levels from housing systems with full litter for the rearing of fattening pigs.....	471
Table 4.118:	Resource requirements associated with deep litter and littered-floors applied to fattening pigs housing systems (¹).....	472
Table 4.119:	Average characteristics of solid manure produced by deep litter housing systems for fattening pigs, in France.....	472
Table 4.120:	Extra costs for implementation of straw littered housing systems for fattening pigs in comparison to a fully slatted floor system with a deep pit.....	473
Table 4.121:	Emissions associated with the use of the V-shaped belt system in partly slatted floor systems.....	476

Table 4.122: Investment and operating costs for partly slatted floor systems with V-shaped manure belts, compared to conventional houses, in the Netherlands	477
Table 4.123: Parameters and performances of fogging in poultry housing compared to other cooling systems techniques	481
Table 4.124: Estimation of the annual operating costs for a fogging system	481
Table 4.125: Odour abatement efficiencies achieved by misting of reactive agents in laboratory trials	483
Table 4.126: Estimates of average costs for the atomisation of patented odour-abating chemicals by animal produced	483
Table 4.127: Extra costs related to the technique of oil spraying in poultry housing	485
Table 4.128: Composition of treated and untreated turkey manure	488
Table 4.129: Types of exhaust air cleaning systems in animal housing, their applicability and removal performance	489
Table 4.130: Extra costs related to water scrubbers in poultry housing	493
Table 4.131: Emission reductions achieved by the application of bioscrubbers in pig production	495
Table 4.132: Reported emission levels achieved with the application of bioscrubbers	496
Table 4.133: Examples of water consumption and water discharges for fattening pig farms applying bioscrubbers	497
Table 4.134: Associated costs for bioscrubbers in the Netherlands by pig category	498
Table 4.135: Cost ranges associated with the use of bioscrubbers for exhaust air treatment in fattening pig production, in Germany and Denmark	499
Table 4.136: Investment and annual operating costs for a biotrickling filter applied to a newly built facility for pig production	500
Table 4.137: Extra costs related to the application of bioscrubbers in poultry housing	500
Table 4.138: Examples of removal efficiencies of chemical scrubbers applied in pig and poultry housing systems	502
Table 4.139: Reported emission levels achieved with the application of acid scrubbers	503
Table 4.140: Additional energy consumption associated with air cleaning by an acid scrubber applied in pig farms in Denmark	504
Table 4.141: Associated extra costs for acid scrubbers by associated ammonia reduction efficiency and animal category in the Netherlands	505
Table 4.142: Investment and annual operating costs for an acid scrubber applied to a new house for pig production	505
Table 4.143: Extra costs related to the application of acid scrubbers in poultry housing	506
Table 4.144: Annual resources demand for the operation of a biofilter, in Germany	508
Table 4.145: Emission reductions achieved by the application of two-stage scrubbers in pig production	511
Table 4.146: Emission levels achieved with the application of two-stage scrubbers in pig production	511
Table 4.147: Cost ranges associated with the use of two-stage scrubber systems for exhaust air treatment in fattening pig production, in Germany	512
Table 4.148: Costs associated with the use of two-stage scrubbers with an 85 % NH ₃ reduction efficiency, in the Netherlands	513
Table 4.149: Examples of removal efficiencies achieved with a three stage scrubber system (water scrubber, wet acid scrubber and biofilter)	515
Table 4.150: Emission levels achieved with the application of three-stage scrubbers in pig production	515
Table 4.151: Annual resources demand for the operation of a multi-stage scrubber, in Germany	516
Table 4.152: Waste water volume produced by air cleaning system in a housing system for 1 000 fattening pigs	516
Table 4.153: Cost ranges associated with the use of three-stage scrubber systems (combining a water scrubber, wet acid scrubber and biofilter) in fattening pig houses	517
Table 4.154: Investment and annual operating costs for a three-stage scrubber (water and acid scrubber + biotrickling) applied to a newly built facility for fattening pig production	517
Table 4.155: Emission levels and cost data for different percentages of exhaust air treated by two-stage air cleaning systems	519
Table 4.156: Ammonia emissions from covered and uncovered poultry manure heaps	534
Table 4.157: Nitrogen losses from covered and uncovered solid manure heaps	535
Table 4.158: Cost data of a silo for the storage of solid pig manure	538
Table 4.159: Overview of the different types of covers applied in slurry storage	541
Table 4.160: Ammonia emissions as a percentage of the total stored nitrogen in slurry containers in Denmark	542
Table 4.161: Reduction of gaseous emissions from the storage of slurry with the use of a rigid cover in underground pilot stores, compared to uncovered stores	544
Table 4.162: Costs for rigid polyester covers reported from France	544
Table 4.163: Cost data for different covers of slurry tanks, in Germany	545

Table 4.164:	Ammonia emissions mitigation costs for different covers of slurry tanks, in Germany	545
Table 4.165:	Costs for different types of flexible covers in France	547
Table 4.166:	Costs for covering an above-ground slurry tank with flexible covers, in the UK.....	548
Table 4.167:	Performance of different types of floating covers	554
Table 4.168:	Investment costs for some types of floating covers, in Denmark	555
Table 4.169:	Investment costs for different types of floating covers in France	556
Table 4.170:	Costs for covering an above-ground slurry tank with floating flexible covers, in the UK	556
Table 4.171:	Cost data for different covers of earth-banked slurry stores (lagoons), in Germany	559
Table 4.172:	Investment costs for covering a slurry lagoon in the UK.....	559
Table 4.173:	Cost data for above-ground and underground slurry silos	562
Table 4.174:	Investment costs for slurry tanks and leakage inspection systems in Germany.....	564
Table 4.175:	Summary of the main characteristics of techniques for processing manure	568
Table 4.176:	Characteristics and technical data of common slurry separators in the Netherlands	572
Table 4.177:	Costs of slurry mechanical separation in the Netherlands for an annual capacity of 5 000 m ³	573
Table 4.178:	Separation performance range of a screw press.....	575
Table 4.179:	Characteristics of the separated fractions from a decanter-centrifuge separation of typical pig slurry in Denmark	577
Table 4.180:	General characteristics of the incoming slurry and the produced fractions after a mechanical separation process including flocculation.....	579
Table 4.181:	Example of pig slurry separated with a drum sieve	581
Table 4.182:	Mass balance of the mechanical separation and biological treatment of pig slurry	589
Table 4.183:	Composition of manure and products in g/kg	589
Table 4.184:	Nitrogen and weight losses during composting of solid pig manure, in France	595
Table 4.185:	Investment costs for equipment used in composting plants.....	596
Table 4.186:	Indicative values of the C/N ratio for different materials	597
Table 4.187:	Composition variation of turkey manure co-composted with green residues (ratio 1/1 in weight).....	598
Table 4.188:	Energy consumption of equipment used in composting and co-composting plants	598
Table 4.189:	Operational and cost data for a biogas plant applied on a small-scale farm, operating with pig slurry only.....	604
Table 4.190:	Number of existing biogas plants for manure digestion and the amount of manure digested in the Baltic Sea region countries (estimated for year 2012).....	605
Table 4.191:	Characteristics of effluents from slurry treated in anaerobic lagoons.....	607
Table 4.192:	Costs for a vacuum evaporation plant for pig slurry, with a capacity of 14 000 tonnes/year.....	610
Table 4.193:	Average ammonia, methane and nitrous oxide emissions from the laying hen house and drying tunnel.....	612
Table 4.194:	Cost data reported for slurry acidification in relation to the number of pigs, in Denmark	617
Table 4.195:	Operating costs for a slurry acidification unit treating 10 000 m ³ /yr, in Denmark	617
Table 4.196:	Achievable emission levels from a fluidised bed combustion plant for poultry litter, in comparison with fresh wood shavings and ELVs set by Directive 2010/75/EU for waste incineration plants.....	620
Table 4.197:	Summary of the main characteristics for different groups of manure additives	628
Table 4.198:	Input and output characteristics of the manure processed in the manure belt drying process	630
Table 4.199:	Calculated maximum allowable animal number per hectare	635
Table 4.200:	Costs for implementing spring slurry application practices in a typical pig farm in the UK in order to limit nitrate leaching losses	640
Table 4.201:	Characteristics of four different slurry application techniques	643
Table 4.202:	Bonus for conserved nitrogen, achieved by applying low-emission spreading techniques for slurry	646
Table 4.203:	Costs for slurry spreading and associated ammonia emission reduction costs for different application techniques and farm sizes, in Germany	647
Table 4.204:	Average chemical characteristics of the water-slurry mixture.....	653
Table 4.205:	Estimated operating costs for a band spreader system and a broadcast system for the application of slurry.....	656
Table 4.206:	Extra costs related to slurry application with band spreading techniques in comparison with a broadcast spreader, in Spain.....	657
Table 4.207:	Ammonia emissions reduction achieved by slurry injection in comparison with surface application techniques, in Denmark.....	659
Table 4.208:	Extra energy and costs associated with open (shallow) and closed (deep) slot injection for different operating conditions applied in Denmark.....	660

Table 4.209: Summary of experiment results on ammonia emissions reduction with different manure incorporation equipment	665
Table 4.210: Average ammonia emissions and reduction efficiencies from the spreading of solid manures followed by immediate incorporation using different equipment	665
Table 4.211: Reduction of ammonia emissions achieved by the incorporation of solid manure after application.....	666
Table 4.212: Calculated ammonia emissions from the application of solid pig manure followed by incorporation, with different equipment and time lags.....	666
Table 4.213: Emissions of N ₂ O after spreading and incorporation of solid manure	666
Table 4.214: Example of the effect of storage conditions and application conditions of broiler litter on subsequent emissions during application	667
Table 4.215: Comparison of ammonia losses from different procedures for landspreading of differently stored broiler litters.....	667
Table 4.216: Extra costs for the incorporation of slurry applied by a broadcast spreader with a splash plate, in comparison with no incorporation within 24 hours, in Spain	668
Table 4.217: Reducing effect of different noise measures	674
Table 4.218: Examples of assessed combinations of techniques for fattening pigs	687
Table 4.219: Examples of assessed combinations of techniques for broiler production	688
Table 4.220: Examples of assessed combinations of techniques for laying hens in enriched cages	688
Table 4.221: Examples of assessed combinations of techniques for laying hens on litter	689
Table 4.222: Emission factors for dust (PM ₁₀) reported for various pig categories and types of manure management	692
Table 4.223: Emission factors for dust (PM ₁₀) reported for various poultry categories and types of manure management	693
Table 4.224: Sampling strategy and monitoring conditions for testing ammonia emissions in a livestock housing system.....	699
Table 4.225: Sampling strategy and monitoring conditions for testing dust emissions in a livestock housing system.....	702
Table 4.226: Parameters to be recorded in the operations logbook.....	704
Table 5.1: BAT-associated total nitrogen excreted	713
Table 5.2: BAT-associated total phosphorus excreted	714
Table 5.3: BAT-associated time delay between manure landspreading and incorporation into the soil.....	725
Table 5.4: BAT-AEL for ammonia emissions to air from each pig house	730
Table 5.5: BAT-AELs for ammonia emissions to air from each house for laying hens	731
Table 5.6: BAT-AEL for ammonia emissions to air from each house for broilers with a final weight of up to 2.5 kg.....	732
Table 6.1: Odour, hydrogen sulphide and ammonia concentrations and emissions	754
Table 6.2: Average concentrations and emissions of ammonia and odour measured in trials with underfloor ventilation.....	756
Table 6.3: Nutrient content of the resulting fractions after the multi-step biological and chemical manure processing.....	765
Table 6.4: Example of concentration levels obtained before and after treatment of pig slurry by electro-coagulation	767
Table 6.5: Efficiency of a combination of electro-coagulation and electro-oxidation in laboratory trials.....	767
Table 7.1: Key milestones of the review process of the BREF for the Intensive Rearing of Poultry or Pigs	773
Table 7.2: Split views.....	774
Table 9.1: Standard values for the calculation of live animal mass in LU, used in Germany	795
Table 9.2: Standard values for the calculation of live animal mass in LU, used in Spain	796
Table 9.3: Standard values for the calculation of live animal mass in LU, used in the UK	796
Table 9.4: Livestock unit coefficients used by Eurostat.....	797
Table 9.5: Multiphase feeding for pullets in the UK	798
Table 9.6: Multiphase feeding for pullets (free range) in the UK	798
Table 9.7: Multiphase feeding for pullets in Germany	798
Table 9.8: Multiphase feeding for laying hens (in cages) in the UK.....	799
Table 9.9: Multiphase feeding for laying hens (free range) in the UK.....	799
Table 9.10: Multiphase feeding for laying hens (in cages) in Germany.....	799
Table 9.11: Multiphase feeding for light broilers (40 days) in the UK	800
Table 9.12: Multiphase feeding for heavy broilers (7 to 8.5 weeks) in the UK	800
Table 9.13: Multiphase feeding for broilers in Germany	800
Table 9.14: Multiphase feeding for turkeys in the UK	801

Table 9.15:	Multiphase feeding for turkeys (starter) in Germany.....	801
Table 9.16:	Multiphase feeding for turkeys (male) in Germany.....	801
Table 9.17:	Multiphase feeding for turkeys (female) in Germany.....	802
Table 9.18:	Multiphase feeding for ducks in Germany.....	802
Table 9.19:	Multiphase feeding for gestating sows in the UK.....	803
Table 9.20:	Multiphase feeding for gestating sows in Germany.....	803
Table 9.21:	Multiphase feeding for farrowing sows in Germany.....	803
Table 9.22:	Multiphase feeding for weaners and growers in the UK.....	804
Table 9.23:	Multiphase feeding for weaners in Germany.....	804
Table 9.24:	Multiphase feeding for finishers in the UK (two phases).....	804
Table 9.25:	Multiphase feeding for fattening pigs in Germany (two phases).....	805
Table 9.26:	Multiphase feeding for weaners and fattening pigs in the UK (5 phases).....	805
Table 9.27:	Multiphase feeding for fattening pigs in Germany (5 phases).....	805
Table 9.28:	Multiphase feeding for pigs in France.....	806
Table 9.29:	Units used for assessing costs.....	808
Table 9.30:	Capital expenditure considerations.....	809
Table 9.31:	Annual cost considerations.....	809
Table 9.32:	Additional costs incurred with liquid manure application by soil injection in the UK.....	810
Table 9.33:	Additional costs incurred with solid manure incorporation by ploughing in the UK.....	811
Table 9.34:	Additional costs incurred with air duct installation in the UK.....	811
Table 9.35:	Additional costs incurred with metal grid floor replacement in the UK.....	812
Table 9.36:	Additional costs incurred for the installation of multiphase feeding in fattening pig houses in Spain.....	812
Table 9.37:	Additional costs to install a partly slatted floor with a reduced pit in gestating sow houses in Spain.....	813
Table 9.38:	Additional costs to install a manure pan with a smooth surface under the slatted floor in a new house for farrowing sows in Spain.....	813
Table 9.39:	Additional costs to install a manure pan with a smooth surface under the slatted floor in an existing house for farrowing sows in Spain.....	814
Table 9.40:	Additional costs to install slanted walls in the manure pit of a new house for weaners in Spain.....	814
Table 9.41:	Additional costs to install a partly slatted floor and reduced pit in an existing gestating pig house in Spain.....	815
Table 9.42:	Additional costs incurred for the fitting of a mounted trailing hose system to an existing slurry tanker.....	816
Table 9.43:	Economic life of new facilities.....	817
Table 9.44:	Repair costs as a percentage of new costs.....	818
Table 9.45:	Annual costs to consider in capital costs of feeding systems.....	818
Table 9.46:	Annual costs to consider in capital costs of housing systems.....	819
Table 9.47:	Annual costs to consider in capital costs of manure storage systems.....	819
Table 9.48:	Annual costs to consider in capital costs of manure storage systems.....	819

SCOPE

This BREF for the Intensive Rearing of Poultry or Pigs concerns the following activities specified in Section 6.6 of Annex I to Directive 2010/75/EU, namely '6.6. Intensive rearing of poultry or pigs':

- (a) with more than 40 000 places for poultry
- (b) with more than 2 000 places for production of pigs (over 30 kg), or
- (c) with more than 750 places for sows.

In particular, this document covers the following on-farm processes and activities:

- nutritional management of poultry and pigs;
- feed preparation (milling, mixing and storage);
- rearing (housing) of poultry and pigs;
- collection and storage of manure;
- processing of manure;
- manure landspreading;
- storage of dead animals.

This document does not address the following processes or activities:

- disposal of dead animals; this may be covered in the BREF for Slaughterhouses and Animal By-products Industries (SA);

Other reference documents which are of relevance for the activities covered by this BREF are the following:

Reference documents	Activity
Waste Incineration (WI)	Incineration of manure
Waste Treatment Industries (WT)	Composting and anaerobic digestion of manure
Monitoring of emissions from IED-installations (ROM)	Monitoring of emissions to air and water
Economics and Cross-media Effects (ECM)	Economics and cross-media effects of techniques
Emissions from Storage (EFS)	Storage and handling of materials
Energy Efficiency (ENE)	General aspects of energy efficiency
Food, Drink and Milk Industries (FDM)	Feed production

The scope of the BREF does not include matters that only concern safety in the workplace or the safety of products because these matters are not covered by the Directive. They are discussed only where they affect matters within the scope of the Directive.

1 GENERAL INFORMATION

This chapter provides general information on pig and poultry production in Europe. It briefly describes the position of Europe in the world market and developments in the internal European market and those of its Member States. It introduces the main environmental issues associated with intensive pig and poultry farming.

For the purposes of this document, the term 'farm' is used as synonymous with 'installation' as defined in the Industrial Emissions Directive, which may consist of one or more stationary technical units (plants) and of all the directly associated activities. Other terminology used in this document includes:

- Rearing of poultry: the rearing cycle for the production of eggs or for the production of meat from chickens, turkeys, ducks, guinea fowl, etc., including parent stock and pullets.
- Rearing of pigs: the rearing of animals of the porcine species, of any age, kept for breeding or fattening.
- Rearing of sows: the rearing of female pigs including mating, gestating and farrowing sows (including offspring) as well as replacement sows (which have been selected or purchased as replacement breeding stock and are part of the sow herd) and gilts that have been serviced.

1.1 Intensive livestock farming

Farming has been and still is dominated by family-run businesses. Until the mid-1970s, crops were grown and different animal species were reared in mixed farming systems. Feed was grown on the farm or purchased locally and manure was returned to the land as fertiliser.

Since then, increasing market demands, the evolution of breeds due to genetic selection, the development of farming equipment and the availability of a wide range of feedstuff have encouraged farmers to specialise. As a consequence, animal numbers and farm sizes have increased and livestock farming has become intensive. Some regions have specialised in animal production; scale and agglomeration economies have appeared, leading to areas of high animal density. The feed market has opened up and feed materials have started to be imported from outside the EU. Intensive farming has thus led to significant imports of nutrients that are then returned to soil, in the form of manure, in different areas to that where the feed material was produced, sometimes in excessive loads.

Animal density is itself considered a rough indicator of the amount of animal manure produced and therefore of the nutrient supply to the land, which can exceed the requirements of the agricultural area to grow crops or to maintain grassland. Hence, data on the concentration of livestock production at a regional level are considered a good indicator of areas with potential environmental problems (e.g. eutrophication of natural waters due to excess nitrogen and/or phosphorus).

The term 'livestock units' (see Section 9.1) can be used in reports to present the total size of the livestock population, allowing a summation of animal species according to their feed requirements. The meaning of the term 'intensive livestock farming' in Europe is illustrated by using animal density expressed in the number of livestock units per hectare of utilised agricultural area (LU/ha).

Figure 1.1 shows the animal density of all farmed livestock (in LU/ha) at a regional level in 2010. In 2010 the total livestock population in the EU-27 amounted to 134 million livestock units which was a decrease of -2 % compared with 2005. The total livestock density in EU-28 in 2010 was 0.77 LU/ha. The picture illustrates that for nearly all Member States the

environmental impact of intensive livestock farming is a regional issue, but for a few countries like the Netherlands and Belgium it can almost be considered a national issue. The total livestock density remained more or less stable between 2005 and 2010 in EU-27 [2, Eurostat 2017]. Table 1.1 shows the variation of animal density for the years 2007, 2010 and 2013 in the EU-28 and for each Member State, expressed in livestock units per hectare of utilised agricultural area.

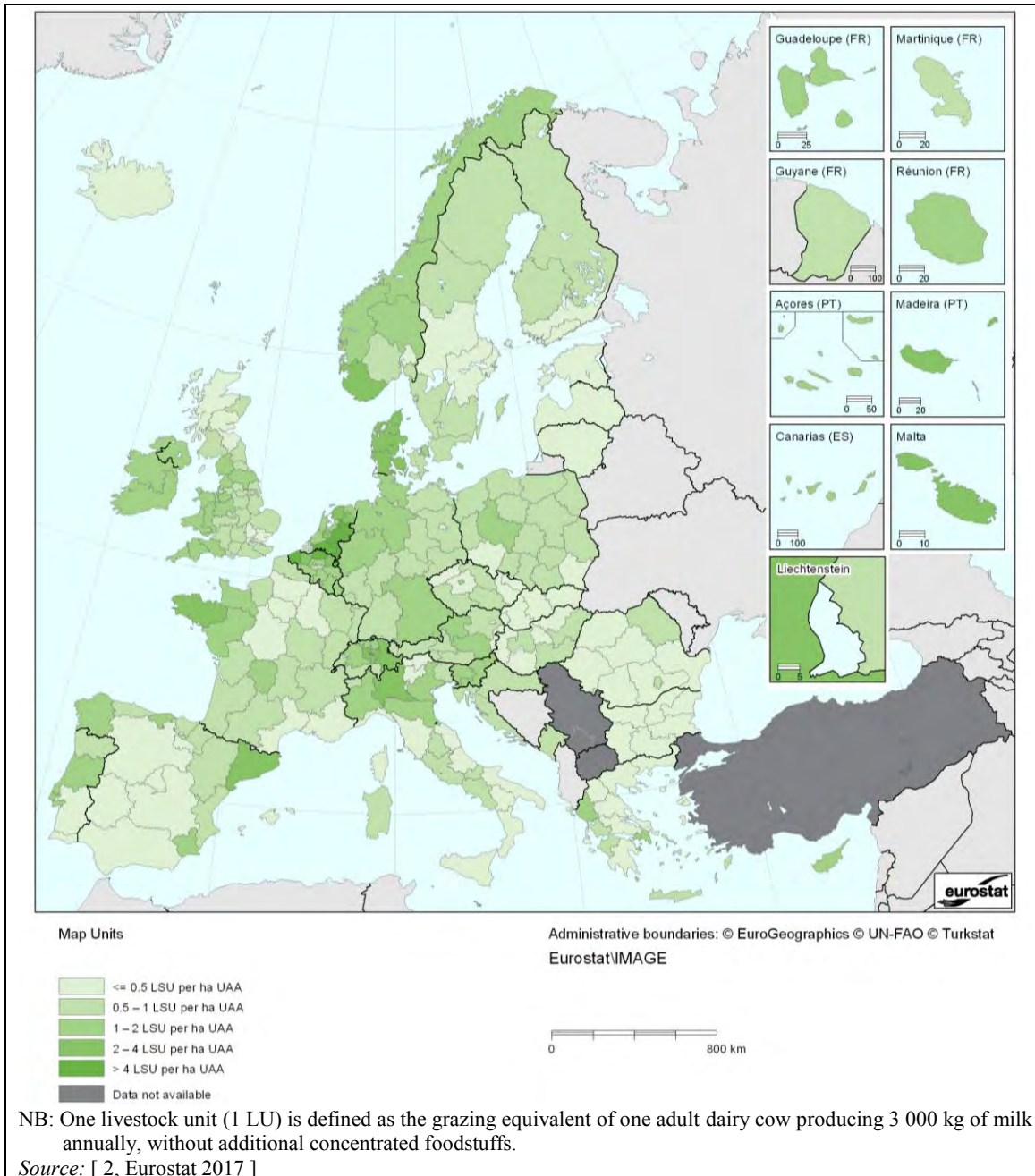

Figure 1.1: Animal density in the European Union expressed as number of livestock units per hectare of utilised agricultural area in 2010

Table 1.1: Animal density in the EU-28 expressed as number of livestock units per hectare of utilised agricultural area for the years 2007, 2010 and 2013

Country	2007	2010	2013	Country	2007	2010	2013
Belgium	2.76	2.80	2.74	Lithuania	0.39	0.33	0.29
Bulgaria	0.41	0.26	0.22	Luxembourg	1.23	1.28	1.26
Czech Republic	0.58	0.49	0.50	Hungary	0.57	0.53	0.49
Denmark	1.72	1.86	1.58	Malta	4.80	3.64	3.21
Germany	1.06	1.07	1.10	Netherlands	3.35	3.58	3.57
Estonia	0.35	0.33	0.32	Austria	0.78	0.87	0.89
Ireland	1.43	1.16	1.20	Poland	0.72	0.72	0.64
Greece	0.64	0.46	0.44	Portugal	0.58	0.60	0.56
Spain	0.58	0.62	0.62	Romania	0.44	0.41	0.38
France	0.82	0.81	0.79	Slovenia	1.13	1.07	1.00
Croatia	0.90	0.78	0.55	Slovakia	0.39	0.35	0.34
Italy	0.78	0.77	0.77	Finland	0.50	0.49	0.51
Cyprus	1.69	1.70	1.60	Sweden	0.57	0.57	0.56
Latvia	0.28	0.26	0.26	United Kingdom	0.86	0.79	0.76
NB: One livestock unit (1 LU) is defined as the grazing equivalent of one adult dairy cow producing 3 000 kg of milk annually, without additional concentrated foodstuffs.							
Source: [6, Eurostat 2017]							

The areas with high livestock densities typically have many intensive pig and poultry farms, each with a large number of animals. For example, the share of pigs and poultry exceeds 50 % in most of these regions and poultry accounts for more than 20 % of the regional livestock population in parts of France (Loire Region, Brittany), Spain (Catalonia) and the United Kingdom (east England). In some Member States there is a decline in the actual number of farms, but the remaining farms now tend to keep more animals and have higher production.

Based on data submitted by Member States during 2009–2011, information on the number of farms specified in Section 6.6 of Annex I to the IED is given in Table 1.2.

Table 1.2: Summary of existing farms requiring a permit by category of activities in Annex I to Directive 2010/75/EU (reference period 2012–2013)

Member State	Total	Poultry 6.6 (a)	Pigs 6.6 (b)	Sows 6.6 (c)
Austria	27	22	3	2
Belgium	859	448	366	35
Flanders	792	415	344	33
Wallonia	67	43	22	2
Bulgaria	93	49	23	21
Cyprus	50	20	30	NI
Czech Rep.	428	238	140	50
Denmark	1 245	NI	NI	NI
Germany	2 682	1 465	931	286
Estonia	53	7	46	0
Greece	55	46	3	6
Spain	2 918	544	1 685	689
Finland	229	131	68	30
France	3 189	2 515	589	85
Hungary	581	241	246	94
Italy	1 812	892	800	120
Ireland	206	96	100	10
Latvia	38	7	28	3
Lithuania	75	34	41	NI
Luxembourg	8	NI	8	NI
Malta	NI	NI	NI	NI
Netherlands	2 174	968	903	303
Poland	820	675	96	49
Portugal	152	112	36	4
Romania	392	254	125	13
Slovenia	30	23	6	1
Slovakia	141	88	46	7
Sweden	255	146	98	11
UK	1 506	1 299	163	44
EU-27	20 018	11 575	6 580	1 863
NB: NI = no information provided.				
Source: [607, EIONET COM 2014]				

1.2 The poultry production sector in Europe

By far the majority of poultry farms are part of the production chain for chicken eggs or for chicken broilers. A comparatively small number of farms produce turkeys (for meat) and ducks (for meat, foie gras or eggs). The value of the eggs and poultry products in the EU-27 in 2012 was EUR 30 748 million [7, DG AGRI 2013].

The following Sections 1.2.1, 1.2.2 and 1.2.3 briefly describe the poultry sectors in Europe with an emphasis on chicken production. More detailed statistical data can be found in the annual reports of the European Commission (DG Agriculture and Eurostat). Poultry production data vary by poultry species and poultry breed and also somewhat by Member State, depending on market demands. Breeds are either selected for their egg-producing capacities or growing (meat) potential.

Table 1.3 shows some typical production data for some poultry species under the scope of the Directive.

Table 1.3: Typical poultry rearing data

Types of animal production	Production cycle (days)	Live weight (kg)	Stocking density (kg/m ²)
Laying hen	350–450	1.1–2.0	12–36
Standard broiler	33–42	1.5–2.6	up to 39 ⁽¹⁾
Heavy broiler	45–63	2.2–3.3	up to 39 ⁽¹⁾
Male turkey	84–150	10–21	58–75
Female turkey	63–120	3.5–15	52–75
Pekin duck	48–56	2.8–3.75	20–55
Barbary duck (mixed)	70–85 ⁽²⁾	3.65–4.0	51–63 ⁽³⁾
Guinea fowl	76–80	1.63–1.78	24–30 ⁽⁴⁾

⁽¹⁾ Requirements are set by Directive 2007/42/EC.
⁽²⁾ Lower end of the range corresponds to female and higher to male ducks.
⁽³⁾ Values calculated from data (2009) provided by [418, ITAVI 2010].
⁽⁴⁾ Values calculated from data provided by [328, CORPEN 2006].
Source: [328, CORPEN 2006] [383, France 2010] [418, ITAVI 2010] [500, IRPP TWG 2011] [633, ITAVI 2013]

1.2.1 Egg production and consumption

Worldwide, Europe is the second largest producer of hen eggs, producing around 10 % of the world total. The supply balance of egg production in the EU-27 is presented in Table 1.4 for the years 2010 to 2013.

Table 1.4: Balance sheet for total egg production in the EU-27 for the years 2010–2013

	2010	2011	2012	2013
Gross internal production (1 000 t)	7 297	7 303	7 271	7 333
Imports (1 000 t)	33	20	35	20
Exports (1 000 t) to non-member countries	182	217	185	215
Internal consumption (1 000 t), of which:	6 885	7 105	7 121	7 138
- Eggs for hatching	880	874	1 007	812
- Eggs for human consumption	6 005	6 231	6 114	6 326
Human consumption (kg/head/year)	12.6	12.5	12.2	12.6

Source: [673, DG AGRI 2014]

The consumption per capita of eggs did not vary greatly between Member States; according to 2007 data, it ranges from an average of 8.5 kg per capita in Portugal to 18 kg per capita in Spain [1, Eurostat 2011].

Eggs for human consumption are produced in all Member States. In the year 2012, the top producer Member States were France (856 kt), Spain (862 kt), Italy (698 kt), and Germany (826 kt). In 2011, the main exporters to non-member countries of eggs for consumption were the Netherlands with 53 % of the total EU-27 exports, Germany (13.1 %), Poland (10.6 %), Spain (6.8 %) and France (5.9 %).

Table 1.5 presents the total number of laying hens in Member States for the years 2012 and 2013 and the total usable production of eggs for the year 2013.

Table 1.5: Number of laying hens and usable production of eggs (total eggs) in EU-27 Member States

	Number of laying hens (thousands) ⁽¹⁾			Total eggs (1 000 t)
	2012	2013	Change (%)	2013
Belgium	9 190	8 442	-8.1	163
Bulgaria	3 859	3 995	3.5	78
Czech Republic	5 081	5 563	9.5	73
Denmark	3 429	3 304	-3.6	78
Germany	47 334	49 903	5.4	847
Estonia	741	998	34.7	11
Ireland	2 764	2 827	2.3	46
Greece	NI	3 791	NI	100
Spain	38 350	38 409	0.2	862
France	45 945	47 041	2.4	918
Italy	61 226	60 312	-1.5	691
Cyprus	435	427	-1.8	8
Latvia	2 193	2 665	21.5	41
Lithuania	2 430	2 479	2.0	51
Luxembourg	NI	103	NI	⁽²⁾
Hungary	5 939	5 671	-4.5	165
Malta	NI	NI	NI	5
Netherlands	29 570	32 924	11.3	704
Austria	5 902	5 962	1.0	99
Poland	35 309	37 649	6.6	637
Portugal	4 857	7 235	49.0	127
Romania	6 520	6 589	1.1	301
Slovenia	1 466	1 467	0.1	21
Slovakia	3 586	2 582	-20.5	76
Finland	4 031	4 151	3.0	67
Sweden	7 009	7 053	0.6	104
United Kingdom	35 857	36 626	2.1	711
EU-27	363 024	378 437	4.2	6 982
⁽¹⁾ Data gathered on the basis of Article 31 of Regulation (EC) 589/2008. ⁽²⁾ Included in Belgium. NB: NI = no information provided. Source: [673, DG AGRI 2014]				

From 1 January 2012, keeping hens in conventional cages was prohibited and egg producers had to change to either enriched cages or alternative housing systems. The transition to full compliance with Council Directive 1999/74/EC laying down minimum standards for the protection of laying hens encountered difficulties. In Europe, in 2008, 278 million hens were still reared in conventional cage systems, of which only about 7% were in enriched cages. However, 57% of EU citizens were prepared to pay more for eggs sourced from animal welfare-friendly production [20, COM 2008].

In northern Europe, non-cage egg production has gained popularity since the end of the 1990s. In Austria, conventional cages were prohibited at the end of 2008, and enriched colonies will also be banned by 2020, whilst in Germany, conventional cages were prohibited at the end of 2009. In Sweden, conventional cages ceased to be used by the end of 2002 and only enriched colony systems are permitted since then [5, The Poultry Site 2017].

The production chain of the egg production sector is a sequence of different activities, each representing one breeding or production step (see Figure 1.2). The breeding, hatching, rearing and egg laying often take place at different sites and on different farms to prevent the possible spread of diseases. Layer farms, particularly the larger ones, often include the grading and packing of eggs, after which the eggs are delivered directly to the retail (or wholesale) market.

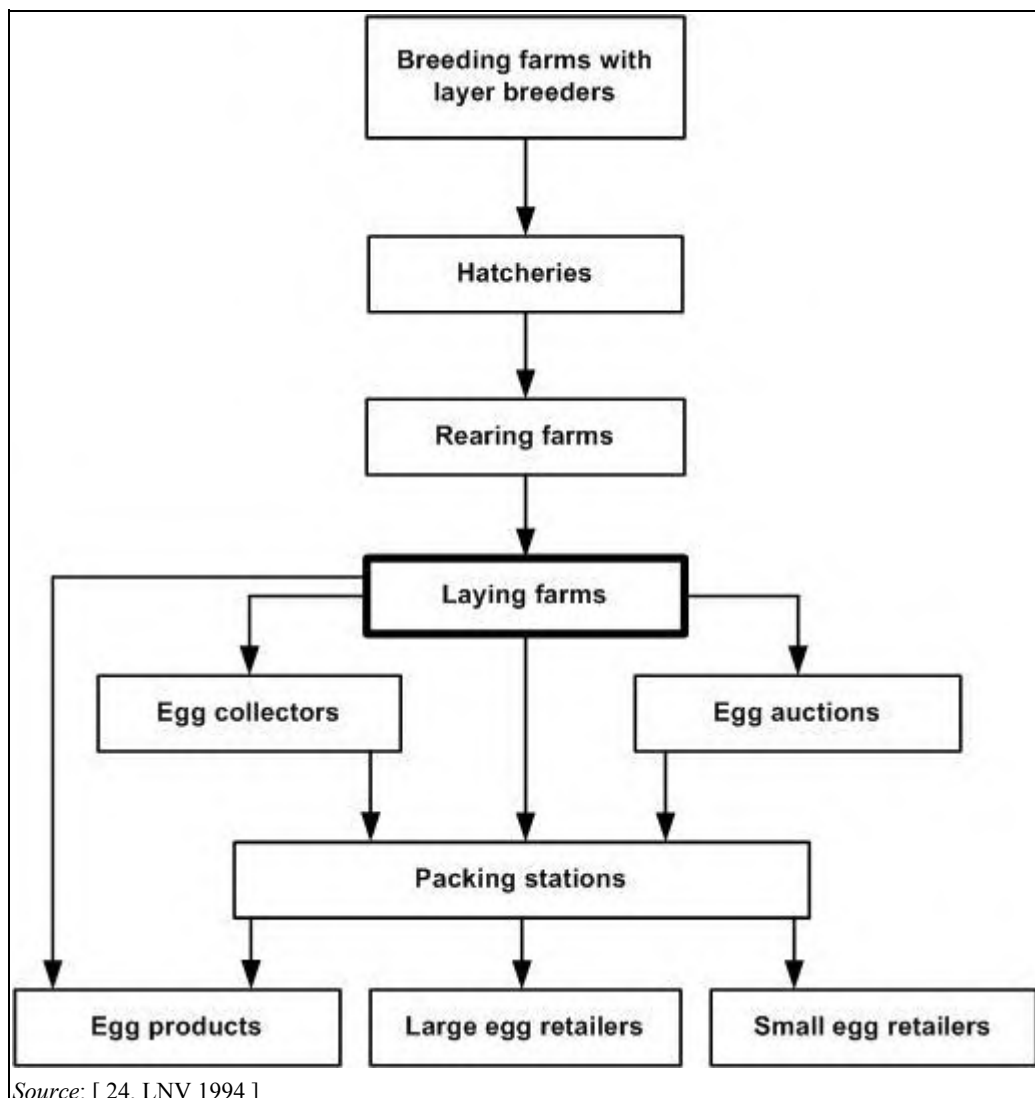

Figure 1.2: Example of the production chain of the egg production sector

The other egg-producing sectors (in particular ducks) represent only a very small portion of the rearing activity in comparison with the chicken egg production sector. Little information is available in relation to the structure, position and development of these sectors.

1.2.2 Poultry meat production and consumption

The supply balance of poultry meat in the EU-27 is presented in Table 1.6 for the years 2011 to 2013.

Table 1.6: Balance sheet for poultry meat production (in carcass weight) in the EU-27 for the years 2011–2013

	1 000 t ⁽¹⁾		
	2011	2012	2013
Gross internal production	13 205	13 474	13 718
Imports - live animals	1.0	1.2	1.1
Exports - live animals	7.7	9.3	9.4
Usable production	13 198	13 466	13 710
Imports	819	840	787
Exports with non-member states	1 288	1 323	1 311
Internal use	12 792	12 982	13 187
Gross consumption (kg/head/year)	23.9	23.7	NI
⁽¹⁾ Carcass weight. NB: NI = no information provided. Source: [673, DG AGRI 2014]			

In 2009, Cyprus recorded the highest per capita consumption of poultry meat (45 kg). Portugal and Greece recorded an annual consumption of poultry meat averaging respectively 34 kg and 30 kg per capita [1, Eurostat 2011].

According to another survey, in 2012, the total poultry meat production in the EU-27 was 12.9 million tonnes. This represents an increase of 14 % compared to 2007. The main poultry meat is broiler meat with a total production of 9.9 million tonnes in 2012. There are seven leading producers of broiler meat, each with a production of more than 0.7 million tonnes: the UK, Poland, Germany, France, Spain, Italy and the Netherlands; these countries account for 76 % of the EU's poultry meat production. Besides broilers, turkeys and ducks are also important subsectors. Total turkey meat production in the EU-27 in 2012 was 1.9 million tonnes. The main producing countries of turkey meat are France, Germany, Poland, Italy and the UK, with a common share of 81 % of the EU total. The total duck meat production in the EU-27 was 0.5 million tonnes. Of all EU countries, France is by far the largest producer of duck meat with almost half of the total EU production, followed by Hungary and Germany. These three countries have a common share of 74 % of the EU total. Other poultry relates to guinea fowl and goose. Table 1.7 gives an overview of the total poultry meat production, subdivided by broilers, turkeys, ducks and other poultry, for the EU-27 Member States [588, LEI Wageningen 2013].

Table 1.7: Poultry meat production in the EU-27 (in thousand tonnes of carcass weight) in 2012

EU Member State	Broilers	Turkeys	Ducks	Other poultry ⁽¹⁾	Total poultry	% of EU-27 total
Belgium	246	3	0	1	250	1.9
Bulgaria	78	0	21.7	5	105	0.8
Czech Republic	158	8	4.8	1	172	1.3
Denmark	175	0	0	5	180	1.4
Germany	1 150	387	63.6	75	1 676	13.0
Estonia	14	0	0	2	16	0.1
Ireland	116	9	4.2	0	129	1.0
Greece	160	3	0.2	17	180	1.4
Spain	1 063	111	6.0	71	1 251	9.7
France	1 080	415	235.8	118	1 849	14.3
Italy	817	286	14	144	1 261	9.8
Cyprus	27	1	0	1	29	0.2
Latvia	24	0	0	0	24	0.2
Lithuania	77	0	0.3	3	80	0.6
Luxembourg	⁽²⁾	⁽²⁾	⁽²⁾	⁽²⁾	⁽²⁾	⁽²⁾
Hungary	280	95	69.6	43	488	3.8
Malta	4	0	0	0	4	0.0
Netherlands	738	27	17	28	810	6.3
Austria	91	25	0.1	14	130	1.0
Poland	1 325	290	17	0	1 632	12.7
Portugal	258	39	8.5	19	324	2.5
Romania	340	10	0	0	350	2.7
Slovenia	55	7	0	0	62	0.5
Slovakia	68	14	0.4	4	86	0.7
Finland	99	8	0	0	107	0.8
Sweden	80	4	0	2	86	0.7
United Kingdom	1 400	177	33	0	1 610	12.5
EU-27	9 923	1 919	496	553	12 891	100.0

⁽¹⁾ Calculated figures: Other poultry = Total poultry – (Broilers+Turkeys+Ducks).
⁽²⁾ Included in Belgium.
Source: [588, LEI Wageningen 2013]

Table 1.8 presents the total number of chicks hatched of table strains for the years 2012 and 2013.

Table 1.8: Number of utility chicks of table strains hatched (in thousands of heads) in EU-27 Member States

EU Member State	2012	2013	Change (%)
Belgium	120 918	128 607	6.3
Bulgaria	45 852	42 450	-7.4
Czech Republic	130 429	120 547	-7.4
Denmark	NI	NI	NI
Germany	738 396	741 093	0.4
Estonia	NI	NI	NI
Ireland	73 275	71 816	-2.0
Greece	NI	NI	NI
Spain	616 240	612 174	-0.6
France	884 907	888 577	0.4
Italy	515 802	522 182	1.2
Cyprus	12 735	10 985	-13.7
Latvia	15 966	17 289	8.3
Lithuania	46 276	48 419	4.6
Hungary	143 886	144 244	0.2
Malta	NI	NI	NI
Netherlands	387 257	403 161	4.1
Austria	69 933	68 851	-1.5
Poland	729 435	809 964	11.0
Portugal	204 113	204 964	0.4
Romania	257 733	242 256	6.0
Slovenia	2 311	1 964	-15.0
Slovakia	49 023	58 191	18.7
Finland	64 203	66 193	3.1
Sweden	NI	NI	NI
United Kingdom	916 438	946 234	3.2
EU-27	6 025 130	6 150 160	2.1
NB: NI = no information provided.			
Source: [673, DG AGRI 2014]			

The production of broilers is the main subsector of the poultry meat production chain. The different steps in the broiler production chain are shown in Figure 1.3. The majority of poultry meat production is based on an all-in, all-out system applying littered floors. Broiler farms with over 40 000 bird places are quite common in Europe. The EU broiler meat sector commonly uses fast-growing genotypes which achieve the target live weight of 2–2.5 kg in around 5 to 6 weeks, after which the broilers are delivered to the slaughterhouse.

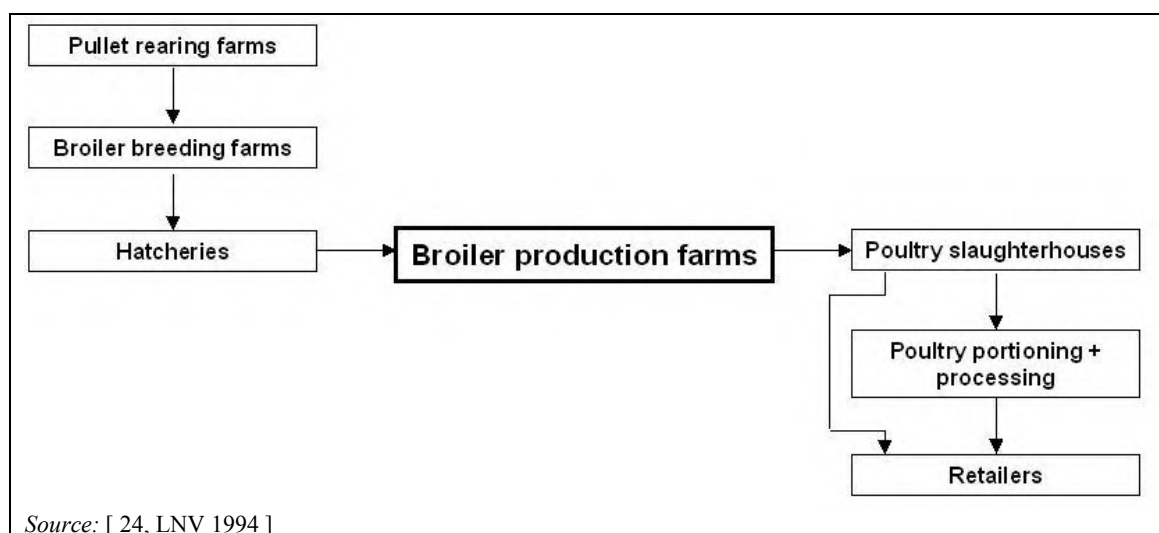

Figure 1.3: Example of the production chain of the broiler production sector

1.2.2.1 Alternative poultry meat production

Alternative broiler production that may use slower-growing genotypes is increasingly gaining attention in many EU countries. The poultry meat of such breeding programmes is a premium product, and farmers and processors receive a higher market price to compensate for the higher production costs. The conditions and names of the alternative broiler production in the EU are regulated by Regulation 543/2008, in which the marketing terms are described. The production of organic broilers is regulated in Regulation 834/2007, including the requirement to use organic feed. These requirements are summarised in Table 1.9.

Table 1.9: Marketing terms and conditions for production of alternative broilers, according to Regulations (EC) 543/2008 and 834/2007 (organic)

Production system	Minimum age (days)	Maximum indoor density (birds/m ²)	Access to outdoor run
Extensive indoor	56	15	No
Free-range	56	13	Yes, 1 m ² per bird
Traditional free-range	81	12	Yes, 2 m ² per bird
Free-range, total freedom	81	12	Yes, 2 m ² per bird
Organic	70 to 81	10	Yes, 2 m ² per bird

Source: [588, LEI Wageningen 2013]

The number of farms with free-range or organic production is small, except in France where a large number of farms are involved in alternative broiler production. In organic production, France and the UK are the largest producers within the EU. In free-range production systems, broilers have access to an outdoor area for at least half of their lifetime. An example of this type of broiler production is 'Label Rouge' in France, with the following standards: a slow-growing breed, a low indoor density and access to an outdoor area. In France, about 12 % of all broilers have access to an outdoor run.

The so-called intermediate market segment or certified broiler production has a position between regular broiler production and organic production. Certified broilers are slow-growing broilers that are kept indoors until they are at least 56 days old. Certified broilers are produced in France ('certifié'), the UK ('Freedom Food') and the Netherlands (one star within the 'Better Life Certificate'). France, the UK and the Netherlands hold a significant position in this production segment, but Germany also has some companies that have started to produce certified broilers. This type of production is expected to grow further in the coming years.

No statistics are available on the exact numbers of alternative broilers in the EU. It is estimated that the market share of alternative broilers is 5–10 % including the market for organic and free-range broilers, as defined by EU regulations and directives, as well as the numbers for 'backyard' poultry production in some southern European countries and private label production, such as 'Label Rouge' in France, 'Freedom Food' in the UK and intermediate extensive indoor production in the Netherlands [588, LEI Wageningen 2013].

Similar types of farming to those described for broilers are also defined in Regulations (EC) 543/2008 and 834/2007 for all poultry species for meat production such as turkeys, ducks, guinea fowl and geese.

1.2.3 Economics of the poultry sector

The majority of poultry farms are family-run enterprises. Some farms belong to large integrated companies carrying out all the activities of a production line, from production (hatching, rearing, slaughtering, transport) to retail and including animal feed supply. The net margin of poultry farms varies in each Member State and depends on production costs and product price. Production costs may consist of:

- costs for chicks (meat production) or pullets (cost of young hens at 16–20 weeks, less the revenue from the end-of-lay hens);
- feed costs during the growing or the laying period;
- variable costs (water and litter costs, veterinary costs, energy costs, cleaning and disinfecting costs);
- manure management costs;
- labour costs;
- housing costs (maintenance of equipment and buildings, depreciation costs, interest);
- general costs.

The gross income of a farm depends on the number of eggs or kg of live weight that can be sold and the prices the farmer receives (including the price of end-of-lay hens). The prices of poultry products are not guaranteed or fixed and fluctuate in the market. In some Member States (e.g. France, Germany, the UK, Italy), contracts are stipulated between farmers and buyers to reduce price fluctuations. This market is in turn affected by the dynamics and the structure of the large grocery retailers, who are the main outlets for the poultry products and are therefore responsible for the majority of the annual turnover of poultry products.

1.2.3.1 Economics of the egg production sector

The layer sector had to deal with additional costs related to the implementation of Council Directive 1999/74/EC as egg producers had to change conventional cages to either enriched cages or alternative housing systems from 1 January 2012. It is also evident that increasing the space allowance per bird in enriched cages or in non-cage systems will provoke additional poultry house costs and as a result the investment in housing and equipment will increase.

Production costs for different laying hen rearing systems in Europe are reported in Table 1.10, as calculated by an extensive study on the competitiveness of the EU egg industry, together with the basic assumptions made for the technical performance (egg production, mortality and daily feed intake), labour input and investment costs. For the purpose of comparison to the situation before the year 2012, conventional cages are also displayed.

According to the results of this study, the average production costs in the EU of eggs produced in enriched cage systems were calculated to be 7 % higher and the production costs of eggs produced in an aviary system 22 % higher in comparison to conventional cages providing 550 cm² per hen. This means that the market price should be higher to keep the egg producer's income at a constant level. In this context it should also be mentioned that other alternative housing systems, like free-range and organic, have higher production costs than enriched cages and aviaries. Eggs produced in these systems need an even higher bonus from the market to compensate the egg producer for the additional costs [392, LEI Wageningen 2012].

However, consumers regard free-range and organic eggs in a positive manner; this demand can sustain higher market prices [5, The Poultry Site 2017].

Table 1.10: Comparison of production costs for rearing systems for laying hens at EU level

	Conventional cage ⁽¹⁾	Enriched cage	Aviary
Production parameters and main assumptions for costs			
Laying period (days)	400	400	392
Eggs per hen	340	340	326
Mortality (%)	7	7	9
Daily feed consumption per hen (g)	111	111	123
Number of birds managed per worker	60 000	55 000	40 000
Stocking density (birds/m ²)	35	27	18
Surface area per house (m ²)	1 909	2 237	2 414
Housing investment (EUR/bird)	6.05	7.73	11.47
Inventory investment (EUR/bird)	6.5	10.60	9.00
Other inventory investment (EUR/bird)	2.7	2.95	4.5
Production costs per hen housed (EUR/bird)			
Pullet at 17 weeks	3.30	3.30	3.70
Feed costs	10.29	10.29	11.07
Other variable costs	1.29	1.51	1.39
Housing	1.91	2.75	3.08
Labour	0.99	1.10	1.51
General costs	0.37	0.41	0.51
Revenue end-of-lay hen	0.27	0.27	0.26
Total cost	17.89	19.10	20.99
Total cost per egg	0.052 6	0.056 2	0.064 4
Total cost per kg of eggs	0.85	0.91	1.04
Difference % ⁽²⁾	NR	7	22
⁽¹⁾ Conventional cages have been banned since January 2012.			
⁽²⁾ Calculated on the basis of 550 cm ² per hen in conventional cages.			
NB: NR = not relevant.			
Source: [392, LEI Wageningen 2012]			

From the same study, the costs of egg production (in conventional cages) in several EU countries are presented in Table 1.11 as calculated for the year 2010 in order to give an insight into the build-up of production costs at EU level. The differences are mainly caused by differences in feed costs, the price of young hens (pullets), housing costs and manure management (disposal) costs. All countries have revenue for spent hens, except for Denmark, where egg producers have to pay for rendering. In Spain and Poland there is revenue for manure disposal.

Table 1.11: Prices, technical performance and production costs for egg production in selected EU countries in 2010

	NL	FR	ES	IT	UK	PL	DK	EU
Prices and technical performance								
Feed price (EUR/100 kg)	22.0	23.0	23.5	24.0	24.8	23.5	21.8	23.2
Pullet cost at 20 weeks (EUR/pullet)	3.57	3.84	3.89	3.85	4.38	3.49	4.70	3.96
Laying period (days)	420	369	410	392	392	400	389	396
Number of eggs produced per hen	363	322	345	330	340	332	343	339
Egg weight (g)	61.4	62.3	64	63	62.5	63	61.6	62.5
Feed conversion ratio	2.01	2.13	2.07	2.02	2.15	2.12	1.99	2.07
Mortality (%)	8.0	5.0	7.0	8.0	6.0	7.0	5.0	6.6
Production costs (euro cents/kg of eggs)								
Hen cost at 20 weeks	16.0	19.2	17.6	18.5	20.6	16.7	22.2	18.7
Feed	44.2	49.0	48.6	48.5	53.2	49.8	43.3	48.1
Other variable costs	6.5	5.5	4.8	6.5	6.5	4.7	7.0	5.9
Labour	4.5	4.0	3.2	3.8	3.2	2.2	4.7	3.7
Housing	8.0	7.0	5.7	7.5	6.1	5.5	8.3	6.9
General	1.1	1.0	0.9	1.0	1.1	0.8	1.1	1.0
Manure management	2.6	0	-0.2	1.7	0.0	-0.3	1.5	0.7
Revenue for spent hen	-1.1	-1.1	-1.7	-1.5	-1.9	-1.3	1.2	-1.0
Total production costs	82.0	84.5	79	85.9	88.8	78.2	89.3	84
<i>Source: [392, LEI Wageningen 2012]</i>								

Another example of a breakdown of production costs for different rearing systems for egg production is shown in Table 1.12, where French national averages for the year 2011 are shown. Production costs were derived according to the technical performance of the farms and taking into account investment and financial costs as well as costs for feed, pullets, labour and all other variable cost factors.

Table 1.12: Average performance data and production costs for egg production in France for the year 2011

	Enriched cages	Free-range (°)	Organic	Barn
Technical performance				
Stocking density (birds/m ² of usable area)	(¹)	8.29	6.41	9.00
Laying period (days)	380.3	347.4	353.2	363.1
Empty period (days)	22.04	27.1	27.3	NI
Mortality (%)	5.89	7.45	6.96	8.12
Number of eggs produced per hen	314.9	284.7	291.6	299.2
Weight of eggs produced per hen (kg)	20.17	16.98	17.46	18.58
Feed conversion ratio (kg of feed/100 kg of eggs)	2.18	2.57	2.49	2.35
Production costs (EUR/hen)				
Feed cost	11.27	12.29	22.89	11.97
Labour costs	0.73	3.05	3.81	1.83
Pullet cost	3.18	3.27	4.82	3.13
Investment cost, financial cost and other fixed costs	3.35	3.71	4.82	3.7
Variable costs (water, electricity, cleaning and disinfection etc.)	0.71	0.83	0.9	0.84
Total production cost	19.24	23.15	37.24	21.47
Total production cost (EUR/100 eggs)	6.11	8.13	12.79	7.17
(¹) 750 cm ² /bird. (²) French specification 'Label Rouge'. NB: NI = no information provided. <i>Source: [417, ITAVI 2012]</i>				

The evolution of the weekly EU average price for Class A egg is shown in Figure 1.4 while Figure 1.5 presents the yearly average market price for eggs in Member States.

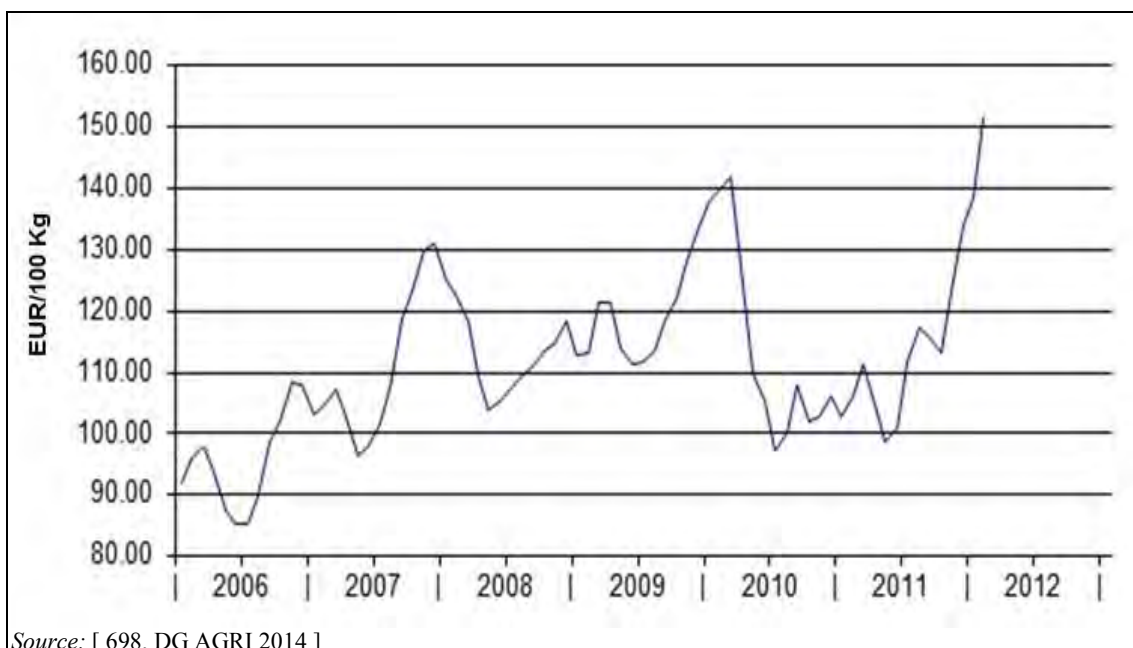

Figure 1.4: Evolution of the weekly EU average price for Class A eggs in packing stations for the period 2009 to 2014

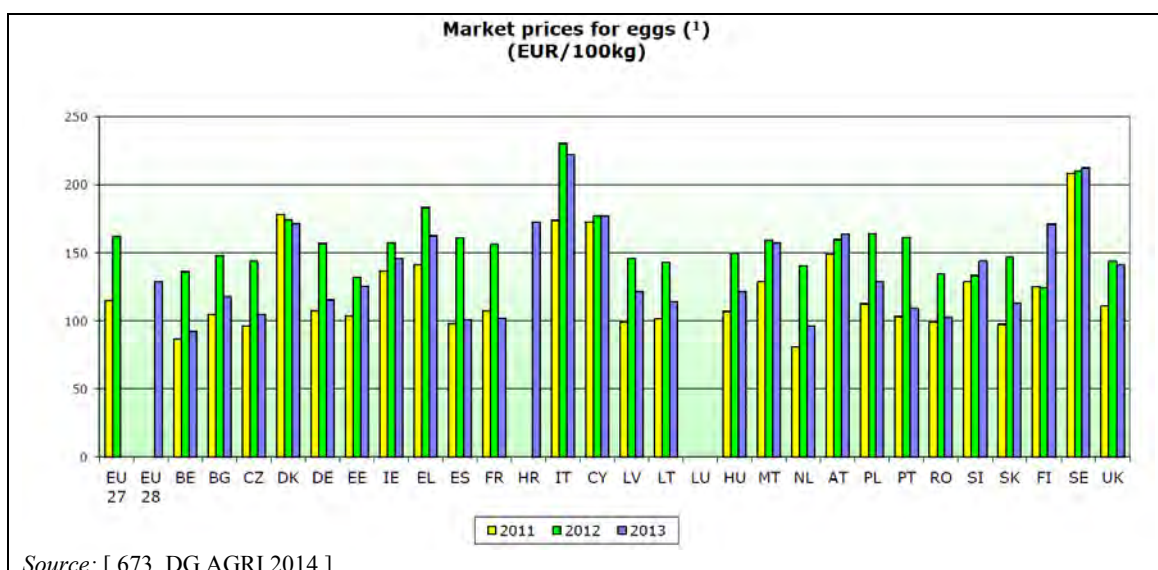

Figure 1.5: Market prices for eggs from caged hens (average for categories L and M) for the period 2011 to 2013

1.2.3.2 Economics of the poultry meat production sector

An example of production costs for the poultry meat sector is shown in Table 1.13, where French national averages for the year 2009 are displayed. The calculations include investment costs, feed costs, fixed costs (chicks, financial expenses, water, etc.), and variable costs (heating, electricity, etc.) for fully equipped housing.

Table 1.13: Average performance data and production costs for meat poultry species in France for the year 2009

Parameter	Broiler			Turkey		Duck		Guinea fowl
	Standard	Heavy		Male	Female	Male	Female	
		'Certified'	'Label'					
Stocking density (birds/m ²)	22.8	17.9	11.0	7.9		14.9		17.1
Production cycles per year	6.51	4.88	3.27	2.53		3.44		3.74
Age at slaughter (days)	37.7	58.5	87.6	120.7	88.0	84.4	70.2	77.2
Live weight at slaughter (kg)	1.9	2.22	2.3	12.9	6.5	4.6	2.5	1.7
Feed conversion ratio	1.8	2.16	3.2	2.4	2.4	2.8	2.8	2.8
Mortality (%)	4.18	2.64	3.60	6.87		4.1		5.5
Production cost (EUR/kg live weight)	0.831	0.938	1.607	1.137		1.271–1.299		1.593

Source: [418, ITAVI 2010]

The production costs for broilers at farm level have been calculated for nine Member States based on the situation in 2011. Table 1.14 gives the average price of feed and day-old chicks as well as the average feed conversion as a good indicator of the production efficiency. The price of feed strongly affects the total production costs and it is influenced by the world market prices of the main feed ingredients, such as grains (wheat and maize) and soybean meal. The difference in feed price between the EU countries is a result of differences in the structure of the supply chain (integrated versus non-integrated), average farm size, feed mill policy, average transport distance to farms and optimal position with access to sea harbours and waterways for efficient supply of feed ingredients. Growing broilers to a higher final weight also results in a higher feed intake per kg of growth.

Table 1.14: Prices, technical performance and production costs for broiler production in selected EU countries in 2011

	NL	DE	FR	UK	IT	ES	DK	PL	HU
Prices and technical performance									
Live weight (kg)	2.2	2.2	1.92	2.3	2.46	2.7	2.1	2.3	2.3
Feed conversion	1.67	1.68	1.75	1.75	1.85	1.95	1.65	1.76	1.8
Feed price (EUR/100 kg)	33.8	34.5	32.8	35.4	40.1	34.6	32.8	34.5	32
Day-old chick (EUR)	0.306	0.311	0.31	0.367	0.355	0.316	0.317	0.311	0.308
Production costs (EUR cents/kg of live weight)									
Day-old chicks	14.4	14.7	16.9	16.6	15.1	12.2	15.7	14.1	13.9
Feed	56.4	57.9	57.4	61.9	74.1	67.4	54.1	60.7	57.6
Other variable costs	8.6	8.6	8.2	7.4	7.5	5.8	9.3	7.2	8.9
Labour	4.4	4.5	4.9	3.1	2.6	2.9	4.6	1.4	2.3
Housing	5.4	5.8	6.5	7.0	6.2	5.9	6.5	5.9	8.0
General	1.1	1.1	1.1	1.1	1.0	0.9	1.1	0.8	0.8
Manure management	0.9	0.4	0.0	-0.1	NI	NI	0.0	-0.1	0.3
Total production costs	91.2	92.9	94.9	96.9	106.5	95.2	91.4	90.2	91.8

NB: NI = no information provided.
Source: [588, LEI Wageningen 2013]

Data in the above table show that EU countries also differ in some other cost components. Other variable costs relate to heating, electricity, litter, animal health and catching. These variable costs vary slightly between countries, mainly because of differences in heating costs (fuel prices) and costs of catching. Labour costs also differ between countries. Normally, the work on the farm is done by the farmer. The differences in housing costs (poultry house and inventory) between the countries relate to differences in investments for a poultry house, stocking density and interest rate. General costs relate to the costs at farm level for insurance, bookkeeping, consultancy, communication and transport. In some countries broiler farmers have manure management costs. In the Netherlands, Germany and Hungary farmers have to pay for a sustainable management (disposal) of manure. In other countries, farmers do not have to pay for manure disposal, while in the UK and Poland farmers even get a small revenue.

Poultry meat prices are also subject to fluctuations. The evolution of the monthly average price for broiler meat in the EU is shown in Figure 1.6. Figure 1.7 shows the yearly average market price for broiler meat in Member States.



Figure 1.6: Evolution of monthly EU average selling price in slaughter plants for broilers (wholesale price for class A chicken) for the period 2006 to 2012

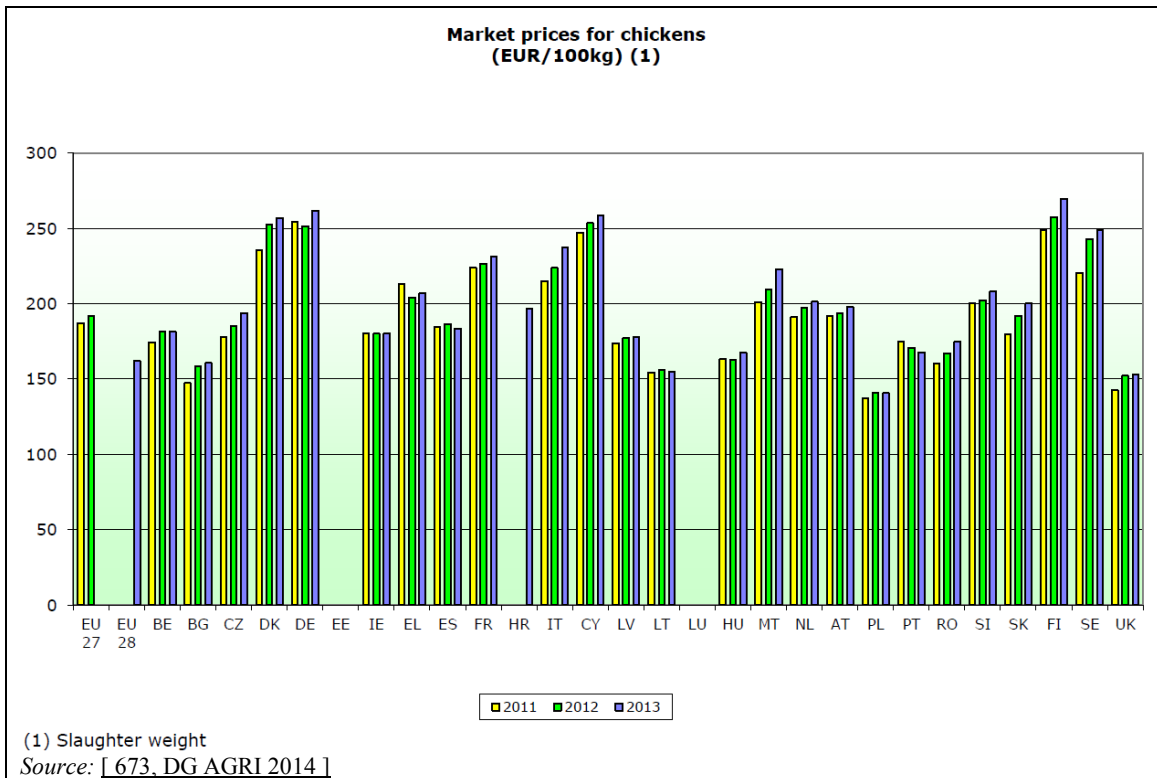

Figure 1.7: Market prices for broilers for the period 2011 to 2013

1.3 The pig production sector in Europe

1.3.1 Structure, trends and geographical distribution of the pig production sector in Europe

Pig meat is produced throughout the EU on several types of farms with considerable variations from one Member State to another. In 2012, the value of the pig sector agricultural products in the EU-27 was EUR 37 785 million [7, DG AGRI 2013].

According to the 'Farm structure survey' carried out by all Member States on the basis of Regulation (EC) 1166/2008, in 2015 the total pig population in the EU-28 was 148.7 million, consisting of 41.7 million piglets with a live weight of less than 20 kg, 12.3 million breeding sows reflecting the permanent pig herd and 60.2 million fattening pigs with 50 kg or over [699, Eurostat 2017]. A detailed breakdown for the EU-28 is presented in Table 1.15.

Table 1.15: Pig population in the EU-28 in 2015 (in thousands)

Total population	148 724.2
Piglets, < 20 kg	41 704.9
Breeding sows	12 301.8
Covered sows	8 411.1
Sows not covered	3 888.7
Breeding pigs (breeding sows + boars)	12 502.8
20 kg < pigs < 50 kg	34 271.1
Fattening pigs, ≥ 50 kg	60 245.2
50 kg < fattening pigs < 80 kg	27 599.7
80 kg ≤ fattening pigs < 110 kg	24 111.9
Fattening pigs ≥ 110 kg	8 534.6
Breeding boars	201.1
Sows covered for the first time	1 500
Gilts not yet covered	1 490.8
NB: 'Gilts not yet covered' and 'Sows covered for the first time' are also included in 'Fattening pigs'.	
Source: [699, Eurostat 2017].	

The trend of the pig livestock population over the period 2007–2015 confirms a decrease in the total number of pigs (-7.6 %). The number of breeding sows has declined (-98.3 %) and the same behaviour is observed for fattening pigs over 50 kg (-6.1 %). The number of piglets decreased by around 3.8 % from 2007 to 2015 [699, Eurostat 2017].

The total number of sows represents the production capacity. Between 2008 and 2013, the number of sows fell by 13.5 %. In the 13 newest Member States the reduction was steeper (-20 %) than in the EU-15 (-8 %). The decrease affects pig farms of all sizes, including larger farms (>200 sows). Such extreme changes are a combination of several factors, which have a varying impact depending on the structure of pig production. The general decrease concerns all countries, but one underlying reason is the concentration, i.e. an increase in the size of the largest farms to the detriment of the smallest farms (e.g. in Belgium, Germany, Estonia, France, Latvia, Lithuania, the Netherlands, Austria, Portugal and Finland). However, the decrease in the total number of sows is balanced by a gain in productivity [3, Eurostat 2014]. Other reasons for the contraction in the EU pig herd are the high feed costs throughout 2012 and the first half of 2013 together with the new welfare rules in the sow sector [7, DG AGRI 2013].

Germany, Spain, France, Denmark, Poland and the Netherlands are the major producers at EU level, with more than two thirds of the breeding pigs [699, Eurostat 2017]. At regional level, data are more informative than national figures as a means of displaying the zones of pig production (see Figure 1.8). The most important zone extends from Denmark through northern Germany and into the Netherlands and Belgium. Pig farming is particularly concentrated in the Danish regions of Capital (region), Central Jutland and North Jutland. A particularly high concentration of pigs per km² could also be observed in the Dutch region of North Brabant and the Belgian region of West Flanders as well as in the German regions of western Lower Saxony (districts of Cloppenburg and Vechta) and the northern parts of North Rhine-Westphalia. The location of pig farming is, to some degree, reliant upon easy access to animal feed and, in particular, cereals. Some areas with a high concentration of pig farming are close to sea ports, which may be used to import feed. Otherwise, the distribution of pig farms across the EU can be linked to consumer preferences for different types of meat and to the complementary nature of different types of pig farming (breeders, fatteners, etc.). There were also other regional pockets where the density of pigs is relatively high: these included Catalonia, Aragon and Murcia in Spain, Brittany in north-west France, Lombardy in northern Italy, and Wielkopolskie in central Poland [4, Eurostat 2014] [15, Eurostat 2014].

Pig farms vary considerably in size. The latest data collected by the 'Farm structure survey' on the distribution of the pig population by size of the herds (in numbers of 'other pigs') show that about three quarters of other pigs (77.9 %) and about half of the sows (48.6 %) are reared by just 1.7 % of the largest farms (those with more than 400 'other pigs'). At the EU level, small units (less than 10 other pigs) rear 3.8 % of 'other pigs' and they account for 73.3 % of the pig farms [4, Eurostat 2014].

Small pig producers are mostly found in the 13 Member States that joined the EU since 2004, which leads to a decreasing herd size. According to the 'Farm structure survey' of 2010, the 13 newest Member States accounted for 2.9 % of the breeding sows overall, but only 62.9 % of these sows are in farms with at least 10 sows and 41 % are in herds of 100 to 199 sows. Animals kept in small units of less than 10 other pigs are important in Romania (62.8 %), Croatia (45.3 %), Slovenia (31.4 %), Lithuania (28.8 %) and Bulgaria (25.8 %) [4, Eurostat 2014].

In addition, almost half of the 'other pigs' (41.6 %) are reared by fatteners, i.e. farms without sows. The large fatteners (at least 400 'other pigs') account for more than one third of other pigs in ten countries (Belgium, Denmark, Germany, Spain, Italy, Luxembourg, the Netherlands, Finland, Sweden and the United Kingdom). They reflect a production organised between specialised breeding farms and fatteners. These 10 countries represent two thirds of the 'other pigs' production and three quarters of the EU pork production. In France the distribution is balanced between typical fatteners and large breeders. The large breeders (at least 400 pigs and 100 sows) manage more than two thirds of the 'other pigs' in six countries (the Czech Republic, Estonia, Ireland, Greece, Cyprus and Portugal). This class represents also half of the EU-28 sow herd [4, Eurostat 2014].

In the UK, approximately 40 % of the total 438 000 breeding sows are reared outdoors in rotational systems. This type of rearing scheme is not included in the statistics of the permitted farms given in Table 1.2.

The figures on the changing structure of the average unit size related to 2010 are presented in Table 1.16. More detailed data about the pig population and the exact distribution of national herds by size can be taken from the 'Farm structure survey'.

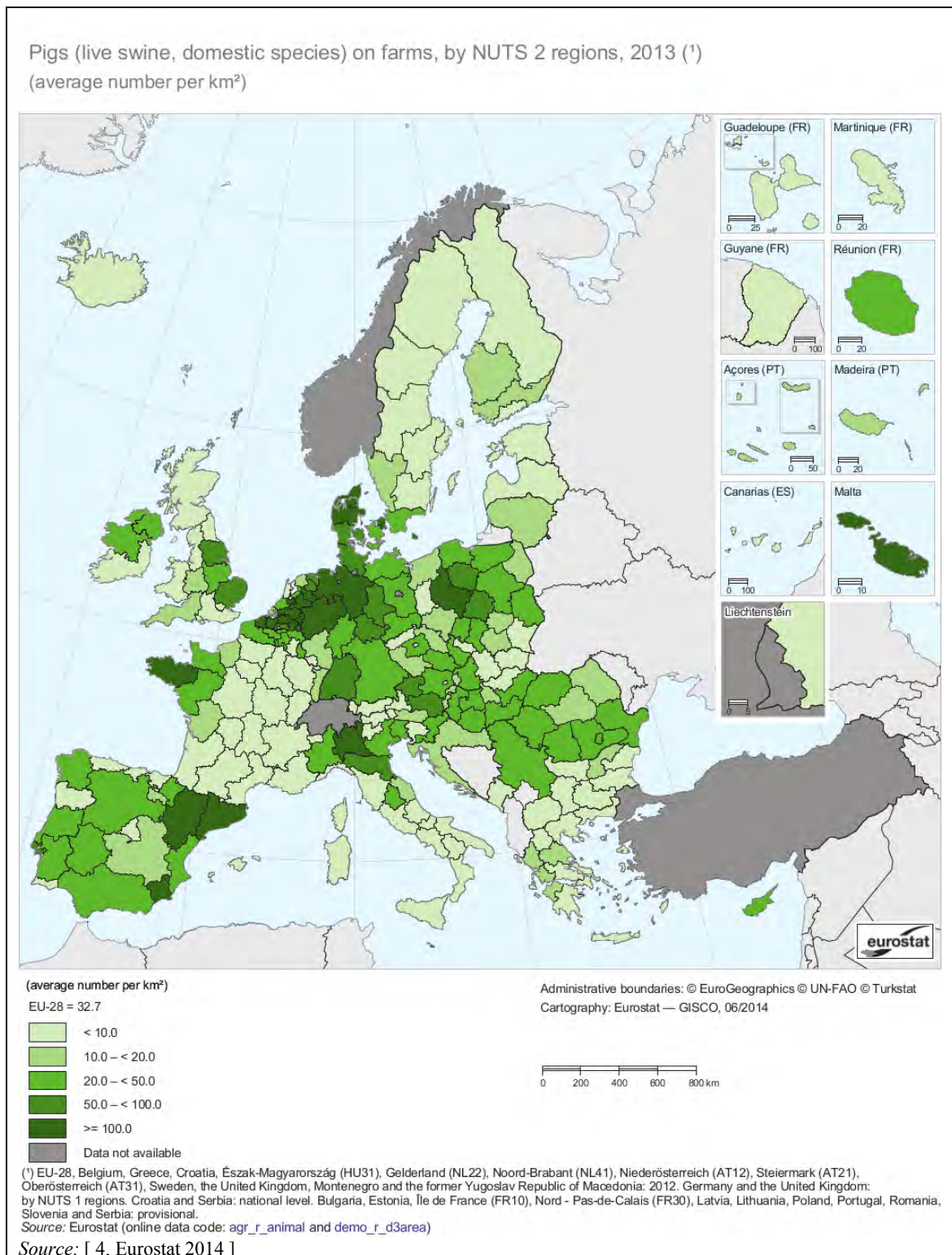

Figure 1.8: Pig density by region (in average number per km²) in 2013

Table 1.16: Pig population and changing structure of pig farms by herd size class in the EU-28, 2005-2010

EU Member State	Holdings (x 1 000)			Animals (x 1 000)			Average number of animals per holdings		
	2005	2007	2010	2005	2007	2010	2005	2007	2010
Belgium	8	7	6	6 318	6 256	6 430	818	895	1 092
Bulgaria	191	154	82	932	848	670	5	6	8
Czech Republic	15	11	4	3 019	2 876	1 908	207	252	477
Denmark	9	7	5	13 534	13 723	13 173	1 500	1 903	2 598
Germany	89	79	60	26 858	27 059	27 571	303	341	459
Estonia	5	3	2	355	370	389	75	128	251
Ireland	1	1	1	1 660	1 606	1 516	1 977	2 007	1 253
Greece	45	33	19	1 017	1 112	947	23	33	49
Spain	116	108	70	22 777	23 424	24 712	197	217	354
Croatia	NI	106	128	NI	1 575	1 501	NI	15	12
France	42	35	24	14 793	14 283	13 922	353	405	569
Italy	103	101	26	8 758	9 040	9 331	85	90	356
Cyprus	1	1	1	424	458	330	706	619	524
Latvia	39	30	18	430	419	383	11	14	21
Lithuania	152	95	63	1 200	956	860	8	10	14
Luxembourg	0	0	0	90	83	84	429	463	598
Hungary	316	283	183	3 860	3 823	3 208	12	14	18
Malta	0	0	0	73	79	71	523	564	543
Netherlands	10	9	7	11 312	11 663	12 255	1 167	1 342	1 743
Austria	52	45	38	3 147	3 235	3 247	60	71	86
Poland	702	664	388	17 717	18 512	15 244	25	28	39
Portugal	83	67	50	1 834	1 799	1 913	22	27	38
Romania	1 753	1 698	1 656	4 936	4 709	5 345	3	3	3
Slovenia	34	32	26	505	544	382	15	17	14
Slovakia	42	40	11	1 005	837	588	24	21	55
Finland	3	3	2	1 401	1 448	1 367	455	513	657
Sweden	3	2	2	1 811	1 676	1 520	649	732	894
United Kingdom	11	10	10	4 860	4 833	4 443	424	495	445
EU-28	3 822	3 624	2 883	154 626	157 245	153 311	40.5	43.4	53.2
NB: NI = no information provided.									
Source: [7. DG AGRI 2013]									

1.3.2 Production and consumption of pork

The EU-27 accounts for 22.8 % of the world pork production, with 22.7 million tonnes of carcass weight of the nearly one hundred million tonnes produced in the whole world (99 532 328 t) [17, FAO 2009]. For comparison, pork production totals more than twice the carcass weight of beef and veal.

Figure 1.9 shows the decrease registered for the slaughter of cattle, sheep and goats since 2005, whilst at the same time the increase in the total weight of pigs and poultry slaughtered, leading to an overall expansion in meat production within the EU-28.

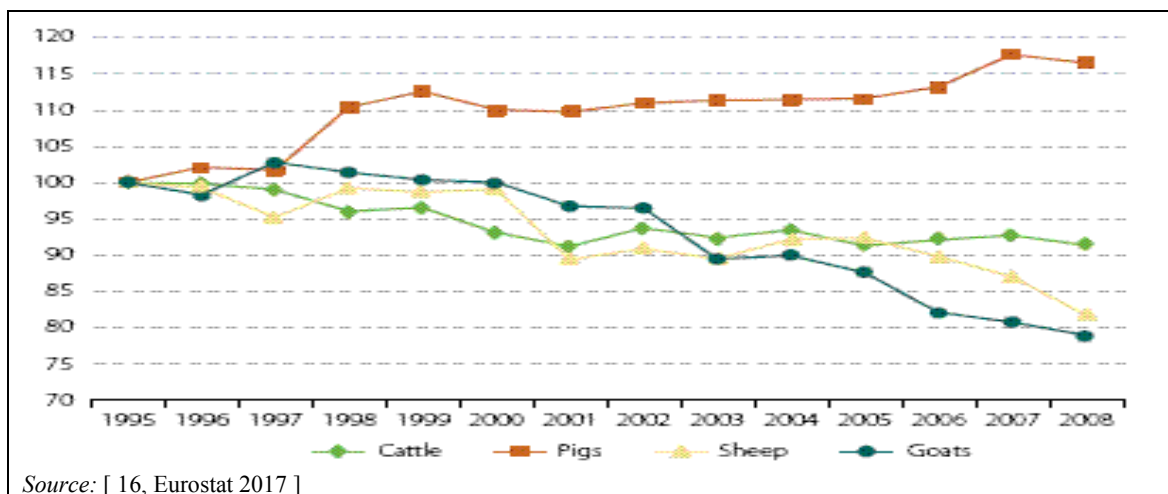

Figure 1.9: Production of meat by type of animal (in tonnes) in the EU-28

The average weight to which pigs are finished and their average carcass weight vary throughout the EU. This has a significant impact in relation to the period of time that the pigs are housed, the quantity of feed consumed, and the volume of effluent produced. For example in Italy, heavy pigs are reared to an average live weight of 156 kg, yielding a carcass weight of 112 kg. The types of pig production carried out in the EU are listed below:

- 'Continental' pig, produced in Germany, the Netherlands, Austria, Belgium and France, with a carcass weight of around 90 kg.
- British pig, with a 90–105 kg live weight and a 79 kg average carcass weight. Also produced in Spain.
- Danish pig, intermediate between continental and British types.
- Italian heavy pig. Standard pigs are also produced in Italy [383, France 2010].
- Iberian pig, with a 150 kg live weight and a 120 kg carcass weight [624, IRPP TWG 2013].

Not all of this production is consumed in the Member States themselves. As a whole, the EU is a net exporter of pork, importing only a very small amount (see Table 1.17). Not every major producer is an exporter. Denmark, the Netherlands, Belgium and Spain are large exporters, Italy and UK are net importers while Germany and France are net exporters to a lesser extent [383, France 2010]. The supply balance for pig meat in the EU-27 is presented in Table 1.17 for the years 2010 to 2013.

Table 1.17: Balance sheet for pig meat production (in carcass weight) in the EU-27 for the years 2010–2013

	2010	2011	2012	2013
Gross internal production (1 000 t)	22 209	22 503	22 026	22 012
Imports - live animals (1 000 t)	0.12	0.02	0.02	0.02
Exports - live animals (1 000 t)	75.5	66.2	36.6	23.5
Usable production (1 000 t)	22 133	22 437	21 990	21 989
Imports (1 000 t)	22	15	16	15
Exports (1 000 t) with non-member states	1 839	2 175	2 182	2 177
Internal consumption (1 000 t)	20 316	20 278	19 824	19 827
Per capita consumption (kg/head/year)	40.8	40.7	39.7	NI
NB: NI = no information provided.				
<i>Source:</i> [673, DG AGRI 2014]				

The annual consumption for pork products averages around 40 kg per capita, a level that is higher than the combined total of poultry, cattle, sheep and goats. In 2009 Denmark had the highest overall consumption of meat in the EU, 81 kg per capita. Austria and Germany average in excess of 50 kg, while the United Kingdom, Bulgaria and Greece recorded per capita is below 30 kg [1, Eurostat 2011].

With varying live weights at the end of the finishing period, the period of time needed for rearing a pig also varies in the EU. Many factors influence this, such as the feeding, farm management and market demands requiring a certain quality of pork meat.

Table 1.18 presents the physical performance data concerning the production of pigs for a selected sample of EU countries.

Table 1.18: Summary of physical performance data for the production of pigs for selected EU countries (year 2009)

Performance	DK	FR	DE	UK	IT	NL	ES	SE	EU Average
Pigs weaned per sow per year	27.45	26.16	23.9	22.25	22.64	27.19	23.71	23.19	24.32
Pigs sold per sow per year	25.63	24.7	22.47	21	21.69	26.03	21.81	22.11	23.01
Litters per sow per year	2.25	2.33	2.3	2.23	2.22	2.38	2.32	2.2	2.28
Sow replacement rate (%)	53.8	45.4	43.2	48.1	34.0	42.0	52.7	51.3	45.5
Lactation period (days)	31	25	27	28	27	25	23	34	27
Post-weaning daily live weight gain (g/day)	460	475	440	492	450	362	285	437	423
Post-weaning feed conversion ratio	1.70	1.69	1.70	1.80	2.02	1.54	1.70	1.97	1.78
Average number of days in post-weaning unit	52	51	51	60	61	51	45	48	53
Transfer weight to finishing unit (kg)	31.4	31.57	29.9	36.6	35	25.1	19	31	30.03
Finishing daily live weight gain (g/day)	898	785	753	819	640	792	643	876	767
Finishing feed conversion ratio	2.66	2.85	2.92	2.77	3.68	2.71	2.71	2.83	2.89
Average number of days in finishing unit	84	107	119	81	205	116	134	98	116
Finishing pigs' feed consumption (kg) per pig	203	243	265	187	483	250	236	242	256
Finishing ration average energy content (MJ ME/kg)	13.32	12.8	13.2	12.96	12.7	13.8	NI	12.32	11.83
Finishing mortality (%)	4.10	3.60	3.10	3.20	0.70	2.40	4.80	2.40	3
Pigs per pig place per year (finishing)	4.06	3.19	2.89	4.13	1.72	2.93	2.59	3.49	3.14
Average live weight at slaughter (kg)	107	116	120	103	166	117	105	117	117
Average carcass weight - cold (kg)	81	89	93	78	128	90	79	87	90
Carcass meat production per sow per year (kg)	2 064	2 189	2 084	1 643	2 781	2 349	1 729	1 924	2 062
Average lean meat percentage (%)	60.2	60.1	56.5	62.0	47.0	56.4	58.0	57.7	58
NB: NI = no information provided. Finishing = the rearing phase after post-weaning until slaughter.									
<i>Source:</i> [415, BPEX 2010]									

Depending on the final slaughter weight, the castration of male piglets is a practice still in use to avoid boar taint. While alternatives to castration are being investigated, the debate on the practice in relation to the production systems and efficiency, and the use of anaesthetic is ongoing. As an example, in the UK, over 90 % of British pigs are produced on farms which are members of a recognised quality assurance scheme that does not allow the castration of male pigs.

1.3.3 Economics of the pig sector

The economy of European pig production is driven by the choices of the Common Organisation of Agricultural Markets, for which the key factor is competitiveness, even if there are small niche markets. Prices mostly reflect the situation of supply and demand, while the EU Common Agricultural Policy only indirectly affects the pig sector by shifting crop production. Market crises are recurrent and there is little public financial support for European pig production. For

more efficiency, the trend is towards concentration in larger farms and in specialised regions (economy of scale and agglomeration). The efficiency of the whole chain, and not only of the farm, is important [383, France 2010]. The economics of pig production are also largely dictated by the availability of feed, or easy access to transport, and suitable markets. This has led to regional development of the industry.

Environmental constraints and financial drivers for better nutrient recovery within pig farming have led to a link between production and the availability of land for spreading manure. Manure (solid or slurry) has a nutrient value for crops and when used in accordance with crop requirements is a valuable fertiliser. When landspread it adds both major and minor plant nutrients (predominantly nitrogen and phosphorus) to the soil which can leach into ground and surface waters. This can be a problem where there are concerns over eutrophication of water bodies and/or nitrate levels in drinking water sources. Where sufficient land for spreading is available, manure can be applied beneficially without a potential risk of water pollution by nitrates. Where manure transportation is possible, wider spreading areas are reached, albeit at higher costs. In this respect, differences exist across countries.

In Denmark, the pig population is spread across the entire country, and therefore it has only a relatively average pig density associated with the cultivated land area. The mixed livestock and arable farming systems that are used in Denmark and Germany also allow the use of generated manure with a reduced environmental risk. The association with mixed farming also provides benefits in terms of feed costs. In contrast, in some Member States (e.g. the Netherlands) a small land area is associated with livestock farms, and the quantities of manure produced are so large that farmers pay to have it removed. In others, the manure has sufficient value that farmers can sell it or at least give it to other farmers [204, IMPEL 2009].

Pig density in Spain as a whole is very low, but there is a concentration of intensive pig farming and other agricultural activity in the northern autonomous communities (e.g. in Catalonia). It has been stated that the manure landspreading is of great agronomic interest to Spain as, along with the savings on mineral fertilisers, it can also improve the structure and fertility of most Spanish soils and can contribute significantly to the fight against desertification. These favourable circumstances support the growth of the sector and even the setting up of foreign companies.

Generally, pig production in the EU does not tend to show the level of vertical integration found in the poultry sector, for instance the breeding and finishing of pigs are often carried out in separate facilities. In the latest years, there has been a tendency towards a more integrated approach with an individual or company-based control of feed supply, pig production and slaughtering capacities. There is also a trend that even in situations where breeding and finishing are undertaken at separate sites these may be owned by a single producer. The most developed integrated production systems are in Denmark and fall under the guidance of the Federation of Danish Pig Producers and Slaughterhouses (Danske Slagterier). Examples of vertical integration can be found also in Spain and Belgium [383, France 2010].

Where investments are made, there are a variety of reasons why farmers might decide to invest in environmental techniques. Often, national legislation pushes them towards the application of certain techniques, but also the requirements of the large grocery retailers can affect the choice and operation of production techniques, as happens in egg production. Increasing attention is being paid to animal welfare issues, such as the use of straw and access to an outdoor area. It should be borne in mind that techniques applied under the scope of animal welfare legislation are not always associated with the best environmental performance.

In the UK as an example, some producers in the pig production sector moved to straw bedding systems to meet the desires of pork customers, particularly on welfare grounds. This change applies especially to loose-housed dry sows (as in the Netherlands) and eventually provoked discussions about the environmental disadvantages that may occasionally result from some practices (e.g. use of straw). In the UK, many of the pigs that are fattened on straw are sourced

from outdoor sow herds, giving an example of a niche market with an integrated supply chain from producer to retailer.

Some Member States set up public programmes for limited periods to encourage farmers to take action or to adopt techniques in order to reduce emissions to the environment. Hence, some farmers are able to access financial assistance to invest in improved manure management techniques (e.g. in Finland, financial support was available for liquid manure injection) [26, Finland 2001] [37, BOE España 2009] [383, France 2010].

The economic viability of techniques or combinations of techniques is related to the economic profitability of the sector or farm, where profitability depends on production costs and sales income. Table 1.19 shows the financial performance data for the year 2014, together with the variability of production costs across the EU. The evolution of the total production costs of pig meat across the EU during the period 2009–2014 is displayed in Table 1.20. The evolution of market prices for pig meat in the EU is presented in Figure 1.10 while Figure 1.11 shows the yearly average market price for pig meat in Member States from 2010 to 2013.

Table 1.19: Summary of financial performance in the year 2014 in selected countries (in EUR per kg deadweight ⁽¹⁾)

Production cost breakdown	BE	CZ	DK	FR	DE	UK	IE	IT	NL	ES	SE	EU
Feed	1.04	0.95	0.91	0.95	0.94	1.05	1.17	1.32	0.95	1.04	1.00	1.02
Other variable costs	0.20	0.47	0.26	0.23	0.30	0.27	0.26	0.25	0.32	0.20	0.27	0.27
Total variable costs	1.23	1.41	1.17	1.19	1.23	1.32	1.43	1.57	1.27	1.23	1.26	1.30
Labour	0.12	0.11	0.14	0.15	0.15	0.17	0.12	0.17	0.16	0.09	0.19	0.15
Depreciation and finance	0.19	0.14	0.21	0.21	0.22	0.22	0.19	0.20	0.20	0.14	0.38	0.21
Total fixed costs	0.31	0.25	0.35	0.36	0.37	0.38	0.31	0.38	0.35	0.23	0.57	0.36
Total production costs	1.54	1.65	1.52	1.54	1.60	1.72	1.74	1.94	1.62	1.47	1.83	1.65
⁽¹⁾ Values in EUR as per exchange GBP/EUR = 0.81. NB: Figures may not add up due to rounding. Source: [382, BPEX 2016]												

Table 1.20: Changes in total production costs in the EU for the years 2009–2014 (in EUR per kg deadweight)

EU Member State	2009	2010	2011	2012	2013	2014
AT	1.45	1.61	1.68	1.78	1.79	1.65
BE	1.41	1.48	1.61	1.73	1.74	1.56
CZ	1.73	1.85	1.78	1.86	1.84	1.65
DK	1.42	1.41	1.59	1.68	1.68	1.53
FR	1.41	1.42	1.65	1.66	1.71	1.56
DE	1.54	1.52	1.76	1.82	1.82	1.63
UK	1.50	1.68	1.78	1.91	1.89	1.74
IE	1.48	1.52	1.72	1.84	1.93	1.77
IT	1.74	1.79	1.96	1.98	2.01	1.96
NL	1.45	1.42	1.62	1.68	1.77	1.64
ES	1.44	1.42	1.60	1.64	1.64	1.49
SE	1.48	1.72	1.97	2.14	2.08	1.86
EU	1.50	1.57	1.73	1.74	1.74	1.58

NB: Figures may not add up due to rounding.
 Source: [382, BPEX 2016]

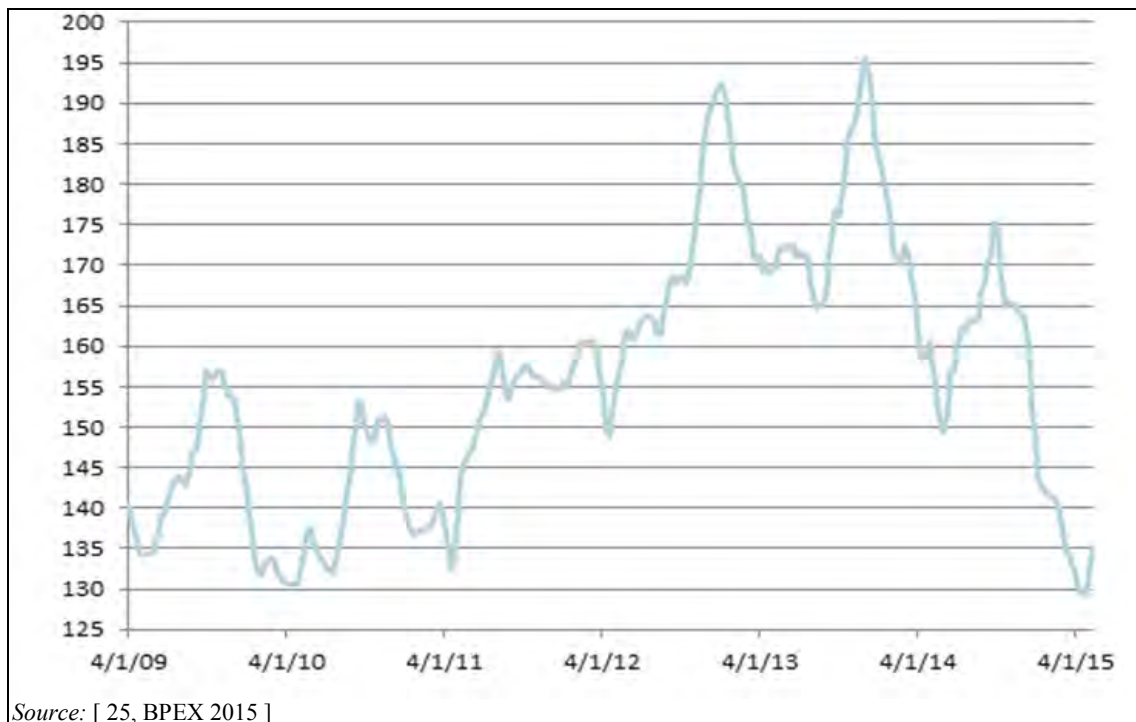

Figure 1.10: Evolution of pig meat market prices on weekly basis (EUR/100 kg deadweight) in the EU-28, January 2009 - February 2015

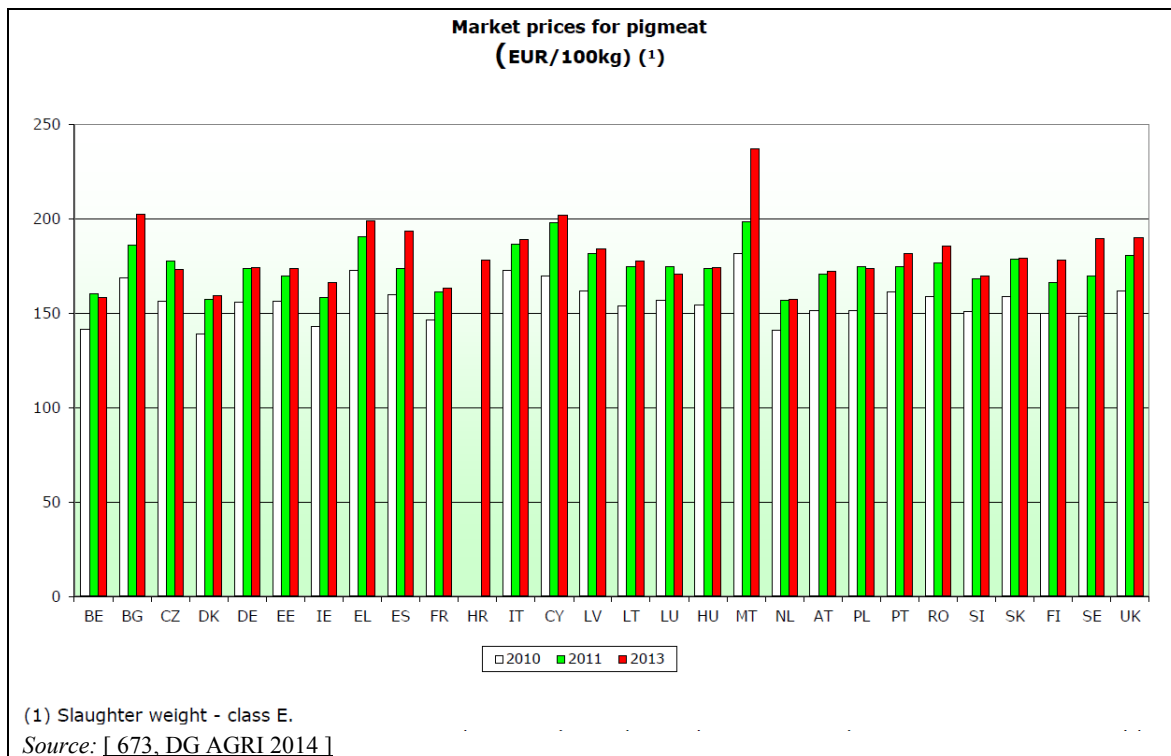

Figure 1.11: Market prices for pig meat

The European Commission and Member States are progressively introducing rules to oblige industry and farmers to commit to minimising greenhouse gas (GHG) emissions as part of the actions implementing the Kyoto Protocol. Provisions that could be introduced may become a significant driver in the future and may affect the costs of production. In the UK, the strategy on low carbon emissions (Low Carbon Transition Plan) moved the English pig industry to organise an action plan on greenhouse gases (Roadmap and Greenhouse Gas Action Plan).

1.4 Environmental issues of intensive poultry or pig farming

Environmental issues have only been on the agricultural agenda for a relatively short period of time. It was not until the 1980s that the environmental impact of intensive livestock farming really became an issue. Awareness of the implications of farming activities such as excess manure application and its impact on soil and water quality and odour nuisance has increased over the years, due to an increasing population in rural areas.

The growing concerns about climate change focused attention on the emissions from the entire livestock sector. According to the FAO, 14.5 % of human-induced GHG emissions are related to livestock production [18, FAO 2013]. On a global scale, the greater contributions come from enteric fermentation by ruminant animals and deforestation related to feed crops, whilst emissions from pig and poultry farms contribute to a lesser extent.

According to another published article, livestock sector contributes to 78 % for terrestrial biodiversity loss, 80 % for soil acidification and air pollution (ammonia and nitrogen oxides emissions), 81 % for global warming, and 73 % for water pollution (both N and P) [523, Leip et al. 2015].

The existence of livestock farms near areas of particular protection or interest (e.g. sites of specific scientific interest, wildlife and geological areas or where vegetation is very sensitive) may lead to stricter local, regional and/or national legal requirements and additional improvement conditions. This may be the case for the EU Natura 2000 sites, those in the vicinity of residential areas, or close to other farms where a cumulative impact of dust and odour may occur.

One of the major challenges in the modernisation of poultry and pig production is the need to balance the reduction or elimination of the polluting effects on the environment with increasing animal welfare demands, while at the same time maintaining a profitable and economically viable business. In addition, food security has become a real concern for governments and the public. The European agricultural industry has to operate in the global food market with technological advances which simultaneously aim to achieve economic efficiency, safeguard animal and consumer health, and protect the environment.

Potentially, agricultural activities on intensive poultry and pig farms can contribute to a number of negative environmental consequences (see also Figure 1.12):

- surface water and groundwater pollution (e.g. NO_3^- and NH_4^+);
- acidification (NH_3 mainly, H_2S , NO_x , etc.);
- eutrophication (N, P);
- airborne pollution, in particular ammonia (NH_3), N_2O , NO , dust (PM_{10} and $\text{PM}_{2.5}$), bio-aerosols, etc.;
- increase of the greenhouse effect (CO_2 , CH_4 , N_2O , etc.);
- desiccation (groundwater use);
- local disturbance (odour, noise);
- diffuse spreading of heavy metals, pesticides and toxic substances;
- spreading of pathogens including antibiotic-resistant pathogens;
- residues of pharmaceuticals in waters.

An integrated accounting of the environmental impacts of pig or poultry farming should consider the flow of manure and nutrients along the whole production chain. Positive environmental aspects of intensive livestock farming also exist, e.g. manure use for anaerobic digestion, manure substituting manufactured mineral fertiliser.

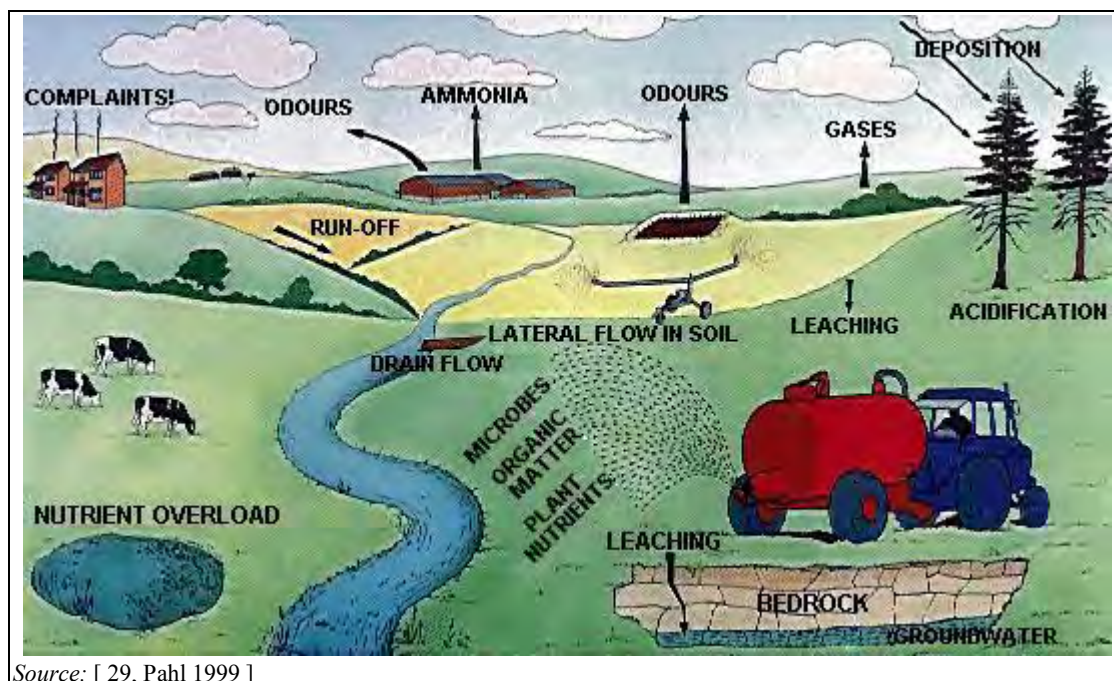

Source: [29, Pahl 1999]

Figure 1.12: Illustration of the potential negative environmental aspects related to intensive livestock farming

The key on-farm environmental aspect of intensive livestock production is related to the natural living processes, i.e. that the animals metabolise feed containing nutrients absorbed by the feed crop. Some of the nutrients are then retained in the animals, while the rest are excreted via manure. The quality and composition of the manure and the way it is stored and handled are the main factors determining the emission levels of intensive livestock production.

From an on-farm environmental point of view, the efficiency with which pigs, for example, convert feed for maintenance, growth, and breeding is important. The pigs' requirements will vary during different stages of their life, e.g. during the rearing and growth periods or during different stages of their reproductive life. To be sure that their nutritional requirements are always met, it has become customary to feed nutrients at levels in excess of the animals' requirements. At the same time, emissions of nitrogen into the environment can be observed which are partly due to this imbalance. The process of nitrogen consumption, utilisation and loss in the production of pigs for slaughter is quite well understood. Nutritional management as a preventive measure aims to improve the efficiency with which dietary nitrogen is retained in body tissue (see Figure 1.13 for the basic situation).

Animal welfare and health are linked and should be taken into account when considering the impacts of diseases [708, EC 2016].

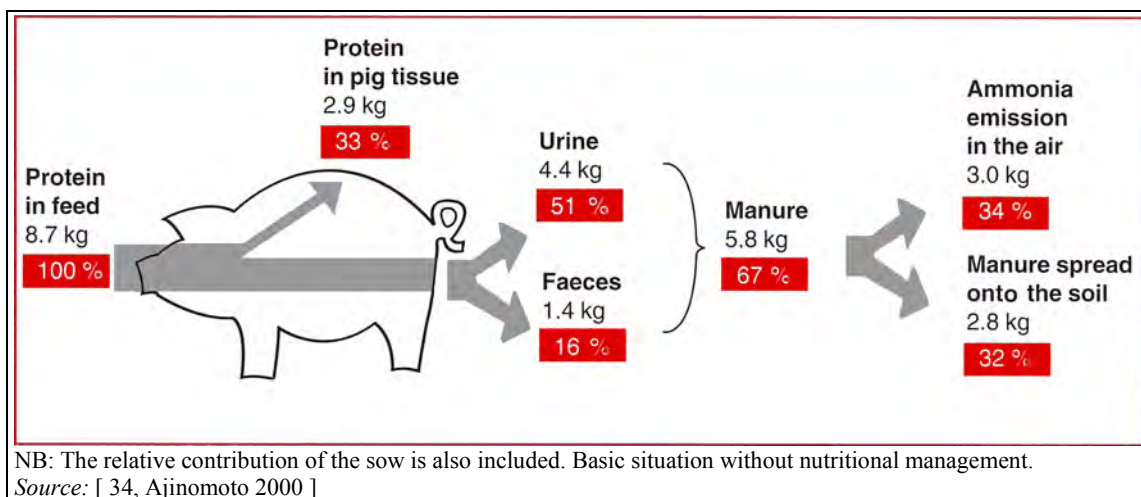

Figure 1.13: Nitrogen consumption, utilisation and losses in the production of a pig for slaughter with a final live weight of 108 kg

1.4.1 Emissions to air

Emissions to air from the production systems for the intensive rearing of poultry or pigs can be summarised as shown in Table 1.21.

Table 1.21: Emissions to air from the intensive rearing of poultry or pigs

Air	Production system
Ammonia (NH ₃)	Animal housing, manure storage, processing and landspreading
Odour	Animal housing, manure storage and landspreading
Dust (bioaerosols)	Animal housing, milling and grinding of feed, feed storage, solid manure storage and landspreading, heaters in buildings and small combustion installations
Methane (CH ₄)	Animal housing, storage of manure and manure processing
Nitrous oxide (N ₂ O)	Animal housing, manure storage, processing and landspreading
NO _x (NO + NO ₂)	Animal housing, manure storage and landspreading, heaters in buildings and small combustion installations
Carbon dioxide (CO ₂)	Animal housing, energy used for heating and transport on farm, and biogenic CO ₂ that may be emitted in the field

Ammonia emissions

Most attention has been paid to the emission of ammonia from livestock production, as this is considered an important compound for the acidification of soil and water. The subsequent impacts of ammonia deposition to land can be significant, including adverse effects on aquatic ecosystems in rivers and lakes, and damage to forests, crops and other vegetation. Ammonia contributes also to eutrophication in water and soil by nitrogen enrichment with adverse effects in aquatic ecosystems, loss of biodiversity, etc.

Furthermore, ammonia reacts with atmospheric acids, forming (secondary) particles that contribute significantly to the burden of particulate matter in the atmosphere, which is likely to threaten human health [337, Webb et al. 2005]. As a secondary particle precursor, ammonia plays an important part in the long range transport of the acidic pollutants, having environmental effects beyond an individual region [474, VDI 2011]. The 1979 Geneva Convention on Long-range Transboundary Air Pollution is an important measure for globally protecting the environment against air pollution. The 1999 Gothenburg Protocol which

originated from the Convention is aimed at reducing acidification, eutrophication and ground-level ozone. Annex IX to the Protocol includes measures for the control of ammonia emissions.

Agriculture was responsible for 94 % of EU-28 NH₃ emissions in 2011 [706, EEA 2017]. Between 1990 and 2014, NH₃ emissions in the EU-28 dropped by 24 %. The Member States that contributed most (i.e. more than 10 %) to NH₃ emissions in 2014 were Germany, France and Italy [697, EEA 2016]. Commitments from EU Member States to reduce ammonia emissions and other atmospheric pollutants have been adopted in Directive 2016/2284 [700, EC 2016]. The contribution of IED pig and poultry farms to the total NH₃ emissions is relatively large, because of the large percentage of animals (around 20 %) that fall under the IED [707, Alterra 2007].

Emissions of ammonia occur at all stages of manure management. Ammoniacal nitrogen in livestock excreta is the main source of NH₃. In animal houses, it is volatilised from the manure and spreads through the farm building and is eventually removed by the ventilation system. Factors such as the temperature, ventilation rate, humidity, stocking density, litter quality and feed composition (crude protein) can all affect ammonia levels. Factors that influence the rate of ammonia emissions from animal houses are presented in Table 1.22. For example in pig slurry, urea nitrogen represents more than 95 % of the total nitrogen in pig urine. As a result of microbial urease activity, this urea can rapidly be converted into volatile ammonia. The rate of conversion depends on the pH of the manure and other environmental parameters (e.g. temperature).

Table 1.22: Overview of processes and factors involved in ammonia release from animal houses

Processes	Nitrogen components and appearance	Affecting factors
Faeces production	Uric acid/urea (70 %) + undigested proteins (30 %)	Animal and feed
Degradation	Ammonia/ammonium in manure	Process conditions of manure e.g. T, pH, A _w , airflow at floor level, urease activity
Volatilisation	Ammonia in air	Process conditions, local climate, exposed surface and contact time of manure/slurry with the air
Removal	Ammonia in animal house	Ventilation: T, RH, air velocity
Emission	Ammonia in environment	Air cleaning
NB: T = temperature, pH = acidity, A _w = water activity, RH = relative humidity.		

Ammonia gas has a sharp and pungent odour and in higher concentrations in animal houses can irritate the eyes, throat and mucous membranes in humans and farm animals. In many Member States workplace regulations set upper limits for the acceptable ammonia concentration in working environments. In general, the generation of gaseous substances in the animal housing also influences the indoor air quality and can affect the animals' health and create unhealthy working conditions for the farmer.

The average amount of ammonia emissions in the EU-27 expressed in kg of nitrogen per kg of produced pork is estimated equivalent to 28 g. Based on this value, the total ammonia emissions for the whole European pig sector are estimated to be 606 ktonnes of nitrogen per year. Average ammonia emissions per kg of poultry meat and eggs are estimated at a level of 20 g and 12 g respectively. Total ammonia emissions from EU poultry meat production amount to 217 ktonnes of N, while total emissions for EU egg production sum up to 88 ktonnes of N per year. The methodology applied took into account all on-farm emissions related to livestock rearing, as well as the emissions associated with the production of feed and emissions caused by input of mineral fertilisers, pesticides, energy and land for the production of feed [416, COM 2010].

The E-PRTR for 2014 shows that the largest share by far of ammonia emissions from the industry sectors covered by the E-PRTR originates from the intensive rearing of poultry or pigs. In particular, 6 669 registered farms for the intensive rearing of pigs or poultry with ammonia emissions of more than 10 t/year emitted a total of 178.4 ktonnes of ammonia to air, representing 83.2 % of the total ammonia emissions from all industry sectors covered by the E-PRTR (see Figure 1.14) [45, E-PRTR 2017].

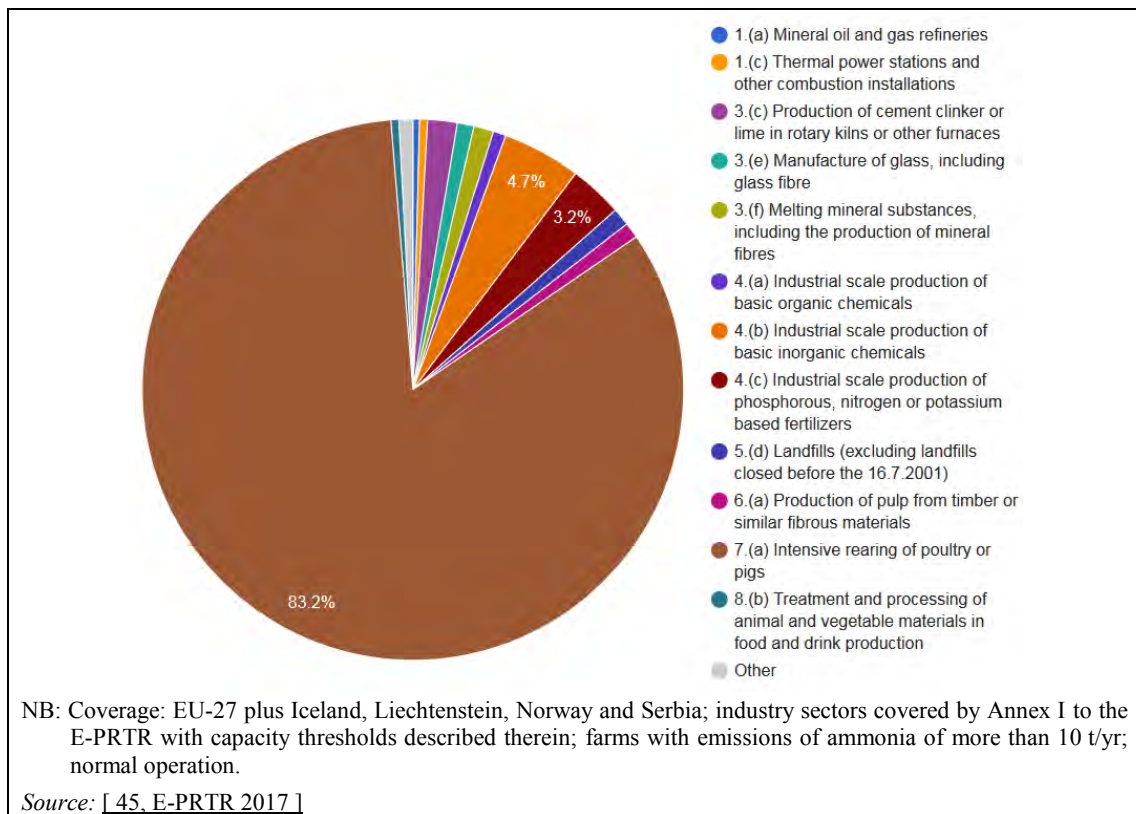

Figure 1.14: Emissions of ammonia to air by industry sector/activity in Europe in 2014

Greenhouse gases

Greenhouse gases have an effect on global warming in relation to their potential for trapping heat in the atmosphere. Methane (CH₄) and nitrous oxide (N₂O) are the most important greenhouse gases associated with animal farming and their global warming potential for a time horizon of 100 years is 25 (CH₄) and 298 (N₂O) times greater than CO₂.

Emissions of CH₄ and N₂O from livestock production are regulated as part of the Paris Agreement under the United Nations Framework Convention on Climate Change. The EU reduction target for GHG is 20 % by 2020, with reference to 1990, with a proposed further reduction target of 40 % by 2030 [701, COM 2014].

The amount of CH₄ generated by a specific manure management system is affected by the extent of anaerobic conditions present, the temperature of the system, and the retention time of organic material in the system. When manure is stored or treated as a liquid (e.g. in lagoons, tanks, or pits), it decomposes anaerobically and can produce a significant quantity of CH₄. When manure is handled as a solid (e.g. in stacks or piles) or when it is deposited on pastures and rangelands, it tends to decompose under more aerobic conditions and less CH₄ is produced [659, IPCC 2006].

Most of the nitrous oxide in livestock systems occurs through the microbiological transformation of nitrogen and this involves three main processes: nitrification, denitrification and autotrophic nitrifier denitrification. For denitrification to occur, anaerobic conditions are

necessary, while nitrification occurs under aerobic conditions. Not much is known about the nitrifier denitrification pathway, but it is believed to be similar to denitrification. Under partial or transient anaerobic conditions, the denitrification reaction is uncompleted, resulting in the production of NO and N₂O. Apart from the lack of oxygen availability, denitrification is also favoured by the presence of an available carbon source and warm temperatures, among others. Because of this dependence upon such site-specific factors, emissions of N₂O exhibit a rather high degree of spatial and temporal variability [551, Oenema et al. 2005].

Soil microbial processes (denitrification processes) produce nitrous oxide, and nitrogen gas (N₂) which is harmless to the environment. Both can be produced from the breakdown of nitrate in the soil, whether derived from manure, mineral fertilisers or the soil itself, but the presence of manure encourages this process. Livestock housing itself, particularly littered systems, is an additional source of N₂O emissions [570, ALTERRA 2000].

The IPCC factor [550, IPCC 2006] for direct N₂O-N emissions from mineral/organic fertiliser, crop residues and N mineralised as a result of soil C loss is 0.01 kg N₂O-N/kg N applied. The IPCC emission factor for indirect N₂O-N emissions is 0.010 kg N₂O-N/kg (NH₃-N + NO_x-N) volatilised and 0.007 5 kg N₂O-N/kg N leached [500, IRPP TWG 2011].

According to the results of a study on the quantification of greenhouse gas emissions of the livestock sector in the EU-27, on average pork and poultry meat have a carbon footprint of about 7.5 kg CO₂-eq/kg of meat and 5.0 kg CO₂-eq/kg of meat, respectively. Egg production causes about 3 kg CO₂-eq/kg product. Total emissions in the EU-27 amount to 165.5 and 21 X 10⁶ tonnes CO₂-eq for pork, poultry meat and egg production respectively. These emissions include all on-farm emissions associated with livestock rearing including emissions related to the production, transport and processing of feed, as well as land use changes induced by feed production [416, COM 2010].

The share of each gas in the total fluxes of greenhouse gas emissions for pig and poultry production is presented in Table 1.23.

Table 1.23: Total fluxes of greenhouse gas emissions for the EU-27 pig and poultry production

	kg CO ₂ -eq/kg of produced pork meat	kg CO ₂ -eq/kg of produced poultry meat	kg CO ₂ -eq/kg of produced eggs
CH ₄	0.74	0.04	0.03
N ₂ O	1.71	1.1	0.77
CO ₂ related to energy consumption	2.00	1.4	0.75
CO ₂ related to land use and land use change	3.1	2.4	1.33
Total carbon footprint	7.55	4.94	2.88
<i>Source: [416, COM 2010]</i>			

Other gases

Among other gas emissions related to livestock rearing, NO_x and N₂ need to be mentioned. NO_x is normally associated with combustion processes, while N₂ is derived from nitrification-denitrification processes but is not an environmental concern.

Odour

Odour is a local problem but is an issue that is becoming increasingly important as the livestock industry expands and as ever increasing numbers of rural residential developments are built in traditional farming areas, bringing residential areas closer to livestock farms. The increase in the number of farm neighbours is expected to lead to increased attention to odour as an environmental issue as odour emissions can be offensive and give rise to problems with neighbours.

Odour can be emitted by stationary sources, such as from manure storage facilities and animal houses, and can also be an important emission during landspreading, depending on the spreading technique applied. Its impact increases with farm size. Dust emitted from farms contributes to the transportation of odour.

Odour is caused by microbial degradation of organic substance (e.g. faeces, urine, and feedstuff). Odour is a complex mixture of many different compounds, such as sulphurous compounds (e.g. H₂S, mercaptans), indolic and phenolic compounds volatile fatty acids (e.g. acetic acid, n-butyric acid), ammonia and volatile amines [511, Le et al. 2007] [270, France 2010]. A leading substance in the complex mixture of odorous compounds (e.g. ammonia or hydrogen sulphide) cannot be determined [474, VDI 2011].

Dust

In the past, dust was not reported as an important environmental issue for the intensive livestock sector. Nowadays, especially where farms are close to residences, there are concerns over local air quality and a growing interest for dust emissions from livestock farms. A distinction is often made between dust and fine dust particles, i.e. the fractions of PM₁₀ and PM_{2.5} (diameters below 10 and 2.5 micrometres respectively), which are considered a major environmental risk to health due to diseases in the respiratory track.

The airborne particles that can be generated in livestock buildings range from non-organic substances (e.g. soil material) to organic particles from plants and animals, including dead and living microorganisms such as bacteria, fungi, viruses and parts of these organisms, e.g. endotoxins, that are usually called 'bioaerosols'(see Section 1.4.3) [474, VDI 2011]. Dust emissions are also a way for odour dispersion around the animal house [383, France 2010].

Inside the animal house, dust is known under certain circumstances to be a contaminant that can affect both the respiration of the animals and the farmer, such as in broiler houses with litter having a high dry matter content. The main sources of dust emissions are the animal houses and the feed management. The factors that affect dust emissions include ventilation, activity of the animals, type and quantity of bedding, type and consistency of feedstuff, humidity in the animal house.

The type of feed and feeding technique can influence the concentration and emission of dust (bioaerosols). The feeding of pellets or meals (unpelleted feeds) via liquid feed systems and through the addition of feed fats, or oils in the case of dry feed systems, can reduce dust development. Mealy feed mixes are better when combined with oils as binding agents. Liquid feed installations are regarded as desirable. A dry feed system may only be implemented on the basis of automatic slop/raw slop feeders. The high quality of the feed and bedding raw materials can be ensured through dry harvesting and storage. This will then prevent, in particular, microbial and fungal contamination.

Regular cleaning of the housing equipment and all the housing surfaces will remove dust deposits. This regime is assisted by the all-in, all-out rotation method as, following the removal of all the livestock, careful cleaning and disinfecting of the housing is necessary. Moreover, the indoor dust concentration depends very much on the animal activity. Housing techniques which offer the animals only a little freedom of motion (e.g. housing of laying hens in enriched cages) emit less dust than those which provide more freedom of motion (e.g. aviary housing, floor husbandry).

The type and quality of the litter has a great influence on emissions. Finely structured material (e.g. chopped straw) releases more particles than coarse material (long straw, wood shavings). As a general rule, in non-litter housing, less dust occurs than in the case of litter-based housing. In litter-based housing, care must be taken to keep the litter clean and dry under all circumstances and free of mould/fungus. Low air velocities in the floor area can reduce the dust content in the air.

In pig housing, airborne particulate matter also depends on the feeding technique and human presence. During feeding time and when the animals are disturbed (e.g. during inspection rounds), higher concentrations are measured than at night and in resting phases.

The presence of an air cleaning system can also influence dust emissions from housing.

1.4.2 Emissions to soil and water

Emissions from housing and manure storage facilities that contaminate soil and groundwater or surface water occur because of inadequate facilities or operational failures and should be considered accidental rather than structural. Adequate equipment, frequent monitoring and proper operation can prevent leakage and spillage from slurry storage facilities.

Emissions to surface water can also occur from a direct discharge of the waste water arising on a farm. Little quantified information is available on these emissions. Similarly, the treated effluent from slurry processing systems will normally have increased levels of nitrogen, phosphorus, BOD and total suspended solids (TSS) [364, Portugal 2010]. Waste water arising from water collected from the farmyard, manure collection areas, household and agricultural activities might also be mixed with slurry to be applied onto land, although mixing is not allowed in many Member States.

The quality of waste water produced from intensive livestock farming is generally affected by the feeding regime, animal manure, the litter used and other supplementary substances such as pharmaceuticals or disinfectants. Waste water is usually the result of manure run-off, wash water after cleaning of animals, cleaning and disinfecting of buildings and farmyards, and waste water from exhaust air treatment by wet scrubbing. In addition, polluted precipitation water may be infiltrated into the drainage via storage and manipulation, as well as from the roof surfaces [373, UBA Austria 2009]. Emissions to water from these sources contain nitrogen and phosphorus, but increased levels of BOD may also occur; in particular in water collected from the farmyard and from manure collection areas.

However, of all the sources, landspreading is the key activity responsible for the emissions of a number of components (e.g. nitrogen compounds, phosphorus, heavy metals) to soil, groundwater and surface water. It has to be stressed that land fertilisation with untreated manure/slurry or with fractions derived from manure/slurry treatments is good agronomical practice as long as they are properly managed and the side-effects are minimised.

Most attention has been given to the emission of nitrogen and phosphorus, but other contaminants, such as (heavy) metals (e.g. copper and zinc), pathogen microorganisms and pharmaceuticals may end up in manure and their emissions may cause negative effects in the long run.

Contamination of waters due to nitrates, phosphates, pathogens (particularly faecal coliforms and salmonella) or heavy metals is the main concern. Excess landspreading has also been associated with an accumulation of copper in soils, but EU legislation starting in 1984 significantly reduced the level of copper allowed in pig feeds, thereby reducing the potential for soil contamination when manure is correctly applied. While improved design and management can lead to the elimination of potential pollution sources on farm, the existing spatial density of pig production in the EU is of particular concern with regard to the availability and suitability of land for spreading pig slurry. Increased environmental regulation of the spreading of manure has sought to address this problem. Indeed, in the Netherlands and the Flemish region of Belgium, exports of surplus manure occur.

Directive 2000/60/EC of the European Parliament and of the Council establishing a framework for the Community action in the field of water policy or, in short, the EU Water Framework Directive was adopted to provide coordinated sets of objectives and tools to protect water bodies. The Directive establishes an approach for water management based on river basins, the

natural geographical and hydrological units. In this framework, Member States put various initiatives in place to address diffuse pollution from agriculture, such as the Codes of Good Agricultural Practice, or more specific initiatives, like the England Catchment Sensitive Farming Delivery Initiative in the UK.

For the Baltic and Mediterranean Seas, eutrophication concerns arise, as they are characterised by longer water retention times. The objective of Council Directive 91/676/EEC (the Nitrates Directive) is to reduce these risks via the reduction and limitation of organic nitrogen application per hectare of arable land.

Nitrogen

For nitrogen, the various emission routes after manure landspreading are illustrated in Figure 1.15. Through these reactions, losses of 25–30 % of the nitrogen excreted in pig slurry have been reported. Depending on the weather and soil conditions, this can be 20–100 % of the ammoniacal nitrogen if the slurry is surface spread. The ammonia emission rate tends to be relatively high in the first few hours after application and decreases rapidly during the day of application. It is important to note that the ammonia release is not only an unwanted air emission, but also provokes a reduction of the fertilising quality of the applied manure.

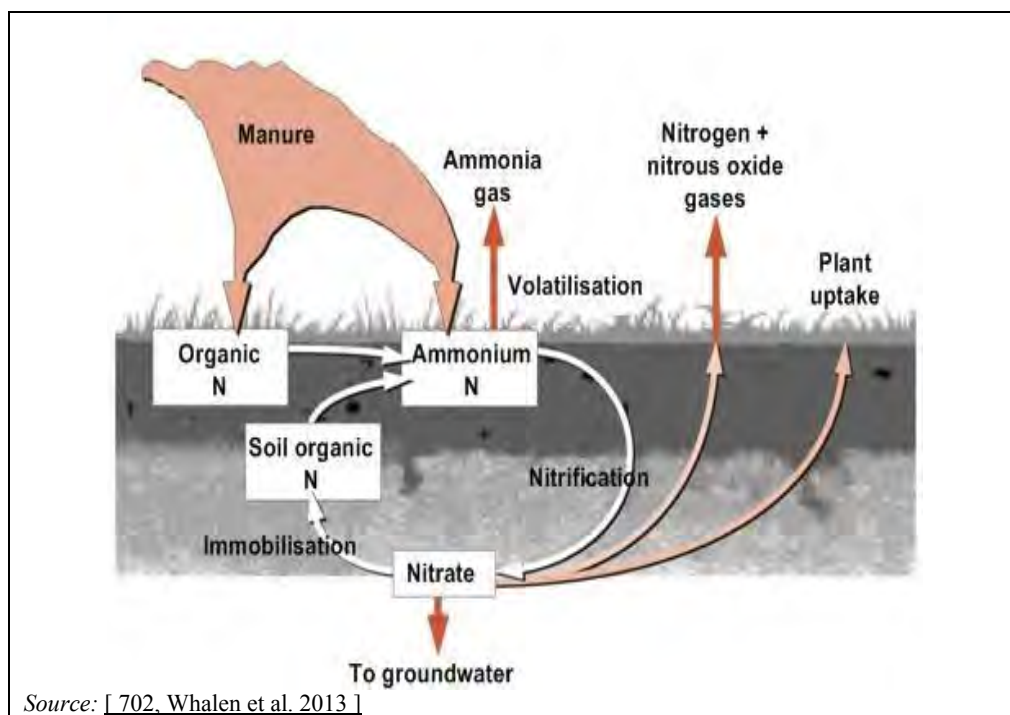

Figure 1.15: Nitrogen cycle showing the main transformations and losses to the environment after manure landspreading

To comply with the Nitrates Directive, Member States are obliged to identify zones that drain into waters which are vulnerable to pollution from nitrogen compounds and that require special protection, i.e. the Nitrate Vulnerable Zones. In these zones, regulations aim to control nitrate concentrations in ground and surface waters by careful management of land, inorganic nitrogen fertiliser and manure applications, e.g. landspreading is restricted to a maximum level of 170 kg N/ha per year.

Of the whole EU-27 area, 46.7 % has been designated as vulnerable zones, including Member States that apply a whole territory approach. As compared to 2007, the total area in the EU-27 designated as vulnerable zones has increased (the total EU-27 area to which action programmes apply was 39.6 % in 2007 including the area of Member States that apply a whole territory approach) [427, COM 2010] [460, COM 2013].

Fewer problems arise from landspreading in areas where sufficient land appropriate for application is available for the amount of manure that is produced. The intensive rearing of poultry or pigs is sometimes affected by an insufficient, small land area being associated with productive farms, particularly in areas with a high concentration of farms.

Phosphorus

Phosphorus is an essential element in agriculture and plays an important role in all forms of life. In natural (i.e. unfarmed) systems, it is efficiently recycled as it remains in the ecosystems, transforming in cycles across vegetation, residues and soil. In agricultural systems, it is removed by crops and eventually by the animal product, so further phosphorus has to be imported to sustain productivity.

Phosphorus is normally held firmly in the soil, but excessive manure applications can result in unnecessary soil enrichment, which at elevated topsoil concentrations can result in phosphorus leaching to ground and surface waters. Also, phosphorus can be lost through soil erosion and from surface run-off of freshly applied manure.

Manure applications that comply with the nitrogen load allowed by the Nitrates Directive (maximum 170 kg N/ha per year) normally provide an excess of phosphorus fertilisation. As only part of the phosphorus is taken up by the plants (5–10 %), large and often excessive applications of manure and mineral fertiliser were common in the past. Increased awareness of farmers on environmental and economic aspects induced a change in farm practices for a better use of nutrients.

The importance of manure as a source of phosphorus has increased to the point at which it is estimated that 50 % of the input to EU surface waters from leaching and penetration into soil can be attributed to the application of animal manure [32, SCOPE 1997]. Phosphorus is the main cause of algal blooms in fresh water systems and can be damaging to aquatic life and unsightly for water users.

Potassium can also be lost by leaching and in surface run-off. This means a decrease in the fertiliser value of manure, but is not a risk to the environment.

1.4.3 Other emissions

Noise

The intensive rearing of poultry or pigs can generate other emissions such as noise and emissions of bioaerosols. Like odour, it is a local problem, and disturbances can be kept to a minimum by properly planning activities. The relevance of this problem may increase with expanding farms and with the growth in rural residential developments in traditional farming areas.

2 APPLIED PROCESSES AND TECHNIQUES

This chapter describes the major activities and production systems used in intensive poultry or pig production, including the materials and equipment used and the techniques applied. It presents the techniques that are generally applied throughout Europe and to create a background for the environmental data presented in Chapter 3. It also describes those techniques that can serve as a reference or benchmark for the environmental performances of the reduction techniques presented in Chapter 4, without giving an exhaustive description of all existing practices or a description of all combinations of techniques that may be found on IED farms. Because of historical developments and climatic, economic and geographical differences, farms vary in the kind of activities that take place, as well as in the way in which these activities are carried out, namely in the combinations of techniques that may be applied. Nevertheless, this chapter should give the reader a general understanding of the common production systems and techniques applied in Europe in the production of poultry and pigs.

2.1 Introduction

Livestock production mainly consists of converting feed into meat or eggs, and is usually performed in different phases. The objective is to achieve a high efficiency in the feed conversion ratio (FCR), whilst respecting animal welfare and avoiding emissions that are harmful to the environment or to people. It is important to note that good environmental farm management is more likely to be practised if it is complementary to product quality rather than at the expense of it, since economic profitability and customer satisfaction are the main drivers for the activity.

In general, the production systems commonly applied do not require highly complex equipment and installations, but they increasingly require a high level of expertise to properly manage all the activities of the farm.

The animal housing system, where animals for meat or egg production are kept for all or part of the year, is the main determinant of the activities of the farm, and includes the following elements (see Sections 2.2 and 2.3):

- the way the animals are stocked (cages, crates, free);
- the system to remove and store (internally) the produced manure;
- the equipment used to control and maintain the indoor climate;
- the equipment used to feed, water and litter the animals.

Other important elements of the rearing system are:

- the outdoor storage of manure;
- the storage of feedstuffs;
- the storage of dead animals;
- the storage of other residues;
- the loading and unloading of animals.

Additionally, on egg-producing farms, the selection and packaging of eggs is a common activity, but this is outside the scope of this document.

A number of associated activities can be part of the farming system, but these vary between farms for reasons such as the availability of land, farming tradition, or commercial interest. The following activities or techniques may be encountered on an intensive livestock farm:

- manure landspreading;
- on-farm manure processing and treatment, e.g. biogas production, manure separation, composting;
- feed milling and grinding;
- waste water treatment;
- residue treatment, such as carcass incineration.

Schematically, farm activities for the rearing of poultry or pigs can be illustrated as in Figure 2.1.

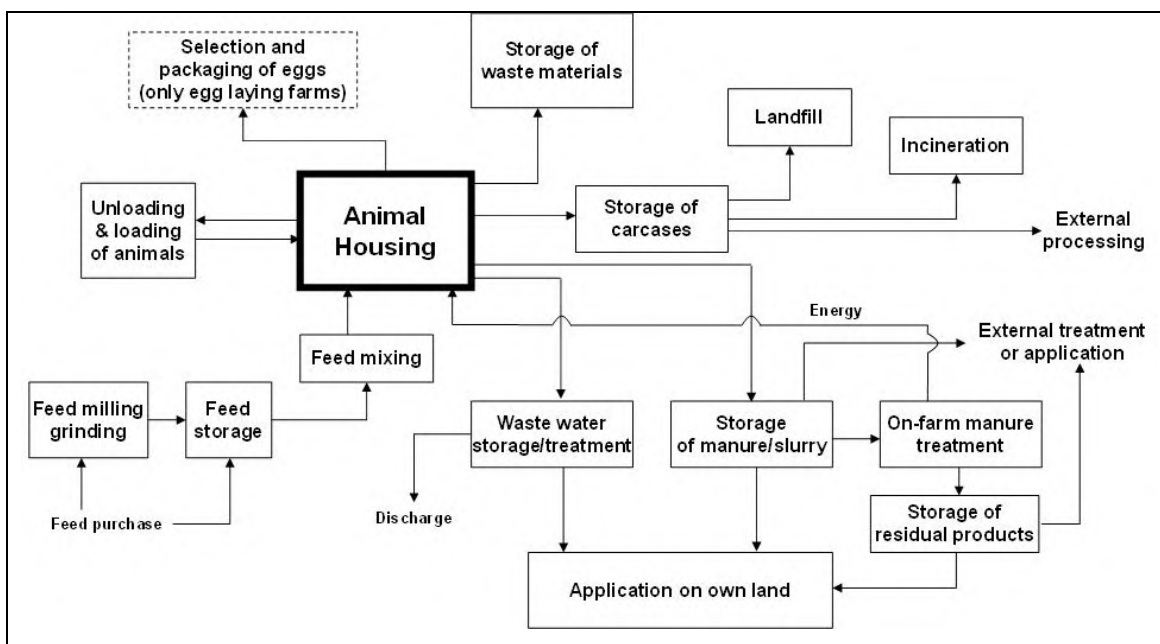

Figure 2.1: Schematic representation of activities carried out on farms for the intensive rearing of poultry or pigs

2.2 Poultry production

2.2.1 Production of eggs

For commercial egg production, the poultry breeds used are from selection and breeding programmes that optimise their genetic potential for high egg production. The breeds have smaller bodies and so direct more of the dietary nutrients into egg production, rather than into increasing their body mass. The egg-producing breeds are further divided into birds that produce white shelled eggs or coloured shelled eggs.

Council Directive 1999/74/EC of 19 July 1999 lays down minimum standards for the protection of laying hens. In accordance with this Directive, since 2012 conventional battery cages are banned for laying hens and only enriched cages or alternative (non-cage) rearing systems are allowed. Unenriched cages are allowed for breeders and pullets.

The number of laying hens per surface area varies between housing systems. The formerly commonly used cage systems allowed a stocking density, depending on tier arrangement, of up to 22 birds in each cage floor area or up to 30–40 birds/m² (corresponding to the available ground area). The rearing systems allowed by Directive 1999/74/EC laying down minimum standards for the protection of laying hens have much lower densities. In particular:

- enriched cages: up to approximately 13 birds/m² of cage area and up to approximately 16 birds/m² of usable area (each laying hen must have at least 750 cm² of cage area, 600 cm² of which shall be usable);
- barn systems: up to 9 birds/m²;
- aviary systems: up to 9 birds/m² of usable area or up to 36 birds/m² corresponding to the available ground area (no more than four levels can be used).

In non-cage systems, hens can walk around freely, such as in barn systems and free-range systems in which the hens also have continuous daytime access to open-air runs.

In cage systems, birds are kept in tiered enclosures made from welded steel wire which are arranged in long rows with sloped floors to allow the eggs to roll to the front side of the cages, where they are removed by hand or on a conveyor belt. The cage systems can be described as a combination of the following elements:

- building construction;
- cage design and placement;
- manure collection, removal and storage.

Intensive egg production usually takes place in closed buildings made of various materials (e.g. stone, wood, steel with sheet cladding). The building can be designed with or without a light system, but always with ventilation. The equipment in the housing can vary from manual systems to fully automated systems for indoor air quality control (see Section 2.2.4), feeding and drinking (see Section 2.2.5), manure removal and egg collection. Close to the housing or immediately attached are the feed storage facilities.

Laying hens kept in cages have one laying period of about 12–15 months (after a growing period of around 16–20 weeks). The laying period can be extended by a forced moult between the eighth and twelfth month of lay, hence a second laying period of at least 7 months can be added [39, Germany 2001]. Moulting is a natural process, but in commercial egg production it is sometimes still induced by feed modification or light alteration, hence it is argued that it is not a welfare-compatible practice. Moulting induction by feed or water deprivation is prohibited (Directive 98/58/EC concerning the protection of animals kept for farming purposes), whereas

changing feed composition (e.g. reducing the energy content by increasing the bran percentage) or controlling feed (instead of *ad libitum* provision) is allowed. Studies are ongoing to find a more acceptable alternative method of inducing moulting in laying hens to prolong the laying period.

2.2.1.1 Cage systems for laying hens

Directive 1999/74/EC phased out conventional cages for laying hens as of 31 December 2011, and therefore they are not described in this document. The cage systems described below correspond to modern cages that are referred to as ‘enriched’, ‘furnished’, or ‘colony systems’.

Enriched cages are equipped with structural features to stimulate species-specific behaviour, like nests, perches, litter, and increased cage height. Nest boxes can be placed at the front of the cage and are normally darkened by plastic curtains to encourage laying. Nests can be adapted to keep hens out at night, with gentle expulsion systems or automatic doors that allow animals to exit but not to enter the nest. In enriched cages, the area in which eggs are laid can be relatively small, and collisions occasionally occur between eggs in the nest box, which can damage the eggshell.

Perches are arranged to provide around 15 cm per hen, and are designed to strengthen animals’ legs. Wing flapping is made possible due to a cage height of at least 45 cm. Sand-bathing and scratching are possible in separate areas, equipped with automated distribution of sand, shavings, or other materials, plastic mats, or other kinds of litter. Claw shorteners such as perforated plates, abrasive stones, ceramics, plates or strips are provided and are frequently placed in the baffle plates behind the feed troughs. All these features can be placed in different relative positions in the cage, as shown in Figure 2.2.

A summary of the main characteristics of enriched cages is presented in Table 2.1.

Table 2.1: Summary of the main characteristics of enriched cages

Minimum cage area per hen	At least 750 cm ² , of which 600 cm ² shall be usable
Minimum total area per cage	2 000 cm ²
Length of feed trough	12 cm per hen
Minimum height	45 cm: headroom between levels in the usable area 20 cm (at least): in the remaining area of the cage
Drinking system	Two nipple drinkers or two cups must be within reach of each hen
Length of perches	At least 15 cm per hen
Levels and droppings	No more than four levels, arranged to prevent droppings falling on the levels below
Additional features	A nest: litter such that pecking and scratching are possible

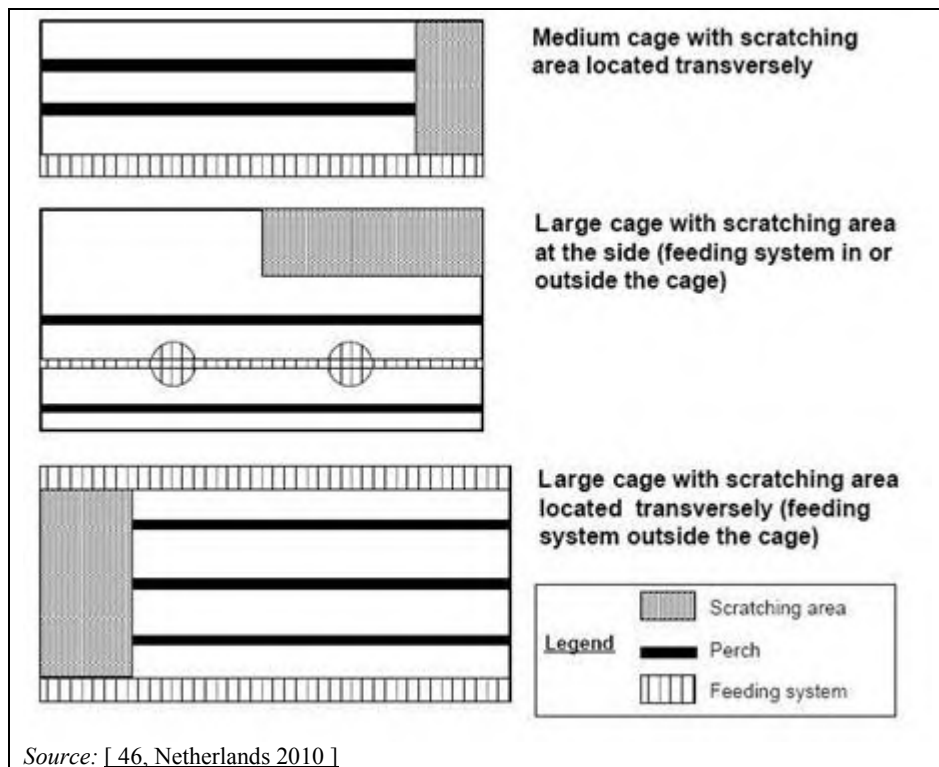

Figure 2.2: Possible placement of the equipment in enriched cages

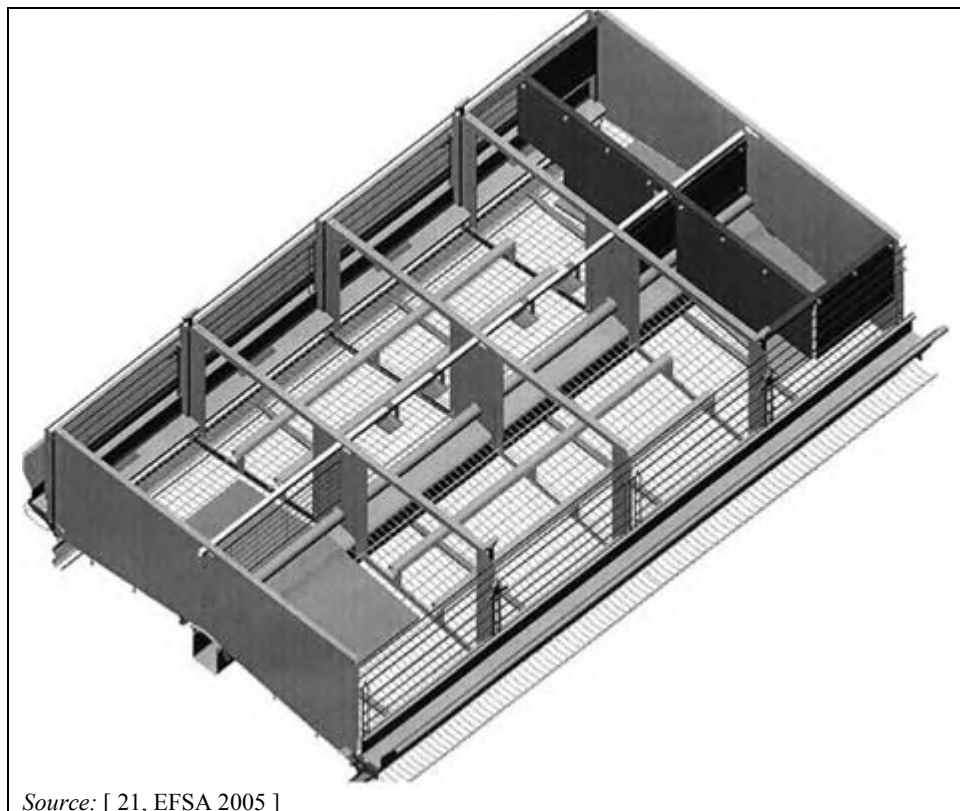

Figure 2.3: Schematic drawing of two large enriched cages

Hens are reared in enriched cages in a wide variety of group sizes. Groups of up to 10–12 birds are generally referred to as a 'small group', while 15–30 birds could be regarded as a 'medium-sized' group and above this number would be regarded as a 'large group'. Larger cages may

house up to 60 birds. Neither the maximum nor the optimum number of birds has yet been defined [38, ASG Lelystad 2006].

There are a wide variety of enriched cages designs. Positioning and layout of equipment is important to allow proper use and thus contribute to bird welfare, hygiene and performance. Cage dimensions are related to the group size and may influence inspection of birds and depopulation [21, EFSA 2005]. In Germany, the small group system that has been developed goes beyond the EU requirements for an enriched cage and allows for better hygiene levels. The cages are arranged on three to five tiers, and are often stacked in two levels with an intermediate platform [368, France 2010].

The manure is collected on manure conveyor belts that are situated under each tier of cages. At the end of the belt, a cross-conveyor further transports the manure outside, normally to external storage. Closed manure storage can pose a sanitary risk; hence, manure is also transported directly to field heaps or external storage, or to other uses (e.g. direct application on compatible cultivations, manure processing or treatment). The manure belts are made of smooth, easy-to-clean polypropylene or trevira and no residue sticks to them. With modern reinforced belts, manure can be removed from very long runs of cages. Some drying takes place on the belts, especially during the summer, and manure may be held on the belts for up to a week.

Frequently, the manure on the belts is dried by blowing air over the droppings through pipes that are placed above or along the belts. The air can be preheated and the manure is removed at least once a week at a minimum dry matter content of 40–60 %. A benefit for the animals is the introduction of fresh cooling air immediately adjacent to the birds. Further improvements consist of the introduction of conditioned air and/or the use of heat exchangers to condition incoming outside air.

2.2.1.2 Non-cage systems for laying hens

Laying hens are also kept in systems which Directive 1999/74/EC refers to as ‘alternative systems’. They are also commonly called ‘non-cage systems’. In alternative housing systems, hens are reared on a litter-covered solid floor in combination with a slatted floor. Often the floor is made of concrete, but other materials can be used as well. Manure accumulates either on the solid floor or under the slatted area for the 14-month laying period.

Manure removal is generally mechanised using scrapers or belts. They may have air-drying systems ventilating and drying the manure. Air temperature can be increased with heating systems and/or heat exchangers using the heat of outgoing ventilation air to heat incoming fresh air.

The removal system is used to convey the manure from the building to a container or storage area. Alternatively the storage may be underneath the building in a separate room. Another approach is to store the manure in a pit underneath a perforated floor or below the house where it is stored and subsequently processed or spread on the land [38, ASG Lelystad 2006].

Article 4 of Directive 1999/74/EC regulates features for non-cage systems, such as:

- the availability of feeders and drinkers;
- the positioning and dimensioning of nests, perches and litter;
- the number and the height of the floors where the hens can move freely;
- the prevention of droppings from falling on levels below;
- the dimensions and the availability of pop-holes giving access to open runs;
- the general characteristics of the open runs;
- the stocking density.

These features allow for a more comfortable housing. However, higher ammonia and dust emissions may arise compared to cage systems, due to the presence of litter material and to increased animal activity, though this can be mitigated by the frequent removal of manure with belts or scrapers.

What non-cage systems all have in common is that the birds have more space or can move around more freely within the building, and that operators can enter them. The housing construction is similar to that of the cage systems with respect to walls, roof and foundations. Birds are kept in large groups with 2 000 to 10 000 bird places per housing facility, where the air is replaced and emitted passively by natural ventilation or by forced ventilation with negative pressure. Thermally insulated poultry houses have forced ventilation, and can be either windowless or with windows for natural daylight.

Various housing designs are applied, such as variations of the basic schemes of:

- the deep litter system, also referred to as the single-tier non-cage system or single level system;
- the aviary system, also referred to as the 'perchery' or multi-level system.

These indoor systems can be combined with either one or both of the following additional structures: verandas and/or free ranges (see Section 2.2.1.2.3).

2.2.1.2.1 Deep litter system

In single-tier or single-level systems, the ground floor area is fully or partly covered with litter and may be combined with a slatted floor. At least 250 cm² of littered area is provided per hen and the litter occupies at least one third of the ground surface in accordance with the provisions of Directive 1999/74/EC. The remaining area is covered with slats that are mostly made of plastic, wire mesh or wood. Underneath the slats, a manure pit or a manure removal system (e.g. scrapers or belts) is placed to collect the droppings together with spilled water from the drinkers. Usually the slatted floor is in the middle of the hen house, with littered floors on both sides, but there are also houses where slatted floors are placed along sidewalls with the litter in the middle of the house.

The pit is formed by the raised floor or can be sunk into the ground (see Figure 2.4). Droppings are removed from the pit at the end of the laying period, or may be removed periodically, with the aid of aerated or non-aerated manure belts or a scraper. At least a third of the exhaust air volume is drawn off via the droppings pit. In single-tier systems, there is only one level available for the birds at any one point [38, ASG Lelystad 2006].

Variations are possible in wider houses, where rows of laying nests can be placed, or in the same house, two stacked compartments can be arranged on different levels of the house [70, Netherlands 2010].

The laying nests, feed installation and water supply are usually placed on the slats to keep the litter area dry. Nest boxes can be automated or hand collected, with an artificial grass bottom or with litter. Also the size of each nest can vary largely, from single nest boxes for one hen at a time to group nests.

The automatic supply of feed and drinking water, with long troughs or automatic round feeders (feeder pans) and nipple drinkers, cups or round drinkers are usually installed above the slatted area, although this depends on the available space. Lighting programmes to influence the performance/rate of laying. Perches are available and are usually placed in A-frames on the slatted floor [38, ASG Lelystad 2006] [39, Germany 2001] [44, IKC 2000].

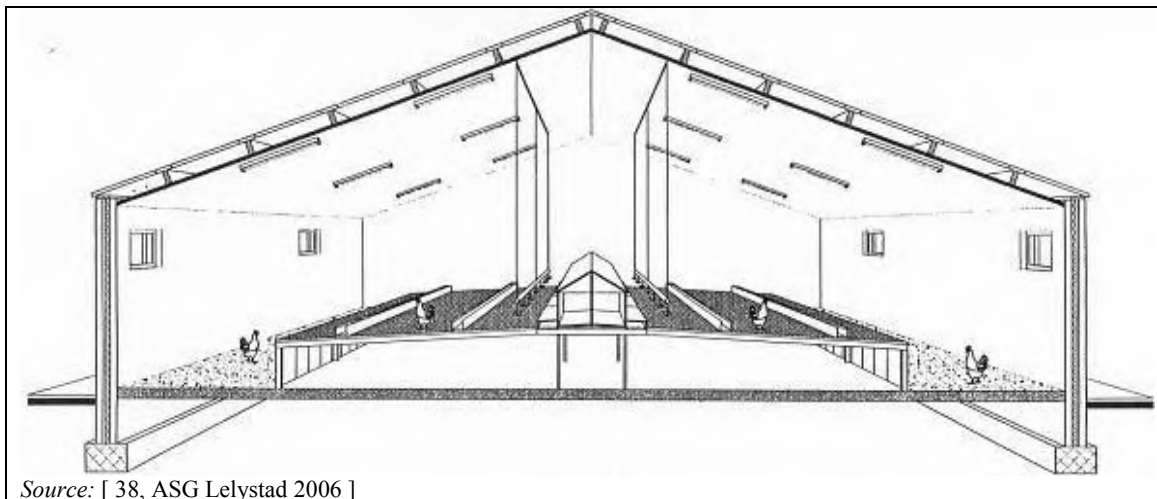

Source: [38, ASG Lelystad 2006]

Figure 2.4: Schematic cross section of a single-tiered non-cage system

2.2.1.2.2 Aviary system

Aviaries (multi-level systems or percheries) consist of the ground floor plus one or more levels of perforated platforms, from which manure cannot fall on birds below. At some point across the system, there will be at least two levels available for birds. An aviary house is a construction with thermal insulation and forced ventilation and either natural or artificial light. Houses can be combined with a free range and an outside scratching area. Birds are kept in large groups and enjoy freedom of movement over the entire house area over multiple levels. The housing space is subdivided into different functional areas: feeding and drinking, sleeping and resting, scratching and egg-laying area. The fact that the birds can use several levels allows for higher stocking densities compared to the commonly used floor regime (deep litter): up to 9 birds per usable m^2 or up to 18 birds per m^2 of ground space. Houses can accommodate up to 80 000 birds. Droppings are removed by manure belts or collected in a manure pit.

Many configurations are possible (see Figure 2.5). Three major categories can be distinguished:

- Aviaries with non-integrated nest boxes: aviaries with several levels of perforated floors with manure belts under them and separately arranged nest boxes (see Figure 2.5, configuration A). Feeders and drinkers are distributed in such a way that they provide equal access for all hens.

The earlier type of aviaries has stacks of elevated floors and separate units of nest boxes. Between the elevated floors and the nest boxes an aisle covered with litter is positioned to enable operators to walk through the system and to provide litter to the hens. The elevated floors usually have a slight slope to allow eggs to roll towards one side. Under each floor a manure belt is positioned to prevent the manure from falling to the lower levels, and to transport manure out of the hen house. The nest boxes (individual or group nests) can be lined up in one row or in multiple rows above one another.

On the elevated floors, water and feed is provided. Nipple drinkers are usually used for watering, but cups are also an option. Feed is provided by means of chain feeders or feeding pans. Perches are located over the elevated floors. The top floor usually has many perches; the lower floors often have perches only along the sides.

Litter is provided on the floor of the house. In some systems the entire floor is covered with litter and birds can walk underneath the elevated floors. In other some systems, birds cannot use the space underneath the stacks [38, ASG Lelystad 2006].

- Aviaries with integrated nest boxes: aviaries as above but where nest boxes are integrated within the blocks of perforated floors (see Figure 2.5, configuration B).

The use of a system with integrated nest boxes is an evolution of the previously described non-integrated nest system. In this type of aviaries, stacks of elevated floors with units of nest boxes are integrated in the same stack. Often, stacks with integrated nest boxes are alternated with stacks without nest boxes. Between the different stacks of floors, an aisle covered with litter is positioned to enable operators to walk through the system and to provide litter to the hens. The nest boxes (individual or group nests) are usually lined up in two rows connected with the back of the nests.

On the elevated floors water and feed is provided. Water is usually provided through nipple drinkers, but cups are also possible. Feed can be provided by means of chain feeders or feeding pans. Perches are located over the elevated floors. The top floor usually has many perches, the lower floors often have only perches along the sides of the floors. Perches are also placed in front of the nest boxes.

Litter is provided on the bottom of the hen house. In some systems the entire floor is covered with litter and birds can walk underneath the elevated floors. Other systems have the area underneath the elevated floors blocked, so that hens have to jump onto the slatted floors to continue [38, ASG Lelystad 2006].

- Portal aviaries: aviaries with elevated perforated floors, the top tier of which is a single level which links the lower stepped platforms (see Figure 2.5 configuration D). The keeper can walk under and upon the top tier. Nest boxes are integrated in the system. Units of nest boxes are integrated into the same stack. Typically, litter covers fully the entire floor of the hen house and birds can walk underneath the elevated floors. Between the different stacks of floors, under the single level part, an aisle covered with litter is positioned to enable carers to walk through the system and to provide litter to the hens. On the outside of the two stacks there is also an aisle covered with litter.

On the elevated floors water and feed is provided. Water is usually provided through nipple drinkers, but cups are also possible. Feed can be provided by means of chain feeders or feeding pans. Perches are located over the elevated floors.

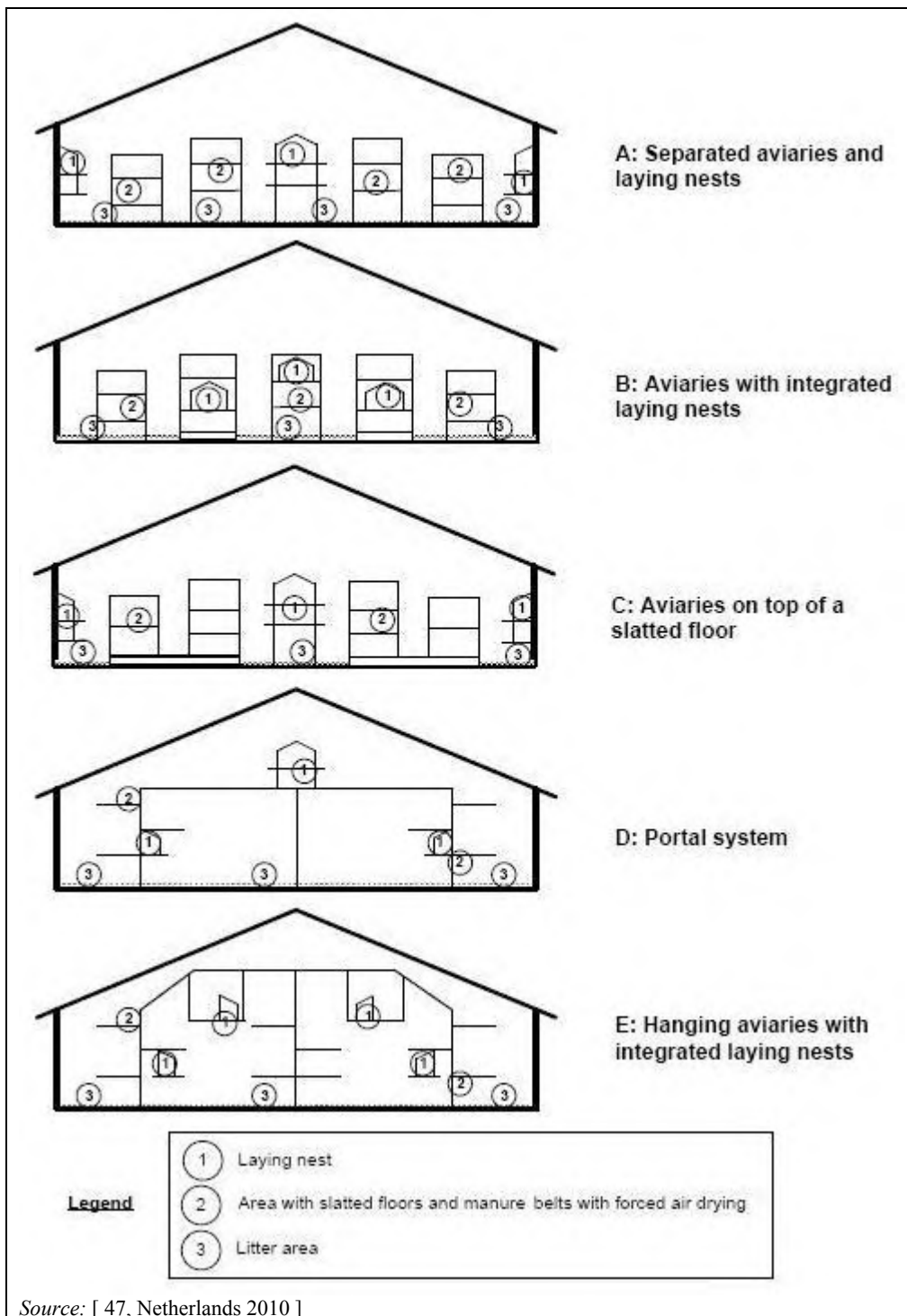

Figure 2.5: Common aviary configurations

2.2.1.2.3 Additional structures for non-cage housing

Covered veranda

This consists of an outside covered area, which is available to the birds during daylight hours. Covered verandas are connected to the hen house and can be built as additional elements to the house, or as a part of the main structure, covered by a roof extension. Verandas are often closed by shutters or a curtain that can be lifted to provide hens access to the free-range area. If there is no free range, curtains are replaced by fences of wire mesh preventing birds from getting out, but allowing fresh air to blow freely through the area. In this case, the climate is similar to that outside, except for the rain, which is prevented from entering the area by the use of protective

devices. The floor of the covered veranda is usually littered (e.g. a thin layer of sand) [38, ASG Lelystad 2006].

Free range

Free ranges can be covered with grass. The birds have access to this area from houses via pop-holes in the wall and from the covered veranda, if present. They will use the area if they feel there is sufficient shelter. The shelter may be trees or bushes, but it can also be artificial shelter (elevated nets, tents). Also, a fence is used as cover to walk along. Providing a sand bath is another way to attract poultry to use these facilities. Areas near the house may be covered with free-draining material, in order to maintain good hygiene both outside and inside the house [38, ASG Lelystad 2006]. Protection is also necessary from wild avifauna for biosecurity reasons, e.g. due to the risk of avian flu.

Veranda and free-range housing variations are not intended to reduce ammonia emissions.

2.2.1.3 Pullet rearing

Success in the laying period will greatly depend on effective housing and management in the rearing period. In order to facilitate a smooth start to the laying period, it is advisable to rear the pullets of laying hens in a system that is similar to the one they will be housed in during the laying period [38, ASG Lelystad 2006]. This procedure, together with a transfer well before the onset of laying, minimises the stress due to the transfer into a new facility and, consequently, promotes layer productivity.

Feed and light management of the pullets will also influence the production results later in life. Stimulation too early may lead to more egg-laying problems. As the challenges hens meet in the laying period are different for cage systems and alternative systems, the rearing management should be focussed on the demands of the laying period [38, ASG Lelystad 2006].

The rearing phase for chicks up to 17 or 20 weeks is normally run in separate facilities because the microbial conditions of the adult environment would be too dangerous for young chicks. The space provided in small group housing is about 0.035–0.045 m² per bird.

Management details differentiate pullet rearing from the laying period. For instance, in pullet rearing, more care is paid to providing heat to the few-days-old birds, to encouraging them to feed and drink after arrival, and to synchronising their activity with lighting programmes.

Pullets can be reared in simple deep litter housing on a bedded solid floor in closed, well insulated houses with forced ventilation and without functional areas. The manure is stored with the bedding and is removed at the end of the rearing period, which is about 16–18 weeks. The system is relatively animal-friendly and provides a space of 0.05–0.07 m² per head (whilst in aviaries, 0.017–0.04 m² per head is usual). However, high ammonia, dust and odour emissions arise due to the long-term indoor manure storage. A slatted floor covering no more than two thirds of the area can be included, allowing a deep pit underneath. Manure is removed at the end of the rearing period.

2.2.2 Production of broiler meat

Broiler meat is produced by growing meat-type breeds of chicken. Meat chickens stem from broad breeding programmes which balance health, welfare and productivity. A limited number of international companies produce hybrid varieties (strains) from combinations of many different breeds. Traits that are mostly considered in the genetic selection are: higher breast meat yield, more efficient feed conversion, reproduction efficiency, and improved disease resistance. Obviously, these strains are not as well suited to laying eggs as the laying breeds.

Directive 2007/43/EC, laying down minimum rules for the protection of chickens kept for meat production, establishes rules for the protection of animals, aiming for a balance between animal welfare, health, economic and social considerations, and environmental impacts.

The traditional housing for intensive broiler production is a simple, closed-building construction of concrete or wood with artificial lighting or artificial/natural light combination lighting systems, and thermal insulation. Forced ventilation (negative pressure principle) is applied by way of fans and air inlet valves (see Figure 2.6). Naturally ventilated buildings are also used which are constructed with open side walls (windows with louvre-type curtains). Open climate houses are located so that they are freely exposed to a natural stream of air and are positioned at a right angle to the prevailing wind direction. Additional ventilating fans may operate via ridge slots during hot weather and gable openings may also apply to provide extra air circulation during hot periods in summer. Wire mesh screens along upper side walls keep wild birds out.

Broilers are commonly kept on litter spread over the entire floor area. Bedding can be made up of chopped straw or wood shavings, but also of shredded paper, rice husks or other material, which has to comply with the provisions (dry and friable on the surface) of Directive 2007/43/EC. The floor area is usually built as a solid concrete slab, but may also consist of a clay floor (in France, 93 % of buildings have non-concrete floors). The bedding is spread uniformly at the beginning of each growing period and the solid manure is removed (broiler litter) at the end of the growing period.

Modern housing is mainly equipped with controlled ventilation systems that allow climate control for animals, litter drying, and, ultimately, for channelling air to air treatment devices. The airflow direction depends on the position of inlets and outlets which can be placed on the roof ridge, on side walls or gable ends. Hence the air can be drawn from the sides up to the ridge, or from the top down to the sides (cross ventilation), or all along the length of the house from one gable side to the other (tunnel ventilation). In housing fitted with cross ventilation, the litter moisture may be less homogenous and can be around 10 % higher [91, Italy 2010]. Directing the ventilated air in a precise direction also allows it to be channelled entirely to an air treatment system, without leaving any uncontrolled airflows.

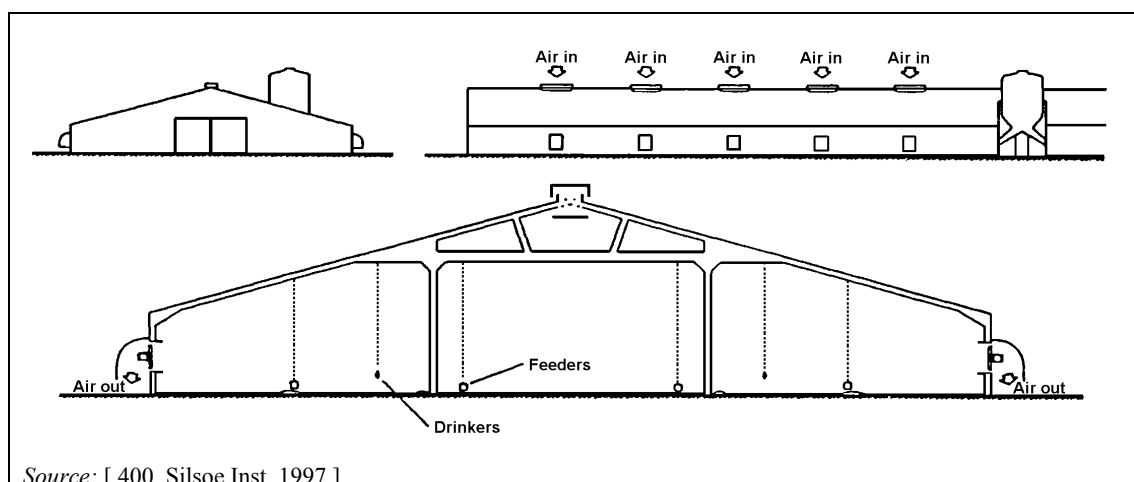

Figure 2.6: Example of schematic cross section of a common broiler house

Automatic, height-adjustable feeding and drinking systems (mostly tube feeders with round feeder pans and nipple drinkers with drip-water catch bowls) are provided.

Closed buildings have oil- or gas-fired warm-air blowers for whole room heating, when needed; heat exchangers (water-air, air-air) coupled to air blowers are increasingly used. Radiant heaters (mostly gas-fired) are used for zone heating.

Broilers are kept at a stocking density of 13 to 26 birds per m², depending on the duration of the fattening period and consequently of the live weight (LW) at slaughter. Typical bird weights and ages prior to slaughter are given below:

- 34-day cycle and final weight of 1.5 kg of LW per bird;
- 40-day cycle and final weight of 2 kg of LW per bird;
- 45–55-day cycle and final weight of 2.1 kg of LW per female bird or 3 kg of LW per male bird.

Directive 2007/43/EC defines the maximum stocking density in a housing system as 33 kg/m². Broilers can also be kept at a higher stocking density of 39 kg/m² and up to 42 kg/m² if Member States allow derogations, provided that the housing systems comply with certain welfare requirements.

Houses can be combined with a veranda, where open side walls along the side of the house allow birds access to a covered, outside climate area for animal welfare reasons. Verandas are usually equipped with a base plate covered with some type of litter (scratching area) or ground covering. Verandas are often combined with free-range systems (made accessible from the twentieth day of the bird's life onward) where the animals have free access to an outside area during the daytime. This production system is especially common on organic farms or in special animal welfare programmes (see also Section 2.2.1.2.3).

2.2.3 Other poultry production sectors

2.2.3.1 Rearing of broiler breeders

Meat broilers are slaughtered well before they become sexually reproductive at around 5 months of age. The broilers' parents, often called 'broiler breeders', live to maturity and beyond so they can be used for breeding. Broiler breeder farms raise parent stock which produces fertile eggs for broiler production. Housing is similar to that of broilers, additionally equipped with nests where eggs are laid, or they may be reared in cage systems.

Broiler breeder rearing is typically a two-stage process. Parent stock purchased from a primary breeder is delivered at a day old to 7–10 days old. Most are first placed on starter farms, where males and females are raised separately, until 10–20 weeks old. In the houses where reproduction takes place, 8–10 males are provided for a hundred females, and one nest is provided for approximately every five females. Feeding of broiler breeders is restricted to avoid reproductive problems.

2.2.3.2 Production of turkeys

Turkeys are reared for meat production and different production systems apply. These include the two-phase system (e.g. in the UK, the Netherlands, Germany). The first period covers a brooding period for all birds up to 4–6 weeks, until they reach an approximate weight of 2 kg, after which the birds are transferred to different housing for the fattening phase. In general, the slaughter weight for the stags is from 14.5 kg to 21 kg live weight, with a fattening period that ends at 16–22 weeks, and for the hens, the slaughter weight is generally from 7.5 kg to 11 kg live weight, with a fattening period between 10 and 17 weeks. The animals are kept in much higher densities at the beginning, when they are still small. During the growing period, the birds are thinned, and after 22 weeks only a third of the birds may be left. For example in the UK, the hens are removed first and sold as oven-ready birds. Stags are used for further processing.

The most commonly applied turkey housing is a traditional housing construction, which is very similar to that used for the housing of broilers (Figure 2.6). Turkeys are housed in closed, thermally insulated buildings with forced ventilation, or in open houses with open side walls and louvre-type curtains (controlled natural ventilation). Forced ventilation is applied by fans and inlet valves while natural ventilation is created via automatically controlled louvre-windows or wall-mounted inlet valves. Open houses are aligned at right angles to the prevailing wind direction and located in such a way as to be exposed to natural airflow. Additional ventilation is applied via ridge slots and gable openings. Radiant gas heaters are used for heating.

Closed buildings are typically used to house all young turkeys in the first rearing period, and to rear the females in the finishing phase. For the finishing period, stags are more often reared in houses with open side walls and natural ventilation, which may also be fitted with outdoor free ranges. The stocking density in Germany is reported as 5 birds/m² for the finishing period of female turkeys and 2.8 birds/m² for the finishing period of male turkeys [118, Germany 2010].

Precautions are put in place to protect against emergencies like power cuts, extreme weather conditions or fire, since all animals in these large units will be at risk at once. During peak summertime temperatures, additional measures are taken to minimise heat stress on the birds (by providing for larger-volume air exchange, operating extra fans for bird comfort in open houses, water fogging or roof sprinkling).

Wire meshing in the upper side wall section is applied to keep wild birds out. A floor regime is operated with litter material (chopped straw, wood shavings) with a depth of 5–7.5 cm spread over the entire housing floor area (built of concrete), with layers topped up during the rearing cycle reaching a depth of 20–55 cm. Manure removal and cleaning of the house takes place at the end of each respective growing period. All manure is removed by an excavator or a front-end loader. Litter replenishment is applied as needed. Automatic height-adjustable drinkers (such as bell drinkers) and feeders are provided during the growing period to minimise spillages and avoid the degradation of litter. Daylight length and light intensity can be controlled during brooding and, in houses with forced ventilation, over the entire brooding/finishing period.

The rearing of turkeys must comply with the provisions laid down in the Council of Europe's 'Recommendation concerning turkeys (*meleagris gallopavo ssp*)' as adopted by the Standing Committee of the European Convention for the protection of animals kept for farming purposes on 21 June 2001.

2.2.3.3 Production of ducks

Ducks are generally reared for meat production. There are numerous breeds on the market, but popular breeds for commercial meat production are Pekin and Barbary; Rouen and Muscovy are both types of Barbary. The Muscovy and domestic duck hybrid (mallard duck) is obtained by crossing a female Pekin duck and a male Muscovy and it is produced on farms for meat and foie gras. Different breeds are used for egg laying, although Pekins have a reasonable laying performance compared with the other breeds reared for meat. Pekins account for about 80 % of meat production and Barbary ducks for 20 %. Muscovy ducks are the heavier types. Drakes are normally heavier than female ducks (see Table 2.2).

Ducks are kept in housing, although in some Member States outdoor rearing is also allowed. There are three main housing systems for the fattening of ducks:

- fully littered, with or without water systems positioned above a gully;
- partly slatted/partly littered;
- fully slatted.

The commonly applied duck house is a traditional housing system and is similar to the broiler house (Figure 2.6). It has a concrete floor that is covered with litter. The house is equipped with a ventilation system (natural or mechanical) and, depending on the climatic conditions, heating is applied. Partly or fully slatted floors are also used.

Table 2.2: Range of weights of duck breeds for meat and egg production

	Adult drake (kg)	Adult duck (kg)
Meat breeds		
Pekin	3.00–4.50	2.80–3.75
Muscovy	4.50–5.50	2.25–3.00
Rouen	4.50–5.00	3.50–4.10
Egg breeds		
Indian Runner	2.00–2.25	1.60–2.00
Khaki Campbell	2.25	2.00
Source: [506, TWG ILF BREF 2001] [365, France 2010]		

Production cycles will vary between Member States. In Germany, the cycle for Pekin duck meat production consists of a growing period until they reach 16 days old; followed by a finishing period until day 40–42, and a final weight of 2.9–3.1 kg. Growing and finishing is done in separate houses. Manure is removed and houses are cleaned and disinfected during a service period of about five to seven days, before they are stocked again. The maximum stocking density is 20 kg live weight/m² of accessible floor area in both phases. Thus, the growing houses can accommodate approximately 20 000 ducklings and the finishing houses about 6 000 ducks (see fact sheets in [39, Germany 2001]). In France, Barbary drakes and ducks are raised together on fully slatted floors, with a density of 14.5 birds/m² until day 72, when females are then slaughtered. Males are reared until 85 days of age [365, France 2010].

The fully littered system is commonly applied, using wheat or barley straw (including wood shavings for the ducklings). A suitably thick bedding layer, taking into account that the manure of ducks is much wetter than that of chicken broilers, is crucial for the good health and condition of the birds; a daily addition is normally necessary in order to avoid wet litter. Approximately 3–4 kg of straw per duck is needed, generating triple the quantity of manure, i.e. 9–12 kg of litter per duck at 30–35 % total solid content. Slatted flooring is also used, with the slats made out of plastic-coated wire or synthetic material.

The rearing of ducks has to comply with the provisions laid down in the Council of Europe's 'Recommendation concerning Muscovy ducks (*cairina moschata*) and hybrids of Muscovy and domestic ducks (*anas platyrhynchos*)' and 'Recommendation concerning Domestic ducks (*anas platyrhynchos*)' as adopted by the Standing Committee of the European Convention for the protection of animals kept for farming purposes on 22 June 1999. In particular, the design, construction and maintenance of enclosures, buildings and equipment for ducks have to be such that they allow the fulfilment of the essential biological requirements of ducks, such as access to water for bathing or to water facilities sufficient in number and so designed to allow water to cover the head and be taken up by the beak so that the duck can shake water over the body without difficulty.

2.2.3.4 Production of guinea fowl

Approximately 45 million guinea fowl are produced in Europe per year. Of the total EU production, 86 % is situated in France, in 926 farms incorporating 1 345 buildings and a total surface area of 437 000 m² [365, France 2010]. A further 13 % of European production takes place in Italy.

Commercial breeding and the raising of guinea keets can be compared with that of turkeys. Guinea fowl are very different in their behaviour to chickens and need a lot of space: in France they are reared at a density of 16.8 birds/m², until 78 days. Breeder guinea fowl (approximately 350 000 in France) are raised in cages where artificial insemination is practised systematically. It is unclear whether there are any farms in Europe rearing guinea fowl intensively in such numbers so as to be under the scope of Directive 2010/75/EU.

2.2.4 Control of poultry indoor environment

Housing systems for all poultry species are normally equipped to maintain the indoor environment. Factors that are important for the indoor environment in poultry housing in general are:

- indoor air temperature and humidity (see Section 2.2.4.1);
- air composition and air velocity at the animal level (see Section 2.2.4.2);
- light intensity (see Section 2.2.4.5);
- dust concentration (see Section 2.2.4.3);
- stocking density;
- insulation of the building.

Treatments applied to incoming air (principally for animal welfare reasons) generally comprise dust removal, cooling and/or humidification [264, Loyon et al. 2010]. Adjustments are usually made by controlling the temperature, ventilation and lighting. Minimum health standards and production levels impose requirements on the indoor climate of poultry houses.

2.2.4.1 Temperature control

The temperature in poultry houses is controlled by means of the following techniques:

- insulation of the building;
- local heating (deep litter systems) or space heating;
- direct heating (e.g. infrared, gas/air heating, gas convectors, hot-air cannon) or indirect heating (central heating of space, central heating of underfloor);
- cooling by spraying of the roof (practised in warmer climates and in summer);
- cooling by spraying water mist, also known as fogging;
- wet filters (pad cooling systems);
- heat exchangers.

Floors are often made of concrete and are normally not further insulated, except for broilers (see Section 4.6.4.1). Partly insulated floors are sometimes applied while in the northernmost countries floors are often fully insulated (e.g. Finland). There is a potential loss of heat from the housing by radiation to the soil underneath, but this is small and has not been reported as having an effect on production. Heating is sometimes applied through heat recovery from the exhaust air, which is also used for manure drying. For layers, heating is hardly needed when the stocking density is high.

Generally, in winter, but also during the early stages of production (young birds), heating is applied to broilers, turkeys, ducks and pullets. Local heating is usually provided by gas radiators that allow the animals to find their optimal temperature by displacement below the heater. Movement is sometimes restricted when the birds (of all species) are small, to keep them near the brooders.

The capacity of the heating equipment is related to the number of birds in the shed and the volume of the shed. For example, in Portugal, gas radiators with a capacity of 6 000 kJ are equal to 650 one-day-old birds per radiator, and a capacity of 12 500 kJ equates to 800 newborn birds. Some typical temperatures for the housing of broilers are shown in Table 2.3.

Table 2.3: Examples of required indoor temperature for broiler rearing

Age (days)	Indoor temperature (°C)		
	Portugal ⁽¹⁾	UK ⁽²⁾	France ⁽³⁾
1–3	37–38	30–34	31–33
3–7	35	32	30–32
7–14	32	28–30	28–30
14–21	28	27	26–28
21–29	No heating	18–21	26–23
28–35			20–23
Over 35			18–20
⁽¹⁾ [8, Portugal 1999]			
⁽²⁾ [40, NFU/NPA 2001]			
⁽³⁾ [339, ITAVI 1997]			

In turkey housing, the required temperature is higher (32–34 °C) at the beginning of the rearing period, so heating may initially need to be applied. When the birds grow, the indoor temperature is gradually decreased (see Table 2.4). When heating the turkey housing, more ventilation is needed and this results in higher energy consumption. On a number of farms in the Netherlands, recirculation of the air is practised, combining natural and mechanical ventilation. By operating valves, the airflow can be adjusted in such a way that the air is mixed properly, and less energy is then needed for heating.

Table 2.4: Indoor temperature for rearing turkeys, applied in France

Age (days)	Temperature (°C)	Age (days)	Temperature (°C)
0–2	33.5–34	25–26	26.5
3–4	32.5–33.5	27–28	26
5–6	32–33	29–32	25.5
7–8	31.5–32.5	33–34	24.5
9–10	31	35–36	24
11–14	29.5	37–38	23.5
11–16	29	39–40	23
17–18	28.5	41–42	22.5
19–20	28	43–44	21
21–22	27.5	+44	19–21
23–24	27		
Source: [339, ITAVI 1997]			

During hot weather it may be necessary to lower the indoor temperature to ensure birds do not suffer heat stress. Directive 2007/43/EC of 28 June 2007 states that for outdoor temperatures higher than 30 °C, the interior temperature should not exceed the outside temperature by more than 3 °C.

In practice, in spraying systems, plates located outside the building are used for injecting water into the incoming airflow, at a low pressure of 3 to 5 bar. These devices are the least expensive and allow a maximum cooling of 3–5 °C but have a lower cooling efficiency, e.g. a spraying device needs three to five times more water than a fogging system for the same cooling effect [358, France 2010].

The main cooling techniques used in poultry farming are water fogging (see Section 2.2.4.3) and wet filters (see Section 2.2.4.4) which are based on evaporative cooling. A farmer needs to utilise both air movement and evaporative cooling during hot weather to keep birds comfortable and productive, taking into account the relative humidity in the barn.

2.2.4.2 Ventilation of poultry housing

Poultry housing can be naturally and/or forced ventilated, depending on the climatic conditions and the birds' requirements. Ventilation has the objective of circulating the air in order to provide fresh air and to remove gaseous products, heat and moisture to ensure a suitable indoor climate.

The building can be designed to force the ventilation airstream across, or longitudinally through, the building or from an open ridge in the roof downwards via fans below the cages. For both natural and forced ventilation systems, the prevailing wind direction may influence the positioning of the building, for instance it may increase the required control of the ventilation airflow, as well as reduce emissions to sensitive receptors in the vicinity of the farm. Where low outdoor temperatures occur, heating equipment may be installed to maintain the required temperature inside the building.

Ventilation is important for the birds' health and will therefore affect production levels. It is applied when cooling is required, and for maintaining the composition of the indoor air at the required levels. For broilers for example, Directive 2007/43/EC lays down minimum requirements environmental parameters that need to be ensured, namely:

- NH₃ concentration not exceeding 20 ppm;
- CO₂ concentration not exceeding 3 000 ppm;
- indoor temperature, when the outside temperature measured in the shade exceeds 30 °C, not exceeding this outside temperature by more than 3 °C;
- indoor average humidity, measured over 48 hours, not exceeding 70 % when the outdoor temperature is below 10 °C.

Parameters for controlling fan speed and air inlet openings may include temperature, relative humidity and carbon dioxide concentration which are monitored by appropriate sensors. Additional air parameters can be controlled. For example, for the composition of air in broiler housing in Belgium-Flanders, upper limit values are also set for H₂S at 20 ppm and for SO₂ at 5 ppm.

Ventilation systems can be divided into natural and forced systems. Natural systems are comprised of openings in the ridges of the roof. Minimum outlet sizes are 2.5 cm²/m³ of housing volume, with a required inlet of 2.5 cm²/m³ on each side of the building. With natural systems, the design of the building is important to enhance ventilation. If width and height are not properly matched, ventilation may be insufficient and may give rise to increased levels of odour inside the housing.

Forced (mechanical) ventilation systems, where ventilation is carried out through the use of electrically powered fans in the walls or roof that are normally controlled by the temperature in the building, operate under negative pressure and a net inlet of 2 cm²/m³ of housing volume.

They are more expensive, but give better control of the indoor climate. Different designs are applied, such as:

- roof/side ventilation: air is pulled down across the width of the house by air inlets and fans in the roof and exits through side vents;
- ridge ventilation: air is drawn in through openings in side walls and forced out via fans on ridges;
- cross ventilation: air is pulled across the width of the house by air inlets and fans in side walls;
- tunnel ventilation: air is pulled down the length of the house with air inlets and fans in gable end walls.

For layers housed in cages, the ventilation airflow ranges from 3 to 7 m³ per bird per hour in the summer (depending on the climate zone) and 0.5 to 0.8 m³ per bird per hour in the winter [39, Germany 2001].

Generally, the ventilation capacity of 4–6 m³ per kg live weight is applied in the design of ventilation systems for broilers. The air speed at bird level varies with temperature, and speed levels of 0.1–0.3 m/s have been reported [8, Portugal 1999]. The ventilation capacity changes with the outside air temperature and relative humidity (RH) and with the age and live weight of the birds (CO₂, water and heat requirements).

The relationship between ventilation needs and the different variables was reported in a study conducted in Belgium. With an outside air temperature of 15 °C and a RH of 60 %, the ventilation was determined by the CO₂ balance in the first three days, by the water balance in the first 28 days, and after this by the heat balance. With lower outside air temperatures, the CO₂ balance and water balance become more important. From a temperature of 15 °C, the heat balance becomes more important in combination with lower RH and heavier chickens. It was concluded that a minimum ventilation requirement for broilers should be set at 1 m³ per kg live weight, to be prudent [509, Province Antwerpen 1999].

2.2.4.3 Water fogging

Fogging systems are a means of lowering the indoor temperature in regions with high summer temperatures, and controlling humidity and dust. The key characterisation parameters for the equipment are pressure and design. Water is sprayed through specially designed nozzles and indoor air is cooled through evaporative cooling.

The fogging system at medium pressure (< 70 bar) has a good cost efficiency but presents risks of litter moistening. The fogging system at a high pressure (> 70 bar) is more sensitive to the water quality and the clogging of the nozzle. The higher cooling efficiency makes it possible to obtain a reduction in temperature of up to 10 °C when the surrounding air is dry and the droplets fine enough (< 10 microns) [358, France 2010].

In combination with fans, evaporative cooling is combined with convective cooling: evaporation cools the air and fans, which are placed close to the nozzles, to create an airflow that intensifies the cooling effect. The benefits of this technique are:

- cooling effect;
- dust abatement (see Section 2.2.4.6);
- additive products can be sprayed simultaneously with water;
- cleaning of slatted floors, where present, is easier.

2.2.4.4 Pad cooling

Pad cooling systems (or wet filters) are used to cool down the incoming air in poultry houses by a water evaporation effect. The system is most effective at high temperatures and low relative humidities.

The pads are cellulose or plastic panels with a large specific surface area and are continuously kept soaked. The warm incoming air flows through the moist pads (by negative pressure), taking up humidity and cooling down in turn. Excess water is recirculated [358, France 2010].

The residual salinity of the circulating water and the possibility that pathogenic organisms can develop on the large surfaces are the main difficulties encountered with the management of these systems.

2.2.4.5 Lighting of poultry housing

Poultry housing may use only artificial light or may allow natural light to enter (sometimes called ‘daylight housing’). The laying activity and laying rate can be influenced by the use of artificial lighting.

Minimum light intensity and light periods (lighting duration per day) are regulated by Directive 1999/74/EC of 19 July 1999, laying down minimum standards for the protection of laying hens, and Directive 2007/43/EC of 28 June 2007, laying down minimum rules for the protection of chickens kept for meat production. In particular, the following requirements apply:

- In broiler houses, a lighting intensity of at least 20 lux during the lighting periods and illuminating at least 80 % of the usable area is required (temporary reduction may be allowed following veterinary advice). In addition, within seven days from the time when the chickens are placed in the building and until three days before the foreseen time of slaughter, the lighting must follow a 24-hour rhythm and include periods of darkness lasting at least 6 hours in total, with at least one uninterrupted period of darkness of at least 4 hours, excluding dimming periods;
- For the production of laying hens, all buildings shall have light levels sufficient to allow all hens to see one another and be seen clearly, to investigate their surroundings visually and to show normal levels of activity. After the first days of conditioning, the lighting regime must follow a 24-hour rhythm and include an adequate uninterrupted period of darkness lasting, by way of indication, about one third of the day. A period of twilight of sufficient duration ought to be provided when the light is dimmed, so that the hens may settle down.

Different lighting schemes are applied with alternating periods of light and darkness. An example of lighting program is shown in Table 2.5 for broilers.

Table 2.5: Examples of lighting programmes for broiler production

Age of birds (days)	Light intensity (lux)	Hours of light per day
1–3	20	23
4–10	5	8
11–15	5	12
16–21	5	16
22–35	5	18
36–42	5	23
<i>Source: [709, The Poultry Site 2017]</i>		

In laying hens, the photoperiod length is usually between 12 and 17 hours in practice, often increasing as the birds increase in age (for gonadal stimulation). Good production results can also be achieved with intermittent photoperiods (alternating short periods of light and darkness). Light intensity necessary to keep a normal laying rate is 5 to 7 lux. Light intensities well over 10 lux are usually avoided to prevent serious feather pecking.

Where there is natural light in laying hen houses, apertures are often shaded or baffled to avoid direct sunlight and thus arranged in such a way that light is distributed evenly within the accommodation. For the first few days after housing light may be fairly bright. Later the light intensity should be such as to prevent health and behavioural problems [38, ASG Lelystad 2006].

In turkey rearing, lighting is particularly important during the first few days of rearing (1–7 days), when programmes with a light intensity of at least 10 lux or more (up to 50 lux) and 2 to 3 hours of darkness are applied. Afterwards, the light intensity is reduced. Light schemes can vary from at least 14 to 16 hours a day, with an appropriate period of rest from artificial lighting always available to birds in conformance with Directive 98/58/EC.

2.2.4.6 Control of dust

Controlling dust at source not only reduces emissions to the external environment, but also helps to maintain a better indoor environment for animals and workers. Animal activity is normally a factor in increasing dust emission. Dust levels may also increase when the form of the feed is dusty, such as with some non-pelleted feeds for laying hens. Broiler feed is less dusty as it contains a higher level of fat. The equipment in which feed is administered can also increase the amount of airborne dust. Automatic feeders can generate dust when the feed is dropped into the troughs.

Dust emissions are generally higher in houses using bedding than in enriched cages. Oil spraying is an inexpensive and effective abatement method, removing airborne dust by binding it to oil in the litter (see Section 4.8.4); however, cleaning of the houses can be more difficult and the quality of the litter can be affected.

Dry filters can be fitted to internal air recirculation units. Negative ionisation of indoor air deposits fine dust on surfaces which can easily be removed after each growing cycle (see Figure 2.7).



Source: [377, Netherlands 2010]

Figure 2.7: Effect of dust attraction caused by ionisation on the roof of a poultry shed

Water fogging (see Section 4.8.3) produces small droplets that absorb airborne particles and fall on the floor. It is important that the size of water and dust particles are similar, in the range of a few micrometres. If the sprayed droplets are too large, the dust particles flow around the droplets and are not absorbed, as little or no contact occurs.

2.2.5 Poultry feed and drink supply

2.2.5.1 Poultry feed formulation

Feeding is very important, as it determines the quality of the end products. For example, broiler growth (reaching the required weight in only 5 to 8 weeks) depends largely on feed quality. The way feed is obtained varies from the purchase of ready-to-use feed mixtures to on-farm milling and preparation of the required mixtures, which are often stored in silos adjacent to the birds' housing. The formulation of poultry feed has also to meet the requirements of the animals by ensuring the right level of energy and essential nutrients, such as amino acids, vitamins and minerals.

In poultry production, the energy value of a feed (ingredient or diet) is expressed as the metabolisable energy (ME) as it is not possible to measure the digestible energy (DE) since faeces and urine are not separated and because of the negligible energy losses of the heat increment which is needed for the formulation of net energy (NE).

The essential amino acids (or indispensable amino acids) are those that the animal metabolism cannot provide or can only provide in small quantities. Therefore, essential amino acids must be supplied through the diet in sufficient quantities to cover the animals' requirements. The essential amino acids are methionine (+cystine), lysine, threonine, valine, isoleucine, leucine, tryptophan, arginine, histidine and phenylalanine (+tyrosine).

Cystine is not an essential amino acid per se, but methionine can only be made from cysteine and thus they are always linked. In formulations of poultry feed, the most frequent amino acid deficiencies are sulphur amino acids (methionine and cysteine) and lysine. Another quoted deficiency is typically threonine [506, TWG ILF BREF 2001]. However, latest developments in the production of amino acids means more amino acids are now available for better poultry feed formulations.

In the formulation of feeds for poultry nutrition, the ideal protein is a concept where the optimum indispensable amino acids supply is described in terms of ratios to lysine (which has been used as a reference because it is the first limiting amino acid for growth in pigs) and where any deficiency of one of the indispensable amino acids will compromise growth and/or health. In this profile, all indispensable amino acids are equally essential for performance, just covering the requirements for all physiological functions. In practical nutrition, this offers the advantage that the lysine requirement will vary (per kg of feed or per MJ of energy), but not the ideal amino acids profile expressed relative to lysine. Each of these ratios can thus be directly introduced as a constraint in feed formulation.

Formulating feeds can require the use of linear programming to obtain the required mixtures. Layers, in particular, require sufficient calcium to produce the eggshell. Phosphorus is important for its role in the storage of calcium in the bones and will either be fed as a supplement or made more readily available from feedstuffs used in the diet by, for example, adding phytase to the feed. Other minerals (trace elements) in the feed can be varyingly controlled as well: Na, K, Cl, I, Fe, Cu, Mn, Se and Zn, while others like S and F are already sufficiently available in the feed. Vitamins are not produced by the animals themselves, or are produced in insufficient quantities, and should therefore be added to the daily ration. Vitamins are often part of a premix with minerals.

The use of additives in animal feed is regulated at European Union level (Commission Regulations 1831/2003 and 429/2008). Each additive is evaluated for safety and efficacy, as well as for the way it is used in animal nutrition. Only after a thorough risk assessment is each feed additive authorised for use accompanied by the conditions of that use and its effects, indicating the minimum and maximum dosage in feeds, for which species it is applicable, the appropriate age of the animal and whether a withdrawal period has to be observed.

The composition of poultry feed also varies considerably between Member States, as it is a mixture of different ingredients, such as:

- cereals grains, their products and by-products;
- oilseeds, oil fruits, their products and by-products, tubers, roots, their products and by-products;
- other seeds and fruits, their products and by-products;
- milk products and fish, other marine animals, their products and by-products.

Meat and bone meal is banned in Europe. In Spain, pork lard is added to the feed because of the lack of the enzyme lactase, but milk products are not included. In the UK, 'bulbs, tubers and roots or root crops' are not fed to poultry. In France, animal fats are not used. In Danish broiler production, wholewheat is added to the broiler feed at the farm, from day 10. The share of wholewheat in the total feed is initially 2 % at day 10 and is then continuously increased up to 30–35 % at the end of the production cycle.

Different substances can be added to poultry feed for different reasons, e.g.:

- Some substances are added in small amounts, but can have a positive effect on growth, by increasing the weight gained and improving the feed conversion ratio (FCR). Enzymes, herbs, essential oils, immunostimulants and organic acids are examples of substances used (compounds of Cu and Zn may also be included in this category).
- Some substances raise the nutritional quality of the feed (e.g. vitamins, trace elements).
- Some substances improve the technical quality of the feed, e.g. technological additives, such as those that can improve the pressing of feed into granules.
- Some substances balance the protein quality of the feed, therefore improving the protein/nitrogen conversion (pure amino acids).
- Some substances increase the digestibility of phosphorus of plant origin, therefore improving phosphorus uptake from feed (e.g. the enzyme phytase).

The use of antibiotics as feed additives in animal feed to stimulate growth is prohibited under EU Regulation No 1831/2003/EC. Coccidiostats and histomonostats may be added to prevent the development of parasites. Such products are regulated as additives in animal nutrition.

Apart from the feed formulation, different types of feeding regimes are also adopted during production cycles to match the feed more closely to the requirements of the birds. For the different categories, the following numbers of feeds are most commonly applied:

- layers: 2 phases (feeding up to laying, during laying);
- broilers: 3–4 phases (early weeks growing, finishing);
- turkeys: 4–6 phases (more types for stags than for hens);
- ducks: 2–3 phases.

Layers can also have six-phase feeding, three phases up to laying (pullets) and three phases during laying, or two to three phases up to laying (pullets) and one or two phases during laying [40, NFU/NPA 2001] [506, TWG ILF BREF 2001]. Feeding programmes for broilers are affected by the strain of bird, as well as the sex and market age or market weight [327, Germany 2010].

2.2.5.2 Feeding systems

Feeding practices depend on the type of production and bird species. Feed is given in mashed form, crumbs, or pellets. Layers are generally fed *ad libitum* [40, NFU/NPA 2001] [30, Spain 2001]. Meat species, such as broilers and turkeys, are also fed *ad libitum*. Hand feeding is still applied, but in large enterprises modern feeding systems are applied that reduce the spillage of feed and that allow accurate (phase) feeding.

Common feeding systems are:

- chain feed conveyor;
- auger conveyor;
- feeding pans;
- moving feed hopper.

Chain feed conveyors move feed from the storage area through to the feeding gutter. It is possible to influence the feeding pattern, spilling and rationing by adjusting the velocity of the conveyor. Chain feed conveyors are common in floor systems and are also applied in cage systems. In the auger conveyor, feed is pushed or pulled through the feeding gutter by a spiral. Spillage is low. Application is common in floor systems and aviary systems.

Feeding pans or bowls are connected with supply via the transport system. The diameter varies from 300 mm to 400 mm. Feed is transported by a spiral, chain or a steel rod with small scrapers. The system is designed with a lifting device. They are applied in floor systems (e.g. broilers, turkeys and ducks). In the case of bowls, one bowl feeds approximately 65–70 birds. For the feeding of turkeys, feeding pans are used in the earlier life stage but, at a later stage, feeding barrels (50–60 kg) are also used. Feed is supplied in large buckets or square feeding troughs. Tube feeding systems are increasingly applied to reduce spillage.

A feed hopper is a moving system that moves alongside the cages on wheels or a rail, and is equipped with a funnel-shaped hopper. Moved by hand or electrically, this system fills the feeding trays or gutters.

Examples of feeding space allowances (in the UK) for meat poultry species are as follows:

- Broiler, pan feeders: 1 linear metre per 100 birds.
- Broiler, chain feeders: 0.75 linear metre per 100 birds.
- Turkeys, pan feeders: 1 linear metre per 100 birds.
- Ducks, trough space: 50 cm per 100 birds from 1 day old to 8 weeks of age, 60 cm per 100 birds of 8 weeks of age and over.

2.2.5.3 Drinking water supply systems

All animals must have permanent access to a suitable water supply or be able to satisfy their fluid intake needs by other means (Directive 98/58/EC). For all poultry species water has to be available without restriction. Birds need water to control their body temperature, as well to support the digestion of the feed provided. The drinking water system is also used to provide additional micronutrients to birds in case of additional requirements. Techniques applying restricted watering have been tried but for welfare reasons this practice is no longer allowed (except for breeders).

Various drinking systems are applied. Design, proper maintenance and control of the drinking system aim to provide sufficient water at all times and, at the same time, to prevent leakages and spillage and, therefore, wetting of the litter. Natural drinking behaviour also has to be considered, e.g. hens drink by putting their beak into the water, and then lifting their head and letting the water run down their throat.

There are different drinking systems:

- high-capacity nipple drinkers (around 80–90 ml/min or higher);
- low-capacity nipple drinkers (around 30–50 ml/min);
- round (or bell) drinkers;
- water troughs (or cup drinkers);

Nipple drinkers are often used in automatic watering systems designed to provide water on demand to broilers or laying hens. They improve water hygiene and reduce evaporation.

Nipple drinkers have various designs. Usually, they are made of a combination of plastic and steel and are placed underneath the water supply pipe. A pressure control system is installed at the beginning of each pipe, with a water gauge to measure consumption. Pressure regulation in water lines is a critical aspect as leaking is often the result of the wrong water pressure (e.g. any slope in the floor and long pipelines may create pressure differences in the system). Drinkers are generally designed to produce optimal results within a certain pressure range.

High-capacity nipple drinkers have the advantage that the bird quickly receives a proper amount of water, but have the disadvantage of leaking water during drinking. To catch this leakage, small cups are installed underneath the nipples (drip cups). Nipple drinkers with a drip cup are the most economical in water consumption. Low-capacity nipple drinkers are not affected by leakage, but drinking takes longer with nipples than with bell drinkers. In non-cage systems for laying hens, the drinking hens may block other hens on their way to the nest, and so eggs may be laid in incorrect places [[407, Netherlands 2002](#)].

In floor housing, the nipple drinker system can be installed in such a way that it can be lifted out (for example for cleaning and mucking out). It works with low pressure. Additionally, the nipple line is generally positioned above the birds' heads and gradually raised as the birds grow to avoid water leaking and spoiling the litter underfoot. Additionally, some individuals' water intake (and hence food intake) may be constrained through inefficient use of nipples, and these and other slower-growing birds may find it increasingly difficult to obtain water as nipple lines are raised progressively during the growing period [[624, IRPP TWG 2013](#)].

Round drinkers are small, circular plastic containers of different designs (e.g. bell-shaped designs) depending on the type of bird or the system they are applied to. They are usually attached to a winch line and can be pulled up. They work on low pressure and are easily adjustable. Round drinkers (or bell drinkers) are the oldest systems but are still widely used in turkey and duck rearing. They incur a notable waste of water because even a minimal movement of a bird's head leads to spillages. Stabilisers are also applied to prevent tipping over [[357, France 2010](#)].

Water troughs (or cup drinkers) are containers providing water which are placed on or below the water supply pipe. Cups are either filled with water all the time or filled when a metal strip is touched by a bird. Other valves can also be used to trigger water delivery, e.g. a floating ball for young poultry that cannot force valves to open. Cup drinkers are placed in groups or in lines and can minimise stagnant water; however, they can be more complicated to keep clean.

In most layer housing systems, automatic watering systems are applied using nipple drinkers. In the Netherlands, 90 % of the water supply systems for layers are nipple drinkers and 10 % are round drinkers [407, Netherlands 2002]. The number of birds serviced in France by the different types of drinking systems is shown in Table 2.6.

Table 2.6: Number of birds serviced by each type of drinking equipment in France

Species	Starter	Serviced birds	Grower/Finisher	Serviced birds
Broiler	Round drinker	100–150	Round drinker	100–130
	Nipple drinker	10–20	Nipple drinker	15–18
	Drinker with cup	200–250	Drinker with cup	200–250
	Large cup	60		
Turkey	Round drinker	50–200	Round drinker	100–120
	Mini-cup	20	Mini-cup	20
	Large cup	100	Large cup	100
	Nipple drinker	8–10	Nipple drinker	100–120
	Drinker with cup	200–250	Drinker with cup	135
Duck	Round drinker	50	Round drinker, wide channel	120–150
	Nipple drinker ⁽¹⁾	5–7	Nipple drinker ⁽¹⁾	5–7
Guinea fowl	Round drinker	50	Round drinker	100–130
	Nipple drinker	15	Nipple drinker	15
⁽¹⁾ When nipple drinkers are provided as the drinking source, then an additional water source must also be provided, such as troughs, bell drinkers, baths or showers. <i>Source:</i> [357, France 2010] [500, IRPP TWG 2011]				

In broiler houses, watering points are installed in many places, frequently using a combination of round drinkers and nipples drinkers. The round drinker design gives every bird easy access to water and aims at limiting spillage, to prevent wetting the litter.

In the UK, nipple drinkers are more commonly applied for broilers than round drinkers. In the Netherlands, only 10 % of the water supply systems for broilers are nipple drinkers and 90 % are round drinkers. In France, 80 % of broiler farms use nipple drinkers, 15 % bell drinkers and 5 % cup drinkers [40, NFU/NPA 2001] [407, Netherlands 2002] [357, France 2010].

Drinking water for turkeys is supplied using round drinkers or water troughs. Round drinkers and troughs can differ in size according to the stage of production (smaller or larger birds). Nipple drinkers are generally not applied, as turkeys do not use these effectively. In France, 30 % of turkey farms use nipple drinkers, 20 % use cup drinkers and 50 % bell drinkers [357, France 2010].

For duck rearing in the UK, a minimum water drinker space of 60 cm per 100 birds should be provided. The most commonly used source is the bell drinker. Ongoing research in the UK aims to determine the height, width and depth of the most suitable trough-type drinkers. Where nipple drinkers are provided as the drinking source, then an additional water source should also be provided, such as troughs, bell drinkers, baths or showers. In France, 75 % of duck farms use bell drinkers and the rest nipple drinkers [357, France 2010].

2.3 Pig production

2.3.1 Pig housing and manure collection

In intensive pig production systems, separate phases of production are recognised which require different feeding and housing conditions:

- breeding (including mating, gestating, farrowing and neonatal period);
- weaning;
- fattening (growing and finishing).

The gestation length of the sow is approximately 112 to 115 days. The average litter size in the EU is 11. After birth, piglets are nursed by their dams for approximately 21 to 28 (in some Member States up to 35) days. During this phase of production in most Member States, male piglets that will not be used for breeding are surgically castrated.

After weaning, piglets are generally moved to - and mixed with - members of other litters in specially designed housing systems for weaners. This phase presents the greatest management challenge as dietetic changes (from milk to solid foods at this early age) are frequently associated with disease outbreaks. After about 5 weeks, when the piglets reach approximately 30 kg live weight the weaned pigs are moved on to further accommodation to finish their growth prior to slaughter.

As the selection of individuals to fill pens in the fattening houses is based on live weight, members of different litters may become pen mates in the fattening pens. There are a few instances where pigs are housed together during the entire rearing period from weaning to slaughter. However, due to economic reasons, different management and environmental requirements during the production phases, these systems are rare. The length of time that pigs spend in the fattening sheds will be determined by their growth rate as in most systems the live weight determines the time of slaughter. The weight of carcasses will depend on the demand for meat cuts.

Housing system designs are affected by a number of factors including climate, legislation, economics, farm structure and ownership, research and traditions. EU legislation, combined with certain socio-economic issues, has had a great impact on pig housing systems in Member States. Changes have also come about because of retailing standards applied in certain Member States which have had a major effect on the production methods used by some producers [495, EFSA 2007].

Production systems can be divided into two main categories, those based on liquid manure (slurry) and those based on solid manure. Some of these systems provide different climatic zones where the pig can choose its microclimate for various activities (i.e. for resting in kennels or under thermo-boards). The main common characteristics of both systems, for all animal types (sows, weaners, fattening pigs), are given below.

Techniques based on slurry

In liquid manure techniques, fully or partly slatted (or perforated) floors with slurry channels or pits situated underneath are used. Housing systems with slatted floors are the most widely used throughout the EU. Hygiene is maintained in these systems, usually in the absence of any bedding (or bedding is used only in relatively small quantities, e.g. as occupational material), by the installation of slatted or perforated floors through which the excreta can fall and be stored in a physically separate place to that occupied by the animals. Slurry can be stored in the animal house or removed continuously or periodically (e.g. at the end of the production cycle) via channels and pipes to outdoor storage.

Floors may be fully slatted over the entire pen area, or have a solid concrete lying area combined with a slatted dunging area. Pens with partly slatted floors may require more space than fully slatted floors. Partly slatted floor systems need to provide enough space for pigs to be able to maintain separate and distinct lying and dunging areas, so that the solid portion of the floor and the pigs can be kept clean. Some pens are therefore equipped with two floor types that differ in the degree of perforation (i.e. 40 % versus 10 %; the area with lower perforation being intended for lying) in order to lessen the risk of reduced cleanliness.

Slats can be made of concrete, metal (mostly iron) or plastic and have different shapes (e.g. triangular), although the use of composite materials is increasing. One critical component for the efficient use of slatted floors is the dimension of the gap between slats in relation to the dimensions of the animal feet at any given age.

Directive 2008/120/EC of 18 December 2008 lays down minimum standards for the protection of pigs and, among other things, imposes a maximum width of openings in concrete slatted floors according to pig category. The maximum width of the openings must be 11 mm for piglets, 14 mm for weaners, 18 mm for rearing pigs and 20 mm for gilts after service and sows. Directive 2008/120/EC also determines the minimum slat width, which is 50 mm for piglets and weaners, and 80 mm for rearing pigs, gilts after service and sows [158, EC 2008].

The manufacture of precast concrete flooring is covered by a European Standard (EN +A1:2007), consistent with Council Directive 2001/88/EC. This standard specifies both minimum and maximum gap and beam widths for precast concrete floors together with a manufacturing tolerance. The top of the beams are not permitted to have sharp edges; where radius or chamfer are provided these shall not exceed 3 mm.

Concrete slats have proved to be more durable than other materials, such as metal and plastic. Smooth finishes facilitate cleaning and ensure that no faecal matter builds up. Systems for removing manure and urine are related to the flooring system and as such are described in the context of housing systems. These systems may vary from deep pits with a long storage period to shallow pits and manure channels through which the slurry is removed frequently by gravity and valves, by flushing with a liquid or by scraping.

The base and walls of the slurry pit, including the channels for slurry transfer, are usually built of reinforced concrete cast *in situ*, precast reinforced concrete modules or concrete blocks sealed with a waterproof coating. Channels have a flat or a V-shaped base. V-shaped channels are prone to potential blockages caused by solids left behind as the liquid fraction of the slurry may run off faster during evacuation [175, Ecodyn 2010] [624, IRPP TWG 2013].

Moreover, some countries have formulated demands stricter than or additional to the EU legislation with respect to floor area, floor design, or provision of natural light. For example, in Denmark and the Netherlands, the requirement for continuous solid floor space is greater for most pigs and the maximum drainage opening smaller than those mentioned in the EU Directive; in Sweden, there is a ban on fully slatted floors in all pig housing; in Germany, houses for the rearing of fattening pigs are required to have at least 50 % continuous solid floor [201, Mul M. et al 2010].

In general, there is increasing attention being paid to the provision of manipulable materials to animals, in order to provide them with the opportunity to behave naturally (foraging, rooting, nesting, etc.). When these behavioural needs are not met, which can be different for the different pig categories, a range of adverse welfare consequences result, one of these being an increased risk of tail biting in weaners and fattening pigs [566, EFSA 2014].

Techniques based on solid manure

In solid manure techniques, the solid floors of the pens are littered with bedding material in order to bind urine and faeces in the litter. Straw and other materials, such as wood shavings, sawdust and peat (in Finland) are used. Bedding materials should be comfortable to lie on, non-

abrasive, non-slippery, highly absorbent and have low levels of environmental bacteria and mycotoxin contamination. Bedding materials have different capacities to absorb moisture, in proportion to their dry weight. The absorbency and characteristics of different bedding materials are presented in Table 2.7.

Table 2.7: Absorbency and characteristics of different bedding types

Bedding material	Mean absorbency factor (kg water absorbed/kg material)	Remarks
Sawdust ⁽¹⁾	2.60	Coarse sawdust is extremely absorbent. Fine sawdust is not a suitable bedding material due to potential health problems for workers and animals because of increased dust emissions.
Barley straw ⁽¹⁾	1.91	Commonly used for pigs; soft and does not contain much dust. The least absorbent of all straw types.
Wheat straw ⁽¹⁾	2.14	The most commonly used material for pigs; quite brittle, not as soft as barley and with wider stalks. The least palatable of all the straws.
Oat straw	2.86	Softer than wheat straw and, therefore, more absorbent than all other straws. It can be expensive due to its feed value. Highly palatable; however, very light and fluffy so will blow away quite easily in outdoor units.
Triticale straw ⁽¹⁾	1.97	Similar to wheat straw, although a little harder. It produces a 30 % larger volume of straw compared with the equivalent yield of wheat or barley straw.
Cornstalks	2.70	Only available when the cob is used for animal feed rather than when the whole plant is used for silage.
Shredded paper ⁽¹⁾	2.08	Dust-free, very absorbent and costs little. Excellent bedding material especially for farrowing sows. Light to handle and easy to transport packaged in bales. Also works well mixed with straw.
Wood chips/Coarse wood shavings	NI	Good drainage properties. Can be obtained free of charge from processing plants and joinery manufacture, thus incurring only transport costs. Likely the most cost-effective option when produced on farm from home-grown or recycled wood. Can also be used underneath straw. Wood chips produced from wood that has been treated with chemical preservatives or glues cannot be used as a bedding material.
Peat	3.8–5.2	Peat has a very high absorption capacity. High dust emissions are associated with its use as a litter material, mainly during its application.
⁽¹⁾ Values calculated on the basis of the information reported in reference [388, BPEX 2011]. NB: NI = no information provided. Source: [388, BPEX 2011] [624, IRPP TWG 2013]		

Straw is a manipulable material enabling rooting. It also provides thermal insulation and physical cushioning, as well as having a moderate absorption capacity, making it an effective bedding material. The viability of straw (availability and cost) is affected by plant harvests and competition from different uses (e.g. biofuel). In the UK, pig farms typically use wheat and barley straw and occasionally oat straw.

Due to the large surface area and the high C:N ratio, straw can reduce emissions of NH₃ if properly managed (i.e. keeping the litter dry by more frequent straw addition or manure removal, hence at an additional cost) but, on the other hand, may also result in the *in situ* composting of the litter and hence increased litter temperature and NH₃ emissions [252, IGER 2005].

Additionally, compared to slurry management, straw bedding may lead to significantly higher emissions of greenhouse gases (methane and nitrous oxide). Nevertheless, CH₄ emissions from the straw-based sow housing systems are not greater than the emissions from the slurry-based systems, as it seems that CH₄ produced in the deeper anaerobic layers of the litter bed is readily oxidised to CO₂ in the surface layer, due to aeration by the rooting and foraging behaviour of the pigs [441, Webb et al. 2012]. Finally, provision of straw, especially straw of poor quality, and the use of wood chips and sawdust will increase the production of airborne particles such as dust, moulds and fungi associated with respiratory disturbances in pigs and humans [495, EFSA 2007].

Use of straw in pig housing is expected to increase due to concern for the welfare of the pigs. In conjunction with (automatically controlled) naturally ventilated housing systems, straw allows the animals to self-regulate their temperature with less ventilation and heating, reducing energy consumption. The integrated evaluation of straw use should consider the added cost of the straw and mucking out the pens; possible increased emissions from storage and landspreading with straw; and the benefit of adding organic matter to the soil [508, TFRN 2014].
[500, IRPP TWG 2011]

For litter-based systems, even though there are a number of designs and layouts of the animal house and different practices for manure management, two main methods of litter management can be distinguished.

a. Littered-floor system (or 'scraped litter'): In scraped systems, the lying and dunging areas are made structurally distinct and the manure is removed at frequent intervals from the dunging area. Animals are provided with little to moderate amounts of litter which serves as an absorptive and manipulable material [495, EFSA 2007].

When straw is used as bedding material, the manure is scraped with a typical frequency of between two and three times a week or manually removed from once or twice a week up to a daily frequency. Topping up with fresh dry litter is regularly carried out in order to prevent the litter from becoming too wet; this operation replaces the amount of straw which is removed with the manure. The smaller the amount of litter applied, the higher the risk of an increase in humidity and ammonia emissions. Floors can be sloped to one end to allow the collection of the manure resulting from the mixture of dung and straw.

b. Deep litter (or 'accumulated litter'): The litter accumulates on the floor and a permanently thick bedding is provided. Fresh straw is added upon necessity (usually every week) over accumulating manure, which is removed at the end of the rearing period or can remain for periods longer than one production cycle (removal after successive production cycles). This period can range from a few weeks (piglets, sows) to several months (fattening pigs, sows). After the bedding material is spread, litter may need to be stirred, since pigs tend to defecate in the same area of the pen. The abundance of bedding can alleviate the effect of low temperatures.

In deep litter systems, the whole area occupied by the animal has to be kept clean and dry by regular provision of absorbent bedding material. In such systems the animals will often subdivide the pen area into separate lying and dunging areas, choosing to lie in the most thermally comfortable and undisturbed areas and excreting in areas of the pen which are cold, wet or draughty. Space requirements are therefore greater in these systems compared with fully or partly slatted pens [495, EFSA 2007].

In the case of sawdust used as a bedding material, only a deep litter system is used; this can be a thick (60–80 cm) or thin (15–20 cm) bedding. The majority of sawdust bedding is provided at the start of the production cycle. The deep sawdust bedding is used for several batches and the surface layer is removed at the end of the cycle. In the case of thin sawdust bedding, no sawdust is added during the cycle and manure is removed at its end [262, France 2010].

In insulated buildings (and during summer periods in uninsulated ones) the upper critical temperature of the deep bedding systems, especially when the bedding is fermenting and producing a large amount of heat, may be critical in creating thermoregulatory problems, resulting in heat stress and decreased performance; the heat production will also lead to increased evaporation of water [495, EFSA 2007].

Sections 2.3.1.1, 2.3.1.2, 2.3.1.3 and 2.3.1.4 give technical descriptions of the housing systems commonly applied for sows, weaners and fattening pigs (growers/finishers). Their environmental performances and other characteristics are described and evaluated in Chapter 4. The overview aims to be representative of the applied techniques, but can never be exhaustive given the variation observed in systems and their adapted designs.

2.3.1.1 Housing systems for mating and gestating sows

Sows are housed in different systems depending on the phase of the reproduction cycle. Mating sows are kept in systems which facilitate easy contact between boars and sows. After mating or after pregnancy diagnosis, the sows are usually moved to a separate part of the housing for the period of gestation.

Housing sows in groups or individually in confinement is regulated by 2008/120/EC. In compliance with this Directive, individual housing is permitted for sows and gilts only in the first 4 weeks after service and the last week before the expected time of farrowing. Directive 2008/120/EC also addresses the cases where group housing may have drawbacks, e.g. animals that are particularly aggressive or that are sick or injured may be temporarily kept in individual pens, designed to allow the animal to turn around easily; it also imposes feeding systems for group housing that ensure that each animal can obtain sufficient food even when competitors for the food are present. Directive 2008/120/EC as well gives provisions for continuous solid floors and maximum drainage openings for gilts after service and pregnant sows: at least 0.95 m² per gilt and 1.3 m² per sow must be a continuous solid floor of which a maximum of 15 % is reserved for drainage openings. In addition, the total unobstructed floor area available to each gilt after service and to each sow when gilts and/or sows are kept in groups must be at least 1.64 m² and 2.25 m² respectively. When these animals are kept in groups of fewer than six individuals the unobstructed floor area must be increased by 10 %. When these animals are kept in groups of 40 or more individuals the unobstructed floor area may be decreased by 10 % [158, EC 2008].

Individual housing used to be the most common system within the EU. Individual housing systems generally score better on utilisation of labour. In addition, since individually housed sows are limited in their movement, they are easier to control and there is more tranquillity in the stall, which has a positive effect in the early stages of gestation [202, EAAP 1998]. It is also easier to feed the sows in individual housing, where competition is minimised or negated. On the other hand, housing sows in individual stalls, from the weaning period up to 4 weeks after mating, severely restricts their freedom of movement, causes frustration and does not allow sows to socially interact during a period of the reproductive cycle in which they are highly motivated to do so. In addition, the lack of exercise may cause damage and weakness to limbs and bone strength as a consequence of reduced muscle use, and also reduce cardiovascular competence [494, EFSA 2007]. With the entry into force of the pig welfare Directive (2008/120/EC), individual pens may only coexist along with pens for groups.

Some countries' demands go beyond the EU legislation concerning standards for the protection of pigs. As regards the minimum unobstructed floor space, which depends on group size, in Austria, Germany, Denmark, Sweden, Finland and the Netherlands, the minimum unobstructed floor space requirement per gilt is greater than that required by the EU legislation. Extra demands for sows in groups exist in Denmark and Sweden while Germany and Austria have limited additional requirements. The requirements for continuous solid floor space is greater for most pigs and the maximum drainage opening is smaller in Denmark and in the Netherlands than mentioned in the EU Directive. As regards the group housing of pregnant sows and gilts, in the UK non-lactating sows should be kept in groups and there is no exception for 4 weeks after service, while in Sweden sows and gilts should always be housed in groups (except farrowing sows and sows 1 week before farrowing); in the Netherlands sows and gilts should be kept in groups starting from four days after service until 1 week before farrowing [201, Mul M. et al 2010].

In the UK, certified programmes, mainly promoting and ensuring the production of quality food (farm assurance standards), can impose increased space allowances for animal welfare purposes [419, Red Tractor 2011]. In the UK, 85 % of mating sows are group-housed and more than 55 % of mating sows have access to straw, as a result of British welfare legislation requiring all sows to be loose-housed from weaning to farrowing by 1999. In Poland, production on solid floor with bedding is also commonly applied. In the Czech Republic, dry sows awaiting mating and gestation are kept in yards [264, Loyon et al. 2010].

In general, partly slatted floors are commonly applied throughout Europe, whereas fully slatted floors are only used in some Member States (e.g. France, Belgium). The slurry is either stored in deep pits or it is removed frequently by a vacuum system; other systems like flushing channels are only rarely applied. Scrapers are also used when sows are housed on litter (e.g. Sweden, Denmark, the Czech Republic, Cyprus, Finland) [264, Loyon et al. 2010].

Buildings are generally well insulated, or, less frequently, partly insulated. Open climate housing is rarely applied on IED farms. Heating, whether by electricity or gas/oil, is applied locally above animals to a defined area, otherwise the air entering the house is preheated [264, Loyon et al. 2010].

Only in some Member States (especially Cyprus, Denmark, Germany) is air conditioning or the pretreatment of incoming air to the housing commonly applied. Exhaust air treatment is used in the Netherlands, Belgium, Denmark and Germany but it is hardly used in the other EU Member States [264, Loyon et al. 2010].

2.3.1.1.1 Individual housing with a fully or partly slatted floor for mating and gestating sows

In this type of housing system, mating and gestating sows are kept in individual crates. The crates measure about 2.0–2.1 m × 0.60–0.65 m and the rear end is equipped with concrete or metal slats to collect slurry in a deep pit or shallow channel which is emptied at intervals depending on its capacity. The area the sow is allowed is such that she cannot turn around and excreta are deposited at a fixed location. The partitions of the crates are barred or meshed to allow visual contact but prevent aggression. Natural or mechanical ventilation is applied and sometimes a heating system.

Feeding systems and drinkers are placed at the front end. Feeding may be manual or automatic (one to three times per day) and feed may be given dry or wet. Wet feeding systems can vary from the simple dropping of individual dry rations into water to complex pipeline distribution systems from a central, computer-controlled mixing facility. Sows commonly have a trough which is either individual or shared (four to six sows) to allow the possibility of keeping sows of the same body size or condition in adjacent crates [494, EFSA 2007].

Flooring is most commonly partly slatted, although fully slatted floor systems do occur [494, EFSA 2007]. A central slatted passageway runs between the rows of crates and a concrete-floored one runs on either side of the crates for feeding.

In the mating house, there are pens for housing the boars. These pens are absent in the housing section for gestating sows. Figure 2.8 shows a common design for the mating section, but various other designs are applied to enhance intensive contact between boar and sows. Also, the sows may face the central alley with the troughs placed on the inner side and the slatted area will be at the side corridors (see Figure 2.9).



Source: [678, NSW DPI 2006]

Figure 2.8: Schematic view of a housing design for mating sows

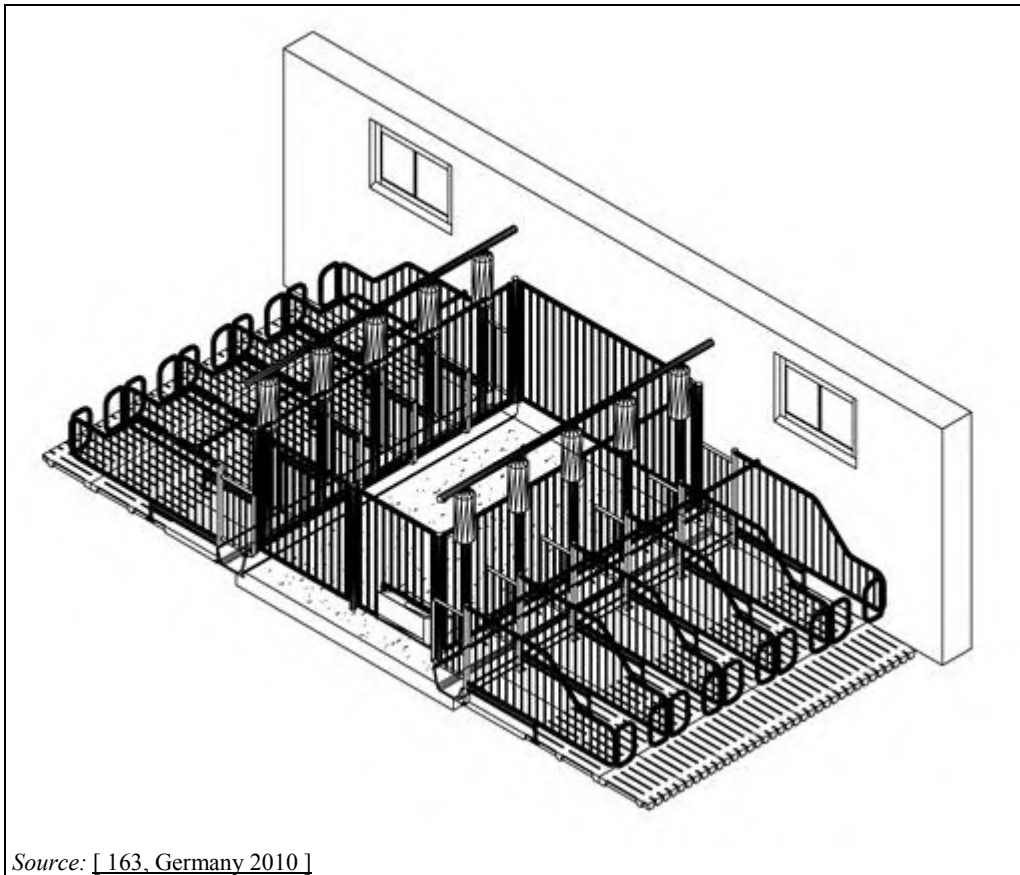

Source: [163, Germany 2010]

Figure 2.9: Individual housing of mating sows (service centre)

2.3.1.1.2 Sow crates with a solid floor for mating and gestating sows

In this system, mating and gestating sows are housed in crates similar to the above design but with a concrete floor often with a layer of straw bedding to produce solid manure or farmyard manure (see Figure 2.10). Again, feeding and watering are applied at the front of the crate. In the central passageway there is a drainage system for the collection and removal of urine. Manure and litter (straw, wood shavings or other where applied) are removed frequently [262, France 2010].

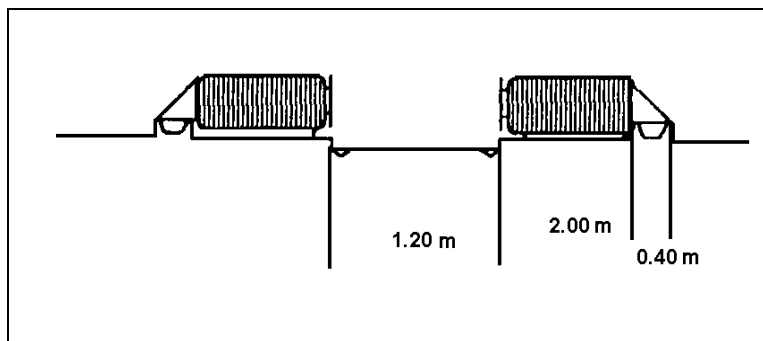

Figure 2.10: Floor design for sow crates with a solid concrete floor for mating and gestating sows

In these systems ventilation is natural when straw is applied, but mechanically driven in insulated buildings where no straw is used.

2.3.1.1.3 Group housing with or without straw for mating and gestating sows

In this housing design, several sows are kept together in enclosed compartments or pens. Individual feeding stalls (0.4–0.5 m × 1.9–2.0 m) can be used to separate the sows temporarily during feeding, preventing dominant individuals from chasing off less dominant sows in order to get access to extra feed rations. The total free space available (excluding feeding stalls) is commonly 2.25–2.8 m² per sow depending on group size. The feeding areas are placed over slatted floors and they can be combined with shared lying (perforated or solid floor with limited use of bedding material) and defecating areas (slatted flooring). Design varies with group size, which is highly variable (e.g. from 5 to 40) [494, EFSA 2007]. An example is shown in Figure 2.11.

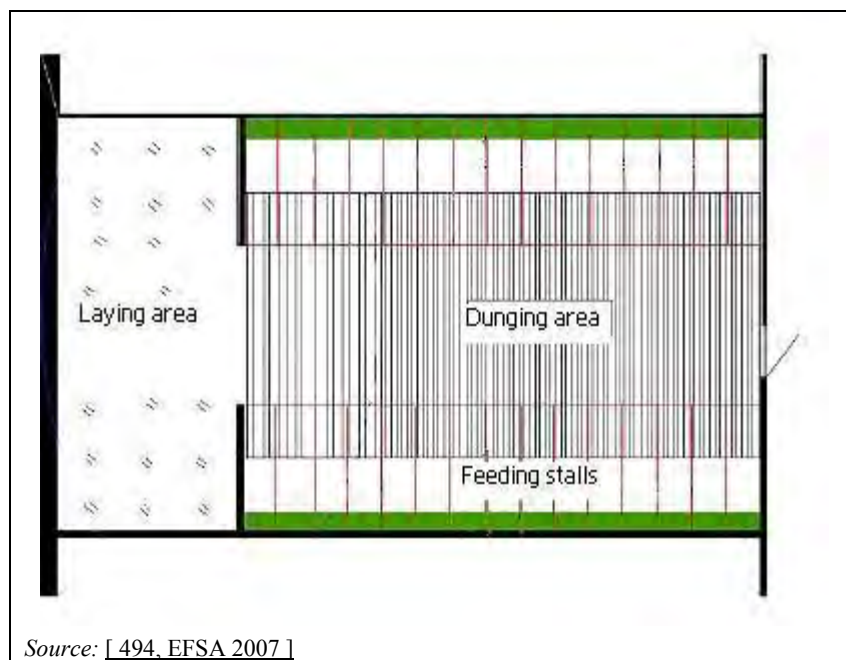

Figure 2.11: Example of a housing system for group housing of gestating sows with individual feeding stalls and shared lying and defecating area

A solid concrete floor with straw bedding in the lying area can also be used to produce solid manure (see Figure 2.12).



Source: [494, EFSA 2007]

Figure 2.12: Example of group housing for gestating sows with individual feeding stalls in combination with full litter

Group housing of pregnant sows in pens with trough or floor feeding without use of individual feeding stalls is also commonly used. Flooring is solid or slatted. Small amounts of bedding material are used on the lying area. Groups are kept stable and small (< 10 animals) in order to reduce aggressive behaviour during feeding. Gilts are less dominant to each other, thus these are more often found in this type of system than older sows [494, EFSA 2007]. A design with a perforated floor in the lying area, is shown in Figure 2.13.

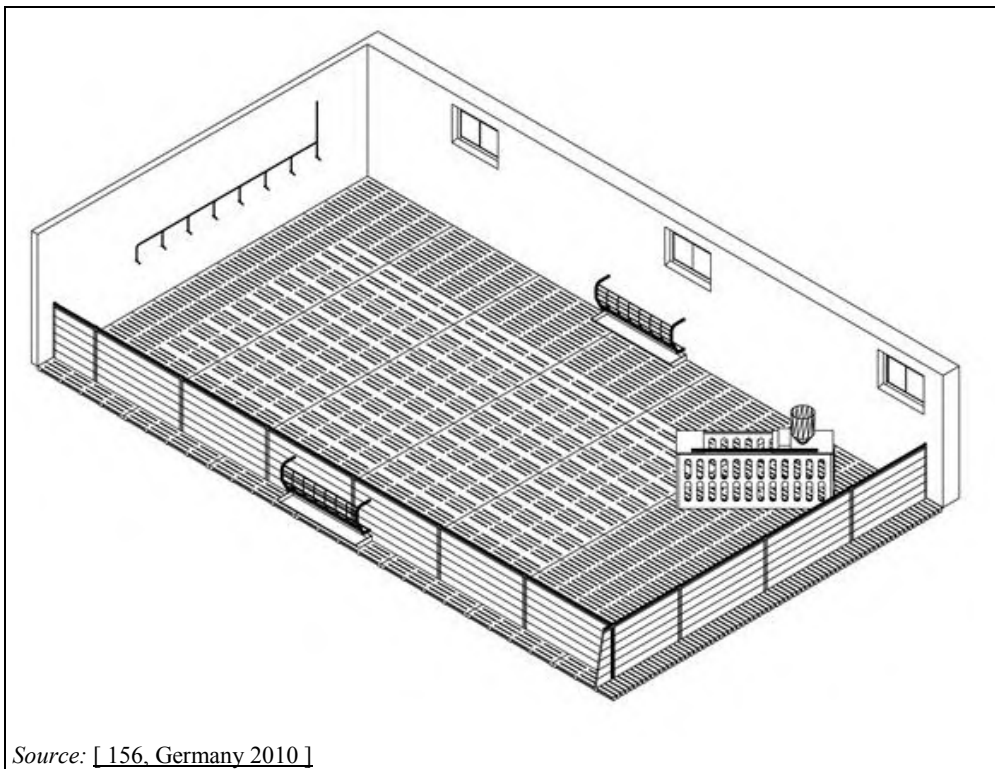

Source: [156, Germany 2010]

Figure 2.13: Example of group housing for mating and gestating sows with perforated lying area (perforation in the lying area < 15 %)

For the ventilation of group housing, the same principles apply as for the individual housing of sows. Natural ventilation is an option in new deep litter housing systems. With the application of straw, heating is generally not applied as at low temperatures the sows are able to compensate by lying amongst the deep litter.

Solid manure is generated and has to be frequently removed in order to prevent the litter from becoming too moist, the frequency of removal depending on the litter type, the depth of the bedded area and on the general farm management practices. In units where bedding is used exclusively for rooting, the amount of litter is limited so that all the manure is handled in the form of slurry. In units with a slatted floor in the defecating and feeding areas, slurry may be emptied using scrapers. In units with solid flooring, the manure is cleaned either daily with scrapers or two to three times a week using a tractor-mounted tyre scraper. In units with deep litter in the lying area, the litter is removed once or twice annually.

2.3.1.1.4 Group housing with electronic feeders

In this system, sows are often kept in large dynamic groups (50–300 sows) with common dunging and lying areas. In the electronic sow feeder systems (ESFs) each sow carries an electronic transponder (ear tag or collar) allowing passage to a feeder station. A precisely measured individual ration of food is then dispensed to that animal which is protected while eating by a specialised feeding stall with gates operated by the sow herself or by the feeding computer. A single feeding station can be shared by up to 70 sows [494, EFSA 2007].

The pen layout is very important to distribute and manage large groups of sows fed this way, since ESFs allow a profit for a reduced space per sow. Indeed, for groups of 40 animals or more, the minimal space is 2.025 m² per sow and 1.476 m² per gilt. Pens have a lying area, a defecating area and a feeding area where electronic sow feeders are placed. The lying areas are on solid concrete floors from which the manure is removed daily by a scraper tractor. Pens can be arranged on concrete slats or on straw.

The version on a slatted floor allows an available surface per sow of 2.20–2.66 m². Short pen divisions may also be used to create boxes approximately two metres long. Stalls or boxes can be laid out at both sides of the corridors which are broad enough to allow two sows to pass each other (see Figure 2.14).

The version with littered pens has a large area of 50–120 m² where sows can lie and which is opposite a feeding and defecating zone. The total surface per sow is between 2.3 m² and 3 m² and the minimal surface of the lying area is 1.2–1.4 m² per sow. Litter is added and removed every 7–10 days in quantities between 200 and 450 kg/sow per year.

The feeding stations have one entrance but may have one or two exits, hence allowing the workers to direct animals to different areas as needed [262, France 2010].

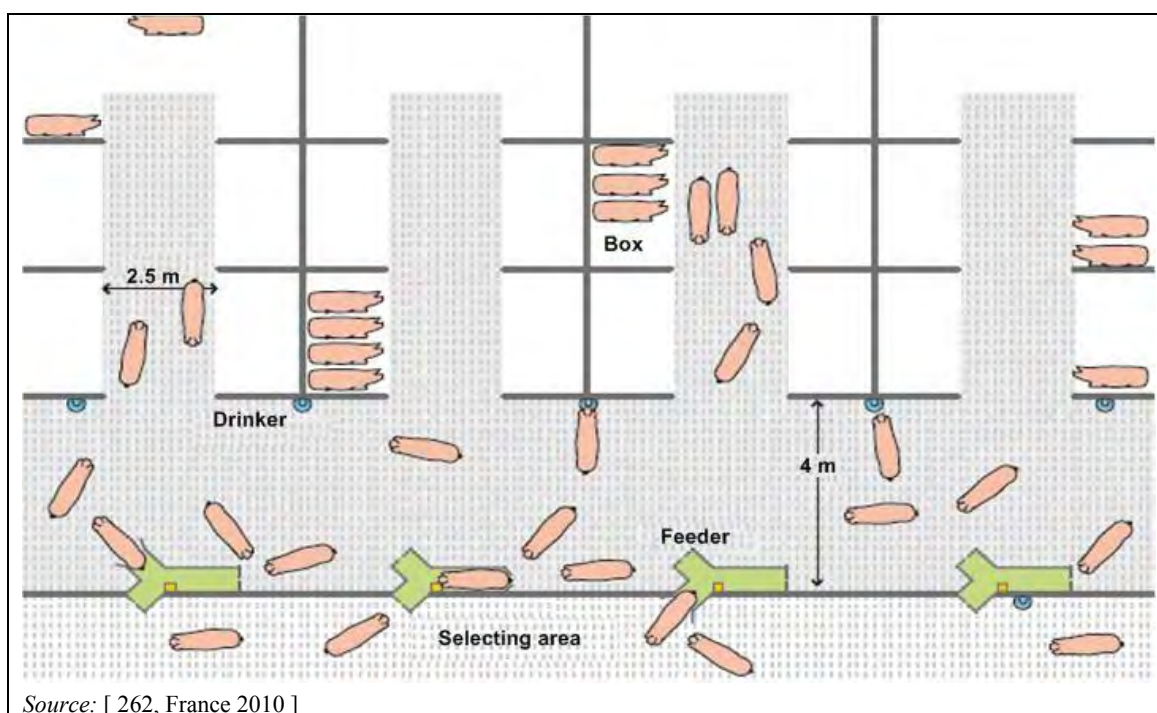

Figure 2.14: Layout of a pen for gestating sows fed with an electronic feeder

2.3.1.2 Housing systems for farrowing sows

Gestating sows are typically moved to farrowing accommodation three to seven days before the expected farrowing date (115 days after service). Sows remain in the farrowing crate or individual pen throughout lactation.

There are different designs of farrowing pens. Flooring can be partly or fully slatted. Bedding is not usually provided. In accordance with Directive 2008/120/EC, in the week before the expected farrowing time sows and gilts must be given suitable nesting material in sufficient quantity unless it is not technically feasible for the slurry system used in the establishment.

The sows are often confined in their movement by farrowing crates, but loose-housing is also applied. For example, straw-based and loose-housing can be found in the UK. In some Member States, the use of farrowing crates is restricted to a limited period around the time of farrowing. However, in the EU as a whole, the use of farrowing crates throughout lactation is the predominant system [494, EFSA 2007]. In accordance with the provisions of Directive 2008/120/EC, farrowing pens where sows are kept loose must have some means of protecting the piglets, such as farrowing rails. Where a farrowing crate is used, the piglets must have sufficient space to be able to be suckled without difficulty.

Fully slatted flooring is applied widely in the EU, as it is considered to be more hygienic and labour efficient than partly slatted or solid floors. In France, 93.6 % of the total capacity for sows are housed on fully slatted floors [262, France 2010]. Danish information indicates that partly slatted floor systems are more energy-efficient and a gradual increase in these systems is being observed.

Some general features of farrowing compartments are:

- applied minimum room temperature of 18 °C;
- temperature for the sows of 16-18 °C;
- distinct safe lying area for piglets with a temperature of about 33 °C at the start of their lives;
- low airflow, in particular in the piglet area.

2.3.1.2.1 Housing for farrowing sows with confined movement

The use of farrowing crates for this period predominates. These crates, typically 2.1 m × 0.9 m in size, are designed to restrict the movement of the sow and are placed centrally or offset in a pen which has a specialised provision for the piglets. Pen sizes measure 4–5 m².

In order to allow all in - all out production, farrowing rooms often contain a complete farrowing batch in one air space; this number can be up to 50–60 sows. Use of crates which can be opened out in such a way to allow the sow to move around more freely, including a full 360 degree turn, while still protecting the piglets from being crushed, is increasing.

Piglets are housed in these systems until weaning, after which they are sold or reared in rearing pens (weaner housing). The floor can be fully or partly slatted. The lying area for the piglets is usually not slatted. Slats made of plastic or plastic-coated metal are increasingly used instead of concrete, as they are considered to be more comfortable. The design of the system can vary in the position of the piglet area and the applied slats.

The slurry is stored under the slatted floor of the crates either in a shallow manure pit, in which case it is removed frequently via a central system in the building, or in a deep pit, from where it is removed only at the end of the lactating period or less frequently. A cross section of a typical pen system for farrowing sows is shown in Figure 2.15.

There is a specific area for the piglets (the 'creep area'), usually positioned in the central alley (for easier observation) between the pens. This area is generally not slatted and is heated during the first days after birth by using a hanging lamp, a heat pad, by warming the floor or it may be an enclosed area to maintain a higher temperature. The sow's movement is limited to prevent crushing the piglets.

Forced or natural ventilation is applied in such a way that the airflow will not disturb the climate at the floor level around sow and piglets and the different requirements for indoor environment conditions for sows and piglets are both met. In modern closed housing, fully automatic climate control is applied, thereby maintaining the temperature and humidity in the farrowing section at a constant level.

The position of the sow is often as pictured in Figure 2.15, but the crates may also be reversed with the sows facing the alley. In practice, some farmers have observed that this position makes the sows more relaxed, as they can more easily notice movements in the alley, whereas in the other position they cannot turn, which makes them more restless.

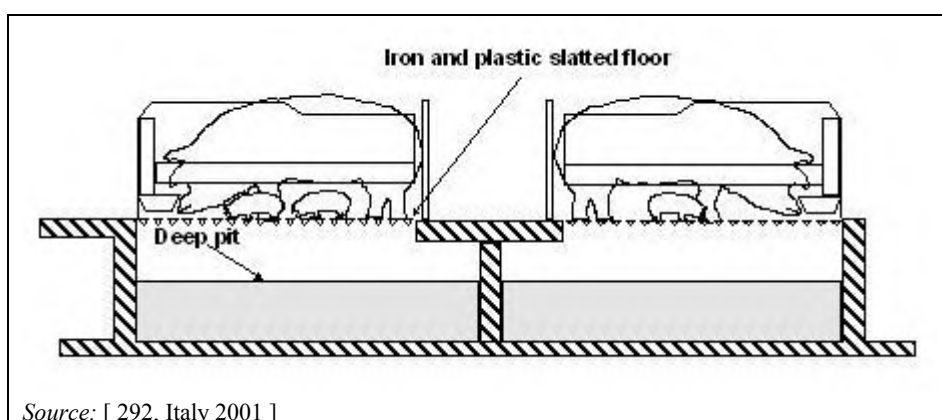

Figure 2.15: Example of confined housing of farrowing sows on a fully slatted floor with a storage pit underneath

2.3.1.2.2 Housing of farrowing sows allowing sow movement

Farrowing sows are housed without being confined in their movement in systems with partly slatted floors. A separate lying area for the piglets prevents them from being crushed by the sow. This design requires more space than the design with restricted sow movement and needs more frequent cleaning. The number of pens or sows per compartment is generally less than 10.

The use of individual pens for the farrowing sow and piglets is common in Member States where farrowing crates are no longer allowed. These may be simple pens of approximately 2.0 m × 3.0 m with anti-crushing rails around the walls and a heated creep area for the piglets (see Figure 2.16) [494, EFSA 2007]. In Sweden, for example, farrowing pens must have a continuous solid floor area of at least 3 m², a total floor area of at least 6 m² and the farrowing pens should be constructed in such a manner as to allow nesting behaviour [201, Mul M. et al 2010].

Beneath the slatted flooring, scrapers or liquid manure systems are used. The type of manure handling system influences the possibility to use straw during farrowing. These pens sometimes contain a temporary crate structure made by moving a partition into place at the time of farrowing (see Figure 2.16); this reduces the total space available when the sow is loose [494, EFSA 2007]. Temporary confinement of the sow can last up to seven days.

Material for the floor system and heating and ventilation requirements for the sow and piglets are the same than for confined movement. With loose sow housing, the walls of the pen are slightly higher than for the pen with restricted movement.



NB: Left: Farrowing pen with anti-crush rails. Right: Farrowing pen with gates that can be used for temporary confinement of the sow

Source: [494, EFSA 2007]

Figure 2.16: Farrowing pens allowing sow movement

Indoor group farrowing systems are in use in commercial practice but only to a small extent. These systems operate very differently compared to conventional ones. Five to ten sows are kept in groups where each sow has access to an individual farrowing nest and a communal resting area, often on deep straw bedding. In this system, the sows are moved to the big pen some days before farrowing and along the walls a cubicle is put up for each sow. There are no rails, creep area or heat lamp in the cubicle as it can distort the interaction between the sow and piglets during the nest phase. The nest boxes are taken out when the piglets have left the nest, usually 10 to 14 days after farrowing. Sows and piglets are then grouped in a ‘multisuckling’ system in the deep bedded system until weaning. Group housing systems for farrowing sows are reported to be in use in farms in Sweden [494, EFSA 2007].

2.3.1.3 Housing systems for weaners

After weaning, the sow is returned to service accommodation and the piglets are commonly moved immediately to the weaner accommodation. Piglets are typically weaned at 4 weeks and up to 6 weeks of age. In accordance with Directive 2008/120/EC, no piglets shall be weaned from the sow at less than 28 days of age, unless the welfare or health of the sow or the piglets would otherwise be adversely affected. However, piglets may be weaned up to seven days earlier if they are moved into specialised houses which first need to be emptied and thoroughly cleaned and disinfected before the introduction of a new group. Furthermore, these houses have to be kept separate from houses where sows are kept, in order to minimise the transmission of diseases to the piglets.

Weaners are commonly reared up to 30 kg live weight (range from 20 kg to 35 kg) in groups of varying sizes. Rearing is commonly done in groups of less than 20 animals, such as in small groups of the same litter (8–12 pigs per pen), but group sizes of up to 100 animals consisting of more litters are also common. According to the provisions of Directive 2008/120/EC, the minimum unobstructed floor space available per weaner in the pen must be at least 0.15 m² for a live weight of less than 10 kg, 0.20 m² for a live weight between 10 kg and 20 kg, 0.30 m² for a live weight of more than 20 kg but less than 30 kg and 0.4 m² for a live weight of more than 30 kg [158, EC 2008].

Weaners may be moved from the first stage weaner accommodation to a larger, second stage accommodation after 2–4 weeks or remain in the same pen until the age of about 9–10 weeks or, in a few instances, until slaughter [495, EFSA 2007].

A variety of housing systems are used. Weaners are typically reared either in conventional pens with partly or fully slatted floors or in flat decks (raised pens). Housing of weaners on fully or partly slatted floors is very similar to the housing of fattening pigs (growers/finishers).

The fully slatted flooring is favoured for hygiene reasons as it separates piglets from their faeces and urine (Figure 2.17). However, fully slatted floors are not easily compatible with straw or other rooting materials.

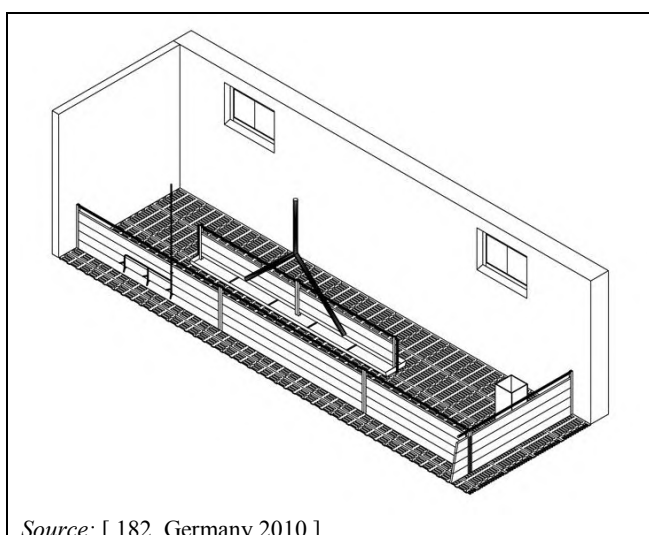

Figure 2.17: Schematic picture of a fully slatted floor pen for weaners

Partly slatted floors are mainly used in Poland, the Czech Republic, Sweden, Denmark and Estonia [264, Loyon et al. 2010]. Partly slatted floor designs are applied to add comfort areas with heated spaces (see Figure 2.18). Pens with partly slatted floors may require more space allowance than fully slatted floors as they need to provide enough space for pigs to be able to

maintain separate and distinct lying and defecating areas, so that the solid portion of the floor and the pigs can be kept clean [495, EFSA 2007]. In the partly slatted design, a covered lying area can be applied, which can be removed or lifted once the pigs have grown and need more ventilation.

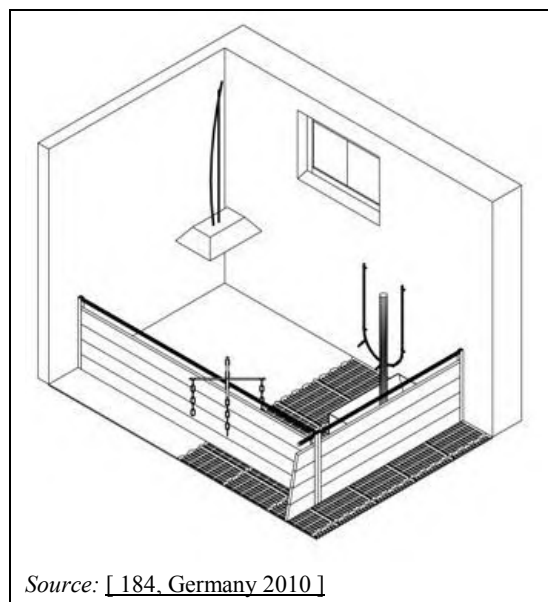

Figure 2.18: Schematic picture of a weaner pen with a partly slatted floor

A special housing design for weaners is the use of flat decks that are intended to provide controlled environment housing. It originally comprised a low, well-insulated building with a linked heating and ventilation system to maintain temperature at any desired level. Each house contains several pens with fully slatted floors above a slurry channel. The pen floor level was originally raised (in comparison to that of the passage floor), but more recent designs have passages and pen floors at the same level. The system has evolved over the years and the term is now often used to loosely describe any slurry-based housing system for weaners [636, Ramiran 2011].

Systems with a solid floor and bedding are also used in countries such as Poland, the UK, Austria, Sweden, the Czech Republic, Italy, Germany and Estonia [264, Loyon et al. 2010]. The use of solid floors with deep litter is increasing in the UK and is anticipated to become more widespread in the future because of animal welfare concerns. Nevertheless, solid manure on a solid floor may compromise pig gut health due to increased exposure to microorganisms.

Weaners are typically housed in highly controlled environments with supplementary heating. Room temperatures are maintained in the range of 28–30 °C for the first few days after weaning and are then reduced as the weaners grow (non-bedded systems). Heating is applied in the form of gas radiant heaters, electric fan or convection heaters or by a central heating plant with heating pipes. Heating systems may also use recovered ground and/or air source heat.

The housing is equipped with mechanical ventilation, either a negative pressure or balanced pressure type. Ventilation is almost exclusively provided by extractor fans. Typically, air is drawn into each room through inlets in one end of the room from an access passageway common to a group of flat deck rooms. Inlet air might be preheated, as necessary, by automatically controlled heaters. Extractor fans, normally situated in the opposite wall, are intended to create air movements across the room, and radiant heaters above the pens (or underfloor heating) may be used to provide additional temperature/comfort control.

Weaners are typically fed *ad libitum* (dry) or restricted (liquid) with an animal to feeder space ratio of 1 : 1 to 12 : 1, depending on the feeding system [495, EFSA 2007].

Manure is handled in the form of slurry and is mainly drained through a pipe discharge, where the individual sections of the manure channels are emptied via plugs in the pipes. The channels can also be drained via sluice gates. The channels are cleaned after the removal of each group of pigs, often in connection with the cleaning of the pens, i.e. at intervals of 6 to 8 weeks. For the storage and removal of slurry, deep pit and frequent removal by vacuum systems are the most commonly applied techniques. Manure removal by scraper is also used [264, Loyon et al. 2010].

2.3.1.4 Housing of fattening pigs

From an average live weight of 30 kg (20–35 kg), pigs are moved to separate sections to be grown and finished for slaughter. It is common to use two (or three) housing stages with larger pens at each stage in the fattening period, to make the most efficient use of space, but the housing facilities are very much the same (i.e. one-phase up to 110–120 kg, two-phase with a grower period up to 40–60 kg and a finisher period from 40–60 kg to 110–120 kg; Italy: 150–170 kg). Slaughter weights may be lower (e.g. in the UK: 90 kg) in countries where male pigs are not castrated after birth [495, EFSA 2007].

There are many different construction techniques for the fattening housing such as insulated concrete, composite panels, insulated brick, etc. Buildings are, in general, well insulated and may have supplementary heating (depending on the prevailing weather conditions). Heating is mostly provided by electricity, gas or oil and sometimes by a mixture of all sources of energy. Wood, straw and other renewable sources are also used as a fuel, especially in Nordic countries. Ventilation can be natural or forced which is the main option in nearly all countries. Nonetheless, the use of controlled natural ventilation is also important in some countries, including Italy, Germany, Cyprus, Poland, Portugal and France. In Spain, Finland and Denmark, air conditioning is commonly applied. Ventilation with pretreated air is used in Spain, Poland and Denmark [264, Loyon et al. 2010].

The number of pigs per house can range from a few to thousands [624, IRPP TWG 2013]. The house is usually divided into compartments for 10–15 pigs (small groups); however, the number of fattening pig houses with large group sizes is increasing (24 pigs up to 40 or more). The pens are arranged either with the aisle on one side or in a double row with the aisle in the centre. In the pens with a solid concrete floor, movable covers can be used to cover the lying area, at least during the first stage of the growing period.

Feed distribution is usually automated to sensor-controlled feeders, adjusted to the respective growing phase of the pigs. Liquid or dry feeding is applied *ad libitum* or may be restricted in the latter stages to prevent excessive fatness or with very heavy slaughter weights (> 120 kg). The design of feeding troughs and drinkers depends on the type of feeding.

Accommodation for fattening pigs may be fully slatted, partly slatted, litter-based with a scraped defecating area or deep bedded with straw or sawdust. Although there are national differences, housing with fully or partly slatted flooring (typically on concrete slats with 17 mm slot spacing) with a pen floor area of 0.7 m² at the end of the finishing period predominates within the EU. The recommended common temperature range for buildings with non-bedded perforated floors is 20–26 °C [495, EFSA 2007].

Partly slatted floors are mostly used in countries such as the Netherlands, the Czech Republic and Denmark. In Ireland, France and Germany fully slatted floors prevail and in Spain both types of floor are used with the proportion of slatted to solid floor being 60 : 40. In Belgium, fully slatted floors are prevalent in old housing or in new houses equipped with a chemical scrubbing system. In the UK, straw bedding is common. Both systems for the storage of slurry are common: underground deep pit and frequent removal by channel systems [264, Loyon et al. 2010].

2.3.1.4.1 Housing of fattening pigs on a fully slatted floor

Housing systems with fully slatted floors are widely used throughout the EU. In these systems, slats cover the entire pen area, usually to maintain hygiene and cleanliness by allowing for a quick removal of faeces and urine from the immediate environment of the animal, and thus favouring the conditions for a dry lying area. In addition, slatted floors are generally associated with lower airborne toxin concentrations than litter-based systems due to the potential bacterial contamination of straw and other litter materials.

Slatted floors should have a sufficient perforation in order to keep the pen clean of manure and urine; on the other hand, the gap between slats should not endanger the animals, in accordance with Directive 2008/120/EC.

The fully slatted floor housing system is very common for small groups (10–15) pigs and large groups (up to 24) of fattening pigs (growers/finishers). It is applied in closed, thermally insulated housing with mechanical ventilation, as well as in houses with natural ventilation. Windows allow daylight in, but electric lighting is also used. Auxiliary heating is applied only when necessary, as the pigs' body heat is usually capable of satisfying the heat requirement.

The pen is fully slatted and has no physical separation of the lying, eating and defecating areas. The slats are made of concrete or (plastic-coated) metal. Urine mixes with the manure or runs off through urine/liquid manure channels. The slurry is collected in a manure pit under the fully slatted floor. Depending on the depth of the pit, it may provide for an extended indoor storage period (thus high ammonia levels in the house) or it is emptied frequently and the slurry is stored in a separate storage facility. A frequently applied system has the individual sections connected by a central drain, into which they are emptied by lifting a plug or a gate in the pipe.

Point 4 of Annex I, Chapter I of the Directive 2008/120/EC concerning the welfare of pigs, states that 'pigs must have permanent access to a sufficient quantity of material to enable proper investigation and manipulation activities, such as straw, hay, wood, sawdust, peat or a mixture of such, which does not compromise the health of the animals'; the provision of such material may be somewhat difficult in the case of housing systems with fully slatted floors [158, EC 2008]. A Scientific Opinion issued by EFSA concludes that 'stocking density, associated with lack of enrichment and fully slatted floors, is a significant risk for tail biting'. Tail biting may cause very poor welfare, and tail docking is likely to be painful [495, EFSA 2007]. Careful management and design can fulfil the pigs' behavioural needs, therefore avoiding routine tail docking. In slatted floor systems, enrichment material (i.e. straw, hay) can be provided in feeders or racks [624, IRPP TWG 2013]. However, as the problem of tail biting is mainly multi-factorial, other parameters (e.g. poor indoor air quality) also have to be considered [495, EFSA 2007].

2.3.1.4.2 Housing of fattening pigs on a partly slatted floor

Partly slatted floor systems are applied in similar buildings to those used for fully slatted floor systems. The floor is divided into a slatted and a solid/non-slatted section. There are basically two options: to have the solid concrete floor on one side or in the centre of the pen. The solid part can be flat (see Figure 2.19), convex (see Figure 2.20) or slightly inclined (see description below).

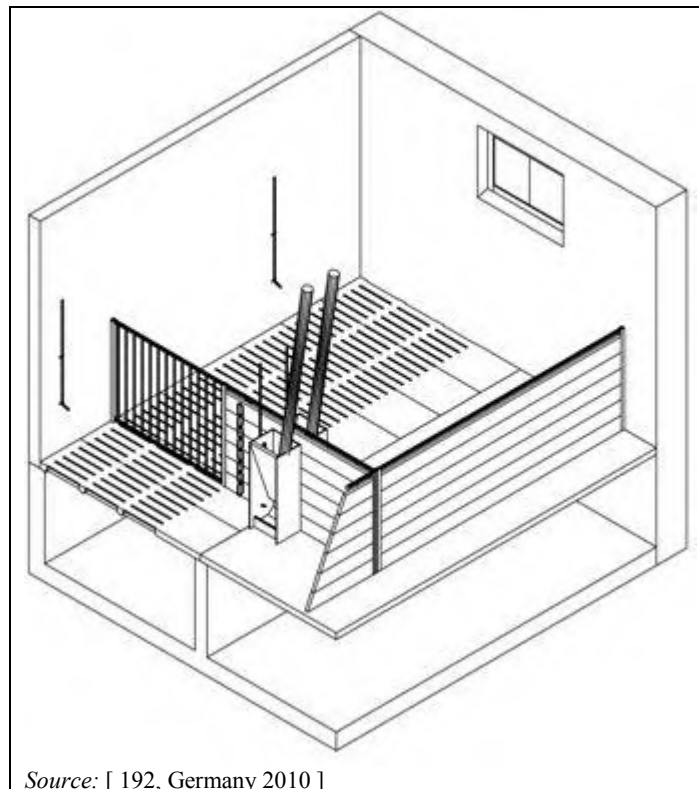

Source: [192, Germany 2010]

Figure 2.19: Design of a partly slatted floor system for fattening pigs

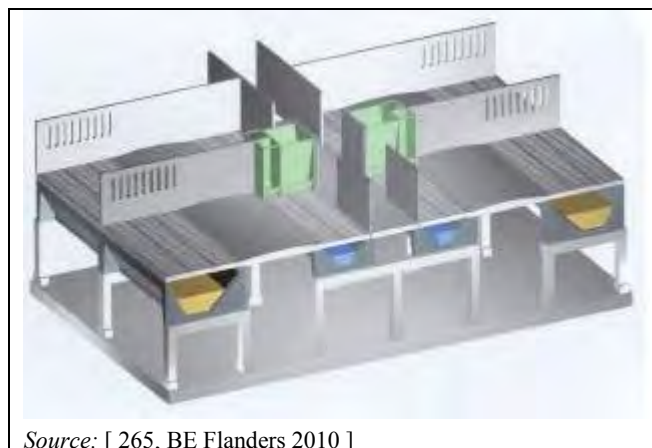

Source: [265, BE Flanders 2010]

Figure 2.20: Pen design for fattening pigs with partly slatted (convex) floor and solid area in the centre

The solid part usually functions as a feeding and resting place and the slatted part of the pen is designed to be used for defecating. Generally, partly slatted floor systems, preferably with a raised level of the slatted part, allow for a fairly good supply of straw [495, EFSA 2007]. Slurry is collected in a channel or pit beneath the slatted part of the floor.

In another pen layout, restricted amounts of straw are applied in the partly slatted pen designed with a concrete floor and one slatted area (solid/slatted: 2 : 1). Straw is given in straw racks that are filled manually, and from which the pigs take the straw in themselves. The solid floor has a slight incline (a slope of 5–7 %) to the dunging area, slurry and straw are moved towards the slats by the pigs' activity; therefore, this system is also called a straw flow system.

A partly slatted design is applied in Italy with a solid concrete floor and an external slatted alley adjacent to a manure channel (see Figure 2.21). In each pen, the pigs have their housing and

feeding area inside the building, but an opening with a shutter allows them to reach the external defecating area with the slatted floor. The pig activity moves the manure through the slats into the manure channel, which is emptied once or twice a day with a scraper. The manure channel runs parallel to the pig building and is connected with a slurry storage facility. This system is also used for mating and gestating sows in group housing.

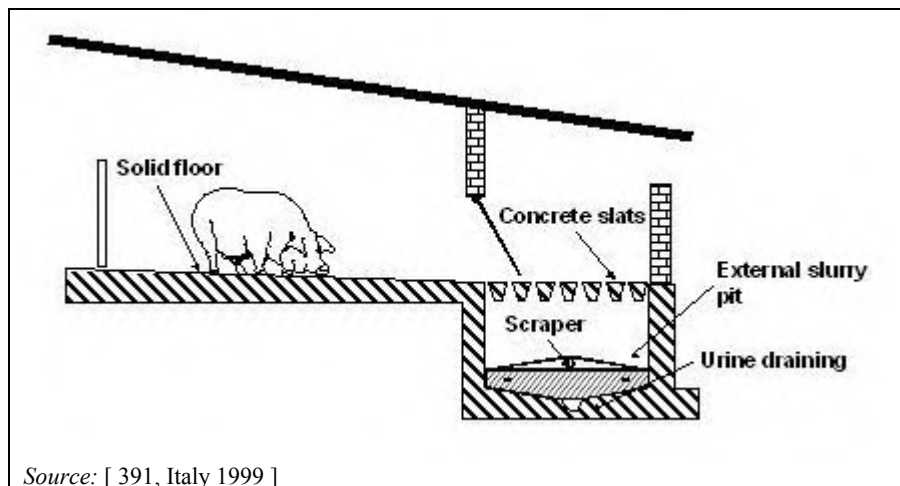

Figure 2.21: Solid concrete floor with slatted external alley and scraper underneath

Partly slatted flooring, if correctly designed and well-drained, can reduce emissions of ammonia. The ventilation system has to function consistently in order to deliver the appropriate in-house environment for the pigs with the purpose of maintaining the desired lying and defecating areas at all times. If the ventilation system fails to provide the appropriate indoor conditions, dunging and urination may take place on the solid floor area causing it to become fouled and increase emissions.

2.3.1.4.3 Housing of fattening pigs on a solid concrete floor and straw

In the housing systems for fattening pigs with a solid concrete floor, a bedding (> 10–15 cm bedding) with materials such as straw, sawdust, wood chips or a big-bale supply is applied to improve animal welfare. The use of a bedding system demands good facilities for removing the bedding and cleaning/disinfecting in a strict batch system. Provision of straw, especially straw of poor quality, and the use of wood chips and sawdust, will increase the production of airborne particles such as dust, moulds and fungi associated with respiratory disturbances in pigs and humans [495, EFSA 2007].

These systems are applied in closed buildings or in open-front houses. The open-front designs are equipped with wind barriers (netting or spaceboards), but straw bales are also used for insulation and for protection against the wind.

Pen designs can vary, but usually there is a lying area with straw and a feeding area, which may be elevated and accessible by steps (see Figure 2.22). The lying area may be covered. The pens may be positioned on one side of the building or on either side of a central aisle. Defecation takes place in the littered area. Mucking out and cleaning are usually done with a tractor-mounted front-end loader after each batch. Group size may range from 35–40 up to 250 pigs. The area provided per grower is usually 0.5 m² and per finishing pig is 1.0–1.2 m².

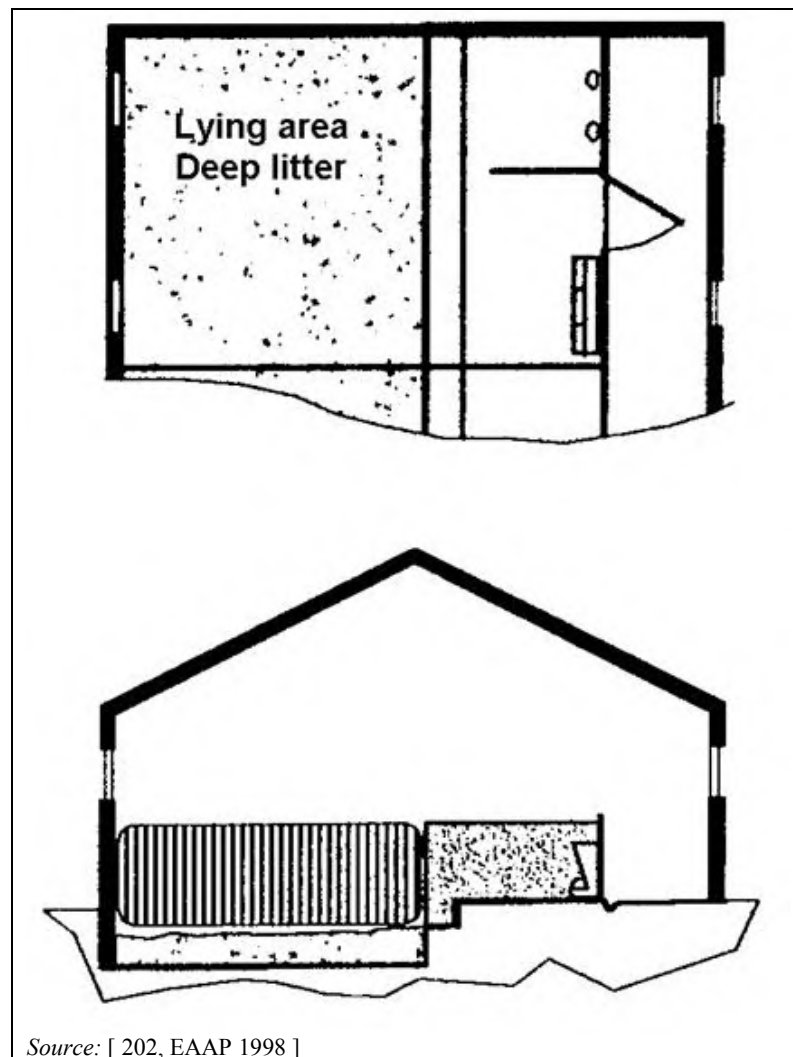

Figure 2.22: An example of a solid concrete floor system for fattening pigs

In Italy, the bedded area is a littered external alley, which is similar to the design with slatted floor in the external alley (see Figure 2.23). The indoor pen area is used for lying and feeding and has very little or no straw. The outside defecation area is littered and connected with a manure channel. Manure and straw are moved into the channel by the pigs' activity. Manure is removed once or twice daily by a drag chain or a scraper to outside manure storage.

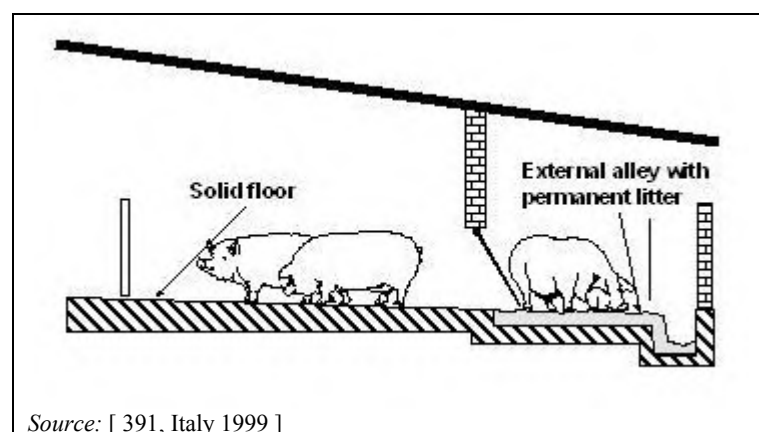

Figure 2.23: Solid concrete floor with external littered alley and manure channel

The technique may take place with a wide variation of pen designs and manure management systems. Examples of litter management, as reported by France, are detailed in Table 2.8.

Table 2.8: Manure and bedding management in litter-based systems for fattening pigs in France (from 30 kg to 115 kg live weight)

Litter management	Building features and management of bedding and manure	Surface (m ² /pig)	Bedding use (kg/pig/cycle)	Manure generation (kg/pig/cycle)
Deep litter (straw)	- Raised bedded area and feeding platform - Straw provision at cycle start-up - Fresh straw addition over the accumulated manure: 2 to 3 times per week - Manure removal at end of cycle	1.3	70 (50–80)	200–300
Littered floor	- Straw in lying area, scraper in the corridor and feeding platform - Removal of manure and fresh straw addition: 2 to 3 times per week	1.0	45 (30–50)	NI
Deep litter (deep sawdust bedding)	- Raised bedded area and feeding platform - Bedding of 60–70 cm used for few batches - Only the surface layer is removed at the end of each cycle. Bedding used for several cycles	1.2	50–60	NI
Deep litter (thin sawdust bedding)	- Bedding of 20 cm at cycle start-up - No sawdust added during the cycle - Manure removal at end of cycle	1.3	20–40 (90 % DM)	100–200 (30–40 % DM)
NB: NI = no information provided; DM = dry matter. Source: [420, Ramonet 2003] [262, France 2010]				

Littered systems in the UK use 30–60 kg of straw/pig/cycle while deep litter systems use 50–120 kg of straw/pig/cycle [624, IRPP TWG 2013]. From Belgium-Wallonia a requirement of 80 kg of sawdust/pig/cycle is reported for systems applying a deep sawdust bedding, and an associated average manure generation of 123 kg/pig/cycle [567, Nicks B. 2004].

2.3.2 Control of indoor environment in pig housing systems

The indoor environment of the pig housing systems has to be adequately controlled to ensure:

- the evacuation of harmful gases (CO₂, CH₄, NH₃), whilst providing oxygen necessary for the breathing of the animals;
- maintenance of adequate humidity and temperature adapted to the physiological stage of the animal rearing, to ensure a good performance, in good health and without behavioural disorders.

The indoor climate in pig housing systems is important, as ammonia, combined with dust, is known to be a frequent cause of pig respiratory diseases, including atrophic rhinitis and enzootic pneumonia. Since workers can also be subject to respiratory health issues it is doubly important that pig housing is sufficiently ventilated.

Minimum (qualitative) requirements are laid down in Directive 2008/120/EC, including the control of the pig housing climate [158, EC 2008]. Temperature and humidity of air, dust levels, air circulation and gas concentrations must be below harmful levels. For example, the limit value concentrations shown in Table 2.9 are advised, but these values vary between MS. A good indoor environment can be achieved by insulation of the buildings, heating, ventilation, and pen layout and construction.

Table 2.9: General indicative levels of indoor environment for pigs

Indoor environment factor	Level/occurrence
CO	Below measurable value
H ₂ S	Below measurable value
Relative humidity	Pigs up to 25 kg: 60–80 % Pigs 25 kg upwards: 50–60 %
NH ₃	Maximum 10 ppm
Air velocity	Farrowing pens and weaners: < 0.15 m/s Mating and gestating sows: < 0.20 m/s
CO ₂	Maximum 0.20 vol-%
<i>Source:</i> [44, IKC 1993]	

The performance of the applied system is affected by:

- design and construction of the building;
- position of the building in relation to wind directions and surrounding objects;
- application of control systems;
- number, age and production stage of the pigs in the housing.

Insulation can be applied to reduce heat losses through walls, the ground and the roof by interposition of layers of materials that slow down the transfer of heat in and out of the building. Different degrees of insulation are achieved by various materials. Two coefficients are generally used to define this insulation: the coefficient of thermal conductivity (λ) and the heat transfer coefficient (U), which is the coefficient most commonly used and is expressed in W/m² per °C [345, France 2010].

In the case of forced ventilated buildings under negative pressure, the building must be as airtight as possible. It is important to regularly verify the air sealing of doors and windows, and that neither water condensation on walls nor undesired air draughts occur. In the case of undesirable airflow, openings are usually sealed by polyurethane foam spraying. Height, positioning and number of pens across the room, as well as properly designed pen divisions (solid or open to allow air movement) to match the ventilation system, are all important considerations for designers and operators if the optimum living environment and the lowest emissions possible by the housing system are to be delivered.

Treatments may be applied to incoming air (mainly for animal welfare reasons), primarily dust removal, cooling and/or humidification [264, Loyon et al. 2010].

The combination of heating and ventilation constitutes the crucial factor in indoor environment management. Each of the two factors has an antagonistic action on the other, hence the best compromise has to be determined.

2.3.2.1 Heating of pig housing

The need for temperature control in pig housing depends on the climatic conditions, construction of the building and the stage of production of the animals (see Table 2.10). In general, in colder climates or climates with periods of low temperatures, buildings are insulated and equipped with mechanical ventilation. In warmer regions (Mediterranean latitudes), high temperatures have a greater influence on the welfare and productivity of adult pigs than low temperatures. Usually there is no need to install heating systems; the animal body heat is generally sufficient to maintain welfare temperatures within farms. In this context, climate control systems are mainly designed to guarantee good air circulation.

In some housing systems for sows and fattening pigs (growers/finishers), large amounts of straw help the animals to maintain a comfortable temperature. However, the most important factors are live weight, age and production stage. Other factors that affect temperature requirements are:

- individual or group housing;
- flooring system (fully or partly slatted or solid floors) and use of bedding;
- amount of feed (energy) the animals consume;

Table 2.10: Example of temperature requirements in heated housing for different pig categories in healthy conditions

Farrowing pen	Weaned pigs	Mating and gestating sows	Fattening pigs
Room and sow location: up to 20–22 °C	7 kg, up to 25 °C	Mating, up to 20 °C	20 kg, up to 20–22 °C
	10 kg, up to 24 °C	Early gestation, up to 20 °C	30 kg, up to 18 °C
Piglet area: first days after birth, 28–30 °C	15 kg, up to 22 °C	Middle gestation, up to 18 °C	40 kg, up to 16 °C
	20 kg, up to 20 °C	End of gestation, up to 16 °C	50 kg, up to 15 °C
	25 kg, up to 18 °C		
<i>Source: [44, IKC 1993] [261, France 2010]</i>			

Pig housing can be heated by various systems. Heating is applied as zone heating or room heating. Zone heating has the advantage that it is aimed at the place where it is most needed. Systems applied are:

- floors equipped with heating elements;
- heating elements above the pig places radiating heat onto the animals, as well as onto the floor surface.

Room heating is applied by two methods:

- by preheating: incoming air is preheated by leading the air through a central corridor to warm it to a minimum temperature, to reduce temperature fluctuations and to improve air movement in the housing area;
- by post-heating: heating is applied to the air once it has entered the housing area, to reduce temperature fluctuations and to reduce heating costs.

Heating can be direct or indirect. Direct heating is accomplished by applying installations such as:

- gas heat radiators: infrared, gas air heaters and gas-fuelled radiation convectors;
- electric heat radiators: special light bulbs or ceramic radiators;
- electric floor heating: on matting or under the floor;
- floor heating with warm water (water is heated by boilers of various types or by the techniques reported below);
- combined heat and power (CHP) systems;
- heat pumps;
- heat exchangers;
- heaters/blowers.

Indirect heating can be compared to central heating in domestic applications. The installations applied can be:

- standard boilers (efficiency: 50–65 %);
- improved efficiency boilers (improved efficiency: 75 %);
- high efficiency boilers (high efficiency: 90 %).

Boilers can be open or closed design. Open designs use indoor air for the burning process. Closed designs draw air from outside the building and are particularly suitable for dusty areas.

Extra local heating is applied to the piglets during their first weeks. Often, a heating lamp (gas or electric) is installed above the solid (non-slatted) lying area. The lying surface itself can also be heated, by running hot water through tubes or a reservoir underneath the floor surface. Weaners still have temperature requirements that require control of temperature and ventilation. Heating may be required during cold weather. The following heating systems are used: radiating heat lamps, electric heating (thermal bedding with a resistance wire heating) and also hot water heating systems (under the floor or through air ducts).

Heating the housing of fattening pigs is not common, as their body heat is usually sufficient to create a comfortable environment. In pens with growers, removable covers are sometimes applied to create a more comfortable lying area in the early weeks.

2.3.2.2 Ventilation of pig housing

Animal houses have to be ventilated in order to [\[474, VDI 2011 \]](#):

- supply the animals with fresh air;
- dissipate excess heat in order to keep the temperature within the optimal animal-specific range, which depends on age and performance;
- remove gaseous substances and dust;
- avoid damage to buildings due to humidity.

Ventilation systems vary from manually controlled naturally ventilated systems to fully automated mechanically ventilated systems. Two main building and ventilation types are distinguished for animal housing facilities:

- Forced (or mechanical) ventilated housing systems in closed, generally thermally insulated buildings:
 - exhaust ventilation: mechanical ventilation under negative pressure;
 - pressure ventilation: mechanical ventilation in overpressure;
 - neutral ventilation: mechanical ventilation under equal pressure.
- Natural (or free) ventilated housing systems:
 - manual controlled ventilation;
 - automatically controlled natural ventilation (ACNV).

In animal houses with forced ventilation, fans are responsible for the exchange of indoor and outdoor air. The distribution of air can be accurately adjusted by means of valves, positioning of the fan(s) and the diameter of the air inlets. In contrast, natural ventilation depends on the natural fluctuations of the outside air temperature and on the wind flow (pressure differences) and is attained by openings in the roof and/or sides of the building.

A defined air volume flow can only be reached in animal houses with forced ventilation. In addition, a more even airflow in the housing can be achieved. This is important when considering the application with housing systems, as the interaction between the housing (flooring) system and the ventilation system affects the air currents and temperature gradients in the house. For example, partly slatted floors may combine better with mechanical ventilation than with natural ventilation, whereas with fully slatted floors, natural ventilation may be equally applied.

The volume of the housing area and the air inlet and outlet openings have to correspond to create the required ventilation rate at all times. Irrespective of the production stage and the ventilation system, a draught close to the animals must be avoided. In new farms it is common to apply integrated installations that match heating and ventilation requirements [397, Denmark 2000].

Operators can monitor by computer the ventilation parameters and remotely apply correction measures for precision control. Control parameters may include temperature, relative humidity and carbon dioxide concentration which are monitored by appropriate sensors. Electronic equipment is applied to measure the fan revolutions per minute. A measuring fan in a ventilation tube can be used to measure the air velocity in the tube, which is related to a certain pressure and revolution rate.

The ventilation techniques that are mostly applied in pig housing are described below [44, IKC 1993] [26, Finland 2001].

In buildings with an exhaust ventilation system, fans are used in the side walls or in the roof (see Figure 2.24). Adjustable ventilation openings or vents allow fresh air to be drawn in. Fans expel air outside, usually through the ceiling at one or more points. This creates under-pressure, and creates fresh airflows into the building through the inlets. The fresh air inlets are usually on the wall, close to the ceiling, on the ceiling or on the floor. It is typical in an exhaust ventilation system for the air pressure inside the building to be lower than that outside. Exhaust ventilation works well when it is warm outside, and it is therefore a very popular and appropriate system in countries with warmer climates. On fattening pig farms, heating costs may be relatively low when exhaust ventilation is used, provided that it is properly adjusted.

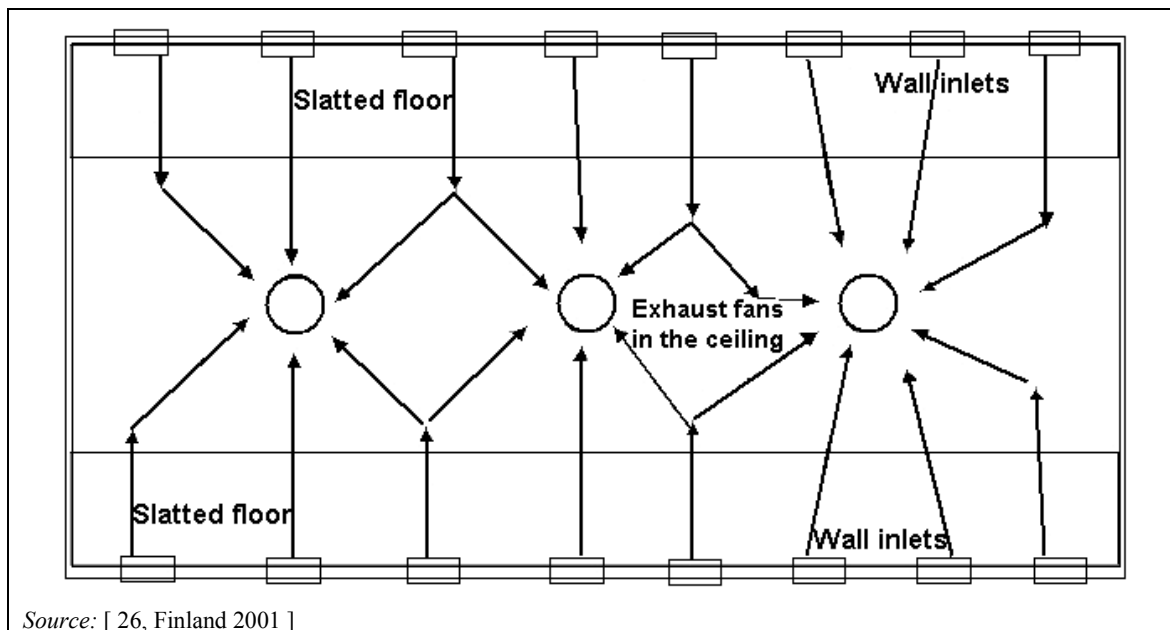

Figure 2.24: Schematic view of airflow in an exhaust ventilation system

In buildings with a pressure ventilation system, fans are used to blow air into the building, which means that the air pressure inside the building is higher than outside. Due to the difference in the pressure, air flows out of the building through outlets (see Figure 2.25).

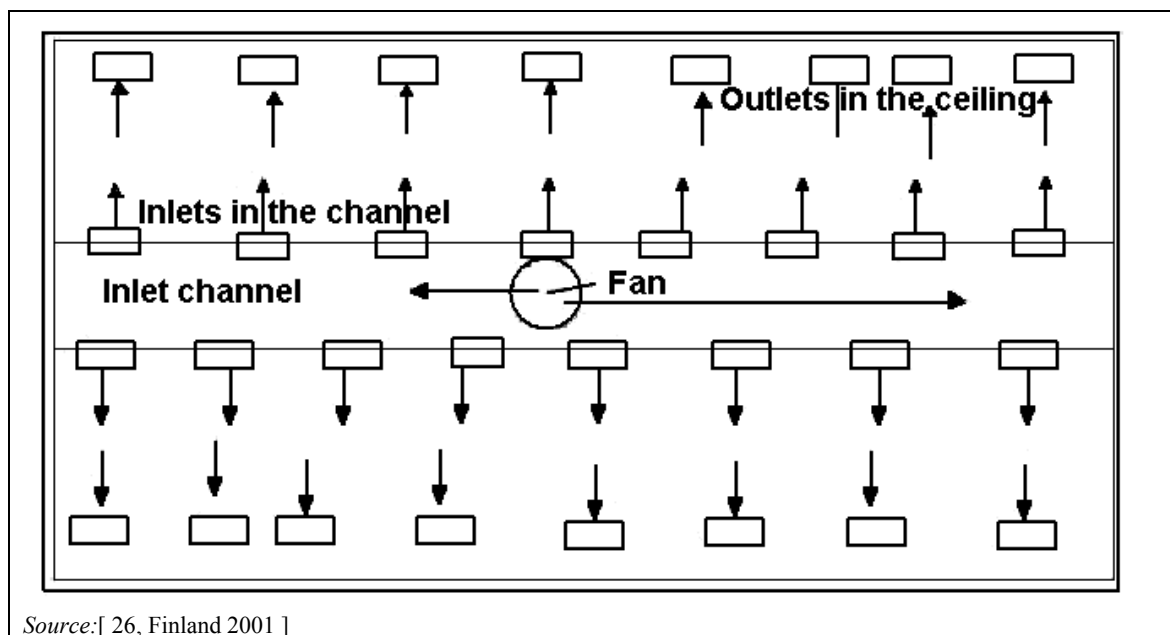
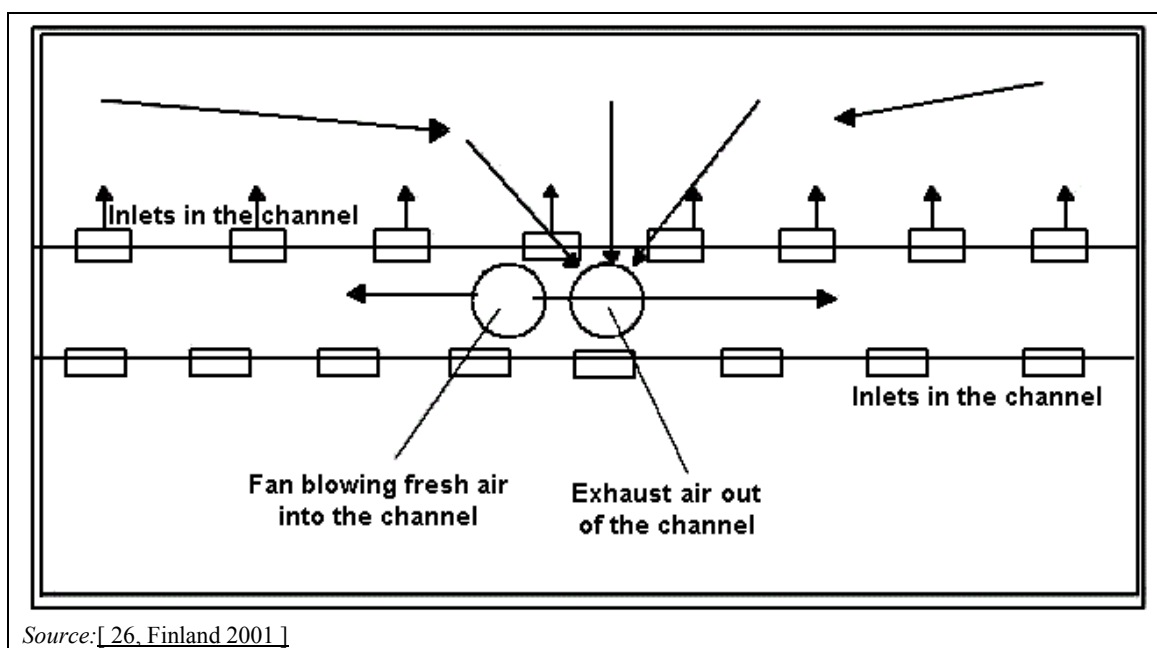

Figure 2.25: Schematic view of airflow in a pressure ventilation system

When using pressure ventilation, the air entering the building can be preheated, and thus part of the heating in the winter can be done by means of ventilation. The main problem in this system is that the airflow is quite uneven when only one blowing point is used. Airflow is rapid and the air is cold close to the fan, but the airflow slows down rapidly when moving further away from the fan. Blowing channels may be used to avoid this problem. Blowing channels are usually placed in the middle of the pig house. In particular, air is blown into a channel, which spreads it throughout the building. The airflow, distribution and direction of the blow are controlled by means of nozzles. Sometimes humidity is a problem, which, due to the higher pressure inside

compared to outside, leads to condensation on the surfaces of the channels when the air is not preheated. This is why pressure ventilation is not very common in colder climates. It is only used in concrete buildings, as the humidity can damage insulating materials and structural timbers.

A neutral ventilation system is a combination of the exhaust and pressure ventilation systems (Figure 2.26). As with exhaust ventilation, the exhaust air is drawn out of the building by means of a fan. However, the replacement air does not flow into the building, because of negative pressure in the building, but air is drawn in through a channel. Thus, the difference between the air pressure inside and outside the building is much smaller than in the case of exhaust or pressure ventilation. In neutral ventilation, a heat exchanger can be used to reduce the need for additional heating. Neutral ventilation uses more energy than exhaust or pressure ventilation, because the air is drawn in and blown out. Investment costs are also higher, as twice as many blowers and blowing channels are needed as for the other systems.



Source: [26, Finland 2001]

Figure 2.26: Schematic view of airflow in a neutral ventilation system

Natural ventilation systems are based on the difference in density and air pressure between warm air and cold air due to wind, temperature and the so-called stack (or chimney) effect that causes warm air to rise and cold air to replace it. The stack effect depends on the relationship between the opening and the position of air inlets and outlets and the inclination of the roof (25 °; 0.46 m per metre stall width). Obviously, the design and construction of the building are very important with natural ventilation. As the effect is based on temperature differences, it is clear that the effect is largest when the ventilation requirement is at its lowest (in winter). In contrast to forced ventilation, no defined air volume flow can be set.

The naturally created negative pressure is relatively small; even in winter in Finland it is reported as less than 20 Pa, and so, in summer, exhaust pressure ventilation is sometimes used to boost the airflow. Thus, combinations of ventilation systems are applied that work alternately, depending on the indoor and outdoor air temperatures. In countries such as the Netherlands, wind is the prevailing factor that influences natural ventilation.

In automatically controlled natural ventilation (ACNV), the increase or reduction of the airflow is achieved through openings or vents in the sides or roof that are opened and closed by electrically driven motors in response to sensors in the building.

Ventilation of the building should be designed in such a way that air follows a predefined route. Underfloor extraction from pits beneath the pens is a way to achieve air stratification within pig housing. Ventilation by drawing air from the manure pit in slatted floor systems is also considered an efficient way to reduce concentrations of manure gases in the house. By abstracting air from this head space, the flow of air through the slats will be predominantly downwards. This will reduce releases into the above-ground environment. Airflows could be locally increased during periods of disturbance, such as when slurry is being scraped or flushed. Stratified air management has the potential to reduce airflow requirements, thereby cutting heating and cooling needs and reducing the cost of abatement with air cleaning systems. This system has specific requirements in terms of the length and diameters of the air channels.

Irrespective of design or the principle applied, ventilation systems have to provide the required ventilation rate over the course of the year, which depends on the different production stages and the time of year. Air velocity around the animals must be kept below 0.15–0.20 m/s, to avoid draughts.

With forced ventilation, the air volume flow depends on the climatic conditions and is usually controlled depending on the temperature. The ventilation rate, which is dependent on the season and the time of the day, varies significantly. In summer, for example, it can reach ten times and in some cases even twenty times the amount of the minimum airflow rate in the winter [474, VDI 2011]. The minimum (winter) ventilation rate is the flow necessary to evacuate the moisture produced in cold weather by the youngest animals for the physiological stage considered and/or carbon dioxide and possibly ammonia. The maximum capacity is the flow applied in hot weather to the heaviest animals for the stage considered, to counteract the temperature rise inside the building.

The optimum airflow significantly contributes to the control of the indoor concentrations of ammonia, dust and germs. An increase in concentration of CO₂, NH₃, dust and germs can affect the pig feed intake by approximately 160 g/d, as a consequence decreasing the daily weight gain by 75 g [261, France 2010].

The recommended temperatures and ventilation rates in France for heated and non-heated pig slurry-based houses are summarised in Table 2.11. Reference values from the Netherlands are reported in Table 2.12.

Table 2.11: Ventilation rates and indoor temperatures for pig housing, in France

Animal category	Ventilation rate (m ³ /h per animal place)	Temperature (°C)
Mating/gestating sows (winter)	25–150	20
Mating/gestating sows (summer)		22
Farrowing sows (start of cycle)	35–250	24 ⁽¹⁾
Farrowing sows (end of cycle)		22
Weaners (start of cycle)	3–30	27 (weaning at 28 days)
Weaners (end of cycle)		28 (weaning at 27 days)
Fattening pigs (winter)	8–65	22
Fattening pigs (summer)		24–25
⁽¹⁾ For the piglet area, the temperature recommendation is 28–30 °C.		
Source: [261, France 2010] [345, France 2010]		

Table 2.12: Ventilation rates and indoor temperatures for pig housing, in the Netherlands

Animal category	Minimum ventilation m ³ /h per animal place	Maximum ventilation m ³ /h per animal place	Temp (°C)
Mating sows	14–20	120–150	22
Gestating sows	18–25	120–150	20
Gestating sows 1 week before birth	18–25	160–200	20
Farrowing sows during birth	18–25	160–200	23
Farrowing sows 1 week after latest birth	35–50	200–250	20
Farrowing sows end	35–50	200–250	20
Weaners start (7.5 kg)	2–3	10–12	26
Weaners day 21	4–6	15–18	24
Weaners day 42	6–9	20–30	22
Fattening pigs day 1 (23 kg)	6–8	20–30	25
Fattening pigs day 5	6–8	20–30	23
Fattening pigs day 50	11–15	40–55	22
Fattening pigs day 100	14–20	60–80	21
<i>Source: [421, Netherlands 2011]</i>			

Design values in Germany and Austria are shown in Table 2.13 for different pig categories.

Table 2.13: Ventilation rates for thermally insulated pig houses according to DIN 18910-1, in Germany and Austria

Weaners and fattening pigs ⁽¹⁾								
Live weight	kg	5	10	20	30	50	100	120
Minimum ventilation rate (winter)	m ³ /h per animal	2.5	3.7	5.4	6.9	9.4	14.1	15.6
Maximum ventilation rate (summer)	m ³ /h per animal	12	23	40	53	74	108	119
Gestating sows ⁽²⁾								
Live weight	kg	150	200	250	300			
Minimum ventilation rate (winter)	m ³ /h per animal	12.4	15.1	17.8	20.3			
Maximum ventilation rate summer)	m ³ /h per animal	83	106	128	149			
Farrowing sows ⁽³⁾								
Live weight	kg	150	200	250	300			
Minimum ventilation rate (winter)	m ³ /h per animal	21.7	24.5	27.1	29.6			
Maximum ventilation rate (summer)	m ³ /h per animal	139	164	187	209			
⁽¹⁾ Values calculated for 1.2 m ² per animal and temperatures from 28 °C to 18 °C.								
⁽²⁾ Values calculated for 2.0 m ² per animal and temperature 18 °C.								
⁽³⁾ Values calculated for 5.0 m ² per animal and temperature 18 °C.								
NB: Calculated values are based on an overpressure of 1 000 mbar and a house with a surface area of 14 m × 40 m.								
<i>Source: [275, DIN 2004] [251, KTBL 2009]</i>								

Mating and gestating sows have relatively low temperature requirements. In Spain and Italy, many farms apply only natural ventilation, with air entering from outside directly into the animal housing area. Nevertheless, in large farms, with a high density of animals, ventilation requirements are met by means of fan ventilation.

Extractor fans are commonly used, but, in Spain for example, there is a trend towards pressure ventilation systems linked to evaporative cooling, as these enable not only ventilation but also air temperature reductions inside the building. Throughout Europe, in farrowing and weaning houses it is common to control the indoor climate by operating automatic (sensor-controlled) ventilation systems with the heating of the air. The air inlet is usually via a central corridor (indirect) and the design of the ventilation system in the units is such that a draught near the animals is avoided.

The houses for fattening pigs that are naturally ventilated count on an air inlet directly into the pen area, whilst extractor fans are also used in new constructed buildings. Mechanical ventilation is also widely applied (e.g. for most fattening pig houses in Belgium-Flanders).

2.3.2.3 Lighting of pig housing

Lighting requirements for pigs are laid down in Directive 2008/120/EC, stating that pigs must be kept in light with an intensity of at least 40 lux for a minimum period of 8 hours per day [158, EC 2008]. Light must be available for good control of the animals and must not have a negative influence on pig production. Light can be artificial or natural entering through the windows; at the latter additional artificial lighting is normally applied.

Additional requirements are stipulated in some Member States. Finland, Austria, Belgium, Sweden and Germany require that pigs have access to daylight through the walls or roof (3 % of the floor space in Belgium and Germany; in Austria if there is no outdoor access) or through windows (all buildings must have windows for natural light in Sweden). Germany requires that pigs are housed under 80 lux for at least 8 hours per day [201, Mul M. et al 2010].

Different lamps are used with different energy requirements. Fluorescent lights are up to seven times more efficient than filament bulbs. LED lights are characterised by lower energy consumption and heat output, by smaller sizes than traditional bulbs, by the possibility of dimming bulbs without effect on the spectral sensitivity, and by the minimal flicker [422, Taylor N. 2010].

Lighting installations should conform to normalised standards for safe operation and must be water-resistant. Lights are installed in such a way that sufficient radiation (light level) is assured to allow the required maintenance and control activities to be carried out.

2.3.2.4 Water fogging

Some farms, located in zones where summer temperatures are extremely high, use mist evaporative cooling systems to reduce the housing temperature, as heat stress affects animal performance. Spraying fine particles of water is a technique that produces a cooling effect by evaporative cooling, and has a positive effect on dust control, as described in Section 2.2.4.3.

2.3.3 Pig feed and drink supply

2.3.3.1 Pig feed formulation

The feeding of pigs is aimed at supplying the required amount of net energy, essential amino acids, minerals, trace elements and vitamins for growth, finishing or reproduction. The composition and supply of pig feed is a key factor in the reduction of emissions to the environment from pig farming.

Pig feed formulation is a complex matter, combining many different components in the most economical way. Different factors influence the composition of a feed. Components used for feed formulation are determined by the location. It is now common for different feeds to be applied, enabling formulation closer to the requirements of the pig. For example, two-phase feeding is applied for sows and three-phase for finishers.

In general, multiphase (adapted N and P content) feeding regimes are commonly applied for fattening pigs, as well as the use of feed additives, with the aim of reducing the amount of manure. Multiphase or programmed feeding regimes are also widespread for weaners. This section can only give a short overview of the essential elements that are combined in pig feed.

An important feature of a feed (material or diet) is its energy content (expressed in MJ/kg) and in particular the amount of productive energy that is available to the pig, the net energy (NE). There are a number of systems operating within the EU, used to express the energy value of a pig feed. In the past, these were mostly based upon digestible energy (DE) which is the difference between the gross energy of the feedstuff and the dietary energy losses in the faeces. However, the DE system undervalues the productive energy content of fats and overvalues that of protein and fibre. A modified version of the DE system is the metabolisable energy (ME) which takes into account energy losses through faeces, urine and gases. The net energy (NE) is the energy actually available for productive purposes (maintenance of bodily functions, growth, milk production and reproduction) taking into account all energy losses, not only through faeces, urine and gases but also the biggest energy loss by the pig, the heat. Nowadays, NE has been adopted by the majority of Member States; nevertheless, energy systems based on approximate DE are still in use.

There are two basic NE systems in operation in the EU, one produced by France and one by the Netherlands. There are also derivations such as the Danish system which is basically an NE system but uses Feed Units. In comparison with feeds formulated on a DE system, formulating feeds on an NE basis typically results in reduced crude protein content [624, IRPP TWG 2013].

The indispensable (or essential) amino acids are those that cannot be synthesised by the animal organism, or can only be in small quantities. They must, therefore, be supplied through the diet, which has to provide the indispensable amino acids in sufficient quantities to cover the animal's requirements. The essential amino acids for pigs are the same as for poultry, but the order of deficiency is not the same. In pigs, lysine is the first limiting amino acid, followed in general by methionine (and cystine), threonine, tryptophan, valine, isoleucine, histidine and the others.

In the formulation of feeds for pig nutrition, the ideal protein is a concept where the optimum indispensable amino acids supply is described in terms of ratios to lysine and where any deficiency of one of the indispensable amino acids will compromise growth and/or health. In this profile, all indispensable amino acids are equally limiting for performance, just covering the requirements for all physiological functions.

In practical nutrition, this offers the advantage that the lysine requirement will vary (per kg of feed or per MJ of energy), but not the ideal amino acids profile expressed relative to lysine. Each of these ratios can thus be directly introduced as a constraint in feed formulation. For many years pig feeds have been formulated using digestible amino acids (standardised ideal digestible or SID) rather than total.

The pigs' requirements for minerals (major elements and trace elements) is a complex matter, even more so due to the interactions between them. Their doses in feeds are measured in g/kg (minerals) or mg/kg (trace elements). The most important are Ca and (digestible) P for bone tissue. Ca is also important for lactation and P is important for the energy system. Often their functionalities are related and so therefore attention must be given to their ratio. The minimum requirements vary for the different production stages or purposes. For early growth (including weaners) and lactation, more Ca and P are required than for growing and finishing. Mg, Na and Cl are usually given at levels sufficient to meet the requirements. The requirements of trace elements are defined as minimum and maximum levels, as the elements are toxic above certain concentrations.

Important trace elements are Fe, Zn, Mn, Cu, Se and I. The requirements can usually be met, but Fe is given by injection to suckling piglets. Cu and Zn can be added to the feed ration of pigs in a quantity higher than the actual production requirements, in order to make use of the pharmacological effects and the positive effects on production performance (auxinic effect). However, European (i.e. Directive 85/520/EEC and Regulation 1334/2003) and national rules have been adopted, establishing maximum concentration levels in livestock feeds; for example

in Italy, regarding additives in feeds, which place limits on the addition of copper and zinc, in order to reduce the quantity of these two metals in animal slurry.

Vitamins are organic substances that are important for many physiological processes, but can usually not (or not sufficiently) be provided by the pig itself and therefore have to be added to the pig's feed. There are two types of vitamins:

- fat-soluble vitamins: A, D, E, K;
- water-soluble vitamins: B, H (Biotin) and C.

Vitamins A, D, E and K can be stored in the body and are supplied on a regular basis, but B-vitamins, H and C are supplied daily, as the animal cannot store them (except B12). There are minimum requirements for the concentration of vitamins in pig feed, but the requirements of pigs are affected by many factors, such as stress, disease and genetic variation. To meet the varying requirements, feed producers apply a safety margin, which means that usually more vitamins are supplied than necessary.

Other substances might be added to pig feed to improve:

- production levels (growth, FCR): zootechnical additives;
- quality of feed: e.g. vitamins and trace elements;
- technological characteristics of feed (taste, structure);
- the environmental impact of animal production: digestibility enhancers, gut flora stabilisers and additives that favourably affect the environment.

Organic acids and acid salts can be added for their effect on digestibility and to allow a better use of the feed energy.

Plants contain some compounds that either the animal cannot digest or which hinder its digestive system, often because the animal cannot produce the necessary enzyme to degrade them. Enzymes are substances that enhance the chemical reactions of the pigs' digestive processes, e.g. the addition of the enzyme phytase to the feed enhances phosphorus digestibility by breaking down the indigestible phytic acid (phytate) part of phosphorus of plant origin in feedstuffs. By improving digestibility, they increase the availability of nutrients and improve the efficiency of metabolic processes. The use of antibiotics as a feed additive in animal feed for growth promotion is prohibited in the EU (Regulation No 1831/2003/EC).

2.3.3.2 Feeding systems

The choice of feeding system is important as it can influence daily weight gain, FCR and percentage feed loss [39, Germany 2001]. In reality, differences within systems may be greater than between systems [624, IRPP TWG 2013]. Pig feeding encompasses a number of feed types. Dry feed is formulated as pellets or meal without any addition of water. Wet feed (or liquid feed) is formulated as a mixture of feed, water and other ingredients so that it can be pumped. Most feed mixed on farm is dispensed as a meal whereas that supplied by larger commercial mills is more often supplied in the form of pellets or nuts.

Pelleting improves digestibility, reduces feed wastage and dust, and may improve feed intake while the feed conversion ratio is generally improved. Pelleting, as a thermal process, can also reduce or eliminate potential pathogens such as salmonella in the feed ingredients. However, meal is cheaper to produce and gut microbiology is generally better for pigs fed with meal, with less diarrhoea and a lower salmonella incidence.

In areas with a high population there are high quantities of liquid by-products available for the preparation of liquid feeds. These include starch products, those from the brewing and distilling industries (including bioethanol) and milk products. They are mixed on farm with meal and circulated to the pigs via a pipeline. Such by-products are cost-effective although their composition and supply can be variable. They are low in dry matter and, therefore, the transport distance is crucial. There has been an increase in by-product feeding in the EU although this is inevitably limited by the supply of co-products [624, IRPP TWG 2013].

The design of the feeding installation depends on the feed type. Liquid feeding is most common, but for example in Spain and Belgium dry feeding is applied in most of the farms, and mixtures are also applied. Regimes are *ad libitum* or restricted. For example in Italy the following variations apply [412, Italy 2001]:

- for mating/gestating sows: 80 % of farms operate liquid feeding; the other 20 %, dry feeding;
- farrowing sows and weaners are given dry feed;
- growing/finishing pigs are liquid-fed on 80 % of farms (of which 5 % are fed with wetted feed), with feed supplied as dry plus drinkers on 5 %, and dry-fed on 15 %.

The feeding system consists of the following parts: feeding trough, storage facility, preparation system, transport system and dosage system.

Feeding can vary from fully hand-operated to fully mechanised and automated systems. Troughs of different designs are used and provisions are made to prevent pigs from lying in the trough. Feed is often delivered dry or mixed with water. Different dry feeds are purchased to allow a mixture close to the required nutrient content. Dry feed is usually transferred from the storage to the mixing machines by augers.

Distribution varies with the type of feed. Dry feed can be transported by a feeding cart or mechanically through feed distribution tubes in the same way as liquid feed. Liquid feed is pressed through a plastic tube system, in which the pressure is built up by the pumping system. There are centrifugal pumps, which can pump large amounts and can achieve about 3 bar. Displacement pumps have a lower capacity, but are less limited by pressure build-up in the system.

Liquid (wet) feeders consist of a mixing container, where the feed is mixed with water, and tubes to distribute it to the animals. The rationing of the mixture can be done automatically based on weighing the exact amounts or can be computer-controlled, mixing according to the feeding plan and substituting feed when necessary. Liquid feeding can also be operated manually by weighing and mixing the required amounts. In Austria, fattening pigs are fed with a 'soup' of water and 30 % dry matter coming from maize, soy, mineral raw materials and a raw fibre carrier called 'pig fibre' [373, UBA Austria 2009].

Feed can be delivered to animals by using mechanical drops with calibrated boxes (drop-feeding) that are fed by auger. The system is used for group-housed animals and for individual housing (crates). Group-housed sows can be individually fed with computerised sow feeders (see Section 2.3.1.1.4) that identify the animals by an electronic identifier (chip) clipped at the ear or neck. The amount and supply are adjusted to allow the sow to eat as much and as often as it needs, but constrained by operator-determined limits.

Individual feeding stalls are frequently provided in pens for group housing. Animals are free to roam in pens and enter the feeding stations, where they are individually fed, in order to reduce aggression between animals at feeding time. Self-locking or manual locking individual feeding stalls can be used for activities such as vaccination, oestrous detection, and artificial insemination.

With trickle feeding systems, feed is delivered via a top auger to individual feeding points, in small portions, at regular intervals over the feeding period. The feed is delivered at a speed adjusted to the consumption rate of the animals (typically 80–180 g/minute), to discourage changes of feeding position, with consequent differences of feed intake within the group. In the rearing of sows, aggressive behaviour caused by competition for feed can be reduced.

Liquid feeding has the potential to reduce production costs and is an effective management tool for controlling the presence of salmonella in pigs at slaughter but has no significant effect on measures to reduce the environmental impact [289, MLC 2005] [290, Univ. of Newcastle 2002]. On the other hand, the capital cost of wet feeding is high compared to that of dry feeding and the variability of ingredients in liquid feeding could make it difficult to guarantee the ingestion of properly balanced feed.

2.3.3.3 Drinking water supply systems

All pigs over 2 weeks of age must have permanent access to a sufficient quantity of fresh water in compliance with Directive 2008/120/EC. Natural drinking behaviour also has to be considered.

Inadequate water intake can lead to reduced feed intake, poor daily weight gain and poor feed conversion. Significant losses may occur due to a recreational use of water. In turn, waste water may significantly increase the volume of slurry produced [423, Gill P. 1989].

For the supply of drinking water, a great variety of drinker systems are available. The quality of the water should be appropriate for the animals being produced according to the provisions of Regulation (EC) 183/2005. Some farms have a main reservoir with a large capacity and possibilities for disinfecting treatment; inside each house or sector there may be smaller reservoirs to allow water distribution along with medicines and/or vitamins. One or more pressure regulators are necessary to control pressure in the pipeline; a filter can be placed upstream of the distribution line [413, Portugal 2001] [357, France 2010].

The proper functioning of the watering system mainly depends on:

- the drinker design;
- the flow per drinker;
- the number of animals per drinker;
- the position of drinkers, e.g. height from the ground [357, France 2010].

The following drinker designs are commonly used to distribute water to the animals:

- nipple drinkers in a cup or a trough;
- bite drinkers;
- push-tube drinkers;
- trough with bowl and pallet;
- water trough at a constant level.

Animals easily learn how to use nipple and bite drinkers and the cleanliness of the water provided is ensured; notable waste water can occur in comparison with trough drinkers. By pressing a nipple with its nose, the pig can make water run into the trough or the cup. Minimum requirement capacities vary from 0.75–1.0 litres per minute for piglets and typically 2.0–3.0 litres per minute for sows. A bite nipple gives water when the pig sucks on it and opens

a valve. The water will not run into a trough or cup. The capacity of the bite nipple is 0.5–1.5 litres per minute. Push-tube drinkers generally equip wet feeders or can be placed above small troughs.

Watering the animals by filling the trough can vary between a simple tap to a computerised dosing system measuring exactly the required volume. Trough drinkers at a constant water level allow fast animal adaptation and result in less water wastage due to the water being retained in the trough. However, this retained water is susceptible to spoilage, which could decrease water intake, therefore they are not widely used. Troughs with bowl and pallet combine low water wastage with acceptable water cleanliness. The bowl is generally made of cast iron with the shape of a snout.

The number of animals serviced in France by the different types of drinking systems is shown in Table 2.14.

Table 2.14: Number of animal serviced by each type of drinking equipment in France

Pig category	Drinking system	Capacity (l/min)	Height (cm) ⁽¹⁾	Maximum number of animals per drinker system
Piglets	Bowl	0.5	8	NR
	Bite drinkers	0.5	20	NR
Weaners	Bowl	0.5–1.0	12	18
	Bite drinkers	0.5–0.8	30	10
Fattening pigs	Bowl	0.8–1.0	20	18
	Bite drinkers	0.5–0.8	50	10
Sows (Group housing)	Bowl	3.0	30	10
	Bite drinkers	1.5	70	5
Sows (individual housing)	Bowl	> 3.0	5–10	NR

⁽¹⁾ For bowls, height is calculated from the higher edge and for bite drinkers from the of the end of the bitter.
 NB: NR = not relevant.
 Source: [357, France 2010]

2.4 End-of-pipe techniques for air cleaning

Air cleaning systems are end-of-pipe techniques used to remove pollutants from the exhaust air of animal housing. They are applied only in forced ventilated houses because the exhaust air has to be collected and led through the cleaning system by fans. Air cleaning systems operate on different removal principles (physical, biological and/or chemical). Different types of wet scrubbers and biofilters are applied, individually or in combinations; they differ in applicability and removal performance (see related data in Table 4.129).

Modifications to the feed formulation and adaptation of the housing system may not always allow compliance with increasingly stringent emission regulations and targets. This can be seen as a driving force for the development and use of air cleaning systems; even if these techniques do not improve the indoor climate of the animal houses.

2.4.1 Wet scrubbers

A wet scrubber, or trickling filter, is an end-of-pipe technique for removing pollutants from the exhaust air of a forced ventilated animal house. The air is filtered through a bed of inert material that has a high porosity and a large specific area and is continuously kept wet (see Figure 2.27). The contaminated air is blown through the filter either horizontally (cross-current) or upwards (counter-current), to produce intensive contact between air and water, enabling the soluble contents to be exchanged from the gas to a liquid phase. Most of the trickling water is continuously recirculated, while a fraction is discharged and replaced by fresh water. The discharge is automatically managed on the basis of the water conductivity and allows for the removal of nitrogen compounds. These techniques have the potential to achieve a combined removal of ammonia, odour and particulate matter.

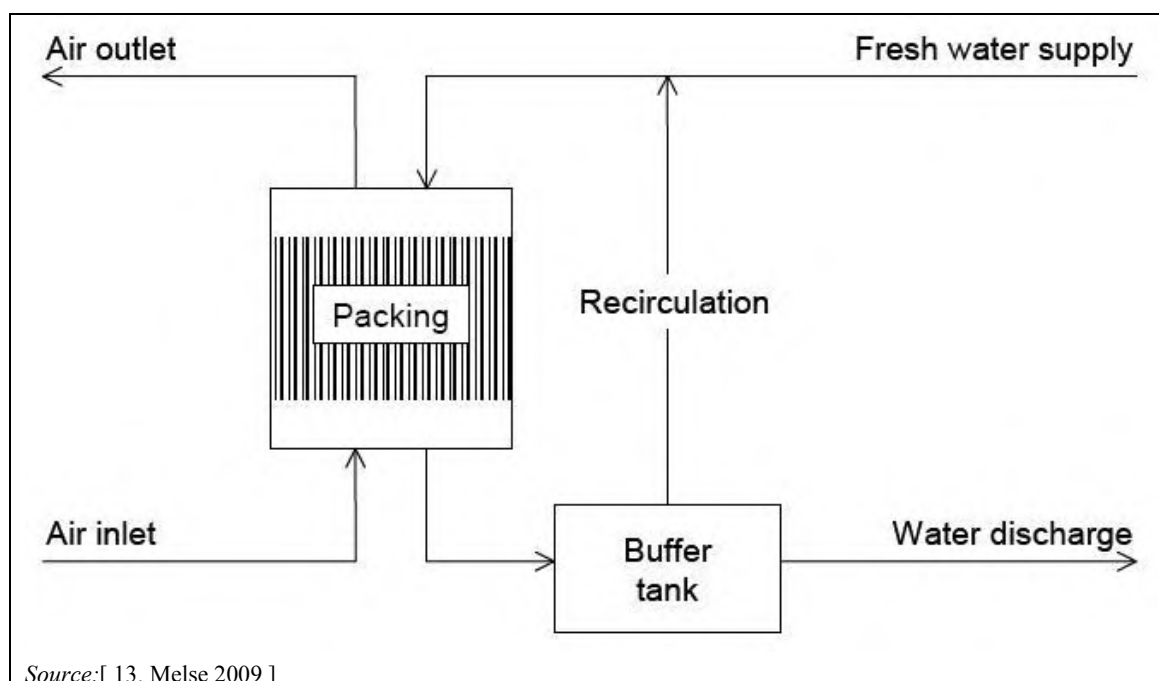

Figure 2.27: Schematic representation of a wet scrubber

Two types of wet scrubbers are mainly used: 'acid scrubbers', and 'biotrickling filters' (bioscrubbers) and their combinations, e.g. 'multi-stage air cleaning systems', where two or three stages that operate on different principles are run in series, e.g. an acid scrubber to remove ammonia and a biofilter to remove odour.

In a bioscrubber or biotrickling filter, the exhaust air is conducted through a package of plastic material, which is continuously sprayed with water containing microorganisms to trap and breakdown ammonia and organic compounds responsible for odour; dust is also dissolved in water. During the passage through the moistened packing material, ammonia is removed by bacterial conversion to nitrite and nitrate. The bacterial population mainly grows as a film on the synthetic packing material and is partly suspended in the recirculating water.

An acid scrubber uses a spray of acid solution (usually sulphuric acid) to trap and remove ammonia from the contaminated exhaust air. The pH of the circulating liquid is kept at low levels (i.e. < 5) and the ammonium salt that is formed is removed from the system with the discharge water.

In practice, scrubbers should be designed for treating the maximum exhaust airflow rate. Since maximum ventilation rates do not occur frequently, scrubbers can alternatively be dimensioned for treating lower ventilation rates, so that the part of the exhaust air that exceeds the air cleaning system capacity is allowed to be vented untreated through a bypass. In this way, the air cleaning system size and cost are significantly decreased (as cost is proportional to the volume of air to be treated), ammonia removal efficiency is kept high and emission loads are only slightly affected; on the other hand, odour nuisance mitigation will be nearly completely compromised. However, the ammonia removal efficiency of the system also depends on other parameters, including the thickness of the filter package.

Manufacturers deliver either prefabricated modules or custom-made installations. Periodic maintenance and controls are necessary in order to maintain the abatement efficiency. The nitrogen compounds that result from both chemical and microbial processes can be used as fertilisers.

2.4.2 Biofilters

A commonly applied method of treating the exhaust air of forced ventilated animal housing is the use of biofilters. The exhaust air flows through a large packed filter bed of organic material, such as compost, root wood or wood chips. The filter material is always kept moist, so that high microbial activity occurs on the biologically active film that is formed on its surface. The wet microbial film traps and degrades the organic compounds responsible for odour that are blown through the filter. Dust emissions are also considerably reduced. Even though NH_3 is degraded by microbial activity, the use of single-stage biofilters for ammonia removal in animal housing is generally not recommended due to the risk of formation of secondary trace gases and fast filter material decomposition. At normally applied air residence times, the filter material lifespan is shortened in the case of relatively high NH_3 and dust concentrations of the incoming air and inconsistent humidification of the packing. In general, this technique can be effectively used in combination with other air cleaning techniques as a polishing step for effective odour removal.

2.5 Processing and storage of animal feed

Many on-farm activities involve the processing and storage of feed. Many farmers obtain feed from animal feed compounders that can be readily used or that needs only very limited processing. Production of the basic feed ingredients is a specialised activity; however, some large enterprises produce the majority of the basic ingredients themselves and also purchase premixtures of additives to manufacture their own compound feed; this may also be the case for some small and medium-sized enterprises.

The processing of feedstuff consists of grinding or crushing and mixing. The mixed feed can either be fed as a dry or a liquid feed. Mixing the feedstuff to obtain a liquid feed is often done shortly before feeding the animals, as this liquid cannot be stored for a long period of time. Grinding and crushing are time-consuming and require a lot of energy. Other energy-consuming parts of the installation are the mixing equipment and the conveyor belts or air-pressure generators used to transport the feed.

Feed processing and feed storage facilities are usually located as close as possible to the animal housing. Feed produced on the farm is usually stored in silos or sheds as dry cereals; gas emissions are then limited to the emission of carbon dioxide from respiration.

Industrial feed can be wet or dry. If dry, it is often pelleted or granulated to allow for easier handling. After mixing the feedstuff, dry feed is transported in tanker lorries and unloaded straight into closed silos, therefore dust emissions are usually not a problem.

Driveways and trucks are preferably kept in a zone separate from the animal houses, in order to avoid trucks entering the clean zone and, therefore, reducing the risk of contamination (biosecurity measure).

There are many different designs of silos and materials used. They can be flat at the bottom, to stand on the ground, or conical, resting on a supporting construction. Sizes and storage capacities are numerous. Nowadays, polyester, glass fibre reinforced plastic (GRP) or galvanised steel silos are the most frequently used, and the inside is made as smooth as possible to prevent residues from sticking to the wall. For liquid feed, materials (resins) are applied to resist low pH products or high temperatures.

Silos are usually a single construction, but there are also designs on the market that can be transported in parts and assembled in the farmyard. Silos are usually equipped with a manhole for internal inspection and a device for air venting or for relieving overpressure during filling. Equipment is also applied for aeration and the stirring of the contents (especially soya) and to allow the smooth transportation of the feed out of the silo.

2.6 Collection and storage of manure

2.6.1 General requirements

Manure is an organic material, which supplies organic matter to soil, together with plant nutrients (in relatively small concentrations compared to the mineral fertilisers). It is collected from animal housing and stored either as slurry or as solid manure. Manure from intensive livestock is not necessarily stored on the farm where it is produced and particular care is taken because of the risk of spreading disease.

Slurry consists of excreta produced by livestock in a yard or a building, mixed with rainwater and cleaning water and, in some cases, with bedding in relatively small quantities and feed. Slurry may be pumped or discharged by gravity. Pig manure is often handled as slurry.

Solid manure includes farmyard manure (FYM) and consists of material from litter-covered yards, dried poultry manure from belt removal systems in hen housing, excreta with a lot of straw in it, or solids from a mechanical slurry separator. Solid manure does not flow under gravity and cannot be pumped. Some types of solid manure cannot be stacked in a heap and liquids may drain from the material. Most poultry production systems produce solid manure, which can generally be stacked.

Storage facilities are usually built with a minimum capacity to guarantee sufficient storage until further manure handling is possible or allowed (see Table 2.15), due to regulations implementing the Nitrates Directive (91/676/EC). The required minimum storage capacity and prohibition period for manure landspreading differ between Member States; the prohibition period may also depend on the soil and crop type. The storage capacity depends on the climate, on the regulatory requirements, on the landspreading risks (manure management planning), on the size of the farm (animal numbers) and on the amount of manure produced taking into account the amount of waste water produced, and is expressed in months rather than in m³. For slurry storage in earth-banked lagoons, in particular, the calculation for the required storage capacity has to allow for a minimum freeboard as a safety margin to limit pressure on the bank and to prevent overtopping by the action of wind on the slurry surface or abnormal precipitation (predominately rainfall), which in turn can erode the top and dry slope and lead to pollution. In general the quantity of precipitation must be considered in uncovered storage facilities.

The storage time depends on the fertiliser requirements of the crops, the vegetation period, the soil moisture deficit and the storage capacity. The field crops and fertiliser requirements differ between farms and management options and may change every year. The storage time can range from some days to some months depending on the management system [574, UBA Germany 2011] [624, IRPP TWG 2013].

Across Europe, a storage capacity of 4 to 6 months is generally applied for solid manure. In the northern regions (Sweden, Finland), even larger storage capacities may be applied. A storage capacity of 6 months seems to be a common standard in Europe for slurries; although, shorter (e.g. Czech Republic, Spain, Portugal) and even longer storage times are also common (e.g. the Netherlands, Denmark, Germany, Sweden, Finland) [264, Loyon et al. 2010]. A large slurry tank can easily contain 2 000 m³ or even up to 5 000 m³.

Table 2.15: Storage times of poultry and pig manure in a number of Member States

EU Member State	External manure storage capacity ⁽¹⁾ (in months)	Climate
Belgium (Flanders)	3 (farmyard manure) 9 (slurry) 9 (poultry manure when birds are kept indoors all the time)	Atlantic/Continental
Belgium (Wallonia)	6 (slurry)	Atlantic/Continental
Luxembourg	5	Atlantic/Continental
Denmark	6–9	Atlantic
Finland	12 (except for deep litter)	Boreal
France	3–4 6 (Brittany)	Atlantic
Germany	2–4 (solid manure, according to good agricultural practice) 6–10 (slurry, depending on soil and climatic conditions)	Continental
Austria	6	Continental
Greece	4	Mediterranean
Ireland	6	Atlantic
Italy	3 (solid manure) 4–6 (slurry)	Mediterranean
Portugal	3–4	Mediterranean
Spain	3 or more	Mediterranean
Sweden	8–10	Boreal
Netherlands	7 (slurry) length of production cycle (poultry)	Atlantic
UK	6	Atlantic
Slovenia	4 or 6 (depending on the region)	Continental

⁽¹⁾ Deep litter of poultry systems is considered storage space.
Source: [537, COM 1999] [500, IRPP TWG 2011] [574, UBA Germany 2011]

Table 2.16 reports examples of national regulations implementing the Nitrates Directive (91/676/EEC), which bans manure application during certain periods of the year.

Table 2.16: Examples of national regulations (2013) prohibiting manure application during certain periods of the year

EU Member State	Regulation for manure application
Germany	Ban on slurry application between 01.11 and 31.01 on tillage land, and between 15.11 and 31.01 on grassland
Austria	Ban on slurry application between 15.10 and 15.02 on soils without vegetation, and between 15.11 and 15.02 on soils with vegetation
Netherlands	Ban on slurry application between 01.09 and 31.01 on sandy and loose soils, and between 15.10 and 31.01 on clay and peat soils under grass
Ireland	Ban on slurry application between 15.10 and 12.01 till 31.01, depending on the region
France	Ban on slurry application between 01.11 or 15.11 to 15.01, depending on the type of cultivation
UK	Ban on slurry application between 01.09 and 31.12 for sand and shallow soils under grass, and between 01.08 and 31.12 for sand and shallow soils under tillage; in other soils, between 15.10 and 31.01 under grass, and between 01.10 and 31.01 under tillage
Denmark	It is not allowed to spread slurry between 15.10 and 01.02
Italy	Ban on manure application depending on whether it is slurry or solid manure, the type of crops (arable or permanent grassland) and the region. The ban periods generally start between the months of November/December and end in January/February.
Finland	Manure must not be applied between 15.10 and 15.04. It may be applied in the autumn up to 15.11, and application may be started in the spring no earlier than 01.04, provided the ground is not frozen and is sufficiently dry to avoid run-off into watercourses and any danger of subsoil compaction. Manure may not be applied on the surface of grassland after 15.09.
Belgium (Wallonia)	Ban on the application on slurry and poultry manure on arable land between 16/10 and 15/02, on grassland between 16.09 and 31.01.
Belgium (Flanders)	Ban on slurry application and other fertilisers from 15.10 until 15.02 on arable land on heavy clay soils. Ban on slurry application from 01.09 until 15.02 and obligation to sow catch crop/intermediate crop after harvest of the main crop. Ban on farmyard manure and compost application from 15.11 until 15.01 on arable land and grassland
<i>Source:</i> [442, Hansen et al. 2008] [574, UBA Germany 2011] [624, IRPP TWG 2013]	

Manure can have a relatively high dry matter (DM) content (dried poultry manure and litter-based manure) or can be a mixture of faeces, urine and cleaning water (slurry). Facilities for the storage of manure are normally designed and operated in such a way that the substances they contain cannot overflow.

The design and the construction material for the manure storage facilities often have to be chosen in accordance with the specifications and technical requirements laid down in guidance notes or in national or regional regulations (e.g. Germany, the UK, Belgium). The regulations are often based on water regulations and their objective is to prevent any contamination of ground or surface water. They also include provisions for maintenance and inspection and procedures to follow in case of an escape of slurry, which could pose a risk of damage to water resources.

Spatial planning of on-farm manure storage is regulated for the protection of water sources and to protect sensitive receptors in the vicinity of the farm against odour. Regulations prescribe minimum distances, depending on the number of animals and on farm-specific features, such as prevailing wind direction and the type of neighbouring receptors.

Table 2.17 compares the benefits and disadvantages deriving from the use of solid manure or slurry-based manure management systems over the entire chain of farm processes and activities.

Table 2.17: Advantages and disadvantages of solid manure- and slurry-based systems

	Straw-based systems	Slurry-based systems
General advantages	<ul style="list-style-type: none"> • More flexible long-term use of houses; • May reduce odour problems; • Perceived as more animal-friendly. 	<ul style="list-style-type: none"> • Generally more easily mechanised; • Lower labour inputs during housing.
General disadvantages	<ul style="list-style-type: none"> • More floor space required per animal; • Straw not always easily available/high cost; • Potentially higher ammonia and GHG emissions; • Higher dust emissions associated. 	<ul style="list-style-type: none"> • Specialised storage and handling equipment required.
Transport and storage	<ul style="list-style-type: none"> • Flexible, as almost any farm bulk trailer or lorry can be used to transport solid manure; • Manure may be stored in field heaps before landspreading; • Few straw-based units produce only 'solid' manure. 	<ul style="list-style-type: none"> • Almost always at the unit itself and must be in dedicated facilities; • Slurry is usually moved in purpose-made tankers or via piped systems; • High work rates can be achieved by pumping slurry through pipelines and tubes.
Fertiliser value and landspreading attributes	<ul style="list-style-type: none"> • FYM provides a greater amount of added organic matter, as well as plant nutrients; • Spreading is generally favoured on uncropped land or to grassland before reseeding, because of potential smothering problems. 	<ul style="list-style-type: none"> • Slurry can be more readily applied to growing arable crops and grassland in early spring and summer; • Greater supply of nitrogen available to plant in the season of application.
Animal welfare	<ul style="list-style-type: none"> • Straw is widely perceived to enhance the welfare of pigs; • Provides thermal insulation, thermal comfort 'buffering' and a more 'natural' environment; • Specific welfare concerns about outdoor production systems with straw-bedded shelters; • Straw must be of good quality, without presence of fungus. 	<ul style="list-style-type: none"> • European welfare directives increasingly discourage fully slatted floor systems; • Poor management of partly slatted floor rearing systems entails problems of fouled lying areas; • Fully slatted floor systems have been outlawed in new houses in some EU Member States.
Industry image	<ul style="list-style-type: none"> • The perception of better pig welfare provides some pig-meat marketing advantages; • Little evidence that a higher price is achieved. 	<ul style="list-style-type: none"> • Producers see slatted floor housing as the most cost-effective way to produce.
Labour requirements	<ul style="list-style-type: none"> • Advanced mechanisation of straw and solid manure handling; • Activity involved in straw procurement and additional manual tasks; • Typically, one extra full-time worker is required for a straw-based breeder/finishing pig unit of about 250–300 sows. 	<ul style="list-style-type: none"> • Slurry-based housing systems have lower labour requirements at all stages of production; • General husbandry tasks are generally more readily accomplished in housing layouts associated with slurry.
Flexibility of buildings	<ul style="list-style-type: none"> • Straw-based houses are more flexible, but reconversion to a slurry system would be costly; • Many buildings could be readily adapted to other farm uses (simple modifications to general purpose farm buildings). 	<ul style="list-style-type: none"> • Buildings with low ceiling heights, may be difficult to adapt to mechanised straw-based manure handling. • Ventilation systems may not be suitable for controlling the environment in straw-bedded pens without modification; • Floors and supporting structures may not be suitable for carrying the loads imposed by straw-based systems and equipment associated with their

	Straw-based systems	Slurry-based systems
		management; <ul style="list-style-type: none"> Natural ventilation could also be difficult to provide in many houses, because of lack of headroom.
Source: [253, ADAS 2002] [624, IRPP TWG 2013]		

2.6.2 Poultry manure

Solid manure is mostly produced in poultry houses and may be temporarily stored in the same building until its removal after the production cycle. The manure is cleared out approximately once a year for laying hens in systems without frequent removal (i.e. deep litter), or at the end of the rearing cycle for broilers and other poultry raised for meat. Some laying hen housing systems allow for more frequent, almost daily removal of manure (i.e. with manure belts). In free-range systems, birds have access to the outside environment and some droppings will be deposited in fields. In large farms, it is not unusual for the collection, further off-farm storage and management of the manure to be done by contracted third parties.

Laying hens produce droppings with a typical moisture content of 80–85 %. The initial moisture content is likely to be mainly influenced by nutrition, whilst the drying rate is affected by the external climate, indoor environment, ventilation and the manure handling system. Some systems enable manure to be dried to lower moisture content in order to reduce ammonia emissions. Some laying hens use a litter-based system similar to broilers. In-house manure collection and storage systems are described in Section 2.2.1. Different types of manure can be obtained:

- Wet manure. This has a dry matter content of approximately up to 30–35 % and is produced with regular daily removal.
- Pre-dried manure, with a dry matter content of approximately 35–50 %. This can be produced, for example, in systems where manure belts are fitted with pre-drying ventilation.
- Dry manure or littered manure. These can be produced in houses with deep pits with air-drying or in littered houses. The manure has a high dry matter content of up to 80 %.

Where manure belts are used, manure collection is frequent (usually every one to three days) because the weight of the accumulating droppings may hamper the performance of the removal system.

Broilers are typically bedded on wood shavings, sawdust or straw which, when combined with bird droppings, produce a fairly dry (around 60 % dry matter) friable manure, often referred to as poultry litter. Sometimes shredded paper is used as a bedding material. Peat is the most commonly used litter material for broilers and turkeys in Finland. Poultry litter quality is affected by temperature and by ventilation, drinker type and management, feeder type and management, stocking density, nutrition and bird health. Systems are described in Section 2.2.2.

Turkeys are typically bedded on wood shavings or straw (also mixed together) to about 75 mm depth, which produces a litter of 40 % to 60 % dry matter as an average. In comparison to broilers, turkeys tend to wet the litter more in the areas under the drinkers where extended bands with levels of dry matter between 25 % and 35 % can be found [624, IRPP TWG 2013] [9, Italy 2013]. Systems are described in Section 2.2.3.2.

Ducks are normally bedded on straw applying higher amounts in finishing accommodation. A lot of water is spilled and this results in a litter relatively low in dry matter (around 25 % dry matter) [425, DEFRA 2010]. Systems are described in Section 2.2.3.3. However, in France, meat ducks are mainly raised on fully slatted floors, where slurry is produced. Stores are dimensioned in relation to the surfaces where the ducks are reared, with a capacity of 300 m³ or 450 m³ per 1 000 m² of surface, for storage periods of 4 or 6 months respectively [257, France 2010].

2.6.3 Pig manure

Slurry may be stored beneath fully slatted or partly slatted floors of livestock buildings. The storage period can be quite short but may extend to several weeks in the deep pit within the housing (e.g. Belgium-Flanders, the UK, Ireland); in general, inside storage is temporary and slurry is regularly removed to an outside storage facility in the farmyard for further management. In-house manure collection and storage systems are described in Section 2.3. Where further storage is required or where treatment is applied, slurry is usually sluiced by gravity or pumped to collection pits and/or directly to slurry stores. Slurry tankers are also used. Examples of factors used for calculating slurry storage volume are presented in Table 2.18.

Table 2.18: Factors used for calculating storage dimensions for pig slurry, in Belgium-Flanders and Spain

Animal physiological state	BE (FL)	ES
	Required storage capacity in m ³ per animal place ⁽¹⁾	Annual slurry generation in m ³ per animal place
Fattening pigs (up to 100 kg)	0.8 (0.6 if water-saving devices are used)	2.15
Growers (20 to 50 kg)	0.4	1.8
Finishers (50 to 100 kg)	NI	2.5
Farrowing sows (including piglets)	2.3	5.1
Mating and gestating sows, boars	2.0	NI
Sow in a farrow-to-finish farm ⁽²⁾	NI	17.75
Boars	NI	6.12
Gilts	1	2.5
Weaners	0.2	0.41
⁽¹⁾ Values corresponding to a storage period of 6 months. For a storage period of 9 months, the values are increased by half. ⁽²⁾ Includes all offspring of the sow until end of fattening period. NB: NI = no information provided. <i>Source:</i> [255, BE Flanders 2010] [624, IRPP TWG 2013]		

Differences in similar factors are common because the amount of slurry produced is variable due to the following aspects:

- yields and efficiency of the animals;
- amount and type of bedding used;
- spillage of drinking water, depending on the type of drinkers;
- water used for cleaning and sprinkling;
- differences in diet that may cause a higher consumption of drinking water and thus also higher urine production.

Where significant quantities of straw are used for bedding, solid manure is generated which may be removed from buildings regularly (every one, two or three days) or (in deep-littered houses) after batches of pigs are moved every few weeks. Solid manure and FYM are typically stored in concrete yards or on field heaps ready for landspreading.

In Belgium-Flanders, the factors used for estimating the required manure storage capacity (for a minimum of 3 months storage in house) for solid pig manure generated in deep litter housing systems are:

- group-housed mating and gestating sows: 2.4 m³/animal place;
- fattening pigs: 0.7 m³/animal place [255, BE Flanders 2010].

Many pig farms produce both slurry and solid manure. There is a tendency to collect the excreta and urine separately to reduce ammonia emissions from housing (see Chapter 4). They may be mixed again in storage if further treatment of the slurry and/or the solid manure is not required [506, TWG ILF BREF 2001].

2.6.4 Storage systems for solid manure

Manure collected in solid form is normally transported by front-end loader or (chain) belt systems and stored on an impermeable concrete floor that is placed outdoors or in closed barns. The storage system can be equipped with side walls to prevent liquid fractions or rainwater from leaking away. These constructions are often attached to an effluent tank to store the liquid fraction separately. The tank may be emptied regularly or the contents may be moved to a slurry store. Double storey constructions are also applied that allow the liquid fraction of manure and rainwater to drain into a basin underneath the manure storage area.

The storage of solid manure on impermeable surface is the most commonly applied option throughout Europe. However, field storage is still often practised. Measures for leakage control and collection and separate storage of seepage liquids are applied only in a few countries (e.g. Czech Republic, Italy, Germany, Finland) [264, Loyon et al. 2010].

In France, solid manure is stored or composted on the field or on a concrete silo. A concrete silo may be obligatory, depending on the local water protection regulation. In the case of solid pig manure, storage on the field is done only after a two-month period inside the house in order to minimise risks of leaching. The dry layer droppings are almost always stored in a shed [259, France 2010].

Examples of calculation factors, used in France, for dimensioning the store for the manure produced by cage-reared laying hens are reported in Table 2.19.

Table 2.19: Factors for calculating the dimensions of the manure store for cage-reared laying hens in France (1 000 bird places)

Manure collection system	Characteristics of manure		Store characteristics			Storage period of 4 months		Storage period of 6 months	
	Type of manure	Dry matter (%)	Storage type	Wall height (m)	No of side walls	Surface (m ²)	Volume (m ³)	Surface (m ²)	Volume (m ³)
Gutters	Slurry	< 20	External pit	NA	NA	NA	23.3	NA	35.0
Belt, no air drying	Wet droppings	20–27	External pit	NA	NA	NA	23.3	NA	35.0
Belt, no air drying	Wet droppings	20–27	Covered concrete silo with side walls	1.5	4 ⁽¹⁾	20.0	NA	24.0	NA
Belt, no air drying	Wet droppings	28–35		2	4 ⁽¹⁾	11.2	NA	14.0	NA
Belt with air drying	Pre-dried droppings	36–65		1.5	3	6.7	NA	10.0	NA
Belt with air drying	Pre-dried droppings	> 65	Covered concrete silo without side walls	NA	NA	6.7	NA	10.0	NA
Belt with air drying	Pre-dried droppings	> 65		1.5	3	4.7	NA	7.0	NA
				3.0	3	3.3	NA	5.0	NA
Underfloor pit without air drying	Droppings	< 20	Indoor storage in the underfloor pit with impermeable floor and walls			Storage surface = surface of the building			
Underfloor pit with air drying	Pre-dried droppings	35–65	Indoor storage in the underfloor pit with impermeable floor			Storage surface = surface of the building			

(¹) The fourth side will have an opening to facilitate access to machinery.
 NB: NA = not applicable.
 Source: [257, France 2010]

In Belgium-Flanders, the factors used for estimating the manure storage capacity for the rearing of pullets and laying hens are the following [255, BE Flanders 2010]:

- pullets (wet manure): 10 m³/1 000 animal places;
- laying hens (wet manure): 30 m³/1 000 animal places.

When manure is collected and carried away from housing immediately, especially when further management is done by third parties, there is no need for intermediate manure storage. For instance, daily collection from belts under laying hens or direct transport of broilers' manure at the end of cycle can be done directly from the farm to a third party or for landspreading.

Temporary field heaps can be created prior to landspreading. They may remain in place for a few days or for several weeks. Since soil and water contamination can occur, depending on the rainfall and the length of storage, heaps should be located where there is no risk of direct run-off entering watercourses or infiltration of liquid fractions seeping from heaps to groundwater (e.g. in a well-drained location away from drainage ditches or away from karstified limestone). Member States regulate temporary field heaps in different ways by requiring covers (the Netherlands, Finland, France), regulating the length or the season of the storage (the Netherlands, Belgium, the UK), the quantity and maturity of the manure (Austria), or demanding a yearly rotation of the place of storage (the Netherlands, Austria, the UK, France). Some examples of the requirements applied in different Member States for temporary field heaps are presented in Table 2.20.

Table 2.20: Examples of requirements applied for temporary field heaps in different Member States

EU Member State	Requirements
Austria	No requirement to cover field heaps. A three-month storage should lead to natural self-heating and the amount should correspond to the fertilising demand of the farm (about 25 t/ha). Mandatory yearly change of the storage place.
Belgium-Flanders	Storage of solid manure in field heaps is forbidden during the period landspreading is banned (15 November – 15 January) and is only permitted for a maximum of 1 month (pending landspreading) outside that period.
Belgium-Wallonia	No requirement to cover the field heaps. The heap has to be relocated each year.
Finland	The manure heap can be placed in the middle of the field or, in the case of a gently sloping field, near the top. A layer of mud or peat at least 15 cm thick has to be spread at the bottom of the heap in order to catch nutrient run-off. In winter, snow must first be removed from the site. Manure has to be piled up in one or a few large heaps. Piling up manure in the same place every year must be avoided. Manure heaps must always be covered with a tarpaulin or a layer of peat or an equivalent protective layer at least 10 cm thick, in order to prevent excessive run-off and emissions to air.
France	Location of temporary field heaps must change every year and, in this case, there is no need for a solid impermeable floor with drains. Mandatory cover only for poultry manure. No obligation to store solid pig manure on a solid floor if it has remained more than 2 months in-house in deep litter housing systems.
Ireland	Requirement for compact heap.
Italy	Temporary storage is permitted on agricultural land only after storage for at least 90 days and for a period not exceeding 3 months. Storage cannot be repeated in the same place within the same crop year. Temporary heaps must be of sufficient size and shape to ensure good aeration of the mass and, in order not to generate leachate, the necessary measures must be taken to complete drainage of leachate before transfer in the field and prevent the infiltration of rainwater, as well as provide appropriate soil waterproofing.
Netherlands	For temporary manure storage of 2 weeks or more, an absorbent layer of at least 0.15 metres, with at least 25 % organic matter (e.g. peat) is requested. Contact with rainwater has to be prevented as much as possible (in practice this means the use of a plastic sheet). Requirements may be applied at local level for temporary manure heaps of less than 2 weeks (same protection as for older heaps).
Denmark	Solid manure heaps must be covered and have to be stored on places with impermeable surface covers (e.g. concrete) and liquid collection facilities.
United Kingdom	Covering of the heaps is not always required. Criteria as to where temporary field heaps may be located, and for how long, are normally applied.

Source: [500, IRPP TWG 2011] [624, IRPP TWG 2013]

2.6.5 Storage systems for slurry

2.6.5.1 Slurry storage in tanks

Slurry, or the liquid fraction of slurry after separation, is usually stored in tanks made of concrete or steel panels. Slurry is pumped from the slurry pit or slurry channel inside the housing to the external slurry storage system. Slurry is transported via a pipeline or by means of a slurry tanker, and can be stored in slurry tanks above or below ground.

Slurry storage systems consist of collection and transfer facilities. Collection facilities are structural-technical facilities (channels, drains, pits, pipes, slide gates) for the collection and piping of liquid manure, slurry and other effluents, including the pumping station (i.e. the reception pit from where the tank is filled or emptied). Valves and sliding gates are important devices to control (back) flow. Although single valve designs are still common, double valve (sliding gate) designs or the blocking of valves are recommended for safety reasons. The

structural-technical facilities intended for homogenisation and transfer of liquid fractions and slurry are called transfer facilities.

Emissions to air from slurry stores can be reduced by decreasing or eliminating the airflow across the surface. Slurry tanks can be open or may be covered with a natural crust formed on the surface of the stored slurry, an artificial layer of floating matter (such as granulated materials, straw chaff or floating membrane) or with a firm cover (such as a canvas or concrete roof) to keep rainwater out and to reduce emissions. Both below- and above-ground stores may have a solid cover over the tank which is not in contact with the slurry surface. Formation and accumulation of gases in slurry stores present a real and significant health and safety hazard to operators.

Only in some Member States (e.g. the Netherlands, Denmark) are the slurry storage facilities generally covered by tents or roofs. Open storage is still widespread along with the use of natural or artificial crust forming [[264, Loyon et al. 2010](#)]. Other options for reducing emissions from slurry stores is the reduction of the surface area per unit volume of the slurry store (appropriate store design) and slurry acidification.

Underground tanks and reception pits are often used to store small amounts of slurry and can act as reception pits to collect slurry before it is pumped to a larger slurry store. They are usually square constructions built from rendered reinforced blocks, reinforced concrete made on site, ready-made concrete panels, steel panels or GRP. With blocks or bricks, extra attention is paid to the impermeability by applying elastic coating or lining. Occasionally, larger stores are constructed with reinforced concrete or block-work, or concrete panels; they may be partly underground, and are often rectangular in shape. Underground tanks made of reinforced concrete elements are the most common storage systems for slurry in cold regions. They are built with a common capacity of 5 000 m³ as circular and partly underground of up to 3 000 m³ (e.g. in Finland 1 000–2 500 m³ as circular and partly underground).

Above-ground circular stores are normally made from curved steel panels or concrete sections. Steel panels are coated to protect them against corrosion, usually with paint or a ceramic layer. Some concrete panel stores may be partly underground. Normally, all stores are built on a properly designed reinforced concrete base. In all tank designs, the thickness of the base plate and the suitability of the seal at the joint of the wall and the tank base are very important features to prevent slurry from leaking away. A typical system has a reception pit with a grid cover next to the main store. A pump is used to transfer slurry to the main stores; the pump can be fitted with an extra outlet to allow slurry mixing in the reception pit. Above-ground slurry tanks are filled via a pipe with an opening above or below the slurry surface. Since gas and odour emissions are different if the slurry is pipe-loaded from above or below the surface of the stored slurry, authorisations (e.g. Finland) may require that tanks are filled by a pipe below the slurry surface. Prior to discharge or filling, slurry is normally thoroughly mixed with hydraulic or pneumatic stirring systems to agitate sediment and floating matter and to obtain an even distribution of the nutrients. Slurry mixing can be carried out using propellers, either mounted through the side of the store or suspended from a gantry over the top of the store. Stirring can cause sudden releases of large quantities of noxious gases and proper ventilation is required, particularly if done in housing.

The main store may have a valve outlet to allow for emptying back to the reception pit, or alternatively it can be emptied using a pump located in the store (Figure 2.28).

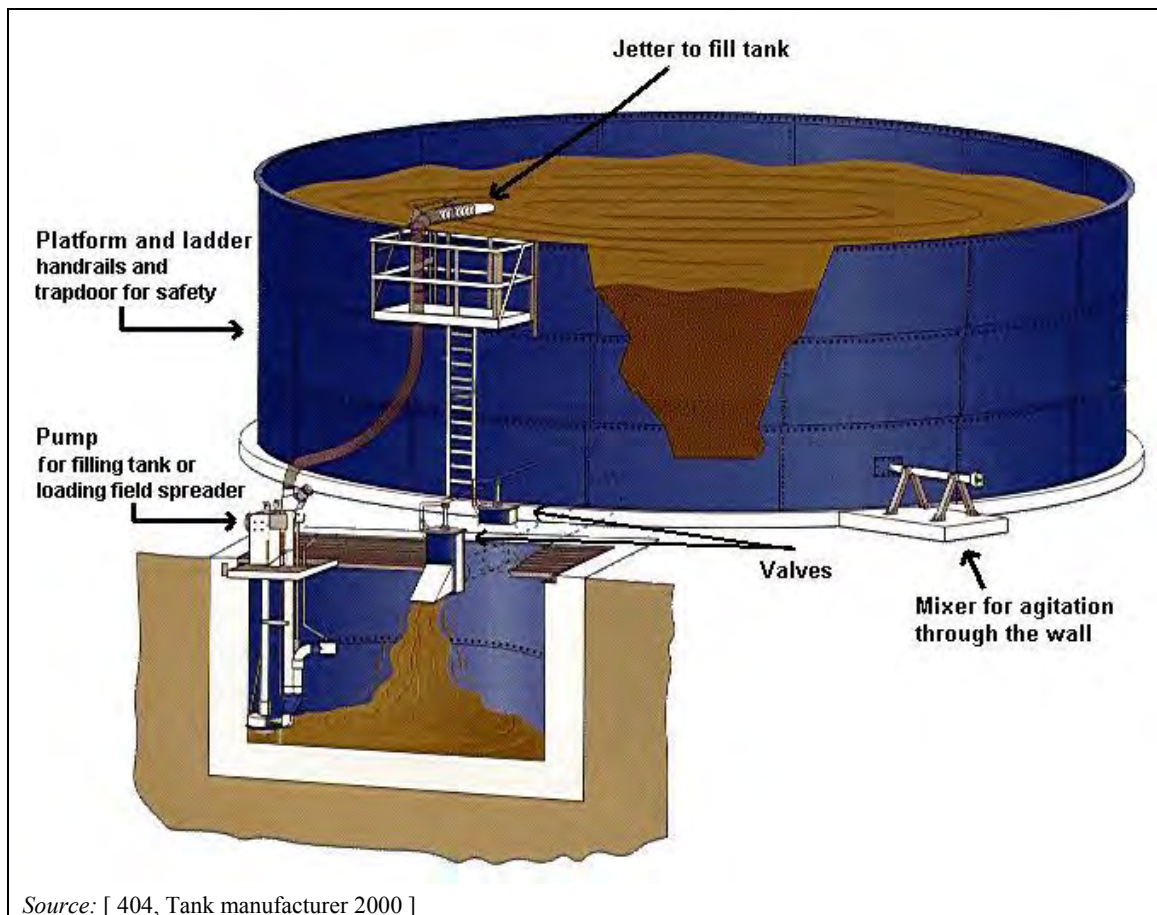

Figure 2.28: Example of above-ground slurry tank with an underground receiving pit

The typical size is 1 500 m³, within the range of 500–5 000 m³, which is made up of round sections of 20 m in diameter or by boxed sections with a height of 5.2 m. A freeboard of at least 0.5–0.75 metres is always left when filling the store, according to local conditions.

2.6.5.2 Slurry storage in earth-banked stores (or lagoons)

Earth-banked walls or lagoons are commonly applied in many MS to store slurry for extended periods of time. They are normally a large rectangular or square shaped structure with sloping earth bank walls (earth-banked lagoon) with a large surface area to depth ratio. Their design varies from simple ponds without any provisions to relatively well monitored storage facilities with water-impermeable lining such as clay or thick plastic sheets (e.g. polythene or butyl rubber) on the bottom, protecting the soil underneath. The capacity of a lagoon depends on the slurry generation of the farm and the operational requirements. Slurry can be mixed using pumps or propellers. If the slurry is not transported by pipelines but by a vacuum tank, earth-banked stores can be equipped with an access ramp. The earth-banked store is often fenced off to prevent accidents.

The durability of lagoons is considered to be 10–15 years. Capacity varies from 500 m³ to 7 500 m³. The typical size is 1 500 m³, on an area of 15 × 30 m, with a depth of 4 m (0.5–0.75 m must be kept as a freeboard), to store manure of 1.0–1.1 t/m³ for a period of 6 to 10 months. For a capacity larger than 5 000 m³ and up to 7 500 m³, the homogenisation of the stored slurry is increasingly difficult.

The soil used to construct an earth-banked store needs special properties to ensure stability and low permeability, which usually means a high clay content (*in-situ* clay or clay-lined stores). These stores are built below, above or partly below/above ground level. Earth-banked stores

also include a minimum allowance for freeboard in order to limit erosion and pressure on the bank and avoid overtopping (see Figure 2.29). These stores are not authorised in some Member States if they are not equipped with a geomembrane liner system (i.e. double-layered plastic geomembrane) and with leakage control [257, France 2010].

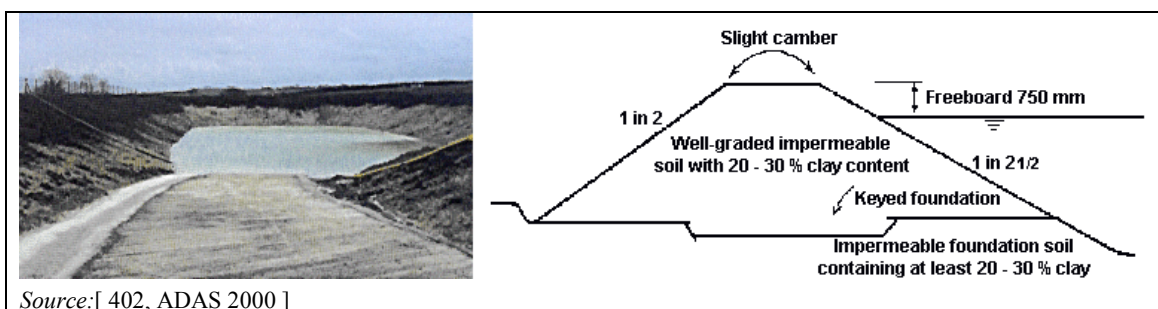

Source: [402, ADAS 2000]

Figure 2.29: Example of earth-banked slurry store, and design features

On some farms located in Mediterranean countries, a multiple earth-banked store or lagoon system is used for biological treatment and not just for storage. In each store, slurry is held for a certain period of time for aerobic or anaerobic degradation depending on the design, loading rate and type of microorganism present. Transport between the different stores can be done mechanically or by gravity, using the natural height differences of the site. In Portugal for example, these systems are normally designed and operated to comply with treatment requirements, although, due to legal restrictions on the quality of the discharged slurry, the majority of farms use lagoons to store the slurry before landspreading it as fertiliser.

The size of the earth-banked storage system may not allow the installation of some abatement techniques for the control of gaseous emissions (e.g. plastic sheets may not be applicable to large existing lagoons).

2.6.5.3 Other types of slurry storage

For the short-term storage of relatively small amounts of slurry, flexible bags are used. They may be moved from farm to farm (when empty). Larger bags may be sited more permanently in earthworks to provide longer-term storage. Such stores are filled and emptied via pumps and the larger stores can be equipped with mixing tools. Slurries can also be stored in masonry stores, which constitute the stores with the highest risk, particularly with age.

2.7 On-farm manure processing

To reduce nitrogen and phosphorus losses from livestock manure, it is important to manage the manure effectively so as to improve utilisation of the nutrient content, thereby reducing the mineral fertiliser requirement.

Where farmers have insufficient land to accommodate the manure being produced they are encouraged to export manure to their neighbours or look to reduce livestock numbers, in order not to exceed the limits imposed by the Nitrates Directive (91/676/EEC) concerning the amount of nitrogen that can be applied on farm. Movement of manure is an added cost and a potential source of odours and problems with biosecurity, but, at the same time, reduction in livestock numbers may not be economically viable.

Some countries have opted to encourage the processing of livestock manure so as to improve its manageability and utilisation. It is important that manure processing does not increase losses of gaseous forms of nitrogen (NH_3 , N_2O , NO_x), or the formation and release of other (greenhouse) gases: CO_2 and CH_4 [203, ADAS 2005].

In some EU countries, manure processing is frequently done by mobile units run by contractors moving from farm to farm (e.g. Denmark, Belgium-Flanders and France) [256, VITO 2006] [259, France 2010] [533, Baltic Sea 2020 2011].

A report suggested on the basis of data from Member States that manure processing reached an average level of 7.8 % of the total livestock manure production, with a big variation from country to country. The processing comprises 108 million tonnes of manure, containing 556 000 tonnes of nitrogen and 139 000 tonnes of phosphorus. The largest share of the livestock manure production is being processed in Italy, Greece and Germany, with 36.8 %, 34.6 % and 14.8 % respectively of the total. Anaerobic digestion is by far the most commonly used manure processing technology; 88 million tonnes of livestock manure and other products are processed in this way [595, Agro Business Park 2011].

Besides on-farm treatment, manure may also be (further) treated off-site in industrial installations such as poultry litter combustion plants and centralised composting plants. The assessment of off-site treatment is outside the scope of this document.

FYM is not often treated, but in some cases it is composted, dried or treated anaerobically. In some southern countries (e.g. Italy, Cyprus, Portugal), solids separation in pig slurry is of practical importance, possibly because of the value ascribed to the organic matter recovered. Amongst all other treatment techniques, anaerobic and (to a lesser extent) aerobic treatments have some use. Interest in anaerobic digestion has increased due to the rewards of biogas production [264, Loyon et al. 2010].

Manure processing prior to landspreading may be performed for the following reasons:

- to recover the residual energy (biogas) in the manure;
- to reduce odour emissions during storage and/or landspreading;
- to separate the solid phase of slurry;
- to decrease the nitrogen content of the manure to prevent groundwater and surface water pollution as a result of landspreading, and to reduce odour;
- to allow easy and safe transportation to other sites for application in other processes.
- to reduce the gaseous N and C losses from manure during housing, storage and landspreading.

The latter two reasons are frequent in regions with a nutrient surplus.

Organic compounds can be converted to methane by the anaerobic biological digestion of manure. The recovered methane is normally used as a fuel in combined heat and power production (CHP) systems for the production of electricity to sell in the public network and of heat to use at the farm or in the neighbourhood. In this way, the use of fossil fuels that would otherwise be needed to produce electricity and/or heat can be reduced.

Odour nuisance that occurs during or after the storage of manure can, in some instances, be reduced by aerobic or anaerobic treatment or by additives [506, TWG ILF BREF 2001].

The solid phase, which is rich in phosphorus, can be separated from the liquid phase, which is rich in nitrogen, allowing for a more adequate and environmentally balanced use of nutrients, especially in order to avoid over-fertilisation with phosphorus.

Nitrogen compounds in manure (organic, ammonium, nitrites and nitrates) can be converted to environmentally neutral nitrogen gas (N_2). The most common technique in this regard is the biological nitrification-denitrification: bacteria convert organic and ammonium nitrogen to nitrites and nitrates (nitrification) and further still to nitrogen gas (denitrification).

On the other hand, reducing the N content of manure may mean that there is less N to be used as a fertiliser (compared to raw manure). This amount of N that can no longer be provided by manure then has to be supplied through the addition of mineral fertilisers, with the consequent indirect emissions associated with the production of the mineral fertiliser, including N_2O emissions.

The water content and volume of the manure can be reduced. In addition, pathogenic microorganisms present in the manure can be deactivated (this prevents the spreading of livestock pathogens to other regions), and odour emissions reduced. Sometimes different manure compounds are separated for market reasons. The techniques given below are often used:

- Separation technologies (e.g. mechanical separation): separation of slurry into one or more liquid and one or more solid fractions (see above).
- Ammonia stripping: after pH adjustment, NH_3 is stripped from the manure fluid and captured.
- Evaporation: liquid manure is heated or depressurised, the resulting vapours are then condensed and further treated.
- Drying: solid manure is dried by air or animal body heat (see also Section 4.5), by burning fossil fuels, or by burning biogas from manure fermentation.
- Lime treatment: lime (CaO or $CaO-MgO$) is added to the manure, with the aim of reducing the amount of pathogens. The resulting increase in pH and temperature also leads to an increased release of NH_3 in the air and a volume reduction.
- Composting: the volume of the solid pig manure fraction or poultry manure is reduced, and also many pathogens are inactivated by the temperature increase caused by the biological degradation of organic material. The composting of poultry litter is, for example, used in the mushroom industry in Ireland. Under unfavourable conditions, this technique increases the potential for NH_3 , N_2O and CO_2 emissions.
- Pelletising: dried manure may be converted to fertiliser pellets, but with a notable expense for energy consumption.

By regulating (reducing) the pH of slurry, a reduction in both ammonia and methane emissions can be achieved. If performed during in-house storage, slurry acidification (mainly by adding sulphuric acid) prevents these emissions occurring in the slurry management chain.

In the following sections some techniques used for manure processing are described in more detail.

2.7.1 Mechanical separators

Natural settling (gravity sedimentation) is the easiest and cheapest way to remove undissolved material from liquid manure (slurry). It is performed in a thickener, in batch or continuous mode. Most thickeners consist of a container that is cylindrical at the top and conical at the bottom. Slurry is added to the top of a thickener and the suspended solids settle at the bottom of the conical part by gravity from where they can be removed. A secondary function is the provision of storage capacity. However, the process can be inefficient as it requires time and space. Thickeners can also be operated in continuous mode, where the slurry is added continuously, while solid and liquid fractions are removed at the same rate [594, *Agro Business Park 2011*] [203, *ADAS 2005*].

Mechanical separation is another separation process that separates slurry into a stackable solid fraction (solids or fibrous material at around 10–25 % of the initial mass) and a liquid fraction (at around 75–90 % of the initial mass). Separating the suspended solids from slurry means that the two manure streams can be handled separately. With this processing option, nutrients (especially P) and organic matter can be concentrated in the solid phase and transported to other regions without a nutrient surplus. The main process parameters (i.e. throughput, separation efficiency, volume reduction and energy consumption) are influenced by many factors:

- type of the separator;
- sieve mesh size (or centrifugal force);
- slurry type;
- additives (water, flocculants);
- total solid content of the raw manure.

A wide range of mechanical separators are available. Commonly applied techniques include [219, *Netherlands 2010*]:

- Simple screen separators: these have a metal sieve mesh in either a vibrating, inclined or rotary screen. In rotary screen separators the sieve mesh is mechanically cleared of solids using pressure rolls, brusher rolls or scrapers. The separation efficiency is low to moderate.
- Screw separators: these are equipped with a rotating metal or plastic screw or auger that forwards the liquid manure into a cylindrical metal tube fitted with small openings to allow the liquid fraction to be squeezed out. The end of the tube is closed using a piston that provides sufficient back pressure. A properly set back pressure can ensure this process is capable of removing about 25 % of phosphorus from pig slurry. This type of machine can easily be tuned to the specific needs of the farm (e.g. the production of dry solids suitable for composting or a wetter solid fraction with a higher nutrient removal).
- Belt filter presses: these are large separators often used in waste water treatment plants. Manure is fed between two parallel conveyor belts, one of which is permeable to water (the sieve belt). By means of pressure rolls, the liquid fraction is separated from the solid fraction. To establish a high separation efficiency (50–75 % phosphorus removal), additives (flocculants) such as multivalent cations (e.g. FeCl_3) and/or polymer flocculants (e.g. polyacrylamides) are applied to enhance the aggregation of suspended particles. Belt filter presses are designed to yield a highly clarified effluent. Because of their size, belt filter presses are not suitable for mobile separators.
- Centrifuges and decanters (vertically placed centrifuges): separation is achieved through centrifugal forces generated by the rapid rotation of the installed sieve drum. These separators are capable of efficiently removing small particles of high specific density, and are used to dewater sludge in waste water treatment plants. Without chemical additives,

centrifuges can obtain a high phosphorus separation efficiency of 50–70 %. The drawback of these machines is the robustness, the capital cost and the high operating cost [257, France 2010]. Centrifuges can be incorporated in mobile equipment.

Belt filter presses, screw presses and centrifuges may need an initial pre-separation stage or a cutting machine when large solid particles are present in the slurry in order to avoid clogging in parts of the equipment. Screw presses and centrifuges are more susceptible to wear, as a result of the presence of sand, than the other types of separators. Process parameters can be adjusted in slurry separation equipment, allowing optimisation of the separation efficiency.

In general, mechanical separation is performed as a first process step prior to the aerobic treatment of slurry, to reduce the oxygen requirement, and thus the energy needs [257, France 2010]. Composting of the solid fraction can be applied afterwards to enhance its value. Aerobic treatment can be applied to further reduce the nitrogen surplus in the remaining liquid fraction or this fraction is landspread without further treatment. The solid fraction can also be treated by anaerobic digestion. Similar systems to those applied on farm also exist for centralised facilities [264, Loyon et al. 2010].

On the contrary, liquid manure can be converted into solid manure by mixing it with peat. There are mixers for this purpose, which makes this method practicable. Straw or sawdust can also be used as litter material, although Finnish work has shown that peat absorbs water and ammonia more efficiently and also prevents the growth of harmful microbes. This method has been recommended, especially on farms in Finland where the storage capacity of the liquid manure tank is not adequate to accommodate all the liquid manure produced and where building a new tank is not considered profitable. Peat manure is a good soil improvement material for soil that is poor in humus. Liquid manure mixed with peat produces less odours than liquid manure alone; here the carefully mixed liquid manure is pumped into a machine which mixes liquid manure with peat into litter manure.

On the other hand, peatlands are important wetlands and natural ecosystems with a high value for biodiversity conservation and climate regulation. Inappropriate management may lead to their degradation, with major environmental and social impacts, such as significant emissions of carbon gases (CH_4 , CO_2) causing global warming, and a loss of biodiversity and fresh water resources [428, GEC 2008].

2.7.2 Aerobic digestion (aeration) of liquid manure

On some pig farms, aerobic digestion is used to improve the properties of liquid manure such as to reduce odour emissions from pig slurry by the biological oxidation of volatile organic compounds, to decrease pathogens and BOD content, to produce a stabilised and homogenous liquid manure, and, in some cases, to reduce its nitrogen content.

Slurry contains large quantities of nutrients for plants and microorganisms, as well as microbes that are capable of utilising these nutrients. The air conducted into liquid manure starts aerobic decomposition, which produces heat, and as a result of the aeration, bacteria and fungi which use oxygen in their metabolism multiply. The main products from the activity of microorganisms are carbon dioxide, water and heat. The associated heat generation can provide pathogen control.

The main types of biological aerobic system are the following:

- intermittent aeration without any separation;
- intermittent aeration followed by sedimentation of aerated slurry;

- mechanical separation of raw slurry followed by intermittent aeration of the liquid fraction and sedimentation of aerated slurry;
- mechanical separation of raw slurry, followed by intermittent aeration of the liquid fraction, and the mechanical separation of the aerated slurry with the addition of chemical flocculating agents or polymers.

The use of continuous aerobic treatments is declining in favour of intermittent processes (aeration in sequential batch reactors – SBR). The air supply is achieved mostly by surface aerators or by fine bubble diffusers [264, Loyon et al. 2010]. In some cases, aerobic treatment is performed on slurry stored in lagoons [204, IMPEL 2009].

2.7.3 Composting of solid manure

The composting of solid manure is a form of controlled aerobic treatment which can occur naturally in farmyard manure heaps, and that produces a more stable product, with consistent chemical properties, than the initial material. A high porosity (30–50 %) is required for sufficient aeration. In addition, for manure to be composted it has to contain a certain amount of water, to ensure the development of microorganisms [257, France 2010].

Temperatures in the compost heap are between 50 °C and over 70 °C and kill most of the pathogens, thus cleansing the product. A significant water loss also takes place at high temperatures, and compost with a dry matter of up to 85 % can be produced.

Suitability for application depends on the structure of the manure, but requires a minimum dry matter content of 20 %. During composting the manure, which is usually arranged in windrows, is monitored for temperature and moisture; these cannot be excessive as this would inhibit aeration. Treated effluent from manure processing, dirty water or slurry can be added to dry windrows. The compost is turned regularly using a windrow turner or other available farmyard machinery. On the largest units, composting vessels can be used instead of windrows.

Typical FYM heaps do not satisfy the requirements for thorough composting. With controlled application, manure is composted in stacks of a size that suits the aerobic conditions and the use of machinery. Composting can also be performed in a barn (e.g. pre-dried poultry manure). Specific systems have been developed that consist of a combination of tanks with aeration and stirring equipment to enhance the fermentation process and containers or boxes for further fermentation and drying.

For farmers, the main advantage of composting is the significant reduction in the volume of material to be transported and spread. Other potential benefits include efficient decrease in pathogens through generation of heat, reduction in odour, concentration of nutrients and a lighter, friable and more homogeneous product (compost), which is easier to handle than untreated manure. Generally, the physical properties, the stability, and the organic form of the contained nitrogen make compost a good fertiliser and soil improver.

Co-composting is the composting of solid manure with other organic substrates (usually green wastes) and, in general, it is applied to achieve an optimal C/N ratio of around 25–30, in order to ensure efficient composting. The best results are obtained by using well chopped straw and solid manure in the right proportions in long narrow windrows. A biological inoculum can be added to start up the degradation. For easier handling, pelletising can be applied in addition to composting.

Composting installations handling animal manure, which is an animal by-product, must be approved under Regulation (EC) 1069/2009, in accordance with Article 24. The requirements applicable to composting installations, concerning hygiene, operational parameters and standards of derived products are set out in Article 10 and Annex V of Regulation 142/2011/EC.

2.7.4 Anaerobic digestion of manure in a biogas installation

Anaerobic digestion of pig slurry is carried out in a digester in the absence of free oxygen, and consists of the methanogenic anaerobic decomposition of organic matter by microorganisms. The benefits of the process include the production of biogas, the stabilisation and hygienisation of the digested manure (digestate) which can be landspread as a soil conditioner and a source of nutrients (e.g. N and P) with improved N availability for the plants due to mineralisation, compared to the untreated slurry. Less odour is also produced during landspreading. The resulting biogas (approximately 50–75 % methane and 30–40 % carbon dioxide) provides a source of renewable energy, replacing fossil fuel use, which can be used for heating and/or for generating electricity.

Processes can vary with temperature, process management, operating time and substrate mixing. In practice, the mesophilic process (operated in a temperature range of 30–45 °C) is most common for digesters at the farm scale. In large reactors, where the aim is generally to reduce the retention time (and thus the reactor volume required), the thermophilic process is applied, which runs at a higher temperature (50–55 °C). In the case of joint biogas plants (shared by several farmers), the thermophilic process is also preferred, in order to achieve improved sanitisation [257, France 2010].

On the other hand, bacteria are very sensitive to temperature changes and this sensitivity increases with higher temperatures. Moreover, a higher temperature shifts the equilibrium of nitrogen towards more ammonia production, which renders the process vulnerable to ammonia inhibition (too much ammonia is toxic for methanogenesis bacteria).

The anaerobic digestion can be carried out either in intermittent or continuous mode. Continuous systems are the most common. Here the digester receives a continuous flow of substrate (e.g. slurry), for an average residence time of the mass of 50–60 days, whilst an identical volume of digested matter is expelled daily. The plant is in operation throughout the year; the accruing biogas is produced continuously and may be stored in gas bags and used in combined heat and power (CHP) production units, or burnt directly to provide heat, including for the digester. The waste heat of the biogas engine is used to heat up the digester. The biogas can also be upgraded for direct use in the natural gas grid, or for producing a fuel that can be used for applications in transportation.

In discontinuous (batch) systems, the digester is charged with various substrates and is hermetically closed. During the fermentation (2 to 4 weeks), the matter is degraded and the digester is then emptied. In this system, the volume of produced biogas and its composition are not constant over time. For this reason, several digesters are installed in parallel operating in shifts [257, France 2010] [345, France 2010].

Slurry is ideally suited to anaerobic digestion, as it is easy to transfer and use, it has a high load of fresh bacteria, it is easily manipulated, it can be used to dilute other substrates, and it has a strong buffer effect (stabilises the pH), which facilitates the bacterial reactions and ensures the stability of the environment where the reaction takes place. Organic wastes, energy crops and solid pig and poultry manure or the solid fraction from mechanically separated slurry are conveniently used to raise the dry matter content (which increases the yield and reduces heating needs), but conversely incur an additional cost for the increase in energy use. Mixing of the mass has been reported to be more difficult for dry matters higher than 10 % in the digester [257, France 2010].

High initial installation costs are a major deterrent but can be overcome with targeted renewable energy incentives or other rewards for the multiple environmental benefits of the anaerobic digestion. Anaerobic digestion by the dry process based on solid manure is currently not very developed but is a promising technique for the future as it requires less investment.

2.7.5 Anaerobic lagoon system

Lagoons serve as a store for pig slurry and waste water, as well as for the biological anaerobic treatment of the slurry under ambient temperature conditions. The treatment system may involve mechanical separation of the solids and the subsequent separate treatment of solids and liquids. A mechanical separation of slurry before entering the lagoon system can prevent the capacity of the lagoon being reduced by sedimentation of sludge, and also reduces the organic matter in the liquid part.

Slurry or the liquid fraction from mechanical separation is put into a settling basin or lagoon, from which it overflows or is pumped into the anaerobic lagoon system (often three to five earth-banked structures). The capacity of the lagoon that first receives the slurry is reduced over time by the sedimentation of the solid fraction, and needs to be desludged from time to time.

The liquid from the second lagoon is sometimes used for flushing the pits under the pig pens. It is believed that the second lagoon provides a certain degree of protection against disease-carrying organisms carried over from the first lagoon.

The anaerobic conditions inside the lagoon can lead to emissions of gases like methane and nitrous oxide which are related to the lagoon's surface size. The slurry and air temperature affect the biological activity in the lagoon, by changing the type of predominant methanogenic bacteria between psychrophilic and mesophilic. Methane emissions are also affected by the wind turbulence, that removes CH₄ from the lagoon surface and the atmospheric-boundary layer just above.

The solid fraction can be used for landspreading; the liquid part after the anaerobic treatment may be directly applied to land, or, in a few cases, it may comply with local legal requirements for discharge into watercourses [364, Portugal 2010]. Designs are country- and site-specific: for example, in Italy, covers are also used to collect biogas.

2.7.6 Manure additives

Under the generic denomination of manure additives is a group of products made up of different compounds that interact with the manure, changing its characteristics and properties. The following positive effects are claimed and are described to different degrees in the label of every product:

1. a reduction in the emission of several gaseous compounds (NH₃ and H₂S);
2. a reduction of unpleasant odours;
3. a change in the physical properties of the manure to make its use easier;
4. an increase in the fertilising value of the manure;
5. a stabilisation of pathogenic microorganisms.

Usually, items 1, 2 and 3 are the main reasons for their use at farm level. Below, the five groups of techniques are detailed.

1. Additives for reducing the emission of several gaseous compounds. The decrease in gaseous emissions achieved through their use (mainly NH₃ and H₂S) is one of the most interesting yet controversial points. It has been well documented that up to 90 % of the N produced by pigs is in the form of urea. When the urease produced by faecal microorganisms comes into contact with urea, the following reaction occurs:

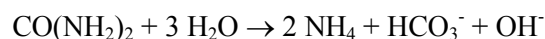

coupled with the following equilibrium reaction NH₃/NH₄⁺:



One mole of urea may generate two moles of ammonia. The hydrolysis of urinary nitrogen (urea) to ammonia is rapid. Urea spread on a concrete floor starts releasing NH_3 in 2–2.5 minutes [277, Ji-Qin et al. 2000].

This reaction is highly influenced by temperature and pH, for example, under 10°C or at a pH below 6.5 the reaction stops. Acid addition to lower the pH and the addition of urease inhibitors to prevent the hydrolysis of urea both offer a strategy for significant control of ammonia emissions from livestock facilities, thus increasing the fertiliser value of slurry.

2. Additives for reducing unpleasant odours. Several types of additives, with different characteristics, may be employed for reducing odours from manure: masking, blocking, absorbing agents, microbiological agents, and chemical additives.

Odour results from the mix of different compounds under anaerobic conditions. More than 200 substances have been identified as causing odours, such as:

- volatile fatty acids;
- alcohols (indol, skatole, p-cresol, etc.);
- H_2S and derivatives;
- ammonia;
- other N compounds (amines and mercaptans).

A huge variation in the proportion and concentration of odour agents exists, depending on the type of farm, nutrition and nutritional management, and climatic conditions. This could explain why the effectiveness of these compounds against odours is not predictable under farm conditions.

3. Additives for changing the physical properties of the manure. The objective of these additives is to make the manure easier to handle by changing the physical properties of the manure, resulting in an increase in manure flow and the elimination of superficial crusts. In particular, these additives may have an effect on the dry matter content and viscosity of the manure; however, these effects are not always found.

Their application might make the cleaning of the manure pits easier, and thereby might shorten the cleaning time required and allow savings in water and energy consumption. Moreover, since the manure is more homogeneous, it facilitates the manure's agricultural use (better dosing).

4. Additives for increasing the fertilising value of the manure. As a consequence of the use of additives for reducing NH_3 emissions (e.g. pH modification), higher levels of N are retained in the manure. In other cases, through an increased synthesis of the microbial cells (use of microbiological agents), higher levels of organic nitrogen are achieved.

5. Additives for stabilising pathogenic microorganisms. There are many different microorganisms in manure, some of which contribute to the gaseous emissions and odours. It is also possible to find faecal coliforms and salmonella and other pig or poultry pathogens, viruses, eggs of flies and nematoda in the manure.

Usually, the longer the storage period, the higher the decrease in pathogens, because of the different requirements of temperature and pH. The pH decreases within the first month of storage (from 7.5 to 6.5 because of the microbial synthesis of volatile fatty acids) which has a negative effect on pathogens survival. Some of the manure additives have been designed to especially control the eggs of flies.

Nowadays, there are many manure additives on the market, with different characteristics and purposes; but their efficacy has not been demonstrated in every case. Information concerning the performance and applicability of different additives is presented in Section 4.12.12.

It has to be highlighted that in many cases the effects on human or animal health or on the environment of using additives are not known and this, of course, limits their applicability [405, Tengman C.L. et al. 2001].

2.7.7 Slurry acidification

Acidification of slurry is a commonly used technique in a few countries (e.g. Denmark) with a high potential to reduce ammonia emissions. By adding acid (usually sulphuric acid), the pH of the slurry is lowered to around 5.5, and thereby the ammonia volatilisation is reduced or inhibited. Nitrogen is retained in the manure in the form of ammonium and is available to crops when the manure is spread on the field.

The technique can be applied in manure stores and/or animal houses using an automatic dosing system (see Section 4.12.9), but it is also possible to acidify the slurry in the tank immediately before landspreading. Another alternative is to continuously acidify it in a system directly mounted on the slurry spreader. In this case, the acidified slurry is spread with standard equipment (e.g. trail hoses) and an additional acid tank is placed in front of the tractor.

2.8 Manure landspreading techniques

A range of equipment and techniques are used to spread slurry and solid manure to land. These are described in the following sections. Much of the manure was used to be landspread using machinery which spreads manure over the whole soil surface ('broadcast') by throwing it into the air. In some countries (e.g. the Netherlands, Denmark and Belgium-Flanders), the use of band spreaders and injectors for slurry is required to reduce emissions. In many other countries, these techniques are also becoming increasingly popular. Solid manure is broadcast after being chopped or shredded into smaller pieces. Manure should be incorporated into soil by ploughing, discing or using other suitable cultivation equipment and, in some Member States, this is a legal requirement. Contractors are often used for manure landspreading and manure is not always spread on the producer's own land.

Directive 91/676/EEC, the Nitrates Directive, lays down minimum provisions on the manure landspreading, with the aim of providing all waters with a general level of protection against pollution from nitrogen compounds, and additional provisions for manure landspreading in designated Nitrate Vulnerable Zones. The measures include nitrogen content limits for manure, closed periods when some types of manure (high in available N) cannot be spread to grassland and arable land (on sandy and shallow soils), and the identification of other situations when manure should not be applied. In France for example, the dates for manure landspreading vary according to the C/N ratio i.e. type I with $C/N > 8$ (solid manure except poultry manure), or type II ($C/N < 8$ (solid poultry manure and slurry) [[257, France 2010](#)]. In other countries (i.e. Denmark), nitrogen quotas for each farmer have been introduced, in order to avoid unnecessarily high application levels of nitrogen per hectare of land.

In many countries, legislation governing the manure landspreading aims at balancing the amounts of manure applied with the nutrient requirements of the crop. Indeed, the Nitrates Directive is based on this approach, by requiring action programmes and codes of good agricultural practice, including measures for regulating the periods when landspreading is prohibited, in such a way that fertilisers (including manure) are spread only in periods when there is a crop available that can benefit from the nutrients applied to the field. Depending on legislation, weather conditions and field crops cultivated in different regions of Europe, there are different seasons and practices applied for manure landspreading. In other countries and areas, where landspreading is not controlled by specific legislation, spreading practices can rely upon published guidelines, such as codes of good practice.

In a number of countries (e.g. Ireland, Sweden, Estonia, Finland, Germany, Belgium-Flanders, Denmark, Lithuania, Latvia and Poland), the phosphorus load is used as a limiting factor as well, either as a legal constraint or as a recommendation only.

Ammonia volatilisation is reduced by using spreading machinery which decreases the exposed surface area of manure applied to the surface of soil or burying manure through injection or incorporation into the soil. However, many factors influence the volatilisation of ammonia after landspreading of the manure. Abatement efficiencies will also vary depending on these factors.

In particular, emissions of ammonia as a percentage of TAN applied are normally decreased with decreasing air temperature, wind speed, solar radiation and slurry DM content [[508, TFRN 2014](#)]. For example, an increase in wind speed of 1 m/s increases the ammonia loss by 10 % (expressed as percentage of TAN) [[260, IGER 2001](#)].

In addition, emissions of ammonia as a percentage of TAN applied are normally decreased with increasing TAN concentration and application rate. Emissions from different manure types will also vary. Emissions are also dependent on soil conditions that affect infiltration rates. For example, well-draining, coarse textured, dry soils, which allow faster infiltration, will give rise to lower emissions than wet and compact soils with reduced infiltration rate. However, when very dry, some soils may become hydrophobic, which can also reduce infiltration and therefore increase emissions [[508, TFRN 2014](#)]. In addition, the decrease of the volatilisation rate with

time elapsed after application is significant for all application methods [232, Huijsmans et al. 2009].

The viscosity of slurry, which is determined by the content of organic particles, and its tendency to stick to the soil have an influence on ammonia volatilisation. A slurry with a high viscosity will increase NH₃ emissions, by reducing the infiltration of liquid with dissolved TAN into the soil during landspreading. It has been observed for example that digested slurry penetrates the soil more easily and rapidly, not sticking to the surface as much as raw manure [517, Petersen et al. 2011].

If properly applied, manure landspreading has benefits in terms of saving mineral fertiliser, improving soil conditions as a consequence of the addition of organic matter, and in reducing soil erosion. When manure is not properly applied, losses of the applied nutrients occur by volatilisation, leaching through soil layers, running through to field drainage systems and via run-off. Manure application techniques differ in the placement of the manure on the grass or the soil surface. As can be seen in Figure 2.30, the contamination of the vegetation and the exposed surface of the manure is different between application techniques.

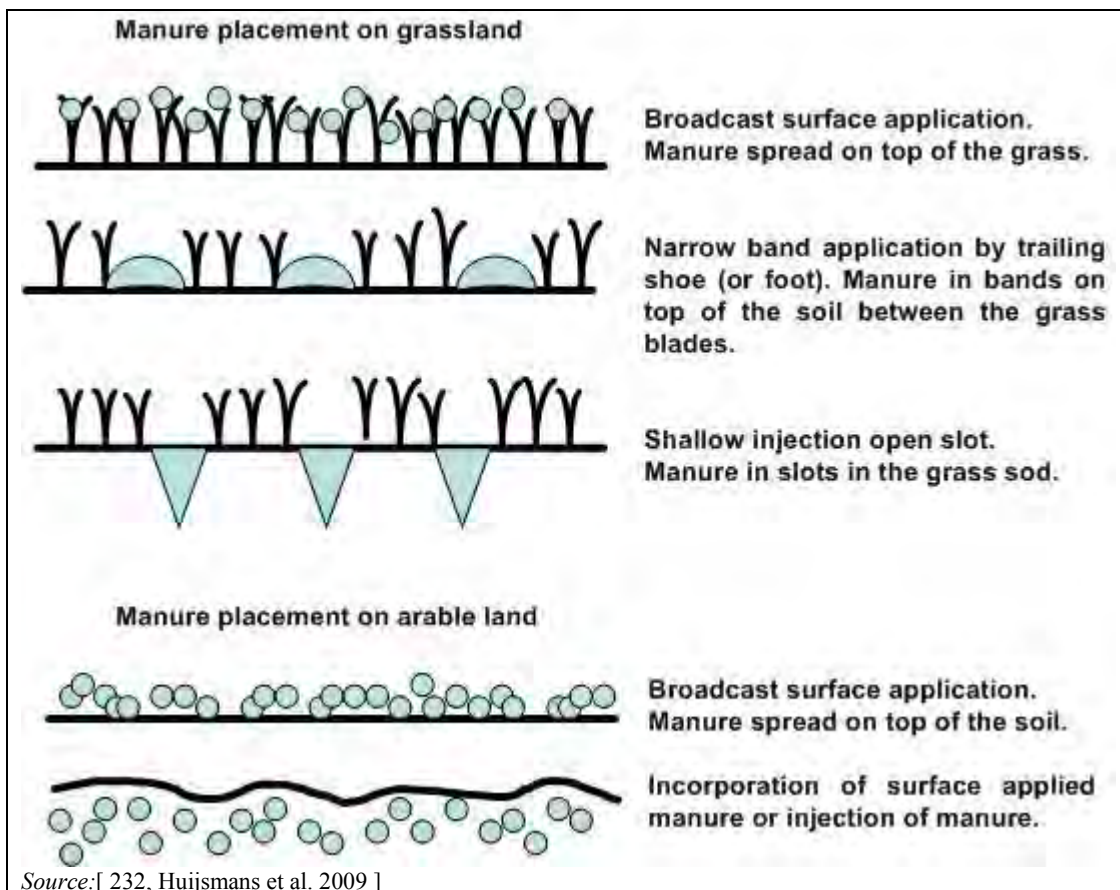

Figure 2.30: Placement of the manure when applying manure with different application and incorporation methods

Energy consumption and soil compaction related to the spreading equipment can also be considered. Landspreading techniques and equipment, which are detailed in the following sections, vary depending on type of manure, land use and structure of the soil.

2.8.1 Slurry transport systems

There are four main types of slurry transport systems used in Europe that can be used in combination with different slurry distribution systems. The features of these transport systems are set out in Table 2.21 and are discussed below.

Table 2.21: Qualitative comparison of four slurry transport systems

Features	Transport system			
	Slurry tanker (vacuum)	Slurry tanker (pumped)	Umbilical hose	Irrigation equipment
Range of dry matter	Up to 12 %	Up to 12 %	Up to 8 %	Up to 3 %
Requires separation or chopping	No	No (centrifugal) Yes (PD pump)	No (centrifugal) Yes (PD pump)	Yes
Work rate	●●●	●●	●●	●● (Depends on field size/shape)
Accuracy of application rate	●	●● (centrifugal) ●●● (PD pump)	●● (centrifugal) ●●● (PD pump)	●●
Soil compaction	●●●	●●●	●●	●
Capital costs	●	● (centrifugal) ●● (PD pump)	●●●	●●
Labour requirement per m ³	●●●	●●●	●●	●
NB: Number of bullets (●) indicate input level or value, e.g. irrigator requires low labour input.				
Source: [390, ADAS 2001]				

A slurry tanker can have a built-in tractor unit or can be built on a chassis with engine and cab for slurry transport in longer distances. When no there is independent motor unit in the tanker, a tow-bar exists for towing by a tractor.

The slurry is sucked into the vacuum tanker by using an air pump to evacuate the air from the tank to create a vacuum; the tanker is emptied using the air pump to pressurise the tanker, thereby forcing the slurry out, commonly onto a splash plate. It can be used for most slurry transport and has a versatile applicability.

Alternatively, the slurry can be pumped into and out of the tanker using a slurry pump, either a centrifugal (e.g. impeller-type) or positive displacement pump (PD pump), such as a lobe-type pump. Some tankers fitted with a centrifugal pump only pump manure out and must be filled with a separate pump. The pumped tanker generally has better spreading precision (m³ or tonnes/ha) than vacuum tankers. PD pumps require more maintenance.

In the case of an umbilical hose, the slurry is fed to the distribution system from a short-term stationary tank or directly from the store via a long flexible hose mounted directly on the rear of the tractor. The hose is supplied with slurry by a centrifugal or positive displacement pump. There is possible crop damage as the hose drags across the ground; hose damage and wear can especially be a problem on abrasive or flinty ground. The umbilical hose tends to be used where higher application rates are possible and on wetter soils where heavier machinery would mark the land (with increased potential for run-off). In general, the risk of soil damage by compaction caused by heavy slurry tankers is reduced. However, it is time-consuming to roll out hoses and roll them back in again.

Slurry or waste water can also be transported through pipes, commonly underground, leading to a length of flexible pipe on the surface connected to an irrigator (see Section 2.8.2.2). The irrigator can be a self-propelled machine with flexible or reeled-in hoses, fed from a centrifugal or positive displacement pump, situated near the slurry store. It is suitable for semi-automatic operation, but anti-pollution safeguards are needed (e.g. pressure and flow switches). Irrigators tend to be associated with high application rates.

2.8.2 Slurry landspreading systems

2.8.2.1 Broadcast spreader

Slurry is spread over the whole surface of an area of land or crop. The broadcast spreader is often considered the reference system when comparing techniques for reducing ammonia emissions. The technique is rapid and inexpensive, but the distribution is typically uneven, especially in windy conditions, and the application of nutrients to the crops inconsistent, largely due to ammonia volatilisation. The use of broadcast spreading is restricted by the risk of crop quality deterioration or damage caused by slurry contamination. The diffusion of odours and the risk of pathogen spreading with drifting droplets are other drawbacks of this technique. Broadcast spreaders are not authorised in many countries (e.g. in Denmark and in Ireland where an upward facing splash plate is not permitted).

With broadcast spreaders, ammonia losses after application are reported to be in the range of 40–60 % of the total ammoniacal nitrogen applied (TAN), although emissions outside this range are also common [508, TFRN 2014]. Ammonia losses are greater from broadcasting slurry on stubble than on bare soil, particularly if the slurry has a high dry matter content, because of increased exposure to the air and a reduced infiltration rate.

The combination of a tractor with a tank with a broadcast spreader at the rear is shown in Figure 2.31. The untreated slurry is forced under pressure through a discharge nozzle, often onto an inclined plate (i.e. a splash plate) to increase the area over which it is distributed.



Source: [390, ADAS 2001]

Figure 2.31: Example of a broadcast spreader with a splash plate

Figure 2.32 shows a hose-reel irrigator with a ‘raingun’ attached to a moveable trolley, which is also a broadcast spreader. The trolley is pulled out to about 300 metres with its supply pipe and is wound back to the reel (using the supply hose) where it automatically shuts off. Dilute slurry is pumped to the hose-reel from the slurry lagoon via a main pipe – often buried underground and with valved outlets in a number of places in the field. The applicator in this picture is the ‘raingun’ that operates at a high connection pressure [408, UK 2002].



Source:[408, UK 2002]

Figure 2.32: Example of a raingun

Broadcasting can also be operated by low trajectory machines, which discharge at a relatively low angle to the land, and at a low pressure to produce large droplets, to avoid atomisation and wind drift. Figure 2.33 shows a tractor applying dilute pig slurry through a boom with two splash plates to a crop of winter wheat. The slurry is supplied to the tractor/boom using an umbilical hose from the slurry lagoon.



Source:[408, UK 2002]

Figure 2.33: Example of a broadcast technique with low trajectory and low pressure

Figure 2.34 shows the same type of boom applicator with two splash plates, but this time on the back of a tractor and tanker combination. Slurry is supplied from the tanker and is spread, again, with a low trajectory and at low pressure.



Source: [408, UK 2002]

Figure 2.34: Example of a broadcast technique with low trajectory and low pressure

2.8.2.2 Irrigators

Irrigators are devices for slurry or waste water landspreading. There are static irrigators such as sprinklers and rainguns that have to be moved manually to apply slurry to different parts of the field, and mobile (or travelling) irrigators that are self-propelled and normally travel in preset lines across the field. For both types, the liquid is forced through nozzles that are designed to rotate or oscillate to distribute the liquid as relatively small droplets over a wide area. Travelling systems can be equipped with a specifically designed application boom. Irrigation is suitable only for slurries that can be pumped through long lengths of pipe and discharged through small nozzles without causing blockages.

Low-pressure irrigators (e.g. sprinklers) are designed for applying irrigation water to crops at low pressures and flow rates. Rainguns, usually fed by a hose, are devices for applying irrigation water to crops at very high pressures in order to shoot the liquid over relatively long distances. Systems with pressures higher than 2 bar at the hose are prohibited in some Member States, as they can generate aerosols that are potential sources of microbiological contamination.

Dilute slurry or the liquid fraction from mechanical separation (less than 2 % dry matter content) can be landspread by irrigation systems, including rainguns, boom-mounted splash plates and rotary boom systems. The rear and side views of a mobile irrigation system, consisting of a horizontal boom with splash plates, are shown in Figure 2.35 and Figure 2.36.



Source: [247, IGER 2003]

Figure 2.35: Rear view of a horizontal boom with splash plate for slurry application



Source: [247, IGER 2003]

Figure 2.36: Side view of a horizontal boom with splash plate for slurry application

2.8.2.3 Low-pressure irrigator

The system is based on the use of controlled amounts of slurry or liquid fraction from mechanical separation of slurry which are mixed with irrigation water and are distributed at a low pressure by irrigation systems such as pivots or sprinklers. These systems are widely used. More information is reported in Section 4.13.4.2.1, including a picture of a typical irrigator (see Figure 4.95) [242, CRPA 2009].

2.8.2.4 Band spreader (or trailing hose)

Band spreading is commonly referred to as 'trailing hose', but it is also known as 'drag hose' and 'drop hose'. Band spreaders are machines for the application of slurry to the land surface in parallel bands with no slurry applied between the bands. Band spreaders discharge slurry at or just above ground level in strips or bands through a series of hanging or trailing pipes attached

to a boom. The band spreader is fed with slurry from a single pipe, and thus relies on the pressure at each of the hose outlets to provide an even distribution. Most systems use rotary distributors to supply the slurry evenly to each outlet. The width is typically 12–28 m with about 30–50 cm between bands (see Figure 2.37). Band spreading systems are normally fitted to the rear of slurry tankers but they can also be mounted at the rear of a tractor (umbilical system).

The technique is applicable to grass and arable land, e.g. for applying slurry between rows of growing crops. Band spreading applies manure more uniformly than broadcasting and enables higher yields [254, Webb J.M. et al. 2009].



Figure 2.37: Example of a band spreader fitted with rotary distributor to improve lateral distribution

2.8.2.5 Trailing shoe spreader

This is a similar configuration to the band spreader with a 'shoe' device added to each hose designed to part crop or grass leaves and stems and deposit the slurry in bands under the crop canopy on the soil surface. It is also known as 'drag shoe' and 'sleighfoot'.

This technique is mainly applicable to grassland. Grass blades and stems are parted by trailing a narrow shoe or foot over the soil surface and slurry is placed in narrow bands on the soil surface at 16–35 cm intervals, therefore contamination of the foliage is minimised. The slurry bands should be covered by the grass canopy so the grass height should be a minimum of 8 cm. The machines are available in a range of widths up to 6–16 m [575, UBA Germany 2011].

2.8.2.6 Injector (open slot)

Slurry is placed in slots cut into the soil to various depths depending on the type of injector. The slots cut in the soil are left open after filling with slurry. There are various types of injectors but each falls into one of two categories; either open slot shallow injection, up to 50 mm deep; or deep injection, typically about 150 mm deep. These normally comprise an array of injector units mounted on a tanker or at the rear of a tractor (umbilical system). Slurry is normally fed from

the tanker or umbilical hose system to a rotary distributor that serves to chop and homogenise the manure and to supply it evenly to hoses attached to each injection unit.

Open slot injectors are mainly for use on grassland, especially on relatively short grass, e.g. after cutting or grazing. Different shaped knives or disc coulters are used to cut vertical slots in the soil up to 5–6 cm deep into which slurry is placed (Figure 2.38). The spacing between the slots is typically 20–30 cm, with a typical working width of 6 m that can reach 9–12 m. The application rate must be adjusted so that excessive amounts of slurry do not spill out of the open slots onto the soil surface.



Source: [563, MARM 2011]

Figure 2.38: Example of an open slot injector

2.8.2.7 Injector (closed slot)

Slurry is landspread by placement in deep, vertical slots, cut into the soil by specially designed tines. This technique can be shallow (5–10 cm depth) or deep (generally 10–15 cm, or up to 20 cm). Slurry is fully covered after injection by closing up the slots with press wheels or rollers, possibly fitted behind the injection tines. Shallow closed slot injection is more efficient than open slot for decreasing ammonia emissions. To obtain this added benefit, soil type and conditions must allow for effective closure of the slot. The technique is, therefore, less widely applicable than open slot injection.

Deep injection can be used effectively to spread high quantities of slurry at one time. Deep injectors usually comprise a series of tines, potentially fitted with lateral wings or ‘goose feet’, to aid lateral dispersion of slurry in the soil, so that relatively high application rates can be achieved. Tine spacing is typically 20–40 cm, and the working width 3–6 m although it can be up to 12 m. Although ammonia abatement efficiency is high, the applicability of the technique is severely limited. The use of deep injection is restricted mainly to arable land because

mechanical damage may decrease herbage yields on grassland. Other limitations include soil depth and the clay and stone content, the slope, and a high draught force requiring a large tractor. Also, in some circumstances there is a greater risk of nitrogen losses as nitrous oxide and nitrates. However, the technique is widely used in some Member States. A variation of the technique rarely used is the direct ground injection system; this forces finely separated slurry under pressure into the soil with little soil disturbance.

2.8.3 Solid manure landspreading systems

For landspreading of solid manure, three main types of spreaders are commonly used:

- Rotaspreeder (see Figure 2.39): a side discharge spreader which features a rotating shaft fitted with spinning flails running along its length. As the rotor spins, the flails throw the solid manure out to the side.



Source: [390, ADAS 2001]

Figure 2.39: Example of a rotaspreeder

- Rear discharge spreader (see Figure 2.40): a trailer body fitted with a moving floor or a conveyor which delivers solid manure to the rear of the spreader. The spreading mechanism can have either vertical or horizontal rotating beaters, spinning discs or a combination of beaters and spinning discs.



Source: [390, ADAS 2001]

Figure 2.40: Example of a rear discharge spreader

- Dual-purpose spreader: a side discharge spreader with an open-top V-shaped body capable of handling both slurry and solid manure. Fast-spinning impellers or blades, usually at the front of the spreader, throw manure from the side of the machine. The rotor is fed with material by an auger or a conveyor fitted in the base of the spreader. The spreader can be adjusted to spread either slurry or solid manure, usually through varying the aperture of the outlet adjacent to the distributor mechanism (e.g. a sliding gate controls the flow rate of the manure onto the rotor) (see Figure 2.41).



Source: [390, ADAS 2001]

Figure 2.41: Example of a dual-purpose spreader

A quality comparison of the characteristics of solid manure spreaders is presented in Table 2.22.

Table 2.22: Comparison of solid manure spreading systems

Features	Spreading system		
	Rotaspreader	Rear discharge spreader	Dual-purpose spreader
Suitability for slurry	No	No	Yes
Work rate	●●●	●●●	●●●
Accuracy of application rate	●	●●●	●●
Lateral precision	●	●●●	●●
Soil compaction	●●●	●●●	●●●
Ease of determining overlapping of adjacent runs	●	●●●	●●
Relative costs	●	●●	●●●

NB: Number of bullets (●) indicates the input level or value, e.g. rotaspreader has a low accuracy of application rate.

Source: [390, ADAS 2001]

Spreaders with a narrow tank-case are most often used, allowing the use of wheels of a large diameter that need limited traction power. High-capacity spreaders are equipped with large tanks. Regular spreading and relatively low soil compression are possible using spreaders with a double axle. Spreading devices used are mainly vertical drums (see Figure 2.42) and deflector plates; the old spreaders with two horizontal drums are not favoured because of the low spraying width.



Source: [257, France 2010]

Figure 2.42: Vertical drum manure spreader

Vertical drums are suitable for solid manure with more than 400 kg/m^3 . Drums of a large diameter are preferred. The spraying width is 6–12 metres. Drums are mechanically simple and require relatively low power.

Deflector plates with horizontal drums have a more general purpose, being more suited to lower density solid manure. The spraying width is wider, from 10 to 12 metres and adjustable shutters optimise the transverse distribution for an achievable load of 4–6 tonnes of solid manure per hectare. Some models allow discs to be tilted to provide an even spread right up to the spreading boundary, in the same way as fertiliser spreaders do. Spreading is successful if three conditions are met [257, France 2010]:

- the manure to spread is suitable for the equipment to be used;
- the mass is well homogenised before it is loaded on the spreader;
- the equipment is adjusted so that manure is evenly spread to the desired amount.

An accurate application of nutrients demands a uniform spread pattern. The coefficient of variation for a machine's spread pattern is a measure of the uniformity of spread achieved, both laterally and longitudinally. A high number indicates a poor uniformity. Research suggests that manure spreaders should be chosen and operated to give a coefficient of variation of less than 25 % [390, ADAS 2001].

2.8.4 Incorporation

After landspreading, manure is mixed into the soil or buried using appropriate cultivation machinery. Incorporation may be achieved with a plough or other types of equipment such as discs or cultivators, depending on the soil type and soil conditions. Incorporating the manure spread on the surface into the soil is an efficient means of decreasing ammonia emissions. The manure must be completely buried under the soil to achieve maximum efficiency.

As ammonia losses take place quickly, higher reductions in emissions are achieved when incorporation takes place immediately after landspreading. At the same time incorporation will reduce the development of odour in the vicinity of the manure-covered land.

Efficiencies depend on the cultivation machinery; ploughing is mainly applicable to solid manure on arable soils. Ploughs are more efficient but much slower than rotor harrows; therefore, manure remains uncovered on the soil for a longer time, with consequent ammonia

emissions. For this reason, the overall effect may be that ploughing is less efficient than other incorporation techniques.

Where injection techniques for slurry are not possible or unavailable, incorporation may also be carried out after slurry spreading, by means of conventional soil cultivation equipment.

2.9 On-farm transport

The scale of transport operations on farms depends on the farm size, farm layout and the location of fuel storage areas, feed stores and feed processing, livestock buildings, product processing (for example egg packing and grading), manure storage, and fields for applying manure to land.

Feed is usually mechanically or pneumatically handled, and in pig units using wet feed, feed is pumped to feeding troughs.

Typically, tractors are used as the prime means of manure transport and landspreading, although in some pig units, slurry irrigation using pumps and pipelines is practised. Many farmers use contractors who typically possess larger equipment and occasionally self-propelled vehicles with mounted 'spreader' bodies. Tractor-mounted slurry scrapers or loaders/grabs are used for moving manure around buildings and concrete areas, but in some egg-laying systems manure is moved mechanically by belts and conveyors.

Eggs are usually mechanically handled through to packing, where forklift trucks assist the loading of lorries for road transport. Forklifts are also used to transfer crates containing birds from broiler housing to road transport vehicles.

Material handlers (a specialist form of tractor) are used on some sites to undertake a variety of tasks around the farm buildings. The movement of road transport lorries around the farm can be extensive in large integrated egg production enterprises dealing with production output and inputs such as birds, feed, fuel, and packaging. Some sites carry out egg grading and packing for other producers.

2.10 Maintenance and cleaning

Maintenance and cleaning primarily relate to equipment and housing. Paved areas of the farmyard can also be cleaned by sweeping or by spraying with water. In the UK and Spain, farmers report that modern building materials are easier to clean than older ones, resulting in water and labour savings.

General building maintenance is necessary, including feed handling systems and other conveying equipment. Ventilation systems are checked for the correct operation of fans, sensors, temperature controllers, outlets and back-draught shutters and emergency provisions. Drinking water supply equipment is checked regularly. The provision and maintenance of appropriate conditions for keeping livestock are required to meet welfare legislation and to reduce emissions of odour.

Regular maintenance (refurbishing and repairs) and cleaning of vehicles, such as tractors and manure spreaders, also takes place. Regular checks should be made during operational periods, also with appropriate maintenance as described in the manufacturers' instructions. These activities usually involve the use of oil and cleaning agents and can require energy for equipment use.

Many farms have a supply of faster wearing parts in order to carry out repairs and maintenance quickly. Routine maintenance and cleaning are carried out by suitably trained farm staff, but more difficult or specialist maintenance work is carried out with specialist assistance.

Buildings are usually cleaned and disinfected after batches of livestock and manure have been removed. As a minimum, the frequency of cleaning is therefore equal to the number of production cycles per year.

Typically in pig units, wash-down water enters the slurry system, but in poultry units such contaminated water is often collected separately in (underground) storage tanks, before landspreading or treatment. Good hygiene practices are required in other building areas where products are handled and packed ready for dispatch.

For cleaning, use is often made of high-pressure washers using only water, but surface-active agents are sometimes added. For disinfecting, disinfection agents are applied with an atomiser or sprayer. Disinfection is not a procedure normally applied, and is usually only carried out in the case of disease outbreaks (e.g. salmonella), and also as a prevention measure in order to avoid them.

2.11 Use and disposal of residues

The operation of a pig or poultry farm gives rise to a number of different residues, some of which are identified in the following list:

- wood;
- pesticides;
- veterinary products and wastes, whose collection and specialised disposal is primarily used in order to prevent inappropriate use of needles, syringes and products as well as minimising infection risks;
- vehicle and machinery waste, such as tyres, oils and lubricants;
- scrap metals;
- packaging (rigid plastic, film plastic, cardboard, paper, glass, pallets, etc.);
- feed wastes (spilt or spoiled feeds);
- building wastes (cement, asbestos and metal);
- waste from electrical and electronic equipment (e.g. fluorescent tubes);
- waste from diagnosis, treatment or prevention of disease (e.g. sharps), whose collection and disposal is subject to special requirements in order to prevent infection.

The processing of manure, carcasses and waste water is subject to special provisions and is dealt with in Section 2.8, Section 2.12 and Section 2.13 respectively.

Most of the residues are paper and plastic packaging material. The most common hazardous residues are those from medicines that have been used or that are past their expiry date. Small amounts of residues of cleaning material or of chemicals necessary to operate special processes (e.g. air scrubber) may be found on a farm as well.

In general, in larger farms, residues can be more economically disposed of than on small farms. For collection, the residues are stored in containers or in small bins and collected by municipal or special collection services. Where no public waste collection is organised, farms may be obliged to organise collection and transportation themselves and are responsible for associated costs and treatment (e.g. in Finland). Collection is difficult to organise in remote areas.

Off-farm waste handling includes disposal or treatment routes such as:

- landfilling;
- storage in dustbins, including in household collection;
- collection by suppliers;
- transferal to contractor;
- recovery or treatment of waste (e.g. oil recovery).

Oils are stored in purpose-designed cans/containers and are collected to be treated off farm. Veterinary residues are stored in special boxes and sometimes collected by the veterinary service or by licensed operators offering waste disposal services.

Plant waste residues, like feed and crop waste residues, can be mixed with farmyard manure or slurry and landspread, or are reused in other ways. Tyres are dealt with in different ways, varying between collection by suppliers, stockpiling, use in construction as tyre bales, use in silage as clamps, or use as crash barriers. In general, waste management (storage, transport, disposal or treatment) needs to be carried out in compliance with the provisions of the Waste Framework Directive (2008/98/EC).

2.12 Storage and disposal of dead animals

The procedures for the collection, storage and disposal of dead animals and carcasses are prescribed by Regulation (EC) 1069/2009 of 21 October 2009 and its corresponding implementing Regulation (EC) 142/2011 of 25 February 2011, laying down health rules regarding animal by-products and derived products not intended for human consumption, which repealed Regulation (EC) No 1774/2002 (Animal by-products Regulation). In particular, Regulation (EC) 1069/2009 classifies on-farm dead pigs and poultry as Category 2 material, in accordance with Article 9, and specifies all the necessary conditions to ensure that management of dead animals is carried out properly, in authorised dedicated plants, in order to prevent the possible spread of pathogens.

According to Article 13 of Regulation 1069/2009, possible disposal procedures for Category 2 material are:

- disposal as waste by incineration or co-incineration;
- disposal in an authorised landfill, following processing by pressure sterilisation and permanent marking of the resulting material;
- used for the manufacturing of organic fertilisers or soil improvers to be placed on the market in accordance with Article 32 following processing by pressure sterilisation, when applicable, and permanent marking of the resulting material;
- composted or transformed into biogas following processing by pressure sterilisation and permanent marking of the resulting material;
- used as a fuel for combustion with or without prior processing;
- used for the manufacture of derived products referred to in Articles 33, 34 and 36 and placed on the market in accordance with those Articles.

Some farms have an installation for incineration of dead animals. On-farm incinerators for the disposal of fallen stock which incinerate only animal carcasses are exempted from Chapter IV and Annex VI of the Industrial Emissions Directive (2010/75/EU) and are instead regulated by Regulation (EC) 1069/2009. Specifically, they must be approved in accordance with Article 24 of Regulation (EC) 1069/2009 and must comply with Article 6 and Annex III of Regulation (EC) 142/2011, in particular concerning hygiene conditions, operating conditions, residue disposal requirements, temperature measurement requirements and requirements for dealing with abnormal operating conditions. In addition, specific requirements for operating conditions and water discharges are set out for high and low capacity plants.

Small-scale incinerators (< 50 kg/hr) are operated in the UK, mainly on large poultry and pig farms for the incineration of animal carcasses. Strict controls apply to their use, including a periodic inspection and monitoring regime. The ash may be landfilled, disposed of by other routes, or recycled, as ashes have a high phosphorus content.

Only animal by-products, including dead animals, originating in remote areas and under specific conditions and circumstances may be disposed of as waste by burning or burial on farm under official supervision, according to Article 19 of Regulation (EC) 1069/2009. Several Member States have already granted derogations in regard to the possibility to dispose of animal by-products as waste by burial or burning in remote areas [492, DG SANCO 2005]. A remote area is defined as an area where the animal population is so small, and where disposal establishments or plants are so far away that the arrangements necessary for the collection and transport of animal by-products would be unacceptably onerous compared to local disposal.

Burial and burning of animal by-products may also be justified in disease control situations requiring the emergency disposal of the animals killed as a measure to control an outbreak of a serious transmissible disease. In particular, disposal on farm should be allowed under special circumstances, since the available rendering or incinerator capacity within a region or a Member State could otherwise be a limiting factor in the control of a disease.

2.13 Treatment of waste water

Waste water is a general term for water contaminated with faeces, urine, chemicals etc. and so posing a risk of pollution but of little value as a fertiliser. Waste water, also called dirty water, originates from washing livestock houses and equipment, from facilities for personnel, and particularly from run-off from yards and open concrete areas that are contaminated by manure, waste animal feed, etc. Cleaning water from livestock farming facilities can contain residues of dung and urine, litter, and feedstuffs, as well as cleaning agents and disinfectants.

Waste water can be managed in combination with slurry, but can also be treated and handled separately, in which case separate storage will be needed. On poultry farms, the aim is to keep manure dry to reduce ammonia emissions and to allow easier handling. Waste water is stored in special tanks and dealt with separately. On pig farms, waste water is commonly added to the slurry and treated in combination or applied directly to land. Various treatment systems for slurry exist and they are described in Section 2.7.

If kept separate, waste water may be landspread through low-rate irrigators (e.g. in the UK) or treated in a common or on-farm waste water treatment plant (e.g. sedimentation treatment is a minimum for waste water arising from solid manure systems in Finland).

For discharge into running waters or a public sewage system, waste water from intensive livestock farming must comply with emission limits stipulated under water regulations [[373, UBA Austria 2009](#)].

Constructed wetlands with reedbeds are aquatic plant-based systems designed specifically for the removal of nitrogen from dilute waste water as it passes through the vegetative filter. Some of these solutions may have limited effectiveness (with water of variable quality) or may have a limited lifetime. They are relatively inexpensive to construct but may require a large area of land to provide an adequate level of treatment [[203, ADAS 2005](#)]. Their construction and operation and the discharges to groundwater and surface have to be authorised and assessed.

Swales are ideal for collecting and transporting run-off but require large space. Ponds remove part of the sediment with a partial treatment. Soakaways need practically no care, but must not be used where there is a high level of contaminants.

2.14 Installations for heat and power production and energy recovery

2.14.1 Renewable energy production

Renewable energy production on farm can contribute to the reduction of the energy costs by covering part of the energy requirements of the farm and/or selling the produced energy to supply networks.

Solar or wind-driven generators are more frequently installed. Solar power supply depends very much on the weather conditions, while windmills attached to a generator can supply power, particularly in areas with relatively high wind speeds.

Electricity production from photovoltaic panels is possible in pig and poultry farms as large roof surfaces are available on houses. In addition, roof slopes (26–45 %) allow a good efficiency of the system. Government incentives, such as 'Feed-In Tariffs' applied in many EU Member States, have reduced payback times of the investment in solar energy production to 5–10 years. Costs for photovoltaic panels are falling rapidly. Costs of about EUR 2 500 per kW or EUR 450.600 per m² were reported in 2013.

The installation of small wind turbines is also becoming more convenient: for sizes up to 12 m in height, costs are around EUR 500/kW; while for capacities of 10–50 kW and 15–30 m in height, costs are reported to be around EUR 3 500 per kW. In France, contracts for the purchase of wind power electricity are established for 15 years.

2.14.2 Heat recovery by heat exchangers

Several solutions for the recovery of energy from various media are available, which use heat exchangers based on three major principles:

- air-air heat exchangers;
- air-water heat exchangers;
- air-ground heat exchangers.

Air-air exchange. The principle consists of warming up the air that enters the house using the heat of the exhaust air. The heat is transferred through plates that separate the flows that enter and exit the house.

Air-water exchange. The exhaust air warms water circulating in aluminium fins placed in the extraction shaft. Recovered heat is returned indoors by a fan-convecter. Electric consumption is only needed for the pump, which ensures the circulation of the water. The maximum recorded effect is an increase of 12 °C of the incoming air.

Air-ground exchange. The exchangers use the inertia of the ground to smooth the seasonal variations of temperatures and, consequently, to improve the conditions of thermal comfort of the animals. They are used to preheat the air in winter as well as to cool it in summer [347, Bartolomeu 2007].

2.14.3 Heat pumps

A heat pump is a device that transports heat from one location at a lower temperature to another location (the 'heat sink') at a higher temperature using mechanical work. When a heat pump is used for heating, it employs the basic refrigeration cycle but in the opposite direction, releasing heat into the conditioned space rather than the surrounding environment. In this use, heat pumps generally draw heat from the cooler external air, water or from the ground.

Heat pumps use a refrigerant liquid as an intermediate fluid to efficiently transfer heat at relatively long distances. In heating mode, the refrigerant flowing through insulated pipes from the evaporator, where it vaporises, carries the thermal energy absorbed (from air, water or soil) indoors into the animal house, after the fluid's temperature has been augmented by compressing it. The condenser, where the refrigerant condenses, then transfers heat (including energy from the compression) to the indoor air or water in the animal house for example. The refrigerant is then allowed to cool and to expand and the cycle restarts by collecting heat in the evaporator (Figure 2.43).

The recovered heat can be used to produce sanitary warm water or to feed a heating circuit (warm water buckles, underfloor heating or fan convectors) in the animal house.

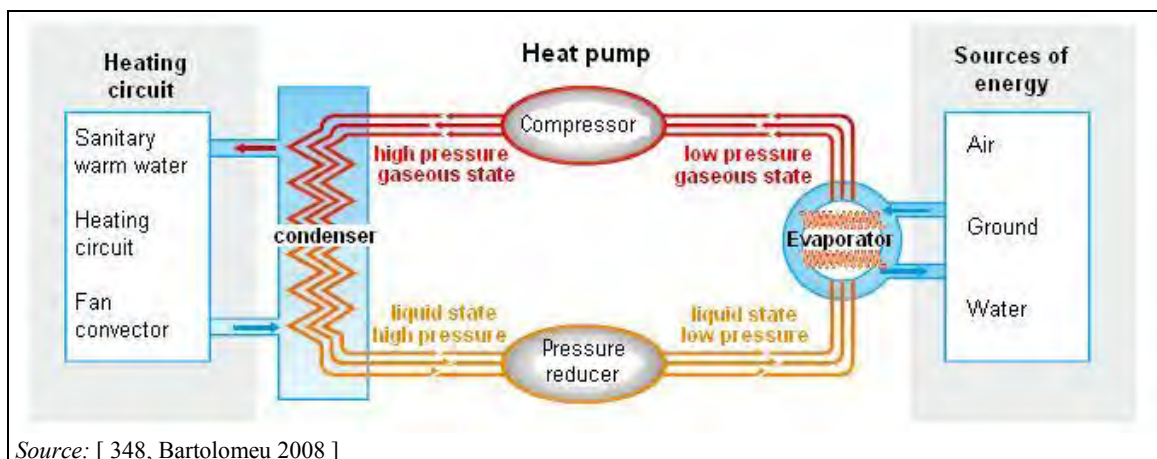

Source: [348, Bartolomeu 2008]

Figure 2.43: Operating principle of a heat pump

2.14.4 Biogas energy production

In the intensive livestock production sector, the potential for biogas production by anaerobic digestion can be important at farm level although slurry has a relatively low energy content and generally needs to be supplemented with high-energy feedstocks like energy plants, green wastes and silage maize. Poultry manure can also be digested with pig slurry as a part of the substrate.

Anaerobic digestion (see Section 2.7.4) is a process of degradation of the organic matter without oxygen that leads to the production of biogas (mainly constituting of methane). Biogas can be used as fuel by a co-generator (CHP) plant to produce electricity to sell it to the commercial network and to produce heat which can cover part of the heating needs of the farm, such as for animal houses, greenhouses and piglet heating [345, France 2010]. The heat produced by CHP plants can also be transferred to external users by district heating for residential and commercial heating requirements.

After a first wave of digesters that were built in the 1980s and 1990s had little real success, anaerobic treatment is in a new phase of development in Europe, especially due to attractive prices provided for the energy produced, which is classified as renewable. The profitability of

the process depends on the production capacity and on the sale price of the electric power as well as from the valorisation of the heat produced. Different grants and incentives are in place in various Member States, which are taken into account in the economic evaluation of these production systems.

2.14.5 Energy production from biomass

Heat production using biomass (or wood) firing requires a whole infrastructure to benefit from the heat produced. These requirements, which normally are not present in existing farms, consist of the heating network, hot air blowers or heating floors or fins.

Boilers must be installed close to buildings because the heat distribution piping network is relatively expensive. However, biomass fuel costs generally offer substantial savings over imported fossil fuels, once the capital has been invested.

This heating system is profitable when the heat needs are large and stable, as is the case with multiple houses or users. Some examples of heat requirements for different size farms and animal categories are reported in Table 4.42.

2.15 Monitoring of emissions and control of process parameters

This section gives some examples of common practice in monitoring of emissions and control of process parameters. In most cases, farmers do not normally monitor and control emissions to air unless specifically required to do so as a result of complaints from neighbours. These complaints are usually related to noise and odour emissions.

In some areas, farmers have to keep a register of phosphate and nitrogen flow. This is usually where intensive livestock production is responsible for high pressures on the environment. The resulting balance gives a clearer indication of the input and losses of nutrients on the farm. The information can be used to optimise the feeding of nutrients to the animals and the landspreading. Some farmers assess the nutrient status of soils and apply an appropriate amount of organic nutrients and mineral fertiliser according to crop requirements and rotations. The level of precision varies from those who undertake soil and manure analysis and use some form of recognised nutrient management planning to those who estimate requirements using general published information or those just using experience or guesswork. The legislation that applies in some countries is described in Section 2.8, which explains why the extent of record-keeping is variable.

Farmers keep records (receipts) of purchased items, although the extent to which they are kept in an organised way will vary. Such records will usually exist for the main items of feed, fuel (including electricity) and water (not all private abstractions) so the amounts used can be identified. Since feed and water are primary inputs to livestock systems their usage may be monitored by farmers irrespective of whether receipts are kept. Most poultry farmers will have bought in bedding material, whereas pig producers who use straw may produce their own or have an agreement with neighbouring farmers exchanging manure for clean straw.

For manure spreading, monitoring is generally limited to keeping records of the spreading activity (timing, amount, location, quality, etc.) [204, IMPEL 2009].

Computerised registration and the administration of costs, inputs and outputs are increasing and are already common in large enterprises. Monitoring provides data, often remotely or instantaneously, that are useful for the farm management. This information allows operators to ensure that systems are operating within their specification and to easily identify failures or areas where further investigation is required. Where measuring is applied, water gauges, electric meters and computers for indoor climate control are used.

There may be requirements to check slurry stores regularly for any signs of corrosion, leakage or loss of integrity of the solid or floating cover and to find any faults that need to be put right. Professional help may be required. Checking takes place after completely emptying the stores. In Denmark, where surface crusts are required as an alternative to the slurry stores' covers, farmers are required to inspect the crust at least monthly, and to maintain a record of findings.

Emissions to water by discharging waste water may occur under specific legislation and within set (discharge) conditions and monitoring requirements.

3 CURRENT CONSUMPTION AND EMISSION LEVELS OF INTENSIVE POULTRY OR PIG FARMS

This chapter presents data on consumption and emission levels associated with activities on farms for the intensive rearing of poultry or pigs, based on the information that has been submitted in the framework of the information exchange. It aims to give an overview of the ranges that apply to these sectors in Europe and so to serve as a benchmark for the performance levels associated with the techniques presented in Chapter 4. The factors that account for the variation of data are briefly described when possible, or sometimes only mentioned. The circumstances under which data have been obtained are described in more detail in the evaluation of applied techniques in Chapter 4.

3.1 Introduction

The major production activities, systems and techniques on intensive pig and poultry farms have been described in Chapter 2. The consumption and emission levels that were reported were not always clear and comparable, and major variations occur due to a large number of factors. Table 3.1 summarises the key environmental issues of the major on-farm activities.

Table 3.1: Key environmental issues of the major on-farm activities

Major on-farm activity	Key environmental issue	
	Consumption	Potential emission
Housing of animals: <ul style="list-style-type: none"> the way the animals are stocked (cages, crates, free) the system to remove and store (internally) the manure produced 	Energy, litter, medication	NH ₃ , odour, noise, greenhouse gases (CH ₄ , N ₂ O, etc.), dust and fine dust particles (PM ₁₀), manure, waste water, other wastes (e.g. dead animals)
Housing of animals: <ul style="list-style-type: none"> the equipment to control and maintain the indoor climate and the equipment to feed and water the animals 	Energy, feed, water	Noise, waste water, dust, CO ₂
Storage of feed	Energy	Dust and fine dust particles (PM ₁₀), waste
Storage of manure in a separate facility	Energy	NH ₃ , odour, emissions to soil, greenhouse gases
Storage of residues other than manure	NA	Odour, emissions to soil, groundwater
Storage of dead animals	Energy	Odour, pathogens
Unloading and loading of animals	NA	Noise, dust
Manure landspreading	Energy	NH ₃ , odour, greenhouse gases, pathogens, emissions to soil, groundwater and surface water of N, P etc., noise
On-farm treatment of manure	Additives, energy, water	NH ₃ , odour, greenhouse gases, waste water, emissions to soil
Milling and grinding of feed	Energy	Dust and fine dust particles (PM ₁₀), noise
Treatment of waste water	Additives, energy	Odour, waste water
Incineration of dead animals	Energy	Emissions to air, odour

NB: NA = not applicable.

The central environmental issue for the poultry or pig rearing sectors is manure management: the amount produced, composition, method of removal, storage, treatment and its landspreading. This is reflected in the order in which the activities are presented, starting with feed as the major consumption issue and followed by manure production as the most important emission.

The levels of consumption and emission depend on many different factors, such as the animal category, production phase, and management system. Additionally, factors such as climate and soil characteristics also have to be taken into account. As an example, the climate in the Mediterranean regions is characterised by two very distinct seasons, spring-summer and autumn-winter, in which consumption and emissions have distinct values. The tables show the widest possible ranges of reported consumption and emissions. In the accompanying text an attempt is made to explain this variation as far as information allows, but without being too specific.

Within MS, standard units are applied that may not always be comparable with units used elsewhere. Consumption and emission levels can be measured in different ways and at different moments involving the factors mentioned above. For the sake of comparison and for reference, relevant factors will be mentioned that influence the character and the level of the consumption or emissions level presented.

In the assessment of consumption and emission levels, a distinction can be made between single activities and the farm as a whole. Where possible, data are directly associated with a single on-farm activity, so as to enable a clear link to the reduction techniques described in Chapter 4. Some other data are given for the farm as a whole. In the assessment of consumption and emission levels of pig farming, it is important to know the production system applied. Growing and finishing aim for a slaughter weight of 90–110 kg or 150–170 kg (Italy) and can be reached within different periods of time. Poultry production systems seem to be quite similar throughout the EU.

A remark may be made on the use of animal units to standardise data and to achieve comparability. For this purpose EU countries use the ‘animal unit’ or ‘equivalent animal’. There may be difficulties associated with these standardised units, because in different EU countries they are defined in different ways (see Section 9.1).

3.2 Consumption levels

3.2.1 Feed consumption and nutritional levels

The amount and composition of feed given to poultry and pigs and the feed management not only has a strong influence on animal performance but also on the amount of manure produced, its composition and structure, and thereby on emissions such as ammonia. Thus, feeding is an important factor in the environmental performance of an intensive poultry or pig enterprise. Emissions from livestock farms are predominantly related to the metabolic processes of the housed animals. Two processes are considered essential:

- enzymatic digestion of feed in the gastrointestinal tract;
- absorption of nutrients from the gastrointestinal tract.

The advanced understanding of these processes is responsible for the development of the wide range of feeds and feed additives adapted to the needs of the animal and to the production objectives.

Consumption levels vary with the energy requirements of the individual animal, which involve maintenance requirements, growth rate and production level. The total amount of feed intake is a result of the duration of the production cycle, the daily intake and the type of production purpose and it is also influenced by a number of factors related with the animal. Data on consumption levels are reported in kg per head per production cycle or kg per kg of product (eggs or meat). Comparisons are difficult to make with the use of different breeds and the application of different production targets (egg weight or animal weight) and production cycles.

The following sections present an overview of the feed intake levels and nutrient requirements reported and show the existing variation where possible together with the factors that account for that variation.

3.2.1.1 Poultry feeding

Indicative feeding levels for different poultry species are presented in Table 3.2.

Table 3.2: Indication of feed conversion ratio and feed consumption per poultry category

Types of animal production	Feed conversion ratio	Feeding level range (kg/bird/cycle)	Feed amount (kg/bird place/year)
Laying hens	2.1–2.8 ⁽¹⁾ ⁽²⁾	NA	34–47 ⁽³⁾
Pullets	NI	5.5–6.6 ⁽³⁾	15.3–15.7 ⁽⁴⁾
Standard broilers	1.6–2.2 ⁽¹⁾	2.4–5.7 ⁽⁵⁾	16.8–33 ⁽⁵⁾ ⁽¹⁾
Heavy broilers	1.8–2.3 ⁽¹⁾	3.9–8 ⁽⁵⁾ ⁽¹⁾	22.6–33 ⁽⁵⁾ ⁽¹⁾
Male turkey	2.6–3.1 ⁽¹⁾	50–60 ⁽¹⁾	150 ⁽¹⁾
Female turkey	2.3–2.8 ⁽¹⁾	24 ⁽¹⁾	65 ⁽¹⁾
Pekin duck	2.45 ⁽³⁾	5.7–9.0 ⁽¹⁾	37–58 ⁽¹⁾
Barbary duck	2.66–2.82 ⁽⁶⁾ ⁽⁷⁾	7.6–12.9 ⁽⁶⁾	37–42
Guinea fowl	2.75–3.37 ⁽⁷⁾	4.5–4.7 ⁽³⁾ ⁽⁶⁾	17 ⁽⁷⁾

NB: NI = no information provided; NA = not applicable.

Source: ⁽¹⁾ [500, IRPP TWG 2011]
⁽²⁾ FCR kg feed per kg eggs.
⁽³⁾ [43, COM 2003]
⁽⁴⁾ Calculations based on data (2009) from [633, ITAVI 2013] (6.3 to 6.46 kg/bird/cycle)
⁽⁵⁾ Calculations based on data reported in Table 1.3 and 19 days of sanitation.
⁽⁶⁾ [280, France 2010]
⁽⁷⁾ [418, ITAVI 2010]

The purpose of poultry feeding and the components used in poultry feed mixtures have been described in Section 2.2.5.1. The amino acid composition of feeds, which is derived from the amino acid profile of the individual feed materials, has to be as close as possible to the ideal amino acid profile for the relevant animal species. In this 'ideal protein' concept, the required amino acid levels are expressed relative to the lysine level of the feed. Farm practices are (along with their variability) reported in

Table 3.3. The recommended amino acid balances are quoted from literature, but the appraisal of protein and lysine levels results from farm observations at a European level. Examples of applied commercial feeding programmes are presented in Annex 9.2.1.

Table 3.3: Appraisal of protein and lysine levels and scope for recommended amino acid balances

	Broilers	Layers	Turkeys (medium weight)
Energy level MJ/kg, ME basis			
Phase 1	12.5–13.5	11.6–12.1	11.0–12.5
Phase 2	12.5–13.5	11.4	11.0–12.5
Phase 3	12.5–13.5	11–11.4	11.5–12.5
Phase 4	NI	NI	11.5–13.5
Phase 5	NI	NI	NI
Protein level (CP=N*6.25), total content			
% feed, phase 1	20–24	15.4–20	25–30
% feed, phase 2	18–22	15.5–19	22–28
% feed, phase 3	17–21	15–17	19–26
% feed, phase 4	NI	15–17	18–24
% feed, phase 5	NI	13–16	15–22
Lysine level, total content			
% feed, phase 1	1.1–1.5	NI	1.80–1.50
% feed, phase 2	1.0–1.3	NI	1.60–1.30
% feed, phase 3	0.9–1.2	NI	1.40–1.10
% feed, phase 4	NI	NI	1.20–0.90
% feed, phase 5	NI	NI	1.00–0.80
mg/day	NI	850–900	NI
Recommended amino acid balance, in percentage of lysine level			
Threonine: lysine	63–73	66–73	55–68
Methionine +cystine: lysine	70–75	81–88	59–75
Tryptophan: lysine	14–19	19–23	15–18
Valine: lysine	75–81	86–102	72–80
Isoleucine: lysine	63–73	79–94	65–75
Arginine: lysine	105–125	101–130	96–110
NB: ME = metabolisable energy; CP = crude protein; NI = no information provided.			
Source: [506, TWG ILF BREF 2001] [280, France 2010] [327, Germany 2010] [294, UK 2010] [500, IRPP TWG 2011]			

Indications of the applied levels of calcium and phosphate in feed are given in Table 3.4.

Table 3.4: Applied calcium and phosphorus levels in commercial feeds for poultry

Element (% of feed)	Pullets	Laying hens	Broilers	Turkeys (male)	Ducks
Ca	0.9–2.25	2–4.4	0.65–1.2	0.65–1.4	0.7–1.2
P	0.4–0.76	0.354–0.55	0.32–0.78	0.45–0.90	0.6–0.85
NB: Diets based on multiphase feeding.					
Source: [ANNEX 9.2.1] [280, France 2010]					

3.2.1.2 Pig feeding

For pigs, the feeding strategy and feed formulation vary with factors such as live weight and stage of (re)production. A distinction is made between the feeding of young sows (gilts), mating and gestating sows and farrowing sows and between piglets, weaners, and fattening pigs. Feed amounts are expressed in kg per day and in required energy content per kg of feed. A large number of tables and data on various feeding strategies are available. The following tables in this section merely present the ranges of reported levels applied in Europe, acknowledging that higher or lower nutrient levels may also be applied in certain cases. The final intake depends on the amount consumed and on the nutrient concentration and therefore minimum levels are recommended for the different feeds to meet the pigs' requirements given their average daily intake.

The amino acid composition of feeds has to be as close as possible to the ideal amino acid profile. The sum of the amino acid contribution of each ingredient used to make the feed is compared to the ideal protein profile. Lysine being the first limiting amino acid for pig performance in this 'ideal protein' concept, the required amino acid levels are expressed relative to lysine. Farm practices are (along with their variability) reported in Table 3.5 (sows) and Table 3.7 (weaners and fattening pigs). The recommended amino acid balances are quoted from literature, but the appraisal of protein and lysine levels result from field observations at a European level. Some applied commercial feeding programmes for pigs are presented in detail in Annex 9.2.2.

Lactating sows generally need higher nutritional levels than gestating sows due to milk production; in particular, crude protein and lysine are required to be in higher concentrations in the feed ration. The energy requirements increase towards the moment of birth. After farrowing, daily energy requirements increase with the increased size of the litter and also as lactation progresses. Between weaning and first mating, energy levels remain high to help the animal to recover and to prevent loss of condition. After mating, the energy content of the feed can be reduced. During winter, higher energy levels are applied for gestating sows. The amount of feed given to a sow in production, including dry periods, and depending on energy intake, amounts to about 1 200–1 400 kg per year. Average nutritional levels are shown for sows in Table 3.5.

Table 3.5: Appraisal of protein and lysine levels and scope for recommended amino acid balances for sows (one phase for every physiological stage)

	Lactating sow	Gestating sow
Energy level (MJ/kg), ME basis	12.5–13.5	12–13
Protein levels (CP=N*6.25), total content (% feed)	16–18	13–16
Lysine levels, total content (% feed)	1.00–1.15	0.70–1.70
Recommended amino acid balance, in percentage of lysine level		
Threonine : lysine	65–72	71–84
Methionine+cystine: lysine	53–60	54–67
Tryptophan : lysine	18–24	16–21
Valine : lysine	69–100	65–107
Isoleucine : lysine	53–70	47–86
Arginine : lysine	67–70	NA
NB: ME = metabolisable energy; CP = crude protein; NA = not applicable.		
Source: [506, TWG ILF BREF 2001] [430, Paulicks et al. 2006]		

Indications of the range of applied levels of calcium and phosphorus in feed for sows are given in Table 3.6.

Table 3.6: Applied calcium and phosphorus levels in commercial feeds for sows

	Mating and gestating sows	Lactating sows
Feed (kg/sow/day) ⁽¹⁾	2.2–2.7	5–8
Calcium (% feed)	0.55–0.9	0.55–0.95
Total phosphorus (% feed)	0.4–0.75	0.5–0.75
⁽¹⁾ Average range.		
NB: Diets based on multiphase feeding.		
Source: [ANNEX 9.2] [329, CORPEN 2003] [624, IRPP TWG 2013]		

The amino acid requirements of boars are much higher at higher weights and so inevitably feeds are higher in crude protein and this increases nitrogen excretion [624, IRPP TWG 2013].

Fattening pigs are fed according to their body weight, with feed intake increasing with increasing weight. Towards the end of the finishing period (the last 20–30 kg) the amount of feed given is unchanged, while the protein level is generally lowered.

The total amount of feed consumed during growing and finishing depends on the breed, FCR, daily growth, length of the finishing period and final live weight. For pigs growing from 25 kg up to 110 kg live weight, about 260 kg of feed is consumed. Obviously, the nutrient levels of the feed are most important. Nutritional levels have to meet the requirements of daily growth or production. For each weight category average requirements can be distinguished, as reported by various sources and summarised in Table 3.7. Increasingly, finishing periods range between 30 kg and final weight and are divided into two or three feeding phases. In these phases, the nutrient content in the feed varies to meet the varying demand of the pig. The end of the first growing phase ranges between 45 kg and 60 kg live weight and the second phase between 80 kg and 110 kg. Where one feed is given between 30 kg and 110 kg, the content of the feed is equal to the average of the level of the two-phase feeds.

Table 3.7: Appraisal of protein and lysine levels and scope for recommended amino acid balances for pigs (one phase for each major stage of growth)

Energy level (MJ/kg), ME basis	
Phase 1 (weaned piglet)	12.5–13.5
Phase 2 (growing pig)	12.5–13.5
Phase 3 (finishing pig)	12.5–13.5
Protein levels (CP=N*6.25), total content	
% feed, phase 1	21–17
% feed, phase 2	18–14
% feed, phase 3	17–13
Lysine levels, total content	
% feed, phase 1	1.30–1.10
% feed, phase 2	1.10–1.00
% feed, phase 3	1.00–0.90
Recommended amino acid balance, in percentage of lysine level	
Threonine: lysine	60–72
Methionine +cystine: lysine	50–64
Tryptophan: lysine	18–20 (fattening pigs) 18–22 (weaners) ⁽¹⁾
Valine: lysine	68–75
Isoleucine: lysine	50–60
Arginine: lysine	18–45
⁽¹⁾ [663, Simongiovanni et al. 2012]	
NB: ME = metabolisable energy; CP = crude protein.	
Source: [506, TWG ILF BREF 2001]	

Standard applied levels of calcium and digestible phosphorus in feeds for sows, weaners and fattening pigs (growers/finishers) are given in Table 3.8.

Table 3.8: Calcium and digestible phosphorus standard levels applied to feed for pigs, in total amount per kg of feed

Parameter	Sows		Weaners			Fattening pigs	
	Gestating	Lactating	6–9 kg	9–20 kg	20–30 kg	30–45 kg	45–105 kg
Calcium (g/kg)	6.9–7.5	8.4–9.0	8.3–9.0	9.9–10.5	9.9–10.5	8.0–8.6	7.5–8.1
Phosphorus + phytase addition (g/kg)	6.4–7.0	7.9–8.5	7.7–8.3	9.3–9.9	9.3–9.9	7.5–8.1	7.0–7.6
Digestible phosphorus (g/kg)	2.0–2.2	2.8–3.0	3.9–4.1	3.7–3.9	3.4–3.6	2.8–3.0	2.6–2.8
ME (MJ/kg feed)	12.6	13.3	14.4	14.1	14.1	13.4	13.4

Source: [624, IRPP TWG 2013]

Another example is presented in Table 3.9 for finishers in Italy, where a distinction is made between heavy and conventional pigs. In general, the feeding is *ad libitum* for light pigs, which are capable of strong muscular development, but rationed for heavy pigs, which have a considerable propensity towards fat accumulation and towards a higher weight level. This changes the feed composition. For example, whey (5–6 % dry matter) can be used for the heavy pigs, with 13–15 litres of whey substituting 1 kg of dry feed. The whey can be used in increasing quantities, from 3–4 litres per head per day at a weight of 30 kg up to a maximum of 10–12 litres for more than 130 kg (quantities beyond these levels may have negative effects on the utilisation i.e. FCR of the total daily ration).

Table 3.9: Example of rationing used for conventional and heavy fattening pigs in Italy

Heavy pig							
Live weight (kg)	Up to 25	30	50	75	100	125	150+
Feed (88 % DM) (kg/day)	<i>Ad lib.</i>	1.2–1.5	1.5–2.0	2.0–2.5	2.5–3.0	2.7–3.2	3.0–3.4
Conventional pig							
Feed (88 % DM) (kg/day)	<i>Ad lib.</i>	1.5	2.2	2.8	3.1	NA	
Digestible energy (MJ/kg)	13.8	13.4	13.4	13.4	13.4		
Lysine (%)	1.20	0.95	0.90	0.85	0.80		

NB: NA = not applicable.
Source: [391, Italy 1999]

In finishing the heavy weight pig in Italy, different weight ranges are distinguished with their associated nutrient levels (see Table 3.10).

Table 3.10: Average nutritional levels applied in Italy for heavyweight pigs for different live weight intervals (as % of raw feed)

Nutritional parameters	Pigs 35–90 kg	Pigs 90–140 kg	Pigs 140–160 kg
Crude protein (CP, %)	15–17	14–16	13
Crude fats	4–5	< 5	< 4
Crude fibre	< 4.5–6	< 4.5	< 4
Total lysine	0.75–0.90	0.65–0.75	0.60–0.70
Total methionine + cystine	0.45–0.58	0.42–0.50	0.36–0.40
Total threonine	0.42–0.63	0.50	0.40
Total tryptophan	0.15	0.15	0.10–0.12
Calcium	0.75–0.90	0.75–0.90	0.65–0.80
Total phosphorus	0.62–0.70	0.50–0.70	0.48–0.50
Digestible energy (MJ/kg)	> 13	> 13	> 13
<i>Source:</i> [391, Italy 1999]			

3.2.2 Water consumption

The total amount of water used includes not only consumption by the animals, but also the water used to clean housing, equipment and the farmyard, the water used for cooling purposes and the water consumed by air cleaning techniques. Cleaning water particularly affects the volume of waste water produced on farms. After every cycle, the housing is fully cleaned and disinfected. The length of this cleaning period varies from 1 day [500, IRPP TWG 2011] up to 2 (Finland, the UK) or even 3 weeks (Ireland).

3.2.2.1 Water requirements of poultry farms

3.2.2.1.1 Birds' water consumption

In the poultry sector, water is required for satisfying the physiological needs of the birds. Water intake depends on a number of factors, such as animal species and age, animal condition (health), water and ambient temperature, feed composition, and the drinking system used.

With increasing ambient temperatures the minimum water intake of broilers increases geometrically. A higher laying percentage also raises the daily consumption of layers. With respect to drinking systems, nipple drinkers show lower consumption than round drinker systems, due to lower spillages. In general, drinking consumption is roughly twice the feeding consumption. The water to feed ratio is between 1.6 (birds with a slow growth rate) and 2.2 (birds with a fast growth rate). Average water consumption levels are shown in Table 3.11. Water to feed ratios were reported for broilers, laying hens, turkeys and ducks.

Table 3.11: Water consumption of different poultry species per cycle and per year

Poultry species	Average water to feed ratio (l/kg)	Water consumption per cycle (l/head per cycle)	Annual water consumption (l/bird place per year)
Laying hens	1.8–2.0	10 (up to production)	73–120 (egg production)
Broilers	1.7–1.9	4.5–11	30–70
Turkeys	1.8–2.2	45–100	117–150
Ducks	3.5–6	30–46	195–300
<i>Source:</i> [44, IKC 1993] [391, Italy 1999] [24, LNV 1994] [358, France 2010] [500, IRPP TWG 2011]			

3.2.2.1.2 Use of cleaning water

Waste water primarily results from the cleaning of the animal houses. All water spillages from drinking are usually removed as part of the manure. Farms that produce wet manure (no drying in the poultry house) can store this water in the manure storage facility. On farms where dry manure is produced, waste water is stored separately (e.g. in tanks). Table 3.12 shows the estimated cleaning water use for different poultry housing systems.

Table 3.12: Estimated water use for cleaning of poultry housing

Poultry species	Use (m ³ per m ² cleaned)	Cycles per year	Use (m ³ per m ² per year)
Layers (enriched cages)	0.01	1	0.01
Layers (deep litter)	0.030–0.060 ⁽¹⁾	1	0.03–0.06 ⁽¹⁾
Broilers	0.005–0.008 ⁽¹⁾	6	0.03–0.048 ⁽¹⁾ 0.085–0.105 ⁽²⁾
Turkeys	0.009–0.010 ⁽¹⁾ 0.02 ⁽²⁾	2–3	0.018–0.03 ⁽¹⁾ 0.04–0.06 ⁽²⁾
Ducks (Pekin)	0.005–0.050 ⁽²⁾	8.6	0.040–0.430 ⁽²⁾
Ducks (Barbary)	0.064 ⁽¹⁾	3.5	0.215 ⁽¹⁾
⁽¹⁾ Data related to French poultry farms.			
⁽²⁾ Data related to UK poultry farms.			
Source: [500, IRPP TWG 2011] [624, IRPP TWG 2013]			

The volume of water used for cleaning purposes is variable and depends on the technique applied and the water pressure of the high-pressure cleaner. Also, using hot water or steam instead of cold water will reduce the volume of cleaning water used.

For laying hens, water use for cleaning varies with the housing system. Cleaning is done after each round of 12–15 months. For layers kept in enriched cages, less cleaning water is needed than for layers in a deep litter system. The cleaning of housing systems where layers are kept on deep litter varies with the area covered with slats. The larger the surface with slats the higher the volume. Cleaning water requirements for non-cage housing of laying hens is reported to be 4 m³/1 000 hens in French farms [358, France 2010].

Cleaning water use for broiler houses varies widely. In France, water use for cleaning a broiler house with a 1 200 m² floor surface (equivalent to 1 800 m² including surfaces of walls and roof to be washed) is reported as 5.5 m³ per batch for a building on a hard-packed floor and 10 m³ for a building with a concrete floor. For turkeys and for the same surface, the quantity of cleaning water is about 11–13 m³ [358, France 2010].

3.2.2.1.3 Use of cooling water

Water consumption related to cooling of bird houses by fogging or spraying systems depends on climatic conditions, and only occurs for limited periods during the year. One litre of water that evaporates at 25 °C absorbs 678 Wh from the environment.

To cool a house of 1 000 m² by fogging, for 10 hours a day for 30 days, 100 m³ of water are needed. With a spraying system operating in the same conditions, the water requirement would be 190 m³ [354, ITAVI 2004]. Additional information is available in Section 4.8.3.

3.2.2.2 Water requirements of pig farms

3.2.2.2.1 Animals' water consumption

Four types of water consumption can be identified:

- the water necessary for maintaining homeostasis and meeting the growth requirements;
- the water ingested by the animals in excess of what is strictly necessary;
- the water which is wasted at the moment of drinking due to an incorrect structuring of the distribution system;
- the water used by the animals for satisfying behavioural needs, such as the water spillage during the typical behaviour generated by the lack of 'play' objects other than the drinking system.

Animal consumption of water is expressed in litres per kg of feed and depends on animal age and live weight, animal health, stage of production, climatic conditions, and feed and feed structure.

The water consumption of finishers per kg of feed ingested decreases with age but, as the animals have a higher feed intake with increasing live weight towards the end of the finishing period, the absolute daily water intake is higher.

For sows, water consumption is important for maintaining homeostasis and for the production of piglets or milk. Such high levels of water ingestion also have positive effects on the animal's ingestion capacity during the suckling phase and on maintaining the health of the urogenital organs during pregnancy. Total water requirements can differ in different systems and regions.

Table 3.13 shows the average water consumption for different pig categories and rearing stages in Spain.

Table 3.13: Average water requirements of pigs in Spanish farms with respect to pig category

Pig production type	Water consumption (l/animal place per day)
Sows (in a farrow-to-finish farm) ⁽¹⁾	60–73
Farrowing sows with piglets up to 6 kg	14–17
Farrowing sows with piglets until 20 kg	21–26
Gilts	10–13
Weaners from 6 to 20 kg	2.7–3.3
Growers from 20 to 50 kg	5.4–6.6
Fattening pigs from 50 to 100 kg	11–14
Fattening pigs from 20 to 100 kg	7–9
Boars	15–18
⁽¹⁾ Includes all offspring of the sow until end of fattening period.	
Source: [43], MARM 2010]	

In Denmark, typically around 800 kg of dry feed are used per pig place per year. With that amount, the pigs are drinking 2.5–3.0 litres of water per kg of feed. In total, 2 000–2 400 litres of drinking water are needed per pig place per year [500, IRPP TWG 2011].

In the UK, water requirements for sows are reported as 20–40 l/d for farrowing sows and 10–20 l/d for gestating sows [624, IRPP TWG 2013].

The water consumption increases linearly with body weight after weaning, as represented in Figure 3.1. Animals consume 0.8 litres per day on entry (7 kg live weight), reaching 4–5 litres per day at the end of the weaning phase (27 kg live weight). The water consumption increases linearly at a rate of about 0.16 litres of water per kg of live weight.

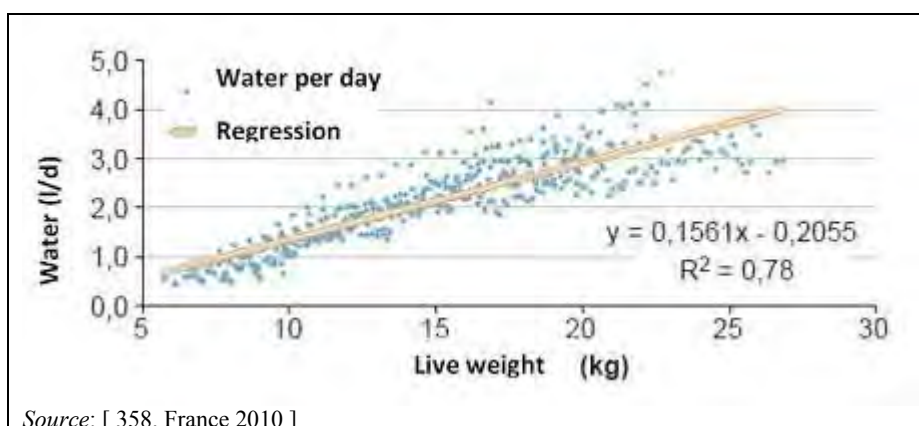

Figure 3.1: Evolution of water consumption with the live weight of post-weaning piglets

Increased water requirements at higher indoor temperatures are due to the thermoregulation needs. For fattening pigs, the ratio of water intake to feed intake increases from close to 3 at temperatures between 20 °C and 24 °C to over 4 at a temperature of 28 °C. A higher water wastage is also expected at higher temperatures, due to the efforts that animals make to cool themselves [359, Massabie P 2001].

Measurements in French farms have shown that, in the fattening phase, the daily water intake increases by 0.063 litres per kg of live weight at a temperature of 20–24 °C (i.e. water consumption (l/d) = 0.063 * weight (kg) + 2.564) and by 0.10 l/kg of live weight at an indoor temperature of 28 °C (i.e. water consumption (l/d) = 0.101 * weight (kg) + 2.564). In the case of lactating sows, at higher temperatures, water intake is not increased but the feed intake is [359, Massabie P 2001].

In general, manure production increases, but with a simultaneous decrease in its dry matter percentage, due to an increased water intake (Table 3.14). This pattern is similar for pigs, lactating sows (including litter) and dry sows with water including other fluids such as whey, skimmed milk and silage effluent.

Table 3.14: Example of the effect of water to feed ratio on the production and dry matter content of manure of fattening pigs

Water to feed ratio	Ration (kg/pig per day)	Manure production (m ³ /pig place per year)	Dry matter content (%)
1.9 : 1	2.03	0.88	13.5
2.0 : 1	2.03	0.95	12.2
2.2 : 1	2.03	1.09	10.3
2.4 : 1	2.03	1.23	8.9
2.6 : 1	2.03	1.38	7.8

Source: [44, IKC 1993]

Water spillage and slurry generation are both influenced by the type of drinking system and the rate of water delivery. In Table 3.15, it can be seen that an increase in the speed of the water delivery of the drinking nipples by a factor of 2 leads to an increase in the volume of the slurry produced by a factor of 1.5, and at the same time a decrease in the DM content of the slurry.

Table 3.15: Effect of water delivery of drinking nipples on the production and dry matter content of manure of fattening pigs

Water delivery (l/pig per min)	Manure production (m ³ /pig place per year)	Dry matter content (%)
0.4	1.31	9.3
0.5	1.45	8.1
0.6	1.60	7.2
0.7	1.81	6.1
0.8	2.01	5.2
<i>Source: [44, IKC 1993]</i>		

In cases of restricted feeding, drinking water consumption is reported to increase as pigs tend to satisfy the feeling of hunger in this way; this extra quantity will be excreted as urine and increases slurry generation. Other nutritional factors that increase water consumption are the crude protein content in the feed, as well as sodium and potassium levels [359, Massabie P 2001].

3.2.2.2 Use of cleaning water

The volume of waste water produced on pig farms is directly related to the amount of cleaning water used. Water consumption on pig farms is affected not only by the cleaning technique applied, but also by the housing system, as a lot of water is used if washing the floors is required for the purpose of slurry removal. For example, the larger the slatted floor surface, the lower the cleaning water use. In Table 3.16, data are reported that have been measured in different farm types or floor systems, but large variations are generally observed depending on the use of high-pressure cleaning and the application of detergents to soak the surface. The differences in use between floor systems can therefore not explain by themselves the level and variation between different farms.

Table 3.16: Estimated average water use for the cleaning of pig housing in Denmark

Reared animal	Housing system (slurry management)	Consumption (litres/animal/cycle)	Consumption (litres/animal place/year) ⁽¹⁾
Farrowing sows	Crates, fully slatted floor	NI	340
	Crates, partly slatted floor	NI	340
Weaners (7–30 kg)	Fully slatted floor	15	87
	Draining floor with slits (50/50)	20	116
	Partly slatted floor	20	116
Fattening pigs (30–100 kg)	Partly slatted floor (50–75 % solid floor)	25	100
	Partly slatted floor (25–50 % solid floor)	25	100
	Solid floor	30	120
	Draining floor with slits (33/67)	25	100
⁽¹⁾ Consumption calculated for an average production time of 90 days for fattening pigs and 63 days for weaners in Denmark.			
NB: NI = no information provided.			
<i>Source: [437, Agrsci 2008]</i>			

Differences in the ease of cleaning have been reported, but not measured, in relation to wall and hard surface material. However, reduced water consumption has been reported for the cleaning of hard-packed floors, in comparison with concrete floors. This might therefore represent a potential means for reduced water use.

3.2.2.2.3 Use of cooling water

Water consumption related to cooling of pig houses by fogging or spraying systems depends on climatic conditions, and only occurs for limited periods during the year. One litre of water that evaporates at 25 °C absorbs 678 Wh from the environment. Additional information is available in Section 4.8.3.

3.2.2.2.4 Use of water for air cleaning systems

Air cleaning systems like biofilters, water scrubbers, chemical scrubbers and multi-stage systems consume significant volumes of water. The treated air leaves these systems at a humidity of more than 95 %. Water consumption is a function of the airflow rate, humidity and ambient temperature. This means that more water is provided to these systems in summer than in winter. On average over the year, fresh water consumption from 5 to 7 litres per 1 000 m³ of treated exhaust air are reported with the application of any of these air cleaning systems. Additional information concerning air cleaning systems is available in Section 4.9.

3.2.3 Energy consumption

Quantification of the energy consumption of livestock farms is a complex undertaking for all the production systems, as their organisation and systems are not homogeneous. Moreover, the technologies applied to the production system, on which the amount of energy consumption depends to a large extent, vary substantially depending on the structural and production characteristics of the farms. Another important factor that influences the energy consumption is the climatic conditions [506, TWG ILF BREF 2001]. The main measures applied in poultry and pig housing systems for reducing energy consumption consist of the control of heaters for the rearing of young livestock, the insulation of buildings, control of ventilation and artificial lighting systems [264, Loyon et al. 2010].

The reported energy use on poultry and pig farms and their main findings are presented in the following sections.

3.2.3.1 Poultry farms

As regards layer farms, artificial heating of the housing is not commonly applied, due to the low temperature needs of the birds and the relatively high stocking density. Activities requiring energy are:

- heating the water in winter;
- feed distribution;
- housing ventilation;
- lighting, this requires high consumption levels in order to artificially maintain a constant period of high light levels during the year, so as to increase egg production during the periods of the shortest days;
- egg collection and sorting: consumption is about 1 kWh per 50–60 m of conveyor belt;
- operating the sorting and packaging facilities.

On poultry meat farms, the main energy consumption is related to the following areas:

- heating in the initial phase of the cycle which is effected with hot air heaters (e.g. in France it accounts for around 80 % of the consumption);
- housing ventilation, which varies between the winter and summer periods from 2 000 to 12 000 m³/h per 1 000 heads (e.g. the capacity of the installed ventilation system is around 5 m³/h per kg of LW in France);
- lighting, which is critical for both animal welfare and performance;
- energy used for distribution, and sometimes, preparation of feed.

Seasonal variability of energy consumption during the year is primarily related to the type of farm and the type of systems used. On broiler farms, electrical energy consumption is at a maximum in the summer (ventilation) and thermal consumption is at a maximum in winter (heating). At laying hen farms, where winter heating is not used, the peak of (electrical) energy consumption is in summer, due to the increase in ventilation rate [391, Italy 1999].

Apart from annual trends, daily trends in electrical energy consumption are also quite variable and relate to the type of technical systems used on the farm. Often, there are two daily peaks corresponding to feed distribution. In poultry farms, the main sources of energy are propane gas and electricity. In addition to electricity and propane gas, fuel oil is used to run tractor engines and generators.

Propane gas is widely used for heating poultry meat houses, and, for instance, in France it accounts for approximately 2 % of the production costs in broiler production. In poultry meat farms, gas heating is very important not only to provide the high ambient temperatures required on the birds' arrival (32 °C for chicks and 34 °C for turkeys on the first rearing day) and during the first days of rearing, but also because of the large surface and the volumes of air flowing in the poultry houses, which induce high energy requirements for heating. The required installed heating power is equivalent to about 85–100 W/m² [341, Amand et al. 2007]. Data concerning the average gas consumption for poultry meat houses, observed in France, are reported in Table 3.17.

Table 3.17: Annual average gas consumption reported for poultry production in France

Type of animal production	Annual average gas consumption ⁽¹⁾		
	kg gas/m ²	kWh/m ²	kWh/kg of meat produced
Standard broilers	6.8 (4.7–8.2)	93.8 (64.9–113.2)	0.38 (0.34–0.48)
Heavy broilers	6.7 (4.2–8)	92.5 (58–110.4)	0.35 (0.30–0.43)
Female turkeys	6.9 (5.9–8.2)	95.2 (81.4–113.2)	0.56 (0.50–0.58)
Ducks (Barbary)	7.3 (6.0–8)	100.7 (82.8–110.4)	0.57 (0.47–0.58)
Guinea fowl	7.5 (7.1–8)	103.5 (98.1–110)	1.12 (1.06–1.19)
Broiler breeders	0.08	1.1	NA
Pullets	3.45	47.6	NA

⁽¹⁾ The range reported for each poultry species includes different housing, heating and ventilation systems.
 NB: NA = not applicable.
 Source: [342, ADEME 2008]

The average consumption of propane gas that is reported from the UK is approximately 15 kg/m² for broilers, corresponding to a share of the total production costs of around 6.5–8 %. For the rearing of turkeys, the average energy consumption is reported to be 77.2 kWh/m², which corresponds to around 3.4 % of the total production costs. As for gas, electricity consumption varies considerably according to the type of production due to the differences in the type of building, ventilation and heating needs. Data concerning the average electricity consumption for poultry meat houses, observed in France, are reported in Table 3.18.

Table 3.18: Annual average electricity consumption for poultry production in France

Type of animal production	Annual average electricity consumption		
	kWh/m ²	25 % of the lower reported values (kWh/m ²)	25 % of the higher reported values (kWh/m ²)
Standard broilers	15.2	9.4	20.3
Female turkeys	11.7	7.2	13.1
Broiler breeders	18.8	NI	NI
NB: NI = no information provided.			
Source: [342, ADEME 2008]			

In the UK, electricity consumption for the rearing of turkeys is reported to be equivalent to 2.64 kWh/m². Examples of breakdown values for electricity consumption are reported in Table 3.19, for two different poultry farms located in France, with a surface of 1 000 m² each.

Table 3.19: Distribution of electricity consumption for two poultry farms in France

Farm characteristics	Ventilation (%)	Lighting (%)	Feeding (%)	Watering (%)	Others (%)	Annual consumption (kWh)
Broilers – High consumption farm (mechanical ventilation, artificial lighting, water pumping from borehole)	48.1	32.5	4.7	8.7	6	21 000
Turkeys – Low consumption farm (no fans, natural lighting, connected to water supply network)	18.4	41.4	16	10.9	13.3	5 440
Source: [342, ADEME 2008]						

Table 3.20 shows the energy requirements of some essential activities on broiler and layer farms in Italy. The daily consumption will be quite variable depending on the size and the equipment used, on energy-saving measures, as well as on losses caused by lack of insulation. The overall energy consumption for laying hens based on these data was reported as ranging between 3.5 and 4.5 Wh per bird per day depending on the type of farm.

Table 3.20: Indicative levels of daily energy consumption of activities on poultry farms in Italy

Activity	Estimated energy consumption		
	Unit	Broilers	Laying hens
Local heating	Wh/bird/day	13–20 ⁽¹⁾	NA
Feeding	Wh/bird/day	0.4–0.6	0.5–0.8
Ventilation	Wh/bird/day	0.10–0.14	0.13–0.45
Lighting	Wh/bird/day	NI	0.15–0.40
Egg preservation (where necessary)	Wh/egg per day	NA	0.30–0.35
Conveyor belt for egg collection	kWh per 50–60 m	NA	1
Egg sorting and packaging	kWh	NA	1.5
⁽¹⁾ Only applicable at the initial stage of the cycle (15 days).			
NB: NI = no information provided; NA = not applicable.			
Source: [391, Italy 1999]			

Indicative levels of energy use in poultry farms in the UK are shown in Table 3.21 [500, IRPP TWG 2011].

Table 3.21: Indicative levels of energy use in poultry farms in the UK

Poultry category	Unit	Live weight (kg) at marketing	Electricity	Non-electric static equipment	Mobile machinery (fuel)
Broilers	kWh/bird per year	2.2	0.4–0.7	1.10	Trace
Turkeys	kWh/bird per year	14	4.20	7.00	Trace
Ducks	kWh/bird per year	3.5	2.6	1.75	Trace
Geese	kWh/bird per year	NI	Trace	Trace	Trace
Laying hens	kWh/dozen of eggs	NA	0.54	0.09	Trace

NB: NI = no information provided; NA = not applicable.
Source: [355, Warwick 2007] [500, IRPP TWG 2011]

In France, the total energy consumption for turkeys is reported as 111 kWh/m²/year (i.e. 6 to 8 kWh/bird or 17 kWh/bird/year), while for broilers it is reported to be in the range from 0.6 to 0.8 kWh/bird [500, IRPP TWG 2011]. Estimates of energy consumption in pullet and laying hen houses in France are shown in Table 3.22.

Table 3.22: Estimates of energy consumption (kWh/bird) for pullets and laying hens, in France

	Gas		Electricity	
	Cage system	Non-cage system	Cage system	Non-cage system
Pullets	1.42	1.42	0.45	0.45
Laying hens	NA	NA	3.15	2.45

NB: NA = not applicable.
Source: [340, ADEME 2007]

The measured energy consumption in a broiler farm in Finland is presented in Table 3.23.

Table 3.23: Energy consumption allocation in a broiler house in Finland

Unit	Electricity	Heat
kWh/batch	3 800	64 800
kWh/m ² /batch	2.38	40.5
kWh/m ² /year	14.3	243
kWh/bird place/year	0.88	15

NB: Data reported for a farm of 26 000 bird places, 6 batches/year, 1 600 m².
Source: [624, IRPP TWG 2013]

Approximately 50–70 % of the heat losses by convection from poultry houses occur from roofs that hence need to be well insulated. Losses are dependent on the different levels of insulation and of outdoor temperature (see example in Table 4.37).

3.2.3.2 Pig farms

Energy use on pig farms is related to lighting, heating, ventilation and feed preparation. Electricity is the main form of energy used as it responds to both needs for heating (e.g. radiant electric heaters) and power (e.g. ventilation, feed distribution, lighting). Fuel oil is the second source of energy, and it is mainly used to power generators but also for heating water in boilers (in more than 60 % of French farms) [343, ADEME 2008].

Gas, such as propane, is exclusively used for heating. In colder climates in northern Europe, like in Finland, consumption of fuels is significant because of the need for supplementary heating.

For example, in Finland, pig farm buildings are always heated in wintertime, and heating systems that make use of renewable energy are supported by farm building investments.

Energy sources are used in variable shares across Europe. In Italy, about 70 % of the energy used in pig rearing comes from fuel oil, whilst in the UK more than 57 % of the energy used is electricity. In moderate climates, such as France, electricity is the form of energy that is consumed the most.

The share of each energy source and the total average energy consumption, observed in France for different types of pig farms, are reported in Table 3.24. The variability between farms in total energy consumption is substantial, i.e. the standard deviation of the average energy consumption is equivalent to 328 kWh per sow per year for the integrated farrow-to-finish farm.

Table 3.24: Share of energy sources and total average energy consumption for different types of pig farms in France

Type of farm	Electricity	Fuel oil	Gas	Total average energy consumption	
	%	%	%	kWh/pig produced/year	kWh/sow/year
Farrow-to-finish	76	21	3	48	983
Rearing (weaners-to-fattening pigs)	86	14	0	25	NA
Breeding	70	30	0	19 (¹)	403

(¹) Value expressed in kWh/weaner produced.
 NB: NA = not applicable.
 Source: [343, France 2010] [344, France 2010]

The distribution of total energy consumption, reported from France for each physiological stage present in an integrated pig farm (where rearing from farrowing to finish is performed), is presented in Table 3.25. The shares of energy used for each process (heating, ventilation, lighting, feeding) are shown in Table 3.26.

Table 3.25: Distribution of energy consumption in integrated farms in France, for each physiological stage (average values from 15 farms)

Physiological stage	Weaners	Farrowing sows	Fattening pigs	Gestating sows	Other stages
Energy consumption (%)	36	22	27	8	7

Source: [343, ADEME 2008]

Table 3.26: Shares of energy consumption for each consuming process, in integrated farms in France

	Heating (%)	Ventilation (%)	Lighting (%)	Feeding (%)
Weaners	79	15	6	1
Fattening pigs	2	90	3	5
Farrowing	81	10	8	1

Source: [344, ADEME 2008]

The results of a project about the average annual energy consumption per LU (1 livestock unit = 500 kg) for different types of farms in Italy, are summarised in Table 3.27.

Table 3.27: Average annual energy consumption per type of pig farm and by type of energy source used and operation in Italy

Operation	Integrated farm				Fattening pig farm			
	Electricity		Fuels		Electricity		Fuels	
	kWh/yr/LU	%	kWh/yr/LU	%	kWh/yr/LU	%	kWh/yr/LU	%
Feeding	61.31	27.3	0	0	20.14	11.6	0	0
Ventilation and heating	95.08	42.3	0	0	85.12	49.1	70.84	81.2
Feed mill	14.32	6.4	0	0	27.87	16.1	0	0
Manure management	10.01	4.4	0	0	8.39	4.8	1.35	1.5
Manure processing	10.06	4.5	0	0	6.03	3.5	0	0
Manure application	31.08	13.8	52.75	100	19.39	11.2	15.08	17.3
Lighting	2.85	1.3	0	0	6.47	3.7	0	0
Total energy consumption	224.71	100	52.75	100	173.41	100	87.27	100

NB: LU = livestock unit = 500 kg.
Source: [669, Italy 2013]

The effect of farm size is also illustrated for farms in Italy (Table 3.28). Here, the larger the farm, the higher the energy consumption. This was explained by the use of more machinery in larger enterprises, with an associated higher consumption of power (factor 2.5). Interestingly, this is in contrast with the experiences in the UK, where large herds have lower energy inputs per head than small herds [395, ADAS 1999].

Table 3.28: Average daily energy consumption for farms in Italy by animal capacity and energy source

Energy source	Estimated energy consumption per animal capacity (kWh/head per day)			
	Up to 500 pigs	501 to 1 000 pigs	1 001 to 3 000 pigs	Over 3 000 pigs
Electrical energy consumption	0.061	0.098	0.093	0.150
Diesel fuel	0.084	0.107	0.169	0.208
Natural gas	0.002	0.012	0.023	0.010
Fuel oil	0.048	0.029	0.011	0.049
Liquid gas	0.042	0.048	0.018	0.026
Total thermal energy consumption	0.176	0.196	0.221	0.293
Total energy consumption	0.237	0.294	0.314	0.443

Source: [391, Italy 1999]

Heating and ventilation are the main consumers of electricity in pig farms. The average electricity consumption is presented in Figure 3.2 for the different uses in the farm for French conditions; the share for ventilation can be highly variable, depending on the characteristics of fans and ventilation management, and on the animals' physiological stages [344, ADEME 2008].

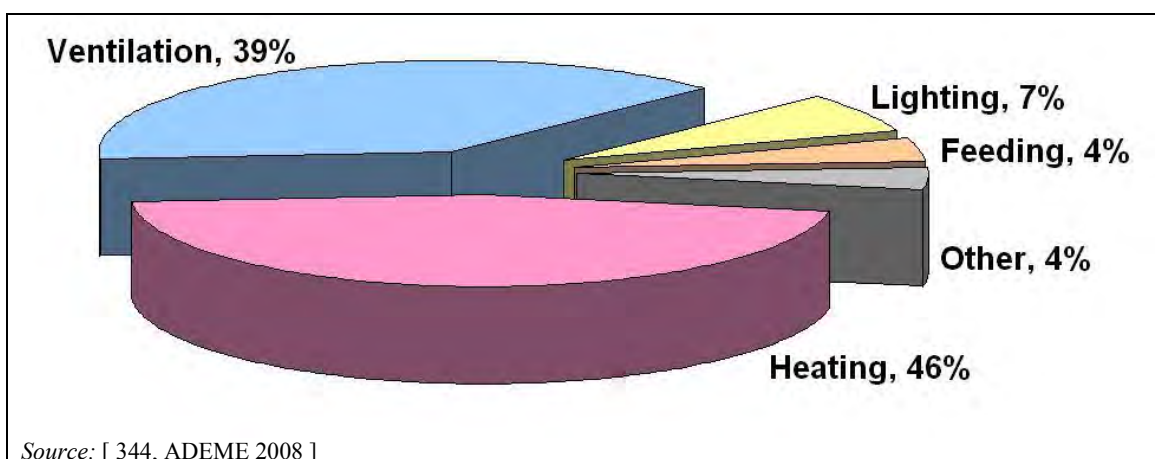

Figure 3.2: Breakdown of electricity consumption on pig farms in France

A study concerning electricity consumption on pig farms adopting different techniques was conducted in the UK over a period of 1 to 2 years. The observed results are reported in Table 3.29. A major conclusion reached by this study was that the choice of the system to be adopted has less influence on electrical consumption than the way in which the system is operated on a daily basis [432, BPEX 2010].

The main factors affecting the electricity use for ventilation are the stocking density (pig heat needs to be removed), and the differential between the outside temperature and the indoor target temperature. Whilst the outside temperature is beyond the control of users, the indoor target temperature is indeed a variable that can be managed.

Table 3.29: Electric energy consumption for different rearing stages in pig farms in the UK (data from 11 farms)

Animal category	Electric energy consumption (kWh/pig produced)			
	Total	Heating	Ventilation ⁽¹⁾	Lighting
Farrowing sows	6.3–11.3	3.9–12.6	0.04–1.43	0.6–0.9
Weaners	1.7–10.6	0.1–4.1	0.34–5.39	0.3–0.7
Growers	3.2–11.7	NI	3.59–14.7	0.9–2.6

⁽¹⁾ The lower values of the range were reported by farms equipped with ACNV systems.
 NB: NI = no information provided.
 Source: [432, BPEX 2010]

Lighting generally represents the third most relevant share of the total electric consumption of a pig farm. Daylight is considered to be desirable, but artificial light is used instead in areas where natural light intensity can be highly variable. Minimum lighting requirements are set by the welfare legislation. Energy requirements for the lighting of pig housing can therefore be quite different for different areas in Europe.

Energy use for heating depends on the type of animal, the climate in the different areas of the EU and the housing system as well as the management of air turnover in rooms, especially with regards to the minimum ventilation. Creep heating in farrowing houses represents a large proportion of total electricity use.

For feed preparation, the total energy use is considered to be between 15 and 22 kWh/tonne of meal produced where a hammer mill with pneumatic transfer is used to mill cereals. Pelletisation or cubing of the feed on farm will double the input, requiring about 20 kWh per tonne. Electrical consumption due to feed distribution is quite low in the case of dry feed but can be significant in the case of wet feed [432, BPEX 2010].

Pig rearing on litter is associated with less energy use because forced ventilation and heating are commonly applied only to the farrowing stage; therefore fuel oil is the main type of energy consumption for carrying out the activities of litter spreading and cleaning. As reported from France, the average energy consumption levels are 206 kWh/sow per year (10.8 kWh per pig produced) for integrated farms, and 11.1 kWh/pig produced for farms with the post-weaning and fattening rearing stages only; these results are associated with the energy consumed due to the use of litter, without including other forms of energy consumption (e.g. electricity consumption) [344, ADEME 2008].

3.2.4 Other inputs

3.2.4.1 Bedding (litter)

The amount of litter used depends on the animal species, the housing system and the farmers' preferences. Use of litter (bedding material) is normally expressed in kg per animal (per year). Examples of typical amounts of bedding material, for different animal categories, housing systems and operating conditions, are reported in Table 3.30 and Table 3.31. Amounts used may increase for both layers and pigs, where regulations on animal welfare and market demands require more use of litter-based housing techniques.

Table 3.30 Typical amounts of bedding materials applied in France in pig housing systems

Animal category	Litter management	Typical amounts used
		kg/animal
Fattening pigs	Deep litter (straw)	50–80
	Littered floor (straw)	30–50
	Deep litter (60 to 80 cm of sawdust)	50–60
	Deep litter (20 cm of sawdust)	20–40
Sows	Deep litter (straw)	900
	Littered floor (straw)	637
Weaners	Deep litter (straw)	10–15
<i>Source:</i> [262, France 2010] [263, France 2010]		

Table 3.31: Typical amounts of bedding material used in poultry and pigs housing systems

Animal species	Housing system	Litter used	Typical amounts used (kg/animal/yr)
Poultry			
Layers	Deep litter on all or part of the area, with or without veranda and outdoor run	Chopped straw, wood shavings	0.16–0.5
		Sand	0.075
	Deep litter with forced air drying system with vertical tubes	Wood shavings	2.5
Pullets	Deep litter	Chopped straw, wood shavings	2.3
Broilers	Deep litter, with or without veranda and outdoor run	Chopped straw (concrete floor)	0.3–0.59
		Chopped straw, wood shavings (clay floor)	1.1–1.9 ⁽¹⁾ (average 1.7)
		Peat	0.096 (free-range) 1.66 (closed housing)
		Wood shavings	0.067
Ducks	Deep litter	Chopped straw	7–28
Turkeys	Deep litter	Chopped straw, Wood shavings	2–5.8
Pigs			
Sows	Individual pen for farrowing	Straw	180
	Deep litter for mating/gestating		640
	Plain floor with yard		300–450 (average 420)
	Individual pen with partly slatted floors and vacuum removal, for mating/gestating		4
Weaners	Deep litter on solid floor	Straw	40–60 (average 53)
	Kennel housing with partly slatted floor		26
	Plane floor with yard		35
Fattening pigs	Deep litter on solid floor	Straw	275–400 (average 350)
	Plane floor with yard		250–300 (average 275)
	Partly slatted floor with vacuum removal		8.7
⁽¹⁾ Range derived from reported use of 4 to 7 kg per m ² per batch in France [500, IRPP TWG 2011], a standard density of 22.8 birds/m ² [418, ITAVI 2010] and 6.15 production cycles per year [328, CORPEN 2006]. Source: [87, Germany 2010] [144, Finland 2010] [145, Finland 2010] [97, UK 2010] [96, UK 2010] [116, Germany 2010] [117, Germany 2010] [193, Germany 2010] [191, Germany 2010] [181, Germany 2010] [183, Germany 2010] [185, Germany 2010] [276, Finland 2010] [60, Germany 2010] [61, Germany 2010] [62, Germany 2010] [64, Germany 2010] [65, Germany 2010] [66, Germany 2010] [71, Netherlands 2010] [72, Netherlands 2010] [109, Netherlands 2010] [49, Germany 2010] [81, Germany 2010] [172, Germany 2010] [161, Germany 2010] [157, Germany 2010] [229, Finland 2010] [119, Germany 2010] [624, IRPP TWG 2013] [500, IRPP TWG 2011]			

3.2.4.2 Cleaning material

Cleaning material (detergents) are used with water and will end up in waste water treatment facilities or in the slurry. A variety of detergents are used for cleaning the housing. Very little information is available on the amounts used. For poultry, a concentration of one litre of disinfectant per m³ was reported, but for pigs, quantification is considered to be very difficult and no representative data have been reported. The use of veterinary hygiene biocidal products is regulated by Directive 98/8/EC concerning the placing of biocidal products on the market and Commission Regulation 2032/2003/EC.

3.3 Excretion and emission levels

The majority of emissions from the main activities on any poultry or pig farm can be attributed to the amount, structure and composition of manure. From an environmental point of view, manure is the most important residue to be managed on farm. This section therefore starts by presenting an overview of the characteristics of poultry and pig manure before presenting the emission levels of the on-farm activities which involve manure management.

Emissions are presented as ranges rather than as single averages (mean values). On a national basis, emissions will vary within different ranges, but it is assumed that similar factors apply.

3.3.1 Excretion of nutrients and manure generation

This section reports on the excretion levels and nutrient contents of manure. Generally, the kind, quantity, and composition of the manure depend on the animal species, the age and the performance of the animals, the feed ration, and the housing techniques applied.

The properties of manure, expressed in dry matter (DM) content (expressed in %) and the concentration of nutrients (N, P, etc.), are mainly affected by the quality of feed and by the efficiency with which the animal can convert feed into product (feed conversion ratio). The efficiency of protein utilisation depends on the dietary composition and the physiological status or the growth stage of the animals. As feed characteristics vary considerably, the concentrations of nutrients in fresh manure will show similar variations. Measures applied to reduce emissions associated with collection (housing), storage and the processing of manure will affect the structure and composition of manure, and in the end will influence the emissions associated with landspreading.

Models and tables are available in various Member States to estimate how manure production and nutrient content vary with the production stage and the composition of the diet. These tools can be used to allow estimation of nitrogen and phosphorus outputs through landspreading. The different methods used for the assessment of excretion result, in general, in different calculations between Member States.

An example of a model used to estimate animal excretion, reported by Belgium, is presented in Table 4.6. With a knowledge of the composition of the feed, the model allows for the identification of the potential excretion levels of total N and P₂O₅ [506, TWG ILF BREF 2001]. Based on continuous improvements in feed quality and feed conversion, updates of the calculation parameters can be derived. The conversion factor between P and P₂O₅ is P x 2.2915

Several mathematical models have been developed to predict pig excretion. As an example, one calculation tool for fattening pigs is based on the following simple approach [610, Fefana 2012]:

$$\text{Nutrient Ingested (NI)} - \text{Nutrient Retained (NR)} = \text{Nutrient Excreted (NE)}$$

The calculation of nitrogen retention in the animal body tissues is based on the following equation [611, C.Rigolot et al. 2010]:

Equation 3.1: $N_{\text{body}} = [\exp(-0.9892 - 0.0145 * \text{Lean \%}) * \text{EBW}^{(0.7518 + 0.0044 * \text{Lean \%})}] / 6.25$

where:

Lean % = percentage of lean meat at slaughter weight;

EBW = Empty Body Weight (0.96 × body weight).

This tool can also calculate the excreted phosphorus, copper and zinc contents, taking into account specific conditions of each farm (observed or calculated feed intake, dietary content of feed, weight gain, production cycles, initial and final weight of animals, one-phase or two-phase feeding).

A methodology has been developed, within an EC-funded study, to assist individual producers in calculating manure coefficients for different animal categories, taking into account the animal type, diet and management practices [558, COM 1999]. The methodology is flexible enough to accommodate the variations in environmental conditions and farming practices within the EU. Table 3.32 summarises the ranges of calculated coefficients for animal excretion, adapted to different animal categories.

Table 3.32: Nitrogen excretion standards calculated for different animal categories

Animal category	Sows with piglets (till 25 kg)	Fattening pigs (25–105 kg)	Laying hens	Broilers (1.8 kg)	Ducks (3.3 kg)	Turkeys (13 kg)
Nitrogen excretion (kg/ap/yr)	21–32	7.5–13.1	0.35–0.82	0.23–0.52	0.41–0.97	0.9–1.68
<i>Source: [558, COM 1999]</i>						

3.3.1.1 Levels of excretion and characteristics of poultry manure

Depending on the housing system and the way of collecting manure, different types of poultry manure are produced:

- wet (fresh) manure from laying hens with a DM content of 25–28 %;
- wet manure from ducks with a DM content of 0–20 %;
- dry manure (> 45 % DM) from layers in housing where drying is applied;
- deep litter (50–80 % DM) from laying hens, broilers, turkeys and ducks;

Manure with a dry matter content between 20 % and 45 % is difficult to handle, and in practice water may be added to enable pumping as slurry. Deep litter is manure mixed with the bedding on which animals are kept on concrete or slatted floors. The DM content is important, as with increasing DM content, emissions of NH₃ will decrease. Calculations showed that, with quick drying to a DM content of > 50 %, the emissions of NH₃ (g/hr) were reduced to less than half the emissions of those from manure with a DM content of < 40 %.

Feed type, housing system (manure drying and the use of litter) and poultry breeds are factors that account for the variation in the manure composition. With respect to feeding, it is clear that the higher the protein level in feed, the higher the nitrogen levels in manure. For the different poultry species, nitrogen concentration levels vary within a similar range, also as a consequence of manure management (see Table 3.38).

In the next tables, examples of emission levels for excreted nitrogen, phosphorus and metals are reported for different EU Member States. The quantities of various elements (nutrients and metals) excreted with the manure, for different poultry species, reported from France, are presented in Table 3.33.

Table 3.33: Excretion levels of different elements in poultry manure, in France

Poultry category	Weight (kg)	Production cycles per year	Excretion level (g/bird place/year) ⁽¹⁾					
			Nitrogen	P ₂ O ₅	K ₂ O	CaO	Cu	Zn
Standard broilers	1.88	6.35	311	95	191	32	0.35	1.46
Laying hens	1.91	1	779	380	248	860	0.57	3.38
Turkeys (female)	4.52	7.6	1 352	790	844	418	1.53	6.32
Turkeys (mixed)	9.7	2.47	1 010	568	598	346	1.07	5.22
Turkeys (male)	12.56	2.35	1 159	569	691	398	1.43	6.09
Barbary ducks	4.8	3.5	735	294	357	235	0.71	3.42
Pekin ducks	3.17	5.11	491	275	302	179	0.67	2.86

⁽¹⁾ Values are derived from original data expressed as g/bird, using the given production cycles.
Source: [633, ITAVI 2013]

Examples of excretion levels concerning total nitrogen and phosphorus, reported from Ireland, Belgium (Flanders) and Italy, are presented in Table 3.34.

Table 3.34: Examples of excretion levels for total N and P, from Italy, Ireland and Belgium (Flanders)

Poultry type	Total nitrogen (kg/bird place per year)			Total phosphorus (as P ₂ O ₅) (kg/bird place per year)	
	Ireland	Italy	Belgium (Flanders)	Ireland	Belgium (Flanders)
Laying hens	0.56	0.66	0.81	0.12	0.45
Broilers	0.24	0.36	0.61	0.09	0.26
Turkeys	1	NI	1.7	0.4	1.05

NB: NI = no information provided.
Source: [612, TWG comments 2012] [666, Belgium Flanders 2011]

Calculated values for broilers' excretion in Denmark, based on the national normative system for 2014, are shown in Table 3.35.

Table 3.35: Standard values for excretion of broilers in Denmark (reference year 2014)

Production parameters	Age at slaughter (days)			
	30	32	35	40
Live weight at slaughter (kg)	1.63	1.81	2.09	2.55
Feed consumption, per bird produced (kg)	2.45	2.77	3.33	4.35
Protein content in feed (%)	20.2	20.1	20.0	19.8
Number of batches per year	10.1	9.6	8.9	7.9
Number of birds produced per m ² per batch	24.5	22.1	19.1	15.7
Number of birds produced per m ² per year	249	212	170	124
N excreted (kg per animal place per year) ⁽¹⁾	0.324	0.351	0.409	0.507

⁽¹⁾ Values calculated from the original figures on the basis of the number of batches per year.
Source: [612, TWG comments 2012] [653, Denmark 2014]

Calculated excretion levels for different poultry species in the Netherlands, based on standard data from 1999–2008, are presented in Table 3.36, together with the relevant parameters used in the calculation.

Table 3.36: Calculated excretion levels for different poultry categories, in the Netherlands (reference year 2008)

Poultry categories	Production cycle	Initial and final weight	Feed conversion	Total feed use	N excreted	P ₂ O ₅ excreted	K ₂ O excreted
	days	kg + egg production	kg feed/kg growth	kg/yr	kg/ap/yr	kg/ap/yr	kg/ap/yr
Broilers	41.8	0.42–2.23	1.8	34.5	0.53	0.19	0.26
Broiler breeders (< 18 weeks)	126	0.42–2 (hens) 2.75 (cocks)	NI	20.7	0.33	0.2	0.16
Broiler breeders (> 18 weeks)	298	2–7.75 (hens) 3.7–4.8 (cocks) + 11.9 kg eggs	NI	57.3	1.12	0.55	0.44
Laying hens (< 18 weeks)	119	0.35–1.47	NI	17.3	0.34	0.17	0.14
Laying hens (> 18 weeks)	409	1.47–1.76 + 17.3 kg eggs	NI	41.9	0.75	0.39	0.33
Male turkeys	129.5	0.57–15	2.65	112	1.71	0.87	0.9
Ducks	46	0.56–3.21	2.22	56.6	0.76	0.36	0.48

NB: NI = no information provided.
Source: [613, UR Wageningen 2012]

Data concerning the quantity of manure and total nitrogen produced by different poultry categories, reported from the UK, are presented in Table 3.37.

Table 3.37: Nitrogen and excreta production by poultry type in the UK (reference year 2012)

Poultry	Total N produced (kg/ap/year)	Manure output (kg/day)
Laying hens (cage)	0.67	0.12
Laying hens (non-cage)	0.75	0.12
Broilers	0.4	0.07
Pullets	0.33	0.04
Broiler breeders	1.02	0.12
Turkeys (male)	2.18	0.18
Turkeys (female)	1.46	0.13
Ducks	1.71	0.1

Source: [614, UK 2013]

The quantity of manure produced as well as the nutrients content in manure after housing and before landspreading (after storage) are reported from France and presented in Table 3.38.

Table 3.38: Composition and production of manure from different poultry species and manure management in France

Animal production	Type of manure	Manure produced			Cycles per year	Animal density (initial)	Nutrient content in the manure (kg/tonne)				
		kg/bird place per year ⁽¹⁾	kg/m ² per year	DM (%)			No	animal per m ²	N	P ₂ O ₅	K ₂ O
Laying hens	Wet droppings	NI	NI	25	1	NI	15	14	12	40.5	3
	Pre-dried droppings on belt	30–40	NI	40	1	NI	22	20	12	50	4.8
	Dried droppings in deep pit	15–17	NI	80	1	NI	30	40	28	60	8
	Dried droppings under shed	15–17	NI	80	1	NI	40	40	28	60	8
	Slurry	70	NI	10	1	NI	6.8	9.5	5.5	16.2	1.2
	Aviary	NI	NI	33–44	1	NI	15–28	10–12	7–8	NI	2–3
Ducks	Slurry	82	NI	10–15	4.9	14.5	5.9	5.9	4.1	6	1
Standard broilers	Solid manure from housing	5	120	75	6.15	22	29	25	20	14.5	3.7
	Solid manure after storage	5	120	75	6.15	22	22	23	18	11	2.8
Heavy broilers	Solid manure from housing	12–14	130–150	70	3.25	11	20	18	15	10	2.5
	Solid manure after storage	12–14	130–150	70	3.25	11	15	17	14	7.5	1.9
Turkeys	Solid manure from housing	19–22	150–170	65	2.6	7.8	27	27	20	23.5	3.7
	Solid manure after storage	19–22	150–170	65	2.6	7.8	21	25	18	18.2	2.8
Guinea fowl	Solid manure from housing	7–8	110–130	70	3.63	16.3	32	25	20	18	2

⁽¹⁾ Values calculated on the basis of the reported data.
 NB: NI = no information provided.
 Source: [258, France 2010] [328, CORPEN 2006] [434, ITAVI 2001]

3.3.1.2 Levels of excretion and characteristics of pig manure

The annual amount of pig manure, urine and slurry that is produced varies by pig category, the nutrient content of the feed and the drinking system applied, as well as by the different production stages with their typical metabolism. During the post-weaning period, feed conversion and live weight gain primarily affect the outputs per animal, whereas growth rate and muscle percentage are less important. For sows, outputs are not influenced by performance when expressed per animal, but can vary a lot when expressed per piglet. The length of the production period and the feed to water ratio are important factors that further account for the variation observed in amounts of slurry per year (see Table 3.39). With higher slaughter weights, higher levels of slurry generation are found.

Table 3.39: Range of levels reported for daily and annual production of manure, urine and slurry by different pig categories

Pig category	Production (kg/head/day)			Production (m ³ /head)	
	Manure	Urine	Slurry	Per month	Per year
Gestating sows	2.4	2.8–6.6	5.2–9	0.16–0.28	1.9–3.3
Farrowing sows ⁽¹⁾	5.7	10.2	10.9–15.9	0.43	5.1–5.8
Weaners ⁽²⁾	1	0.4–0.6	1.4–2.3	0.04–0.05	0.5–0.9
Finishers (85–120 kg)	2–4.1	1–2.1	3–7.7	0.09–0.26	1.1–3.1
Finishers (160 kg)	NI	NI	10–13	NI	NI
Gilts	2	1.6	3.6	0.11	1.3

⁽¹⁾ Water intake varies with drinking system.
⁽²⁾ Feeding and drinking system account for variation.
 NB: NI = no information provided.
 Source: [44, IKC 1993] [394, Smith et al. 2000] [411, Ireland 2001] [289, MLC 2005]

The following remarks can be made on the variation in the nutrient composition of manure. Feed composition and the level of feed conversion ratio (FCR) determine the nutrient levels of pig manure. Feed utilisation may vary, but advances in the understanding of pig metabolism make it possible to manipulate the composition of manure by adapting the nutrient content of the feed and using ingredients which improve feed utilisation by the animals. FCRs vary between the different stages of production, e.g. finishing pigs have FCR levels ranging between 2.5 and 3.1.

Important factors for the level of excretion of nitrogen and phosphorus are N and P concentration in the feed, animal production type, and stage of the rearing cycle. Many reports clearly show that lower nitrogen levels in manure result from lower crude protein (CP) levels in feed. With a lower consumption and an unchanged retention, nitrogen losses are considerably reduced (see Table 3.40).

Table 3.40: Example of effect of reduced CP levels in feed for growers and finishers on daily consumption, retention and losses of nitrogen

Animal category	Level of nitrogen (g/d)					
	Consumption		Retention		Losses	
	Low CP	High CP	Low CP	High CP	Low CP	High CP
Growers	48.0	55.6	30.4	32.0	17.5	23.7
Finishers	57.1	64.2	36.1	35.3	21.0	28.9
Total	105.1	119.8	66.5	67.3	38.5	52.6
Relative (%)	88	100	99	100	73	100

Source: [28, FORUM 2001]

The annual excretion of nitrogen and phosphorus by farrowing sows is the result of the excretion of both sow and piglets up to weaning, but varying litter size has a minor influence as illustrated with an example from the Netherlands (see Table 3.41). The data clearly show that excretion is influenced by the content of nitrogen in the feed, rather than by differences in technical performance (number of pigs). Nitrogen utilisation efficiency is considered to be highest by farrowing sows and piglets just after weaning.

Table 3.41: Average excretion of nitrogen (kg per year) in housing with a breeding sow (205 kg) and different numbers of piglets (up to 25 kg) at weaning

	Average number of weaners					
	17.1		21.7		25.1	
	N1	N2	N1	N2	N1	N2
N excretion factor						
Piglet feed	29.0	27.4	29.0	27.4	29.0	27.5
Sow feed – pregnant	22.0	20.4	22.0	20.4	22.0	20.4
Sow feed – lactation	25.5	23.9	25.5	23.9	25.5	23.9
N excretion						
N excretion (kg/yr)	28.7	26.2	29.5	26.7	29.5	26.6
NB: N1 = higher nitrogen content in feeds; N2 = lower nitrogen content in feeds.						
Source: [399, ID Lelystad 2000]						

Compared to the gestation-farrowing phases, the growing-finishing stages are biologically inefficient. In addition, the protein efficiency is lower for heavier live weights, as can be seen for the Italian heavy pig that is reared up to an average final weight of 160 kg (see Table 3.42). Since the growing and finishing phases (together fattening) account for the major contribution of excreted nitrogen in a closed cycle farm (77–78 %), the most efficient measures for abating the nitrogen emissions are those that are taken in these categories. The ratio of nitrogen excreted to nitrogen ingested for fattening pigs is generally high, e.g. around 65 %, on a closed cycle farm.

Table 3.42: Nitrogen retention in different growing phases of fattening pigs (Italian data)

Nitrogen balance (g/head per day)	Fattening phase (kg)		
	40–80	80–120	120–160
Nitrogen ingested	40.9	69.3	61.3
Nitrogen excreted	25.3	45.7	40.7
Nitrogen retention (%) (N ingested – N excreted)/N ingested	38.1	34.1	33.6
Source: [391, Italy 1999]			

The applied fattening method is very important. Whereas in Italy 1.5 fattening cycles are possible over 1 year, in other European Member States it is common to have between 2.5 and 3 rounds of fattening with different farming systems, leading to weights between 90 kg and 120 kg. The associated annual level of nitrogen excretion in Italy for a fattening period from 40 kg to 160 kg is reported as 15.4 kg N/animal place/year [391, Italy 1999].

In France, where it is common to have three cycles for fattening pigs per year and six cycles for weaners, the levels of nitrogen excretion that are possible with standard and two-phase feeding are those shown in Table 3.43.

Table 3.43: Standard level of nitrogen excretion in kg/animal place/year, in France

Pig category	N excretion	
	Standard feeding	Two-phase feeding
Sows ⁽¹⁾ (kg/animal place/year)	24.6	20.4
Weaners (8–30 kg) (kg/animal) ⁽²⁾	4.03	3.64
Fattening pigs (30–112 kg) (kg/animal) ⁽³⁾ ⁽⁴⁾	14.6	12.12

⁽¹⁾ For 1 200 kg of feed/sow per year.
⁽²⁾ Feed conversion of 1.74. Values calculated on the basis of 6.5 cycles per year.
⁽³⁾ Feed conversion of 2.86. Values calculated on the basis of 3.2 cycles per year.
⁽⁴⁾ For pigs heavier than 112 kg, excretion is increased by 0.067 kg N/cycle for each additional kg of live weight for standard feeding and by 0.06 kg N/cycle for each additional kg of live weight for two-phase feeding.

Source: [258, France 2010]

The evolution of ammonia volatilisation in relation to the total nitrogen excreted is ultimately different depending on the animal category, as is shown in Figure 3.3.

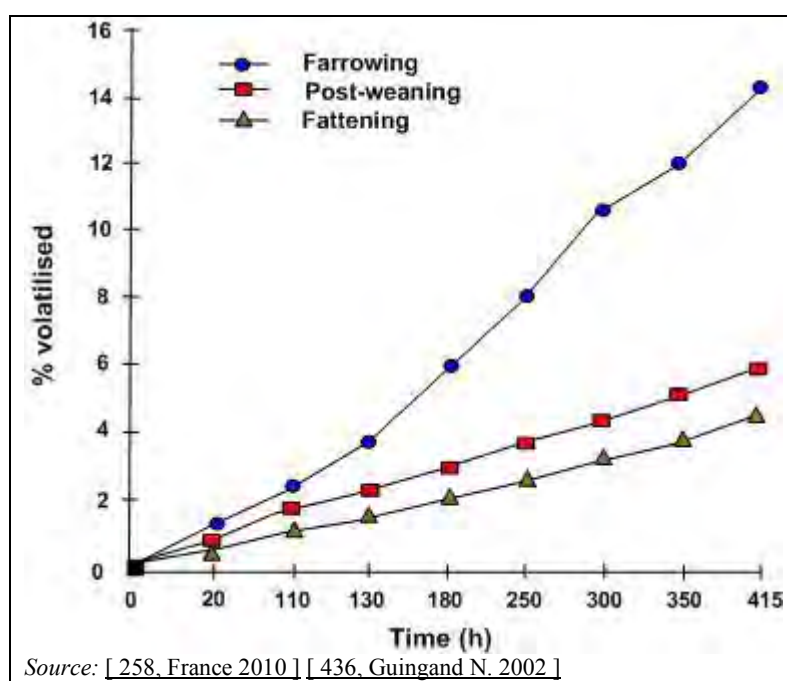

Figure 3.3: Evolution over time of ammonia volatilisation (percentage of total nitrogen) for different pig categories

Similarly to nitrogen excretion levels, phosphorus excretion varies with the total phosphorus content in the diet, the genetic type of the animal and the weight class of the animal (see Table 3.44). Availability of phosphorus in the diet is an important factor. In fact, measures to improve phosphorus availability (phytase) show reduced phosphorus emissions in manure. Retention of phosphorus is highest in weaners.

Table 3.44: Example of consumption, retention and excretion of phosphorus in pigs (kg per pig)

	Days	Consumption	Retention	Excretion			
				Faeces	Urine	Total	%
Sow							
Lactation	27	0.78	0.35	0.34	0.09	0.43	55
Dry + gestating	133	1.58	0.24	0.79	0.55	1.34	85
Total/cycle	160	2.36	0.59	1.13	0.64	1.77	75
Total/year	365	5.38	1.35	2.58	1.46	4.04	75
Pig							
Piglet (1.5–7.5 kg) ⁽¹⁾	27	0.25	0.06	0.12	0.07	0.19	75
Weaner (7.5–26 kg)	48	0.157	0.097	0.053	0.007	0.06	38
Finisher (26–113 kg)	119	1.16 ⁽²⁾	0.43	0.65 ⁽³⁾	0.08	0.73	63
⁽¹⁾ Based on 21.6 piglets/sow per year. ⁽²⁾ Feed intake 2.03 kg/day and 4.8 g P/kg feed. ⁽³⁾ Feed intake 2.03 kg/day and 2.1 g P/kg feed.							
Source: [538, Netherlands 1999]							

After the nitrogen and phosphorus content, the excretion of potassium, magnesium oxide and sodium oxide are also relevant for manure landspreading, see Table 3.45.

Table 3.45: Average composition of different types of pig manure and standard deviation (in brackets) in kg per 1 000 kg of manure

	DM	OM	N _{total}	N _m	N _{org}	P ₂ O ₅	K ₂ O	MgO	Na ₂ O	CaO	Density
kg per 1 000 kg of manure											kg/m ³
Slurry											
Finishers	90	60	7.2	4.2	3.0	4.2	7.2	1.8	0.9	NI	1040
	(32)		(1.8)	(1.1)	(1.3)	(1.5)	(1.9)	(0.7)	(0.3)	NI	NI
Sows	55	35	4.2	2.5	1.7	3.0	4.3	1.1	0.6	NI	NI
	(28)		(1.4)	(0.8)	(1.0)	(1.7)	(1.4)	(0.7)	(0.2)	NI	NI
Average slurry	NI	NI	9.6	NI	NI	4.8	5.9	1.7	NI	5.2	NI
Diluted slurry	NI	NI	4.3	NI	NI	3.8	2.6	1.2	NI	3.6	NI
Liquid fraction of solid manure											
Finishers	20–40	5	4.0–6.5	6.1	0.4	0.9–2.0	2.5–4.5	0.2–0.4	1.0	NI	1010
Sows	10	10	2.0	1.9	0.1	0.9	2.5	0.2	0.2	NI	NI
Solid manure											
Pigs (straw)	230–250	160	7.0–9.1	1.5	6.0	7.0–10.9	3.5–11.2	0.7–3.1	1.0	6–7.5	NI
Sawdust litter	336	278	6.4	NI	NI	8.2	11.1	NI	NI	NI	NI
Wood shavings litter	398	335	6.5	NI	NI	8.8	12.9	NI	NI	NI	NI
Compost of deep litter	NI	NI	7.6	NI	NI	10.2	14.7	3.0	NI	8	NI
Compost of scraped straw litter	NI	NI	11.0	NI	NI	18.3	20.8	4.0	NI	NI	NI
Compost of scraped litter and straw	NI	NI	7.7	NI	NI	14.9	10.5	2.0	NI	5	NI
Compost of mechanically separated solid fraction of slurry	NI	NI	7.2	NI	NI	43.4	2.6	3.0	NI	NI	NI
NB: OM = organic matter; N _m = metabolic nitrogen; N _{org} = organic nitrogen; NI = no information provided.											
Source: [44, IKC 1993] [389, ADAS 2001] [258, France 2010] [429, Texier et al. 2004] [433, CORPEN 2006]											

The standard quantities of nitrogen and manure excreted by different pig categories in the UK are presented in Table 3.46.

Table 3.46: Pig excreta and nitrogen produced in relation to different pig categories and nutritional measures, in the UK

Pig category	N excretion (kg/ap/year)	Manure output (kg/animal/day)	
		Slurry	Solid manure (FYM)
Weaners (< 20 kg)	3.4	1.3	1.5
Sows	18.1	11.1	12.5
Fattening pigs (20–50 kg)	8.9	3.8	4.3
Fattening pigs (50–80 kg)	13.3	3.8	4.3
Fattening pigs (80–110 kg)	15.4	5.2	5.9
Fattening pigs (> 110 kg)	15.4	5.2	5.9
Gilts	15.5	5.7	6.4
Boars	21.8	8.8	10

Source: [614, UK 2013]

From the Netherlands, calculated excretion rates per pig category and information on the physiological data associated with the calculations are presented in Table 3.47.

Table 3.47: Calculated annual excretion of nutrients per pig category, in the Netherlands (reference year 2008)

Pig category	Production cycle	Initial weight – Final weight	Growth rate	Total feed use	N excreted	P ₂ O ₅ excreted	K ₂ O excreted
	days	kg	kg/day	kg/yr	kg/ap/yr	kg/ap/yr	kg/ap/yr
Fattening pigs	117	25.3–116.6	0.778	781	12.9	5	8.1
Gilts - young boars	163	25.3–140	0.704	804	13.5	5.9	8.1
Breeding sows (mixed)	NI	140–230 ⁽¹⁾	⁽²⁾	1941	30.8	14.7	19.4

⁽¹⁾ 25.3 kg final weight of weaners.
⁽²⁾ 26.5 reared piglets per sow.
 NB: NI = no information provided.
Source: [613, UR Wageningen 2012]

Excretion rates per pig category in terms of total nitrogen (kg/year) and total phosphorus (kg/year) are presented in Table 3.48, as reported by Ireland and Belgium (Flanders) and adopted in the national regulations for the implementation of the Nitrates Directive.

Table 3.48: Annual excretion rates and slurry generation for pig rearing units and different pig categories, in Ireland and Belgium (Flanders)

Pig category	Ireland			Belgium (Flanders)	
	Slurry generation	Annual excretion rate		Annual excretion rate	
	m ³ /ap/yr	kg N/ap/yr	kg P/ap/yr	kg N/ap/yr	kg P/ap/yr
Breeding unit (per sow place)	9.048	35	8	NI	NI
Integrated unit (per sow place)	16.22–25.12	87	17	NI	NI
Finishing unit (per pig place)	1.25–2.76	9.2	1.7	NI	NI
Gilts not yet served	1.77	9.2	NI	NI	NI
Sows in pig	5.93	20	NI	24	14,5
Other breeding sows	2.48	20	NI	NI	NI
Boars	2.48	16	NI	NI	NI
Fattening pigs > 20 kg	1.77	9.2	NI	13.0	5.33
Fattening pigs < 20 kg	0.67	3	NI	2.18	1.53

NB: NI = no information provided.
Source: [615, IE EPA 2012] [666, Belgium Flanders 2011]

In Denmark, the calculation of standard excretion values is based on a simple balance between input and output. The input is derived from data recorded by farms yearly on feed intake and calculations based on the nutrient concentrations in the diets. The nutrient retention is calculated based on standard values obtained from literature. For farms using phase feeding and feed optimisation measures, the following values for nitrogen and phosphorus excretion are obtained. Figures from 2014, which reflect mostly farms that are using phase feeding and feed optimisation, are presented below in Table 3.49.

Table 3.49: Annual excretion rates for different pig categories, in Denmark (reference year 2014)

Animal category	Weight (kg)	Number of cycles	N excretion (kg N/animal place/yr)	P excretion (kg P ₂ O ₅ /animal place/yr)
Fattening pigs	32–107	4	11.3	5.4
Weaners	7.3–32	6.5	3.2	2.1
Mating and gestating sows	NI	⁽¹⁾	19.7	9.7
Farrowing sows ⁽²⁾	NI	⁽³⁾	33.4	16.5
Sows ⁽⁴⁾	NI	NI	22.61	11.14

⁽¹⁾ 115 days of gestation.
⁽²⁾ Including piglets up to 7.3 kg.
⁽³⁾ 31 days of lactation.
⁽⁴⁾ Values derived from individual values for gestating and farrowing sows for 115 days of gestation, 31 days of lactation and 2.25 litters per year.
NB: NI = no information provided.
Source: [653, Denmark 2014]

3.3.2 Emissions from housing systems

The following sections present the levels of emissions of different pollutants to air from poultry and pig housing systems. Emission data published for individual housing techniques generally show a large range of variation [474, VDI 2011]. The lowest levels are generally achieved with additional air cleaning techniques (end-of-pipe).

Emissions from animal housing facilities show great variability over the course of the day and the year. The level and variation of emissions to air are determined by many factors, which can be linked and can also affect each other. Major factors that influence emissions to air from housing are:

- Design and management of the animal housing and manure collection system;
- ventilation system and ventilation rate;
- applied heating and fluctuations of the indoor temperature;
- the growth stage of the animals and different animal activities over the course of the day;
- the amount and quality of manure, which in turn depends on:
 - feeding strategy;
 - feed formulation (protein level);
 - application of litter;
 - watering and watering system;
 - moisture content of manure;
 - stocking density;
 - animal's health state.

Key emissions to air that are produced in animal housing systems are ammonia (NH_3), odour, dust, methane (CH_4) and nitrous oxide (N_2O).

The main source of ammonia is the rapid hydrolysis of urea contained in urine by the urease, leading to ammonium (NH_4^+). Another source of NH_3 is the degradation of undigested proteins, but this pathway is not as fast as the previous. The urease is an enzyme largely present in faecal bacteria and it can be found in abundance on fouled surfaces like floors, pits and walls inside livestock buildings. Urease activity is affected by temperature; it is low at temperatures below 5–10 °C and above 60 °C. Under practical conditions, models show an exponential increase of urease activity related to temperature. Urease activity is also affected by pH, with optimum values ranging from 6 to 9, while animal manure pH is usually buffered to between 7.0 and 8.4. Therefore, optimal conditions for complete urea hydrolysis are largely met in animal husbandry, making the urea availability the limiting factor. The NH_4^+ production depends also on manure moisture content, as water is necessary for bacterial activity. Thus, NH_4^+ production is optimal between 40 % and 60 % moisture content; emissions decrease at values above and below this range. Ammonia generation stops below 5–10 % moisture content [590, Batfarm 2013].

Ammonia release from manure is also associated with the difference in NH_3 concentration between the manure and the air above. On the one hand, NH_3 concentration in the manure is affected by pH and temperature, as described above; on the other hand, NH_3 removal from the surface air is governed by the convective mass transport due to the house ventilation [277, Ji-Qin et al. 2000]. Due to its relatively low olfactory threshold, NH_3 has a relationship with nuisance odour, at higher than neutral pH conditions [277, Ji-Qin et al. 2000] [500, IRPP TWG 2011] [624, IRPP TWG 2013].

Dust emissions originate from the feed, bedding material and from the animal activities. The amount of airborne dust may vary significantly depending on the type of animal, but also in the course of a day. The concentration of dust in animal housing, in particular the PM_{10} fraction, can have a direct negative effect on the animals and humans, due to the compounds that the dust particles may carry (bacteria, toxins). Dust also plays an important role as a carrier of odorous compounds. The airborne particles that can be generated in livestock buildings range from non-organic substances (e.g. soil material) to organic particles from plants and animals, including dead and living microorganisms, such as bacteria, fungi, viruses and parts of these organisms, e.g. endotoxins. These biological components are usually named 'bioaerosols'. The main factors that affect dust emissions are ventilation, activity of the animals, type and quantity of bedding, the type and the consistency of feedstuff, and humidity in the animal house.

More dust is raised from bedded pens than from non-bedded ones. The kind and quality of litter influence the emissions. Finely structured material (e.g. chopped straw) emits more particles than coarse material (long straw, wood shavings).

The indoor dust concentration depends very much on the animal activity. Housing techniques which offer the animals only little freedom of motion (e.g. housing of laying hens in enriched cages) emit less dust than those which provide more freedom of motion (e.g. aviary housing of laying hens). In pig housing, airborne particulate matter also depends on the feeding technique and human presence. Each time feed and when the animals are disturbed (e.g. during inspection rounds), higher concentrations are measured than at night and in resting phases. The formation of dust can also be reduced, by serving liquid, moistened or pelleted feed and by using corn and grass feedstuffs in place of roughage (hay, straw) or by adding dietary fat or oil to dry feed.

Nitrous oxide formation occurs during incomplete nitrification-denitrification processes that normally convert NH_3 into N_2 . Thus, N_2O synthesis requires a close combination of aerobic and anaerobic areas; in general, these heterogeneous conditions are not met with slurry but with litter. However, N_2O emissions can occur from slurry when a dry crust is formed on the surface, generating anaerobic and aerobic micro-sites. Because of these numerous sources and different conditions that affect N_2O emissions formation, N_2O production from manure has a highly random nature, especially with litter systems [590, Batfarm 2013].

Methane production originates from the anaerobic degradation of organic matter performed by mesophilic/thermophilic bacteria with an optimal pH close to neutrality. In pig houses, the sources of CH_4 emissions are the animal digestive tract and the releases from the manure. The level of enteric CH_4 is a function of the fermentative capacity of the digestive tract in the animal, and the content, source and solubility of dietary fibre. In indoor slurry/manure storage, CH_4 release is promoted by high temperature, high organic matter content and low oxygen availability. On the contrary, the production is inhibited under aerobic conditions or high concentration of ammonium and sulphides. If a surface crust is formed on slurry, CH_4 releases are less, since the CH_4 produced can be oxidised into CO_2 during passage through the crust [590, Batfarm 2013].

A long-term investigation carried out in fattening pig houses, found a clear influence of the average daily outside temperature (above 25 °C) on the level of the CH_4 emissions. In the same study, it was also demonstrated that CH_4 emissions were reduced significantly when a complete slurry removal at the end of each cycle and subsequent cleaning of the slurry pits were performed [444, Haeussermann et al. 2006].

3.3.2.1 Emissions from poultry housing

Ammonia

In accordance with Council Directive 2007/43/EC, concentrations of ammonia must not exceed 20 ppm in the house, measured at the level of the birds' heads. According to a study carried out in the UK in 2002, ammonia concentrations in commercial broiler houses appear to be consistently below 15 ppm [149, Robertson et al. 2002]. In the case of reduced ventilation or high humidity, extremely high concentrations of ammonia are possible (50–200 ppm) [400, Silsoe Inst. 1997]. In general, peaks in ammonia concentrations are related to poor litter management.

An example of daily ammonia emission rates for different poultry categories as measured in the UK, for conditions without changes in the diet to reduce emissions, is described below [151, Link CR 2005]:

- 0.34 g/kg of LW/day for broilers, with significant farm variability ranging from 0.15 g/kg of LW/day to a peak measured value of around 1.3 g/kg of LW/day; higher emission rates coincided with higher moisture contents;

- values in the range of 0.2–1.8 g/kg of LW/day for laying hens, depending on manure storage, removal and/or crop age;
- 0.14 g/kg of LW/day for turkeys, ranging from 0.05 g/kg of LW/day during winter to 0.4 g/kg of LW/day in summer;
- 1 g/kg of LW/day for ducks, associated with higher moisture levels in the straw litter.

Indicative ammonia emission factors reported by various Member States, for the housing of different poultry categories, are presented in Table 3.50.

Table 3.50: Examples of national ammonia emission factors for poultry housing

Bird categories	Country	Ammonia emission (kg NH ₃ /ap/yr)	Source
Broilers	UK	0.039 ⁽¹⁾	[614, UK 2013]
	ES	0.094 ⁽²⁾	[616, Spain 2012]
Hens in cages (with belts)	UK	0.117 ⁽¹⁾	[614, UK 2013]
	BE-Flanders	0.085	[462, VITO 2005]
Hens on floor, with manure pit	UK	0.29 ⁽¹⁾	[614, UK 2013]
	FR	0.45 ⁽³⁾	[500, IRPP TWG 2011]
Hens on floor, with manure belts	DE	0.091	[571, Eurich-Menden et al. 2011]
	FR	0.15 ⁽³⁾	[500, IRPP TWG 2011]
Hens in cages	ES	0.204 ⁽²⁾	[616, Spain 2012]
Hens on floor	ES	0.189 ⁽²⁾	[616, Spain 2012]
Hens (cage and non-cage systems)	IE	0.14	[639, IE EPA 2014]
Turkeys (male)	DE	0.68	[571, Eurich-Menden et al. 2011]
	UK	0.659 ⁽¹⁾	[614, UK 2013]
Turkeys (female)	DE	0.387	[571, Eurich-Menden et al. 2011]
Turkeys (gender mix)	FR	0.263–0.374	[633, ITAVI 2013]
Ducks	DE	0.146	[571, Eurich-Menden et al. 2011]

⁽¹⁾ Values calculated from the mean emissions expressed as g N/LU/d and the live weight coefficients of Table 9.3.
⁽²⁾ Values corresponding to the reference system and calculated from kg N-NH₃/ap/yr reported.
⁽³⁾ EPER values.

Two indicative, more detailed, examples of national ammonia emission factors for poultry houses applied in Denmark are presented in Table 3.51.

Table 3.51: Ammonia emission factors for different poultry types, in Denmark

Animal category	Ammonia emission ⁽¹⁾	
	kg/1 000 birds produced	kg/ap/year ⁽²⁾
Broilers, 35 days at slaughter	11.82	0.098
Broilers, 40 days at slaughter	15.9	0.118
Turkeys, females, 112 days at slaughter	116.8	0.352
Turkeys, males, 147 days at slaughter	213.2	0.50
Ducks, 52 days at slaughter	42.01	0.251
Layers in cages with manure belt, 365 feeding days	84.39	0.084
Layers, barn, deep litter and manure pit	367.8	0.36
Layers, aviary (multi-tiered and manure belt), 365 feeding days	120.45	0.12

⁽¹⁾ Calculated from values given as kg NH₃-N in the Danish normative system.
⁽²⁾ The production cycles have been derived by dividing the breeding time by 365 days and considering 9 days between two batches.

Source: [500, IRPP TWG 2011] [624, IRPP TWG 2013]

Dust

In general, dust levels are higher in litter-based systems than in cage systems. Dust may function as a carrier for part of the emissions to air, but its correlation with odours is less clear than for pig housing [438, Lacey et al. 2004].

Studies carried out in France in laying hen housing showed a much higher dust concentration in aviaries than in cage systems. In one particular study, average dust emissions (particle size < 100 micrometres) were measured for a period of 5 hours, resulting in 1.8 mg/m³ in cage housing and 15.3 mg/m³ in aviaries [367, Michel et al. 2005]. Another study showed that the daily average concentration of fine dust (particle size < 4 micrometres) in deep litter houses was equivalent to 0.36 mg/m³, which is significantly higher than the average emission in cage systems, around 0.12 mg/m³. In addition, the measured values had a high variability in the case of litter systems (from 0.30 mg/m³ to 0.42 mg/m³), whereas values from cage systems were more homogeneous (from 0.10 mg/m³ to 0.14 mg/m³) [660, France 2010].

Under UK conditions, reported daily average dust emissions (with higher concentrations during the day and lower overnight) do not show significant differences between non-cage poultry houses (with the exception of a few broiler houses), with values generally below 0.4 g per kg of bird per day [151, Link CR 2005]. Dust emissions increase with the birds' growth and activity. During the first 3 weeks of rearing, young chicks are not very active and little dust is generated, but in the following stages, the older birds occupy most of the available space, walk more actively and lose feathers. As a consequence, more dust is generated. Point source concentrations of inhalable dust at broiler houses (at day 30) are about 5–7 mg/m³ [149, Robertson et al. 2002] but average values are between 1 mg/m³ and 3.5 mg/m³ [366, Renault et al 1997]. In Austria, an emission factor of 0.1 kg of dust per animal place per year is considered for laying hens reared in aviaries [373, UBA Austria 2009].

In duck rearing, an increase in dust emissions with the animals age/live weight is clearly observed, as is reported in Table 3.52.

Table 3.52: Estimated emissions from fan ventilated littered duck housing in the UK

Duck age (days)	NH ₃ emission (g/bird per day)	Dust emission (g/bird per day)
20	0.33	0.02
27	0.55	0.08
34	0.82	0.12
41	1.15	0.22
47	1.57	0.28
Source: [152, Link CR 2006]		

The highest concentrations are found in guinea fowl houses, where indoor dust concentrations were measured on average 35.7 mg/m³ [366, Renault et al 1997].

Nitrous oxide, methane and other gaseous emissions

The development of nitrous oxide (N₂O), methane (CH₄) and non-methane volatile organic compounds (NMVOC) is associated with the internal storage of manure; in general, their levels in housing can be considered very low when the manure is frequently removed.

Hydrogen sulphide (H₂S) is generally present in very low quantities, i.e. about 1 ppm [391, Italy 1999]. An overview of the reported emission values (given as ranges) associated with housing systems for NH₃, CH₄, N₂O, dust and odour, methane, for the different types of poultry, is given in Table 3.53. More information on odour emissions is presented in Section 3.3.9.

Table 3.53: Range of reported air emission levels from poultry houses

Type of poultry	NH ₃	CH ₄	N ₂ O	PM ₁₀	Odour ⁽¹⁾
	kg per bird place per year				ou _E /s per bird
Laying hens – Enriched cage systems	0.01–0.15	0.034–0.078	0.0017–0.023	0.01–0.04	0.102–0.68
Laying hens – Non-cage systems	0.019–0.36	0.078–0.2	0.002–0.180	0.02–0.15	0.102–1.53
Pullets (cage and not cage systems)	0.014–0.21	NI	NI	0.008–0.078	0.042–0.227
Broilers	0.004–0.18	0.004–0.006 ⁽²⁾	0.009 ⁽²⁾ –0.032	0.004–0.025	0.032–0.7
Broiler breeders	0.025–0.58	NI	NI	0.016–0.049	0.11–0.93
Turkeys (female) Whole period	0.045–0.387	NI	0.015 ⁽²⁾	0.09–0.5	0.4
Turkeys (male) Whole period	0.138–0.68	NI	NI	0.24–0.9	0.71
Ducks	0.05–0.29	NI	0.015 ⁽²⁾	0.01–0.084	0.098–0.49
Guinea fowl ⁽²⁾	0.80	NI	0.015	NI	NI

⁽¹⁾ Odour emissions have been derived from original data expressed in ou_E/s per LU.
⁽²⁾ Source: [43, COM 2003]
 NB: Emission levels achieved by air cleaning systems are included. Values derived from EPER are not included;
 NI = no information provided.

3.3.2.2 Emissions from pig housing

Ammonia

Many factors increase the variability of the level of emissions from pig housing, such as the nutrient content of the feed, the indoor climatic conditions, the management of the housing technique and the level of maintenance of the housing facilities.

In slurry-based housing systems, ammonia emissions may vary significantly because of differences in the surface area of the slurry channels, ratio of solid floor to slatted area, slurry pH, TAN concentration in the slurry, temperature and ventilation rate. Studies showed that planning the position of drinking and feeding areas, the social behaviour in a group and reactions to changes in climate all influence the defecating behaviour of the animals and hence can change the emission levels.

In particular, it is generally assumed that in buildings with partly slatted floors, the majority of the emission arises from the slurry channels and that floor emissions account for between 11 % and 40 % of the emission from the pens. The variation on ammonia emissions depends more on the cleanliness of the solid floor and the size of the slatted area rather than the quantity of slurry stored beneath the slats in partly slatted floors. The magnitude of the soiled area is related to the animal behaviour, which can be controlled partly through the design of the pens, the position of feeders and drinkers, and the control of the indoor climate [439, Sommer et al. 2006].

Normally, in ventilated buildings, pigs prefer to lie on a warm solid floor, which contributes to a tendency towards dunging in the slatted floor area. Thus, fattening pigs (30–110 kg) spend 87 % of their time lying, mostly on the solid concrete floor in buildings with a partly slatted floor. However, at high ambient temperatures, pigs prefer to lie on a cool surface, which will be the slatted floor and, consequently, defecate on the warmer (previously lying) surface. This fouling causes an increase in the emitting area, not only from the floor but also, to some extent, from the fouled animals themselves [439, Sommer et al. 2006].

In a reported example, in pens for group-housed sows designed with functional areas, it was observed that care had to be taken to guarantee the accessibility of these areas, as the social order in the group

prevented younger sows from free and easy access, when older sows blocked small passageways to the feeding and defecating areas. The young sows then started to defecate outside the designed slatted area, causing an increase in ammonia emissions. The use of periodical water shower drizzles has been reported as an effective measure to reduce this type of behaviour in the rearing of fattening pigs and sows [500, IRPP TWG 2011].

Another factor increasing NH₃ emission variability from housing is the increase in feed intake during the growing period, in particular with fattening pigs, which results in an increased excretion of total ammoniacal nitrogen (TAN), leading to a greater emission of ammonia [439, Sommer et al. 2006]. Increasing the number of animals per pen/room, taking into account animal welfare considerations, reduces the relative ammonia emissions per unit area [439, Sommer et al. 2006].

In litter-based systems, urine infiltrates the litter (sawdust or straw), thus reducing the surface area in contact with the air. Straw also has the effect of reducing the airflow over the emitting surface. At the same time, dung can be absorbed by the straw and transformed into organic nitrogen by microorganisms. This would suggest that the potential for nitrogen losses via volatilisation of NH₃ from deep litter systems might be smaller than from slurry systems due to the immobilization of ammoniacal nitrogen. However, the O₂ that diffuses into the porous surface layer is utilised by aerobic microbial activity in the litter, resulting in a temperature increase to about 40–50 °C, with consequent NH₃ losses [439, Sommer et al. 2006].

Ammonia emissions may be higher from straw litter floors than from slatted floors, where the straw is accumulated or removed at longer intervals, i.e. once per month [375, Philippe et al. 2007], or if composting starts in the straw-based systems. If soiled bedding material is regularly removed and replaced (weekly or daily), no significant difference of ammonia and dust emissions should arise from straw-bedded housing compared to slatted floor systems [289, MLC 2005] [439, Sommer et al. 2006].

In houses where pigs are reared on deep litter straw bedding (i.e. where more straw is added at intervals and the manure is removed at the end of the cycle), ammonia emissions can vary from 15–25 % of the excreted nitrogen to 5–15 %, in the case where bedding exceeds 50–80 kg/animal, or if the stocking density falls from 1–1.4 m²/pig to 2 and more m²/pigs [378, Robin et al. 2004]. Nevertheless, the variation in the reported emissions of comparative studies demonstrates that there is no consistent difference between slurry-based and deep litter systems [439, Sommer et al. 2006].

The differences in the specific characteristics of the livestock and manure management systems, as well as different climatic conditions are reflected by differences in the emission factors used by Member States. An example of detailed reference emission factors, used in pig housing in the UK, is presented in Table 3.54.

Table 3.54: Ammonia emission factors for pig housing, used in the UK

Animal category	Average live weight	NH ₃ emission factor	
	kg	g N/LU/d	kg NH ₃ /ap/yr ⁽¹⁾
Sows – straw	200	25.2	4.47
Sows – slats	200	17	3.01
Farrowing sows – straw	225	25.2	5.01
Farrowing sows – slats	225	26.7	5.32
Weaners – slats	12	27.7	0.29
Fattening pigs – straw	65	50.2	2.89
Fattening pigs – slats	65	69.6	4.01
Boars – straw	250	25.2	5.68

⁽¹⁾ Values are calculated from the reported emission in g N/LU/d and the average live weight presented in Table 9.3.
Source: [614, UK 2013]

In Germany, the standard emission factor associated with slurry systems for fattening pigs is 2.9 (2.4–6.1) kg NH₃/ap/yr when N-adapted feeding is applied but no other mitigation measures [121, Germany 2010]. Standard ammonia emission factors for pig housing used in Germany are presented in Table 3.55; these factors are not associated with nutritional measures nor ammonia mitigation measures.

Table 3.55: Ammonia emission factors for pig housing by pig category, in Germany

Pig category	NH ₃ emission factor (kg NH ₃ /ap/yr)
Fattening pig farms	
Forced ventilation, liquid manure technique (partially or fully slatted floors)	3.64
Forced ventilation, solid manure technique	4.86
Natural ventilation, liquid or solid manure technique ((kennel housing, sloped floor housing)	2.43
Outdoor climate house, deep litter technique	4.2
Breeding farms	
All breeding sows including piglets up to 25 kg	7.29
Mating and gestating sows	4.8
Farrowing sows (sows including piglets up to 10 kg)	8,3
Weaners	0.5
Gilts	3.64
<i>Source: [474, VDI 2011]</i>	

Spain has also compiled emission factors for the reporting obligations related to the E-PRTR [667, Spain 2011].

Nitrous oxide and methane

In pig houses where no bedding is used, the slurry produced remains in a predominantly anaerobic state with little opportunity for the NH₄⁺ to be nitrified. As a result, little or no N₂O emissions are likely to occur from such buildings [443, Chadwick et al. 2011]. Emissions ranging between 0.66 g and 3.62 g N₂O/LU per day have been measured from slurry-based pig houses with fully slatted floors. Much higher emissions may occur from deep litter systems with fattening pigs, where values between 4.8 g and 7.2 g N₂O/LU per day have been reported [443, Chadwick et al. 2011]. From a literature review for solid manure systems in housing for fattening pigs in the Netherlands, Germany and Belgium, the measured average value for N₂O emissions is 2.7 g N₂O-N per day per animal place [441, Webb et al. 2012].

Investigations on methane release from a pig house with indoor slurry storage showed an emission rate of 3.8 kg CH₄/ap/yr when slurry pits were emptied at the end of the cycle but not cleaned afterwards. In particular, average daily CH₄ emissions ranged from 0.8 g to 124 g/day/LU or 0.1 g to 22.5 g/day/pig. CH₄ emission rates were very low until day 16–19 of the fattening period. The average CH₄ emission per animal per year was reduced by 40 % when the slurry removal was combined with a complete cleaning of the slurry pit [444, Haeussermann et al. 2006].

Dust

Dust levels are higher in litter-based systems than in slurry systems. Dust particles function as a carrier for part of air emissions. The emission levels associated with different housing techniques and reported during the information exchange have been summarised per animal category (sows, weaners and fattening pigs) in Table 3.56, Table 3.57 and Table 3.58. More information on odour emissions is given in Section 3.3.9.

Table 3.56: Range of emissions to air from housing systems for sows (mating/gestating, farrowing)

Housing system	NH ₃	CH ₄	N ₂ O	PM ₁₀	Odour
	kg/ap/yr				ou _E /s/animal
Mating and gestating sows (slurry system)	0.21–4.2	18.2–21.1 ⁽¹⁾	NI	0.035–0.22	1.3–57
Mating and gestating sows (solid manure system)	1.0–5.6	5.5–6.2	NI	NI	6.6
Farrowing sows (slurry and combined slurry/solid manure system)	0.42–9.0	NI	NI	0.03–0.16	5.6–100

(¹) Source: [43, COM 2003]
 NB: Emission levels achieved by air cleaning systems are included; NI = no information provided.

Table 3.57: Range of emissions to air from housing systems for weaners

Housing system	NH ₃	CH ₄	N ₂ O	PM ₁₀	Odour
	kg/ap/yr				ou _E /s/animal
Slurry system	0.03–0.8	0.28–5.98	NI	0.006–0.132	1.1–12.1
Solid manure system and combined slurry/solid manure system	0.11–0.7	0.29–0.70	0.02–0.57	0.08	2.25–3

NB: Emission levels achieved by air cleaning systems are included; NI = no information provided.

Table 3.58: Range of emissions to air from housing systems for fattening pigs

Housing system	NH ₃	CH ₄	N ₂ O	PM ₁₀	Odour
	kg/ap/yr				ou _E /s/animal
Slurry system	0.1–4.6	0.42–30	0.015–0.24	0.01–0.24	1.14–29.2
Solid manure system and combined slurry/solid manure system	1.9–7.53	0.54–18.0	0.01–3.7	0.05 ⁽¹⁾ –2.4 ⁽¹⁾	4.2–7

(¹) Source: [43, COM 2003]
 NB: Emission levels achieved by air cleaning systems are included.

3.3.3 Emissions from manure storage facilities

Ammonia losses from buildings and after spreading livestock manure are usually the most important emission sources. However, losses from stored slurry and solid manure can also make a significant contribution to the total emission of ammonia. The storage of solid manure and slurry is a source of gaseous emissions of ammonia, methane, nitrous oxide and odorous compounds. The liquid draining from solid manure (e.g. heaps in fields) can also be considered an emission (nitrate leaching). Emissions from manure storage depend on a number of factors:

Solid manure

- chemical composition of manure (i.e. the concentration of NH₄-N);
- composting potential (water content, density and C content);
- emitting surface;
- application of covers.

Slurry

- chemical composition of slurry (i.e. the concentration of $\text{NH}_4\text{-N}$);
- physical characteristics (dry matter %, pH);
- emitting surface (size, crusts);
- climatic conditions (ambient temperature, rain, wind);
- application of covers.

Of the aforementioned factors, the most important are the dry matter and nitrogen content (in particular TAN). Dry matter essentially depends on the manure management, whilst nitrogen depends on the feeding practices. In addition, housing techniques that aim for a reduction of emissions from in-house collection of solid manure and slurry also affect the manure's nitrogen content and, consequently, emissions during storage.

Quantification of ammonia emissions, although not easy, can be done through measurements by means of direct methods, such as the dynamic chamber technique for slurry or by enclosing the manure heap in a large 'polytunnel' where emissions can be captured [258, France 2010] [500, IRPP TWG 2011].

Baseline emissions without any cover on the stored manure surface are assumed to be between 1.4 kg and 2.7 kg $\text{NH}_3\text{-N}$ per m^2 per year based on data from western European countries; lower values might be observed where stored manure is frozen for several months, and higher values in warm countries [508, TFRN 2014].

3.3.3.1 Emissions from solid manure storage

Measured ammonia and nitrous oxide emissions from solid manure heaps are presented in Table 3.59 and Table 3.60. Data represent a literature review derived from official reports and peer-reviewed articles. A limited number of studies concerned N_2O emission from manure heaps.

Ammonia emission factors vary from being negligible to being very high and may account for more than the initial TAN ($\text{NH}_3+\text{NH}_4^+$) in the manure, because ammonia emissions may also originate from mineralised organic nitrogen. This variation in NH_3 emission is due to the effect of treatment of the manure, i.e. storage time, aeration and temperature [590, Batfarm 2013] [441, Webb et al. 2012].

Table 3.59: Average ammonia and nitrous oxide emissions during storage of solid pig manure in heaps

Type of manure	Emissions	Average	SD	No	Max.	Min.	Source
FYM	$\text{NH}_3\text{-N}$ (% of total N)	30.8	37.8	13	123.4	0.1	[441, Webb et al. 2012]
FYM		23.5	0.7	NI	NI	NI	[439, Sommer et al. 2006]
Deep litter		4.8	2	4	7	2.4	[441, Webb et al. 2012]
Deep litter		30.2	7.7	NI	NI	NI	[439, Sommer et al. 2006]
FYM	$\text{N}_2\text{O-N}$ (% of total N)	0.5–2.63	NI	2	NI	NI	[443, Chadwick et al. 2011]
Deep litter		4.6	3.5	4	9.8	2.5	[441, Webb et al. 2012]
FYM	$\text{N}_2\text{O-N}$ (g $\text{N}/\text{m}^2/\text{day}$)	1.9	1.1	4	2.9	0.7	[441, Webb et al. 2012]

NB: No = Number of reports and publications from which the values were derived; SD = Standard deviation.
FYM = Farmyard manure; NI = no information provided.

Table 3.60: Ammonia and nitrous oxide emissions during storage of solid poultry manure in heaps

Type of manure	Emissions	Average	SD	No	Max.	Min.	Source
Litter	NH ₃ -N (% of total N)	8.3	5.9	13	18.4	0.3	[441, Webb et al. 2012]
Manure removed daily with belt		2.1	1.8	4	4.5	0	[441, Webb et al. 2012]
Litter	N ₂ O-N (% of total N)	0.17–0.81	NR	1	NI	NI	[443, Chadwick et al. 2011]

NB: No = Number of reports and publications from which the values were derived.
SD = Standard deviation; NR = not relevant; NI = no information provided.

Ranges for national emission factors reported by several Member States are presented in Table 3.61.

Table 3.61: Range of ammonia emission factors for solid poultry manure storage as reported by Member States

Poultry category	Ammonia emission factor (kg NH ₃ -N/animal place/year)
Broilers	0.024–0.04
Laying hens	0.027–0.067
Turkeys	0.092–0.14
Broiler breeders	0.022

Source: [615, IE EPA 2012] [612, TWG comments 2012] [500, IRPP TWG 2011]

An example of emission factors used by a Member State (the UK) for calculating overall ammonia emissions from solid manure stores is presented in Table 3.62.

Table 3.62: Emission factors reported by the UK for solid manure storage

Production	Manure type	Ammonia emission factors	
Pig manure (FYM)	Manure heap	1 224 g N/t initial heap mass/yr	1.49 kg NH ₃ /t initial heap mass/yr
Poultry manure	Manure belts	1 956 g N/t initial heap mass/yr	2.38 kg NH ₃ /t initial heap mass/yr
Poultry manure	Deep pit	1 956 g N/t initial heap mass/yr	2.38 kg NH ₃ /m ² /yr
Poultry manure	Litter	1 435 g N/t initial heap mass/yr	1.74 kg NH ₃ /m ² /yr

Source: [612, TWG comments 2012] [614, UK 2013]

In Germany, the ammonia emission factor associated with solid manure storage is 5 g NH₃/m² of surface area per day [474, VDI 2011].

Ammonia emissions can be reduced (e.g. by 75–80 % by sheeting) or increased (e.g. by 80–150 % by turning the heap), depending on the management strategy applied. Nitrogen losses in leachate from the heaps can range between 2.3 % and 5.3 % of the total nitrogen initially stored for pig manure and between 0.8 % and 8.2 % for broiler litter [207, ADAS 2004].

It has been reported that, within the first 30 days of storage, ammonia losses are over 80 % of the total emissions for pig manure and 25–45 % for broiler litter, whereas losses from slurry storage continue at a relatively steady pace throughout the storage period [253, ADAS 2002]. Because the evolution of NH₃ emissions is basically determined by the tendency for self-heating (composting) which occurs in most heaps of porous manure, ammonia emissions can be reduced by covering the heap, in order to limit internal air transfer, or by a deliberate compaction of the manure [441, Webb et al. 2012].

A literature review (see Table 3.59 and Table 3.60) concluded that N₂O emissions from manure heaps are very variable, and a single major condition affecting the emission could not be established. The production of N₂O that takes place during storage is significant due to nitrification and subsequent denitrification. Emissions of N₂O from poultry manure tend to be smaller [441, Webb et al. 2012].

CH₄ emissions occur only under locally anaerobic conditions. Aerobic decomposition in straw-rich porous heaps of solid manure leads to both high temperatures and anaerobic hotspots, causing CH₄ emissions, even though the heap is largely aerobic. On the other hand, if an airtight cover is used on the heap, thereby inhibiting the activity of aerobic microorganisms and the associated temperature increase, CH₄ emissions will be reduced, even though the heap is largely anaerobic. Another strategy that can be used to reduce methane emissions from stored solid manure is frequent turning, which reduces anaerobic zones in the heap [441, Webb et al. 2012] [443, Chadwick et al. 2011].

3.3.3.2 Emissions from slurry storage

When storing slurry, some NH₃ is initially emitted from the surface layer, but later the impoverished surface layer blocks volatilisation. The formation of a floating crust may depend on the dry matter content of the slurry, as well as the climatic conditions: heavy rains soak the crust which will tend to be weighed down, diluting the slurry at the surface, whereas warm and sunny climatic conditions allow the quick formation of a crust. An intact crust is an effective barrier against NH₃ losses. Low volatilisation may also be caused by the neutral pH value. Stirring will obviously raise the dry matter to the surface and increase the volatilisation of NH₃, thereby causing peaks in emissions to air. Ammonia emission factors from uncovered stored pig slurry, as reported in a literature review, are presented in Table 3.63.

Table 3.63: Ammonia emissions from uncovered stored pig slurry

Parameter	Ammonia emission (kg NH ₃ -N/m ² /yr)		
	Concrete store Untreated slurry	Lagoon Untreated slurry	Concrete store Slurry fermented in biogas plant ⁽¹⁾
Average value	2.18	0.78	2.33
Standard deviation	2.1	1.07	0.68
⁽¹⁾ Cattle and pig slurry. Source: [439, Sommer et al. 2006]			

The ammoniacal nitrogen loss from pig slurry storage in open tanks and lagoons correspond to between 6 % and 30 % of the total nitrogen in stored slurry, assuming there is an emitting surface over the whole year. The emission from pig slurry stored in lagoons appears to be less than that from slurry stored in concrete stores, because the TAN concentration is less [439, Sommer et al. 2006].

Emission factors reported by Denmark for slurry storage, showing the effect of slurry covers, are presented in Table 3.64.

Table 3.64: Ammonia emission factors for covered and uncovered slurry storage in Denmark

Type of cover	Raw slurry		Digested slurry	
	NH ₄ -N as % of NH ₄ -N ex-house	NH ₄ -N as % of total N ex-house	NH ₄ -N as % of NH ₄ -N ex-house	NH ₄ -N as % of total N ex-house
No cover	11.4	9	27.3	21
Covered (natural crust, straw cover)	2.5	2	5.2	4
Tent or concrete cover	1.3	1	2.6	2
Source: [442, Hansen et al. 2008]				

Ranges of reported national ammonia emission factors for the storage of pig slurry are presented in Table 3.65.

Table 3.65: Range of ammonia emission factors for pig slurry storage as reported by Member States

Pig category	Ammonia emission factor (kg NH ₃ -N/animal place/year)
Growers/finishers (20–100 kg)	0.6–2.62
Weaners (6–20 kg)	0.15–1.07
Farrowing sows	2.05–6.82
Sows in full cycle	14.4
<i>Source:</i> [412, Italy 2001] [258, France 2010] [439, Sommer et al. 2006] [616, Spain 2012] [615, IE EPA 2012]	

In Germany, the ammonia emission factor for uncovered pig slurry storage is 10 g NH₃/m² of surface area per day [474, VDI 2011]. In the UK, the corresponding emission factor for slurry stores and lagoons is 3.16 g N/m² of surface area per day [614, UK 2013].

Nitrous oxide emission from slurry or liquid manure with no surface cover is negligible, as slurry stores remain principally anaerobic unless O₂ is introduced as a consequence of a treatment process, or unless windy conditions prevail. Slurry crust conditions can control N₂O emissions, e.g. when the surface layer has a reduced water content N₂O emissions increase and may be as high as 25 mg N₂O-N/h per m² of surface. Emissions are reduced or stopped at low temperatures and when the surface crust or surface straw layer has a high water content [443, Chadwick et al. 2011]. A synthetic permeable cover can enhance or delay N₂O emissions, depending on whether a natural crust will form in the absence of a synthetic cover [517, Petersen et al. 2011]. The Intergovernmental Panel on Climate Change (IPCC) assumes a N₂O emission factor of 0.005 kg N₂O-N/N ex-animal for slurry stores with a crust [659, IPCC 2006]; however, there is little knowledge about the extent and control of N₂O emissions from slurry crusts. Actual emissions will probably vary seasonally, according to local climatic conditions, but also depending on the potential for nitrification, which may vary considerably [517, Petersen et al. 2011].

Slurry stores are sources of methane as the anaerobic environment favours methanogenesis. A higher temperature and longer retention time of organic material in the system greatly increase the amount of methane produced. Uncovered lagoons have a higher potential for CH₄ emissions than other systems under most circumstances as they are associated with longer retention times [659, IPCC 2006]. Covers were found to have contrasting effects, in particular:

- the formation of a slurry crust can reduce CH₄ emissions as a result of methane oxidation;
- mixing slurry with straw may enhance the methanogenic formation of CH₄;
- covering slurry stores with porous surfaces, e.g. straw, expanded clay pebbles or recycled polyethylene, may reduce CH₄ emission due to oxidation to CO₂;
- high concentrations of cellulose and lignin may limit the rate of CH₄ production due to the reduced hydrolysis of the lignified structures in the biomass.

Methane emissions are also influenced by the following parameters:

- mild agitation of the slurry has been shown to increase CH₄ emissions;
- frequent removal of slurry from the store or channel reduces the pool of methanogenic bacteria within this environment. Thus, in pig houses where slurry was removed from channels after each fattening period, emissions were 40 % lower than in houses where channels were not cleared as frequently;

- a positive correlation between CH₄ emissions during storage and the temperature of manure or slurry has been observed. Methane production is low at temperatures below 15 °C, but increases exponentially as the temperature rises above 15 °C [443, Chadwick et al. 2011];
- reducing the organic matter content of slurry through separation or fermentation in a biogas digester may prove to be the most efficient way of reducing CH₄ emissions during outdoor storage. However, it is shown that digested slurry should be cooled to ambient temperatures in post-treatment storage tanks to reduce CH₄ emissions. Also, acidification of slurry for the purpose of reducing NH₃ emissions from storage has been observed to reduce CH₄ emissions.

3.3.4 Emissions from manure processing

For various reasons manure is processed on farm and several techniques are described in Chapter 4, together with a report on their environmental and technical characteristics. With regards to reported data, consumption and emission levels are indicative and specific for the situation in which they are obtained.

Input levels of manure and slurry vary with the number of animals on the farm. Various additives are used to enhance chemical reaction(s) or to react with unwanted elements in the reaction substrate. These may affect emissions to water or air.

During the treatment processes, e.g. lagoon systems, liquid fractions may be produced that have to be discharged. Odour may arise due to suboptimal process conditions, although a number of techniques aim to reduce odorous components (e.g. composting, aerobic digestion). Incineration emits dust and other flue-gases. Techniques such as biogas reactors deliberately form gaseous compounds, which can be used in heaters and engines but from which exhaust gases are then emitted.

3.3.5 Emissions from landspreading

The level of emissions from landspreading depends mainly on the chemical composition of slurries and manures, the prevailing climatic conditions and, mostly, the way in which they are handled. The composition varies and depends on the diet, as well as on the method and duration of storage and the treatment, if any, applied before application. Values of nitrogen and K₂O will be lower for farmyard manure (FYM) stored for long periods in the open. Slurries may become diluted by drainage and wash water, thus increasing in volume, albeit with a decreasing dry matter content.

The nitrogen content of livestock manure is present in two main forms:

- Readily available nitrogen which is potentially available for rapid crop uptake.
- Organic nitrogen, which is slowly released to become available for crop uptake over a time period of months to years. Organic N contributes only to a small extent to N fertilisation in the year of application. In this way, around 10 % of the total nitrogen content may become available for the second crop following application.

Two major processes regulate the loss of nitrogen from landspreading:

- Ammonia volatilisation is the most important source of emissions. Ammonia emissions following slurry or manure landspreading are strongly influenced by the readily available N content of the manure. Slurries and poultry manures are 'high' in readily available N (typically 40–60 % of total N), compared with farmyard manure which is 'low' in readily available N (typically 10–25 % of total N).
- Nitrate leaching. Livestock manures are the greatest source of avoidable nitrate leaching losses. The NH₄-N content of manure is rapidly converted to nitrate-N and can then be used by plants or otherwise lost by leaching or by denitrification. The amount of N leached is mainly related to the manure application rate, readily available N content and timing of applications.

There are various manure management practices that minimise nitrogen losses via ammonia volatilisation, such as rapid soil incorporation on arable land for solid manure and band spreading (trailing hose/shoe) or shallow injection for slurry. In order to reduce nitrate leaching losses, it is important to apply manure throughout the growing season (i.e. in late winter or spring to mid- or late summer) depending upon the climatic conditions, soil and crop type applicable to the land on which it is being spread, when there is a crop demand for nitrogen, rather than in the autumn/winter period when the demand is low and nitrate in the soil is likely to be leached into the groundwater or surface waters. Changing manure application timings from autumn to spring is likely to increase the pool of soil mineral nitrogen [245, ADAS 2002] which is available for the crop uptake but also for nitrification-denitrification microbial processes in the soil, leading to production of NO_3^- , N_2 and a potential increase of 'direct' N_2O emissions. If needed, additional applications of mineral nitrogen to the soil should be adapted properly. A schematic representation of the process regulating the utilisation and losses of nitrogen from manure landspreading is presented in Figure 3.4.

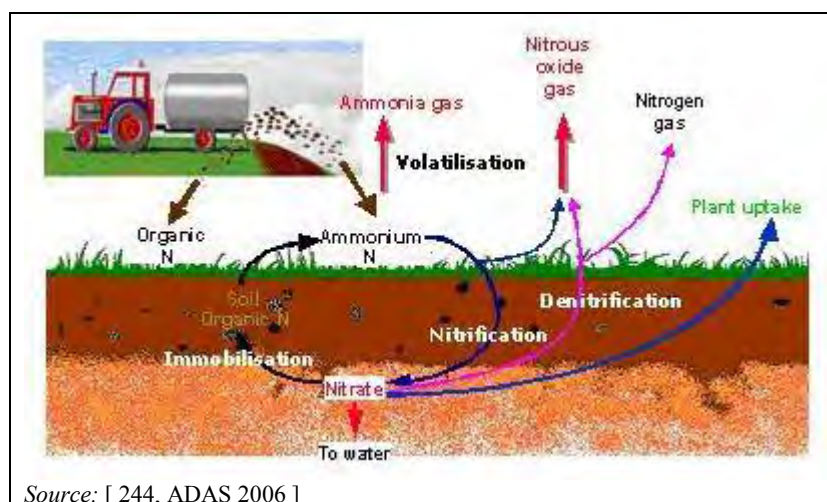

Figure 3.4: Nitrogen losses from manure landspreading

3.3.5.1 Emissions to air

Ammonia emissions during and following slurry application are influenced by a wide range of interacting variables, which are shown in Table 3.66.

Table 3.66: Factors influencing the emission levels of ammonia into air from landspreading

Factor	Characteristic	Influence
Soil	pH	Low pH gives lower emissions
	Cation exchange capacity of soil (CEC)	High CEC leads to lower emissions
	Moisture level of soil and porosity	Ambiguous
Climate factor	Temperature	Higher temperature gives higher emissions
	Precipitation	Causes dilution and better infiltration and therefore lower emissions to air, but increased emissions to soil
	Wind speed	Higher speed means higher emissions
Management	Application method	Low emission techniques
	Manure type	DM content, pH and ammonium concentration affect emission level
	Time and dose of application	Warm, dry, sunny and windy weather should be avoided; excessively high doses increase infiltration periods
Crop conditions	Crop height	Limited ammonia losses when slurry is spread on crops compared to bare land

Source: [22, Bodemkundige Dienst 1999] [442, Hansen et al. 2008]

Any ammonia conserved during housing and storage is subjected to losses during and after landspreading. To achieve a high overall reduction in ammonia emissions in the whole production chain, as well as cost-effectiveness for ammonia abatement, slurry or solid manure have to be incorporated into the soil. Results of field trials carried out in the UK, illustrating the effect of different storage conditions, incorporation techniques, and manure compositions on emissions after landspreading of solid manure, are presented in Table 3.67.

Table 3.67: Emissions from solid manure landspreading, with or without incorporation, reported from the UK

Type of manure	Storage before landspreading	Incorporation	Manure composition	Ammonia emissions	Emission reduction after incorporation, compared with surface application
			NH ₄ -N as % total N content	NH ₄ -N as % total N applied	(%)
Fresh pig manure	No	No	26–38	13–41	NR
Fresh broiler litter	No	No	46–52	16–28	NR
Pig manure	Conventionally stored (open air) for 6 months	No	NI	8	NR
Broiler litter	Conventionally stored (open air) for 6 months	No	20–32	16	NR
Pig manure	Sheet-covered for 6 months	No	NI	22	NR
Broiler litter	Sheet-covered for 6 months	No	40–50	29	NR
Pig manure	Conventionally stored (open air) for 12 months	No	< 5	< 3	NR
Fresh pig manure	No	By plough after 4 hours	26–38	NI	84
Fresh broiler litter	No	By plough after 4 hours	46–52	NI	90
Fresh pig manure	No	By plough after 24 hours	26–38	NI	64
Fresh broiler litter	No	By plough after 24 hours	46–52	NI	78
NB: NI = no information provided; NR = not relevant.					
Source: [207, ADAS 2004.]					

Ranges of NH₃ emissions after landspreading of solid manure, as derived from a survey of published results, are presented in Table 3.68. Data mainly relate to experiment results obtained under different climatic conditions in central and northern Europe.

Table 3.68: Range and average values of ammonia emissions measured after landspreading of solid manure without incorporation

Type of manure	Emissions (NH ₃ -N as % of TAN)	No
Pigs	63 (average) 41–76	19
Poultry	40 (average) 36–73	6
NB: No = number of datasets used. Source: [441, Webb et al. 2012]		

In general, poultry manure is expected to emit less than pig manure, as the hydrolysis of uric acid to urea may take several months and is often incomplete, even after application [441, Webb et al. 2012].

The ranges of reported national ammonia emission factors for slurry landspreading for the two main pig categories, fattening pigs and sows, are presented in Table 3.69.

Table 3.69: Ranges of national ammonia emission factors for slurry landspreading, as reported by Member States

Production	Ammonia emissions (kg NH ₃ -N/animal place/year)
Fattening pigs	0.56–1.47
Sows	1.45–3.65
Source: [612, TWG comments 2012] [615, IE EPA 2012] [615, IE EPA 2012]	

The average emissions of ammoniacal nitrogen from slurry landspreading, in relation to different application methods, expressed as a percentage of total NH₄-N applied, are presented in Table 3.70. Data refer to 199 measurements on grassland and 58 measurements on arable land carried out in the Netherlands.

Table 3.70: Average NH₄-N emission factors and ranges of measured values, expressed as percentage of total ammoniacal nitrogen applied

Type of land	Application technique	Emissions (NH ₄ -N as % of TAN applied)	
		Average	Range
Grassland	Surface spreading	74	28–100
	Narrow band	26	9–52
	Shallow injection	16	1–63
Arable land	Surface spreading	69	30–100
	Surface incorporation	22	3–45
	Deep placement	2	1–3
Source: [232, Huijsmans et al. 2009]			

Emissions of N₂O-N during pig slurry landspreading have been estimated by the Intergovernmental Panel on Climate Change to be equivalent to 0.01 kg N₂O-N/N ex-animal, with a minimum and a maximum value of 0.003 kg N₂O-N/N and 0.03 kg N₂O-N/N, respectively [659, IPCC 2006].

Results of a study reporting N₂O losses (average and range) after landspreading and incorporation of solid manure, under different storage conditions, are presented in Table 3.71.

Table 3.71: Emissions of N₂O-N from landspreading of solid manures

Manure management	Emissions (N ₂ O-N as % of total N)
Surface-applied manure, conventionally stored	1.04 (average) 0.07–3.09
Stored manure, incorporated into the soil after 4 hours	0.38 (0.08–1.08)
Fresh manure, applied on the surface	0.7 (average) 0.05–2.17
Fresh manure, incorporated into the soil after 4 hours	1.02 (average) 0.4–3.27
<i>Source: [250, IGER 2004]</i>	

A summary of field test results from a literature review, concerning landspreading of pig manure under different soil textures, crops, seasons, application methods and amounts of nitrogen per ha, is presented in Table 3.72 [443, Chadwick et al. 2011].

Table 3.72: Reported N₂O-N emissions from pig manure landspreading

Type of manure	Nitrous oxide emissions		
	N ₂ O-N (% of total N)	N ₂ O-N (% of TAN)	Total N ₂ O-N (kg/ha)
Slurry (No=15)	0.12–2.95	0.26–9.55	0.4–2.51
Solid (No=12)	0–3.27	0–5.3	0.03–3.27
NB: No = number of experiments inventoried. <i>Source: [443, Chadwick et al. 2011]</i>			

Emissions of CH₄ generally occur only immediately after manure landspreading as methanogenesis is inhibited by the presence of O₂. In total, the amount of methane emitted from surface application was shown to be negligible, whereas, when slurry is applied via shallow injection, the anaerobic nature of the slot environment results in higher CH₄ emissions [443, Chadwick et al. 2011].

3.3.5.2 Emissions to soil and water

A large amount of the nitrogen, phosphorus and potassium in livestock diets is excreted in manure and urine. Manures contain useful amounts of these plant-available nutrients, as well as other major nutrients such as sulphur, magnesium and trace elements. For a number of reasons not all of these elements can be used by plants and some may cause environmental pollution.

Two types of pollution can be distinguished: point source and diffuse pollution. Point source water pollution can occur through direct contamination of a watercourse from a burst or overflowing slurry store, yard run-off, or immediately after landspreading and during heavy rain. Such incidents can have catastrophic effects on fish and other aquatic life, mainly because of the high biochemical oxygen demand (BOD) and dissolved ammonia contained in manures. BOD measures the amount of oxygen consumed by microorganisms in breaking down organic matter and typically ranges between 10 000 mg/l and 30 000 mg/l for slurry, compared with 300 mg/l to 400 mg/l for raw domestic sewage [389, ADAS 2001].

Diffuse pollution can affect soil, water and air and, unlike point source pollution, is not easily seen. The resulting contamination is associated with farming practices over a wide area and over extended time periods, rather than a particular action or event, and may have long-term effects on the environment. An example is volatilised ammonia deposition, which can contribute to soil acidification problems, particularly in woodland soils. It can raise nitrogen levels in soils low in nutrients, causing a change in the type of plants that grow in the affected area, e.g. botanically rich habitats in old

meadows and heathlands [389, ADAS 2001]. Deposited ammonia can also contribute to nitrate leaching losses.

Of the agricultural emissions to soil and groundwater, the most important are the residual emissions of nitrogen and phosphorus. The processes involved in their distribution are:

- for N – leaching (NO_3^-), denitrification (NO_2 , NO , N_2) and run-off;
- for P – leaching and run-off.

Nitrogen leaching from livestock manure occurs mainly by percolation through soil layers when manure is landspread improperly, i.e. without taking into account existing regulations and fertiliser planning. Similarly, phosphorus is lost to the environment via run-off and leaching; although phosphorus leaching is closely connected to soil erosion mechanisms [218, Baltic Sea 2020 2010]. Conversely, some part of nitrogen and phosphorus is also stored in the soil for medium- or long-term release.

Nitrogen and phosphorus have completely different turnovers in the agricultural environment. Excess fertilisation with phosphorus does not necessarily leach out like in the case of nitrogen; phosphorus can accumulate in the soil layers, where it can be slowly converted into other forms. Agricultural soils can bind varying amounts of phosphorus, but accumulation increases the amount of labile-P and the risk of phosphorus leaching [218, Baltic Sea 2020 2010]. Potassium can also be lost by leaching and surface run-off, causing a decrease in the fertiliser value of manure but without posing an environmental risk.

European concerns over the environmental impacts of nitrates leaching led to the adoption of the Nitrates Directive (Council Directive 91/676/EEC). The Directive introduced voluntary Codes of Good Agricultural Practice, the designation of Nitrate Vulnerable Zones (NVZs) for areas with high nitrate levels (or a risk of this) in the waters, and a mandatory Action Programme for farms within the NVZs. The Action Programme requires farms to fertilise according to the needs of the crops and not to spread livestock manure in periods when lands are waterlogged or frozen; indirectly, this is a requirement for sufficient manure storage capacity.

However, the nitrogen that is saved by measures to reduce ammonia emissions from landspreading may increase the potential for nitrate leaching, especially if the application of mineral nitrogen is not reduced. In comparison with slurry, solid manures, having an inherently lower ammoniacal nitrogen content, are considered to have less readily available nitrogen for nitrification and subsequent nitrates leaching [249, Webb et al. 2001]. However, the loss of nitrogen during the storage of solid manure depends on the potential for composting.

Emissions to surface water are due to leaching and run-off. Nitrogen leaching is highest in winter and on sandy soils. This is more evident where manure landspreading occurs in autumn and with empty fields in winter, as rainfall is likely to wash nitrate out of the soil before crops can use it. Phosphorus loss in surface run-off following manure application occurs when the soil's infiltration capacity is exceeded, or when phosphorus attached to soil particles is eroded. It is most likely to occur if heavy rain follows application, or when the soil is already saturated [506, TWG ILF BREF 2001]. On soils with low organic matter content, this will rarely occur.

Where practically possible, applications during the autumn-early winter period should be avoided, as well as over winter. Delaying applications, particularly of manures high in available nitrogen, until the late winter or spring will increase the utilisation of manure nitrogen and reduce nitrate pollution.

3.3.5.3 Emissions of metals

There are several sources responsible for the introduction of heavy metals into agricultural ecosystems, such as indigenous sources (e.g. the weathering of rock), atmospheric deposition, manure application, pesticides, irrigation, fertilisers, secondary material (such as waste water sludge, compost), crumbling away of riverbanks, feed import, feed additives and animal medication.

Livestock manures, and pig slurry in particular, contain significant amounts of certain metals, specifically copper (Cu) and zinc (Zn), mainly because they are used at high concentrations as feed additives. Continuous landspreading can lead to the accumulation of these metals and undesirably high levels in the soil, which may pose a medium- or long-term toxicity risk to plants and microorganisms. The concentration in the soil should be maintained below the level that ensures the non-transference to the food chain [253, ADAS 2002] [590, Batfarm 2013].

In situations where manure landspreading has been applied for a number of years, and will continue to be applied, it is advisable to have these soils analysed to determine their metal status and to monitor build-up periodically [389, ADAS 2001]. A proportion of metal inputs from surface-applied manures is recycled through the agricultural system in animal feeds grown and fed on farms [253, ADAS 2002].

Copper and zinc are involved in many metabolic functions, and their provision in sufficient amount in feeding is indispensable to ensure good performance and animal health. However, because they are used as growth promoters at pharmacological levels, or because large safety margins are applied, copper and zinc may be oversupplied in pig diets. Consequently, these elements are highly concentrated in manure, especially in pig manure. Moreover, when a treatment is applied to the slurry, copper and zinc will follow the solid fraction where their concentration often exceeds the maximal values allowed for the utilisation of these products as organic fertilisers. The only way to decrease the concentration of trace elements in manure is to restrict their incorporation in the diet.

The incorporation of 150–250 ppm (mg/kg) of copper in pig diets has been employed for a long time because of its growth-promoting effect. This practice is authorised in the EU, allowing diets containing a maximum of 170 ppm of copper for weaners up to 12 weeks. After 12 weeks of age, the use of copper as a growth promoter is no longer allowed within the EU, and the maximum content authorised in feedstuffs is 25 ppm. Nevertheless, the practical supply remains high compared with the theoretical requirements (< 10 ppm according to published data), and the average retention efficiency is still less than 1 %.

With Regulation 1334/2003/EC, the maximum zinc incorporation allowed in pig diets was reduced to 150 ppm, from a previous concentration of 250 ppm. These levels are closer to the theoretical requirement found in published literature, which vary between 50 ppm and 100 ppm, depending on the growing stage, and according to the different authors. However, in some EU Member States, supplementation with 2 500 ppm of zinc is still allowed as medication, resulting in an increased excretion of metal [590, Batfarm 2013].

With the EU Regulation 1334/2003/EC, reported copper and zinc contents in the manure dry matter (about 350 mg/kg DM and 1 250 mg/kg DM, respectively) are below the maximum concentrations allowed in sewage sludge in France (1 000 mg/kg DM and 3 000 mg/kg DM, respectively), but they exceed the concentration allowed for organic fertilisers (300 mg/kg DM and 600 mg/kg DM, respectively). Assuming that 170 kg N/ha are spread each year, it will take 160–170 years for the soil to reach 50 mg Cu or 150 mg Zn per kg of dry matter. However, copper and zinc inputs to soil with a manure application rate of 170 kg N/ha still exceed the metals absorbed by crops [590, Batfarm 2013]. Emissions of metals associated with landspreading of poultry manure, as reported by France, are presented in Table 3.73.

Table 3.73: Emissions of metals associated with landspreading of poultry manure

Type of poultry	Cu (mg/bird place/year)	Zn (mg/bird place/year)
Broilers ⁽¹⁾	342	1 410
Laying hens	708	3 380

⁽¹⁾ Calculation based on 6.15 cycles per year.
Source: [617, ITAVI 2012]

3.3.6 Emissions from the whole farm

In general, nitrogen emission reductions achieved in one production step influence the nitrogen quantity in the following steps and, therefore, also the quantity of potential NH₃ emissions from each step. A reduction of ammonia emissions in the pig house would normally lead to more ammonium reaching the slurry store; this will potentially increase the risk of ammonia emissions from the store. As a result, part of the reduction effect in the animal house may be lost. At the same time, an emission reduction measure applied for manure storage can become more cost-effective if more ammoniacal nitrogen reaches the store. In principle, emissions that might be avoided in one step of the production may increase emissions in the following step, i.e. due to a higher nitrogen content in the manure. In order to address this important interrelationship, animal husbandry also has to be considered in the entire process chain. For this purpose, nitrogen emissions in the individual process steps: feeding, housing, as well as slurry storage and landspreading, are combined into an entire chain [575, UBA Germany 2011].

3.3.6.1 Emissions from the whole-farm process chain for the rearing of poultry

Reported examples of general emissions factors used by some Member States to define the nitrogen flow at each stage of manure management are presented in Table 3.74 and Table 3.75 for broilers and laying hens.

Table 3.74: Examples of the nitrogen flow through the whole farm chain for broiler manure

Parameter	France		Denmark		Spain	
	N losses (%)	N content (%)	N losses (%)	N content (%)	N losses (%)	N content (%)
N excreted in housing	NR	100	NR	100	NR	100
In-house losses (% N excreted)	30	30	20	20	19.6	19.6
N available in outside storage	NR	70	NR	80	NR	80.4
Storage losses (% N ex-house)	15	10.5	7	14.4	11	8.8
N available for landspreading	NR	59.5	NR	65.6	NR	71.5
Spreading losses (% N ex-storage)	10	5.9	31.4 ⁽¹⁾	20.6	38	27.2
Usable N for crop	NR	53.5	NR	45	NR	44.3
N losses from whole farm	NR	46.5	NR	55	NR	55.7

⁽¹⁾ Derived from a reported value of 45 % as usable N when applied to the fields.
NB: NR = not relevant.
Source: [328, CORPEN 2006] [616, Spain 2012] [500, IRPP TWG 2011] [618, DAFC, DK 2013]

Table 3.75: Examples of the nitrogen flow through the whole farm chain for laying hen manure

Parameter	Denmark (Hens in cages)		Denmark (Hens in barns)		Spain	
	N losses (%)	N content (%)	N losses (%)	N content (%)	N losses (%)	N content (%)
N excreted in housing	NR	100	NR	100	NR	100
In-house losses (% N excreted)	10	10	14	14	28.7	28.7
N available in outside storage	NR	90	NR	86	NR	71.3
Storage losses (% N ex-house)	5	4.5	5	4.3	8	5.7
N available for landspreading	NR	88.5	NR	81.7	NR	65.6
Spreading losses (% N ex-storage)	NI	NI	NI	NI	37	24.3
Usable N for crops	NR	NI	NR	NI	NR	41.3
N losses of whole farm	NI	NI	NI	NI	NR	58.7

NB: NI = no information provided; NR = not relevant.
Source: [616, Spain 2012] [618, DAFC, DK 2013]

Data concerning nitrogen losses as ammonia for each step of the poultry production system, reported by France for different types of poultry manure, are presented in Table 3.76.

Table 3.76: Nitrogen losses through all stages of poultry manure management by type of manure produced, in France

Type of manure produced	Housing losses (% N excreted)	Storage losses (% N ex-house)	Losses at landspreading (% N ex-storage)	Available to crops (% N excreted)
Solid manure, indoor rearing on litter	30	15	10	54
Solid manure, indoor rearing on litter, composting	30	30	0	49
Solid manure, broiler, with free range	40	15	10	46
Solid manure, force-fed ducks and geese, with free range	50	15	10	38
Solid manure, broiler breeders	55	15	10	34
Slurry	50	20	20	32
Droppings, pre-dried, storage in shed	30	30	10	44
Droppings, dried	25	25	10	51
Droppings, deep pit	60	15	10	29

Source: [433, CORPEN 2006]

Another example is presented in Figure 3.5 to illustrate the relationship between emissions from storage and landspreading of broiler litter. It can be seen that effective storage (with sheeting), which preserves the content of available nitrogen in the manure, can lead to an increased overall emission if it is followed by poor spreading techniques (e.g. surface spreading without incorporation) [536, Sagoo et al. 2007].

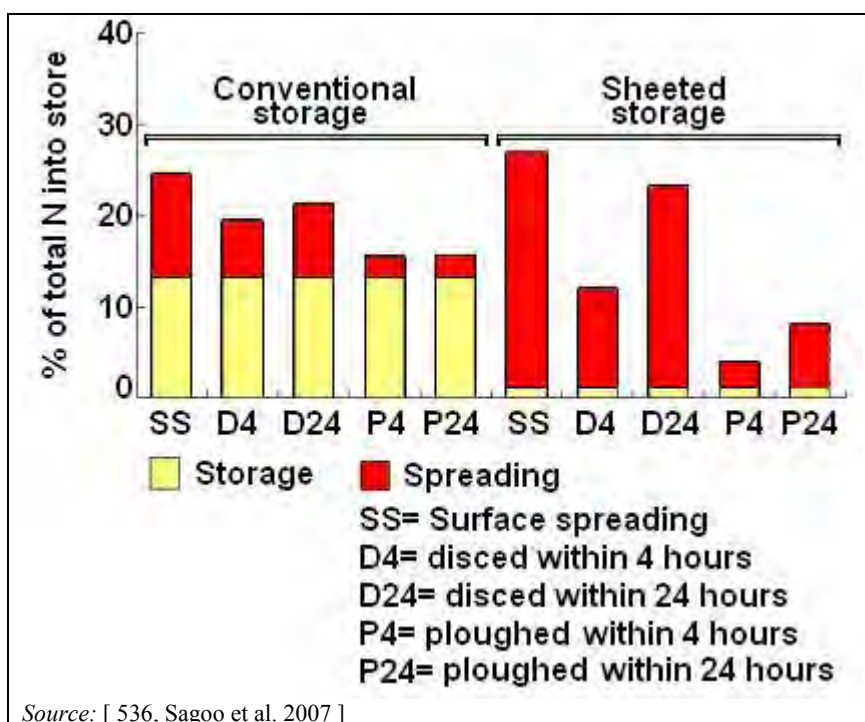

Figure 3.5: Cumulative ammonia volatilisation losses during storage and following landspreading of broiler litter

3.3.6.2 Emissions from the whole-farm process chain for the rearing of pigs

Reported examples of general emissions factors used by France at each stage of pig production for slurry management are presented in Table 3.77. Disaggregated emissions factors for ammonia emissions, for each stage in the production chain, have been reported by Spain for different pig categories; data are presented in Table 3.78.

Table 3.77: Nitrogen losses through all stages of pig manure management (without manure processing), in France

Parameter	Slurry		Solid manure (straw)	
	% N losses (as N-NH ₃) ⁽¹⁾	N content (g)	% N losses (as N-NH ₃ , N-N ₂ O and N-N ₂)	N content (g)
N excreted in housing	NR	1 000	NR	1 000
In-house losses (% N excreted)	25 (15–30)	250	24 (5–30) as N-NH ₃ 4 (2–12) as N-N ₂ O 29 (20–40) as N-N ₂	240 40 290
N available in outside storage (N ex-house)	NR	750	NR	510
Storage losses (% N ex-house)	5 (5–15)	38	10 (0–20) as N-NH ₃ ⁽²⁾	51 as N-NH ₃ ⁽²⁾
N available for landspreading (N ex-storage)	NR	712	NR	459
Spreading losses (% N ex-storage)	20 (10–50)	142	0	0
Usable N for crop ⁽³⁾	NR	570	NR	459
N losses from whole farm (% N excreted)	43	430	29 as N-NH ₃ 4 as N-N ₂ O 29 as N-N ₂	291 40 290

⁽¹⁾ N losses due to N₂O formation are considered low.

⁽²⁾ N losses in the form of N₂O and N₂ are not relevant during storage.

⁽³⁾ Average nutrient composition of slurry for landspreading N:P₂O₅:K₂O = 1.00:0.67:0.89. 70 % of nitrogen is considered to be ammoniacal.

NB: NR = not relevant; range of potential losses in brackets.

Source: [329, CORPEN 2003]

Table 3.78: Examples of ammonia emission factors used as a reference for housing, storage and landspreading of slurry in Spain

Type of pig	Housing stage	Storage stage	Landspreading stage	Total
	kg NH ₃ -N/place/year			
Weaners	0.417	0.150	0.369	0.936
Growers 20–49 kg	1.584	0.570	1.401	3.556
Finishers 50–79 kg	1.904	0.685	1.684	4.274
Finishers 80–109 kg	2.128	0.766	1.882	4.776
Finishers > 110 kg	1.988	0.716	1.758	4.462
Gestating sows	3.421	1.698	3.025	8.144
Farrowing sows	4.132	2.051	3.653	9.836
Gilts	2.088	1.036	1.846	4.971
Boars	2.763	1.371	2.443	6.577
Growers/finishers 20–100 kg	1.665	0.599	1.472	3.736

Source: [616, Spain 2012]

3.3.7 Noise

Noise originating from intensive farming units is a local environmental issue and has to be considered, particularly in those situations where units are located close to residential areas. On the farm, high noise levels can also affect the animals' condition and the production performance, and could potentially damage the hearing capacity of farm personnel. Equivalent continuous noise (L_{Aeq}) is the measure used to assess the noise levels of farms, since it makes it possible to compare noise sources of variable intensity or sources that are intermittent.

Typical farm levels have not been reported. The equivalent noise level that arises from a farm is a combination of the levels of the different activities listed in Table 3.79 and Table 3.80, together with a correction for the time duration. A different combination of activities will obviously lead to a different equivalent noise level. Background noise is noise which may be experienced in the environment, for example, around a poultry unit. It consists of road traffic, birdsong, aircraft, etc. and may also include existing noises in the poultry unit.

In order to account for all the variable intermittent noises, the background noise level (L_{a90}) is taken to be the noise level which is exceeded 90 % of the time over a period of measurement. Background noise varies over a 24-hour period as a result of changes in activities. In rural areas typical daytime background noise is 42 dB, but may fall below 30 dB in the early hours of the morning.

The final impact at sensitive receptors in the neighbourhood depends on many factors. For instance, land surface, reflecting or absorbing objects, construction of the receiving object and the number of noise sources determine the sound pressure level that is measured. In tables in the following sections, sound pressure levels have been given for only a few sources at the farm or very close to it. The noise level at a sensitive receptor is normally lower further away from the farm.

The data must be seen as reported examples of what has been measured. Total noise levels will vary depending on farm management, the number of animals and animal category, and the equipment used. In particular, sources of noise from poultry or pig units are associated with:

- livestock;
- housing;
- feed production and handling;
- equipment;
- manure management.

3.3.7.1 Sources and emissions on poultry farms

Typical sources of noise for a number of specific activities are shown in Table 3.79. Sound pressure levels are reported next to the source or at a short distance.

Table 3.79: Typical sources of noise and examples of noise levels in poultry units

Noise source	Duration	Frequency	Day/night activity	Sound pressure levels dB(A)	Equivalent continuous L_{Aeq} dB(A)
House ventilation fans	Continuous/intermittent	All year	Day and night	43	NI
Feed delivery	1 hour	2–3 times every week	Day	92 (at 5 metres)	NI
Mill mix unit: - inside building - outside building	NI	NI	NI	90 63	NI
Gas fuel delivery	2 hours	6–7 times per year	Day	NI	NI
Emergency generator	2 hours	Every week	Day	NI	NI
Catching chickens (broilers)	6 hours up to 56 hours	6–7 times per year	Morning/night	NI	57–60
Cleaning out (broilers)					
Manure handling	1 to 3 days	6–7 times per year	Day	NI	NI
Power washing, etc.	1 to 3 days	6–7 times per year	Day	88 (at 5 metres)	NI
Cleaning out (laying hens)					
Manure handling	Up to 6 days	Annually	Day	NI	NI
Power washing, etc.	1 to 3 days	NI	NI	88 (at 5 metres)	NI
NB: L_{Aeq} = equivalent continuous noise - unit for noise of variable intensity; NI = no information provided. Source: [393, ADAS 1999] [24, LNV 1994]					

3.3.7.2 Sources and emissions on pig farms

Typical sources of noise for a number of specific activities are shown in Table 3.80. Sound pressure levels are reported next to the source or at a short distance.

Table 3.80: Typical sources of noise and examples of noise levels in pig units

Description	Duration	Frequency	Day/night activity	Sound pressure levels dB(A)	Equivalent continuous L_{Aeq} dB(A)
Normal housing levels	Continuous	Continuous	Day	67	NI
Feeding animals: pigs sows	1 hour	Daily	Day	93 99	87 91
Feed preparation	3 hours	Daily	Day/night	90 (inside) 63 (outside)	85
Stock movement	2 hours	Daily	Day	90–110	NI
Feed delivery	2 hours	Weekly	Day	92	NI
Cleaning and manure handling	2 hours	Daily	Day	88 (85–100)	NI
Manure spreading	8 hours/day for 2–4 days	Seasonal/weekly	Day	95	NI
Ventilation fans	Continuous	Continuous	Day/night	43	NI
Fuel delivery	2 hours	Fortnightly	Day	82	NI
NB: L_{Aeq} = equivalent continuous noise - unit for noise of variable intensity; NI = no information provided. Source: [559, ADAS 1999] [24, LNV 1994]					

3.3.8 Solid waste from poultry and pig farms

The amounts and composition of waste that arise from poultry and pig farms vary considerably. No representative data for the categories identified in Section 2.11 have been reported for the sector.

3.3.9 Emissions of odour

Emissions of odour originate from the activities described in the previous sections such as animal housing, manure storage structures and manure landspreading. The contribution of the individual sources to the total odour emission from a farm varies and depends on many factors such as the general maintenance of the premises, the composition of the manure and the techniques used for handling and storage of the manure.

Odour is caused by the microbial degradation of organic substances (e.g. faeces, urine, and feedstuff) and is defined by human olfactory perception of a mixture of chemical compounds in the atmosphere also known as odorants. The odorant emissions released from animal housing facilities are a complex mixture of more than 150 components in different concentrations. Even if all chemical substances which lead to odour perception are known, odour perception cannot be determined based on the concentration of individual substances because odour is defined by a human physiological reaction [474, VDI 2011].

The most significant sources of odour (odorants) are [438, Lacey et al. 2004]:

- Volatile fatty acids (VFA): the VFA are an intermediate product in the anaerobic fermentation of biological wastes to methane (CH₄). When conditions are such that an incomplete fermentation occurs, then VFA can be volatilised to the atmosphere.
- Ammonia and volatile amines: these are the product of deamination and decarboxylation of amino acids. Deamination results in the production of VFA, carbon dioxide, hydrogen gas, and ammonia under neutral pH (from 6 to 7). For example, microbial breakdown of uric acid in broiler litter is a major source of ammonia.
- Indoles and phenols: these are the by-products of amino acids metabolised by a variety of intestinal anaerobes.
- Volatile sulphur-containing compounds: these are the by-product of anaerobic digestion of sulphates and sulphur-containing amino acids.

According to the latest knowledge of the composition of odour, odour appears to be dominated by sulphuric compounds, especially at neutral pH and below; in this range ammonia volatilisation is not likely to occur [500, IRPP TWG, 2011].

Ammonia and hydrogen sulphide should not be taken alone as an indication of the odour emission and/or of the odour nuisance. Ammonia, due to its high perception threshold, contributes to the odours emitted by the livestock buildings, but odours may persist even in the total absence of ammonia [257, France 2010]. A clear correlation between odour concentration and ammonia emissions does not exist [486, Pelletier et al. 2005]. In general, measures to abate ammonia and dust emissions also contribute to a reduction in odorant emissions but the reduction ratio can be different. Conversely, techniques that are applied to abate odours generally have only a residual effect on other emissions.

Data from Denmark show that, in an integrated production unit with a capacity of approximately 100 sows plus fattening pigs, odour emissions from fattening pigs' facilities account for more than two thirds (68–75 %) of the entire odour emission of an integrated production unit. The total odour emission during summer will be 22 900 ou_E/s where the farrowing crates for farrowing sows and the pens for fattening pigs have fully slatted floors. However, if both the farrowing crates for farrowing sows and the pens for finishers have partly slatted floors, the total odour emission will be reduced by 28 %, which corresponds to 16 600 ou_E/s [645, Denmark 2005].

In the UK, commercial-scale studies have been carried out on four broiler houses, by measuring the odour concentration from flocks of approximately 34 000 birds, fed with different protein level diets. In particular, male broilers received *ad libitum* diets with target protein levels (based on lysine content) of 85 %, 90 %, 100 % or 110 % of the normal commercial level. Odour concentrations were fairly consistent between houses, falling in the range of 600–800 ou_E/s per m³ around day 16, and 1 300–2 300 ou_E/s per m³ around day 30, corresponding to odour emissions in the range of 20 000–33 000 ou_E/s [149, Robertson et al. 2002].

Table 3.81 shows odour emission factors in use in the Netherlands, Germany and Denmark. The factors for the Netherlands and Germany cover yearly average conditions, while for Denmark measurements were carried out in the summer period.

Table 3.81: Odour emission factors for different animal categories and housing systems in the Netherlands, Germany and Denmark

Type of animal rearing	Odour emission factors (ou _E /s per animal)		
	NL	DE ⁽¹⁾	DK ⁽²⁾ ⁽³⁾
Pig farms			
Gestating sows kept in individual crates	19	6.6	16 (7–39)
Gestating sows kept loose	19	NI	16 (7–39)
Farrowing sows and piglets kept in crates with partly slatted floor	28	10	72 (40–125)
Farrowing sows and piglets kept in crates with fully slatted floor	28	10	100 (56–280)
Weaners kept in pens with partly slatted floor	8	3	7 (4–14)
Weaners kept in pens with fully slatted floor	8	3	7 (4–14)
Finishers kept in pens with partly slatted floor	23	6.5	19 (8–48)
Finishers kept in pens with fully slatted floor	23	6.5	29 (13–78)
Finishers in deep litter	NI	4	NI
Poultry farms			
Layers in a floor system	0.35	0.142 8	1.53
Layers in cages (colonies), aerated manure belt	0.34	0.102	0.68
Layers in cages (colonies), manure belt, no aeration	NI	0.102	NI
Layers in aviary system, aerated belt	0.34	0.102	NI
Layers in aviary system, manure belt, no aeration	0.34	0.102	NI
Broilers on deep litter	0.24	0.12	0.4
Female turkeys on solid littered floor	NI	0.4	NI
Male turkeys on solid littered floor	NI	0.71	NI
Ducks on solid littered floor	NI	0.29	NI
⁽¹⁾ Factors are calculated from original figures given in ou _E /s/LU and the following weight factors for live animal mass: gestating sows: 150 kg, farrowing sows: 250 kg, weaners: 20 kg, finishers: 65 kg, layers: 1.7 kg, broilers: 1 kg, female turkeys: 6.25 kg, male turkeys: 11.1 kg, Pekin ducks: 1.9 kg. ⁽²⁾ The ranges for pigs correspond to 5th percentiles to 95th percentiles. Emissions were calculated from measurements in summer. ⁽³⁾ Odour emission factors for poultry are calculated from original figures given in ou _E /s/1 000 kg and the following weight factors per animal: layers: 1.7 kg, broilers: 1 kg. NB: NI = no information provided. Source: [445, VERA 2011] [645, Denmark 2005] [474, VDI 2011]			

Odour emission factors used in Germany for uncovered manure stores are 3 ou_E/s per m² for pig slurry stores, 3 ou_E/s per m² for solid manure store with litter and 7 ou_E/s per m² for solid manure without litter [474, VDI 2011].

4 TECHNIQUES TO CONSIDER IN THE DETERMINATION OF BAT

This chapter describes techniques (or combinations thereof), and associated monitoring, considered to have the potential for achieving a high level of environmental protection in the activities within the scope of this document. The techniques described will include both the technology used and the way in which the farms are designed, built, maintained, operated and decommissioned.

It covers environmental management systems, process-integrated techniques and end-of-pipe measures. Waste prevention and management, including waste minimisation and recycling procedures are also considered, as well as techniques that reduce the consumption of raw materials, water and energy by optimising use and reuse. The techniques described also cover measures used to prevent or to limit the environmental consequences of accidents and incidents, as well as farm remediation measures. They also cover measures taken to prevent or reduce emissions under other than normal operating conditions (such as start-up and shutdown operations, leaks, malfunctions, momentary stoppages and the definitive cessation of operations).

Annex III to the Directive lists a number of criteria for determining BAT, and the information within this chapter will address these considerations. As far as possible, the standard structure in Table 4.1 is used to outline the information on each technique, to enable a comparison of techniques and the assessment against the definition of BAT in the Directive.

This chapter does not necessarily provide an exhaustive list of techniques which could be applied in the sector. Other techniques may exist, or may be developed, which could be considered in the determination of BAT for an individual farm.

Table 4.1: Information for each technique

Heading within the sections
Description
Achieved environmental benefits
Cross-media effects
Environmental performance and operational data
Technical considerations relevant to applicability
Economics
Driving force for implementation
Example plants
Reference literature

In this chapter, the characteristics listed in the previous table are described to provide all elements that are used for the evaluation of techniques, which is carried out to conclude if the techniques presented here are BAT or not.

As described in Chapters 1 to 3, the main emphasis in the application of environmental measures in intensive farming is on the reduction of emissions associated with manure production. Techniques that can be applied at different stages of the process are linked. It is clear that the application of reduction measures in the early steps of the animal production chain can influence the effect (and efficiency) of any reduction measures applied in later steps. For example, the nutritional composition of the feed and the feeding strategy are important for the

animals' performance, but at the same time they affect the manure composition, and therefore influence emissions to air, soil and water from housing, storage and landspreading. The IED puts the emphasis on prevention; hence this chapter also discusses the effects of nutritional management, followed by integrated or end-of-pipe techniques.

It is important to note that the performance of a reduction technique is closely linked with the way in which it is operated, and simply applying a reduction measure may not accomplish the highest achievable reduction. This chapter therefore begins with a description of the elements of good practice for environmental management, before paying more specific attention to technical measures for emissions reduction.

This chapter provides information from techniques that are already being implemented on farms, including information on associated costs and the context in which the techniques can be used effectively.

This chapter contains data on excretion and emission levels from specific farms. The quality of data is usually indicated, according to the following descriptions:

- Derived from measurements: excretion or emission level derived as an average (or with conversion units) of measurements carried out in animal houses.
- Measured data: emission level measured on farm.
- Modelled value: excretion or emission level modelled using a modelling tool, e.g. a nitrogen mass balance.
- Conclusion by analogy: emission level derived by analogy with a similar or different housing system.

4.1 Good agricultural practice for environmental management

All organisational activities, products and services interact with and affect the environment and are linked to the health, welfare and safety of both the farmer and the animals, and to all the farm operational and quality management systems. Good farming management means aiming for a sound environmental performance, which has been shown to be closely linked to increased animal productivity.

The key to good practice is to consider how activities on pig or poultry farms can affect the environment and then to take steps to avoid or minimise emissions or impacts by selecting the best mix of techniques and opportunities for each site. The aim is to put environmental considerations firmly into the decision-making process. Managers should be able to provide evidence that a system is in place to take account of these issues, many of which are referred to in 'Codes of Good Practice' developed by many Member States. Such action is consistent with many of the steps taken by some businesses aiming for formal accreditation under a recognised Environmental Management System.

Each of the various activities that make up farm management can potentially contribute to the overall achievement of good environmental performance. It is therefore important that someone be identified and given the responsibility to manage and oversee these activities. In larger enterprises in particular, that someone may not necessarily be the owner, but a farm manager, who has to make sure that:

- site selection and spatial aspects are considered;
- education and training exercises are identified and implemented;
- activities are properly planned;
- inputs and outputs are monitored;
- emergency procedures are in place; and
- a repair and maintenance programme is implemented.

The manager and staff should regularly review and evaluate these activities, so that any further development and improvements can be identified and implemented.

Site selection and spatial aspects

Often the environmental impact of farms is partly due to an unfavourable spatial arrangement of activities on the farm site. This can lead to unnecessary transport and additional activities, and to emissions close to sensitive receptors. Good farming management can compensate for this to a limited extent, but is made easier if attention is paid to spatial planning of farm activities. The evaluation and selection of a location for a new livestock farming facility, or the planning of a new farm on an existing site, can be considered part of good farming practice, if the following conditions are met:

- Unnecessary transport and additional activities are minimised or eliminated.
- Adequate distances are ensured between the house/farm and the sensitive receptors requiring protection, e.g. from neighbours to avoid conflicts arising from odour and noise nuisance, or from waters to protect them from the emission of nutrients. Requirements regarding the minimum standard distances vary by country, depending also on the type of sensitive receptor. Dispersion modelling can also be performed to predict/simulate odour concentration in surrounding areas.
- Prevailing climatic conditions (e.g. wind) as well as any specific topographical features, such as hills, ridges and rivers are considered.

- The potential future development capability of the farm is taken into consideration.
- Any requirements of outline construction planning or village development planning are satisfied.
- The contamination of water is prevented.

Air pollution can be avoided at sensitive sites by effectively arranging, relocating, or grouping emission sources, such as in the case with the main air ducts that collect all the exhaust air from all subdivisions of sheds. For example, it may be possible to increase the distances of the emission source to any critical sensitive sites, or to relocate the sources so that they lie in a non-prevailing wind direction. For example, low emission generation areas could be located closer to sensitive receptors whilst farms/houses producing higher emissions could be located further away from those same locations.

Ensuring adequate distances between the farm/house and the sensitive receptors may not be generally applicable to existing farms/houses.

Education and training

Farm staff should be familiar with production systems and properly trained to carry out the tasks for which they are responsible. They should be able to relate these tasks and responsibilities to the work and responsibilities of other staff. This can lead to a greater understanding of the impacts on the environment and the consequences of any equipment malfunction or failure. However, staff may require extra training to monitor these consequences. Regular training and updating may be required, particularly when new or revised working practices or equipment are introduced. The development of a training record could provide the basis for a regular review and evaluation of each person's skills and competencies. Particular attention should also be paid so that the staff is aware of the relevant regulations concerning animal health and welfare, as well as worker safety.

Special training may be required for operating and maintaining techniques applied for reducing emissions, above all for the more sophisticated ones such as end-of-pipe techniques for the reduction of emissions to air and techniques for the on-farm processing of manure.

Awareness of regulations and good operating practices concerning manure management, planning for manure application, emergency planning and management, repair and maintenance, etc. should be part of the training of people responsible for transport and/or the spreading of manure in order to prevent emissions to air and water. As an example of the required training, some of these aspects are described below:

- The rate of landspreading should follow a well-documented manure management plan, and it should be done evenly on the field. The operator should be familiar with the adjustment of speed, dosing and the capacity of the machinery.
- Slurry can vary widely in chemical composition in different parts of the manure store. The operator should be familiar with possibilities for homogenising the manure before loading and how to use quick test methods for assessing the amount of plant nutrients in the manure.
- Accidental spills happen, mainly in connection with loading, transport or landspreading of slurry or other liquid manure. The operator should be able to take precautions, be familiar with alarm systems and safety procedures to avoid spills, as well as be prepared to take the right actions in case of spills.
- Manure landspreading and transport can be regulated according to the time of year and week, temperature/climate, field slope, buffer zones, etc. The operator should be aware of these regulations.
- Any legal requirements regarding landspreading technology should be familiar to the operator.

Planning activities

Many activities can benefit from planning, to ensure that they run smoothly and carry reduced risks of unnecessary emissions. An example would be manure landspreading. Other activities that will benefit from a planned approach include the delivery of fuel, feed and other materials to the farm (inputs) and the removal of pigs, poultry, eggs, other products, manure and waste materials from the farm (outputs). Subcontractors and suppliers also need to be properly briefed.

Emergency planning and management

An emergency plan can help the farmer to deal with unplanned emissions and incidents such as the pollution of water, if they occur. In the UK, an emergency plan is required under the Code of Good Agricultural Practice for farmers, and land managers. This may also cover any fire risks and the possibility of vandalism. The emergency plan can include:

- a plan of the farm showing the drainage systems and water sources;
- details of equipment available on the farm, or available at short notice, which can be used to deal with a pollution problem (e.g. equipment for plugging land drains, damming ditches, or scum boards for holding oil spillages);
- telephone numbers of the emergency services, regulator(s) and others, such as downstream landowners and water abstractors;
- plans of action for certain potential events, such as fires, leaking slurry stores, collapsing slurry stores, disease outbreak, uncontrolled run-off from manure heaps, and oil spillages;
- installation of standby electricity generators for emergency power to supply the ventilation during a power surge.

It is important to review procedures after any incident to see what lessons can be learnt and what improvements can be implemented.

Repair and maintenance

It is necessary to check structures and equipment to ensure that they are in good working order. Identifying and implementing a structured programme for this work will reduce the likelihood of problems arising. Instruction books and manuals should be made available and staff should receive appropriate training.

All measures that contribute to the cleanliness of the farm help to achieve a reduction of emissions. These include drying and cleaning the feed store, the housing facilities (defecating, feeding and lying areas in pig housing) and equipment, and the outlying areas around the housing (see Section 4.17 for dust emissions).

Livestock buildings may have insulation and mechanisms which require regular cleaning, checking, filling and maintenance, for example of fans, cowls, air inlets/outlets, regulating flaps, manure belts, filters, temperature sensors, electronic controls, fail-safe arrangements, water supply and feed supply arrangements, pest management, apparatuses under pressure, air cleaning systems, fuel and chemical stores.

Slurry stores could be checked regularly for any signs of corrosion or leakage, and any faults need to be corrected, with professional help if necessary. Stores should preferably be emptied at least once a year, or as frequently as justifiable, depending on the quality of the construction and the sensitivity of the soil and groundwater, so that both internal and external surfaces can be checked and any structural problems, damage or degradation put right.

The operation of manure spreaders (for both solid and liquid manures) can be improved if they are cleaned and checked after periods of use and any repairs or refurbishment are carried out. Regular checks should be made during operational periods and appropriate maintenance carried out as described in the manufacturers' instructions. Slurry pumps, mixers, separators, irrigators

and control equipment will require regular attention and manufacturers' instructions should be followed.

It is sensible to have a supply of the faster wearing parts available on farm, in order to carry out repairs and maintenance quickly. Usually, routine maintenance can be carried out by suitably trained farm staff, but more difficult or specialist work will be carried out more accurately by experts.

Feed storage

No particular techniques have been reported for a reduction of emissions to air from feed storage on farms. In general, dry matter storage facilities can cause dust emissions, but regular inspection and maintenance of the silos and the transport facilities, such as valves and tubes, can prevent this. Blowing dry feed into closed silos minimises dust problems.

When it is considered necessary, silos should be completely emptied to allow inspection and to prevent any biological activity building up in the feed. This is particularly important in summer, to prevent deterioration of the feed quality and development of odorous compounds. When feed bins are emptied, care should be taken not to increase dust emissions.

4.1.1 Storage and disposal of dead animals

Description

Common practices related to the handling and storage and disposal of dead animals in order to prevent or reduce emissions have been described in Section 2.12. For the disposal of dead animals, waste incineration and co-incineration are indicated among the authorised procedures. In particular, two distinct pathways exist:

a. Diversion of dead animals from farms to a centralised, large animal waste incinerator

Specialised services are commonly used to collect dead animals from farms and to process them in centralised treatment facilities. Large centralised incineration facilities, treating different types of waste, fall under a regulatory framework and are designed to meet the provisions set out in the Industrial Emissions Directive (2010/75/EU), Chapter IV and Annex VI, or equivalent requirements. Plants incinerating only dead animals are regulated by the Animal By-Products Regulation ((EC) 1069/2009). The European Reference Documents reporting the Best Available Techniques for these activities are the BAT Reference Document on Slaughterhouses and Animals By-products Industries [581, COM 2005].

Good housekeeping practices are essential to ensure hygienic on-farm storage of the dead animals which are not going to be incinerated on farm. In anticipation of collection by an authorised waste collector, fallen stock should be stored in closed, leakproof containers to avoid spillage or odour problems. Refrigeration may be necessary, especially in hot climates, when the removal frequency is not regular (e.g. more than weekly) [624, IRPP TWG 2013].

b. On-farm incineration in a dedicated incinerator

Incinerators which incinerate only dead animals such as on-farm incinerators for the disposal of fallen stock are exempted from Chapter IV of Directive 2010/75/EU and are instead regulated by Regulations (EC) 1069/2009 and 142/2011. Incinerators must be approved in accordance with Article 24 of Regulation (EC) 1069/2009 and must comply with Article 6 of and Annex III to Regulation (EC) 142/2011 (i.e. hygiene conditions, operating conditions, residue disposal requirements, temperature measurement requirements, requirements for dealing with abnormal operating conditions, water discharge requirements, storage of animal by-products that are awaiting incineration and storage of ashes).

Commission Regulation (EU) 142/2011 of 25 February 2011 lays down general and specific operating conditions for incineration and co-incineration plants treating only animal by-products and derived products, for two different capacity thresholds: more than 50 kg per hour or per

batch (high-capacity incinerators or co-incinerators) and at or less than 50 kg per hour or per batch (low-capacity incinerators or co-incinerators).

Achieved environmental benefits

The biosecurity risk for contamination of humans or animals and the risk of environmental pollution are minimised by the appropriate storage and disposal of dead animals.

Cross-media effects

If refrigeration is applied during storage on farm, energy consumption is increased substantially. Small-scale incinerators fitted with afterburners produce more emissions of oxides of nitrogen than incinerators without afterburners, because of the higher heat input into the incinerator from the afterburner.

Environmental performance and operational data

a. Diversion of dead animals from farms to a centralised, large animal waste incinerator

Large, centralised incinerators allow better control than small-scale incinerators, concerning issues related to the reduction and supervision of emissions to air. On the other hand, the impact on the spread of a disease from farm to farm by collecting and delivering dead animals off-farm at a larger centralised plant is difficult to evaluate.

b. On-farm incineration in a dedicated incinerator

Emissions from small-scale on-farm incinerators have been reported for different types of fuel, and for operating conditions with or without an afterburner. Typical emissions from combustion are dust, SO_x, NO_x, CO₂ and CO.

Carbon dioxide emissions are primarily governed by the carbon content of the fuel burnt and the wastes incinerated. The combustion efficiency is an important additional factor, which determines the full oxidation of carbon to CO₂. The use of afterburners is essential to minimise emissions of VOCs and CO and may even reduce particulate matter; however, it should be noted that even small-scale incinerators equipped with an afterburner but poorly operated and/or maintained (e.g. overloaded) can give rise to much greater emissions of most pollutants than a simpler design not equipped with an afterburner but with a carefully operated system [476, AEAT 2002].

Poor loading of incinerators is considered to be a major problem causing inefficient combustion and increased emissions. Where possible, the furnace should be preheated to at least 850 °C before feedstock is loaded to prevent smouldering at lower temperatures. If the dead animals are loaded into a relatively cool furnace, there will be a period of pyrolysis followed by poor combustion.

When an afterburner is in place, it should be activated well before the main combustion chamber burner is lit so that it is functioning at an optimum temperature. Indeed operation of the main burners should be interlocked with the afterburner chamber temperature. This would help to minimise emissions during the warm-up of the main combustion chamber. The burner and afterburner should both be switched on for the full combustion cycle to ensure minimum pollutant emissions [476, AEAT 2002].

Sulphur dioxide emissions are directly proportional to the sulphur content of the fuel used and waste incinerated. Refined gaseous fuels have negligible quantities of sulphur compounds and consequently the sulphur emissions are due to sulphur in the animal remains. Examples of average emissions in concentration and per operating cycle are presented in Table 4.2 and Table 4.3.

Table 4.2: Examples of emission concentrations in flue-gases from small-scale on-farm incinerators

		Incinerators with afterburners			Incinerators without afterburners		
Unit		Poultry	Poultry	Pigs	Poultry	Pigs	Pigs
Type of animal		Propane	Propane	Diesel	Kerosene	Gas oil	Oil
Fuel		Propane	Propane	Diesel	Kerosene	Gas oil	Oil
Dust ⁽¹⁾	mg/Nm ³	58	90	36	107	173	277
SO ₂	mg/Nm ³	179	34	376	456	127	313
HCl	mg/Nm ³	58	8	24	112	26	56
CO	mg/Nm ³	1 030	1 620	1 650	348	1 180	5 840
NO _x ⁽²⁾	mg/Nm ³	381	303	376	225	129	352
VOCs ⁽³⁾	mg/Nm ³	61	484	117	869	78	3 490
Dioxins and furans ⁽⁴⁾	ng I-TEQ/Nm ³	0.19	0.1	0.1	0.08	0.21	0.05
CO ₂	%	7.2	6.9	7.6	7.7	7.5	9

⁽¹⁾ Dust as total particulate matter.
⁽²⁾ NO_x as NO₂.
⁽³⁾ VOCs as total organic carbon.
⁽⁴⁾ I-TEQ = international toxic equivalent.

NB: Mass concentrations are standardised at 11 % O₂, dry gas, temperature 273.15 K, pressure 101.3 kPa.
Source: [476, AEAT 2002]

Table 4.3: Examples of total emissions per operating cycle from small-scale on-farm incinerators

		Incinerators with afterburners			Incinerators without afterburners		
Unit		Poultry	Poultry	Pig	Poultry	Pig	Pig
Type of animal		Propane	Propane	Diesel	Kerosene	Gas oil	Oil
Fuel		Propane	Propane	Diesel	Kerosene	Gas oil	Oil
Dust ⁽¹⁾	kg/cycle	0.06	0.08	0.08	0.25	0.79	0.3
SO ₂	kg/cycle	0.19	0.03	0.88	1.1	0.64	0.31
HCl	kg/cycle	0.06	0.01	0.06	0.26	0.12	0.06
CO	kg/cycle	1.1	1.4	3.9	0.84	5.3	6.3
NO _x	kg/cycle	0.41	0.27	0.88	0.51	0.58	0.38
VOCs ⁽²⁾	kg/cycle	0.07	0.43	0.27	1.8	0.35	3.8
Dioxins and furans	ng I-TEQ/cycle	190	90	220	210	910	50
CO ₂	kg/cycle	106	246	367	200	505	302

NB: See footnotes in Table 4.2.
Source: [476, AEAT 2002]

Technical considerations relevant to applicability

The storage of dead animals at appropriate temperatures is generally applicable. The storage time depends on the weather conditions and the frequency of removal.

Economics, driving force for implementation: no information provided.

Example plants

In Belgium (Flanders), fallen stock with a smaller size such as poultry or piglets can be stored in closed, airtight containers while dead animals of a medium size such as pigs can be stored on a surface that is easy to clean and disinfect, covered appropriately with a durable and easily maintainable material without permitting access to insects and animals [631, Belgium-Flanders 2013].

Reference literature

[476, AEAT 2002] [581, COM 2005] [624, IRPP TWG 2013] [631, Belgium-Flanders 2013]

4.2 Environmental management systems

Description

A formal system to demonstrate compliance with environmental objectives.

The Directive defines ‘techniques’ (under the definition of ‘best available techniques’) as ‘both the technology used and the way in which the installation is designed, built, maintained, operated and decommissioned’.

In this respect, an environmental management system (EMS) is a technique allowing operators of installations to address environmental issues in a systematic and demonstrable way. EMSs are most effective and efficient where they form an inherent part of the overall management and operation of an installation.

An EMS focuses the attention of the operator on the environmental performance of the installation; in particular through the application of clear operating procedures for both normal and other than normal operating conditions, and by setting out the associated lines of responsibility.

All effective EMSs incorporate the concept of continuous improvement, meaning that environmental management is an ongoing process, not one project which eventually comes to an end. There are various process designs, but most EMSs are based on the plan-do-check-act cycle (which is widely used in other company management contexts). The cycle is an iterative dynamic model, where the completion of one cycle flows into the beginning of the next (see Figure 4.1).

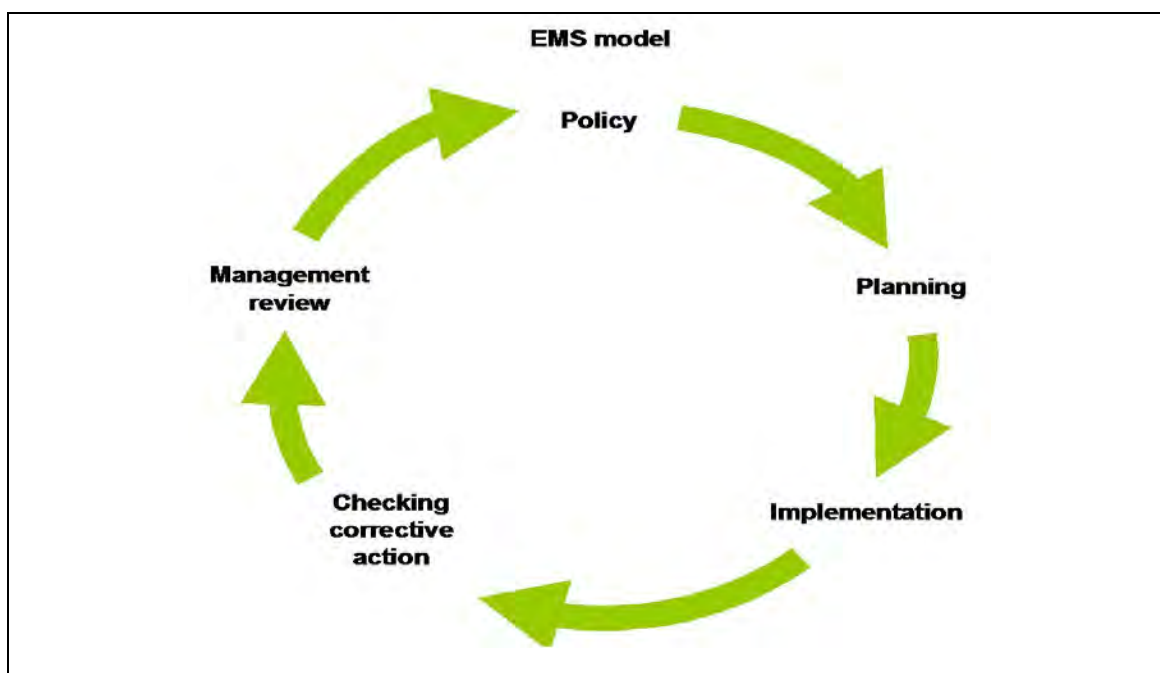

Figure 4.1: Continuous improvement in an EMS model

An EMS can take the form of a standardised or non-standardised (‘customised’) system. Implementation and adherence to an internationally accepted standardised system, such as EN ISO 14001:2015, can give higher credibility to the EMS especially when subjected to a properly performed external verification. EMAS provides additional credibility due to the interaction with the public through the environmental statement and the mechanism to ensure compliance with the applicable environmental legislation. However, non-standardised systems can, in principle, be equally effective provided that they are properly designed and implemented.

While both standardised systems (EN ISO 14001:2015 or EMAS) and non-standardised systems apply in principle to organisations, this document takes a narrower approach, not including all activities of an organisation, e.g. with regard to their products and services, due to the fact that the Directive only regulates installations/plants.

An EMS can contain the following components:

1. commitment of management, including senior management;
2. definition, by the management, of an environmental policy that includes the continuous improvement of the environmental performance of the installation;
3. planning and establishing the necessary procedures, objectives and targets, in conjunction with financial planning and investment;
4. implementation of procedures paying particular attention to:
 - a) structure and responsibility,
 - b) training, awareness and competence,
 - c) communication,
 - d) employee involvement,
 - e) documentation,
 - f) effective process control,
 - g) maintenance programmes,
 - h) emergency preparedness and response,
 - i) safeguarding compliance with environmental legislation;
5. checking performance and taking corrective action paying particular attention to:
 - a) monitoring and measurement (see also the JRC Reference Report on Monitoring of emissions from IED installations - ROM) [576, COM 2017],
 - b) corrective and preventive action,
 - c) maintenance of records,
 - d) independent (where practicable) internal or external auditing in order to determine whether or not the EMS conforms to planned arrangements and has been properly implemented and maintained;
6. review of the EMS and its continuing suitability, adequacy and effectiveness by senior management;
7. following the development of cleaner technologies;
8. consideration for the environmental impacts from the eventual decommissioning of the installation at the stage of designing a new plant, and throughout its operating life;
9. application of sectoral benchmarking (e.g. EMAS Sectoral Reference Document) on a regular basis.

Specifically for the intensive poultry or pig rearing sector, the following features are part of the EMS in some cases:

10. noise management plan (see Section 4.14);
11. odour management plan (see Section 4.10.1.5).

Achieved environmental benefits

An EMS promotes and supports the continuous improvement of the environmental performance of the installation. If the installation already has a good overall environmental performance, an EMS helps the operator to maintain the high performance level.

Environmental performance and operational data

Farms can vary in scale and complexity, from a single building performing one task only (e.g. rearing broilers or finishing pigs) where all materials, such as feed, are purchased ready from the

manufacturer and employing one person, to large farms with multiple activities and several employees.

Depending on the level of complexity of the farm, the implementation of an environmental management system may vary significantly, from the basic control of the rearing process and the performance of the farm in terms of consumption (i.e. feed, energy, water) and production (e.g. live weight of animals, quantity of manure, other waste), to a full implementation with recording of several operating parameters, monitoring of emissions, validation by an external EMS verifier.

Cross-media effects

None reported. The systematic analysis of the initial environmental impacts and scope for improvements in the context of the EMS sets the basis for assessing the best solutions for all environmental media.

Technical considerations relevant to applicability

The components described above can be applied in full or in part to all installations within the scope of this document. The scope (e.g. level of detail) and nature of the EMS (e.g. standardised or non-standardised) will be related to the nature, scale and complexity of the farm, and the range of environmental impacts it may have.

Economics

It is difficult to determine accurately the costs and economic benefits of introducing and maintaining a good EMS. There are also economic benefits that are the result of using an EMS and these vary widely from sector to sector.

External costs relating to verification of the system can be estimated from guidance issued by the International Accreditation Forum [577, IAF 2010].

Driving forces for implementation

The driving forces for the implementation of an EMS include:

- improved environmental performance;
- improved insight into the environmental aspects of the company which can be used to fulfil the environmental requirements of customers, regulatory authorities, banks, insurance companies or other stakeholders (e.g. people living or working in the vicinity of the installation);
- improved basis for decision-making;
- improved motivation of personnel (e.g. managers can have confidence that environmental impacts are controlled and employees can feel that they are working for an environmentally responsible company);
- additional opportunities for operational cost reduction and product quality improvement
- improved company image;
- reduced liability, insurance and non-compliance costs.

Example plants

No example farms applying ISO 14001 audited EMSs have been reported. Some MS implement an EMS as part of permitting and audit compliance as part of their inspection regime (UK).

Reference literature

[576, COM 2017] [577, IAF 2010] [579, Reg. 1221/2009] [578, DG Environment 2010] [580, CEN 2015]

4.3 Nutritional management

Reducing the excretion of nutrients (e.g. N, P) in manure can reduce emissions, e.g. decreasing the amount of N in manure will not only abate ammonia emissions but also other potential N losses (leaching, denitrification). Nutritional management covers all techniques to achieve this reduction. The aim is to meet the animals' nutritional needs without causing a negative impact on animal health and welfare and taking into account the economics of the production process.

A goal of nutritionists is to ensure that animals are not fed with more nutrients (in particular N and P) than required for the target level of production, with the intention to minimise excretion to levels that cannot be avoided due to metabolic activity. In other words, nutritional measures aim to reduce the amount of nitrogen waste from undigested or catabolised nitrogen, which is mainly excreted in the form of urea (uric acid in poultry manure) and is rapidly degraded to ammonia and ammonium. Moreover, reducing N excretion is effective for emission abatement at all stages of manure management (housing, storage, landspreading).

In practice, protein levels in animal feed are often higher than actually required. Safety margins in the protein content of the diet are used to account for:

- suboptimal amino acid ratios;
- variations in requirements between animals with different genotypes;
- variations in requirements caused by differences in age or production stages;
- variations in the actual content and digestibility of essential amino acids in the diet.

Therefore, the protein content of the diet and the resulting N excretion can be reduced by matching the protein/amino acids content of the diet as closely as possible to the animal's requirements [508, TFRN 2014].

Efforts over time in increasing feed digestibility have led to the use of large quantities of enzymes (phytase, xylanase, protease, glucanase, etc.) nowadays in the animal feed industry. Progress in genetics and nutrition has also led to a considerable improvement in the efficient use of feed. The improved utilisation of feed allows the reduction of the feed nitrogen input and hence N excretion even further.

4.3.1 Nutritional measures

Description

The main nutritional strategies to decrease the amount of nitrogen and phosphorus excreted are as follows:

1. Reduce the crude protein content by using a N-balanced diet based on net energy for pigs and on metabolisable energy systems for poultry, and digestible amino acids [506, TWG ILF BREF 2001] [30, Spain 2001] [281, France 2010] [624, IRPP TWG 2013].

In order for the animals to realise their growth potential and achieve the best levels of performance through maximum rates of protein synthesis, the proper amount of essential amino acids are supplied, avoiding both excesses and deficiencies. Diets that are not properly balanced with the animal's requirements in terms of energy and digestible amino acids provide the necessary quantities of the limiting nutrients only with overdoses of others, hence resulting in an increase of excreted nutrients that brings about higher emissions to the environment.

2. Multiphase feeding with a diet formulation of a diet adapted to the specific requirements of the production period (nitrogen and phosphorus).

Animals' requirements change over the growing/production periods. Consequently, adjusting better the composition of the diet to the requirements of the individual animal, e.g. according to age and weight of animals, is a general method to decrease the amount of nutrients excreted by animals (multiphase feeding).

3. Improvement of the feed characteristics, e.g. through the following methods:
 - application of low crude protein (CP) levels, use of synthetic amino acids and related compounds in low CP-amino acid supplemented diets (nitrogen);
 - application of low phosphorus levels, use of phytase to increase digestibility and/or digestible inorganic feed phosphates (phosphorus);
 - use of other authorised feed additives, including zotechnical additives, which have a favourable effect on the environmental consequences of animal production (nitrogen);
 - increased use of highly digestible raw materials (nitrogen and phosphorus).

Among the strategies presented above, the multiphase feeding and the use of diet formulations with reduced CP and phosphorus contents are described in Section 4.3.2 and Section 4.3.3, respectively. Techniques to reduce the phosphate levels in the manure by increasing phosphorus digestibility are described in Sections 4.3.4 and 4.3.5. The application of other additives to animal feed, which is another technique that can be implemented in order to reduce excretion of nutrients and/or ammonia emissions, (e.g. authorised acidifying salts to reduce the pH of urine or enzymes to improve the digestibility of feed) is described in Section 4.3.6.

Achieved environmental benefits

Considerable reductions in the N and P excreted can be achieved by limiting excess nutrient intake and/or improving the nutrient utilisation efficiency of the animal. A reduction in excretion allows a reduction in emissions from pig or poultry rearing, which eventually improves all further steps of the production chain, resulting in environmental advantages in all downstream operations.

Cross-media effects

Nutritional management is the most important preventive measure to reduce the pollution load in farms. No environmental cross-media effect is reported.

Environmental performance and operational data

Across the European agricultural regions, there are many differences in farm practices, species used and nutritional management; hence standard production conditions can vary considerably. Examples of reported standard levels of excretion of nitrogen (N) and diphosphorus pentoxide (P_2O_5) are displayed in Table 4.4. These values refer to a baseline situation in which no nutritional measures are applied.

Table 4.4: Standard levels of nitrogen (N) and diphosphorus pentoxide (P₂O₅) excretion in Germany, Finland and France

Animal categories	N (kg/animal place/year)			P ₂ O ₅ (kg/animal place/year)		
	DE	FI	FR (¹) (²)	DE	FI	FR (¹) (²)
Pigs						
Weaners	4.3	NI	4.03	2.3	NI	2.02
Growers/Finishers	13.0	NI	13.7	6.3	NI	6.30
Boars and sows	27–36	20.3–29.3	24.6	14–19	16.7	14
Poultry						
Laying hens	0.74	0.61	NI	0.41	0.37	NI
Broilers	0.29	0.31	NI	0.16	0.21	NI
Turkeys	1.64	1.19	NI	0.52	0.62	NI
⁽¹⁾ Annual data were calculated for the typical number of production cycles per year, equivalent to 6.5 for weaners and 3 for fattening pigs. ⁽²⁾ Annual data were calculated for the typical number of production cycles per year, equivalent to 6.15 for standard broilers and 2.6 for medium-size turkeys. NB: NI = no information provided. Source: [414, Fefana 2001] [323, Finland 2010] [329, CORPEN 2003]						

In comparison with the standard levels reported in Table 4.4, reduced levels of excreted nitrogen and/or phosphorus achieved by applying nutritional measures are reported, from a minimum of 4 % to > 30 %, depending on the type of technique applied and the animal category. Examples of reduction levels of excretion associated with specific nutritional techniques are given in other parts of Section 4.3. As an example, a comparison of excreted nitrogen, phosphorus and potassium levels for a standard diet and a bi-phase diet applied to the rearing of pigs is given in Table 4.5.

Table 4.5: Examples of the influence of nutrition measures on excreted nitrogen, phosphorus and potassium for the rearing of pigs

Animal	Diet/parameters	N (¹) (kg/ap/yr)		P (¹) (kg/ap/yr)		K (¹) (kg/ap/yr)	
		Standard	Bi-phase	Standard	Bi-phase	Standard	Bi-phase
Sows	Two phases: CP 14 % gestating; 16.5 % farrowing 1 200 kg feed/ap/yr	24.60	20.40	6.11	4.80	9.08	8.00
Weaners (8–30 kg)	Two phases: CP 20 % (1 st phase); 18 % (2 nd phase) FCR: 1.74 kg/kg	4.03	3.64	0.91	0.72	2.02	1.89
Fattening pigs (30–112 kg)	Two-phases: CP 16.5 % (growers); 15 % (finishers) FCR: 2.86 kg/kg during fattening (+0.006 kg per extra kg over 112 kg)	13.68	11.37	2.76	1.89	5.52	4.82
Per each further kg (²)	NA	0.20	0.18	0.05	0.03	0.08	0.08
⁽¹⁾ Levels are calculated for the typical number of production cycles per year, equivalent to 6.5 for weaners and 3 for fattening pigs, as reported in the reference. ⁽²⁾ Correction to apply when the slaughtering weight is over 112 kg of the LW. NB: NA = not applicable. Source: [329, CORPEN 2003]							

The effects of the various nutritional strategies have independent effects on ammonia emission. This means that these effects are additive [508, TFRN 2014].

According to a reported example of combining four different nutritional measures, a 69 % reduction of total ammonia emissions could be achieved in the rearing of fattening pigs. The reduction was achieved by applying the following measures:

- lowering the crude protein intake in combination with addition of amino acids;
- shifting nitrogen excretion from urine to faeces by adding fermentable carbohydrates to the diet;
- lowering the urine pH, by adding acidifying salts to the diet;
- lowering the pH of faeces, by adding fermentable carbohydrates to the diet [324, Netherlands 2010] [448, Aarnink et al. 2007].

Nutritional programmes

In practically every country, programmes exist for advising farmers about nutrition management. Nutritional standards are produced to provide farmers with nutrient requirements for efficient production, taking into account animal welfare and the need for environmental protection.

In the Flemish part of Belgium, low-nitrogen or low-phosphorus feed or a combination of both are legally recognised through a contract between feed manufacturers and the government [506, TWG ILF BREF 2001].

In Germany, the RAM-feeding programmes of low-nitrogen-and-phosphorus feeds were developed by farmers and feed manufacturers. They also rely on contracts that are controlled by the regional agricultural chambers.

In France, CORPEN recommends a two-phase feeding programme for each physiological stage (e.g. first weaner stage for pigs of around 8 kg to 12 kg and second weaner stage for older weaners, lactating/gestating sows, grower/finisher pigs) based on low-protein and/or low-phosphorus diets [329, CORPEN 2003].

Feeding recommendations are prepared for Finland by MTT Agrifood Research Finland and for the UK by the British Society of Animal Science [323, Finland 2010].

In Denmark, data on nutritional management (e.g. consumption of all feed compounds, weight and age of the animals) from farms are used to calculate the actual average crude protein and phosphorus content of all feed mixes used in the period and a norm value for the content of N and P in the manure; this information is collected each year as a part of the fertiliser accounting management plan for crop production. All documentation has to be kept for 5 years in a log book [330, Denmark 2010].

Mandatory nutritional management systems are already in place in some Member States and are backed up by practical experience. They are mainly run in two ways that are described below.

Monitoring of the nutrient input and output

In those areas where intensive livestock production is responsible for high environmental pressure, farmers have to keep a register of their nitrogen and/or phosphate applications. The mineral bookkeeping systems monitor the input and output flows at the farm level. Examples of regulatory tools are: the Act on Classified Installations for Environmental Protection in France, the Manure Action Plan (MAP) and the Sustainable Nitrogen Management in Agriculture (PGDA) in Belgium, the Mineral Accounting System (MINAS) in the Netherlands, and the Düngerverordnung in Germany.

Estimation of nutrient excretion from the slurry on the basis of the feed characteristics

As nutrient output is highly correlated with nutrient intake, it should be calculated based on the characteristics of the feeds in terms of the correlation with the mineral content in diets. Indeed, this is done in those Member States where nutritional management systems are already implemented. Indications of the systems used in France (CORPEN), Belgium (Flanders) (MAP) and Germany (RAM) are given in this section and in the following sections under 'Achieved environmental benefits'.

If the feeding system is different to and/or more efficient than the nutritional specifications used, regression systems allow the actual level of excretion to be calculated as a function of the feed characteristics (protein and/or phosphorus contents). As an example, the set of equations used in Belgium is reported in Table 4.6.

Table 4.6: Regressions used in Belgium (Flanders) to calculate the actual level of excretion

Animal species	Nitrogen (N) excretion (kg/animal/year)	Diphosphorus pentoxide (P ₂ O ₅) excretion (kg/animal/year)
Weaners weighing from 7 kg to 20 kg	$Y = 0.10 \cdot X - 1.322$	$Y = 1.65 \cdot X - 0.819$
Other pigs weighing from 20 kg to 110 kg	$Y = 0.13 \cdot X - 3.046$	$Y = 1.94 \cdot X - 1.698$
Other pigs weighing more than 110 kg	$Y = 0.133 \cdot X - 0.2208$	$Y = 1.8503 \cdot X + 0.344$
Sows, including piglets with a weight < 7 kg	$Y = 0.133 \cdot X - 0.2208$	$Y = 1.8503 \cdot X + 0.344$
Boars	$Y = 0.133 \cdot X - 0.2208$	$Y = 1.8503 \cdot X + 0.344$
Laying hens	$Y = 0.1496 \cdot X - 0.2455$	$Y = 2.2254 \cdot X - 0.0606$
Laying hens/breeders	$Y = 0.1548 \cdot X - 0.2305$	$Y = 2.2606 \cdot X - 0.0587$
Breeding stock of laying hens/breeders	$Y = 0.1492 \cdot X - 0.1149$	$Y = 2.2277 \cdot X - 0.0512$
Broilers	$Y = 0.1541 \cdot X - 0.5283$	$Y = 2.334 \cdot X - 0.196$
Broiler breeders	$Y = 0.1517 \cdot X - 0.1918$	$Y = 2.2606 \cdot X - 0.0587$
Breeding stock of broiler breeders	$Y = 0.1571 \cdot X - 0.1705$	$Y = 2.2152 \cdot X - 0.0770$
Y = Production (kg) of N and P ₂ O ₅ per animal and per year. X = Consumption (kg) of crude protein (CP) and phosphorus (P) per animal per year.		
Source: [625, BE Flanders 2013]		

In France, the amount of nutrients that are excreted, the amount lost as emissions and those that are available for spreading are estimated. For poultry, tables are used for each of the many types of animals produced. For pigs, the 'simplified accounting balance' takes into account the main factors involved in pig excretion, i.e. feeding technique and level of performance, and has been published as a calculation sheet and as a computer model. All compound flows are taken into consideration. Nutrients that are provided to animals are estimated based on pigs' live weight. Elements associated with manure and bedding are determined by the initial feed composition and quantity. Nitrogen emission flows are calculated as a function of the excreted quantity, depending on the rearing system. Emissions from houses are then estimated as the difference between input (animal + feed + bedding) and output (animal + gas losses) flows [328, CORPEN 2006] [329, CORPEN 2003].

Examples of diet formulations applied in different Member States are reported in Section 9.2.

Technical considerations relevant to applicability

Nutritional measures are considered generally applicable and their use is widespread across the EU.

Economics

Cost estimates of nutritional measures take into account the following factors:

- additional feed costs (or savings depending on raw materials' market prices);
- additional costs for increased storage needs when adding a new phase feeding strategy;
- savings in water costs;
- savings in slurry transport and treatment or spreading costs;
- savings in capital investment, e.g. less storage capacity required for raw materials.

Where dietary protein levels decrease with increasing cereal use in feed, then the changes in cereal price are important for the sustainability of the nutritional management measures. With successive CAP reforms, the inclusion of higher levels of cereals has been favoured and the cost of implementing reduced protein diets has decreased accordingly. The cost and affordability of the feeding measure depends on the local commodity supply (such as cereals' affordability), the local land availability for spreading manure (limited availability will enhance the value of the feeding measure), and the world market price for protein-rich feedstuffs. High prices of protein-rich feedstuffs increase the attractiveness of the feeding measures, as will the increasing availability of synthetic amino acids.

The costs that feeding measures imply depend on the market fluctuations in feedstuff prices. These price fluctuations are too large to derive a universal estimate (see Table 4.7). However, as a general rule one can assume that the extra feed cost in pigs and poultry will range from 0 to 3 % of the total feed cost; FEFAC estimated an increase by 2–3 % for poultry and 1–1.5 % for fattening pigs [704, FEFAC 2001]. In periods of extremely low prices of soybean meal, the extra feed cost may increase by up to about 5 %, depending on the prices of the amino acids [506, TWG ILF BREF 2001].

Examples of contract prices for raw materials used in the feed formulation for pigs are given in Table 4.7.

Table 4.7: Contract prices for raw materials and estimates of raw material costs for balanced feed formulations for pigs

Feedstuff	February 2010 (EUR/tonne)	November 2010 (EUR/tonne)	September 2011 (EUR/tonne)
Wheat	116	215	202
Barley	99	195	203
Maize	125	214	226
Wheat bran	84	163	131
Corn gluten feed	144	200	NI
Peas	170	242	256
Soybean meal	329	350	318
Rapeseed meal	199	236	204
Sunflower meal in the husk	143	191	149
Plant oil	741	978	953
Molasses of sugar cane	168	178	NI
L-Lysine HCl	2 100	1 750	1 950
DL-methionine	3 650	3 800	3 650
L-threonine	2 200	1 900	1 880
L-tryptophan	21 000	16 000	10 000
Calcium carbonate	50	50	50
Calcium phosphate	330	380	560
3-Phytase	9 500	9 500	9 500
Balanced growers formula	146.9	228.5	212.6
Balanced finishers formula	135.1	219.6	207.6
NB: NI = no information provided.			
Source: [281, France 2010] [450, IFIP 2011]			

An example of the effect of price fluctuation of feed materials and amino acids on the extra costs (or savings) incurred by the implementation of low-protein diets in the rearing of fattening pigs is reported in Table 4.22.

Driving force for implementation

The necessity to comply with nitrogen loads in Nitrate Vulnerable Zones or with basin management plans, according to European legislation protecting water, is a major force for farmers to reduce and control through nutritional management techniques the concentration of nutrients in animal nutrition and excreta. The application of nutritional measures can also be driven by animal performance, and the competitiveness and financial viability of the business. Indeed, these will usually be the major driving forces for the implementation of techniques when the animal population is within the carrying capacity of the land, and where local land banks have the capability to recover nutrients from produced manures and slurries.

Market prices (for grains and especially for soya) can produce cost savings when applying nutritional measures.

Example plants

Many farms located in Nitrate Vulnerable Zones (according to the Nitrates Directive (91/676/EEC)), such as those in Brittany (France), the Netherlands, Belgium and Germany, already comply with some nutritional constraints in order to control their pollution load [506, TWG ILF BREF 2001].

In France, since the publication of CORPEN recommendations for pigs in 1996, two-phase feeding with low-protein feeds has been much developed, especially for sows. By the end of 1997 nearly one-third of fattening pigs and nearly 60 % of all sows were fed this way [704, FEFAC 2001].

In Germany, N-adapted feeding has been mandatory for intensive livestock farms since 2002.

In Denmark, the implementation of the Danish BAT system in the framework of the ammonia emissions legislation set a requirement starting in 2011 that the feed management in farms produce a reduction of ammonia emissions of 30 % compared to standard feeding for all new houses and 25 % compared to standard feeding for housing systems with partly slatted floors (25 % solid floor) [330, Denmark 2010].

Reference literature

[30, Spain 2001] [281, France 2010] [323, Finland 2010] [324, Netherlands 2010] [328, CORPEN 2006] [329, CORPEN 2003] [330, Denmark 2010] [396, LEI 1999] [414, Fefana 2001] [448, Aarnink et al. 2007] [450, IFIP 2011] [506, TWG ILF BREF 2001] [624, IRPP TWG 2013] [625, BE Flanders 2013] [704, FEFAC 2001]

4.3.2 Multiphase feeding

In multiphase feeding the nutrient content of the diet is adjusted to the different requirements, as well as to the different feed intake of the animals in the different growth phases. This is achieved by the provision of different rations or diets to livestock at different stages of growth or performance to match the ration closely to the changing requirements of the animals.

4.3.2.1 Poultry

Description

Different feeding strategies have been developed which aim at meeting the right balance between energy and amino acid requirements or which aim to influence the nutrient uptake through an improved passage of the feed through the birds' digestive channel.

Multiphase feeding for layers is a method of feeding which involves adjustment of the levels of Ca and P in the different production stages. A uniform group of animals and a gradual transition from one feed to the next is required.

Achieved environmental benefits

The primary effect of multiphase feeding is the potential for reduction in the excretion of nutrients (notably, N and P).

The main environmental benefit of the implementation of multiphase feeding in poultry production is reported as a 4–10 % reduction in the amount of N excreted [281, France 2010] [414, Fefana 2001]. Values as high as 15–35 % are reported for the reduction of N excreted for broilers.

Cross-media effects

A lower nutrient content of the manure leads to lower nutrient emissions from landspreading, but also to a higher use of mineral fertilisers, in the event that crop nutritional needs cannot be met by manure application alone.

Environmental performance and operational data

For broilers, multiphase feeding is applied in some EU countries. This involves dividing their requirements into three to five phases in which the broilers show a considerable change in their nutritional requirements. In each phase, the aim is to optimise the feed conversion ratio (FCR). Applying a slightly restricted feeding regime in the first phase results in more efficient growth at a later stage. Proteins and amino acids must be fed at a high level and in a balanced way. In phase 2 the digestive capacity of the bird will have improved, so it can be fed more feed with a higher energy content. In phase 3, the protein and amino acid content decreases resulting in the same or a reduced amount of energy. In all phases, the Ca-P balance remains the same, but the total concentration in the feed decreases [281, France 2010].

Compared with broilers, turkeys require larger amounts of feed. Their requirements in the different phases vary in the same way as those of broilers. The required concentration of proteins and amino acids decreases with increasing age, but the required feed energy increases. Depending on the type of turkey produced, the number of phases applied can vary, with four to five being normal practice. For instance, in the Netherlands, five-phase feeding is applied, which means five different feeds, although more phases can be distinguished and rations are adapted accordingly. For turkeys, the shape in which the feed is offered influences the FCR and growth. Tests have shown that pellets show better FCR and growth than meal.

Examples of diet formulation for multiphase feeding regimes (reduced crude protein and supplement of amino acids) are reported in Table 4.8, together with the associated performance results, in terms of total nitrogen and ammonia in the excreta. Data refer to farms operated in Germany.

Table 4.8: Examples of multiphase feeding regimes and associated emissions in the poultry sector

Phases ⁽¹⁾	Broilers	Pullets	Laying hens	Ducks (Pekin)	Turkeys (male)	Turkeys (female)
	3	4	3	2	4	3
Phase 1 weeks (days)	(1–10)	1–3	NI	1–3	5–8	5/6–8/9
Crude protein (%)	22	20.5	18	22	24	24.4
Amino acids (%)	0.55	0.48	0.40	0.44	1.4	1.45
Phase 2 weeks (days)	(11–27/32)	4–8	NI	4–7	9–12	9/10–12/13
Crude protein (%)	21	18.5	17	18	20	20
Amino acids (%)	0.55	0.40	0.35	0.43	1.25	1.25
Phase 3 weeks (days)	(28/33–35/42)	9–15/16	NI	NA	13–16	13/14–16/17
Crude protein (%)	19.5	14.5	16.5	NA	18	18
Amino acids (%)	0.50	0.33	0.35	NA	1	1.05
Phase 4 weeks (days)	NA	16/17	NA	NA	> 17	NA
Crude protein (%)	NA	17.5	NA	NA	16	NA
Amino acids (%)	NA	0.36	NA	NA	0.85	NA
Feed efficiency (kg feed/kg weight gain)	1.75	(0.2) ⁽²⁾	2.05 ⁽³⁾	2.3	2.67	2.58
Starting bird weight (kg)	0.035–0.045	0.04–0.05	1.1–1.5	0.053–0.06	1.9–1.95	1.52–1.59
Final bird weight (kg)	1.6–3.3	1.1–1.5	1.7–2.2	2.5–3.4	19.45–21.4	9.5–11.5
Number of animals per place and year	6.5–8.1	2.4–2.9	NI	6.6–7.4	2–2.9	2.2–2.9
Rearing time (days)	39–46	119–140	360–420	45 (40–49)	133–154	70–84
Quantity of manure (kg/kg live weight)	0.6 (0.54–0.65)	2.73	1.4 ⁽⁴⁾	3.2	1.45 (1.23–1.53)	1.21
Dry matter content (%)	60 (57–62.3)	52 (50–75)	55.2	20.46 (20.15–22)	52 (41.7–59.8)	50
N total (g/kg live weight)	18.2 (16–19.6)	66 (66–73)	40 (36–45.7) ⁽⁵⁾	26.5 (25.8–33.5)	39 (28–41.7)	39 (39–44)
N total (kg animal place/year)	0.207–0.42 ⁽⁶⁾	NI	0.626–0.794 ⁽⁷⁾	0.477–0.752 ⁽⁶⁾	1.198–2.352 ⁽⁶⁾	0.987–1.212 ⁽⁶⁾
NH ₄ -N (g/kg live weight)	12.8 (3.5–14.8)	NI	NI	10.38 (10.38–11.48)	15.8 (11–18.4)	NI
P ₂ O ₅ (g/kg live weight)	3.79 (3.59–4)	53.18 (17.3–53.18)	20 (8.4–36) ⁽⁵⁾	13.7 (8.23–13.9)	30.6 (23–38)	7 (6.6–9.9)
P ₂ O ₅ (kg animal place/year)	0.047–0.086 ⁽⁶⁾	NI	0.146–0.626 ⁽⁷⁾	0.152–0.312 ⁽⁶⁾	0.984–2.143 ⁽⁶⁾	0.167–0.25 ⁽⁶⁾

⁽¹⁾ The exact feeding programme is presented in Section 9.2.2.
⁽²⁾ Value expressed in kg weight gain/kg feed.
⁽³⁾ Value expressed in kg weight gain/kg eggs.
⁽⁴⁾ Value expressed in kg manure/kg eggs.
⁽⁵⁾ Value expressed in g/kg eggs.
⁽⁶⁾ The range is calculated from the final animal weight, the number of cycles and the range of reported excretion.
⁽⁷⁾ The range is calculated from an annual production of 278 eggs and an average weight of 1 kg for 16 eggs.
NB: NI = no information provided; NA = not applicable.
Source: [327, Germany 2010]

Technical considerations relevant to applicability

Multiphase feeding is considered generally applicable in the poultry sector. The number of phases and the potential for reducing nitrogen excretion depend on the animal species and might need adaptation to local conditions [508, TFRN 2014].

The availability of animal feedstuffs with a low protein content and synthetic amino acids may result in some limitations to the applicability of the technique, in particular in terms of achievable reduction levels.

Economics

When going from one-phase feeding to two-phase feeding, there may be an additional cost for supplemental storage. As the number of phases increases, the implementation of the technique might require high additional investment for storage, mixing and supplying devices, metering equipment, conveying technology, etc., which might not be affordable for small farms.

Driving force for implementation

Optimisation of animal growth and of feedstuff costs.

Example plants

The use of multiphase feeding for the rearing of poultry is reported to be commonly applied in several Member States.

Reference literature

[281, France 2010] [327, Germany 2010] [414, Fefana 2001] [508, TFRN 2014]

4.3.2.2 Pigs

Description

Multiphase feeding for pigs consists of successively giving two to five feeds to pigs with weights that are multiples of 25 kg, up to 100–110 kg (slaughter weight). Feeding programmes vary among countries. The two-phase feeding programme (25–60 kg and 60–110 kg) is well developed but could be further developed to include environmental concerns, as well as to improve the economic value. Italian feeding programmes differ substantially from those of other EU countries because they work with much higher slaughter weights (140–150 kg).

Multiphase feeding for pigs also consists of providing pigs with a compound feed that matches the animal requirements for amino acids, minerals and energy. This is achieved by mixing a high nutrient feed with a low nutrient feed, on a regular basis (from daily to weekly), as the ideal animal nutritional requirements change continuously with the increase in live weight. Multiphase feeding allows the nutrient supply to be adapted more closely to the nutritional requirements of the animal.

Achieved environmental benefits

The primary effect of multiphase feeding is the potential for reduction in the excretion of nutrients (notably, N and P).

The main achieved environmental benefit of the implementation of multiphase feeding in the production of pigs is reported as a 10–30 % reduction in the amount of N excreted, when used in combination with low-protein diets [281, France 2010] [414, Fefana 2001].

Cross-media effects

A lower nutrient content of the manure leads to lower nutrient emissions from landspreading, but also to a higher use of mineral fertilisers in the event that crop nutritional needs cannot be met by manure application alone.

Environmental performance and operational data

For pigs, a different diet formulation for weaners (< 30 kg live weight (LW)), growers (from 30 kg to 60 kg live weight) and finishers (from 60 kg to 112 kg live weight) is generally applied. In some cases, a different diet formulation is used for young weaners (first stage between 8 kg and 12 kg) and for older weaners (second weaning stage > 12 kg).

For sows, phase feeding consists of giving at least two different feeds: one for lactation and one for gestation. This differentiation is well developed across Europe. In some cases, a specific feed might be given before farrowing [506, TWG ILF BREF 2001]. Examples of detailed multiphase feeding programmes are described in Annex 9.2.2. A summary of the reduction potential for ammonia emissions associated with multiphase feeding in fattening pig production is shown in Table 4.9 for different feeding strategies and diet formulations.

Table 4.9: Reduction potential for ammonia emissions in fattening pig production with different crude protein adjusted feeding

Feeding strategy	Reduction potential ⁽¹⁾ (%)	Remarks
Multiphase feeding (2 phases)	Up to 10	Adjustment between preliminary feeding and main feeding periods (from 18 % to 15 % crude protein)
Multiphase feeding (3–4 phases)	Up to 20	Adjustment every few weeks; from 18 % to 13 % crude protein; balancing of essential amino acids (lysine, methionine)
Multiphase feeding plus amino acid balancing	Up to 40	Daily adjustment; from 18 % to 13 % crude protein; balancing of essential amino acids (lysine, methionine)
⁽¹⁾ Reference feeding regime: No multiphase feeding, 18 % crude protein content.		
Source: [571, Eurich-Menden et al. 2011]		

Examples of excreted nitrogen reductions associated with the use of two-phase feeding programmes combined with low-protein diets applied in France and Germany are reported in Table 4.10, together with an indication of the diet formulation applied.

Table 4.10: Examples of excreted nitrogen reductions for two-phase feeding programmes in the pig sector compared to the one-phase feeding

Animal	Source	Diet/parameters	Excreted nitrogen reduction ⁽¹⁾ (%)
Weaners	France CORPEN 1	Two phases: CP 20 % (1 st phase); 18 % (2 nd phase)	9
	France CORPEN 2	Two phases: CP 20 % (1 st phase); 17 % (2 nd phase)	18
Fattening pigs	France CORPEN 1	Two phases: CP 16.5 % (growers); 15 % (finishers)	17
	France CORPEN 2	Two phases: CP 15.5 % (growers); 13.0 % (finishers)	30
	Germany RAM	Two phases: CP 17.0 % (< 60 kg of LW); 14.0 % (> 60 kg of LW)	19
Sows	France CORPEN 1	Two phases: CP 16.5 % (lactation); 14.0 % (gestation)	17
	France CORPEN 2	Two phases: CP 16.0 % (lactation); 12.0 % (gestation)	27
	Germany RAM	Two phases: CP 16.5 % (lactation); 14.0 % (gestation)	19–22
Source: [414, Fefana 2001] [329, CORPEN 2003]			

A three-phase feeding programme for growers/finishers can reduce N excretion by 16 % compared to a one-phase feeding programme [448, Aarnink et al. 2007].

Trials with five-phase low-CP/DE (crude protein/digestible energy) diets for fattening pigs (growers/finishers) were carried out in the UK, which consistently showed that total nitrogen and ammonium-N in slurry from pigs were reduced compared to levels resulting from the commercial two-phase feeding strategy [539, MAFF 1999] [540, MAFF 1999]. A reduction of up to 5 % for NH₃ emissions and up to 10 % for soluble P emissions is recognised as the effectiveness of this technique in the UK [648, DEFRA 2011].

However, in a field study carried out in the UK, an overall evaluation of daily adjusted multiphase feeding for fattening pigs reared on fully slatted floors or in a straw-based system was performed in comparison with a one-phase diet. The multiphase diet was formulated so that the total lysine to digestible energy ratio was adjusted to meet pigs' requirements according to their actual live weight, while the one-phase feeding was fixed at the target requirement of 70 kg live weight (18.5 % CP). No significant effects were found on dust and ammonia emissions, slurry generation and composition with this diet formulation [654, BPEX 2004].

An example of the performance variation observed by applying a two-phase feeding regime and a five-phase feeding regime for fattening pigs is presented in Table 4.11. The detailed composition of the different diets used for both feeding strategies is reported in Annex 9.2.2.

Table 4.11: Example of the influence of multiphase feeding on excreted nitrogen and phosphorus for fattening pigs

Feeding strategy ⁽¹⁾	Operating and performance data	
	2 phases	5 phases
Phases	Phase 1: 25–60 kg Phase 2: 60–110 kg	Phase 1: 30–40 kg Phase 2: 40–60 kg Phase 3: 60–80 kg Phase 4: 80–100 kg Phase 5: 100–110 kg
Excretion parameters		
Total nitrogen ⁽²⁾ (kg/animal place/year)	7.8	7.35
Nitrogen excreted (kg N/m ³ manure)	~ 5.2	4.9
Total P ₂ O ₅ (kg/animal place/year)	4.8	4.5
P ₂ O ₅ excreted (kg/m ³ manure)	~ 3.2	~ 3.0
Quantity of manure (m ³ /ap/yr)	1.5, with 7.5 % dry matter	
Animal performance		
Feed consumption (kg/d)	2.15 (2.1–2.3)	
Average daily gain (g/d)	720 (650–850)	
Feed efficiency (kg weight gain/kg feed)	0.34 (0.31–0.37)	
Rearing time (d)	125 (110–140)	
Number of animals per place and year	2.8 (2.5–3)	
⁽¹⁾ The exact feeding programmes are presented in Section 9.2.2. Amino acid supplementation and benzoic acid addition. Phytase and inorganic P addition.		
⁽²⁾ Housing and stock losses deducted.		
Source: [326, Germany 2010.]		

Excretion amounts associated with the application of phase feeding and a low-crude protein diet with amino acid supplementation for weaners, gestating and farrowing sows are presented in Table 4.12.

Table 4.12: Example of the influence of multiphase feeding with amino acid and phytase addition on excreted nitrogen and phosphorus for sows and weaners

	Operating and performance data		
Animal category	Sows		Weaners
Feeding strategy ⁽¹⁾	Gestating sows: phase feeding with amino acid supplementation. Phytase and inorganic P addition	Lactating sows: one-phase feeding with amino acid supplementation. Phytase and inorganic P addition	Phase feeding with amino supplementation, benzoic acid and NSP enzymes addition. Phytase and inorganic P addition
Phases	Phase 1: day 1 to day 84 Phase 2: day 85 to day 115 and for non-pregnant sows	Phase 1: ~ 25 days (21–28)	Phase 1: 8–20 kg Phase 2: 20–30 kg
Excretion parameters			
Total nitrogen ⁽²⁾ (kg/animal place/year)	18 (17.2–18.4) ⁽³⁾		1.5 (1.4–1.6)
Nitrogen excreted (kg/m ³ manure)	~ 4.5 (4.3–4.6) ⁽³⁾		~ 2.5 (2.3–2.7)
Total P ₂ O ₅ (kg/animal place/year)	12.4 (11.2–13.6)		2.2
P ₂ O ₅ excreted (kg/m ³ manure)	~ 3.1 (2.8–3.4)		~ 3.7
Quantity of manure (m ³ /animal place/year)	4 (3.6–7.7) with 4 % DM		0.6 (0.5–1.1)
Animal performance			
Feed consumption (kg/d)	2.8 (2.5–3.1)	6.5 (3.5–7)	0.8 (0.65–0.9)
Average daily gain (g/d)	-	-	500 (450–550)
Feed efficiency (kg weight gain/kg feed)	0.25 (0.23–0.28)	0.25 (0.23–0.28)	0.6 (0.5–0.65)
Rearing time (d)	115	25 (21–25)	47 (41–48)
Number of litters or animals per place and year	2.3	2.3	6.7 (5–7)
⁽¹⁾ The exact feeding programmes are presented in Section 9.2.2. ⁽²⁾ Housing and stock losses deducted. ⁽³⁾ Value refers to sows (with 22 reared piglets of 8 kg each) without differentiation between various stages (lactating, gestating or non-pregnant). Source: [326, Germany 2010]			

The feeding strategies with a reduced phosphorus content adopted in France are reported in Annex 9.2.2.5. Compared to the one-phase feeding strategy, the two-phase feeding strategy with a limited P content reduces P intake and P excretion by 19 % and 28 %, respectively, per slaughter pig (0–115 kg) [590, Batfarm 2013].

Technical considerations relevant to applicability

Multiphase feeding is considered generally applicable in the pig sector. In large groups of fattening pigs, a five-phase feeding programme (or more) may not be applicable due to the variability in the weights of individual pigs within a pen group, which may overlap target start and end weights [624, IRPP TWG 2013].

Economics

When going from one-phase feeding to two-phase feeding, there may be an additional cost for supplemental storage. As the number of phases increases, the implementation of the technique might require high additional investment for storage, mixing and supplying devices, metering equipment, conveying technology, etc., which might not be affordable for small farms. Hence in Denmark, the technique is not considered applicable to farms with less than approximately 1 300 animal places [330, Denmark 2010].

Cost data from Spain [379, Spain 2009] report an additional cost of EUR 0.7–1.02/animal place/year or EUR 2.4–4.0/t produced when two-phase feeding is applied in the production of fattening pigs (one phase for the range 20–60 kg and another for finishers of 60–100 kg).

In another study in the UK, multiphase feeding with a daily adjustment of feed did not deliver a cost benefit over a single feeding phase; total finishing costs (EUR/kg of deadweight) were around 2 % higher with the multiphase system (taking into account all variable and fixed production costs) [654, BPEX 2004].

Driving force for implementation

Multiphase feeding offers a cost-effective means of reducing nutrient excretion from pigs and could be implemented in the short term [508, TFRN 2014].

Example plants

Multiphase feeding is a consolidated technique commonly applied across the European Union.

Reference literature

[281, France 2010] [326, Germany 2010] [329, CORPEN 2003] [330, Denmark 2010] [379, Spain 2009] [414, Fefana 2001] [448, Aarnink et al. 2007] [506, TWG ILF BREF 2001] [508, TFRN 2014] [539, MAFF 1999] [540, MAFF 1999] [571, Eurich-Menden et al. 2011] [590, Batfarm 2013] [624, IRPP TWG 2013] [648, DEFRA 2011] [654, BPEX 2004]

4.3.3 Low-protein, amino-acid-supplemented diets

Description

The crude protein content of the diet can be reduced if the amino acid supply is optimised through the addition of synthetic amino acids to meet animal requirements. The low-protein diet is formulated with less protein-rich feedstuff, e.g. soybean meal for pigs. Appropriate amounts of essential amino acids needed for optimal performance are incorporated into the diet. The amino acid supplementation can be done through a one-phase or a multiphase feeding regime. As a result, the ingestion of excess protein is decreased and, consequently, the excreted nitrogen is reduced (Figure 4.2).

The dietary crude protein content can be lowered if at the same time the energy content of the diet is controlled and the level of nutritional amino acids is balanced by synthetic amino acid supplementation in appropriate quantities and proportions and by cereals. Amino acids like lysine (L-lysine), methionine (DL-methionine and analogues), threonine (L-threonine), tryptophan (L-tryptophan) and valine (L-valine) are registered as feed additives and are commercially available.

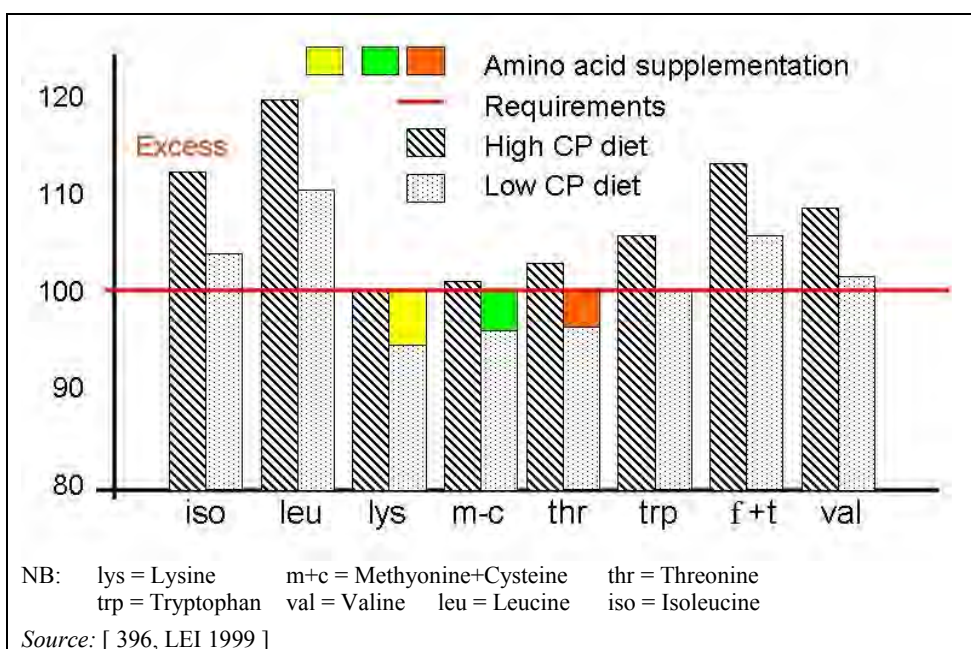

Figure 4.2: Example of reduced protein intake by animals achieved by synthetic amino acid supplementation to a low-protein diet, while maintaining an adequate amino acid supply

Achieved environmental benefits

The reduction of dietary protein ingested (input) leads to a significant reduction of the nitrogen excreted (output), hence emissions can be reduced at all stages of the manure management. For each per cent (absolute value) decrease in the protein content of the animal feed, NH_3 emissions from animal housing, manure storage and landspreading are decreased by 5 % to 15 %, depending also on the pH of the urine and dung. Low-protein animal feeding also decreases N_2O emissions, and increases the efficiency of N use in animal production [508, TFRN 2014]. A summary of benefits associated with the use of a low-protein diet achieved by synthetic amino acid supplementation are listed below.

Poultry

- A reduction in dietary protein content of 1 percentage point results in a reduction in nitrogen excretion of 10 % for poultry [414, Fefana 2001].
- Low-protein diets contribute to a reduction of ammonia emission from poultry houses. In an experiment on growing broilers, a reduction in crude protein of 2 percentage points resulted in a reduction in ammonia emission of 24 %.
- A reduction in water consumption of 8 % is possible when the protein level in grower feed is decreased by 3 percentage points [414, Fefana 2001].
- According to the Dutch model designed for the European Commission, for a reduction of 10 % of the protein content in feed, reductions of the nitrogen content in manure are expected for laying hens, ducks, turkeys and broilers of 14 %, 15 %, 15 % and 19 %, respectively [281, France 2010].
- The litter quality is enhanced by a reduced nitrogen content, which results in reductions of the incidence of skin conditions, such as hock burn, sternal bursitis, focal ulcerative dermatitis and foot pad dermatitis (also important for improving working conditions for farm personnel).

Pigs

- For every 10 g/kg reduction in the CP content of the diet, a 10 % lower TAN content of the pig slurry and 10 % lower NH₃ emissions can be achieved in growing/finishing pigs relative to a baseline value with a protein content of 170 g/kg [508, TFRN 2014].
- It is possible to reduce the nitrogen excretion by up to 20 %, by reducing by up to 2 % the initial protein level in feeds for all categories of pigs and without requiring any specific technical skills [34, Ajinomoto 2000]. However, it is necessary to add the four essential amino acids (lysine, methionine, threonine and tryptophan) and to formulate diets respecting net energy requirements to prevent a deterioration in growth and carcass quality.
- Protein content is gradually reduced according to the need for amino acids and, in this way, a high surplus of nitrogen is avoided. The lower excretion of nitrogen through kidneys and faeces reduces the intestinal problems and physiological 'stress' of the excretion process [330, Denmark 2010].
- In general, reduced crude protein levels have a tendency to lower odour emissions (see Section 4.10) and the emission of odorous components like H₂S [414, Fefana 2001]. This effect is reported as non-existent when a relatively low-protein diet is already used [330, Denmark 2010] [326, Germany 2010]. A reduction in water consumption of about 6–9 % was reported when the protein level in the diet for fattening pigs was decreased by 3 percentage points (from 17.5 % to 14.5 % CP) [414, Fefana 2001]. The saving of water results in a decreased volume of manure to be handled. With higher DM contents, the slurry may also gain in value in terms of its fertilising quality.

Cross-media effects

There are no animal health or animal welfare implications of a reduction of protein level as long as the requirements for all essential amino acids are met.

Environmental performance and operational data

A crude protein reduction of 2–3 % in the feed (20–30 g/kg of feed) can be achieved with adequately balanced and optimal digestible amino acid supply depending on the pig production category and its starting point. For poultry, a crude protein reduction of 1–2 % (10–20 g/kg of feed) can usually be achieved depending on the species and their starting point [508, TFRN 2014]. The resulting range of dietary crude protein content is reported Table 4.13 and in Table 4.14.

Table 4.13: Indicative crude protein levels in low-protein feeds for pigs

Animal type	Phases	Crude protein content (% in feed)	Remark
Weaner	< 10 kg	19–21	With adequately balanced and optimal digestible amino acid supply
	< 25 kg	17–19	
Fattening pig	25–50 kg	15–17	
	50–110 kg	14–15	
Sow	Gestation	13–15	
	Lactation	16–17	

Source: [43, COM 2003]

Table 4.14: Indicative crude protein levels in low-protein feeds for poultry

Animal type	Phases	Crude protein content (% in feed)	Remark
Broiler	Starter	20–22	With adequately balanced and optimal digestible amino acid supply
	Grower	19–21	
	Finisher	18–20	
Turkey	< 4 weeks	24–27	
	5–8 weeks	22–24	
	9–12 weeks	19–21	
	13+ weeks	16–19	
	16+ weeks	14–17	
Layer	18–40 weeks	15.5–16.5	
	40+ weeks	14.5–15.5	

Source: [43, COM 2003]

The values of the ranges of the best feed management practices are indicative target levels and may need to be adapted to local conditions. The achievable levels depend on the management skills of the farmer and the availability of the animal feedstuffs with a low protein content, including synthetic amino acids [508, TFRN 2014]. A series of examples is reported in Table 4.15, showing the environmental and economic effects of the reduction in the amounts of crude protein (CP) for pigs and poultry, together with the corresponding amino acid supplementation.

Table 4.15: Environmental and economic benefits of formulating a low-crude-protein diet with synthetic amino acid supplementation

Feed components	Animal category				
	Laying hens ⁽¹⁾	Broilers	Male turkeys ⁽²⁾	Fattening pigs	Fattening pigs
Source	[316, Fefana 2010]	[312, Fefana 2010]	[313, Fefana 2010]	[314, Fefana 2010]	[315, Fefana 2010]
Phase 1					
Initial CP level (%)	19	22	27.7	17.5	17.5
Initial amino acid supplementation (%)	0.21	0.35	0.32	0.202	0.066
Reduction of CP level (%)	-2.9	-2	-1.9	-3	-1.5
Final CP level in diet (%)	16.1	20	25.8	14.5	16
Additional amino acid supplementation (%)	+0.38	+0.25	+0.32	+0.426	+0.242
Total amino acid supplementation in the reduced CP diet (% of diet)					
L-Lysine HCl (%)	0.24	0.20	0.29	0.49	0.156
DL-Methionine (%)	0.28	0.31	0.27	NA	0.088
L-Threonine (%)	0.07	0.07	0.08	0.124	0.064
L-Tryptophan (%)	NA	0.02	NA	0.014	NA
Phase 2					
Initial CP level (%)	NA	20.6	23.3	NA	15.5
Initial amino acid supplementation (%)	NA	0.22	0.37	NA	0.116
Reduction of CP level (%)	NA	-2.4	-1.7	NA	-2.0
Final CP level in diet (%)	NA	18.2	21.6	NA	13.5
Additional amino acid supplementation (%)	NA	+0.19	+0.31	NA	+0.325
Total amino acid supplementation in the reduced CP diet (% of diet)					
L-Lysine HCl (%)	NA	0.17	0.38	NA	0.255
DL-Methionine (%)	NA	0.24	0.22	NA	0.090
L-Threonine (%)	NA	0.07	0.08	NA	0.096
L-Tryptophan (%)	NA	0.01	NA	NA	NA
Overall results					
Reduction of total N in the excreta (%)	22.9	19.9	23	29.2	16.2
Total N in the excreta (kg/animal place/year) ⁽³⁾	NI	0.352	2.511	5.05	6.22
Total N excreted (kg/animal place/year)	0.601	NI	NI	7.09	NI
Annual savings per animal place (EUR)	0.32	0.116	0.41	8.006	5.21
Annual savings per production (EUR/kg ⁽⁴⁾ or EUR/egg)	(0.0164)	0.018	0.025	0.0391	0.0307
⁽¹⁾ Four phases. Diet presented under 'Phase 1' represents all phases (18 to 80 weeks).					
⁽²⁾ Two more phases of the test have not been displayed.					
⁽³⁾ Obtained by multiplying g N/kg live weight by number of cycles per year and final weight.					
⁽⁴⁾ Price calculations are based on amino acid and feed raw materials prices of December 2009.					
NB: NA = not applicable; NI = no information provided.					

The effects of two different low-protein diets for fattening pigs (finishers), with partial or total substitution of soybeans by synthetic amino acids, have been tested during two field trials; the results are presented in Table 4.16.

Table 4.16: Effects of two low-protein diets with partial or total substitution of soybeans by essential amino acids on fattening pigs (finishers)

Parameters		Diet description and performance data	
Diet		Low-protein diet – 1 Soybeans are reduced and partially substituted by synthetic amino acids	Low-protein diet – 2 Without soybeans which are fully substituted by synthetic amino acids
Time of application		Summer	Winter
Animal weight		98.6–163.8 kg	102.8–160.2 kg
Crude protein (%)		11–12	9
Average reduction in nitrogen, compared to standard diet ⁽¹⁾ (%)		21.9	37.9
Average reduction of ammonia emissions to air, compared to standard diet ⁽¹⁾ (%)	Estimated (Nitrogen balance)	26.2	50.3
	Measured	26.2	54.6
Average reduction of nitrogen to field, after air losses, compared to standard diet ⁽¹⁾ (%)		18	30
⁽¹⁾ Standard diet with 13–14 % CP.			
Source: [325, CRPA 2009]			

In a literature review reported by Ajinomoto Animal Nutrition, data from reported trials on the effects of low-protein diets (and supplemented with synthetic amino acids) on the nitrogen and slurry output from pigs were selected from a large variety of sources within and outside Europe. The conclusion that could be reached was that the excretion of nitrogen drops by 10 % per percentage point reduction in dietary protein for pigs between 25 kg and 110 kg, with a linear trend in the range of a 12 % to 20 % CP level [34, Ajinomoto 2000]. Table 4.17 summarises the effects of a reduction in dietary crude protein levels and the use of low-protein diets.

Table 4.17: Summary of the effect of a reduction of dietary protein and the use of low-protein diets on nitrogen excretion and ammonia emission

Parameters	Effect of 1 percentage point reduction of dietary protein (%)	Using low-protein diets	
		Frequent cumulative effect (%)	Best cumulative effect (%)
Total nitrogen excreted	-10	-25	-50
Ammonia content in slurry	-10	-30	-50
Slurry pH	-	-0.5 points	-1 point
Ammonia emission to air	-10	-40	-60
Water consumption (ad libitum)	-2 to -3	-10	-28
Slurry volume	-3 to -5	-20	-30
Source: [34, Ajinomoto 2000]			

Results of a trial carried out in a fattening pigs farm (30–115 kg in a straw housing system), applying a one-phase feeding strategy in which the applied dietary CP level of 17.5 % was reduced by 3 percentage points with the addition of supplementary synthetic amino acids (lysine, threonine and tryptophan) are presented in Table 4.18. The experiment results are in line with those reported in Table 4.19.

Table 4.18: Effects of reduced crude protein levels with amino acid supplementation in one-phase feeding of fattening pigs

Parameters	Standard one-phase feeding	Modified one-phase feeding
Crude protein in diet (%)	17.5	14.5
Amino acids in diet (%)	0.2019	0.6274
Total Nitrogen excreted (g/kg live weight)	15.37	10.88
NH ₃ + N ₂ O (N gaseous emissions) reduction (%)	NA	30
Savings in feed cost ⁽¹⁾		
EUR/animal place/year	NA	8.006
EUR/kg produced/year	NA	0.0391

⁽¹⁾ Cost calculations based on amino acids and feed raw materials prices of December 2009.
 NB: NA = not applicable.
 Source: [572, Fefana 2010]

The conversion from a one-phase to a two-phase feeding system, with the aim of adapting the feed to the pig's physiological stage and, at the same time, reducing the excreted nitrogen, may better fulfil the animal's requirements during growth. In an already applied phase feeding strategy, based on the needs of the animal at various life stages, the protein intake can be further reduced by adding synthetic amino acids to the feed.

The substitution of a one-phase feeding scheme with 17.5 % CP with a two-phase scheme where the CP level is reduced by 1 percentage point in the first phase and by 2 percentage points in the second phase, while integrating the two diets with proper doses of amino acids (for a total of 0.4 %), provides a reduction in nitrogen excretion of 18.5 % (see Table 4.19) [317, Fefana 2010] [318, Fefana 2010]. The introduction of a second phase with a 2 percentage point reduction of the dietary crude protein level leads to a reduction of the nitrogen excreted of around 8 % [319, Fefana 2010]. The substitution of expensive protein meals with small doses of synthetic amino acids still allows for reductions in the cost of feed preparation, as shown in Table 4.19 for two different formulations of two-phase feeding in comparison with the single phase previously applied.

Table 4.19: Examples of emissions and costs reductions for two-phase feeding schemes after transition from a one-phase feeding scheme for fattening pigs

Feeding scheme	CP (%)		Reduction of total excreted N (%)	Feed cost reduction ⁽¹⁾ (%)	Feed cost savings	
	Phase 1 (growing period)	Phase 2 (finishing period)			EUR/ap per year	EUR/kg of produced meat
Standard one -phase feed	17.5		NA	NA	NA	NA
Switch from single phase to two-phase feeding – Reduction of CP level in the finishing period	17.5	15.5	7.8 %	5.76 %	5.675	0.0334
Switch from one-phase to two-phase feeding – Reduction of CP level in both growing and finishing periods	16.5	15.0	18.5 %	5.47 %	5.25	0.0256

⁽¹⁾ Feed costs calculated based on December 2009 prices.
 NB: NA = not applicable.
 Source: [317, Fefana 2010] [318, Fefana 2010] [319, Fefana 2010]

In Spain, a trial was carried out in fattening pigs by applying a low-protein diet. In Phase 1, a crude protein level of 14.6 % (1.04 % lysine) is applied and in Phase 2 of 13.6 % (0.91 % lysine). A 60 % reduction of ammonia emissions is reported to be achieved for this diet formulation [335, Spain 2010]. In general, a 30–40 % reduction of ammonia emissions is possible when a diet low in protein content and with amino acid supplementation is applied in the rearing of fattening pigs [379, Spain 2009].

A further step in the feeding strategy might be the transition from a two-phase feeding system to a three-phase feeding strategy. Results that were obtained in commercial farms in Belgium, concerning three different situations corresponding to a minimal, medium and strong reduction of CP in the diet, and related compensation by amino acids supplementation, are summarised in Table 4.20 (note that negative savings are, in effect, increased costs).

Table 4.20: Effectiveness of transition from two-phase feeding to three-phase feeding for fattening pigs and different crude protein reductions

Parameters		Crude protein reduction		
		Minimal	Medium	High
Two-phase feeding				
Phase 1 (30–45 kg)	Crude protein content (%)	17.5	17.5	17.5
	Supplemented amino acids (%)	0.43 (Lys, Thr, Met)	0.43 (Lys, Thr, Met)	0.43 (Lys, Thr, Met)
Phase 2 (45–110 kg)	Crude protein content (%)	15.5	15.5	15.5
	Supplemented amino acids (%)	0.38 (Lys, Thr, Met)	0.38 (Lys, Thr, Met)	0.38 (Lys, Thr, Met)
N excretion (kg/animal place/year)		10.834	10.834	10.834
Three-phase feeding				
Phase 1 (30–45 kg)	Crude protein content (%)	17.5	16.5	15.5
	Supplemented amino acids (%)	0.43 (Lys, Thr, Met)	0.61 (Lys, Thr, Met, Trp)	0.79 (Lys, Thr, Trp, Met)
Phase 2 (45–75 kg)	Crude protein content (%)	16.5	15.5	14.5
	Supplemented amino acids (%)	0.36 (Lys, Thr, Met)	0.52 (Lys, Thr, Met)	0.69 (Lys, Thr, Met, Trp)
Phase 3 (75–110 kg)	Crude protein content (%)	14	13	12
	Supplemented amino acids (%)	0.48 (Lys, Thr, Met)	0.60 (Lys, Thr, Met)	0.73 (Lys, Thr, Met, Trp)
Growth (g/day)		607	629	631
Weight gain (kg/animal place/year)		215.25	222.77	224.81
Nitrogen excretion performance				
N excretion (kg/animal place/year)		9.89	9.49	8.55
Reduction of excreted nitrogen (%)		8.7	12.4	21.1
Economics ⁽¹⁾				
Savings/animal place/year (EUR)		2.33	7.15	7.57
Savings/animal place/ year (%)		2.24	6.87	7.27
Savings/kg of produced meat/year (EUR)		-0.002	0.037	0.042
Savings/kg of produced meat/year (%)		-0.42	7.85	8.92
⁽¹⁾ Feed cost savings calculated based on October 2009 prices.				
NB: Lys = Lysine; Met = Methionine; Thr = Threonine; Trp = Tryptophan.				
Source: [320, Fefana 2010] [321, Fefana 2010] [322, Fefana 2010].				

From Denmark, a reduction of ammonia emission of 6 % to 22 % for fattening pigs is reported compared to a standard diet with a crude protein content of 157 g per feed unit (1 Danish feed unit for pigs = 7 380 kJ) which is equivalent to 150 g per kg of feed (the average Danish diet for fattening pigs has an energy content of around 1.05 Danish feed units per kg of feed). In particular, three levels of crude protein in the diet for fattening pigs (161 g, 154 g and 148.5 g

per Danish feed unit corresponding to approximately 153 g, 147 g and 141.5 g per kg of feed) are applied with phase feeding and use of synthetic amino acids [330, Denmark 2010]. The effect of applying low crude protein levels on slurry characteristics and N emissions is presented in Table 4.21.

Table 4.21: Effect of the protein content of fattening pigs' feed on slurry characteristics and nitrogen emissions

Dietary CP content	%	20	16	12
Slurry composition				
Amount	kg/pig/d	5.7	5.1	3.6
Dry matter	%	4.4	4.6	5.9
Total N	g N/kg	5.48	4.3	3.05
Total N-NH ₄	g N/kg	4.32	3.13	1.92
pH	-	8.92	8.61	7.57
N balance				
N retention	g/pig/d	23.2	23.5	21.9
N excretion	g/pig/d	40.7	27.6	15.0
NH ₃ emissions	g/pig/d	17.4	13.8	6.4

Source: [451, Portejoie et al. 2002] [590, Batfarm 2013]

Technical considerations relevant to applicability

This technique is already implemented throughout Europe. No specific technical requirements are necessary for the application of low-protein feed diets. However, the applied levels of crude protein might differ from country to country.

The feeding of low-protein diets can reduce the animals' heat production caused by various physiological processes. This is considered to be an advantage, particularly in Mediterranean Member States during hot summers. This effect is even more pronounced with lactating sows. In general, pigs are not sensitive to dietary CP levels as long as they receive the essential amino acids in quantities and proportions appropriate to meet their requirements.

In trials by Portejoie et al. [451, Portejoie et al. 2002] dietary protein was strongly decreased from 20 % to 12 %, ammonia emissions reductions of up to 63 % were observed over the whole process and the effect on pig performance and carcass quality was negative [281, France 2010]. On the other hand, it might be argued that there is no biological limit to reducing the CP content as long as the amino acid profile is balanced and the net energy content of the pigs' diet is adapted. The reason for the aforementioned performance deterioration should be the deficiency of the amino acid valine, which was not supplemented and was found in the diet to be in a very low ratio to the amino acid lysine. Recalculation of the amino acid profile based on the INRA tables (2004) showed that the valine to lysine ratio in the 12 % CP diet was too low (58 %) compared to the recommended ratio of at least 65 %.

Commercial broiler lines can become quite sensitive to reductions in protein levels. In many commercial diets that are already well optimised with regards to protein content, further crude protein reductions could compromise certain amino acid levels, which are difficult to balance with synthetic amino acids that are not available at commercial prices. The resulting amino acid deficiency would have a negative effect on the animal growth rates. It has been reported that any further crude protein reductions in UK diets are most likely to compromise valine levels and, therefore, affect animal growth.

For UK conditions, poultry nutritionists advise that for laying hens aged 18 to 40 weeks, tryptophan, which is not added in the feed, is also a limiting amino acid. Therefore a crude protein level of 15.5–16.5 % is not technically achievable and under UK conditions a higher crude protein level will be needed for this class of poultry. This nutrient management approach can be implemented very readily on a large scale since:

- little investment is needed and no structural alterations are required on the farm; and
- one feed mill generally covers a large number of farms, therefore reducing individual farm formulation costs.

The optimum crude protein level will depend on local raw materials and will vary from region to region, e.g. where higher protein cereals are predominant higher protein levels will result from feed optimisation. The substitution with amino acids is possible only if cereals are also available [[624, IRPP TWG 2013](#)].

Economics

A general description on cost assessment of nutritional management is given in Section 4.3.1. For feeding low-protein diets, no special equipment has to be applied and no new investment needs to be made. Changing from conventional diets to low-protein diets may lead to a slight increase in feed costs, particularly when protein-rich feedstuffs are inexpensive. The economic benefit will obviously change depending on the relative cost of ingredients; in general, when protein-rich feedstuffs have high prices, as in the past few years, a decrease in feed costs is expected.

Prices of feed materials such as soybean meal and other protein-rich feedstuffs and cereals, as well as of synthetic amino acids, are subject to fluctuations that define the final feed costs. When lowering the dietary CP level, there may be an additional cost but there may be a gain as well depending on the initial feed composition, the target for lowering the NH₃ volatilisation potential and the market prices of the feed ingredients (cereals, soybean meal and other protein-rich feedstuffs) and synthetic amino acids (lysine, threonine, and methionine). When protein-rich feedstuffs have high prices, as has been the case in the past few years, a decrease in feed costs is expected. The use of other feed-grade synthetic amino acids such as tryptophan and valine allows greater reductions but can lead to an increase in feed costs [[337, Webb et al. 2005](#)]. In general, the economic costs range from EUR -2 to EUR +2 per kg of N saved [[508, TFRN 2014](#)]. Moreover, reductions in water and slurry handling costs contribute to a decrease in production costs [[290, Univ. of Newcastle 2002](#)].

An example of the calculation of the extra costs of a low-protein diet and of the effect of the price fluctuations of feed materials and amino acids in the rearing of fattening pigs is reported in Table 4.22. Figure 4.4 shows the calculated extra costs for a low-protein diet with the supplementation of synthetic amino acids in comparison to a common diet. The evolution of prices for soya and the amino acids used for the selected period is presented in Figure 4.3.

Table 4.22: Example of extra costs calculation for low-protein feeding strategies for fattening pigs

Parameters for the calculation	Values
Reference diet	
Phase 1 CP level (20–60 kg)	19 %
Phase 2 CP level (60–100 kg)	16 %
Low-protein diet with amino acid supplementation	
Phase 1 CP level (20–60 kg)	16.5 %
Phase 2 CP level (60–100 kg)	13.5 %
Phase 1 duration (20–60 kg)	55 days
Phase 2 duration (60–100 kg)	45 days
Average feed consumption	
Phase 1 (20–60 kg)	1.4 kg/pig/day
Phase 2 (60–100 kg)	2.2 kg/pig/day
Feed conversion ratio	2.93
Occupation of the building	85 %
Cleaning and disinfection	10 days
Occupation days (20–100 kg)	124 days
Number of cycles per year	2.94 cycles/animal place/year
Production per place	294 kg per animal place per year
Extra costs ⁽¹⁾	
Low-protein diet with amino acid supplementation with unfavourable market conditions	EUR 1.61/animal place/year (EUR 5.3/t of product)
Low-protein diet with amino acid supplementation with favourable market conditions	EUR -1.92/animal place/year (EUR -6.4/t of product)
⁽¹⁾ Cost data are based on raw material costs only. The effect of hardware, manipulation, etc. is not included.	
Source: [335, Spain 2010] [500, IRPP TWG 2011] [338, Piñeiro et al. 2009]	

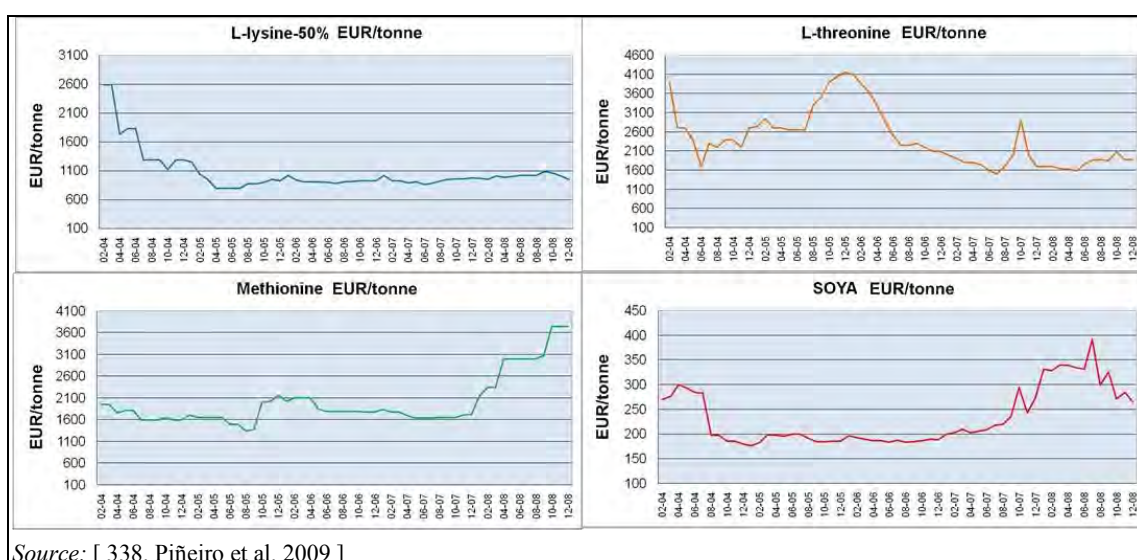

Figure 4.3: Fluctuation of synthetic amino acids and high-protein feedstuff (soya) prices from 2004 to 2008

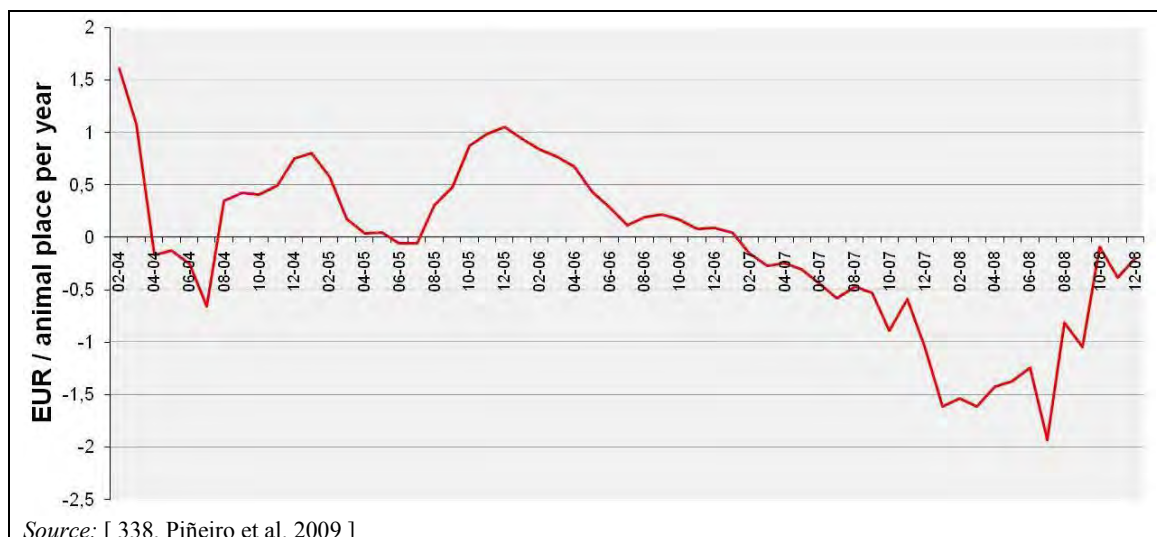

Figure 4.4: Example of the cost difference between a low-protein diet and a conventional diet in Spain

From Denmark, an increase in feed costs of between EUR 0.26 and EUR 0.39 per pig (DKK 1 = EUR 0.13) is reported when a low-protein feeding regime is applied to an already standard low-protein diet for fattening pigs achieving up to 15 % ammonia reduction [624, IRPP TWG 2013]. The cost of supplementation of amino acids increases when the target protein content in the animal feed is lowered.

Driving force for implementation

Low-protein animal feeding is one of the most cost-effective and strategic ways of reducing NH₃ emissions [508, TFRN 2014]. Along with the aim of reducing emissions, this technique is put in place for a parallel optimisation of animal performance, the health status of the animals, and feed costs. Formulating with a constraint on each amino acid allows the matching of nutrients to the animals' requirement. The reduction of protein excess in an animal's stomach also decreases the occurrence of diarrhoea. At an EU scale, reducing the utilisation of proteic raw materials allows the reduction of soybean meal imports from non-EU countries.

Example plants

Low-protein, amino-acid-supplemented diets are already used throughout Europe.

Reference literature

[34, Ajinomoto 2000] [43, COM 2003] [281, France 2010] [290, Univ. of Newcastle 2002] [312, Fefana 2010] [313, Fefana 2010] [314, Fefana 2010] [315, Fefana 2010] [316, Fefana 2010] [317, Fefana 2010] [318, Fefana 2010] [319, Fefana 2010] [320, Fefana 2010] [321, Fefana 2010] [322, Fefana 2010] [325, CRPA 2009] [326, Germany 2010] [330, Denmark 2010] [335, Spain 2010] [337, Webb et al. 2005] [338, Piñeiro et al. 2009] [379, Spain 2009] [396, LEI 1999] [414, Fefana 2001] [451, Portejoie et al. 2002] [500, IRPP TWG 2011] [508, TFRN 2014] [590, Batfarm 2013] [624, IRPP TWG 2013]

4.3.4 Addition of phytase to achieve phosphorus-balanced diets for poultry and pigs

Description

Phosphorus that is contained within phytate (phytic acid), the principal storage form of phosphorus in feed ingredients of plant origin (see Table 4.23), cannot be readily digested by monogastric animals like poultry and pigs, as they lack the appropriate enzyme activity in their digestive tract. In particular, only about 30 % of the phosphorus in feedstuffs of plant origin is digestible by pigs and poultry. Traditionally, inorganic phosphorus is supplemented to feed in order to meet the animals' nutritional needs. The addition of phytase in the diet allows the release of phosphorus from phytate, so it becomes available for digestion, thus reducing the level of supplementation of inorganic phosphorus. The reduction of phosphorus excretion is thus achieved by:

- adding phytase;
- increasing the availability (digestibility) of phosphorus in plant feed materials;
- reducing the use of inorganic phosphate in feeds.

New approaches are being developed by some plant-breeding companies and which involve developing plant varieties with high phytase activity and/or low phytic acid content [30, Spain 2001] [453, DEFRA 2011].

Table 4.23: Total phosphorus, phytate-phosphorus and phytase activity in selected plant feedstuffs

Feedstuffs	Total P (%)	Phytate-P (%)	Phytase activity (U/kg)
Maize	0.28	0.19	15
Wheat	0.33	0.22	1 193
Barley	0.37	0.22	582
Triticale	0.37	0.25	1 688
Rye	0.36	0.22	5 130
Sorghum	0.27	0.19	24
Wheat bran	1.16	0.97	2 957
Rice bran	1.71	1.1	122
Soybean meal	0.61	0.32	8
Peanut meal	0.68	0.32	3
Rapeseed meal	1.12	0.4	16
Sunflower meal	1	0.44	62
Peas	0.38	0.17	116
<i>Source:</i> [452, Fefana 2002]			

Achieved environmental benefits

The data reported below for pigs and poultry can be found in many publications on the use of phytase in feedstuffs. They provide a summary of the results obtained with different feeds and in different situations, with possible reductions presented in relative terms.

Benefits for pigs include the following:

- the inclusion of phytase in feed improves the plant phosphorus digestibility by 20 % to 30 % in weaners, and 15 % to 20 % for growers and finishers, as well as for sows;
- as a general rule, a reduction of phosphorus of 0.1 % in feed, by using phytase, results in a reduction in phosphorus excretion of 35 % to 40 % for weaners, 25 % to 35 % for growers and finishers, and 20 % to 30 % for sows.

Benefits for poultry include the following:

- The inclusion of phytase in feed improves the plant phosphorus digestibility by 20 to 30 percentage points in broilers, layers and turkeys. Variations in the results are linked with the level of phytate-phosphorus contained in the plant materials used in the diet formulation.
- As a general rule, a reduction of 0.1 % of total phosphorus in feed by using phytase results in a reduction in phosphorus excretion of more than 20 % for layers and broilers.

The improvement of phytic phosphorus digestibility can be even higher (around 50 percentage points) depending upon the feedstuff, phytase type and phytase concentration [[624, IRPP TWG 2013](#)].

Low-phosphorus, phytase-supplemented diets, as used in the trials, did not affect growth, feed conversion ratios or egg production when compared with reference diets containing a higher phosphorus concentration.

It has been shown that phytase improves not only phosphorus digestibility, but also protein digestibility [[170, Spain 2007](#)]. Moreover, as the requirement for mineral phosphates addition in the diets is reduced or eliminated, it allows the reduction of the use of scarce and non-renewable resources from P mineral reserves.

A reduction of phosphorus with the addition of phytase should be applied taking into consideration the feed formulation, in order to avoid the uncontrolled modification of the phosphorus-calcium ratio. At the farm level, no specific technical skills are needed to use low-phosphorus, phytase-supplemented feed.

Cross-media effects

The substitution of mineral phosphorus with phytase needs to be followed by a parallel reduction of calcium, in order to maintain growth and bone mineralisation at the proper level. Calcium reduction cannot be excessive in order not to limit in turn the growth rate [[281, France 2010](#)].

Environmental performance and operational data

Since phytase are feed additives, they are evaluated for their efficacy before authorisation for use in animal nutrition. The evaluation of the scientific information supporting the efficacy of phytase is carried out by the European Food Safety Authority's Panel on Additives and Substances used in animal nutrition (FEEDAP). Different types of phytase have been evaluated by the FEEDAP and their evaluation led systematically to the authorisation of these products, based on their safety and efficacy.

Phytase can be incorporated in feedstuffs in powder, granulated coated or liquid form. Powder and granulated forms are used in production processes, only where the temperature does not exceed 75–80 °C. Commercial coated forms exist that have demonstrated stability at temperatures higher than 80 °C, and up to 90 °C. At a higher conditioning temperature, the use of the liquid form (post pelleting) is advised.

Examples of the reduction of excreted diphosphorus pentoxide (P₂O₅) associated with the use of low-phosphorus diets, with or without the addition of phytase, are reported in Table 4.24 for pig production, together with an indication of the diet formulation applied.

Table 4.24: Examples of excreted phosphorus reduction for different feeding programmes in the pig sector, applying a low-phosphorus diet with or without addition of phytase

Animal	Source	Diet/parameters	P ₂ O ₅ reduction (¹) (%)
Weaners	France CORPEN 1	Two phases: CP 20 %; P 0.85 % (1 st phase) CP 18 %; P 0.70 % (2 nd phase)	11
	France CORPEN 2	Two phases: CP 20 %; P 0.77 % (1 st phase) + phytase CP 17 %; P 0.60 % (2 nd phase) + phytase	29
	Germany RAM	One phase CP 18 %; P 0.55 % (< 30 animal weight)	22
	Belgium (Flanders)	One phase: P 0.60 % (7–20 kg animal weight)	31
Fattening pigs	France CORPEN 1	Two phases: CP 16.5 %; P 0.52 % (growers) CP 15.0 %; P 0.45 % (finishers)	31
	France CORPEN 2	Two phases: CP 15.5 %; P 0.47 % + phytase (growers) CP 13.0 %; P 0.40 % + phytase (finishers)	44
	Germany RAM	Two phases: CP 17.0 %; P 0.55 % (< 60 kg of LW) CP 14.0 %; P 0.45 % (> 60 kg of LW)	29
	Belgium (Flanders)	Two phases: P 0.55 % (20–40 kg animal weight) P 0.50 % (40–110 kg animal weight)	19
Sows	France CORPEN 1	Two phases: CP 16.5 %; P 0.65 % (lactation) CP 14.0 %; P 0.50 % (gestation)	21
	France CORPEN 2	Two phases: CP 16.0 %; P 0.57 % + phytase (lactation) CP 12.0 %; P 0.42 % + phytase (gestation)	35
	Germany RAM	Two phases: CP 16.5 %; P 0.55 % (lactation) CP 14.0 %; P 0.45 % (gestation)	21
	Belgium (Flanders)	Two phases: P 0.55 % (20–40 kg animal weight) P 0.50 % (40–110 kg animal weight)	19
<i>Source:</i> [414, FEFANA 2001] [329, CORPEN 2003]			

Technical considerations relevant to applicability

On farm, no specific additional requirements are needed for the application of low-phosphorus, phytase-supplemented diets compared to a high-phosphorus diet, when applied under the same conditions (one-phase or multiphase feeding programmes).

This approach to reducing phosphorus pollution can be implemented very readily on a large scale as:

- no investment is needed for powder and granulated phytase, although some investment is needed in feed mills using liquid phytase;
- no structural alterations are required on the farm;
- one feed mill generally covers a large number of farms [452, Fefana 2002].

Phytase may not be applicable in the case of organic livestock production.

Economics

For feeding low-phosphorus, phytase-supplemented diets, there is no need for any special equipment at the farm level or any additional investment. Furthermore, adaptation of the feed, by addition of phytase and adaptation of the nutrient levels, can lead to a reduction of the feed costs [452, Fefana 2002]. Phytase is cost-effective for a reduction of the total phosphorus in the feed of about 15–20 % of its content (0.1 % in the raw feed), with savings of up to EUR 0.88 per tonne of feed (exchange rate EUR 1 = GBP 0.88) [290, Univ. of Newcastle 2002].

Driving force for implementation

The reduction of phosphorus in diets reduces not only the feed costs, but ultimately also reduces the land surface requirements for manure spreading, since the phosphorus load in the excreta is smaller. Limitations to phosphorus application on the fields are in place in some MS.

Example plants

The addition of phytase is a well-established technique and is generally applied.

Reference literature

[30, Spain 2001] [170, Spain 2007] [281, France 2010] [290, Univ. of Newcastle 2002] [329, CORPEN 2003] [414, FEFANA 2001] [452, Fefana 2002] [453, DEFRA 2011] [624, IRPP TWG 2013]

4.3.5 Highly digestible inorganic feed phosphates

Description

Phosphorous digestibility is improved by using an increased amount of highly digestible inorganic phosphates in diets. Inorganic feed phosphates are classified as mineral feed ingredients. They are listed in the catalogue of feed materials published in accordance with EC Regulation 767/2009 on the marketing of feed. These feed phosphates differ with respect to their mineral content and their chemical composition and as a result they have different phosphorus digestibilities. Highly digestible phosphates are used to replace conventional sources of phosphorus in the feed.

Feed phosphates are incorporated into animal feed either in powder or in granulated form, depending on the physical properties of the end product. Inorganic feed phosphates are predictable in terms of their chemical composition and in their digestible phosphorus content, partly because they are not susceptible to process conditions (such as heat or moisture).

Achieved environmental benefits

The reduction of the total amount of phosphorous in the feed formulation results in a reduction of P excretion and subsequent losses to the environment.

Cross-media effects

There are no cross-media effects of the use of highly digestible phosphorus, as the reduction of excretion is a direct consequence of the phosphorus digestibility. There is no impact on phytate-bound phosphorus excretion, which transits unabsorbed and is then kept in the manure. However, it should be considered that supplies of the highest digestibility feedstuffs might become insufficient to cover the overall market need for animal feed, particularly when phosphorus supplies are tight.

Environmental performance and operational data

Table 4.25 gives an example of reduced phosphorous excretion by the use of highly digestible feed phosphates. The same type of calculation can be applied for pigs, resulting in the same reduction in phosphorus excretion.

Table 4.25: Calculated reduction of phosphorus excretion based on digestibility, for the poultry sector

Feed phosphate	Digestibility (%)	Inclusion rate (%)	Inclusion rate (g P)	Absorbed P ⁽¹⁾ (g)	Excreted P ⁽¹⁾ (g)
Defluorinated phosphate	59	1.56	28.0	16.5	11.5
Monocalcium phosphate	84	0.87	19.6	16.5	3.1

(1) Originating from the inorganic feed phosphate.
Source: [542, CEFIC 2002]

From Denmark, a nutritional system for fattening pigs is reported aiming to reduce phosphorus emissions. This system is a combination of the following combined techniques:

- a higher phytase concentration (1.5 times the standard dose);
- addition of monocalcium phosphate;
- phase feeding with levels of phosphorus in feed around 0.47 % for pigs of 25–50 kg and 0.45 % for pigs of 50–110 kg.

Compared with a typical feeding strategy (addition of dicalcium phosphate and one-phase feeding with 0.63 % P in the feed), the above combination results in a reduction of 17–18 kg of P applied per hectare. The cost of the above combined nutritional strategy is reported as EUR 0.067 per pig produced [650, Denmark 2010].

Technical considerations relevant to applicability

The use of highly digestible feed phosphates can be implemented very easily. No investments are needed, either at the farm level or at the feed compounder level [542, CEFIC 2002].

Economics

A general description on the cost assessment of nutritional management is given in Section 4.3.1. No cost increases for the farmer are involved for the change to the use of highly digestible inorganic feed phosphates. Feed phosphates are normally sold based on the total phosphorus content. Highly digestible inorganic feed phosphates are, in fact, calculated on the digestible phosphorus content, and economy of use over other feed phosphates.

Less phosphorus is excreted, resulting in lower manure processing costs for the farmer. Depending on the inorganic phosphorus availability, the price of these sources of phosphate is highly volatile and can lead to an increase of feed prices, and to inorganic phosphorus becoming expensive [542, CEFIC 2002]. When a combination of techniques is used, the amount of phytase added depends on the market price of phytase and monocalcium phosphate. The cheapest combination is chosen [650, Denmark 2010].

Driving force for implementation

Phosphorus is a pollutant that locally raises particular concerns and it may be subject to strict compliance requirements.

Example plants

Some feed producers and farms in regions which have environmental problems because of the high concentration of intensive animal rearing have already started to use more digestible inorganic feed phosphates. Notably, this has taken place in the Netherlands, where there was no negative impact on animal performance, but there was a positive effect on phosphorus excretion [542, CEFIC 2002].

Reference literature

[542, CEFIC 2002] [650, Denmark 2010]

4.3.6 Other feed additives

Description

Enzymes and other authorised feed additives are added in small amounts to the feed in order to enhance the animal performance by improving the digestion of nutrients and the utilisation of feed. As a consequence, animals achieve higher growth rates and/or an improved feed conversion ratio and a reduced amount of nutrients is excreted. Feed additives that are added in small amounts to the feed of poultry and pigs are:

- enzymes (xylanases, glucanases, proteases, etc.);
- growth enhancers (non-antimicrobial);
- microorganisms;
- organic acids.

Several groups of feed additives used in animal nutrition are authorised and regulated at the European Union level (e.g. animal species, withdrawal period, minimum and maximum dosage in feeds). Annex I to EC Regulation 1831/2003 of September 2003 reports a list of feed additive groups, many of them not included in this section since their use is not associated with specific environmental benefits. This is particularly the case for many technological and sensory additives. Commission Regulation (EC) 429/2008 lays down the implementing rules for ensuring the efficacy of a feed additive in terms of its environmental performance.

Achieved environmental benefits

As a consequence of the improved feed conversion rate, a reduction of the total nutrients excreted by pigs (as a general approximation) of 3 % can be achieved; for poultry this can be approximately 5 %. These reductions are expected at an improvement in the feed conversion rate of 0.1 units [543, Fefana 2002].

Certain additives, such as enzymes, may also allow the use of feed materials of a lower energy content and a high non-starch polysaccharides content in the feed, with a positive influence on gut health in pigs.

Cross-media effects

No specific cross-media effects have been reported. Conditions for authorisation of feed additives according to Article 5 of Regulation (EC) 1831/2003 require that they do not have an adverse effect on animal health, human health or the environment.

Environmental performance and operational data

Information and data concerning the use of different feed additives are reported in the specific sections (see Sections 4.3.6.1, 4.3.6.2, 4.3.6.3, and 4.3.6.4).

Technical considerations relevant to applicability

Feed additives (e.g. enzymes) are incorporated into feedstuffs in powder, granulated, coated or liquid form. Powder and granulated forms are to be used in production processes, only where the temperature is not too high (up to 80–85 °C). Coated forms can be used at higher temperatures, up to 90–95 °C.

Stability performance may vary from one product to another, hence information on the stability may be requested from the supplier. Liquid feed additives are applicable when processes lead to high temperatures in the die by means of specific equipment that supply the product after pelletisation. Some feed mills are already equipped with such systems.

There are no specific additional requirements for the application of feed additives on the farm. This approach to reducing nutrient excretion can be implemented very readily on a large scale as:

- no investment is needed for powder and granulated feed additives, although some investment is needed in feed mills using liquid additives;
- no structural alterations are required on farm;
- one feed mill generally covers a large number of farms [543, Fefana 2002].

Economics

A general description of the cost assessment of nutritional management is given in Section 4.3.1. The introductory cost is generally covered by better animal performance [543, Fefana 2002].

Driving force for implementation

The optimisation of animal performance, together with a potential positive effect on animal health and a reduction of the excreted nutrients, are the main driving forces for the use of these additives.

Example plants

Feed additives are generally used in intensive animal production.

Reference literature

[543, Fefana 2002]

4.3.6.1 Benzoic acid

Description

Benzoic acid is mainly added to feed and it is degraded in the animal to hippuric acid, which lowers the urine pH and consequently the pH of the slurry stored in the pig house. The use of benzoic acid (C_6H_5-COOH) as a zootechnical additive is covered by Regulation (EC) 1831/2003.

Achieved environmental benefits

At the lower pH, ammoniacal nitrogen is retained in solution and, consequently, is expected to volatilise less ammonia. However, not all evidence suggests that there is a reduction in ammonia emissions, even though benzoic acid is effective at reducing urinary pH [664, EFSA 2007].

Since a lower pH reduces the activity of bacteria responsible for methanogenesis, it can be expected that direct CH_4 emissions from the manure will be reduced as well. However, trials with 1 % addition have shown that benzoic acid has no direct effect on odour or greenhouse gas emissions [288, Wageningen 2007] or the effect is not significant (17 % reduction for odour emissions after 1 % addition of benzoic acid) [651, DAFC 2010].

An addition of 0.5 % benzoic acid to the feed in fattening pig production has been reported as having a positive influence on the digestion of nutrients and the utilisation of feed. In particular, a statistically significant reduction of 0.14 is reported for the feed conversion ratio for the whole period of fattening observed in the finishing period [281, France 2010]. However, in other trials with the addition of 0.5 % or 1 % benzoic acid, these improvements have been found to be insignificant [284, Guingand et al. 2005].

Because more nitrogen can be retained in the manure, it may lead to a reduced consumption of mineral fertilisers and lower indirect emissions (associated with the production of the fertilisers).

Cross-media effects

Since a relatively higher quantity of nitrogen is retained in the manure, the subsequent changes in the manure composition in the proceeding operations must be taken into consideration, from higher nutrient supply to an increased potential for NH₃ and GHG emissions from landspreading. As the addition of benzoic acid is relatively high (from 0.5 % to 1.0 %), this has to be taken into account when formulating the feed, to avoid the nutritional value of the feed being reduced.

An increase of sulphur-based odour emissions has been reported for higher doses (2 %) of benzoic acid for diets supplemented with methioanine [454, Eriksen et al. 2010].

Environmental performance and operational data

Many research studies have been carried out on this substance, and results are varied. Most of the studies evaluate positively the environmental effects which are summarised in Table 4.26. Data reported show that the addition of benzoic acid is consistently associated with lower urine pH. Additional information concerning other important characteristics and the results of the trials, in particular the average dietary protein content or the difference in cost compared to the untreated feed, are reported in the table. Effects on the average daily weight gain performance, the feed conversion rate performance, and on the carcass quality have been reported as not significant or having a positive effect. Only in one case, with 1 % benzoic acid addition, has a negative effect on the carcass quality been reported.

Table 4.26 shows that the addition of benzoic acid at a concentration of 1.0 % can reduce the ammonia emissions from the housing system. The reduction varies from 6 % to 24 %, depending on the operating conditions. For an addition of 0.5 % of benzoic acid in the feed, an ammonia reduction potential of 3.6–5 % is reported.

Measurements carried out in Denmark with an addition of 1 % benzoic acid in feed for fattening pigs revealed reductions in ammonia emissions of 7.5 % and 14 % respectively. The effect of benzoic acid on ammonia emission reduction was independent of the dietary protein, while no statistical significant difference was found for the slurry pH [651, DAFC 2010] [652, DAFC 2012].

Table 4.26: Measured results of benzoic acid effects by rate of addition and by the characteristics of the tests in growing and finishing pigs

Benzoic acid in feed 0.5 % (0.5 % in 1st phase; 0.5 % in 2nd phase)		
Source	Diet	Test results ⁽¹⁾ ⁽²⁾
[283, Guingand et al. 2005]	Two-phase feeding: CP 16.6–15.1 %	NH ₃ reduction: 5 % Δ pH urine: 0.45 Additional costs: EUR 7.7 per animal place
[284, Guingand et al. 2005]	Two-phase feeding: CP 16.6–15.5 %	NH ₃ reduction: 3.6 % Δ pH urine: 0.3 Additional costs: EUR 7.93 per animal place
[285, Fefana 2004]	Three-phase feeding: CP 18.0–16.4–15.0 %	NH ₃ reduction: 40 % Δ pH urine: Not available Additional costs: EUR –2 per animal place ⁽³⁾
Benzoic acid in feed 1 % (0.5 % 1st phase; 1 % 2nd phase)		
[284, Fefana 2005]	Two-phase feeding: CP 16.6–15.5 %	NH ₃ reduction: 24 % Δ pH urine: 0.9 Additional costs: EUR 11.74 per animal place
[288, Wageningen 2007] [282, Netherlands 2010]	Two-phase feeding: CP 17.0–16.0 %	NH ₃ reduction: 21 % Δ pH urine: 0.96 Additional costs: EUR 6.94 per animal place
	Two-phase feeding: CP 18.1–15.5 %	NH ₃ reduction: 13 % Δ pH urine: 1.30 Additional costs: EUR 8.1 per animal place
	Two-phase feeding: CP 18.1–15.0 %	NH ₃ reduction: 6.4 % Δ pH urine: 1.72 Additional costs: EUR 7.3 per animal place
	Two-phase feeding: CP 18.1–16.2 %	NH ₃ reduction: 6.4 % Δ pH urine: 1.39 Additional costs: EUR 9.36 per animal place
Benzoic acid in feed 1 % One-phase feeding		
[651, DAFC 2010]	CP 17.5 % and CP 14.5 %	NH ₃ reduction: 7.5 % Δ pH urine: 0.56 (CP 17.5 %) – 1.15 (CP 14.5 %) Additional costs: EUR 2.6 per pig (DKK 1 = EUR 0.13)
[652, DAFC 2012]	CP 17.5 %	NH ₃ reduction: 14.5 %
⁽¹⁾ Feed costs calculated based on March 2010 prices and for pig places at farms from 2.8 to 3.5 pigs/year.		
⁽²⁾ Δ pH urine refers to the difference between untreated and treated urine.		
⁽³⁾ The figure refers to a reduction in the feed cost of EUR 2.00/animal place.		

An assessment made by EFSA for the authorisation of benzoic acid as a feed additive for pigs for fattening concluded that the efficacy of benzoic acid to reduce ammonia emission is not straightforward even though benzoic acid was consistently effective at reducing urinary pH in pigs for fattening. Not all submitted studies provided evidence of a significant reduction at the highest level of 10 000 mg benzoic acid per kg of feed, while the lower dietary level of 5 000 mg per kg was not effective in all studies [664, EFSA 2007].

Technical considerations relevant to applicability

At the time of writing (2013), benzoic acid is authorised in the EU to be used as a zootechnical feed additive belonging to the functional group ‘other zootechnical additives’ for improving the animal performance, for weaners (Regulation 1730/2006/EC) and pigs for fattening (Regulation 1138/2007/EC) in doses of 5 000 mg/kg and between 5 000 mg/kg and 10 000 mg/kg of complete feedstuff, respectively.

Economics

Data for the cost variations of feed with the addition of the related percentage of benzoic acid are reported in Table 4.26, expressed per pig place. This technique does not lead to additional investment costs. The addition of benzoic acid in feed is normally done by the feed millers and does not require any specific equipment for the farmers.

Driving force for implementation

In comparison with other techniques for ammonia reduction, the addition of benzoic acid to pig feed appears to be easier and less expensive [281, France 2010]. The technique is considered a best available technique for the reduction of ammonia emissions in the Netherlands.

Example plants

Industrial organisations report that benzoic acid use for pig feeding is increasing.

Reference literature

[281, France 2010] [282, Netherlands 2010] [283, Guingand et al. 2005] [284, Guingand et al. 2005] [285, Fefana 2004] [288, Wageningen 2007] [454, Eriksen et al. 2010] [651, DAFC 2010] [652, DAFC 2012] [664, EFSA 2007]

4.3.6.2 Probiotics

Description

Probiotics are microorganisms that may favourably affect feed efficiency.

Bacillus organisms are specifically selected to improve growth performance and manure decomposition. *Bacillus* species produce extracellular degrading enzymes (amylases, cellulases, lipases, proteases, etc.). The addition of these microbes in pig feed provides a source of enzymes to animals, improving the nutrient digestion and the utilisation of feed, and thereby improving feed efficiency. These enzymatic activities are a likely explanation of the faster dispersion of manure in pens where pigs are fed with *Bacillus*. In fact, spores survive through the digestive process and germinate within the digestive tract, so that mature microbes are excreted with faecal matter and can also produce an enzymatic effect in the external environment. *Lactobacillus* and *Enterococcus faecium* rapidly install in animal intestines and improve the sanitary state and the growth performance.

Achieved environmental benefits

The enhanced animal performance in feed conversion reduces the excretion of nitrogen and phosphorus, since more nutrients are retained in the animal bodies. However, the scientific evidence is not all conclusively positive on the consistent effectiveness of probiotics. Some test results showed that growth performance, feed conversion ratios and mortality were not significantly different after the use of probiotics in broilers [477, O'Dea et al. 2006].

The improved manure degradability induced by *Bacillus* improves pen cleaning, as it reduces the time taken to disperse the manure mat.

Cross-media effects

No negative effects are reported.

Environmental performance and operational data

Bacillus subtilis and *Bacillus licheniformis* strains are added in the feed at rates of around 0.05 % of a dietary supplement that contains some 10^{e+8} – 10^{e+9} cfu/g of product. *Enterococcus faecium* NCIMB 10415 is provided in doses of $7.0 \times 10^{e+8}$ cfu/kg of feed for sows and starter diets, and in doses of $3.5 \times 10^{e+08}$ cfu/kg of feed for grower and finisher diets. For both *Bacillus* and *Enterococcus*, improvements of the feed conversion rates are reported to be in the range of 0.37–0.38.

The effect of these probiotics is a reduced excretion of nitrogen and phosphorus, due to the increased efficiency of the feed conversion. The estimated effects in pigs are displayed in Table 4.27.

Table 4.27: Reductions in excretion with the direct-fed microbial strains in pigs

Microbial strains	Excreted nitrogen			Excreted phosphorus (P ₂ O ₅)		
	g of N per kg of LW	kg of N per sow per year	kg of N per pig	g of P ₂ O ₅ per kg of LW	kg of P ₂ O ₅ per sow per year	kg of P ₂ O ₅ per pig
Lactobacillus ⁽¹⁾	-1.15	-2.29	-0.12	-0.65	-2.02	-0.068
Enterococcus ⁽²⁾	NI	-2.86	-0.147	NI	-2.52	-0.085

NB: Comparisons are made with the same diets without additives. Type of data = measured data, based on statistical analysis. NI = no information provided.

Source:
⁽¹⁾ [301, Fefana 2010]
⁽²⁾ [302, Fefana 2010]

The effect of *Lactobacillus* on broilers may vary depending on the combination of the dose and the protein content in the diet. An example is reported in Table 4.28, where the effects on finishing broilers are displayed for different doses mixed with different levels of dietary content of protein and minerals (Ca and non-phytin phosphorus). The average reduction of total nitrogen in excretion is 7.2 %. Some of these *Lactobacilli* are registered as silage additives.

Table 4.28: Reductions in excretion with the direct-fed microbial strains of lactobacillus in finishing broilers

Type of diet	Age (days)	Probiotic dose (kg/tonne)	Reduction in total nitrogen (g/bird)	Reduction in P ₂ O ₅ (%)
Classic high level protein (19 %)	28–42	0.9	-0.54	-3.2
Medium level protein (17.3 %)	28–42	0.9	-4.1	-7.0
Medium level protein (16.8 %)	32–42	0.95	-0.8	-8.2
Medium level protein (17.0 %), low Ca, low non-phytin P	32–42	0.45	-1.6	-2.7

NB: Comparisons are made with the same diets without nutritional additives.
Type of data = measured data, based on statistical analysis.
Source: [303, Fefana 2010]

Table 4.29 shows the feed conversion rates obtained with a 2 kg dose of commercial probiotics per tonne of feed for broilers. The average reduction of total nitrogen in excretion is 7.1 %.

Table 4.29: Gains in FCR and value of ingested feed with the use of probiotics in broilers

	Test feed without probiotic addition	Feed with added <i>Lactobacillus</i>	Feed with added <i>Bacillus</i>	Feed with added <i>Pediococcus</i>
Feed conversion rate	0.408	0.510	0.476	0.427
Economic gain per bird (above feed cost)	0	+35.9 %	+23.7 %	+6.2 %

Source: [306, Fefana 2010]

Technical considerations relevant to applicability

Probiotics can be easily added to diets for poultry meat. Probiotics are also easily mixed in feed for gestating sows, lactating sows, weaners and fattening pigs. *Lactobacillus* effects in turkeys

are in the line with those of broilers. Protection from pathogens (*Salmonella*) has been demonstrated [307, Fefana 2010]. This technique is only applicable to authorised preparations according to Regulation (EC) 1831/2003 which improve feed digestibility leading to a reduction of nutrient excretion.

Economics

The increased efficiency in feed transformation into meat returns a higher economic gain due to the saved feed, as is reported in Table 4.29.

Driving force for implementation

Probiotics are also used to improve animal welfare by limiting pathogenic intestinal colonisation. This effect basically enhances the productive performances through increased nutrient retention. Consequently, a positive effect on piglet mortality (around 40 % fewer deaths) is produced, as well as a greater resistance to bone breaks in poultry.

Example plants

The use of probiotics has increased significantly in the EU over the last 10 years, in particular after the ban of the use of antibiotics as growth promoters. The actual use of these additives varies by type of animal, by country and by customer requirements. The rate of penetration in the pig feed market is estimated by production companies at 10 % on average, with peaks of 20 % for liquid feeds and up to 40–50 % in specific countries. For the poultry feed market, the penetration of this product is estimated to be from 8 % for layers to 10 % for broilers and up to 15–20 % for turkeys [472, Fefana 2011].

Reference literature

[301, Fefana 2010] [302, Fefana 2010] [303, Fefana 2010] [306, Fefana 2010] [307, Fefana 2010] [472, Fefana 2011] [477, O'Dea et al. 2006]

4.3.6.3 Enzymes

Description

When the feed quality is low (high fibre content and low digestibility of the feed), enzymes may help to increase the digestibility. When feed digestibility decreases (e.g. at high non-starch polysaccharide levels - NSP), nutrient excretion is increased. The non-starch polysaccharide degrading enzymes (NSP enzymes), such as xylanases, cellulases and glucanases, are incorporated into the animal feed to allow the breakdown of NSP and, therefore, to achieve a faster and more complete digestion of the feed, leading to an improved nutritional value. Additionally, the enzyme protease is supplemented with the feed to increase the digestibility of the protein contained in the plant feed materials.

The use of NSP enzymes and proteases allows the digestibility of a number of feedstuffs with low digestibility to be increased, although this beneficial effect is demonstrated to be dependent on the wheat cultivar used [485, Gutierrez del Alamo et al. 2008]. The effect of the cultivar applies to most of the cereals [624, IRPP TWG 2013].

Enzymes can be used individually or in combination; their synergistic effect depends on the diet [281, France 2010]. The efficacy of enzymes as digestibility enhancers for pigs and poultry (see the Register of Feed Additives pursuant to Regulation (EC) 1831/2003) has been favourably assessed.

Achieved environmental benefits

Lower protein contents in feed normally result in lower nitrogen excretion and lower ammonia emissions. Therefore, practices that allow a reduction of the crude protein content in feed, either by increasing the protein digestibility, as in the addition of the enzyme protease, or increasing the global animal performances (e.g. feed conversion), can in turn reduce ammonia emissions.

The use of feed enzymes often reduces the digestibles' viscosity by degrading non-starch polysaccharides (NSP), thereby decreasing the moisture content of the faeces. Subsequently this results in a reduction of the potential development of fermentation in poultry litter, and thus a decrease in ammonia emissions [543, Fefana 2002].

Cross-media effects

No cross-media effects have been reported.

Environmental performance and operational data

Poultry

The response of individual added enzymes may be dependent on the composition of the diet [479, Bedford et al. 2011] [481, Thacker 2005]. An improved protein digestibility for a wide range of natural ingredients is reported to be in the range of 3–8 % when protease is added to broiler diets [573, DSM et al. 2012].

The effect of mixtures of protease, xylanase and phytase is a higher retention of nitrogen than with enzyme-free feed. Higher amounts of nitrogen can be retained, hence lower amounts of nitrogen are excreted, due to the better digestion efficiency (see Table 4.30).

Table 4.30: Average daily balance of nitrogen in broilers with and without the addition of feed additives (enzymes)

Nitrogen (g/bird)	Control feed (no enzymes)	Feed with added NSP enzymes	Variation in nitrogen (%)
Ingested N	124.62	123.75	-0.7
Fixed N	68.52	71.63	+4.5
Excreted N	56.10	52.12	-7.1

Source: [305, Fefana 2010]

According to some authors, the use of enzymes is beneficial only during the first phase of growth. The effectiveness of additives is summarised in Table 4.31, where the positive effect is shown with a '+' sign, and a '-' sign indicates no significant effect in that given stage.

Table 4.31: Effect of different additives in poultry at various feeding stages

Animal	Type of additive	1-phase	2-phase	3-phase
Laying hen	Coccidiostatic	-	-	-
	NSP enzyme	-	+	+
	Phytase	+	+	+
Broiler	Coccidiostatic	+	+	-
	NSP enzyme	+	-	-
	Phytase	+	+	+
Duck	Coccidiostatic	-	-	.
	NSP enzyme	+	+	.
	Phytase	+	+	.
Turkey starter	Coccidiostatic	+	+	.
	NSP enzyme	-	+	.
	Phytase	+	+	.
Male turkey	Coccidiostatic	+	+	+
	NSP enzyme	+	+	+
	Phytase	+	+	+
Female turkey	Coccidiostatic	+	+	-
	NSP enzyme	+	+	+
	Phytase	+	+	+

Source: [327, Germany 2010]

Xylanases are added to commercial wheat-based compound feed for broilers in order to improve the growth and the feed conversion ratio. At the same time, the intestinal viscosity and the quantity of nutrients excreted are reduced [478, Sieo et al. 2005]. The combined provision of xylanase, amylase and protease improves the utilisation of feed and increases the body weight by approximately 6 % to 7 %. By improving the digestibility of some nutrients, enzymes might also improve the performance of broilers that are fed with suboptimal diets for Ca and P [482, Cowieson et al. 2005] [483, Cowieson et al. 2010].

Supplementation of glucanase strains in chicken diets can reduce the intestinal viscosity by 21 % to 46 % (compared to an unsupplemented feed diet) [478, Sieo et al. 2005]. Protease-supplemented diets can produce improvements in weight gain and the feed conversion rate [479, Bedford et al. 2011] [480, Yu et al. 2007] [481, Thacker 2005]. In commercial products in Germany, the enzyme activity ranged from 280/125 TXU/TGU to 560/250 TXU/TGU (xylanase/glucanase) per kg of complete feed [327, Germany 2010].

Pigs

A study carried out in Denmark calculated that the addition of a NSP enzyme (xylanase) in feeds for fattening pigs, due to the increase of digestibility, allows the modification of the nutritional characteristics of the feed by decreasing protein levels or by improving the animal performance (e.g. feed conversion ratio). Modelled results showed that, with the use of NSP enzymes, the crude protein level was reduced from 16.59 % to 15.35 % (1.24 points of CP or 7.8 % less compared to the untreated diet), feed consumption decreased by 2.5 % while feed efficiency (FCR) improved from 2.89 to 2.83. Calculations showed that the total N excreted was reduced by 6.2 g/kg of live weight and the quantity of manure was reduced by 0.012 kg/kg of live weight [304, Fefana 2010].

Technical considerations relevant to applicability

Only authorised feed additives according to Regulation (EC) 1831/2003 are applicable. The technique is generally applicable to pigs and poultry. It can be used alone or in combination with other nutritional measures (e.g. industrial amino acid addition, phase feeding) for further reductions in excreted nitrogen [573, DSM et al. 2012]. The response of individual added enzymes may be dependent on the composition of the diet, its activity and the origin of its strains [479, Bedford et al. 2011] [481, Thacker 2005] [281, France 2010].

Economics

The addition of enzymes to broiler feed adds costs equivalent to that of less than 1 % of the untreated feed, on average. On this basis, in the case of broiler production, feed costs increase by 0.3 %, from EUR 6.78 per broiler place per year, (untreated feed) to EUR 6.80 with added enzymes. Cost savings are also feasible, depending on the market prices of protein-rich feed ingredients [305, Fefana 2010]. Cost savings of EUR 2 to EUR 6 per tonne of feed are reported for the addition of protease to broiler diets [573, DSM et al. 2012].

Driving force for implementation

The local availability of economical feed of relatively poor digestibility is a driving force. Xylanase enzymes are convenient, most with fibre-rich feed. The use of enzymes allows a higher incorporation into the diets of feed materials with lower digestibilities. Therefore, it may allow the use of locally grown feed materials and by-products and, in turn, contribute to the reduction of costs for the compound feeds.

Example plants

This feeding strategy is already applied in pig and poultry production and can be used in any production process and does not lead to additional investments. The addition of enzymes in feed is done by the feed millers and does not require any specific equipment for farmers.

Reference literature

[304, Fefana 2010] [305, Fefana 2010] [281, France 2010] [327, Germany 2010] [478, Sieo et al. 2005] [479, Bedford et al. 2011] [480, Yu et al. 2007] [481, Thacker 2005] [482, Cowieson et al. 2005] [483, Cowieson et al. 2010] [485, Gutierrez del Alamo et al. 2008] [543, Fefana 2002] [573, DSM et al. 2012] [624, IRPP TWG 2013]

4.3.6.4 Phytogenic feed additives

Description

Phytogenic feed additives are products that are standardised for their plant-derived active ingredients and are used in animal nutrition mainly with the objective of improving performance and the health of the animals. Active ingredients from *Oreganum vulgare*, *Piper Nigrum*, *Syzygium aromaticum*, *Thymus vulgaris*, *Yucca schidigera* and *Quillaja saponaria* have proven effects on the stabilisation of animals' intestinal microflora. The specific effects are:

- an antagonistic activity to many subcultures of pathogenic enterobacteria, such as *C. perfringens* or *E. coli*, *S. typhimurium*, *L. monocytogenes*, *Y. enterocolitica* or of *S. aureus*;
- improvement of animal metabolism by increased blood circulation (pungent substances);
- reinforcement of the immune system, of the growth and reproductive performance by a better permeability of intestinal cell walls;
- inhibition of the activity of the urease enzyme and thus reduction of ammonia volatilisation (saponins).

The standardisation of the active ingredients and dosage recommendations of these additives are the basis for achieving reproducible results in animal nutrition. The leading substances are defined by product specification.

Achieved environmental benefits

Due to the increased secretion of digestive juices, raw protein is increasingly digested in amino acids which are absorbed at a greater rate. Furthermore, animals achieve higher rates of growth, more raw protein is used for meat and, consequently, reduced amounts of excess protein are excreted through faeces [331, Raumberg 2010].

Saponins contained in the products reduce the activity of the urease enzyme, which is formed by bacteria in the large intestine and which decomposes urea into ammonia and carbon dioxide. The inhibition of activity leads to a lower production of ammonia.

However, it is also reported that the consistent effectiveness on ammonia emissions remains unproven, resulting in uncertainty regarding their performance. The available experiment results report data concerning commercial products made from blends of different phytogenic substances. Data on the efficacy of each type and dose of the active compounds contained in the commercial products and their possible interactions with other feed ingredients are not yet available [484, Windisch et al. 2008].

Cross-media effects

No cross-media effects have been reported.

Environmental performance and operational data

In poultry, reductions of indoor ammonia concentrations from 14.4 % to 53.8 % (compared to untreated feed) have been reported, along with an improvement in feed conversion of 2 % and final body weight of 3.2 % [332, Delacon 2010] [333, Delacon 2010].

In another study for fattening pigs carried out in Austria, the effectiveness of a phytogenic feed additive on the reduction of gaseous emissions as well as the effects on animal performance were investigated in one trial. The results report the content of nitrogen (both total N and NH₄-N) in the manure was reduced by 60 % compared to that excreted by pigs that are fed with untreated feed, and a consequent decrease in ammonia concentrations in houses of around 38 % and 34 % for odours [331, Raumberg 2010].

Similar results have been reported for the addition of two similar phytogetic additives based on ethereal oils and saponins to the feed of fattening pigs, with a reduction in the ammonia concentration in the house in the range of 32–38 % [458, Veit et al. 2011]. However, another investigation of fattening pigs in Denmark on the effect of an additive based on a comparable active compound did not show any significant effect on ammonia emissions [632, DAFC 2010].

Tests carried out on lactating sows and piglets indicate that body weight loss is decreased in sows fed with phytogetic additives compared to sows fed without supplementation. Test results vary from 33 % to 67 %, depending on the type of product. Also, the body weight gains of piglets were found to be significantly improved when diets of lactating mothers were supplemented from day 90 of gestation to day 25 postpartum [455, Männer 2011].

Technical considerations relevant to applicability

Only authorised feed additives according to Regulation (EC) 1831/2003 are applicable. No particular management is needed, other than mixing additives in feed. The technique is generally applicable to both poultry and pigs.

Economics

Costs of phytogetic feed additives in broilers range between EUR 0.06 per place per year, if performance benefits are not accounted for, and EUR -0.05 per place per year (a profit), if benefits are taken into account [380, Delacon 2011]. In pigs, costs range between EUR 2.10 per place per year, if benefits are not accounted for, and EUR -1.92 per place per year (a profit), if benefits are taken into account [456, Delacon 2011].

Driving force for implementation

The environmental benefits are a consequence of better performances that do not affect either slaughter performance or carcass quality.

Example plants

In 2010, across the EU, at least 427 million broilers were fed with the addition of one brand of natural phytogetic additive, mainly for performance improvement. In particular, about 80 % of broilers in Czech Republic and 60 % in the Netherlands were fed with supplemented diets [381, Delacon 2011]. More than 600 000 fattening pigs were fed in 2010 with more than 167 000 tonnes of feed with added phytogetic additives [457, Delacon 2011].

Reference literature

[331, Raumberg 2010] [332, Delacon 2010] [333, Delacon 2010] [334, Lipinsky K. 2008] [380, Delacon 2011] [381, Delacon 2011] [455, Männer 2011] [456, Delacon 2011] [457, Delacon 2011] [458, Veit et al. 2011] [484, Windisch et al. 2008] [632, DAFC 2010]

4.4 Techniques for the efficient use of water

Description

A reduction of water use on farms can be achieved by reducing spillage when watering the animals and by reducing all other uses not immediately related to nutritional needs. Sensible use of water and reduction of water usage is primarily a matter of good farm management and may comprise the following actions:

- Pre-cleaning (e.g. mechanical dry cleaning) and cleaning animal housing and equipment using high-pressure cleaners after each production cycle, balancing cleanliness with minimisation of water use.
- Regularly verifying the calibration and, if necessary, recalibrating the drinking-water installation to avoid spillages.
- Keeping a record of water use by metering the consumption (e.g. every 6 months), possibly differentiating between the physiological phases of the rearing cycle and functional uses (e.g. drinking, washing). This procedure allows the establishment of a water index consumption by animal category.
- Detecting (e.g. by visual inspection) and repairing leakages in the water distribution circuit.
- Using separately collected uncontaminated rainwater and reusing it for cleaning purposes, if it is reasonable for the sanitary implications to do so (see Section 4.15.2.1).

Achieved environmental benefits

Reduction of water consumption.

Cross-media effects

Typically in pig housing, the wash-down water enters the slurry system, which means that reduced cleaning water usage will lead to thicker slurry; the higher dry matter content will cause increased ammonia emissions during subsequent slurry spreading because of the lower infiltration rate into the soil (see Section 4.13.4.1).

Environmental performance and operational data

Animal consumption

Water provision always has to satisfy the welfare requirements set by relevant regulations. Reduction of the animals' water consumption is not considered practical as the animals' need for fresh water must not be compromised. The drinking equipment should be selected appropriately considering the animals' drinking behaviour.

For poultry, different types of drinking systems are applied such as (see also Section 2.2.5.3):

- nipple drinkers with or without a drip cup;
- water troughs;
- round drinkers;

For pigs, the following types of drinking systems are commonly applied (see also Section 2.3.3.3):

- nipple drinkers with a trough or cup;
- water troughs;
- push-tube drinkers;
- biting drinkers.

Table 4.32 shows the results of six tests performed on fattening pigs, comparing the water consumption and slurry generation between integrated nipple drinkers in the dry feeding trough and drinkers separated from the dry feeder. Table 4.33 presents the results of similar tests carried out with gestating sows.

It can be seen that the total water consumption for separated drinkers is almost double that of integrated nipples, due to water wasted by the animals; as a consequence, the generation of slurry is much greater too. The difference in the growth rate, feed intake or feed conversion efficiency of the animals does not appear to be significantly influenced by the drinker designs or positions in the pen and the related increase in water consumption [534, AFBI 2007]. However, the exclusive use of integrated drinkers may not be allowed (e.g. in Germany) [624, IRPP TWG 2013].

It has been reported that placing drinkers apart, rather than side by side in the pen, leads to a reduction in water usage, due to a reduction in swapping between drinkers, especially when low flow rates are used [534, AFBI 2007].

Table 4.32: Examples of the effect of drinking equipment on the water consumption and slurry generation of fattening pigs

Water consumption/ slurry generation	Integrated nipple drinkers in the dry feeder			Drinkers separated from the dry feeder		
	Test 1 ⁽¹⁾	Test 2 ⁽²⁾	Test 3 ⁽²⁾	Test 4 ⁽³⁾	Test 5 ⁽³⁾	Test 6 ⁽⁴⁾
	l/animal/day			l/animal/day		
Animal consumption for drinking (water ingested + wasted by the animal)	6.88	5.40	5.97	13.52	19.51	6.14
Water for washing	0.47	0.29	1.31	0.5	0.16	2.76 ⁽⁵⁾
Total water consumption	7.35	5.69	7.28	14.02	19.67	8.9
Slurry generation	3.71	2.70	5.38	8.98	11.80	6.64
⁽¹⁾ Feed is moistened. ⁽²⁾ Feed is not moistened. ⁽³⁾ Individual nipple drinker. ⁽⁴⁾ Drinking bowl. ⁽⁵⁾ Extra outside corridors attached to the building were washed daily. <i>Source: [376, Ferreira et al. 2010]</i>						

Table 4.33: Examples of the effect of drinking equipment on the water consumption and slurry generation of gestating sows

Water consumption/slurry generation	Vacuum trough flooding tube	Drinking bowl	Individual nipple drinker	Vacuum trough flooding tube
	Test 1	Test 2	Test 3	Test 4
	Group housing in pens		Individual housing in stalls	
	l/animal/day			
Animal consumption for drinking (water ingested + wasted by the animal)	23.99	9.65	17.58	16.34
Water for washing	0.64	2.36 ⁽¹⁾	0.26	0.24
Total water consumption	24.63	12.01	17.84	16.59
Slurry generation	11.51	5.3	10.90	9.18
⁽¹⁾ Extra outside corridors attached to the building were washed daily. <i>Source: [376, Ferreira et al. 2010]</i>				

Feed for pigs can be delivered to the trough in liquid form, therefore involving water addition. The volumes of added water depend on many factors and a general rule of quantification is not possible.

As regards nutritional management, Sections 4.3.2 and 4.3.3 present the effects of nutritional measures on water consumption and consequently on the volume of slurry produced. For example, for poultry, it was demonstrated that a reduced protein level of 3 percentage points resulted in an 8 % reduction of water intake.

When water is given *ad libitum* to pigs, they naturally reduce their water intake. Literature shows that reduced-protein diets contribute to a decrease in water consumption. The results are summarised in Figure 4.5.

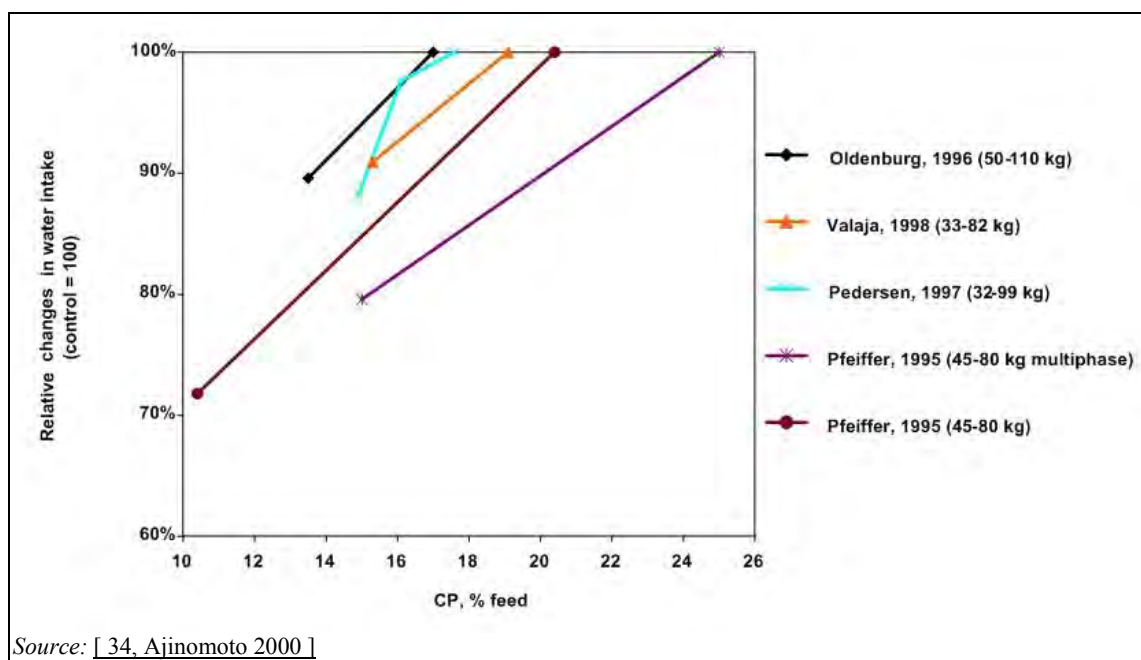

Figure 4.5: Effect of reduced crude protein diets on the intake of water by pigs

Cleaning water

Housing disinfection is necessary to minimise infectious diseases; provisions for regular cleaning and disinfection are also specified by the welfare directives (e.g. 1999/74/EC and 2007/43/EC for poultry and 2008/120/EC for pigs). Cleaning water consumption is very much related to farming habits and housing architecture (e.g. external pasageways along perimeter walls that need to be frequently cleaned to reduce the odour potential) [376, Ferreira et al. 2010]. The use of authorised cleaning agents and disinfectants can reduce the harmfulness of waste water.

By extensively employing dry cleaning methods with the subsequent use of jet cleaners, water consumption and waste water generation can be significantly reduced. The use of high-pressure cleaners, as well as using hot water or vapour cleaners instead of cold water, reduces water consumption [361, France 2010]. In particular, the application of warm water can reduce water use by 50 %. A tenfold difference in cleaning water use was reported between a Finnish broiler farm and a Dutch broiler farm. A steamer, which uses a low water volume, is used widely in Finnish farms and may explain the difference [624, IRPP TWG 2013].

From a laying hen farm in Austria operating with an aviary housing system, 40 m³ to 50 m³ of waste water is reported to be generated by each house (around 14 500 hens/house) after cleaning with high-pressure cleaners without the use of detergents [373, UBA Austria 2009].

Cooling water

The water consumption and the efficiency of systems used for temperature control in animal houses in warm seasons, e.g. fogging, is variable according to the adopted system. The great variability of consumption is related to the climatic conditions.

Air cleaning systems

Air cleaning systems may require the use of water. From biofilters to biotrickling beds to multi-stage scrubbers, water is lost mainly by evaporation and also by waste. The requirements for fresh water range from 5 litres to 7 litres per 1 000 m³ of treated air.

Metering of water consumption

The practice of installing a metering device is effective when a breakdown is obtainable per production stage. Different features applicable in the production stages, namely the flooring system, feeding and drinking devices, ventilation systems and building characteristics, can all affect water consumption.

Technical considerations relevant to applicability

The needs of the animals for fresh water must always be met.

A restriction is related to cleaning animal housing and equipment with high-pressure cleaners, which is not applicable to poultry plants using dry cleaning systems.

Economics

Savings are possible as a result of conscientious habits and behaviour and the proper management of individual specific techniques. A reduction in waste water decreases the volume of liquid manure that will be applied in agriculture, thus reducing landspreading costs. The requirements for slurry storage capacity are reduced, therefore a reduction of construction and operating costs, associated with the pumping, transport or even energy recovery, may be achieved.

Driving force for implementation

Reducing the environmental footprint of the farm and reducing costs are the main driving forces for the implementation of water-saving measures. Smaller volumes of waste water and slurry result in reduced requirements for slurry storage capacity and lower landspreading costs.

Example plants

These measures are widely applied.

Reference literature

[34, Ajinomoto 2000] [361, France 2010] [376, Ferreira et al. 2010] [373, UBA Austria 2009] [534, AFBI 2007] [624, IRPP TWG 2013]

4.5 Techniques for the efficient use of energy

4.5.1 Introduction

Measures to improve efficiency in the use of energy involve good farming practice, as well as the selection and application of appropriate equipment and the proper design of the animals' housing. Measures taken to reduce the level of energy usage also contribute to a reduction of the annual operating costs.

The opportunities for savings in energy use can be ranked in priority order as reported below:

- heating;
- ventilation;
- lighting;
- other consumption (e.g. feed preparation and distribution).

Factors that affect the indoor temperature are:

- heat output from the animals, according to their weight and stocking density;
- any heat supply (e.g. gas heater, lamps or heat pads for piglets, input from lighting and sun radiation);
- ventilation rate;
- heat absorbed by the indoor air, including by fogging and spraying water;
- heat used to evaporate water from drinkers, feed troughs, spilt water and urine;
- heat loss through walls, roof and floor;
- the presence of trees with a shadowing effect (in warm climates);
- external temperature.

Control of ventilation rates is the simplest method of controlling the indoor temperature of animal housing. Energy-saving measures are also closely related to the ventilation of livestock housing. The ventilation system should be designed to remove the extra heat in the warm summer months at the highest possible stocking density, and to also have the capability to provide a minimum ventilation rate in colder winter months at the lowest stocking density. For animal welfare reasons, minimum ventilation rates should be sufficient to provide fresh air, sufficient humidity and to remove unwanted gases.

The achieved energy savings are significant when the ventilation rate is properly managed (see Section 4.5.4.2.1 and Section 4.5.4.2.2) [339, ITAVI 1997] [349, ITAVI 1998]. For example, in pig housing, the yearly average losses associated with the renewal of air represent about 75 % of the total heat losses. A bad adjustment of ventilation rates can result in a significant waste of energy.

Electricity demand can be significantly reduced if houses are equipped with natural ventilation, rather than with forced ventilation systems. However, this is not always possible or desirable for every livestock type and for all farming objectives.

Another significant source of energy consumption is the lighting of livestock houses. The lighting system has to be designed to meet the requirements of the animal regarding animal welfare and animal health as well as to ensure good working conditions for those working in the livestock house. To meet the needs of the animals, a minimum intensity of light has to be

ensured, depending on the animal category. Furthermore, a regular change of light and darkness has to be provided for. Both factors significantly influence animal behaviour. Moreover, in poultry houses, flicker-free lighting is to be provided.

The energy consumption level is also linked to the high-pressure cleaning devices for livestock houses and the removal of manure. The latter includes the stirring devices used to mix the manure in the storage tank before spreading.

4.5.1.1 General energy-saving measures

General operational measures to reduce the energy consumption in pig farms are better use of the available housing capacity and optimising animal density.

Where electrical heating and lighting installations are still manually controlled, the adoption of simple thermostatic controls with ‘dimmers’ can return considerable energy savings. The use of automatically controlled management systems yields further energy savings. Investment costs and cultural resistance to the use of such equipment (which is often viewed as complex and difficult to operate) are impeding uptake [[355, Warwick 2007](#)].

Solar radiation can easily be converted into heat. Both techniques, the ‘indirect’ (panels contain hot water that transfers heat through a coil to the fluid to be heated) and the ‘direct’ (the hot water from the panel is used directly) are suitable for use in agriculture [[355, Warwick 2007](#)]. The use of this technology is increasing on farms as it is cost-effective in many MS (e.g. in Germany small farms digest slurry in a profitable way), especially those with high levels of annual solar radiation. In others, support payments and lower capital costs resulting from government incentives for renewable heating are motivating adoption [[624, IRPP TWG 2013](#)]. However, this technology is unsuitable for use in areas with very hard water.

The potential use of heat produced by cogeneration of heat and power using biogas and the use of other biogenic energy or renewable energy to cover part of the energy demand of the farm are also options with positive effects on the environment.

Another source of electric energy consumption is represented by the feed preparation and distribution. In the pig sector, energy use in feed preparation can be reduced by about 50 % when meal is transferred mechanically, rather than pneumatically (blown) from the mill to mixing or meal storage. Liquid feed systems have higher power requirements for mixing and distribution than dry feeding systems [[350, France 2010](#)]. An increase in total electricity consumption of around 18 % is reported for an integrated farrow-to-finish farm using liquid feeding [[344, ADEME 2008](#)].

The energy demand can be reduced in hot climates, where there is a need to cool the buildings, by trees with a shadowing effect, preferably native species, planted along the long sides of the sheds. Such trees also favour the reduction of dust emissions and the dilution of odour emissions as well as mitigating the impact on the landscape [[624, IRPP TWG 2013](#)]. Potential biosecurity risks due to the presence of vegetation near the animal houses (e.g. wild birds may be attracted) have to be taken into consideration.

Detailed information on the efficient use of energy is given in the ENE BREF [[703, COM 2009](#)].

4.5.1.2 Energy management approach

Establishing an energy action plan is an essential step for the reduction of energy consumption. Energy plans consider all of the information available to operators. Simple planned rules, a comparison of performances with benchmark figures, and a selection of measures and actions

are the key elements of energy action plans. A timely correction of the problem will lead to energy savings. In general, low-cost and no-cost measures are the first to be implemented.

Two examples of a benchmark approach applied for a pig farm for comparing performance are reported for UK conditions and are presented below in Table 4.34 and Table 4.35. If the consumption is above the typical figure, immediate action is required to reduce energy consumption.

Table 4.34: Benchmark figures for energy use in a pig farm

Production stage	Energy consumption (kWh/pig produced)		Main influence
	Typical	Good practice	
Farrowing	8	4	Use of box creeps with thermostatic control gives the lowest operating cost. Underfloor heating pads are generally more energy-efficient than infrared bulbs.
Weaning	9	3	Major issues are the insulation of buildings (or kennels) and, principally, the control of ventilation.
Finishing	10	6	Efficient fan selection, good design of inlets and outlets and system cleaning are the key points to minimising energy use.
Feeding system	3	1	Dry feeding systems use a small amount of energy for conveying. Wet feeding is generally more energy-intensive because of the need to mix and pump feed, and pressurise pipework.
Slurry management	6	2	Selection of high-efficiency pumps, aerators and separators.
Source: [356, Carbon Trust 2005]			

Table 4.35: Benchmark figures for energy use in a weaning house

	Heating		Lighting		Ventilation	
	Typical	Good practice	Typical	Good practice	Typical	Good practice
Average annual usage (kWh/pig)	7.5	3	2	1	0.8	0.6
NB: Room measuring 26 m ² , 120 pigs housed from 3 to 7 weeks of age, four electric heaters of 1.5 kW, and two 355 mm fans.						
Source: [356, Carbon Trust 2005]						

Energy monitoring and understanding consumption patterns are necessary before an energy action plan can be drawn up. Real-time monitoring, often incorporated into ventilation and in-house environment management systems, can provide necessary data in a format in which improvements and areas for attention can be readily identified. The level of data provided is more comprehensive and of greater value than spot measurements, especially where a number of measurements taken simultaneously over a period of time can be viewed together. Measures that can be a part of an energy action plan are given below:

Low-cost or no-cost measures

- To take regular meter readings, including to check fuel stock levels, and to record results in a systematic way. This measure allows the changes occurring in energy use to be understood and performances to be compared. As much as possible, collected information needs to be related to processes, production stages, houses, and external influencing parameters (e.g. weather), with sub-metering of separate buildings or processes.

- To carry out maintenance and repairs to housing and equipment (e.g. maintain regulating flaps, seal buildings to stop draughts).
- Dust and corrosion are major problems for heaters, ventilation components and controllers. All components have to be cleaned at the end of each batch (e.g. cleaning of fans and air inlets/outlets).
- To regularly check the proper functioning of sensors, e.g. those that are fitted for temperature, humidity, carbon dioxide and light.
- To use information from the control systems. A number of monitoring systems for environmental and feed control can be fitted with real-time devices to deliver recorded and live data. Such information may be remotely accessed, e.g. via smartphone devices, and/or used at a later date.

Potential energy savings associated with regular monitoring and benchmarking, are reported to be around 10 % of the total energy use, in both the poultry and pig sectors in the UK, with a payback period of 0–2 years [[355, Warwick 2007](#)].

Medium- and long-term measures of medium to high cost

- To re-insulate buildings.
- To update heating and ventilation controls, e.g. use of improved controlling devices like dimmers or thermostatic controls (e.g. for creep heating).
- To install efficient fans and ducts [[356, Carbon Trust 2005](#)].
- To consider high-efficiency motors, when specifying or upgrading motors on feed or slurry handling systems, and to consider pumps with variable speed drives when servicing a variable demand [[356, Carbon Trust 2005](#)].
- To reconfigure ventilation to give better control of the minimum level [[356, Carbon Trust 2005](#)].
- To install compact fluorescent lighting or high-efficiency tubular fluorescent lighting.
- To achieve a high specific oxygen transfer rate per unit of energy input to the aerator (kg O₂/kWh), when slurry aeration is applied.

The most important medium- and long-term actions for energy saving in the intensive rearing sector are the following:

- insulation of the buildings (see Section 4.5.2);
- use of efficient lighting (see Section 4.5.3);
- optimisation of the heating and ventilation in the housing systems (see Section 4.5.4);
- heat recovery (see Section 4.5.5);
- natural ventilation (see Section 4.5.6).

4.5.2 Insulation

Description

Insulation prevents the passage of heat into or out of the livestock building by interposing non-heat-conducting material in the walls, floor and roof.

As humidity is a major cause of deterioration of insulating material, some insulation materials are naturally impermeable or provided with an impermeable coating on manufacture to prevent moisture ingress when in use. Permeable materials should be provided with a vapour barrier

installed as per the manufacturer's instructions in order to be protected against the ingress of moisture after installation. Insulation material should also be resistant to wild birds, rodents and insects.

The need for insulation also depends on:

- the kind of ventilation system; some open climate housing systems do not require any insulation at all;
- the insulating properties of the materials used in construction.

Achieved environmental benefits

Good insulation limits excessive energy losses through the walls, roof and floor; therefore, it helps to keep buildings warm in winter and cool in summer. When the quality of the insulation and sealing of the buildings is improved, there will be substantial benefits in terms of energy savings for both heating and ventilation.

Cross-media effects

Most materials are custom-fitted and non-reusable and hence are disposed of after use.

Driving force for implementation

Reducing the variability of the indoor temperature preserves or improves animal performance and welfare. Extreme climatic conditions justify insulation even more. In littered housing systems, a decrease in temperature variations between the ground and the litter prevents condensation.

4.5.2.1 Insulation in poultry housing

Environmental performance and operational data

Approximately 70 % of the heat losses occur from the roof, which therefore needs to be well insulated. Losses depend on the different levels of insulation and the outdoor temperature.

Sealing is also very important in the control of heating costs, especially in winter and in sites exposed to wind. The undesired air intake may come from hatches, curtains, doors, gates, and panel junctions. Older timber buildings are prone to leakage around structural joints, door openings and ventilation components. Remedies are quite easy at a reasonable cost. Simple and relatively cheap adjustments and repairs to ventilation flaps, fan ducts and doors will easily result in savings in heating costs.

Common insulation materials in use for livestock housing are shown in Table 4.36, along with the average overall heat transfer coefficient (U).

Table 4.36: Heat transfer coefficients (U) for different poultry house insulation materials with a thickness of 2.54 cm

Insulation type	U (W/m² per °C)
Loose-fill fibreglass	0.44
Perlite/vermiculite	0.47
Loose-fill rock wool	0.49
Fibreglass, roll or batt ⁽¹⁾	0.56
Loose-fill cellulose	0.61
Expanded polystyrene board	0.67
Extruded polystyrene board	0.84
Polyisocyanurate board, unfaced	1.02
Spray polyurethane foam	1.04
⁽¹⁾ 'Batt' is a standard commercial way to deliver pre-cut blankets of insulating material. <i>Source: [459, Overults et al. 2008]</i>	

For north-western Europe, U values of 0.4 W/m² per °C or better (lower U values) are recommended for building insulation where new poultry houses are planned, which approximates to about 50–60 mm of extruded polyurethane [95, UK 2010]. In France, the recommendations for the insulation of new poultry houses are around 0.6 W/m² per °C for walls, and 0.35–0.4 W/m² per °C for roofs.

In the UK, fibre wool insulation materials were widely used in the past because of their low cost, but they are being replaced by blown fibre and slab insulation products when they deteriorate [355, Warwick 2007].

A well-insulated poultry housing system allows savings of between 30 % and 50 % of the gas consumption, compared to a poultry building with an average degree of insulation. The reduction in energy consumption can range between 2 kg and 4 kg of propane gas per m² per year [350, France 2010].

From Finland, an example of insulation for broiler houses has been reported, with 140 mm of mineral wool on vertical walls and 300 mm of cellulose mineral wool applied under the roof [144, Finland 2010].

Table 4.37 shows the estimated thermal losses that may occur from the roofs of laying hen buildings with an area of 1 200 m². Losses depend on the different levels of insulation and on the outdoor temperature. The thermal energy loss needs to be compensated by an equivalent amount from propane gas heaters. The savings in gas requirements can be calculated by the difference in the amount of gas used.

Table 4.37: Estimations of heat losses during one production cycle from roofs in laying hen housing, and the requirements for energy replacement (building area: 1 200 m²)

Outside temperature		Insulation with 40 mm of PU foam U = 0.780		Insulation with 50 mm of PU foam U = 0.638		Insulation with 120 mm of fibreglass + 40 mm of PU foam U = 0.241	
		kWh	kg of propane	kWh	kg of propane	kWh	kg of propane
Average	4.5 °C	15 931	1 154	13 029	944	4 925	375
Range	-4.1 °C to 21.6 °C						
Average	8.5 °C	13 410	972	10 967	795	4 146	300
Range	-0.1 °C to 25.6 °C						
Average	12.5 °C	10 889	789	8 905	645	3 366	244
Range	3.9 °C to 29.6 °C						
Average	16.5 °C	8 380	607	6 853	497	2 591	188
Range	7.9 °C to 33.6 °C						
Average	20.5 °C	5 936	430	4 854	1 835	2 430	176
Range	11.9 °C to 37.6 °C						

NB: PU = Polyurethane; U = Heat transfer coefficient, in W/(m²/°C).
Source: [342, ADEME 2008]

Technical considerations relevant to applicability

All new buildings can be thermally insulated. Insulating older buildings may be difficult, as fitting insulated panels on the inner surfaces can be hampered by pipes, wires and other ancillaries. Alternative insulation solutions include filling roof voids with low-density injected polyurethane foam, or applying external insulation.

Insulation of buildings with natural ventilation is less efficient or is not required. Temperature variability within the European Union, but also within a single Member State, may lead to very different recommendations concerning the insulation of animal houses.

The further insulation of existing poorly insulated buildings is assessed on a case-by-case basis and according to the state and age of the building at the time of renovation, taking into account the material choice and characteristics (thermal conductivity, thickness of the insulation), as well as the prevailing local climatic conditions.

Economics

Costs for the renovation of insulation of a typical poultry house of 1 200 m² are reported in Table 4.38. These costs generally vary according to the type of materials used, the type of technique, the dimensions of the building, the number of gates, doors, etc.

Table 4.38: Costs for the renovation of insulation and sealing in a standard poultry house of 1 200 m²

Building element	Cost range (EUR/m ²)	
	FR	UK
Roof	10–25	18–25
Floors	1–2	4–7
Side walls	15–19	18–25
Gables	3–11	8–15
Gates	1–3	NI
Doors	1–2	NI
NB: NI = no information provided.		
Source: [350, France 2010] [500, IRPP TWG 2011]		

In the UK, the cost for renovation of the insulation in a turkey housing system is reported to be around 0.3–0.4 % of the total renovation costs (the approximate total broken-down costs for the renovation are EUR 6 900/m² for roof, EUR 4 000/m² for side walls, EUR 2 900/m² for gables with an exchange rate of 1 EUR=0.86 GBP) [500, IRPP TWG 2011].

In the poultry sector in the UK, the potential energy savings achievable with measures related to building insulation are reported to be equivalent to 11 % of the total energy use, with a payback period of 2 to 5 years [355, Warwick 2007]. In France, the cost for repairing the sealing of the building is reported to be around EUR 1.5 to EUR 2 per m² [342, ADEME 2008].

Example plants

Insulation is widely applied to poultry housing systems. In France, poultry buildings are now continuously being renovated.

Reference literature

[95, UK 2010] [144, Finland 2010] [339, ITAVI 1997] [342, ADEME 2008] [350, France 2010] [355, Warwick 2007] [459, Overults et al. 2008] [500, IRPP TWG 2011]

4.5.2.1.1 Heat-reflecting membranes

Description

The technique represents a variation of the traditional insulating techniques applied to poultry houses. Walls and ceilings are lined on the indoor side with laminated plastic foils, to seal poultry housing against air leakage and humidity.

More than 96 % of the infrared energy from outside can be blocked, allowing the indoor climate to be kept under control more easily. Indoor energy is reflected back or is not radiated away from the membranes' surface. Energy consumption for lighting can be reduced due to the reflective properties of the material.

Achieved environmental benefits

Better control of indoor temperature and airflow, leading to heating power savings.

Cross-media effects

Cleaning and disinfection of the housing are facilitated, since modern films can be pressure-washed. Insects and parasite habitats are not favoured.

Environmental performance and operational data

Manufacturers claim energy (gas) savings of up to 34 % [[142, UK 2010](#)].

Technical considerations relevant to applicability

This technique can be fitted to new or existing houses.

Economics

Costs per square metre are about EUR 33 for the insulating material and EUR 9 for the installation [[500, IRPP TWG 2011](#)].

Driving force for implementation

This solution is most effective in the renovation of old farms, as older timber buildings are prone to leakage around structural joints, door openings and components. Farming in warmer climates benefits from the improved control over temperature.

Example plants

In the UK, a broiler farm of around 6 000 m² was renovated with heat-reflecting membranes. [[142, UK 2010](#)]. Farms using heat-reflecting films are well known in the warmest regions of around the world.

Reference literature

[[142, UK 2010](#)] [[500, IRPP TWG 2011](#)]

4.5.2.2 Insulation in pig housing

Environmental performance and operational data

Composite panels, containing solid polyurethane insulation, produce good results. These panels can be purchased with plastic-coated steel cladding for durability and cleanliness, and can also be used as effective structural components (e.g. kennel construction).

It has been reported that in pig housing thermal losses through walls account for 25 % of the total heat loss [[351, Marcon M. 2009](#)].

Recommendations in the UK are for an insulation level of better than 0.4W/m²/°C (60 mm polyurethane) [[356, Carbon Trust 2005](#)]. Heat transfer coefficients recommended in France for pig housing are presented in Table 4.39, for two different extreme temperatures (-5 °C and -15 °C). The lower the U value, the better the building's insulation.

Table 4.39: Recommended heat transfer coefficients (U) for two different temperatures, applied in France

Type of floor	Physiological stage	Thermal transmission coefficient (W/m ² /°C)			
		Roof		Walls	
		T = -5 °C	T = -15 °C	T = -5 °C	T = -15 °C
Solid floor with straw	Farrowing	1	0.6	1.2–1.5	0.8
	Post-weaning				
	Growing/finishing				
	Breeding				
Partly slatted floor	Farrowing	0.5	0.35	0.8	0.6
	Post-weaning				
	Growing/finishing	0.8	0.5	1.0	0.7
	Breeding				
Fully slatted floor	Farrowing	0.4	0.35	0.6	0.5
	Post-weaning				
	Growing/finishing	0.6	0.4	0.8	0.6
	Breeding				

Source: [345, France 2010]

In the UK, fibre wool insulation materials, which were widely used in the past because of their low cost, are being replaced by blown fibre and slab insulation products when they deteriorate [355, Warwick 2007].

In France, pig houses with insulation rated as good to very good achieve energy savings of up to 218 kWh/sow/year or, approximately, 10.4 kWh per pig produced, compared to buildings with average insulation; the savings account for about 19 % of the total energy consumption [344, ADEME 2008].

Non-insulated weaner houses require up to around 45 % more energy compared to well-insulated houses with 8 cm of insulation in the walls, as can be seen in Table 4.40. In particular, the heat consumption of a poorly insulated weaner house (2 cm of insulation) is 20 % higher than that for the same building with 8 cm of insulation in good condition; this is equivalent to 10500 kWh (or EUR 735/year) of potential annual savings [350, France 2010].

Table 4.40: Effect of insulation thickness on heat consumption in weaner houses

Thickness of insulation	8 cm	6 cm	4 cm	2 cm	0 cm
Heat consumption (kWh/place)	64.5	66.8	71.0	80.7	121.0
Heat consumption (kWh/ pig produced)	9.9	10.3	10.9	12.4	18.6
Difference ⁽¹⁾ (%)	Reference	3.4	9.1	20.1	46.6
⁽¹⁾ The difference in percentage is given as a ratio to the reference of 8 cm of insulation thickness.					

Source: [351, Marcon M. 2009]

In addition, it is also reported that in weaner houses in France, where the insulation has deteriorated over time, energy consumption is 9 % higher than the average situation [344, ADEME 2008]. In general, the age of the building reflects the quality of insulation and, therefore, the energy consumption of the housing system, as insulation is often based on fibre wool-type materials subject to compression and slipping, with a consequent decrease of the thickness over time [350, France 2010] [356, Carbon Trust 2005].

A study in France revealed that in farrow-to-finish houses built before 1992, which correspond to the development of new building panels, the energy consumption increased by 205 kWh/sow/year, in comparison with houses built after 1992 (19 % increased consumption from a value of 890 kWh/sow/year) [344, ADEME 2008]. Another study showed that by

adding 1 cm of insulation (on the ceiling and the walls), in a weaners' building of 250 places, the energy consumption for heating can be reduced by 11 % to 18 % (for a minimum airflow at the beginning of the batch of 3 m³/h/animal up to 7 m³/h/animal, respectively) (See Table 4.44) [350, France 2010]. The insulation of a partly slatted floor is only installed in the solid part.

Technical considerations relevant to applicability

All new buildings can be thermally insulated. Insulation may not be applicable to existing buildings due to structural restrictions.

Insulation of buildings with natural ventilation is less efficient or is not required. Temperature variability within the European Union, but also within a single Member State, may lead to very different recommendations concerning the insulation of animal houses.

The further insulation of existing poorly insulated buildings is assessed on a case-by-case basis, at the time of renovation, taking into account the material choice and characteristics (thermal conductivity, thickness of the insulation), as well as the prevailing local climatic conditions.

Economics

Investment costs for the renovation of the insulation in pig housing are extremely variable, depending on the age of the building, its maintenance and dimensions.

The application of a layer of 3–5 cm of standard polyurethane foam for a renovation of a pig house might cost EUR 18–35/m². The savings achievable by increasing the insulation from 2 cm to 8 cm in a weaners' house are equivalent to EUR 0.01 per kg of pig produced.

Potential energy savings, achievable with measures related to building insulation, have been reported in the UK for the pig sector as equivalent to 10 % of the total energy use, with a payback period of 2 to 5 years [355, Warwick 2007].

Example plants

Insulation is widely applied.

Reference literature

[344, ADEME 2008] [345, France 2010] [350, France 2010] [351, Marcon M. 2009] [355, Warwick 2007] [356, Carbon Trust 2005]

4.5.3 Low-energy lighting

Description

General measures applicable to save energy for lighting are:

- to replace conventional tungsten incandescent bulbs, still in use, with more energy-efficient lights, such as fluorescent, sodium and LED lights (see Table 4.41);
- to use dimmers for adjusting artificial lighting;
- to adopt lighting controls using sensors or room entry switches;
- to apply lighting schemes, for example using intermittent lighting of one period of light to three periods of darkness instead of 24 hours of light per day reduces the amount of electricity used by 30–75 % [500, IRPP TWG 2011];
- to allow more natural light to enter, e.g. by the installation of vents or roof windows;
- to adopt photoelectric cells to turn artificial lights on, in particular in the poultry sector.

Incandescent light bulbs have been removed from the European market. From September 2011 onwards, incandescent bulbs of over 60 watts were withdrawn from the market. By 1 September 2012, all incandescent light bulbs over 7 watts were withdrawn.

Fluorescent lights (tubular compact shape) can be applied in combination with a device to adjust the frequency of microflashes (> 280 000), so the animals will not be able to register the rapid fluctuations typical of this light.

Savings in electricity consumption, associated with the use of artificial lighting, can be foreseen at the time of planning a new house or a complete rebuild of an existing house, by simply allowing more natural light to enter, though avoiding direct radiation (by appropriate placement of films or sun visors).

The principal lighting sources that are available for use in animal housing are given in Table 4.41.

Table 4.41: Principal lighting sources for animal houses

Type of lamp	Luminosity (Lm)	Power (W)	Luminous efficacy (Lm/W)	Durability (hours)	Energy saving in comparison to incandescent lamp (%)	Relative cost	Recyclable
Incandescent	220–1 420	25–100	10–15	1 000	0	€	No
High-efficiency halogen	NI	13–150	15–24	2 000–4 000	30–40	€€	No
Compact fluorescent	100–1 800	3–23	20–32	40 000–15 000	80	€€ - €€€	Yes
T8 fluorescent tube	1 350–7 000	14–80	44–70	4 000–15 000	30–40	€€	Yes
Induction	35 000–12 000	55–165	NI	60 000	70–80	€€€	Yes
Metal halide (iodine)	5 900–189 000	70–2 000	50–80	10 000–18 000	35–45	€€€	Yes
High-pressure sodium	1 300–130 000	35–1 000	50–150	120 000–25 000	60–75	€€€ - €€€€	Yes
LED high-power	12–100	0.2–5 (each LED)	60–250	50 000	80–90	€€€€	Yes

NB: €€€€ highest cost – € lowest cost; NI = no information provided.
Source: [552, IDELE 2012]

Achieved environmental benefits

Reduced electric energy consumption and easier disposal of waste light bulbs due to the absence of mercury.

Cross-media effects

An increase in the use of natural light needs to be balanced with the possible heat losses through windows or openings, and should also be considered in the context of the geographical climatic conditions, with special focus on the duration of light per day [500, IRPP TWG 2011].

Reference literature

[500, IRPP TWG 2011] [552, IDELE 2012]

4.5.3.1 Lighting in poultry housing

Achieved environmental benefits

The use of a red light during rest time has been shown to have a positive effect on dust emissions in broiler housing. The light is visible to chickens that are less active [463, UR Wageningen 2010].

Cross-media effects

The number of hours of light and the intensity of the light can cause cannibalistic behaviour in the birds (pecking, tearing and consuming of skin, tissue, etc.) [500, IRPP TWG 2011]. Natural light may increase scratches and pecking [624, IRPP TWG 2013].

Environmental performance and operational data

See the general data of Table 4.41.

New compact fluorescent lamps last longer and are becoming cheaper. Low-energy fluorescent tubular lamps, with high-frequency electronic control equipment, can be used. They allow flicker-free dimming down to a very low output. For lighting outside buildings, it is better to use low-energy discharge lamps (high-pressure sodium or metal halide lamps) as these are much cheaper to operate than the commonly used tungsten halogen lamps.

Tungsten halogen lamps are better used where they can be controlled by passive infrared sensors and where they are expected to have very short operating times [95, UK 2010].

LED lighting allows a lower energy consumption and heat output, the opportunity to dim bulbs without affecting the spectrum, and a minimal flicker (unlike fluorescent lighting). LED technology offers solutions specifically tailored to the spectral sensitivity of poultry [422, Taylor N. 2010]. Chickens require a more specific type of light with a preference for blue and green compared to red [461, Glo 2010].

Technical considerations relevant to applicability

No technical restrictions are reported for the implementation of the technique.

Economics

In the replacement of different types of lights, annual operating costs (including amortisation of a new installation) depend on electricity prices as well as on the number of replacements that need to be purchased.

The indicative investment costs required to install an entire low-energy lighting system (including installation, accessories, wiring and protection) in a poultry house of 1 200 m² is estimated to be between EUR 7.5 and EUR 10 per m² [350, France 2010].

Driving force for implementation

The driving force is savings in electricity costs.

LED lights in poultry flocks reduce aggression. In poultry-specific LED lighting, the red end of the spectrum is decreased, in order to favour poultry behaviour and welfare [422, Taylor N. 2010] [461, Glo 2010].

Example plants

The technique is generally applied. Commercial LED equipment is on the European market and being adopted by poultry farmers.

Reference literature

[95, UK 2010] [350, France 2010] [422, Taylor N. 2010] [461, Glo 2010] [463, Wageningen UR 2010] [500, IRPP TWG 2011] [624, IRPP TWG 2013]

4.5.3.2 Lighting in pig housing

Environmental performance and operational data

Table 4.41 provides general data on types of lighting equipment.

Pigs seem to rely more on olfaction and audition than on vision. In practice, pigs have a poor colour perception and are unable to perceive the flicker of normally functioning fluorescent lights. In general, fluorescent lights have a higher light capacity per energy unit (lumen/watt) than conventional bulbs. The power rating and the number of hours used will determine the annual energy use. The replacement of filament bulbs by compact fluorescent lights could save up to 75–80 % of the energy used.

Compact fluorescent lamps cannot be dimmed. T8 (1.25 inch) fluorescent tubes are more efficient than T12 (1.5 inch) tubes. In fluorescent tubular lamps, electronic control gives a 20 % energy saving over conventional ballasts, and extends lamp life by 50 % [[356, Carbon Trust 2005](#)]. As two different levels of lighting are generally required (depending on whether the operator is present in the room or not), energy-efficient lighting can be split into two circuits [[356, Carbon Trust 2005](#)]:

- For high-level lighting, fluorescent tubular (strip) lamps with T8 tubes and electronic control will give the best energy efficiency and most even light distribution;
- For low-level lighting in smaller rooms, a small number of compact fluorescent lamps is a good solution; alternatively fluorescent tubular (strip) lamps with dimmable ballasts can be used to allow the lights to be turned down during stock lighting periods.

Technical considerations relevant to applicability

No technical restrictions are reported for the implementation of the technique.

In general, the use of lighting controls (photoelectric cells) is not commonly applied; lighting control is generally confined to manual switching. Proximity sensors are better used for technical areas or corridors than for areas with animals [[500, IRPP TWG 2011](#)].

Economics

Annual operating costs associated with the replacement of lights depend on electricity prices as well as on the number of replacements that need to be purchased.

In general, the necessary investment to equip a pig farm with low-energy lighting has to be studied on a case-by-case basis. The cost will depend on the farm size and the organisation of the building (use of natural light, size of the rooms, corridor organisation, etc.)

Driving force for implementation

One of the driving forces is savings in electricity costs. The manufacturers of LEDs also claim an improved physical performance in the animals.

Example plants

The technique is generally applied. Commercial LED equipment is on the European market and is being adopted by pig farmers.

Reference literature

[[356, Carbon Trust 2005](#)] [[500, IRPP TWG 2011](#)]

4.5.4 Optimisation of heating/cooling and ventilation systems and management in poultry and pig farms

Thermal losses from animal housing may be reduced by the optimised and well-balanced management of heating and ventilation, adapted to the physiological needs of the animals. This is achieved by optimising the minimum ventilation rates (manual or automated management), taking into account the minimum levels required for the animal performance and welfare (i.e. fresh air supply, sufficient humidity, removal of undesirable gases). Bad management of ventilation can have a negative impact on the growth performance of the animals and thus on the economics of the farm.

An overview of the main measures for minimising energy consumption through optimising the heating and ventilation in poultry and pig farms is given below.

4.5.4.1 Efficient use of energy for heating

4.5.4.1.1 General measures for the efficient use of energy for heating in poultry farms

A building where meat poultry is reared has specific requirements for heating (e.g. 32 °C for day-old chicks) and for cooling (e.g. 20 °C for bird stocking densities of up to 34 kg per m² of floor area). All buildings are fitted with large heating and ventilation systems to maintain these conditions [95, UK 2010].

A considerable reduction in energy consumption for heating and ventilation can be achieved by paying attention to the points given below:

- Energy consumption can be reduced by separating heated spaces from other spaces, by limiting their size.
- In the heated space, energy use can be reduced by correct regulation of equipment and by an even distribution of warm air through the housing, i.e. by spatially distributing the heating equipment adequately. An equal distribution would also prevent a sensor from being located within a cold or hot spot in the housing, which would unnecessarily activate the heating or ventilation system.
- Control sensors need to be regularly checked and kept clean to correctly detect the temperature at the stock level (maximum one metre high).
- For poultry farms equipped with gas heaters, regular maintenance of heating devices and replacement of worn-out parts (every 5 to 6 years) allow for better combustion and savings in energy. Equipment should run at correct (full) power, since the temperature decrease is not proportional to the reduction of power.
- Warm air from just below the roof level can be circulated down to floor level. Airflow directed towards animals should be of a sufficiently low velocity to avoid compromising the animal welfare.
- Over-ventilating heated poultry meat housing during cold weather can dramatically increase heating costs. As small errors in the winter minimum ventilation rate can have a big impact on operating costs for heating, it is essential to invest in good control equipment and ventilation systems, which are capable of delivering low-level and accurate amounts of ventilation.
- Control of minimum ventilation also requires well-sealed buildings. Cracks and open seams in the housing construction should be repaired.
- Placing ventilation vents low down on the walls (as heat tends to rise) will reduce heat losses.

- Further insulation with loose material on the floor (e.g. sand used in the Netherlands), i.e. on top of the built-in insulation of the floor, will reduce heat losses and therefore fuel input (especially with high groundwater levels).
- In a laying hen house, heat may be recovered with a heat exchanger between the incoming and outgoing air (see Section 4.5.5). This type of system is used to warm the air to dry the manure on the belts under the cages, to reduce the emissions of ammonia.
- If heating is required to maintain the moisture content of litter, all sources of unnecessary wetness should be rectified (e.g. spillage from drinkers).
- Fans that operate intermittently should be fitted with back-draught shutters to reduce heat loss.
- Concentrating chicks at the start of the cycle: barriers can be placed in the house to avoid the chicks spreading everywhere in the house to keep them together and warm.
- A good evacuation of rainfall around the building prevents water from rising indoors by capillary action (especially where floors are not made of concrete), requiring additional energy for heating.
- The use of heat exchangers to recover heat is another solution to minimise energy consumption.
- Optimising air homogenisation and air circuits is another option. In buildings with mechanical ventilation, the aim is to heat the entering air by forcing it, following the under-roof route, inside the room. Meanwhile, in buildings with natural ventilation the homogenisation is achieved using a mixing fan, which will allow the warm air from the ridge of the building to be pulled down towards the animal living area, without generating excessive airflow.
- Many control systems used in poultry housing often rely on a single sensor to operate the complete heating or ventilation system for the whole house. Better systems have multiple electronic sensors, positioned just above bird height, to give a representative reading of the true temperature. Control systems which give good feedback in terms of temperature records, as well as information on the historical operation of fans and heaters, help to manage energy more effectively.
- Buildings fitted with separate thermostats for heating and ventilation run the risk of the two systems operating at the same time and, therefore, wasting energy. Where cooling fans and heaters are installed within the same building, interlocked controls should be used to stop the operation of heating when fans are running at anything above their minimum ventilation setting.

4.5.4.1.2 General measures for the efficient use of energy for heating in pig farms

The rate of air exchange is primarily responsible for the energy requirements for heating. That is why it is crucial to control the flow of air, in particular the minimum flow rate. Heating accounts for 46 % of total energy consumption for an integrated breeding-to-fattening farm and for approximately 80 % of the total energy consumption for the farrowing and post-weaning stages. Optimisation of the balance of heating and ventilation, adapting it to the animals' needs, may reduce energy consumption by up to 50 %.

Some possibilities for reducing energy consumption for heating are:

- reducing ventilation, taking into account the minimum levels required for animal performance and welfare;
- lowering the temperature as far as animal welfare and production allow;
- insulating the building, particularly lagging the heating pipes;

- optimising the position and adjustment of heating equipment;
- considering heat recovery;
- considering using high-efficiency boilers in new housing systems;
- using enclosed creep areas;
- checking the calibration of temperature sensors regularly;
- natural ventilation (see Section 4.5.6).

In the operation of biogas facilities, the energy generated (power and heat) from the biogas produced can be used (recovered) to replace that generated by fossil fuels. However, only post-weaning houses are capable of utilising the heating energy throughout the year.

Some examples of operational measures applied in the pig sector for reducing heat requirements and/or achieving energy savings are indicated below.

In sow housing, a zone heating system is installed for heating the piglet creep area. Hot water floor heating is more energy-efficient (if the hot water is from a renewable energy heated source) than an electric floor heating system or the use of infrared radiators.

For houses with natural ventilation, the lying area is located in heat-insulated boxes ('box and bed stalls') to avoid the need for additional heating.

Electric floor heating with warming plates allows for a reduction in energy consumption by 30 %, compared to over-floor heating; however, the technique still remains expensive for existing housing systems, and will usually only be applied on the occasion of a major renovation. The application of electric floor heating, in combination with optimised ventilation, is quite expensive in the retrofit of existing housing systems.

With the use of kennels for piglets, the different thermal needs of sows and newborn piglets can be met simultaneously, providing a temperature of around 30 °C for piglets, and not over 24 °C for sows [350, France 2010].

In post-weaning, adjustable infrared heaters are more energy-efficient than standard heaters. Moreover, the positioning and the calibration of the temperature sensor is essential. A single probe, for simultaneously controlling the ventilation and heating, should be applied.

4.5.4.1.3 Gas-fired infrared heaters and air blowers

Description

Propane- or natural-gas-fired infrared heating systems generate electromagnetic (infrared) radiation, which is transferred to a body with a lower temperature where it is converted into heat. In animal houses, a ceiling-hung gas-fired heater transfers energy directly to the animals and the floor, instead of heating the surrounding air. Eventually, heat is stored in slab floors and the air is secondarily heated as it passes over the warm concrete. In a forced air heater, air is drawn through the heater and blown into the house. The circulating heated air transfers heat to whatever it flows over, including the animals and the litter, provided that air circulation in the house is good.

Achieved environmental benefits

The use of gas-fired radiant heaters provides concentrated heat to the animals without having to heat the rest of the house; therefore, fuel savings are achieved.

Cross-media effects

Fossil fuel (propane, natural gas) is a non-renewable energy. Safety considerations have to be implemented with the use of ceiling-hung gas-fired radiant heaters.

Environmental performance and operational data

Modulated radiant heaters are much more efficient in terms of gas consumption than conventional non-modulated heaters. In modulated heaters, the gas flow and the combustion air are continuously adjusted, allowing gas savings of around 20–40 % compared to conventional systems, which corresponds to 1.4–3.1 kg of gas/m² per year.

Modulated radiant heaters, with automatic regulation, can operate gradually over a pressure range between 20 mbar and 1 400 mbar, showing a better performance in comparison with two-stage radiant heaters working at two pressure levels between 50 mbar and 150 mbar.

In well-insulated and sealed buildings, warm air generators (blowers) are more effective than gas-fired infrared heaters, but the latter are more appropriate in larger buildings that are not well insulated, in particular for the production of turkeys. Warm air blowers require electricity to induce the air movement; meanwhile, gas-fired radiant heaters can, in principle, operate without electricity and, in some cases, be controlled manually.

Technical considerations relevant to applicability

This technique is generally applicable as long as a gas supply is available on farm. It is mostly employed in poultry rearing but can also be used for in pig houses, where it may represent a good alternative where insufficient electric power is available.

Economics

Indicative investment costs for the equipment are EUR 4–9.2/m² (tax excluded) for a gas-fired infrared heater with a modulated gas flow and EUR 3.4–11 per m² for gas hot air blowers. In the case where a warm water heating circuit is also installed, the price for the related hot air blowers lies between EUR 5.8 and EUR 6.7 per m². These prices are evaluated for a building of 1 200 m² and vary according to the type and the number of pieces of equipment installed, as well as to the selected options.

The maintenance cost for radiant heaters, by periodic replacement of worn parts, is reported to be about EUR 100 (every 6 to 10 years) for a 1 200 m² house.

Driving force for implementation

The difference in prices for electricity and gas can play a role in the choice of this technique. Gas heating may be the alternative for farms that are not connected to the electrical network.

Example plants

The technique is widely applied.

Reference literature

[339, ITAVI 1997] [342, ADEME 2008] [349, ITAVI 1998] [350, France 2010]

4.5.4.1.4 Wood- and biomass-fired boilers**Description**

Standard boilers or combined heat and power systems are fuelled with wood and/or other biomass for heating up water. Heat exchangers serve the heating circuit, where hot water is produced and circulated in the building to warm it up (e.g. by means of fins, hot plates).

Straw can be also used in broiler farms as a fuel [144, Finland 2010].

In Figure 4.6, a heating system for a broiler house in Spain based on a biomass burner is illustrated.

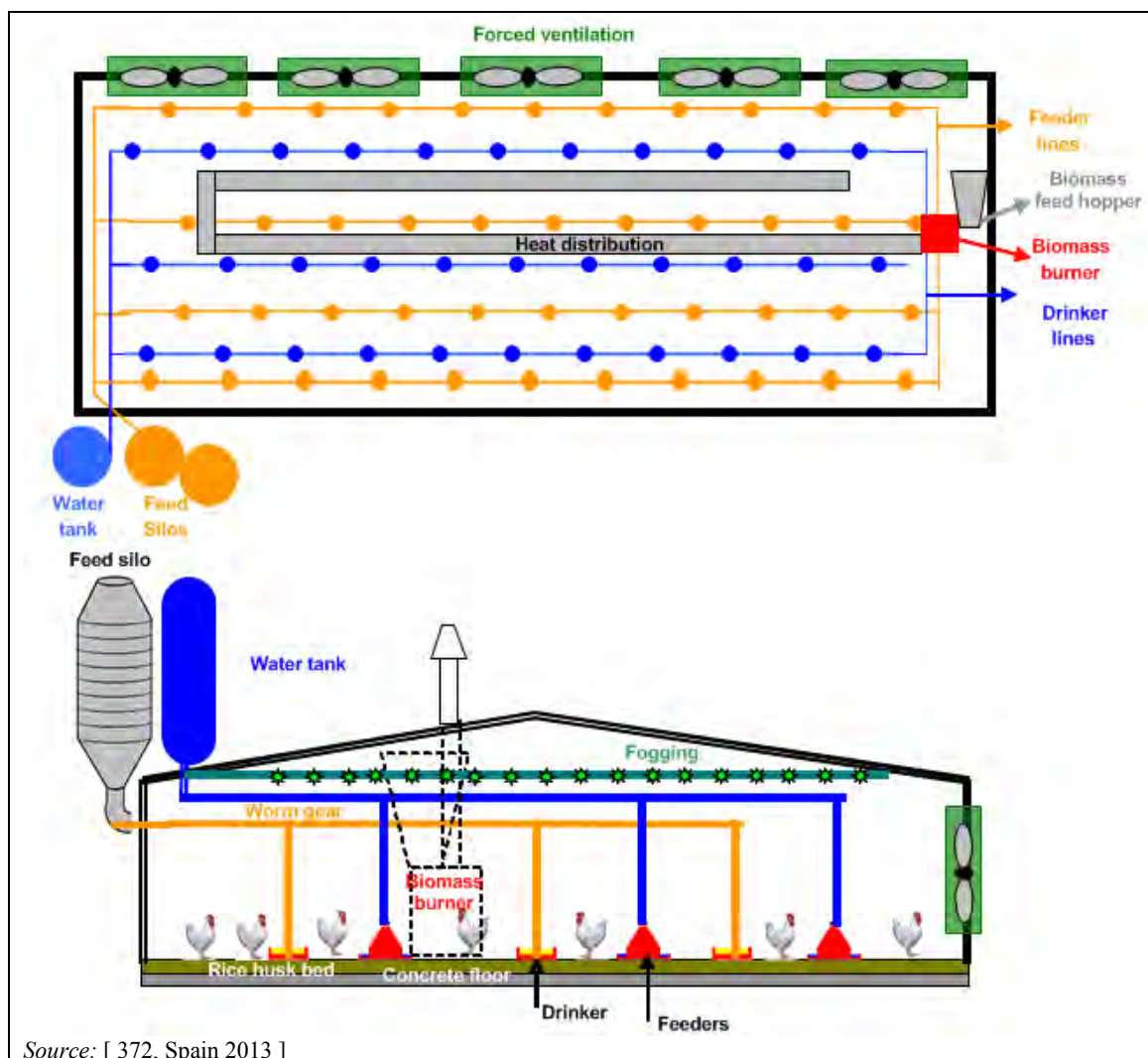

Figure 4.6: Schematic representation of feed, water and heat distribution by a biomass burner in a broiler house

Achieved environmental benefits

Wood use has a neutral impact on the greenhouse effect. The economic value is given by adding value to available copses, farm woodland and agricultural residues that are not fully exploited, or by cropped biomass (e.g. miscanthus).

Cross-media effects

When peat is used as fuel, the indirect environmental effects of peat exploitation (emissions of CH₄ and N₂O when peat is mined) should be taken into account.

Use of wood and other biomass to fire boilers for heating up water may result in dust emissions in the air and should be also taken into account, especially in areas with problems of overcoming air quality limits. A high demand for biomass may cause overexploitation of forests or excessive land use for biomass crops [624, IRPP TWG 2013].

Environmental performance and operational data

This system allows for efficient heating and good temperature control. Heat is well distributed in the building. This heating system is profitable when heat needs are large and stable, as is the

case with multiple houses or users. An example is reported in Table 4.42 of a mixed poultry and dairy farm combined with the farmer's house.

Table 4.42: Example of a mixed farm benefitting from warm water heating served by a wood boiler

Heated houses	Boiler power
3 000 m ² poultry housing + 230 calf places	300 kW
1 800 m ² poultry housing + farmer's house	240 kW
600 m ² poultry housing + farmer's house + heated water in the milking room	100 kW or 60 kW + 8 supplementary infrared heaters
<i>Source: [346, CA Bretagne 2009]</i>	

Information on the quality of fuel (size of particles, humidity, biomass species, absence of wood treated with chemicals) is essential for the proper operation of wood and biomass boilers [345, France 2010].

Technical considerations relevant to applicability

Boilers need to be close to animal housing; otherwise, expensive underground district heating pipe networks are needed which could be justified in cases of a high heat demand throughout the year. Thus, optimal planning of the system is necessary. Biomass should also be readily available [624, IRPP TWG 2013]. In the pig sector, only pig nurseries are likely to use the heating energy throughout the year [350, France 2010].

Economics

Wood is less expensive than fossil fuels and its price is more stable.

Poultry farms

In France, the investment cost for a wood-fired boiler of 240 kW of power is around EUR 90 000 (installation in 2006). This boiler consumes 110 tonnes of wood per year from a nearby sawmill and supplies heat to a broiler house of 1 200 m² and a turkey house of 600 m². In France, this investment may be subsidised for about 40–50 %, in which case the return on investment is around 7 years. Without subsidies, the return on investment would have increased by another 3.5 years [346, CA Bretagne 2009].

Pig farms

For a pig house of 3 300 m² (approximately 220 sows), 85 kW of power are needed at a total cost of EUR 400 per installed kW (except the equipment for the hot water circuit). The requirement for wood would be around 45 tonnes per year, which is covered by the utilisation of 9–14 km of copse hedges.

Driving force for implementation

The economic value is supplemented by the use of available copse and secondary sources that are not otherwise fully exploited, e.g. wood resources produced on the farm.

Example plants

In France, about 15 poultry farms are already equipped with biomass boilers.

Reference literature

[144, Finland 2010] [345, France 2010] [346, CA Bretagne 2009] [350, France 2010] [372, Spain 2013] [624, IRPP TWG 2013]

4.5.4.2 Efficient use of energy for ventilation

4.5.4.2.1 Management of ventilation in poultry houses

Ventilation is one of the main sources of energy consumption in the poultry sector; thus, the management of air circulation in the housing systems is important for controlling energy costs.

For animal welfare reasons, minimum ventilation rates should always be sufficient to provide fresh air, oxygen and sufficient humidity and to remove unwanted gases. General measures to reduce electricity for ventilation use are given below [95, UK 2010]:

- Select the correct type of fans and consider their position in the building.
- Install fans with a low energy use per m³ of air.
- Use the fans efficiently, e.g. operating one fan at full capacity is more economical than operating two at half their capacity.
- Maintain and keep fans and controlling devices clean.
- Select the appropriate size and shape of air ducts and preserve internal smoothness, in order to maintain maximum air throughput.
- Consider new plastic conical profile fan ducts.
- Ensure that ventilation cowls have smooth, slow internal bends to avoid restricting airflow.
- Use adjustable flap windows to optimise the ventilation needs.
- Use a variable speed drive for three-phase electric motors. Reducing the speed of the fan, by tailoring the speed to the exact requirement at any time, may allow significant energy savings (about 20 % and up to 50 %).

Optimisation of energy consumption can be assisted by the use of well-sited, fixed single-speed fans. Additional controls give the possibility to obtain an airflow and speed that match the variable needs for different ages, animal categories, stocking densities and climatic conditions [339, ITAVI 1997] [342, ADEME 2008] [349, ITAVI 1998] [355, Warwick 2007].

4.5.4.2.1.1 Circulating fans

Description

Circulating fans homogenise the speed of airflow at the level of animals without increasing the volume of air supplied by the central ventilation. Several types of circulating fans can be used: horizontal, vertical, or oscillating (sweeping). The description of circulating fans in vertical shafts aiming to dry litter is given in Section 4.6.4.2.1.

Fans are mainly used in meat poultry housing during summer, at the last stage of production. The airflow cools the birds by increasing their heat loss through convection [350, France 2010].

Achieved environmental benefits

Consumption of energy can be reduced as the ventilation system does not have to operate at maximum capacity when the objective is to cool the animals. Circulating fans do not necessarily decrease their net energy consumption when they direct warm air to litter.

In the Netherlands, circulating fans in vertical shafts are integrated into litter-based housing systems to reduce ammonia emissions by drying the litter. Details on this technique are given in Section 4.6.4.2.1.

Cross-media effects

Dust problems may arise.

Environmental performance and operational data

Circulating fans are placed at approximately 1 m above the litter and achieve air speeds of at least 0.8 m/s to every point of the living area, given that the recommended air speed is 1 m/s. According to the climatic conditions, 8 to 12 circulating fans with a capacity of 15 000–20 000 m³/h are needed for every 1 000 m² [350, France 2010].

Technical considerations relevant to applicability

Circulating fans cannot be installed where there are many obstacles in the buildings that could affect their efficiency or where the movement of people or nearby receptors may limit their use.

Driving force for implementation

Depending on the price of electricity, economic savings in heating may be higher than the costs induced by the electricity consumption of circulating fans.

Economics

Investment costs for the installation of vertical circulating fans with a capacity of 20 000 m³/h at 15-metre intervals along the length of the house and 2-metre intervals along the width are estimated at EUR 5/m² [350, France 2010].

Example plants

In France, 10 % of poultry buildings are equipped with circulating fans.

Reference literature

[339, ITAVI 1997] [349, ITAVI 1998] [350, France 2010] [354, ITAVI 2004]

4.5.4.2.1.2 Circulating fans in combination with heat exchangers

Description

This technique is fully described in Section 4.6.4.2.2, as it forms part of an integrated housing system. The technique consists of heating and drying the litter by the combined use of heat exchangers and ventilators. Incoming air is warmed up in a heat exchanger using the heat recovered from the indoor air. The ventilators spread the warm air equally over the litter.

Achieved environmental benefits

The reduction of energy requirements is achieved by means of heat exchangers. An additional environmental advantage consists of ammonia emissions reduction, achieved by the use of the combined system (heat recovery and circulating fans).

Cross-media effects

See Section 4.6.4.2.2.

Environmental performance and operational data

See Section 4.6.4.2.2.

Technical considerations relevant to applicability

See Section 4.6.4.2.2.

Driving force for implementation

See Section 4.6.4.2.2.

Example plants

See Section 4.6.4.2.2.

Economics

See Section 4.6.4.2.2.

Reference literature

[464, Netherlands 2010]

4.5.4.2.1.3 Equal spreading of recirculated air by indoor fans and heaters

Description

This technique is fully described in Section 4.6.4.2.3, as it forms part of an integrated housing system. The technique consists of heating the house by a combination of heaters and indoor ventilators. Ventilators drive warm air from the top of the building down to the floor level. The air is warmed up by thermal exchange with hot water produced by an indirectly fired thermal heater using propane or natural gas or by central heating. The ventilation system is completed with equipment to draw the air out in a horizontal direction, spreading the hot air all over the litter.

Achieved environmental benefits

An optimal indoor climate is achieved at low heating costs. A reduction of energy consumption for heating of around 20 % is achievable, with the related cost reduction, as a result of the good mixing of warm air from the ceiling with colder air just above the housing floor. Ammonia emissions are also reduced by the drying effect of the warm airflow to the litter.

Cross-media effects

See Section 4.6.4.2.3.

Environmental performance and operational data

See Section 4.6.4.2.3.

Technical considerations relevant to applicability

See Section 4.6.4.2.3.

Driving force for implementation

See Section 4.6.4.2.3.

Example plants

See Section 4.6.4.2.3.

Economics

See Section 4.6.4.2.3.

Reference literature

[470, Netherlands 2011]

4.5.4.2.1.4 Energy-saving fans

Description

The housing ventilation system can be automatically controlled according to the CO₂ concentration, resulting in a reduced air exchange.

Achieved environmental benefits

Heat losses due to the ventilation of buildings, and thus the extra consumption of energy for heating, can be minimised by optimising the air renewal, in order to achieve the minimum rates of ventilation in winter. In a litter-based system for the rearing of broilers, the energy

consumption is 70 % lower than in the conventional (old) housing system, while ammonia and odour emissions are reduced by 20–30 % due to the reduced air exchange.

Cross-media effects

No reported cross-media effects.

Environmental performance and operational data

The operating conditions and related energy consumption levels of a farm for the rearing of broilers, equipped with 'energy-saving fans', are presented in Table 4.43. The housing system has a capacity of 120 000 bird places and consists of two insulated buildings; each building with two compartments for 30 000 birds.

Table 4.43: Operating conditions and energy consumption of a broiler housing system equipped with energy-saving fans, in Finland

Parameter	Characteristics/consumption
Insulation	Walls: 140 mm mineral wool Ceiling: 300 mm blown wool (cellulose) Floor: not insulated
Cold season ventilation ⁽¹⁾	1 500–150 000 m ³ /h
Warm season ventilation ⁽¹⁾	15 000–300 000 m ³ /h
Annual fuel consumption for heating	1.42 kWh/ap/yr
Electricity	0.29 kWh/ap/yr
⁽¹⁾ Depending on the size of the birds.	
Source [144, Finland 2010]	

Technical considerations relevant to applicability

No technical restrictions are reported for the implementation of the technique.

Economics

The investment cost of a new broiler farm is reported to be equivalent to EUR 11.67 per animal place, and EUR 12.5 per animal place if it is equipped with energy-saving fans, i.e. the extra cost is equivalent to EUR 0.83 per animal place.

Driving force for implementation

The driving force is improved animal performance due to the achieved temperature uniformity. The average daily gain is reported to be approximately 3–4 g/d higher than the average value observed in Finland.

Example plants

Commonly applied in new farms for broiler rearing in Finland.

Reference literature

[144, Finland 2010]

4.5.4.2.2 Management of ventilation in pig houses

Description

Ventilation in pig housing can be optimised by the following measures:

- The rate of air exchange is primarily responsible for energy requirements for heating; therefore, it is crucial to control the flow of air and, in particular, to always adjust the minimum flow rate to the physiological needs of the animals, in order to ensure their health and welfare.

- Installing energy-efficient fans and equipment. Fans with the lowest possible specific consumption for a given airflow rate and air pressure rise are selected (see Section 4.5.4.2.3).
- Forced ventilation systems are designed, built and operated so that the flow resistance of the ventilation system is kept as low as possible, e.g.:
 - having short air ducts;
 - incorporating no sudden changes into the air duct cross sections;
 - limiting the changes in duct direction, or application obstructions (e.g. baffles);
 - removing any dust deposits in the ventilation systems and on the fans;
 - avoiding having rain protection covers above the discharge points.
- Fans with low-rated rpm (low-speed units) use less energy than those that operate at high rpm (high-speed units). Low-speed fans can, however, only be used if the ventilation system exhibits a low flow resistance (< 60 Pa).
- Fans designed on the basis of electronic commutation technology exhibit a significantly lower power requirement, particularly over the regulated speed range, compared with transformer-regulated or electronically regulated fans. If a series of fans is operated in order to ventilate a house, a multiple-series gang-switching arrangement of fans may be advisable. It means that successive activation or deactivation of each individual fan controls the volume of the airflow. For maximum efficiency, in such an arrangement each fan operates and contributes to the required ventilation volume at its full capacity. The volume of the airflow corresponds with the number of activated fans.
- The installation of air cleaning equipment significantly increases the flow resistance of forced ventilation systems. In order to deliver the requisite air rates, particularly in summer, higher-capacity fans with a higher specific power requirement may be necessary (see Section 4.9).
- The exhaust air in centralised ventilation systems is extracted from the building by using only one fan, whose specific consumption (W/m^3 of extracted air) is lower than the sum of the consumption levels of single fans required in room-by-room forced ventilation. By applying centralised ventilation, reported reductions of the energy consumption are generally between 20 % and 30 % [343, ADEME 2008]. Other measurements have shown a reduction of up to 60 % [350, France 2010].
- Monitoring of yearly fan clogging before the warm season. Removal of settled dust contributes to avoid overconsumption and improve the equipment life span.
- Frequency converter: in practice, most ventilators are powered by a 230 volt triac controller. An efficient control system that can be used to power a ventilator is a frequency converter, where the ventilators can work at low speeds without any decrease in energy efficiency. Fans must be of the 3×400 volt AC type and can be installed in each compartment of any pig or poultry shed. Benefits of the system include less energy consumption and less fan wear-out for less heat produced. Above all, all the compartments can be adjusted to receive between 5 % and 100 % ventilation, regardless of the influences of the weather (e.g. even in windy weather). The system works with the aid of measuring fans, installed in the shed compartments, that measure the need for ventilation. In connection to the main frequency controller, each compartment's ventilating fans are run at reduced speeds to produce the volume of air that is detected by the measuring fans. In practice, fans do not work at maximum speed at most times of the year and during the winter period fans seldom work above 25 % of their maximum speed. The power reduction achievable by using a frequency converter system is up to 69 %, compared to the 230 volt motors with the conventional system.

Achieved environmental benefits

Energy consumption and associated costs can be reduced. An optimised management of ventilation can lead to 50 % savings in heating costs [350, France 2010].

Cross-media effects

No information provided.

Environmental performance and operational data

In France, ventilation accounts for about 40 % of the total energy consumption at integrated breeding-to-fattening farms and about 90 % of the total energy consumption in fattening pig housing systems [344, ADEME 2008]. In Germany, ventilation represents 26 % of the total electricity consumption in fattening pig houses [624, IRPP TWG 2013].

From Table 4.44, it can be deduced that increasing the ventilation rate from the minimum recommended (in France) flow rate, at the beginning of the post-weaning cycle, of 3 m³/h per animal (which fulfils the physiological needs of the weaners), to a standard ventilation of 5 m³/h per animal can result in the doubling of the energy consumption for heating; the energy consumption per pig produced will be increased from 6.7 kWh to 12.3 kWh) [344, ADEME 2008] [350, France 2010]. The combined effect of insulation in reducing heat consumption is also presented. Good control of the ventilation rates can thus allow appreciable savings in heating costs, without degrading the environment and without additional investment.

Table 4.44: Heat consumption according to minimum ventilation flows and added insulation, for weaners at an early post-weaning age

Ventilation	Heat consumption	Heat consumption with 1 cm of insulation added
m ³ /h per animal	kWh per pig produced	kWh per pig produced
3	6.68	6.00
4	9.02	8.22
5	12.29	11.00
6	14.82	12.79
7	17.40	14.35

Source: [344, ADEME 2008]

The application of different ventilation rates results in, first of all, a modification of the indoor environment. Tests were carried out in France in order to determine the effect of the ventilation rate on the performance and health status of fattening pigs. Minimum and optimum ventilation rates were tested as presented in Table 4.45. Temperature (24 °C) and relative humidity (65 %) were kept constant throughout the experiment. It was found that the application of an optimum airflow made it possible to decrease the ammonia concentration by half. It was also found that, for the same type of floor, there were more germs in the environment when the minimum airflow was applied. Minimum flow was also associated with increased dust levels (20–30 %) [261, France 2010].

Table 4.45: Ammonia emissions and germs concentration in relation to the ventilation rate

Parameter	Floor characteristics	Optimum flow	Minimum flow
Ventilation rate (m ³ /hour/pig)	NR	15–50	8–19
NH ₃ (ppm)	Metal slats	7.5	15.1
	Concrete slats	6.6	16.8
Germs (number/m ³)	Metal slats	73	103
	Concrete slats	166	206

NB: NR = not relevant.
Source: [261, France 2010]

Technical considerations relevant to applicability

Centralised ventilation can be applied only to new buildings. An adjustable regulation of temperature and ventilation can be applied in both existing and new housing systems [261, France 2010].

Economics

The investment costs of a frequency converter system are quite similar to those of a conventional system. The purchase and installation of one or more regulation devices largely compensate the potential economic losses generated by poor control of the indoor climate [261, France 2010]. Energy-saving fans are still relatively expensive and their lifespan is short.

Good control of the ventilation rates can allow appreciable savings in the heating costs without degrading the indoor environment and without additional investment. For example, the potential energy cost savings in an integrated breeding-to-fattening farm of 200 sows are equivalent to EUR 1 650 per year.

The annual costs for the purchase and installation of large fans with a capacity of 100 000 m³/h for a house of 250 sows are estimated to be between EUR 0.03 and EUR 0.04 per pig produced, equivalent to less than EUR 1 per tonne of fattening pigs produced. This value is calculated with a payback period of 10 years [350, France 2010].

Driving force for implementation

Even though the cost of centralised ventilation is higher than conventional ventilation, it allows for the installation of end-of-pipe air cleaning systems and of heat exchanging equipment (air-air and air-water).

Example plants

These measures are widely applied.

Reference literature

[261, France 2010] [343, ADEME 2008] [350, France 2010] [355, Warwick 2007] [395, ADAS 1999] [624, IRPP TWG 2013]

4.5.4.2.3 Use of high-efficiency ventilation systems

Description

High-efficiency ventilation systems consist of efficient fans and ducts. Fan efficiency, which can vary significantly, is stated in airflow per unit of energy (e.g. m³/h per W). The system provides the rated air throughput of the fan at the operational pressure it requires, together with the energy rating. Ventilation inlet and outlet ducting should be sized adequately. The internal surfaces should be smooth and clean with slight bends.

The following characteristics should be noted when considering the efficiency of fans:

- fan efficiency generally increases with the impeller diameter;
- belt-driven fans are generally more efficient than fans with direct drives;
- fans fitted with patented 'bell-mouths' to smooth the passage of the air will be 10 % more efficient than fans fitted into a basic circular diaphragm;
- fitting 'cones' to outlet fans will increase efficiency by 10–15 %.

Achieved environmental benefits

Energy consumption is reduced.

Cross-media effects

None reported.

Environmental performance and operational data

In pig farms, energy-saving fans can reduce the associated energy consumption for ventilation by up to 60 % [350, France 2010].

Most manufacturers produce performance characteristics measured to ISO 5801, which can be used for the selection of the most efficient unit.

Technical considerations relevant to applicability

High-efficiency ventilation systems may not be applicable to existing plants.

Economics

When installing fans, the energy cost of the fan over its operational life has to be taken into account as well as its initial capital cost. It is reported that a 10 % higher investment to secure a 10 % energy saving will pay back in around 18 months.

Driving force for implementation

No information provided.

Example plants

No information provided.

Reference literature

[350, France 2010] [356, Carbon Trust 2005]

4.5.5 Heat recovery**4.5.5.1 Heat exchangers****Description**

There are three major types of heat exchangers for energy recovery (see Section 2.14.2):

- air-air heat exchangers;
- air-water heat exchangers;
- air-ground heat exchangers.

In the air-air heat exchanger, the incoming air absorbs heat from the exhaust air from the house, without mixing the two airflows. The device can be composed of plates of anodised aluminium or PVC tubes [344, ADEME 2008].

In the air-water heat exchanger, water flows through aluminium fins or plates located in the exhaust ducts and absorbs heat from the exhausted air. Then, the water feeds the fan coil placed at the air intake of the housing system.

Air-ground heat exchangers absorb heat from and/or dissipate heat to the ground. In the air-ground heat exchanger, fresh air is circulated through pipes buried at a depth of, for example, about two metres. Air-ground heat exchangers take advantage of the low seasonal temperature variation of subterranean soil in order to warm or cool air.

Heat recovery is also possible from the scrubbing waters of air cleaning systems or the exhaust gases of biogas engines; however, these types of application are not always practicable.

Achieved environmental benefits

Heat recovery enables lower energy consumption for heating, by providing an additional source of heat.

In the broiler sector, the use of air-air heat exchangers coupled with circulating fans, to evenly distribute the heated air over the litter, have shown promising ammonia emission reductions. This technical combination is described in Section 4.6.4.2.2.

Cross-media effects

For air-ground heat exchangers, relatively large soil areas are required. For air-air exchangers, there is an increase in electricity consumption. In air-water heat exchangers, the pump for the recirculation of water consumes electricity.

Heat exchangers need to be cleaned often, in order to avoid clogging. Cleaning and disinfection of air-air exchangers should be done during the sanitary emptying on poultry farms.

Environmental performance and operational data

Pig farms

In air-air heat exchangers in pig rearing, the theoretical maximum yield ranges from 50 % to 55 % on an annual basis; this means that, if exhaust air is removed at 24 °C, the incoming air can be heated up to 12 °C with an outside temperature close to 0 °C.

According to a study on energy consumption, 36 % of the total energy of an integrated pig farm (breeding and fattening) is used up in weaner production, with the majority of it (80 %) used to heat the rooms, i.e. approximately 14 kWh per pig produced [344, ADEME 2008]. Air-air heat exchangers allow a reduction of the electricity consumption for heating of 30 % to 50 % in houses for weaners. Therefore, the application of air-air heat exchangers in weaner houses would allow for a recovery of 4–7 kWh per pig produced.

On the basis of the theoretical heat recovery achievable with the application of air-air or air-water heat exchangers, the necessary higher temperatures needed in the rearing of weaners (e.g. at the entry of the piglets or in cold periods) can only be achieved with a complementary heating system.

Air-air heat exchangers achieve higher yields in the cold season when heat is required the most. Table 4.46 shows an example of an air-air heat exchanger reported by France.

Table 4.46: Example of operational data of an air-air heat exchanger

Outdoor temperature (°C)	Incoming air temperature (°C)	Indoor warmed air (°C)	Recovered energy (W/pig)
-9.4	2.6	12.0	97
-4.9	6.4	11.3	89
0.0	9.2	9.2	69
4.4	11.6	7.2	46
7.8	13.9	6.1	41

Source: [350, France 2010.]

The maximum thermal gain obtained by air-water heat exchangers is reported to be 12 °C when the outdoor air temperature is 0 °C [345, France 2010]. The performance of this type of heat exchanger will mainly depend on the technical dimensions of the system (e.g. surface of fins, water flow) and proper maintenance (e.g. control of dust contamination of fins). Electricity savings for heating requirements is estimated at about 50 %. Limited data concerning the performance of air-water heat exchangers applied in the poultry or pig sectors were available and a limited number of applications is reported [350, France 2010].

The air-ground heat exchanger requires careful dimensioning, in order to ensure a good performance. Air is circulated in underground pipes (at a depth of approximately two metres); one pipe of 16 cm in diameter and 25 m in length is necessary for every three fattening pigs.

Poultry farms

In the Netherlands, air-air exchangers applied in litter-based broiler houses are reported to have a capacity of 0.35 m³ per animal place/hour for a normal type of heat exchanger, and up to 1.0 m³ per animal/hour for an improved type [464, Netherlands 2010].

In France, air-air exchangers applied in litter-based houses for broilers, turkeys or guinea fowl are reported to have a minimum capacity of 8 m³/h per m²; for organic production and poultry breeding, the minimum capacity is reported to be 2.5 m³/h per m² [624, IRPP TWG 2013].

A survey carried out in France among 200 farmers using air-air exchangers for at least 6 months showed a 30 % reduction in gas consumption, as well as a decrease in relative humidity of 11 % and a 15 % reduction in the quantity of litter produced. In 40 % of the cases, an air quality improvement was reported (e.g. ammonia). The survey also indicated that an average time of 73 minutes per equipment and per batch was required for cleaning, while the farm's electric consumption was shown to increase by 7 % on average [624, IRPP TWG 2013]. In general, air-air heat exchangers in poultry production can allow shorter heating periods and can ensure the proper ventilation rates during the start-up of the cycle. They also contribute to the maintenance of a steady indoor temperature and a lower humidity (10 % lower on average). The reduction in propane consumption for heating ranges from 25 % to more than 50 % depending on the season, and the type and the size of the exchanger [345, France 2010].

Results of another investigation carried out over 1 year of operation showed the following achievements:

- a decrease in propane consumption for birds aged six days and over;
- radiant heaters were turned off 10 days earlier in the test building, for turkeys.

Test results concerning propane and electricity consumption on three different farms applying air-air heat exchangers are summarised in Table 4.47.

Technical considerations relevant to applicability

There are no serious limitations to the application of heat exchangers, except the cost of the equipment, which is still relatively high, and the cost for additional cleaning (see Economics). The ventilation design becomes a limitation when retrofitting the technique in naturally ventilated existing houses.

Air-ground heat exchangers cannot be implemented when there is not enough available space in the farmyard, due to the high demands for soil surface. Heat recovery from scrubbing waters and from exhaust gases of engines is often not practicable. In the poultry sector, air-air heat exchangers are mainly applied [350, France 2010].

Economics

Poultry farms

In the poultry sector, for a standard poultry house of 1 200 m², two heat exchangers with a capacity of 5 000 m³/h are needed. The necessary investment is about EUR 8.3–10/m² and the additional operating costs for electricity about EUR 0.13/m² per year. In this case, savings due to avoided propane consumption are around EUR 1/m² per year and the investment payback time in the range of 9.5–11.4 years [350, France 2010]. For a standard density of 22.8 birds/m², the investment costs would be EUR 0.36–0.44 per animal place, the operating costs EUR 0.006 per animal place and savings around EUR 0.167 per animal place [418, ITAVI 2010].

For one heat exchanger of 15 000 m³/h, serving two buildings of 1 200 m² each (total surface of 2 400 m²), the investment costs amount to approximately EUR 23/m²; the related additional electricity consumption is EUR 0.06–0.09/m² per year, and the annual saving in gas consumption is EUR 2–2.4/m² (50–60 % savings). The payback time for the investment for the heat exchanger will be between 9.7 and 11.9 years [350, France 2010].

Test results report that yearly savings of propane gas range between 18 % and 27 %. The additional electric energy consumption, due to the heat exchangers, would cost only 8–27 % of the cost saving in propane gas [466, Bonnouvrier et al. 2009]. Data concerning propane and electricity consumption and related costs are reported in Table 4.47, for three different applications of air-air heat exchangers in the poultry sector.

Table 4.47: Propane and electricity consumption and costs, in three different poultry farms applying heat recovery by air-air heat exchangers

Parameters		Unit	Trial 1	Trial 2	Trial 3
Surface area of building		m ²	1 200	1 300	1 200
Animal type		NA	Turkeys	Broilers	Broilers
Batches/year		NA	2.5	7.5	7.6
Heating system		NA	Adjustable radiant heaters	Indoor space heaters	Adjustable radiant heaters
Ventilation		NA	Mechanical	Natural	Natural
No of heat exchangers		NA	2, on long wall, opposite fans	3, on long wall	2, on long wall
Heat exchanger operation		NA	Cyclical	Cyclical	Progressive
Propane consumption	Control building	kg/m ² /year	4.73	12.4	5.6
	Test building	kg/m ² /year	3.47	10	4.6
Propane saving achieved		kg/year	1 572	3 107	1 125
		%	27	18	20
		EUR/year ⁽¹⁾	1 165	2 300	832
Additional electricity consumption due to heat exchangers		kWh/year	2 185	7 946	2 918
		EUR/year	98	486	230
Investment payback time ⁽²⁾		years	7.7–9.2	NI	NI
Investment payback time with 40 % subsidy		years	4.6–5.5	NI	7.6
⁽¹⁾ Gas price: EUR 740/t. ⁽²⁾ Investment cost for two heat exchangers: EUR 10 000–12 000. NB: NI = no information provided; NA= not applicable. Source [466, Bonnouvrier et al. 2009]					

In the poultry sector, cleaning and checking operations are carried out at the end of each cycle and require 1.5–2 hours per unit [464, Netherlands 2010].

Pig farms

The investment cost for an air-air heat exchanger is estimated at EUR 0.7 per m³ of exhaust air (capacity of 25 000 m³/h for a farm of 250 sows, amortisation over 10 years, interest and subsidies excluded). The air-air heat exchanger would allow a saving of EUR 2 to EUR 4 per tonne of pig produced [350, France 2010].

The costs of air-ground systems vary depending on the method of drilling the soil, the type of tubes and fans, the surface necessary, etc. In the pig sector, the cost of an air-ground heat exchanger is reported to be between EUR 60 and EUR 80 per fattening pig place, which

includes the excavation (20 % of the price), a concrete reception pit (55 %), purchase of the tubes (15 %) and ventilation (10 %).

Driving force for implementation

A reduction of energy costs may encourage the adoption of this technique. Heat exchangers allow the improvement of ventilation (i.e. the number of air changes of the indoor air and those during cold periods) in mechanically or naturally ventilated buildings, without decreasing the indoor temperature while improving the environment for the animals.

Heat exchangers present the advantage of warming the air before it enters the building, which reduces the risks related to the effects of cold air on animals and offers more flexibility in the management of ventilation.

At the start-up of the rearing cycle in a broiler farm, an ambient temperature of around 32 °C is necessary in order to ensure the thermal comfort of young chicks. At the same time, a minimum airflow is required to remove undesirable gases and allow fresh air to enter. Introducing cold air into the building, and heating it up to replace the heat extracted with the exhaust air, consumes large amounts of energy. As a result, options for recovering energy from the outgoing air, in order to heat the incoming air, represent an attractive solution. In the poultry sector, benefits to the litter and air quality are also claimed, as well as to birds' physical performances.

Example plants

In France, the UK and the Netherlands, these techniques are becoming more common in poultry rearing. In 2012 in France, almost 20 % of poultry farmers had invested in air-air exchangers. In France, air-air heat exchangers are already common in the pig sector and they are mainly used to preheat air in weaner houses; some air-water heat exchangers are connected to water scrubbing systems.

Reference literature

[344, ADEME 2008] [345, France 2010] [352, Bartolomeu 2005] [353, CA Pays Loire 2009] [350, France 2010] [418, ITAVI 2010] [464, Netherlands 2010] [466, Bonnouvrier et al. 2009] [624, IRPP TWG 2013]

4.5.5.2 Heat pumps for heat recovery

Description

Heat pumps are devices designed to move thermal energy in the opposite to that of the natural heat flow by absorbing heat from a cold location and releasing it to a warmer one, and vice versa. Heat is absorbed from various media and circuits, such as slurry cooling systems, geothermal energy, scrubbing water, slurry biological treatment reactors, biogas engine exhaust gases, and is consumed on farm, usually in buildings. For this purpose, a fluid circulating in a sealed circuit transfers the heat to another location under the operating principle of the reverse refrigeration cycle (see Section 2.14.3 and Figure 2.43). Liquids used in other operational circuits are preheated with the heat that is transferred, to produce sanitised water, or to feed a heating system and may even be used in cooling systems. Heat pumps mostly recover heat in air-air, air-water and water-water circuits.

Slurry cooling

The technique is frequently combined with slurry cooling systems, adding mutual benefit to each technique (see Sections 4.7.1.7 and 4.7.1.8).

Geothermal energy

As a result of the constant moderate temperature that is maintained below the surface of the earth throughout the year due to solar radiation absorption, a sealed underground piping loop filled with circulating water is connected to a heat pump to exchange heat between housing and the ground or a shallow aquifer (less than 100 m). The heat pump uses the earth as a heat source

in the winter, i.e. water circulating in the piping loop absorbs heat and carries it to the heat pump, or a heat sink in the summer, i.e. the heat pump absorbs heat from the air and transfers it to water circulating in the piping loop where it is absorbed by the earth.

Scrubbing water

Heat is recovered from the scrubbing water of air cleaning systems which has to be collected in sufficiently large basins.

Biological reactors

They can provide working temperatures as high as 25 °C.

Biogas engines' exhaust gases

Heat can also be recovered from the exhaust gases from biogas engines in combined heat and power units (see Section 4.12.5). The recovered heat is normally used for heating piglet areas [373, UBA Austria 2009].

Achieved environmental benefits

Improvement of the farm's energy balance.

Cross-media effects

A heat pump uses some external power to accomplish the work of transferring energy from the heat source to the destination (heat sink).

Environmental performance and operational data

Compared to the classic heating applied in weaner houses (average consumption of 9 kWh/piglet per year), geothermal heat recovery allows savings of about 50 % while heating energy savings of around 70 % are possible after heat recovery from a biological reactor or from scrubbing waters. Heat pumps based on biological reactors and water from the scrubbing systems are more efficient than those based on geothermal energy because the temperatures of the water of scrubber and of the biological reactor are stable and not associated with climatic conditions [350, France 2010].

The coefficient of performance of a geothermal heat pump and of a heat pump connected to a biological reactor pump is about 2–3 (i.e. for 2–3 kWh recovered, 1 kWh of electric energy is consumed); for scrubbing waters at about 20 °C, the coefficient is up to 4.

Technical considerations relevant to applicability

The technique can be applied in both the poultry and pig sectors.

For geothermal heat recovery when using horizontal pipes, the principal constraint is that a surface approximately twice as large as the surface of the building to be heated is required. As a consequence, this technique is still not very common and is not suitable for farms with relatively small land availability which cannot meet the surface requirements. Where space is limited, a vertical piping loop can be inserted into boreholes.

The position of buildings, their layout and available space may limit the suitability of this technology for retrofitting [624, IRPP TWG 2013].

Economics

The investment cost of a heating system for weaners with warm water and a geothermal heat pump is reported by France at EUR 45–55 per animal place, which has to be compared with the cost of a standard heating system of EUR 35 per animal place.

The reduction of energy consumption allows savings estimated at about EUR 0.01 per kg of pig produced.

Driving force for implementation

Heat pumps can be successfully coupled to underfloor heating, hence reducing the inconvenience of the traditional air convection systems.

Incentive payments for using renewable energy can justify the adoption of this technique. Ground and water source heat pumps are included in the Renewable Heat Incentive financial support programme in the UK.

Example plants

Geothermal heat recovery is used in Finland. Heat pumps in air-water circuits have been installed at existing pig units in Ireland [624, IRPP TWG 2013]. Heat pumps are used in Denmark and the Netherlands in slurry cooling systems.

Reference literature

[344, ADEME 2008] [348, Bartolomeu 2008] [350, France 2010] [373, UBA Austria 2009] [624, IRPP TWG 2013]

4.5.5.3 Heat recovery in broiler housing with heated and cooled littered floor (combideck system)**Description**

This system consists of heat exchangers below the concrete floor. In particular, a closed water circuit, serving the house, made of hollow strips (intermediately spaced every 4 cm) is installed in an insulated layer below the floor, at a depth of 10–12 cm. Another water circuit is built at a deeper level below the floor (2–4 metres) for storing the excess heat or to return it to the broiler house when needed. A heat pump connects the two water circuits (see Figure 4.7). Depending on the temperature of the water that flows through the strips, the floor and the litter will either be warmed up or cooled down.

When the broilers enter on the first day of the production cycle, water is warmed up and fed through the strips below the floor to warm the floor. Broilers need some heat until about day 21 (about 28 °C). After a short period of equilibrium, the growing process generates a lot of heat and this heat is normally radiated into the soil below the building. This heat is now absorbed by the cold water in the circuit below the floor and the heat pump moves the heat to the second water circuit which stores the heat underground. At the same time, the broilers are cooled down and the temperature is maintained at about 25 °C.

After the broilers leave the housing, the floor is emptied and cleaned. Once ready for the next production cycle, the warm water from the underground storage is pumped up and is run through the heat pump, warming the water in the water circuit that serves the house. The floor is preheated and less energy will be needed to warm the floor to the temperature required for housing young broilers. Once the broilers are in the house (Phase 1), the stored heat is used and only a little extra heating may be required. After the short intermediate phase of thermal balance (Phase 2), cooling is required again (Phase 3) and the heat dissipated from the housing will be stored underground and will be available for the next production cycle.

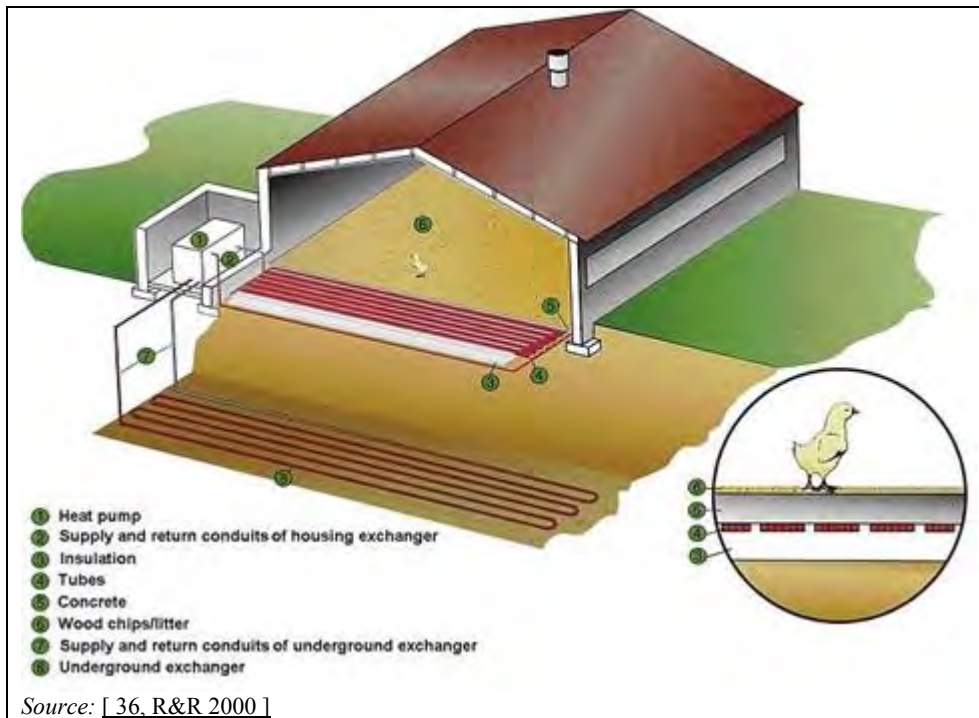

Figure 4.7: Schematic representation of a heat recovery system installed in a broiler house

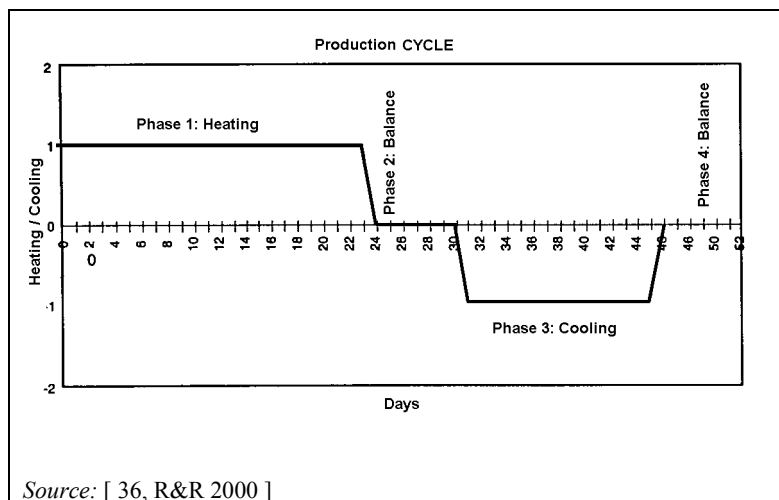

Figure 4.8: Graphic representation of the working principle of the combideck system during one broiler production cycle

Achieved environmental benefits

The reduction of energy use is the main achieved benefit. The amount of energy depends on the farm; a reduction of up to 50 % in energy use has been achieved. Furthermore, preheating the floor prior to littering and introducing poultry and heating the floor during the first period of the rearing cycle keep the litter dry by avoiding moisture condensation, hence preventing ammonia volatilisation. Subsequent cooling of the floor at a later stage of the rearing period decreases microbial activity, which reduces the breakdown of uric acid.

The NH₃ reduction efficiency depends on local conditions and can be up to 40 % at a cost of EUR 6 per kg of NH₃ abated per year [508, TFRN 2014].

Cross-media effects

The storage of heat is achieved at the (electrical) expense of the heat pump. The increased consumption of electricity for the pump is offset by the reduced heat and ventilation

requirements. The coefficient of performance of ground source heat pumps is usually between 2.5 and 3; however, for the specific application presented in Table 4.48, the coefficient of performance was reported as 4.4.

Environmental performance and operational data

Data to illustrate the results of a combideck application are presented in Table 4.48. For 80 000 broilers, three heat pumps of 0.1 kW_e were used. Broilers were stocked at a density of 18 birds/m².

Table 4.48: Results of the application of the combideck system

	Fuel type/ fuel use	Input	Energy equivalent (MWh/yr)	Costs ⁽²⁾ (EUR)	CO ₂ (tonne) ⁽³⁾
Reference situation	Fuel oil	49.5 m ³	549	6 273	65.0
	Natural gas	36.1 m ³	321	9 277	158
	Electricity	40 MWh	40	3 757	14.8
	Total		910	19 307	237
Combideck system applied	Heating	63.6 MWh	63.6	NI	23.5
	Ventilation	34.4 MWh	34.4	NI	12.7
	Heat pump ⁽¹⁾	189 MWh	189	NI	44.4
	Total		287	9 194	80.6
Reduction (as percentage of reference)			623 (70 %)	10 113 (52 %)	156.4 (66 %)
⁽¹⁾ Coefficient of performance heat pump: 4.4. ⁽²⁾ Reference year 1999, corrected for low and peak tariffs on electricity prices in the Netherlands. ⁽³⁾ CO ₂ equivalent: oil 3.2, gas 1.8, electricity 0.37. NB: NI = no information provided. Source: [36, R&R 2000]					

In the above test, the reference farm emitted 0.066 kg NH₃ per broiler place per year, while the average ammonia emissions over four measured production cycles were 0.045 kg NH₃ per broiler place per year. Hence, the reduction of the NH₃ emission of this system was about 32 %.

In 2001, the performances of raising broilers on one farm in two different houses were compared. One house was equipped with the combideck system (House 2) and the other house without (House 1). The summary of the achievable performance is given in Table 4.49.

Table 4.49: Comparison of performance for identical houses with and without the combideck system

	House 1	House 2 (Combideck)
Total birds	33 000	34 000
Mortality (%)	4.97	2.85
Harvesting weight (grams) 1 st time at 35 days	1 681	1 692
Harvesting weight (grams) 2 nd time at 42 days	2 250	2 236
Surplus payment per kg (EUR)	0.2	0.4
Feed ratio (1 500 grams)	1.55	1.40
Heating costs (per broiler in EUR)	3.13	2.10
Source: [43, COM 2003]		

The reuse of heat generated in an earlier production cycle can reduce the ventilation rate by around 14 %.

Technical considerations relevant to applicability

This technique is not applicable to pig plants. This system can be applied in both new and existing poultry houses. If constructed in existing houses, the costs are higher because floors need to be ripped up and reconstructed in order to lay the necessary underfloor circuits. Construction and ground works will be needed in the farmyard, depending on the position of the broiler house.

With several broiler houses, it may be possible to use heated water from one house (being emptied) to warm another (to be stocked), which may reduce the energy needed for pumping even further. However, this idea has not yet been put into practice.

The system can be applied only if soil conditions allow the installation of closed underground storage of the circulated water. The technique is less suitable in areas with hard and rocky soils. Application of the combideck system in colder climates where the frosts are longer and harder and penetrate the soil was not reported.

Economics

Investment costs (for new houses) are EUR 2 per broiler place with 20 broilers per m². Operating costs (depreciation, interest and maintenance) are EUR 0.20 per broiler place per year. The annual increased yields reportedly outweighs the yearly operating costs by a factor of about 3. For instance, veterinarian costs are reduced by about 30 %. Energy costs are reduced by about 52 %. The payback time is about 4 to 6 years [544, Netherlands 2002].

Driving force for implementation

The system has a better performance in terms of broiler production (reduction of mortality, higher meat price, better feed ratio) and a positive effect on animal welfare (less heat stress, lower mortality, less veterinary services needed).

Example plants

In the Netherlands, around 2 million places were available in 2008 that were built with this technique [468, CBS 2011]. Also, 10 systems are reported to have been built in Germany and Russia in 2010.

Reference literature

[36, R&R 2000] [43, COM 2003] [468, CBS 2011] [508, TFRN 2014] [544, Netherlands 2002]

4.5.6 Natural ventilation

Description

Natural (or free) ventilation in the animal house is caused by thermal effects and/or the wind flow (pressure differences). Naturally ventilated animal houses should be oriented at right angles to the main wind direction, if possible, and permit a free airflow to the animal house in order to enhance an optimal flow of fresh and outgoing air. For this purpose, the animal houses should have openings in the ridge and, if necessary, also on the gable sides in addition to controllable openings in the side walls. In contrast to forced ventilation, no defined air volume flow can be set. Free ventilation can be combined with elements of forced ventilation (i.e. fan assistance in hot weather).

The lowering of the indoor temperature and ventilation rate must take into account animal welfare and production considerations. Design recommendations, in particular for the dimensioning of the fresh and exhaust air openings, are given in the literature.

Natural ventilation can be automatically controlled. In this case, openings or vents in the sides or roof are opened and closed by electrically driven motors in response to sensors in the building.

Achieved environmental benefits

With regard to energy requirements, energy savings can be obtained from the animal housing as in free ventilated houses ventilation and heating are not necessary. A reduced potential for ammonia emissions has also been reported due to the lower temperatures.

Cross-media effects

Higher labour requirements are reported due to more difficult cleaning and disinfection as well as a greater need for repairs.

Environmental performance and operational data

Various natural ventilation systems applied in pig and poultry houses are presented in Table 4.50.

Table 4.50: Different natural ventilation configurations

Animal category	Natural ventilation system	Mode of operation
Pigs, poultry	Cross ventilation	Air exchange takes place via large-area openings in the side walls, whose cross section can be varied using blinds or wind protection nets, for example. The air exchange is supported by ridge slits in the winter and additionally by openings on the gable side if the airflow is parallel to the ridge in the summer.
Pigs	Open front	The animal house, which is closed on three sides, is ventilated through the open front side. The front side can be equipped with wind protection nets.
Pigs	Shaft ventilation	The fresh air flows into the animal house through flaps or windows in the side or gable walls, while the outgoing air leaves the animal house through one or several shafts. In the summer, natural ventilation should be supported by opening doors and gates or by means of additional ventilation.
<i>Source:</i> [474, VDI 2011]		

In pig production, automatically controlled naturally ventilated housing systems in straw-based systems achieve reduced energy consumption as straw allows the animals to self-regulate their temperature, protects them from low temperatures and, thus, less energy is required for ventilation and heating [508, TFRN 2014].

Technical considerations relevant to applicability

It is not always possible to reduce the overall energy consumption by applying natural ventilation in animal houses as the energy demand for heating the house may increase. The final net energy balance may depend on the climatic conditions, the species and the physiological stage of the animals. For example, in France, buildings with natural ventilation used for broiler production register higher energy demands for heating than mechanically ventilated houses [350, France 2010].

In pig houses, natural ventilation may not be applicable to housing systems with littered floors in warm climates and to housing systems without littered floors or without covered, insulated boxes (e.g. kennels) in cold climates.

In poultry houses, natural ventilation may not be applicable during the initial stage of rearing (apart from duck production), or in those farms under extreme climatic conditions. Natural ventilation cannot be implemented in houses with a centralised ventilation system.

Driving force for implementation

Improved animal welfare.

Example plants

The technique is commonly applied.

Reference literature

[350, France 2010] [474, VDI 2011] [508, TFRN 2014] [575, UBA Germany 2011]

4.6 Techniques for the reduction of emissions from poultry houses

In general, the following principles can be applied in order to reduce ammonia emissions from poultry houses [508, TFRN 2014]:

- reducing the ammonia-emitting surface;
- removing the manure frequently to an external store (e.g. with belt removal systems);
- quickly drying the manure;
- using surfaces which are smooth and easy to clean;
- treatment of exhaust air by acid scrubbers or biotrickling filters;
- lowering the indoor temperature and ventilation as much as animal welfare and/or production allow.

Emission data reported in the tables may be accompanied (when the information is available or considered relevant) by a note indicating the type of data they refer to. When available, this information is intended to qualify the origin of the values and it should be read as indicated in the footnotes to the tables.

4.6.1 Techniques for cage housing of laying hens

Ammonia emission reduction in enriched cages is achieved by frequent manure removal from the house (e.g. twice a week) using manure belts. Equivalent or better results can be achieved by drying manure on belts with less frequent (e.g. weekly) removal. Emissions of ammonia from laying hen droppings result from chemical reactions in the manure that start immediately after excretion. The organic nitrogen (uric acid) is quickly transformed into ammonia by reactions that are enhanced by manure temperature and moisture content. Drying the manure is a way to inhibit the chemical reactions and thus reduce emissions. The quicker the manure is dried, the lower the emission of ammonia. Two main techniques are applied that create an airstream over the manure belt, which enhances the drying of the droppings:

- Forced air manure drying: air, which is normally preheated, is blown over the manure collected on a manure belt through a perforated tube.
- Whisk-forced air drying: a series of whisks situated above a manure belt are operated by a connecting rod which drives all whisks in the row simultaneously, so moving the indoor air and drying the manure.

A combination of frequent removal and the drying of manure gives the best reduction of ammonia emissions from housing and also reduces emissions from storage facilities, but with an associated energy cost. However, the whisk-forced drying achieves, with lower energy input, a similar emission reduction to forced air drying.

Pre-dried manure from ventilated belts has the advantage of being easier to stack and also to heat up considerably in the covered store with consequent further drying. Equipment for managing manure is integrated into the manufactured cages, such as manure belts and optional ventilation systems.

The principles underlying the reduction of ammonia in Sections 4.6.1.1 and 4.6.1.2 are the same. A summary of the reported emissions associated with the different housing systems is given in Table 4.51. Where relevant, information concerning the operating conditions and the type of emission data (i.e. measured, estimated) are also given.

Table 4.51: Summary of relevant reported achievable emissions in cage systems for laying hens

Description	NH ₃	CH ₄	N ₂ O	PM ₁₀	Odour	Source
	(kg/ap/yr)				(ou _E /ap/s)	
Section 4.6.1.1 Enriched cages						
Two removals per week. No manure drying	0.05–0.10	NI	NI	NI	NI	[508, TFRN 2014]
Belts without drying	0.117 ⁽¹⁾	NI	NI	NI	NI	[614, UK 2013]
	0.0342					[667, Spain 2011]
Belts with drying	0.0318	NI	NI	NI	NI	[667, Spain 2011]
At least two removals per week. No manure drying	0.04–0.08 ⁽¹⁾	NI	NI	NI	0.37 ⁽¹⁾ ⁽²⁾	[56, Denmark 2010]
Two removals per week. No manure drying	0.035–0.038 ⁽³⁾	NI	NI	NI	NI	[57, Denmark 2010]
Three removals per week. No manure drying	0.028 ⁽³⁾	NI	NI	NI	NI	
One or two removals a day. No manure drying	0.020 ⁽³⁾	NI	NI	NI	NI	
One or two removals per week. No manure drying	0.035 ⁽⁴⁾	0.078 ⁽⁴⁾	NI	0.01 ⁽⁴⁾	NI	[500, IRPP TWG 2011]
One removal per week. With dried manure on belt	0.035 ⁽⁴⁾	NI	NI	0.01 ⁽⁴⁾	NI	
Two or three removals per week. With dried manure on belt	0.010–0.040 ⁽⁴⁾	0.078 ⁽⁴⁾	NI	0.01 ⁽⁴⁾	NI	[84, UK 2010]
One removal per week. No manure drying ⁽⁵⁾	0.079 ⁽⁶⁾	0.037 ⁽⁶⁾	0.0024 ⁽⁶⁾	NI	NI	[68, Spain 2010]
Two removals per week. No manure drying ⁽⁵⁾	0.039 ⁽⁶⁾	0.034 ⁽¹⁾	0.0017 ⁽⁶⁾	NI	NI	[69, Spain 2010]
Two removals per week. With dried manure on belt	0.044 (0.017–0.071 ⁽⁶⁾)	NI	0.011–0.023 ⁽⁶⁾	NI	NI	[635, Le Bouquin et al. 2013]
Section 4.6.1.2 Small groups in enriched cages						
One removal per week. With dried manure on belt	0.03 ⁽¹⁾ (0.017–0.040) ⁽⁶⁾	NI	NI	0.023 ⁽¹⁾	0.350 ⁽¹⁾	[67, Netherlands 2010]
One removals per week. No manure drying	0.150 ⁽⁶⁾	NI	NI	0.04 ⁽⁶⁾	0.102 ⁽⁷⁾ ⁽¹⁾	[63, Germany 2010] [474, VDI 2011]
One removal per week. With dried manure on belt	0.040 ⁽¹⁾	NI	NI	0.04 ⁽¹⁾	0.102 ⁽⁷⁾ ⁽¹⁾	[63, Germany 2010]
⁽¹⁾ Derived from measurements. ⁽²⁾ Calculated from a reported value of 219 ou _E per 1 000 kg of live weight for an average weight of 1.7 kg. ⁽³⁾ Modelled values based on experiment results of Table 4.45 and a reference emission of 0.083 kg of NH ₃ /animal/year. ⁽⁴⁾ Modelled values (e.g. results based on N balance). ⁽⁵⁾ Fogging (see Section 4.8.3) was occasionally used during measurements. ⁽⁶⁾ Measured values. ⁽⁷⁾ Figures derived from the associated emission value of 30 ou _E /(LU s) for an average weight of 1.7 kg. NB: NI = no information provided.						

4.6.1.1 Enriched cages

Description

Cages are enclosures with sloping floors made of welded wire mesh or plastic slats. ‘Furnished’ or ‘enriched’ cages provide laying hens with increased space compared to conventional cages and are equipped with structural features like perches, a nest box and litter or a scratch area to stimulate natural behaviour. Additional equipment is available for feeding, drinking and egg collection. The system is described in Section 2.2.1.1 and a cross section is illustrated in Figure 4.9.

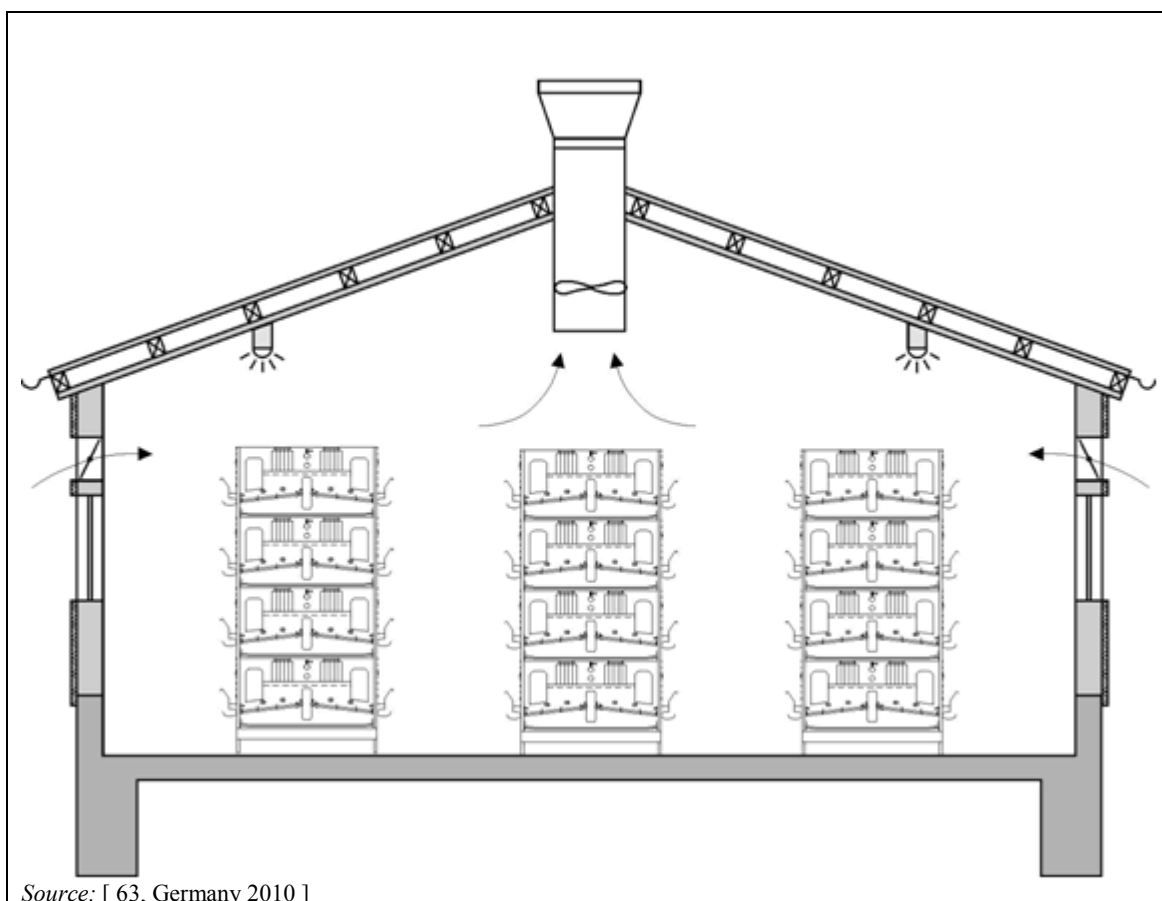

Figure 4.9: Scheme of rows of enriched cages for laying hens

The cages are arranged vertically on three or more tiers and often organised in two groups, with an intermediate platform between the fourth and fifth tier [368, France 2010].

A belt is placed under each tier for the removal of manure. When the collection belt is aerated by an air duct system, dried droppings with a dry matter content of at least 55 % are obtained compared to a dry matter content of 25–35 % without drying. High drying levels are difficult to reach when the manure is removed very frequently.

The reference system for manure removal from enriched cages consists of a belt underneath the cages, with two removals a week without drying [508, TFRN 2014].

Achieved environmental benefits

Ammonia, odour, methane and N_2O emissions are reduced as a consequence of the frequent manure removal and of the possible forced drying. Reductions are higher with more frequent removal, but the effect is not directly proportional.

Cross-media effects

The energy consumption increases with increasing frequency of use of the operating conveyer belt and manure drying. As the removed manure has a high N content, N₂O emissions during storage, handling and application as fertiliser are possible.

Environmental performance and operational data

Ammonia emissions from enriched cage systems have been reported to be between 0.010 kg and 0.10 kg NH₃ per hen per year. The range of emissions is due to the different frequency of manure removal, by non-ventilated or ventilated manure belts placed underneath the cages. It has been estimated that increasing the frequency from twice a week to three times a week or to a daily removal allows for the reduction of ammonia emissions by 19 % and 43 %, respectively. Examples of the effect of manure removal frequency on ammonia emissions are reported in Table 4.52 and Table 4.53.

The effect on ammonia emissions of the frequent removal of manure without drying by ventilated belts was reported from Denmark and is presented in Table 4.52. Measured emission levels were compared to a reference emission factor of 0.083 kg NH₃/ap/yr, corresponding to one removal of manure per week.

Table 4.52: Effect of increasing the manure removal frequency, without manure drying, on ammonia emissions from enriched cages in comparison with weekly manure removal

Parameter	Manure removal frequency		
	Twice per week	Three times per week	Daily removal or twice per day
Ammonia emissions reduction (%)	54–58	66	76
<i>Source: [56, Denmark 2010] [57, Denmark 2010]</i>			

The effect on ammonia emissions of the frequent removal of manure (and associated costs) when belts are equipped with drying fans is presented in Table 4.53. Values are compared with a technique which removes manure twice per week, with no ventilated belt (no drying), associated with an emission factor between 0.05 kg and 0.1 kg NH₃/ap/yr.

Table 4.53: Effect of manure removal frequency, with manure drying on ventilated belts, on ammonia emissions from enriched cages, and associated costs

Parameter	Manure removal frequency	
	Twice per week	More than two times per week
Ammonia emission reduction (%) ⁽¹⁾	30–40	35–45
Associated costs (EUR/kg NH ₃ -N abated/year)	0–3	2–5
⁽¹⁾ Reduction percentage depends on the ventilation rate of the drying fan.		
<i>Source: [508, TFRN 2014]</i>		

In Spain, it was measured that increasing the manure removal frequency from once to twice per week reduced ammonia emissions by 49 %, from an emission factor of 0.079 kg NH₃/ap/yr to 0.039 kg NH₃/ap/yr. Methane and nitrous dioxide were also measured for weekly and biweekly manure removal from belts. Methane emissions were not affected by frequent manure removal but by manure drying (31 % reduction), with a variation of the emission factor from 0.035 kg CH₄/ap/yr to 0.024 kg CH₄/ap/yr. The increase in the manure removal frequency showed a reduction of N₂O emissions of 29 %, from 0.0024 kg N₂O/ap/yr to 0.0017 kg N₂O/ap/yr.

In the UK, emissions per bird place per year are estimated for methane at 0.078 kg CH₄/ap/yr and for PM₁₀ at 0.01 kg/ap/yr.

Measured odour emissions are reported to be equivalent to 0.37 ou_E/s per hen (219 ou_E/s per 1 000 kg of live weight for an average weight of 1.7 kg) [56, Denmark 2010]. Energy consumption should not be significantly different from the values reported in Section 4.6.1.2.

Technical considerations relevant to applicability

These systems are applied in both new and existing houses. The technique can replace conventional cages, without the need for a significant alteration of existing buildings [508, TFRN 2014].

Economics

Increasing manure removal from once to twice a week is more efficient than increasing the number of removals from two to three times per week. The economic effect of this practice is estimated in Table 4.54. The economic value of the savings in mineral fertilisers that are allowed for by the increased nitrogen content in the manure are also taken into consideration. The annual cost of applying frequent manure removal (twice per week compared to once per week) is estimated to be less than 1 % of the total production costs [57, Denmark 2010].

Table 4.54: Economic consequences of removing manure two or three times per week compared to only once per week

	Combined additional cost excluding the value of the saved N		Combined additional cost including the value of the saved N		Additional costs excluding the value of the saved N	
	EUR/layer hen/yr		EUR/layer hen/yr		EUR/kg N reduced	
No of hens ⁽¹⁾	Frequency: twice/week	Frequency: three times/week	Frequency: twice/week	Frequency: three times/week	Frequency: twice/week	Frequency: three times/week
12 000	0.08	0.16	0.05	0.12	2.8	4.7
24 000	0.07	0.12	0.03	0.08	2.1	3.5
30 000	0.07	0.13	0.03	0.09	2.1	3.7
48 000	0.05	0.11	0.01	0.07	1.7	2.9

⁽¹⁾ For converting the reported Danish animal units to number of hens, a factor of 200 was used.
Source: [57, Denmark 2010]

The investment required varies from EUR 10–15 per bird place in Italy [83, Italy 2010] to EUR 12–15 in France, where an entire replacement of the existing sheds, with house rebuilding and equipment, may cost EUR 25 per bird place [368, France 2010]. In Spain, the extra cost associated with increasing the frequency of manure removal, without drying, from once to twice per week is equivalent to EUR 0.013/ap/yr [69, Spain 2010].

Driving force for implementation

The frequent removal of the manure reduces the flies' contamination and improves animal welfare.

Example plants

Several farms in the UK are equipped with this type of system. In 2012, in France, 100 % of the laying hens were raised in enriched cages. One housing system with 60 000 places was reported for Spain and two housing systems of 100 000 places were reported for Italy, in the Veneto region.

Reference literature

[56, Denmark 2010] [57, Denmark 2010] [63, Germany 2010] [67, Netherlands 2010] [68, Spain 2010] [69, Spain 2010] [83, Italy 2010] [84, UK 2010] [368, France 2010] [508, TFRN 2014]

4.6.1.2 Small groups in enriched cages

Description

This consists of an enriched cage system providing birds with a larger surface area per bird, higher cages and more defined areas with litter and nests compared to the minimum requirements for enriched cages defined by Directive 1999/74/EC.

This housing system was developed for small groups of birds. Nevertheless, the colony size is not fixed. A total area at least 2.5 m² is provided, of which 800 cm² are usable without restriction (if the hen weight is over 2 kg, then 900 cm² of space is made available), in comparison with the minimum permitted usable cage area per hen of 600 m² according to the provisions of Directive 1999/74/EC. The littered and the nest areas cover 900 cm² for every group of 10 (for 30 animals or more, an additional 90 cm² per animal are given). The cage height is at least 50 cm and at the trough side it is 60 cm. Each animal is provided with 15 cm of perches and 12 cm of feed trough.

Manure belts placed under the cages allow for frequent manure removal from the shed. Forced manure drying can be performed on the manure belts by means of pipes that blow air over the droppings.

Achieved environmental benefits

Ammonia emissions are reduced by frequent droppings removal, and even more with forced drying. Dust emissions are lower compared to non-cage systems (but this mainly depends on the dust bath material).

Cross-media effects

The increased animal movement and the operation of belts cause higher dust emissions. The energy use is higher with forced air drying.

Environmental performance and operational data

The manure from ventilated belts is removed weekly, or otherwise twice a week. The dry matter content of the manure at the time of removal is at least 55 %, in the case of air drying. The manure removed by the belts is stored outside the housing. When the store is not covered, the manure is further displaced to a storage depot.

The air used for the forced air drying system should be fresh. Ventilation rates vary depending on the season: in the cold season, air volumes from 0.5 m³/bird place per hour to 3.2 m³/bird place per hour are provided, and in the warm season volumes from 3.1 m³/bird place per hour to 6.9 m³/bird place per hour are provided. In the Netherlands, the ventilation rate for the air drying system is reported to be equivalent to 0.7 m³/h/bird, with a minimum temperature of 17 °C.

For each bird place per year, emissions of 0.15 kg of ammonia and 0.04 kg of PM₁₀ are associated with this system (see Table 4.51). If manure drying is applied, emissions are reduced to a range of 0.017–0.040 kg of ammonia per bird place per year and to 0.023–0.04 kg of PM₁₀ per bird place per year. Odour emissions are estimated to be in the range of 0.102–0.350 ou_E per bird place per second [67, Netherlands 2010] [63, Germany 2010].

In Germany, labour requirements have been estimated at 0.085–0.12 hours/ap/yr, on the basis of a housing system with 30 000 bird places.

Energy consumption is considered to be proportional to the number of manure removals [434, ITAVI 2001]. In Germany, the reported energy requirements are in the range 1.1 kWh/ap/yr to 1.8 kWh/ap/yr for two removals per week; the additional consumption for the manure belt ventilation ranging from 0.6 kWh/ap/yr to 1.3 kWh/ap/yr. Energy consumption for lighting is reported to be 0.52 kWh/ap/yr.

Technical considerations relevant to applicability

The system is in use in consumer egg production only.

Economics

The investment requirement varies from EUR 16–20 per bird place in the Netherlands to about EUR 31.00 per bird place in Germany, for a housing system with 5 000–10 000 bird places. The corresponding annualised investment costs have been reported as EUR 2.4–3/ap/yr for the Netherlands and EUR 3.6/ap/yr for Germany. The average extra cost for a new installation reported by the Netherlands is equivalent to EUR 7.9/ap/yr, ranging from EUR 5.5/ap/yr to EUR 9.5/ap/yr. Annual operating costs have been estimated in the Netherlands as EUR 0.1 per bird place.

Driving force for implementation

National or local cage ban programmes (Netherlands, Germany) are the driving force for implementation. Animal welfare is improved compared to conventional cages and standard enriched cages.

Example plants

Since conventional enriched cages are not allowed in the Netherlands and in Germany, small group housing in enriched cages is used.

Reference literature

[63, Germany 2010] [67, Netherlands 2010] [434, ITAVI 2001]

4.6.2 Techniques for non-cage housing of laying hens

Non-cage systems for egg production require a different management regime and therefore need to be considered separately from the cage housing systems. The legal requirements set within Directive 1999/74/EC on the welfare of laying hens and the market acceptance of systems that are considered animal-friendly have motivated the proliferation of these systems. A summary of the results of emission measurements is presented in Table 4.55 and Table 4.56.

Table 4.55: Summary of relevant reported achievable emissions in deep-litter-based non-cage systems for laying hens

Description	NH ₃	CH ₄	N ₂ O	PM ₁₀	Odour	Source
	(kg/ap/yr)				(ou _E /ap/s)	
Section 4.6.2.1.1. Forced ventilation system and infrequent manure removal (in the case of deep litter with a manure pit)						
Deep litter or deep pit with partial litter	0.3	NI	NI	NI	NI	[508, TFRN 2014]
Deep litter with manure pit	0.3157 ⁽¹⁾	NI	0.006 ⁽²⁾	0.12 ⁽¹⁾	0.143 ⁽¹⁾ ⁽³⁾	[64, Germany 2010]
Deep litter, with manure pit and veranda	0.3157 ⁽⁴⁾	NI	NI	0.12 ⁽¹⁾	0.143 ⁽¹⁾ ⁽³⁾	[65, Germany 2010]
Deep litter, with manure pit, veranda and free range	0.347 ⁽⁴⁾	NI	NI	0.12 ⁽¹⁾	0.143 ⁽¹⁾ ⁽³⁾	[66, Germany 2010] [474, VDI 2011]
Deep litter, with manure pit, manure removal once or twice a year, free range	0.158 (0.071–0.248) ⁽⁵⁾	NI	NI	NI	NI	[635, Le Bouquin et al. 2013]
Deep litter with deep manure pit	0.290 ⁽⁴⁾	0.078 ⁽⁴⁾	NI	0.020 ⁽⁴⁾	NI	[85, UK 2010]
Section 4.6.2.1.2. Manure belt or scraper (in the case of deep litter with a manure pit)						
Deep litter with manure pit, with non-ventilated manure belts (twice per week)	0.052–0.068 ⁽⁵⁾	NI	NI	0.084 ⁽⁴⁾	0.34–0.61 ⁽⁴⁾	[70, Netherlands 2010]
Section 4.6.2.1.3. Forced air drying of manure via tubes (in the case of deep litter with a manure pit)						
Deep litter system with forced air manure drying	0.125 ⁽¹⁾	NI	NI	NI	NI	[638, BE Flanders 2014]
Section 4.6.2.1.4. Forced air drying of manure using perforated floor (in the case of deep litter with a manure pit)						
Deep litter system with perforated floor and forced drying	0.110 ⁽⁵⁾	NI	NI	NI	NI	[638, BE Flanders 2014]
⁽¹⁾ Derived from measurements. ⁽²⁾ Modelled values (e.g. results based on N balance). ⁽³⁾ Values have been calculated from an emission of 42 ou _E /s per LU and an average weight for laying hens of 1.7 kg. ⁽⁴⁾ Conclusion by analogy. ⁽⁵⁾ Measured values. NB: NI = no information provided.						

Table 4.56: Summary of relevant reported achievable emissions in aviary-based non-cage systems for laying hens

Description	NH ₃	CH ₄	N ₂ O	PM ₁₀	Odour	Reference
	(kg/ap/yr)				(ou _E /ap/s)	
Section 4.6.2.2.1 Manure belts (in the case of aviaries)						
<i>Non-ventilated belts</i>						
Aviaries, perch design, manure belts, one removal a week	0.250 ⁽¹⁾	0.200 ⁽¹⁾	0.180 ⁽¹⁾	0.10 ⁽¹⁾	NI	[82, Austria 2010 ↓ [373, UBA Austria 2009]
Litter-based with aviaries, veranda and free range	0.08 ⁽²⁾	0.078 ⁽³⁾	NI	0.02 ⁽³⁾	NI	[86, UK 2010]
Aviaries, one removal a week	0.091 ⁽²⁾	NI	0.002 ⁽⁴⁾	0.15 ⁽²⁾	0.102 ⁽²⁾ ⁽⁵⁾	[60, Germany 2010] [474, VDI 2011]
Aviaries, two removals a week	0.056 ⁽²⁾	NI	NI	NI	NI	[474, VDI 2011]
Aviaries, veranda, one removal a week	0.091 ⁽³⁾	NI	0.002 ⁽⁴⁾	0.15 ⁽⁴⁾	0.102 ⁽⁴⁾ ⁽⁵⁾	[61, Germany 2010] [474, VDI 2011]
Aviaries, veranda, two removals a week	0.056 ⁽³⁾	NI	NI	NI	NI	[474, VDI 2011]
Aviaries, veranda and free range, one removal a week	0.100 ⁽³⁾	NI	0.002 ⁽⁴⁾	0.15 ⁽²⁾	0.102 ⁽²⁾ ⁽⁵⁾	[62, Germany 2010] [474, VDI 2011]
Aviaries, veranda, outdoor, two removals a week	0.0616 ⁽³⁾	NI	NI	NI	NI	[474, VDI 2011]
<i>Ventilated belts</i>						
Aviaries, one removal per week	0.046 ⁽²⁾	NI	NI	NI	NI	[474, VDI 2011]
Aviaries, veranda, one removal per week	0.046 ⁽²⁾	NI	NI	NI	NI	[474, VDI 2011]
Aviaries, veranda, outdoor, one removal per week	0.0506 ⁽³⁾	NI	NI	NI	NI	[474, VDI 2011]
Aviaries, perch design, ventilation 0.7 m ³ /h, one removal per week (30–35 % slatted floor)	0.019–0.025 ⁽⁴⁾	NI	NI	0.065 ⁽³⁾	0.34 ⁽³⁾	[71, Netherlands 2010]
Aviaries, perch design, ventilation 0.7 m ³ /h, one removal per week, (55–60 % slatted floor)	0.037 (0.0356–0.0371) ⁽⁴⁾	NI	NI	0.065 ⁽³⁾	0.34 ⁽²⁾	[72, Netherlands 2010]
Aviaries, perch design, ventilation 0.2 m ³ /h, two removals per week (50 % slatted floor)	0.055 ⁽²⁾	NI	NI	0.065 ⁽³⁾	0.34 ⁽²⁾	[73, Netherlands 2010]
⁽¹⁾ Modelled values (e.g. results based on N balance). ⁽²⁾ Derived from measurements. ⁽³⁾ Values derived by expert judgement based on conclusions by analogy. ⁽⁴⁾ Measured values. ⁽⁵⁾ Values have been calculated from an emission of 30 ou _E /s per LU and an average weight for laying hens of 1.7 kg. NB: NI = no information provided.						

4.6.2.1 Deep litter or floor regime systems

4.6.2.1.1 Forced ventilation system and infrequent manure removal (in case of deep litter with a manure pit)

Description

At least a third of the floor area is covered with litter (e.g. sand, wood shavings, straw). The rest of the floor area is arranged as a pit covered with slats to collect droppings over the laying period. The deep litter system is combined with infrequent manure removal, e.g. at the end of the cycle (no belt or scraper is used). Manure is removed from the scratching area by mobile means. Laying nests, feeders and water supply are placed over the slatted area to keep the litter dry (see Figure 4.10). The housing system can be combined with a veranda and/or free-range system.

Achieved environmental benefits

Ammonia emissions can be reduced by ensuring a minimum dry matter content of around 50–60 %. This is achieved by an appropriate forced ventilation system (e.g. fans and air extraction can be placed at floor level), so that a current is generated to dry the droppings below the slatted area.

Cross-media effects

The ammonia emissions associated with this technique are generally higher than those associated with other non-cage systems. There are more management requirements compared to cage systems.

Environmental performance and operational data

Reported ammonia emissions range from 0.071 kg to 0.315 kg NH₃/animal place/year, and to 0.347 kg/bird place per year in the case where free-range systems are available (see Table 4.55). In the case of a free-range system, an increase in NH₃ emissions of about 10 % is estimated.

Technical considerations relevant to applicability

Retrofitting of an existing cage system may not be applicable due to excessive costs.

Economics

Reported information on costs associated with the implementation of a deep litter housing system with a deep pit and partly littered floor is presented in Table 4.58. Data on the resources demand are presented in Table 4.59.

Driving force for implementation

This technique is more animal-friendly compared to enriched cages.

Example plants

In the system typically used in France, manure is stored under the slatted floor for the whole period and is removed at the end [624, IRPP TWG 2013].

Reference literature

[43, COM 2003] [624, IRPP TWG 2013]

4.6.2.1.2 Manure belt or scraper (in case of deep litter with a manure pit)

Description

The house floor is partly covered with litter, such as sand, wood shavings or the straw used for scratching and dust bathing. The littered floor occupies a third to two thirds of the total surface. The remainder consists of a slatted floor, the area of which is, at a maximum, two thirds of the available space, as required by Directive 1999/74/EC. The difference in height between the bedding and slatted floor is maximum 50 cm. Each compartment (level) can have its own climate control system [70, Netherlands 2010]. Perches, laying nests, feeding and drinking systems are situated above the manure pit to keep the litter dry.

Underneath the slats, there is a deep pit for manure, 80–90 cm in height [508, TFRN 2014], which can be equipped with scrapers or belts, with or without aeration. The removal by scraper is periodical; the removal by belts is frequent. If the belts are ventilated, the manure removal can be weekly; otherwise, it takes place twice a week. The bedding over the solid area is distributed at the beginning of the laying cycle and litter is collected at its end by mobile means. A schematic representation of a deep litter system, with a manure pit and partly slatted floor is shown in Figure 4.10.

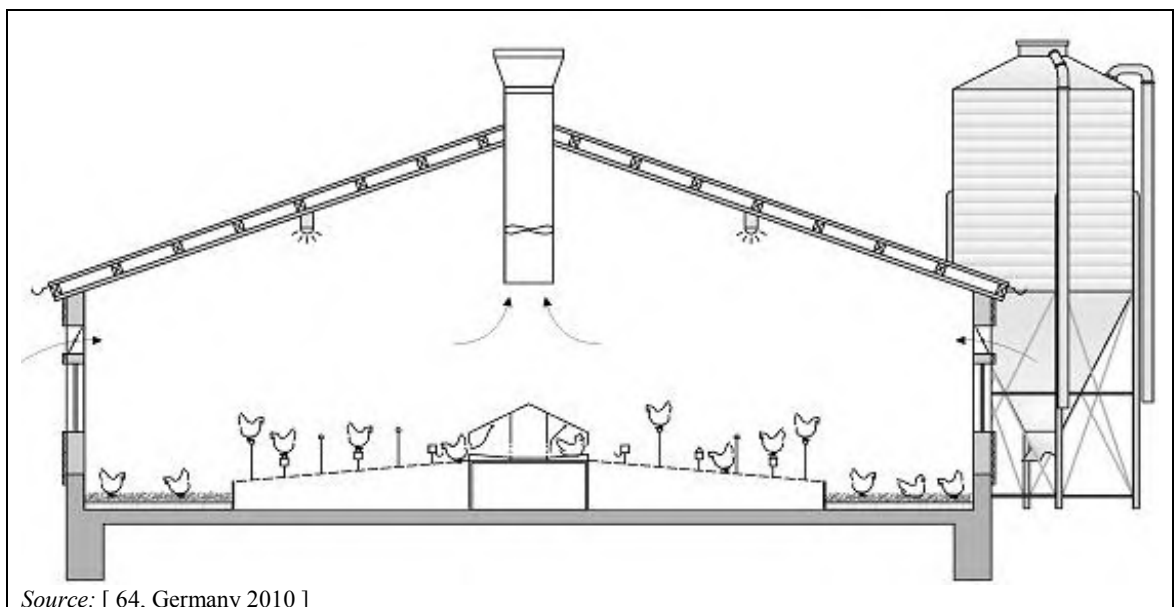

Source: [64, Germany 2010]

Figure 4.10: Schematic representation of a deep litter system with a manure pit for laying hens

In general, the stocking density in these housing systems is up to 9 hens per m² of floor area. Additional structures can be added inside or outside the house for better animal comfort, like verandas and free-range system (see Section 2.2.1.2.3). A schematic representation of the system is shown in Figure 4.11.

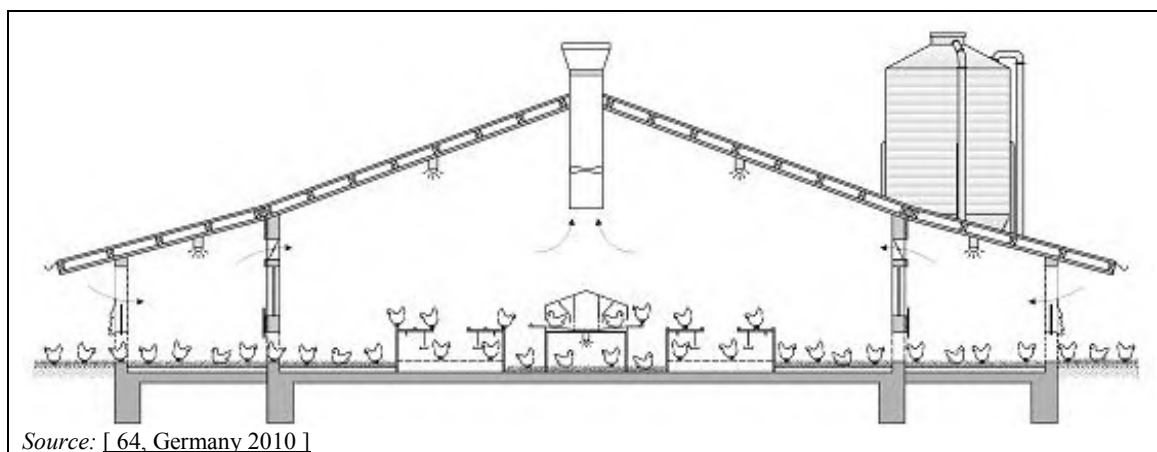

Figure 4.11: Schematic representation of a deep litter system with a manure pit, a veranda and a free-range system for laying hens

Achieved environmental benefits

Ammonia emissions are reduced by the frequent removal of the manure from the belts, in particular when combined with manure drying on the belt through forced ventilation, achieving a high dry matter content of the litter in the top compartment.

No differences in emissions have been reported from the use of verandas. Where free-range systems are available, ammonia emissions are expected to be about 10 % higher than those produced indoors.

Cross-media effects

As manure is obtained with a dry matter content of up to 80 %, a lot of dust can develop in the house as the birds move around freely. The use of manure belts for the removal and forced ventilation for manure drying are associated with energy consumption for the production of electricity and related indirect emissions.

Environmental performance and operational data

For the birds, this system offers an almost full opportunity to display natural behavioural patterns. The house interior can be structured to offer different functional areas. This makes the system more bird-friendly than cage confinement. Also, from a technical perspective, uniform house ventilation and lighting can be achieved more easily than in a cage housing, and, also, bird observation is simpler. The ammonia emissions vary from 0.052 kg to 0.320 kg NH₃/bird place per year, to 0.352 kg/bird place per year where free-range systems are available (see Table 4.55). In the case of a free-range system, an increase in NH₃ emissions of about 10 % is estimated.

In the UK, methane emissions have been estimated at 0.078 kg/bird place per year. In Germany, nitrous oxide emissions are estimated at 0.006 kg N₂O/bird place per year, for a deep litter system without a manure belt or scraper. Odour emissions have been measured from 0.34 ou_E/bird/second to 0.61 ou_E/bird/second [70, Netherlands 2010]. Emissions of the PM₁₀ fraction of dust that originate in belt systems can vary from 0.020 kg to 0.084 kg and to 0.240 kg per bird place per year.

Feeding and drinking features, as well as the space per animal, comply with Article 4 of Directive 1999/74/EC. The ventilation rates vary depending on the season: in the cold season rates from 0.5 m³ to 2.8 m³ per bird per year are applied, whereas in the warm season 3.5 m³ to 6.9 m³ per bird per year may be needed. Some examples of ventilation rates applied in Germany and in the Netherlands are reported in Table 4.57.

Table 4.57: Ventilation rates applied in deep litter housing systems for laying hens

	Applied ventilation rates	
	Germany	Netherlands
	m ³ /h per bird place	m ³ /h per bird place
Cold season	0.5–0.8	1.5–2.8
Warm season	3.1–6.9	3.5–4.4
<i>Source: [63, Germany 2010] [64, Germany 2010] [65, Germany 2010] [70, Netherlands 2010]</i>		

If natural ventilation is applied, the energy input is relatively low; however, under the climatic conditions of most areas in the European Union, natural ventilation is not applicable.

In Germany, the energy consumption is reported as 0.52 kWh/ap/yr for lighting and 2.2 kWh/ap/yr for ventilation, when non-ventilated belts are used. In the case of ventilated belts, the energy consumption is reported as 3.18 kWh/ap/yr.

Technical considerations relevant to applicability

A change from a cage system to this floor regime would require a complete revision of the system. The width of the existing house is the most limiting factor for retrofitting existing constructions. In existing houses, the placement of a manure belt or scraper in a manure pit underneath the slatted floor is not always possible and involves additional costs.

Economics

The basic investment required is in the range of EUR 20.40 to EUR 37.00 per bird place. If additional verandas or free ranges are added, the investment increases to EUR 44.40 per bird place. Reported information on costs associated with the implementation of a deep litter housing system with a manure pit is presented in Table 4.58. Data on the resources demand are presented in Table 4.59.

Table 4.58: Cost data associated with different deep litter systems with a manure pit

System configuration	Investment costs	Annualised investment costs	Annual operating costs	Total costs	Source
	EUR/bird place	EUR/ap/yr			
With scraper	37	3.9	3.2	7.1	[64, Germany 2010]
With manure belt and veranda	38–59 ⁽¹⁾	4.7	3.7	8.4	[65, Germany 2010]
No manure belt or scraper, with veranda and free range	44.4	3.9	NI	NI	[66, Germany 2010]
With non-ventilated manure belt	20.4 (18.9–21.9)	3.05 (2.85–3.3)	0.05	3.1	[70, Netherlands 2010]
⁽¹⁾ Values ranging for housing capacities from 3 000 to 9 000 bird places. NB: NI = no information provided.					

Table 4.59: Resource demand associated with the different deep litter systems with a manure pit

System configuration	Labour	Bedding material	Source
	h/ap/yr	kg/ap/yr	
Without veranda or free range	0.21	0.29	[64, Germany 2010]
With veranda	0.19–0.26	0.5	[65, Germany 2010]
With veranda and free range	0.24–0.41	0.5	[66, Germany 2010]

Driving force for implementation

The proliferation of alternative systems has been stimulated by welfare legislation on laying hens and by some changes in the market towards the consumption of eggs from more animal-friendly systems.

Non-environmental benefits are achievable; the housing system is animal-friendly due to more space being provided to the birds (compared to enriched cages) and to additional characteristics, like perches, separate functional areas, scratching areas, a dust bath and external/climate stimuli.

Example plants

In the Netherlands, about 5 % of laying hens in 2009 were reared with this system. In Germany, the system is widespread.

Reference literature

[39, Germany 2001] [44, IKC 2000] [63, Germany 2010] [64, Germany 2010] [65, Germany 2010] [66, Germany 2010] [70, Netherlands 2010] [85, UK 2010] [506, TWG ILF BREF 2001] [508, TFRN 2014]

4.6.2.1.3 Forced air drying of manure via tubes (in case of deep litter with a manure pit)

Description

The deep litter system with forced air manure drying is based on the previous system but here the ammonia emissions are reduced by applying forced ventilation as shown in Figure 4.12. Forced ventilation is applied through tubes that blow 1.2 m^3 of air per bird place per hour at a temperature of $17\text{--}20^\circ\text{C}$ (pullets and layers have different requirements) over the manure stored under the slats or over the manure being removed by the (aerated) belts [467, BE 2010].

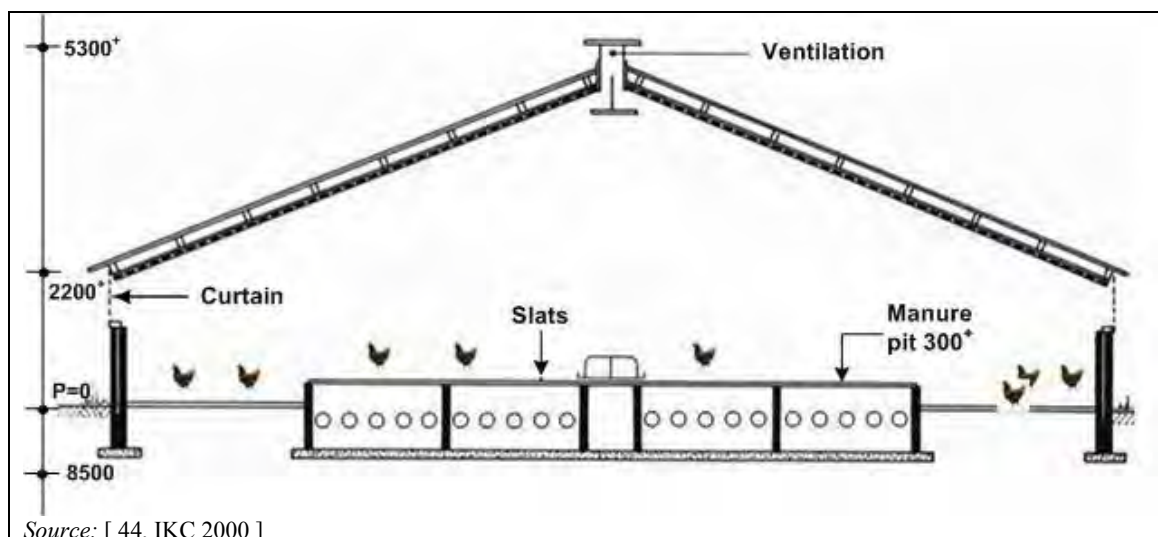

Figure 4.12: Deep litter systems with forced drying via tubes under the slatted floor

Achieved environmental benefits

The application of forced ventilation and the quick drying of the manure reduce ammonia emissions. Frequent removal with (aerated) manure belts can give even lower emission levels. Reduced odour levels can be expected.

Cross-media effects

The energy input in this system is high because a heating system must be installed to achieve the temperature necessary in the tubes (20°C). Extra energy is also required to maintain the

airflow. Air is drawn in through inlets in the side walls and through an open ridge construction in the roof. Aeration may trigger nitrification reactions that may result in an increased emission of N_2O . In general, due to the dried manure, higher dust emissions are expected.

Environmental performance and operational data

Management of this system is principally the same as for the reference deep litter design. Ammonia emissions of 0.125 kg NH_3 per bird place per year are associated with this system in the Netherlands [640, Netherlands 2013]. The associated ammonia reduction is 60 % compared to the deep litter system (0.315 kg NH_3 per bird place per year).

Technical considerations relevant to applicability

The system can only be used in laying hen houses with enough space underneath the slats. Traditionally the manure pit has a depth of 80 cm but when using this system it is necessary to add an extra 70 cm. The experience of farmers already using the deep floor system is that this type of system requires very little change to the traditional design.

Economics

The total cost for implementing this system in Belgium (Flanders) is EUR 32/bird place (VAT excluded), which corresponds to an extra cost of EUR 3.15/bird place in comparison with a conventional deep pit system (11 % higher). The additional energy requirements for the ventilation amount to EUR 0.17/ap/yr [265, BE Flanders 2010].

Example plants

In the Netherlands, around 1 129 000 birds are housed in this type of system, about 3 % of the total Dutch laying hen population [468, CBS 2011]. In Belgium (Flanders), 10 systems (including farms above and below the capacity threshold set by Directive 2010/75/EU, Annex I) have been built since 2004.

Reference literature

[41, Netherlands 2001] [44, IKC 2000] [265, BE Flanders 2005] [467, BE 2010] [468, CBS 2011] [506, TWG ILF BREF 2001] [640, Netherlands 2013]

4.6.2.1.4 Forced air drying of manure using perforated floor (in case of deep litter with a manure pit)

Description

A perforated floor is placed in the manure pit underneath a partially elevated slatted floor, which allows forced air blowing from below to dry the manure on top of it (Figure 4.13).

The house is a simple traditional building. The bedding area is 30 % and slatted floor 70 % of the total area. The laying nest area is included in the slatted floor area. The perforated floor (air channel) is situated at least 10 cm from the bottom of the pit (aeration space). The manure pit available under the slatted area must be large enough to store and dry the manure generated during the entire production period, so the total available height between the slats and perforated floor should be at least 80 cm. The perforated floor must be able to support a weight of 400 kg/m² (including the weight of the dry manure). This false floor should be evenly perforated and the total area of air openings should be at least 20 % of the surface.

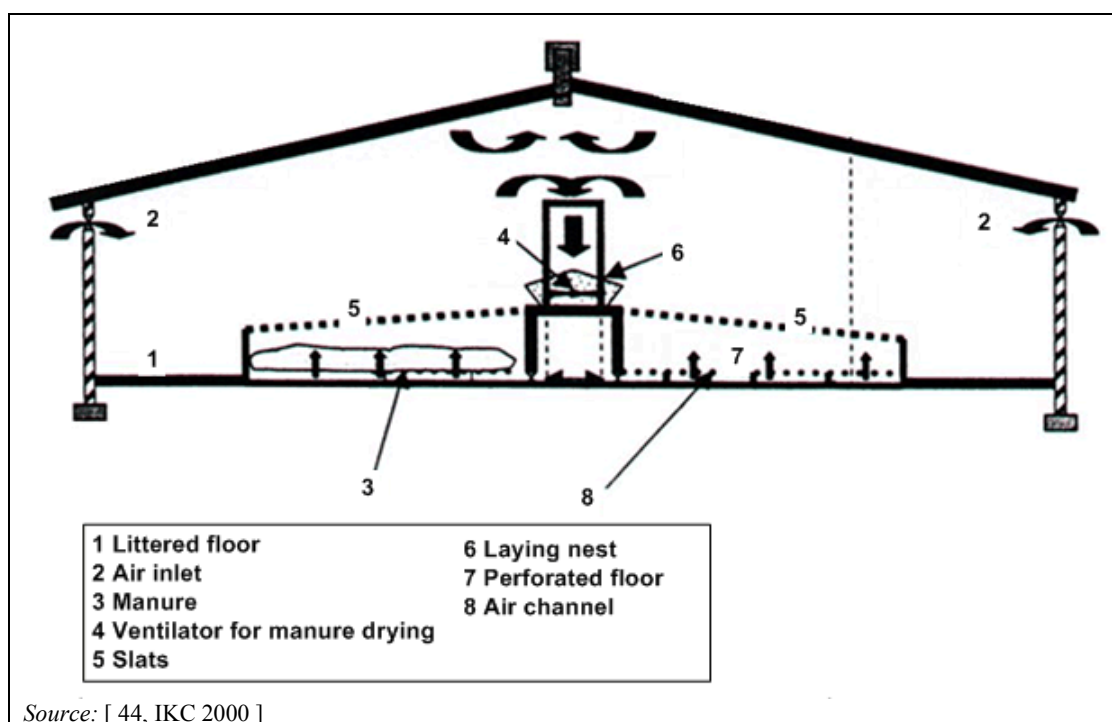

Figure 4.13: Deep litter system with perforated floor and forced manure drying

Achieved environmental benefits

Ammonia emissions are reduced as an effect of the manure drying.

Cross-media effects

Higher energy input is required because of the forced ventilation. Manure aeration may trigger nitrification reactions that may cause an increase of N_2O emissions. In general, due to the dried manure, higher dust emissions are expected.

Environmental performance and operational data

The layer droppings fall through the slats onto the perforated floor. At the beginning of the laying period, on top of the perforated floor, a 4 cm thick bed of wood shavings or sawdust is scattered. Air from the shed is blown from beneath through the small openings in the perforated floor under the manure. To dry the manure properly, at least two ventilators with a minimum capacity of around 7 m^3 air/hour and capable of overcoming a high pressure resistance (minimum 90 Pa) need to be installed. Different placement options are possible for the ventilation units (see Section 4.6.5.4).

The manure stays on the perforated floor for about 50 weeks (laying period) and is then taken out of the house. The manure is dried constantly by the continuous flow of air. The dry matter content of the manure is about 75 %.

Bedding is spread at the start of the flock and twice more during the rearing period, in order to maintain a wood shavings bed density of 0.7 kg/m^2 . Functional areas are above the dropping area. Reported values of ammonia emissions are 0.110 kg per bird place per year. The drinking facilities must be installed on top of the slats, but a good design of the tubes prevents the loss of water.

Technical considerations relevant to applicability

The technique is applicable to new houses but it could also be installed in existing houses, but at an additional cost.

Economics

The investment required is EUR 1.20 per bird place and annual costs are EUR 0.18 per bird (see also Section 4.6.5.4).

Driving force for implementation

No information provided.

Example plants

In the Netherlands, about 276 000 bird places are built with this technique, representing 1 % of the total Dutch availability [468, CBS 2011].

Reference literature

[44, IKC 2000] [108, BE Flanders 2010] [111, Netherlands 2010] [468, CBS 2011] [506, TWG ILF BREF 2001] [545, Netherlands 2002]

4.6.2.2 Manure belts (in case of aviary)**4.6.2.2.1 Manure belts (in case of aviary), with or without a veranda and free-range system****Description**

The building is divided into different functional areas for feeding and drinking, laying eggs, scratching and resting. Nests to lay eggs can be integrated or not integrated with the equipment (see Section 2.2.1.2.2). Functional areas are arranged above the droppings area. The indoor available surface area is increased by means of elevated slatted floors, combined with tiers, allowing a stocking density of up to 18 hens per m² of floor area. A minimum of two tiers are stacked over the slatted floor. The slat coverage can range from 30–35 % up to 55–60 % of the total available area. The remainder of the floor is typically littered (e.g. with straw or wood shavings).

Manure belts collect and remove the droppings under the slatted floors. The belts can be equipped with plastic pipes, through which forced air is blown in order to dry the manure (0.2 m³/h per animal, at a minimum temperature of 18 °C, or 0.7 m³/h per animal at a minimum temperature of 17 °C). Typically, manure is removed at least twice a week with non-ventilated belts and once a week when pre-drying is carried out on ventilated belts. The removal of the litter that is not conveyed by belts is done every 3 months [82, Austria 2010] or at the end of the cycle.

The housing system can be combined with a veranda and free ranges. A scheme of the system is given in Figure 4.14.

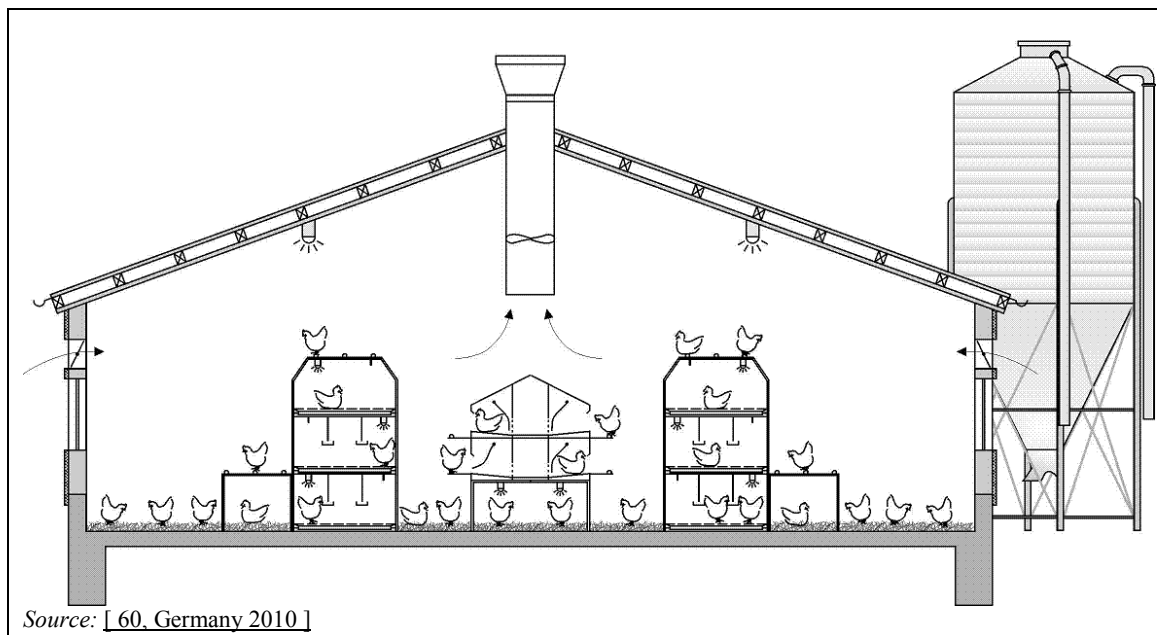

Figure 4.14: Scheme of a litter-based aviary for laying hens

Elements typical of aviary systems are placed in the house; birds can use the entire available space. Variations with a fully solid floor or partly slatted floor are reported. In the first case, the aviaries rest on a continuous solid littered floor; in the second case, aviaries are placed on a slatted floor in various combinations as shown in Figure 4.15. The extension of the slatted floor in relation to the total available surface is also variable. In the case of a partly slatted floor, manure belts are installed underneath the floors, where manure can be dried with forced air through pipes placed above or along the belts. In the solid floor variation, the droppings area is equipped with a manure belt. The scratching area is cleaned by mobile means.

When manure belts are equipped with forced air drying ($0.2 \text{ m}^3/\text{h}/\text{bird}$ at $20 \text{ }^\circ\text{C}$, with removal once per week), a minimum dry matter content of 55 % is reported. The birds are kept at variable densities, from 0.030 m^3 to 0.062 m^3 per head.

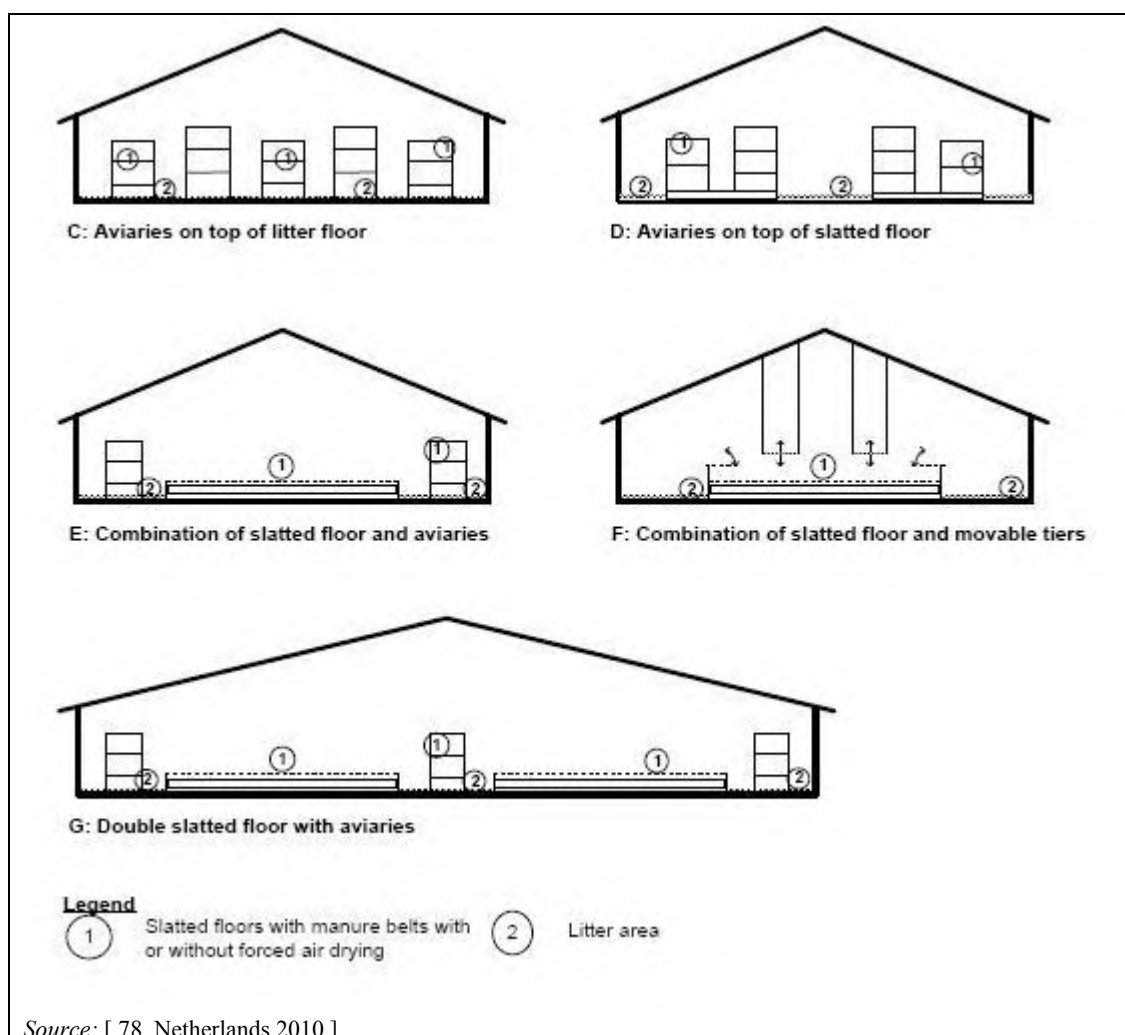

Figure 4.15: Combinations of slatted floors in aviaries

Achieved environmental benefits

The frequent removal and the possible fast pre-drying of droppings by ventilated belts allow ammonia emissions reduction. Odour emissions are also reduced due to the pre-drying of the manure and/or the frequent manure removal.

Aviary systems with manure belts for frequent collection and removal of manure to closed storage reduce ammonia emissions by 70–85 % with non-ventilated manure belts and by 80–95 % with ventilated manure belts compared to the deep litter systems [508, TFRN 2014].

Cross-media effects

If access to the litter is not restricted, more dust is emitted compared to cage systems, due to the presence of litter material and to the increased animal activity. If the system is designed such that the hens only have access to the litter via the lowest aviary level, less dust is emitted. Furthermore, due to the dried manure higher dust emissions are expected.

Additional electric energy consumption is needed for the operation and ventilation of the manure belts, which is associated with indirect emissions.

Compared to the cage systems, there are more management requirements. On a daily basis, these operations should be performed: control of animals and bedding; collection of eggs that have been laid from the nests; and provision of access to the free range during the daytime. Additionally, regular care of the free-range systems and of the parasitological conditions needs to be followed.

Environmental performance and operational data

Depending on the manufacture and whether the manure is removed once or twice per week, ammonia emissions with the use of ventilated manure belts are in the range of 0.019 kg and 0.055 kg per animal place per year. Emissions from non-ventilated belts have been measured as between 0.060 kg and 0.290 kg per animal place per year (see Table 4.56 for a complete summary of the provided emission data).

Nitrous oxide emissions have been estimated in Germany to be about 0.002 kg N₂O per animal place per year. PM₁₀ emissions are in the range of 0.065 kg to 0.150 kg per animal place per year. In the Netherlands, odour emissions are estimated at 0.34 ou_E per animal place per year.

In Austria, emission data have been calculated for an aviary system operating with manure belts and removal once per week, manual removal of the litter every 3 months and with storage of the manure in a closed barn until further transportation. The results of the calculation showed ammonia emissions at 0.25 kg/ap/yr, methane emissions at 0.2 kg/ap/yr, nitrous oxide emissions at 0.18 kg N₂O/ap/yr and dust emissions at 0.1 kg PM₁₀/ap/yr [82, Austria 2010] [373, UBA Austria 2009]. In the UK, emissions are estimated as follows: ammonia 0.08/ap/yr; methane 0.078 kg/ap/yr; PM₁₀ 0.02 kg/ap/yr.

According to information from Germany, an aviary system designed to allow the hens to only have access to the litter via the lowest aviary level has lower dust emissions (PM₁₀ emissions decrease from 0.15 kg/ap/yr to 0.039 kg/ap/yr) [474, VDI 2011].

Electric consumption per animal place per year is around 0.52 kWh for lighting and 2.1 kWh for running the system. Additional consumption for the ventilation of the manure belts is around 1.6 kWh/animal place per year [60, Germany 2010]. The typical ventilation rates reported for aviary systems equipped with manure belts are presented in Table 4.60.

Table 4.60: Reported ventilation rates for aviary systems for laying hens equipped with manure belts

	Ventilation rate (m ³ /ap/h)	
	Germany	Netherlands
Cold season	0.5–0.8	1.9–2.26
Warm season	3.1–6.9	2.8–3.46
Source: [60, Germany 2010] [61, Germany 2010] [62, Germany 2010] [71, Netherlands 2010] [72, Netherlands 2010] [73, Netherlands 2010]		

Reported ventilation rates for forced air drying are 0.2 m³/h per bird, at a minimum temperature of 18 °C and a slat coverage of 45–55 %, or 0.7 m³/h per animal at a minimum temperature of 17 °C and a slat coverage of 30–35 % [72, Netherlands 2010] [73, Netherlands 2010].

In the case of aviary systems equipped with a free range, an increase of NH₃ emissions of about 10 % is estimated; however, in general no major differences are reported for ammonia emissions for different configurations [571, Eurich-Menden et al. 2011].

Technical considerations relevant to applicability

No limitations exist for applying the systems in either small or large farms. Retrofitting an aviary in existing houses depends mostly on the shed width.

Economics

The cost efficiency of the technique is given as EUR 1 to EUR 5 per kg of NH₃-N abated for non-ventilated manure belts and EUR 1 to EUR 7 per kg of NH₃-N abated for ventilated manure belts [508, TFRN 2014].

The investment cost associated with the installation of an aviary system and a ventilated manure belt beneath the slats is reported from the Netherlands as between EUR 12.6 and EUR 16.5 per bird place; the annualised extra investment costs range from EUR 1.9 to EUR 2.5 per bird place/yr and the annual extra operating costs from EUR 0.11 to EUR 0.2 per bird place/yr, leading to an total annual extra cost between EUR 2.33 and 2.36 per bird place [71, Netherlands 2010] [72, Netherlands 2010] [73, Netherlands 2010]. Investment costs for the construction of a building intended for an aviary system (30 000 hens, 18 m²/bird) are calculated at EUR 10.75 per bird place (excluding all structures within housing, feeding silos, egg storage) [589, Netherlands 2010].

A summary of cost data given by Germany related to different configurations of the aviary systems equipped with no ventilated manure belts is given Table 4.61.

Table 4.61: Summary of cost data in Germany for different configurations of aviary systems for laying hens

System configuration	Investment costs	Annualised investment costs	Annualised operating costs	Total costs	Source
	EUR/ap	EUR/ap/yr			
No ventilated belt, 1–2 removals per week	31	3.6	2.8	6.4	[60, Germany 2010]
No ventilated belt, with veranda, 1–2 removals per week	31	3.6	2.9	6.5	[61, Germany 2010]
No ventilated belt, with veranda and free range, 1–2 removals per week	28–38	4.4	4	8.4	[62, Germany 2010]

The labour demand associated with the implementation of aviary systems is reported to be between 0.16 and 0.19 h/ap/yr. Energy consumption is reported as 0.52 kWh/ap/yr for lighting, 2.1 kWh/ap/yr for the use of non-ventilated belts and 3.7 kWh/ap/yr for ventilated belts.

The quantity of bedding material used with non-ventilated belts and one or two manure removals per week is between 0.075 kg/ap/yr and 0.16 kg/ap/yr; values increase in the case of configurations that include a veranda (0.26 kg/ap/yr), or a veranda plus a free range (0.29 kg/ap/yr).

Driving force for implementation

Aviary houses constitute an alternative housing system after the ban of conventional cages. The system allows reasonable egg losses and a high stocking density. Aviaries are more animal-friendly than enriched cages, allowing the birds to manifest their natural behaviour more easily, due to the increased space provided per bird and the improved benefits of perches, functional areas, scratching areas, dust baths and external climate/stimuli.

Example plants

In the Netherlands, about 15 % of the farms in 2008 were equipped with systems of this type. About 50 farms in Belgium (Flanders) are equipped with this system.

Reference literature

[60, Germany 2010] [61, Germany 2010] [62, Germany 2010] [71, Netherlands 2010] [72, Netherlands 2010] [73, Netherlands 2010] [82, Austria 2010] [86, UK 2010] [373, UBA Austria 2009] [467, BE 2010] [474, VDI 2011] [508, TFRN 2014] [571, Eurich-Menden et al. 2011] [589, Netherlands 2010]

4.6.2.2 Underfloor manure drying (in case of aviary)

Description

Aviaries are built with a deep litter under a slatted floor. In the pit, manure drying is performed and the manure is stored during the egg-laying period which lasts typically 13–15 months. The system differs from traditional houses by having a manure pit at least 70 cm deep (see Figure 4.16). A ventilation outlet circulates heated air in the manure pit to dry the droppings. Drying creates a crust on top of the manure which reduces the degradation of urea to ammonia and ammonium.

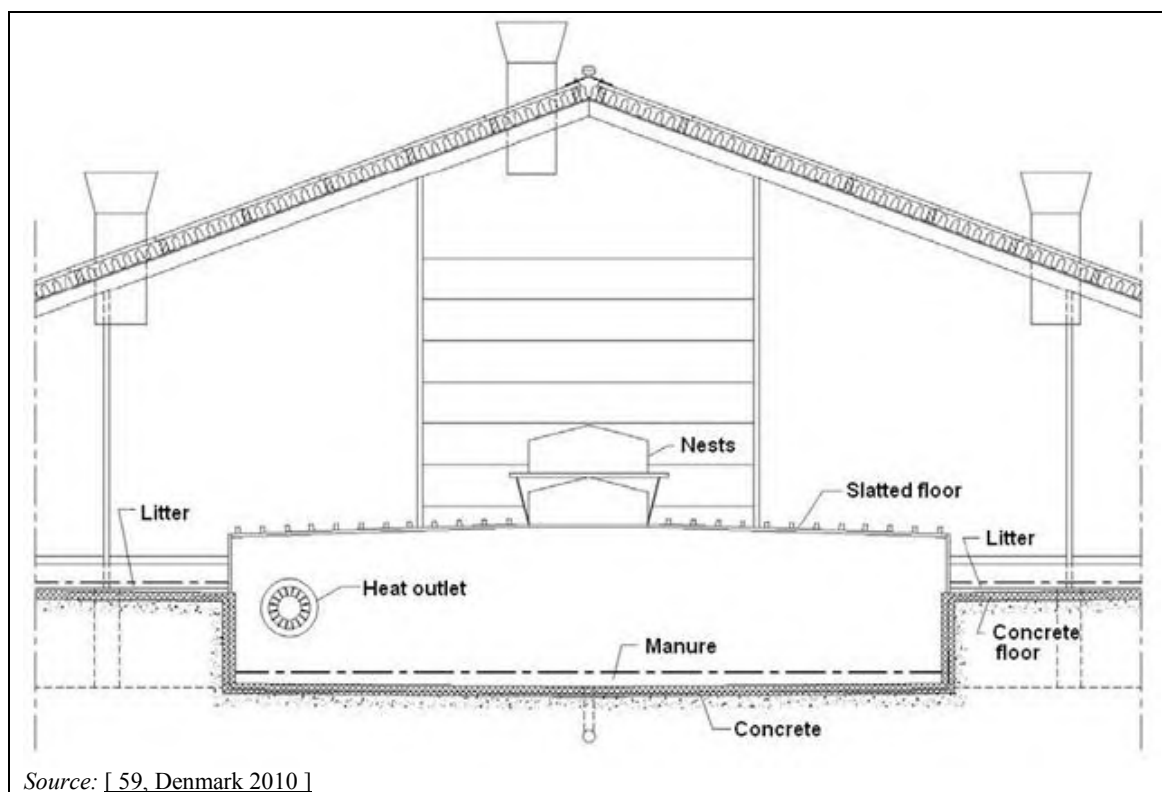

Source: [59, Denmark 2010]

Figure 4.16: Scheme of the underfloor manure drying system in aviary with a deep pit

Achieved environmental benefits

A reduced volatilisation of ammonia and odour compounds is achieved and as a consequence better indoor air quality. A higher nitrogen content in the fertilising manure results. The increase in the nitrogen content of the manure allows it to be used as a substitute for mineral fertiliser.

Cross-media effects

Additional energy is required to heat and blow air onto the pit surface.

Environmental performance and operational data

With the droppings drying, the manure dry matter content is increased from the typical 40 % (without drying) to about 80 %. The energy consumption related to manure drying is reported as 130 kWh per 'animal unit' (one Danish 'animal unit' is defined as the livestock that produces manure with a content of 100 kg of N), which corresponds to approximately 0.65 kWh per bird (an equivalent of 200 laying hens to one Danish animal unit is assumed). The required energy consumption is also reported from Denmark as 0.78 kWh/ap/yr.

Heated ventilation is only required when the indoor house temperature falls below 20 °C. The best results are achieved by ventilating 1.2 m³ of air per animal unit per hour, allowing a

possible reduction of 60 % of ammonia emissions in comparison with a similar system without the underfloor manure drying.

Technical considerations relevant to applicability

The system is typically implemented in new constructions. Manure drying can be installed in existing buildings, but deepening manure pits is a prerequisite for this technique.

Economics

The accumulated additional cost of the manure drying is estimated to be approximately 2 % or 1.5 % of the total annual cost of maintaining each layer hen, depending on whether the value of the saved nitrogen is excluded or included in the calculation. Reported cost data from Denmark indicate an additional investment cost of EUR 0.40/bird/yr, excluding the benefits from saved nitrogen (less mineral fertiliser), corresponding to EUR 3.9/kg N reduced. Annual costs, including the benefits from saved nitrogen are reported as EUR 0.23/bird/yr, corresponding to EUR 2.13/kg N reduced [58, Denmark 2010].

Driving force for implementation

One driving force is the improved indoor environment, due to the reduced ammonia and odour, as a consequence of the dry manure below the slats, resulting in improved animal welfare. Dried manure is easier to handle and remove. Increased fertiliser value is another driving force, due to the higher nitrogen content.

Example plants

Different configurations of the manure drying technique are applied in the Netherlands and in Germany.

Reference literature

[58, Denmark 2010] [59, Denmark 2010]

4.6.2.3 Forced air drying of litter using indoor air (in case of solid floor with deep litter)

Description

The deep litter system, without a manure pit, is equipped with different ventilation systems used to dry the litter. These systems are also used in the housing systems for broilers (see Section 4.6.4.2.1).

Achieved environmental benefits

See Section 4.6.4.2.1.

Cross-media effects

See Section 4.6.4.2.1.

Technical considerations relevant to applicability

See Section 4.6.4.2.1.

Economics

See Section 4.6.4.2.1.

Driving force for implementation

See Section 4.6.4.2.1.

4.6.3 Techniques for housing of pullets

According to Article 4(2) of the 'Recommendation concerning domestic fowl (*gallus gallus*)' adopted by the Council of Europe in 1995, young should be given appropriate experience of management practices and environmental conditions to enable them to adapt to the system which they will encounter later as laying hens, i.e. enriched cages or alternative systems. Housing systems for pullets should be designed to give them appropriate experience of management practices (e.g. particular feeding and watering systems) and environmental conditions (e.g. natural light, perches, litter) to enable them to adapt to the system which they will encounter later in life.

The systems used to rear pullets of laying hens are practically the same as those used to house laying hens. The differences in the management induce different environmental impacts, as a consequence of the different heating needs, the different live weight and the different metabolism of the animals.

In the following sections, for each technique only data related specifically to pullet rearing are given, since techniques have already been described in Section 4.6.1 and Section 4.6.2 for the rearing of layers. The emission values that are associated with pullet rearing and that have been measured are reported in Table 4.62. In Germany, the dust and ammonia emission factors associated with the rearing of pullets (until the eighteenth week) are typically considered equivalent to 70 % of the values applied for the same technique in laying hen housing; the odour emission factors expressed as $ou_E/s/LU$ are considered the same as for the corresponding technique applied in laying hen housing [474, VDI 2011].

Table 4.62: Summary of reported achievable emissions in systems for rearing pullets

Description	NH ₃	PM ₁₀	Odour	Source
	kg/ap/yr	kg/ap/yr	ou _E /s/bird	
Traditional cage system, without forced air drying	0.045	NI	NI	[80, Netherlands 2010]
Section 4.6.3.1.1 Small groups in enriched cages				
Small groups in enriched cages	0.016 ⁽¹⁾	0.008 ⁽¹⁾	0.18 ⁽¹⁾	[80, Netherlands 2010]
Section 4.6.3.1.2 Aviaries				
Aviaries on solid floor with litter. Non-ventilated manure belts, removal once per week	0.064 ⁽²⁾	0.078 ⁽²⁾	0.042 ⁽¹⁾ ⁽³⁾	[81, Germany 2010] [474, VDI 2011]
Aviaries on solid floor with litter. Non-ventilated manure belts, removal twice per week	0.04 ⁽⁴⁾	0.078 ⁽²⁾	0.042 ⁽¹⁾ ⁽³⁾	
Aviaries on solid floor with litter. Ventilated manure belts, removal once per week	0.03 ⁽⁴⁾			
Aviaries on at least 55 % slatted floor. Non-ventilated manure belts, removal once per week	0.050 ⁽¹⁾	0.023 ⁽¹⁾	0.18 ⁽¹⁾	[79, Netherlands 2010]
Aviaries on at least 65–70 % slatted floor. Ventilated manure belts (0.2 m ³ /h/bird at 20 °C), removal once per week	0.029–0.030 ⁽⁵⁾	0.023 ⁽¹⁾	0.181–0.227 ⁽⁵⁾	[74, Netherlands 2010]
Aviaries on at least 35–45 % slatted floor. Ventilated manure belts (0.1 m ³ /h/bird at 18°C), removal once per week	0.030 ⁽¹⁾	0.023 ⁽¹⁾	0.18 ⁽¹⁾	[75, Netherlands 2010]
Aviaries on at least 30–35 % slatted floor. Ventilated manure belts (0.4 m ³ /h/bird at 17 °C), removal once per week	0.014 ⁽¹⁾	0.023 ⁽¹⁾	0.18 ⁽¹⁾	[76, Netherlands 2010]
Aviaries on at least 55–60 % slatted floor. Ventilated manure belts (0.4 m ³ /h/bird at 17 °C), removal once per week	0.020 ⁽¹⁾	0.023 ⁽¹⁾	0.18 ⁽¹⁾	[77, Netherlands 2010]
Section 4.6.3.1.3 Deep litter with or without a manure pit				
Deep litter without a manure pit	0.210 ⁽⁴⁾	0.059 ⁽²⁾	0.056 ⁽⁴⁾ ⁽⁶⁾	[49, Germany 2010] [474, VDI 2011]
Deep litter with a manure pit	0.170 ⁽¹⁾	0.030 ⁽¹⁾	0.18 ⁽⁵⁾	[48, Netherlands 2010]
⁽¹⁾ Values derived by expert judgement based on conclusions by analogy. ⁽²⁾ Modelled values (e.g. results based on N balance). ⁽³⁾ Figures derived from the associated emission value of 30 ou _E /(LU s) for an average weight of 0.7 kg. ⁽⁴⁾ Derived from measurements. ⁽⁵⁾ Measured values. ⁽⁶⁾ Figures derived from the associated emission value of 42 ou _E /(LU s) for an average weight of 0.7 kg. NB: NI = no information provided.				

4.6.3.1 Group cage with manure belts and forced manure drying

Description

The pullets' manure is collected on manure belts that are situated under each tier (or cage level) and transported to a closed storage. At the end of the belt a cross conveyor transports the manure further to the external storage. The manure belts are made of smooth, easy-to-clean material (e.g. polypropylene) so that no residue sticks to them. Some drying takes place on the belts, especially in summer conditions. The higher the frequency of removal, the lower the emission from the housing.

In improved belt systems, air is blown over the manure to achieve faster drying of the manure. The air is introduced just under each tier of cages, usually via rigid polypropylene ducts. Another benefit is the introduction of fresh cooling air immediately adjacent to the birds. Further improvements consist of the introduction of preheated house air and/or the use of heat exchangers to preheat incoming outside air.

In the cages, pullets should be given appropriate experience of management practices (e.g. particular feeding and watering systems) and environmental conditions (e.g. natural light, perches, litter) to enable them to adapt to the husbandry systems which they will encounter later in life.

Achieved environmental benefits

The emission of ammonia is reduced through frequent removal and/or drying of the manure on the belt. Because the manure is transported out of the house and there is no manure residue on the manure belts, a lower odour level is obtained, which improves the climate in the house.

Cross-media effects

Application of this system needs additional energy to operate the belts and the fans used to blow the air over the manure. Additional energy input is also required if preheating is applied.

Environmental performance and operational data

No information provided.

Technical considerations relevant to applicability

No technical restrictions are reported for the implementation of the technique.

Economics

No information provided.

Driving force for implementation

No information provided.

Example plants

No information provided.

Reference literature

[43, COM 2003]

4.6.3.2 Small groups in enriched cages

Description

See Section 4.6.1.2.

Achieved environmental benefits

See Section 4.6.1.2.

Cross-media effects

See Section 4.6.1.2.

Environmental performance and operational data

Under the vertical tiered cages, a manure belt is installed. Air is blown through the forced air drying system at 0.4 m³/h/bird, with a minimum temperature of 17 °C, and it should be fresh. Functional areas for feeding, drinking and resting are arranged above the dropping area. Manure is removed weekly, with a minimum dry matter content of 55 %. Birds are kept at a density of 350–450 cm² per head. In the Netherlands, the minimum available space per bird is reported to be 450 cm² per head.

In the Netherlands, estimations were derived from data of laying hens housed in the same system. Associated ammonia emissions are 0.016 kg/ap/yr and PM₁₀ emissions 0.008 kg/ap/yr when the manure is dried on belts, with an airflow of 0.4 m³ per animal per hour at 17 °C, and removed from the animal house daily.

Technical considerations relevant to applicability

See Section 4.6.1.2.

Economics

No information provided.

Driving force for implementation

It is expected that the use of small group enriched cages, as an alternative system, will increase in the future due to animal welfare legislation. See also Section 4.6.1.2.

Example plants

No enriched cage systems for rearing pullets are yet in use in the Netherlands. Also in Germany, the system is not yet described as a technique for rearing young hens [474, VDI 2011]. Enriched cages are used for the rearing of pullets in some farms in the UK [624, IRPP TWG 2013]. See also Section 4.6.1.2.

Reference literature

[80, Netherlands 2010] [474, VDI 2011] [624, IRPP TWG 2013]

4.6.3.3 Aviaries**Description**

See Section 4.6.2.2.

Achieved environmental benefits

See Section 4.6.2.2.

Cross-media effects

Aviaries generate higher dust emissions compared to enriched cage systems, due to litter material and increased animal activity; dust exposure could be a problem for the farmer and the birds. See also Section 4.6.2.2.

Environmental performance and operational data

The emission levels that are achievable depend on the extension of the slatted floor, on the frequency of manure removal, and on the temperature and volume of the air that is blown over the droppings to dry them. The more the surface is slatted floor, the more manure is periodically removed by the belts that underlie the raised floors. The figures for different combinations of manure belts management are given in Table 4.63.

Table 4.63: Emissions associated with combinations of slatted floor extension, characteristics of the drying air and frequency of manure removal, for the rearing of pullets

Combination	Animal density	Air volume	Air temp.	Slatted floor	Removals per week	NH ₃ emission	PM ₁₀ emission	Reference
	m ² /animal	m ³ /ap/h	°C	%		kg/ap/yr	kg/ap/yr	
Without forced air drying	0.062	NI	NI	55	1	0.050 ⁽¹⁾	0.023 ⁽¹⁾	[79, Netherlands 2010]
Fresh forced air drying	0.062	0.4	17	35	1	0.014 ⁽¹⁾	0.023 ⁽¹⁾	[76, Netherlands 2010]
Fresh forced air drying	0.062	0.4	17	60	1	0.020 ⁽¹⁾	0.023 ⁽¹⁾	[77, Netherlands 2010]
Low ventilation	0.062	0.1	18	50	1	0.030 ⁽¹⁾	0.023 ⁽¹⁾	[75, Netherlands 2010]
Warm forced air drying	0.062	0.2	20	70	1	0.030 ⁽²⁾	0.023 ⁽¹⁾	[74, Netherlands 2010]
Forced air drying	0.030	NI	NI	0	1	0.030 ⁽³⁾	0.080 ⁽³⁾	[474, VDI 2011]
Solid floor	0.030	NA	NA	0	1	0.060 ⁽³⁾	0.080 ⁽³⁾	[81, Germany 2010]
Solid floor	0.030	NA	NA	0	2	0.040 ⁽³⁾	0.080 ⁽³⁾	[474, VDI 2011]

(¹) Values derived by expert judgement based on conclusions by analogy.
(²) Measured values.
(³) Modelled values (e.g. results based on N balance).
NB: NI = no information provided; NA = not applicable.

Technical considerations relevant to applicability

See Section 4.6.2.2.

Economics

In the Netherlands, the investment required is estimated to be EUR 7.35 per animal place on average (from EUR 6.25/ap to EUR 7.8/ap), corresponding to annualised investment costs of EUR 0.92/ap/yr (from EUR 0.78/ap/yr to EUR 0.98/ap/yr). In Germany, investment costs are reported as EUR 11.20 per animal place, on average, corresponding to annualised costs of EUR 1.25/ap/yr.

Driving force for implementation

See Section 4.6.2.2.

Example plants

In the Netherlands, in 2008 about 33 % of pullets were housed in aviary systems. At least 15 farms in Belgium (Flanders) are equipped with this system [467, BE Flanders 2010].

Reference literature

[74, Netherlands 2010] [75, Netherlands 2010] [76, Netherlands 2010] [77, Netherlands 2010] [78, Netherlands 2010] [79, Netherlands 2010] [81, Germany 2010] [467, BE Flanders 2010] [474, VDI 2011]

4.6.3.4 Deep litter with or without a manure pit

Description

See also Section 4.6.2.1.1. Pullets are raised in a house with a concrete floor covered with bedding material (wood shavings or chopped straw). In the middle of the house there may be a manure pit with a slatted floor above it. The slatted surface is reported not to exceed two thirds of the total area. The manure is stored beneath the slatted floor and is removed after delivery of the flock. For configurations without a manure pit, manure is removed by mobile means.

A cross section of a housing system with deep litter and a manure pit, for the rearing of pullets, is shown in Figure 4.17.

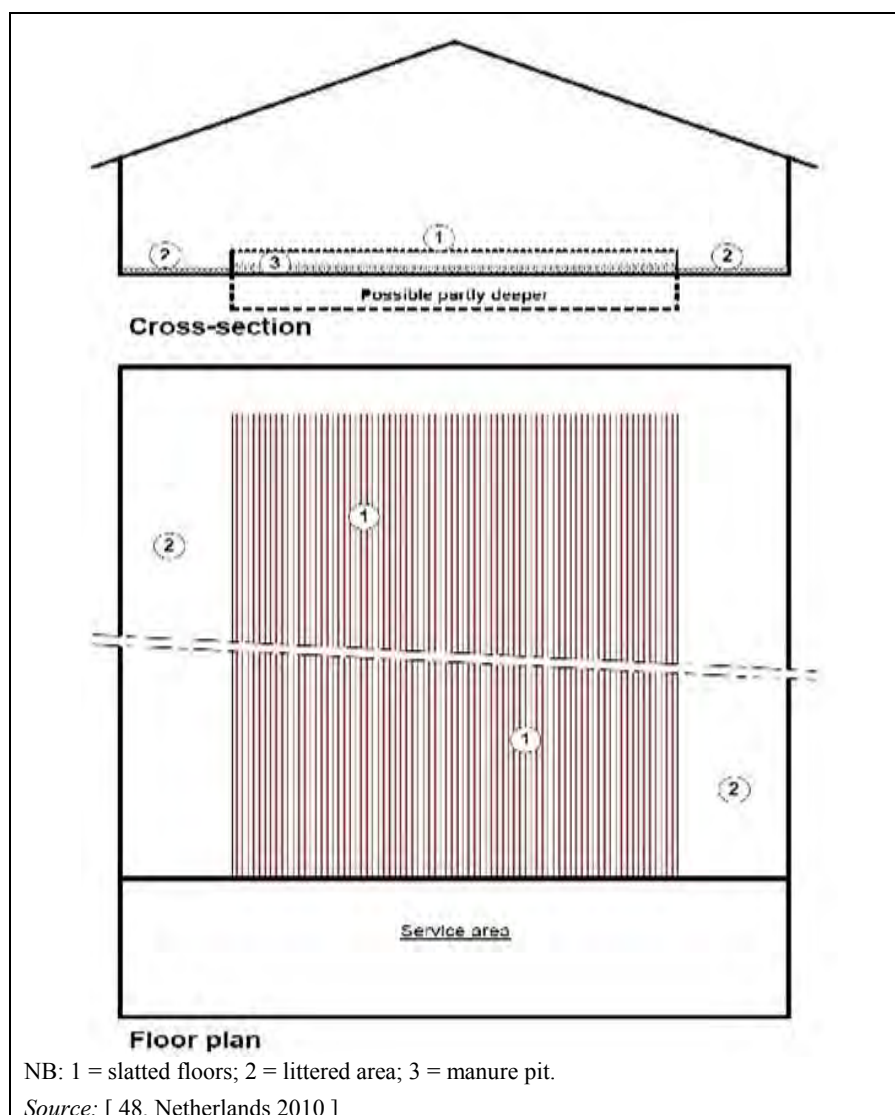

Figure 4.17: Cross section of the housing system with deep litter and a manure pit

Achieved environmental benefits

See Section 4.6.2.1.1.

Cross-media effects

Cross media-effects include higher ammonia and odour emissions, due to manure storage in the housing system and removal only at the end of the rearing period. Dust emissions are higher compared to cage systems, due to the litter material and increased animal activity; dust exposure could be a problem for the farmer and the birds.

Environmental performance and operational data

Functional areas for feeding, drinking and resting are arranged above the dropping area. The system has more management requirements, in particular for the rearing in confinement rings during the first days after birth (up to seven days), when several checks are necessary on a daily basis (e.g. control of chicks and temperature). Later, at least a daily control of the birds and the bedding is sufficient.

The available space provided per bird is reported to be between 0.0625 m² and 0.07 m², and the duration of the growing period is reported to be between 16 and 18 weeks; the animal weight at the end of the rearing period is around 1.3 kg.

Technical considerations relevant to applicability

See Section 4.6.2.1.1.

Driving force for implementation

Pullets should be raised in the same system they are placed in during the laying period. The system is more animal-friendly due to the increased space availability (compared with cages).

Economics

In Germany, for the configuration without a manure pit, the demand for bedding material is reported to be equivalent to 2.3 kg/ap/yr, the labour demand 0.03 h/ap/yr, and the energy consumption is reported as 0.52 kWh/ap/yr for lighting and 2.2 kWh/ap/yr for ventilation.

In the Netherlands, for the configuration with a manure pit, investment costs are reported to be from EUR 2.65 to EUR 4 per animal place, with an average value of EUR 3.35 per animal place, and the annualised investment costs vary from EUR 0.33/ap/yr to EUR 0.5/ap/yr, with an average value of EUR 0.42/ap/yr.

Example plants

In the Netherlands, the deep litter system with a manure pit is the reference housing system for raising pullets. The deep litter technique without a manure pit is also widespread in Germany.

Reference literature

[48, Netherlands 2010] [49, Germany 2010]

4.6.4 Techniques for housing of broilers

Traditionally, broilers are kept in houses with a fully littered floor (see Section 2.2.2). Both for animal welfare reasons and to minimise ammonia emissions, wet litter has to be avoided.

The dry matter content of the litter and emissions depend on:

- the drinking system design and operation;
- the duration of the growing period;
- the stocking density;
- the use of floor insulation;
- the ventilation rate and airflow direction;
- the climatic conditions;
- the management of rainwater;
- bird health (e.g. diarrhoea);
- the type and amount of bedding material.

Ammonia emissions decrease with the increase of the manure dry matter content; for a dry matter content higher than 65 % approximately, the emission reduction is more than proportional [90, Italy 2010].

The stocking density and the duration of the growing period also have an effect on ammonia emissions, in the sense that the increasing bird body weight during rearing implies that higher manure volumes are produced, as well as increased bedding compaction. The latter effect depends on the type of litter material, the season and the humidity of the litter, because the compacted crust that can develop on the surface of a high-density house does not permit air to penetrate and reach the inner layers [90, Italy 2010]. Reported typical bedding material consumption is presented in Table 3.31 for chopped straw, wood shavings and peat. A summary of the emissions associated with techniques that have been reported is presented in Table 4.64.

Table 4.64: Summary of reported emissions from broiler housing with different system configurations

Description	Slaughter weight (rearing period)	NH ₃	PM ₁₀	Odour	Source
	kg				
4.6.4.1 Forced ventilation and a non-leaking drinking system (in case of solid floor with deep litter)					
Ridge ventilation, wood shavings bedding, animal density 17.5–20.8 kg/m ²	2.1 (females, 39 days)	0.034 ⁽¹⁾	0.025 ⁽²⁾	0.032 ⁽²⁾	[96, UK 2010] [97, UK 2010]
Cross ventilation	2.1 (females, 6 weeks)				[98, UK 2010]
Tunnel ventilation					[99, UK 2010]
Side ventilation	3 (males, 7.5 weeks)				[100, UK 2010]
Ridge ventilation					[101, UK 2010]
Tunnel ventilation, animal density of 37 kg/m ²	1.5 (34 days)	0.035 ⁽¹⁾ –0.039 ⁽²⁾	0.015–0.025 ⁽¹⁾	0.09 ⁽³⁾	[87, Germany 2010] [500, IRPP TWG 2011]
	2 (42 days)	0.049 ⁽¹⁾ –0.054 ⁽²⁾	0.015–0.025 ⁽¹⁾	0.12 ⁽³⁾	
Wood shavings bedding, animal density of 35 kg/m ²	2.5–3.3	0.112 (0.096–0.127) ⁽³⁾	NI	NI	[92, Italy 2010] [90, Italy 2010]
Straw bedding, animal density of 35 kg/m ²	2.5–3.3	0.12 (0.114–0.126) ⁽³⁾	NI	NI	
Wood shavings bedding, animal density of 30 kg/m ²	2.5–3.3	0.096 (0.064–0.142) ⁽³⁾	NI	NI	
Straw bedding, animal density of 30 kg/m ²	2.5–3.3	0.101 (0.086–0.116) ⁽³⁾	NI	NI	
Straw or rice husk bedding, summer/winter observations, animal density of 24–30 kg/m ²	1.45–1.74	0.079 (0.055–0.102) ⁽³⁾	NI	NI	
Non-leaking drinking and tunnel ventilation (DM 78 %), animal density of 27 kg/m ² ⁽⁴⁾	1.6 (females, 39 days) 3.3 (males, 57 days)	0.069–0.073 ⁽³⁾	NI	NI	[89, Italy 2010]

Description	Slaughter weight (rearing period)	NH ₃	PM ₁₀	Odour	Source
	kg	kg/ap/year		ou _F /s/bird	
Non-leaking drinking and cross ventilation, animal density of 30 kg/m ² (DM 61 %) ⁽⁴⁾	2 (females, 41 days) 3.3 (males, 62 days)	0.082–0.090 ⁽³⁾	NI	NI	[88, Italy 2010]
Deep litter	NI	0.06–0.1 ⁽²⁾	NI	NI	[624, IRPP TWG 2013] [624, IRPP TWG 2013] [656, Ponchant et al. 2012]
Deep litter (0.05 m ² /bird)	(40–54 days)	0.180 ⁽⁵⁾	NI	NI	[50, Austria 2010]
4.6.4.3–4.6.4.4 Forced air drying of litter using indoor air (in case of solid floor with deep litter)					
Perforated floor with forced air drying system	NI	0.014	NI	NI	[43, COM 2003]
Tiered floor system with forced air drying	2.25 (49 days)	0.0203 ⁽³⁾	0.022 ⁽⁵⁾	0.24 ⁽¹⁾ (0.19–0.7) ⁽³⁾	[585, Netherlands 2010]
4.6.4.5 Separation of hatching and growing broiler chicks for a limited time (in case of tiered floor systems)					
Separate hatching and rearing up to 13 days, finishing in low emission houses	NI	0.018–0.040 ⁽⁶⁾	0.020 ⁽²⁾	0.22 ⁽²⁾	[94, Netherlands 2010] [640, Netherlands 2013]
Separate hatching and rearing up to 13 days, finishing in standard emission houses	NI	0.070	0.020 ⁽²⁾	0.22	[473, Infomil 2011]
Separate hatching and rearing up to 19 days, finishing in low emission houses	NI	0.015–0.038 ⁽⁶⁾	0.017	0.19	[93, Netherlands 2010] [640, Netherlands 2013]
Separate hatching and rearing up to 19 days, finishing in standard emission houses	NI	0.060	0.017	0.19	[473, Infomil 2011]
4.6.4.2 Forced drying system of litter using indoor air (in case of solid floor with deep litter)					
Litter-based systems with circulating fans	2.1–2.34 (37–42 days)	0.037 ⁽¹⁾ (0.0102–0.0418) ⁽³⁾	0.022 ⁽⁵⁾	0.24 ⁽¹⁾ (0.11–0.41) ⁽³⁾	[586, Netherlands 2010]
Litter-based systems with circulating fans and a heat exchanger	2.5 (38–47 days)	0.021 (0.004–0.061) ⁽³⁾	0.019 (0.0176–0.02) ⁽¹⁾	0.24 ⁽⁵⁾	[464, Netherlands 2010]
Litter-based systems with (equally spread) recirculated air by indoor fans and heaters	2.26–2.37 (41–49 days)	0.035 ⁽¹⁾ (0.005–0.128) ⁽³⁾	0.022 ⁽⁵⁾	0.24 ⁽⁵⁾	[470, Netherlands 2011]
⁽¹⁾ Derived from measurements. ⁽²⁾ Modelled values (e.g. results based on N balance). ⁽³⁾ Measured values. ⁽⁴⁾ Before sex separation. ⁽⁵⁾ Values derived by expert judgement based on conclusions by analogy. ⁽⁶⁾ The upper end of the range corresponds to a combination with the combideck system and the lower end to a combination with the tiered floor system with forced air drying. NB: NI = no information provided.					

4.6.4.1 Natural or forced ventilation with a non-leaking drinking system (in case of solid floor with deep litter)

Description

A layer of bedding material is spread uniformly over the entire floor area at the beginning of each growing period and is removed at the end of the cycle as broiler litter (solid manure). Bedding is mainly made up of chopped straw, wood shavings, rice husks, peat or other material. The absorbent bedding material when mixed with droppings binds urine and faeces in the litter and provides a dry area. Drinking water system design and operation are such that leakage and spills on litter are prevented (e.g. use of nipples instead of bell drinkers). The use of floor insulation is intended to reduce litter moisture by preventing air moisture condensation. Floor insulation can be achieved by using different materials, such as concrete or clay. The ventilation rate in forced ventilated buildings is automatically controlled to remove moisture under all weather and seasonal conditions while meeting the physiological needs of the birds.

Reported variations of the basic litter-based system are:

- combination with free range and/or a veranda;
- open climate house (natural ventilation);

Achieved environmental benefits

Ammonia emissions are reduced by keeping the litter dry.

Cross-media effects

Higher dust emissions due to the presence of litter and increased bird movement.

Environmental performance and operational data

Ammonia is emitted through an enzymatic decomposition (hydrolysis) reaction of urea:

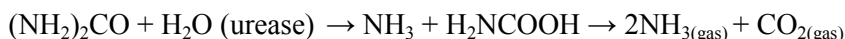

Drying will inhibit the hydrolysis of nitrogen in the manure, thereby reducing NH_3 emissions. At moisture levels in litter below 30–35 %, the rate of reactions responsible for ammonia volatilisation are greatly reduced [[91, Italy 2010](#)].

Drinking water spillages increase the litter moisture content. In particular, ammonia losses from broiler houses using traditional bell drinkers have been found to be three times greater (3.3 g $\text{NH}_3\text{-N/h}$ on average per LU) than those using nipple drinkers, although differences do not seem to be statistically confirmed [[146, DEFRA 2002](#)].

A typical emission level associated with this technique, regardless of the effect of the nutritional management on the manure composition, is 0.08 kg NH_3 per broiler place per year. In fact, ammonia emissions depend on the specific housing system; proper ventilation management and non-leaking drinking systems are among the important parameters for keeping the litter dry and, therefore, reducing ammonia emissions. The NH_3 emission reduction efficiency is reported to range from 20 % to 30 % for naturally or insulated, forced ventilated houses, equipped with a non-leaking drinking system [[508, TFRN 2014](#)].

Reported ranges of emissions to air are presented in Table 4.64. N_2O emissions of between 0.025 kg and 0.032 kg $\text{N}_2\text{O/ap/yr}$ have been reported. The effects of ventilation on ammonia emissions have been studied in Italy for two different mechanical ventilation settings. Reported results and operating conditions applied in two fully littered housing systems for broilers are given in Table 4.65.

A good regulation of the ventilation system, avoiding cold air drafts and water vapour condensation on the litter, a good control of the water leakage from the drinking line, and use of

a computerised control system contribute to a higher ammonia reduction. Based on the results reported from Italy, an ammonia emission reduction of 20–30 % can be achieved with an appropriate management system which can be applied in new and existing buildings [88, Italy 2010] [89, Italy 2010].

Table 4.65: Effects on emissions of controlling mechanical ventilation in deep litter broiler housing systems

Parameters	Units	Housing system	
		Cross ventilation	Tunnel ventilation
Final weight	kg	2.1 (standard) – 3.3 (heavy)	1.6 (standard) – 3.3 (heavy)
Rearing time	days	39 (standard) – 57 (heavy)	41 (standard) – 62 (heavy)
Bird places	places	19 300 (9 000 female + 10 300 male)	12 100 (6 000 female + 6 100 male)
N content of three-phase feed	%	3.9–3.5	4.4–3.3
Cold season, ventilation rate	m ³ /ap/h	1.1 (0.4–2)	1.4 (0.5–3.6)
Warm season, ventilation rate	m ³ /ap/h	9.7 (1.2–28.8)	10 (1.6–23.7)
Manure DM content	%	61	78
NH ₃ emissions	kg/ap/yr	0.082–0.09	0.069–0.073
Reduction of NH ₃ emission	%	20	30
<i>Source: [88, Italy 2010] [89, Italy 2010]</i>			

Other trials carried out in Italy also investigated the effect on ammonia emissions of different ventilation conditions (tunnel or cross ventilation), animal densities (from 24.1 kg/m² to 30 kg/m²), bedding materials (straw or rice husks) and weather conditions (summer and winter). Tunnel ventilation achieved a more even drying of the manure at the end of the cycle, as well as a higher average dry matter content (69 % in comparison to 63 % for cross ventilation). The average ammonia emission factor was found to be 0.079 kg/bird/year (average equal to 0.102 kg/bird/year for winter and 0.057 kg/bird/year for summer). During the summer months, when high ventilation rates allow the achievement of higher levels of dry matter in the litter, regardless of the type of ventilation, ammonia emissions are expected to be lower. As regards stocking density, in some cases emissions from compacted litter were higher than from areas with loose litter because in this case air cannot reach the deeper layers in order to dry litter. In situations with high densities, the formation of a compact surface layer may slow down emissions even though moisture is higher because air exchange with the interior layers is prevented [90, Italy 2010] [91, Italy 2010].

It is also reported from Italy that forced ventilation systems with longitudinal spread can be designed so that inlet tubes convey cold air to the ceiling (in winter), forcing hot air to reflux down. In this way, good air circulation is achieved and water condensation on the litter is avoided, maintaining it sufficiently dry [624, IRPP TWG 2013].

Data reported by Finland, concerning deep litter broiler houses equipped with energy-saving fans, show a reduction of ammonia emissions by 20–30 %, as well as a reduction in odour emissions (see Section 4.5.4.2.1.4) [144, Finland 2010]. In the UK, for all forced ventilation designs in broiler housing, the same ammonia emission factor is used (see Table 4.64) [148, BPC 2009].

Italy and the UK reported similar ventilation rates in the warm season, which are on average in the range of about 10–15 m³ per bird place per hour. Averages recorded in the colder seasons differ between the countries, being around 1.1 m³ to 1.4 m³ per bird place per hour in Italy and 7.5 m³ to 11 m³ per bird place per hour in the UK. Peaks of maximum airflows in the summer

have been reported as 23–28 m³ per bird place per hour in Italy. The German welfare standards require minimum airflows of 4.5 m³/kg live weight per hour on hot days; hence peaks of up to 8 m³ per bird place per hour were recorded. Energy requirements have been reported by Germany and are displayed in Table 4.66.

Table 4.66: Breakdown of resource demand in kWh per bird place/year in deep litter broiler houses (cycles of 38–42 days)

Operation	Basic housing system	Open climate housing	Basic housing system with free range	Basic housing system with a veranda and free range
Lighting	0.330	0.200	0.330	NI
Ventilation	0.730	0.100	0.730	NI
Heating	4.500	NI	5.500	NI
Feeding	0.140	0.140	0.140	0.140
Removal/cleaning	0.140	0.140	0.140	0.140
Total	5.84	NA	6.84	NA
NB: NI = no information provided; NA = not applicable.				
Source: [87, Germany 2010]				

In Finland, data for the consumption of resources have been reported for electricity, from 0.29 kWh/ap/yr to 1.26 kWh/ap/yr, water from 4 litres/ap/yr to 34 litres/ap/yr and labour from 0.016 hours/ap/yr to 0.040 hours/ap/yr. Around 1.42 kWh/ap/yr are needed from fuels; in the reported case, straw is used as fuel.

Naturally ventilated/open climate houses are also in use. As relatively lower average temperatures are achieved compared to houses with mechanically controlled ventilation, lower ammonia emissions are also expected, as well as a better indoor climate, lower energy demands and lower investment and operating costs. In houses with natural ventilation, floor insulation (e.g. concrete, clay, membrane) prevents further water condensation in the litter. Non-leaking drinking systems are necessary. Cooling of the incoming air is possible.

The variant of the litter-based system with free range is applicable from day 20 onwards. Free-range areas include natural ground and structured outdoor areas with trees and installations providing shade and protection from rain as well as from diurnal birds. When a veranda is also combined with the free range, it has a solid floor with bedding. In housing with free range, a 10 % higher ammonia emission is estimated; odour emissions are expected to be the same [87, Germany 2010] [500, IRPP TWG 2011]. Veranda and free-range variations are not intended to reduce NH₃ emissions.

Rice husks can also be used as a bedding material (e.g. in the region of Andalusia in Spain) and provide good hygroscopic properties and fire safety when using biomass burners inside farms.

Technical considerations relevant to applicability

No technical restrictions are reported for the implementation of the technique. For natural ventilation see Section 4.5.6.

Economics

Investment costs have been calculated in Germany for sheds of different sizes, as reported in Table 4.67.

Table 4.67: Investment costs for deep litter houses for broilers

Type of housing	Housing for 35 000–37 000 bird places		Housing for 26 500 bird places	
	Investment cost (EUR/ap)	Annualised investment cost (EUR/ap)	Investment cost (EUR/ap)	Annualised investment cost (EUR/ap)
Basic housing	12.00	1.04	17.00	1.45
Open climate housing	12.00	0.99	16.00	1.38
Basic housing with free range	NI	1.74	NI	NI

NB: NI = no information provided.
Source: [87, Germany 2010]

The annual operating cost is reported to be equivalent to EUR 3.5/bird place for the standard system and the same for the alternative with an open climate house [87, Germany 2010].

Investment data reported from Finland for a farm of 30 000 birds are comparable with the data presented above, with a cost of EUR 11.67 per bird place for the initial investment and EUR 0.93 as the annualised cost (20 years amortisation, 5 % interest rate). In the UK, investment costs have been reported to be in the range of EUR 14 and EUR 16 per bird place.

The cost per bird, for abating ammonia emissions through a reduction in temperature of 1 °C, has been calculated in the UK to be in the range of EUR 0.27–0.28 per bird, leading to a reduction of NH₃ emissions of 0.04 g per kg of bird per day. However, there are concerns that productivity may be reduced and that there may be a related increase in energy consumption due to higher ventilation rates [151, Link CR 2005].

Driving force for implementation

Animal welfare can be improved by the possible combination with verandas and/or free ranges, offering valued non-environmental benefits, such as external climate/stimuli, functional areas, more space and more bird locomotion. The alternative design with a veranda and/or outdoor free range offers a space per bird of 0.085 m²/bird, in comparison with 0.043m²/bird in the standard housing system.

Example plants

This type of housing is the most widespread housing system for broiler production.

Reference literature

[87, Germany 2010] [88, Italy 2010] [89, Italy 2010] [90, Italy 2010] [91, Italy 2010] [92, Italy 2010] [95, UK 2010] [96, UK 2010] [97, UK 010] [98, UK 2010] [99, UK 2010] [100, UK 2010] [144, Finland 2010] [145, Finland 2010] [146, DEFRA 2002] [148, BPC 2009] [151, Link CR 2005] [500, IRPP TWG 2011] [508, TFRN 2014] [624, IRPP TWG 2013]

4.6.4.2 Forced drying system of litter using indoor air (in case of solid floor with deep litter)

4.6.4.2.1 Litter-based systems with circulating fans

Description

The deep litter system is equipped with vertical shafts and a ventilator hanging from the ceiling. At the bottom of the shaft, at a maximum height of 1.20 m above the litter, a special element is placed to direct the warm air from the roof of the house horizontally over the litter. In addition, circulating fans homogenise the airflows at the bird level, without increasing the volume of air

supplied by the central ventilation. This system is used in the Netherlands to reduce the ammonia emissions.

Achieved environmental benefits

Drying of the surface litter is achieved and, consequently, ammonia emissions are reduced. The positive effect, in terms of ammonia emission, is calculated as a 54 % reduction in emissions compared to the reference system used in the Netherlands [586, Netherlands 2010].

Because of mixing the warm ceiling air with the colder air just above the floor, a slight benefit (10 %) is calculated for heating costs, i.e. from reduced energy consumption [586, Netherlands 2010].

Cross-media effects

Due to the ventilators in the shafts, an extra demand for electricity is expected. However, these costs can be partly compensated by the improved heat distribution.

Environmental performance and operational data

Vertical shafts should be placed every 150 m², in two rows along the length of the house, and should not be placed right opposite each other, in order to ensure homogenous spreading of warm air. The fans work continuously, with a reported minimum capacity of 1.8 m³/hour per bird place. At the beginning of the cycle (one-day-old chicks), the ventilators start at a capacity of 10 % and progressively reach 100 % capacity by day 40.

Surface drying of the litter in broiler houses reduces NH₃ emissions. Emission factors achieved in the Netherlands for an installed ventilation capacity of 1.8 m³/hour per bird place are 0.037 kg NH₃/ap/yr in broiler houses and 0.183 kg NH₃/ap/yr in parent houses (broiler breeders) [469, Netherlands 2011]. These ammonia emission levels can only be achieved if the system fully complies with the operational requirements.

Data concerning the emission values associated with the application of deep litter housing systems equipped with circulating fans in the Netherlands are reported in Table 4.68. For the same systems, typical ventilation rates are reported to be in the range between 1.1 m³/ap/h and 1.3 m³/ap/h during the cold season and between 1.9 m³/ap/h and 2.8 m³/ap/h during the warm season, combined with an inlet air cooling system using water fogging.

Table 4.68: Reported emissions from broiler production in deep litter housing systems with circulating fans

Parameter	Unit	Emission levels
Ammonia	kg NH ₃ /ap/yr	0.037 (0.0102–0.0418)
PM ₁₀	kg PM ₁₀ /ap/yr	0.022
Odour	ou _E /s/ap	0.24 (0.11–0.41)
<i>Source: [585, Netherlands 2010]</i>		

Technical considerations relevant to applicability

The technique is applicable to new housing systems for broilers and in most existing houses; however, for existing houses, the applicability may be limited if the building has a very low ceiling [586, Netherlands 2010].

The technique may not be applicable in hot climates in summer when there is a need for cooling [624, IRPP TWG 2013].

Driving force for implementation

Mixing the air inside the house allows a better indoor climate with positive effects on animal health and welfare and labour conditions.

Economics

The extra investment costs associated with the technique compared to the traditional housing costs are reported to be EUR 1/animal or EUR 0.14/bird place/year [586, Netherlands 2010].

Example plants

In 2008, in the Netherlands, the housing system with deep litter and circulating fans was applied for about 10 % of the total bird places [586, Netherlands 2010].

Reference literature

[339, ITAVI 1997] [349, ITAVI 1998] [350, France 2010] [354, ITAVI 2004] [469, Netherlands 2011] [585, Netherlands 2010] [586, Netherlands 2010] [624, IRPP TWG 2013]

4.6.4.2.2 Litter-based systems with circulating fans and a heat exchanger

Description

This technique is intended for ammonia and dust reduction and is based on heating and drying the litter by the combined use of heat exchangers and ventilators (see Section 4.5.4.2.1.2 for information on circulating fans in combination with heat exchangers). Incoming air is warmed up in a heat exchanger using the heat recovered from the indoor air. The ventilators spread the warm air homogeneously over the litter. An improved version, with a higher capacity heat exchanger, is intended for extra dust abatement. A description of heat exchangers is given in Section 4.5.5.1.

Achieved environmental benefits

In addition to a reduced energy requirement, achievable by using a heat exchanger (see also Section 4.5.4.2.1.2), ammonia reductions are achieved and dust is removed with improved exchangers. The generic NH₃ emission reduction efficiency for techniques using internal air for litter drying is reported to range from 40 % to 60 % at a cost of EUR 2 to EUR 4 per kg of NH₃ abated per year [508, TFRN 2014]. The resulting manure is drier and lighter, which implies a lower transport weight and consequently lower associated costs.

Cross-media effects

No direct cross-media effects have been reported.

Environmental performance and operational data

The capacity of the heat exchanger is at least 0.35 m³/bird place per hour, whereas the capacity of the improved heat exchanger for extra dust removal is 1.0 m³/bird place per hour. A removal of fine dust equivalent to 13 % is reported for the normal type of heat exchanger, and 31 % for the improved type.

The placement of the outlet of the heat exchanger depends on the type of ventilation (see Figure 4.18). The ventilators must be placed no more than 20 m from each other and at a maximum distance from the ceiling of 1.5 m. A capacity of 6 000 m³/h per ventilator is reported, with at least 23 m³ per square metre of litter.

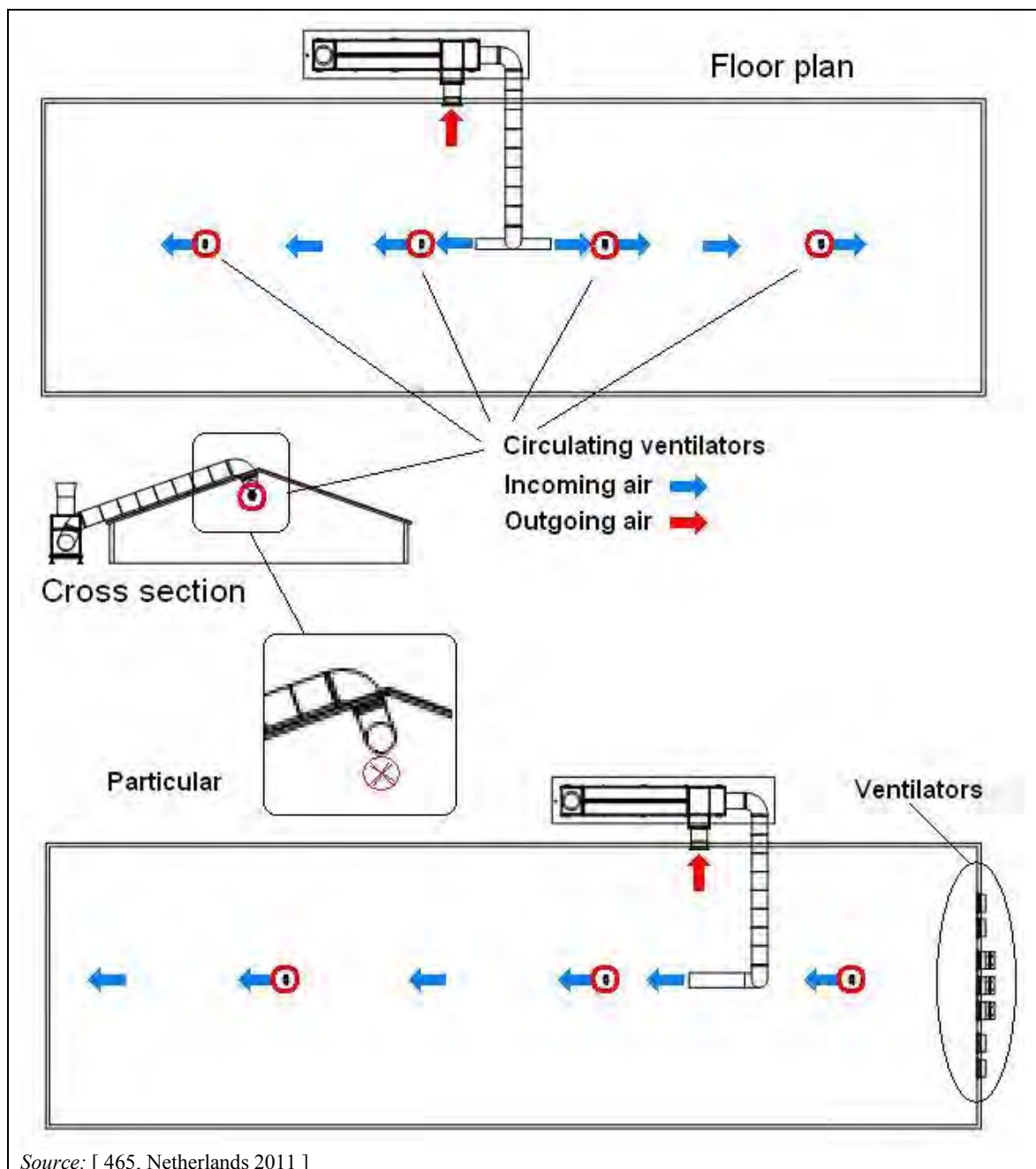

Figure 4.18: Examples of layouts for systems of circulating fans and a heat exchanger

Measurements were carried out at four farms, with capacities from 21 000 to 39 000 birds, fed with three or four feeding phases to a final weight of 2.5 kg (one farm's final weight was 1.9 kg), with ventilation rates in the range of 0.3–0.9 m³/bird place per hour in the cold season, and 2.1–4.8 m³/bird place per hour in the warm season. Recorded ammonia emissions showed a maximum of 0.061 kg NH₃/ap/yr and an average value of 0.021 kg NH₃/ap/yr, which is 74 % lower than the reference level in the Netherlands.

Measurements of dust emissions ranged from 0.02 kg/ap/yr with normal equipment to 0.017 6 kg/ap/yr with improved equipment (10 % and 20 % less respectively compared to the Dutch reference).

Technical considerations relevant to applicability

The system can be implemented in any new broiler house and in most existing ones depending on the ventilation system already in place.

Driving force for implementation

This solution allows for better climate control which is especially beneficial during the first days of rearing since it leads to stronger and healthier animals.

Economics

In a house with a capacity of around 40 000 birds, the investment requirements are in the range of EUR 0.7–1.0 per bird place and the annual operating costs are around EUR 0.005 per bird place. Cleaning and checking of the heat exchangers will take 1.5 to 2 hours work per round per exchanger. Under Dutch climatic conditions, the savings in heating costs that heat exchangers allow can be up to 50 %, corresponding to about EUR 0.38/ap/yr (2011 prices).

Example plants

Heat exchangers are well known and becoming widespread in the Netherlands.

Reference literature

[464, Netherlands 2010] [465, Netherlands 2011] [508, TFRN 2014]

4.6.4.2.3 Litter-based systems with air recirculated (equally spread) by indoor fans and heaters

Description

A combination of heaters with indoor ventilators is used to heat the house (see also Section 4.5.4.2.1.3). Ventilators drive warm air from the ceiling down to the floor level. The air is warmed up by thermal exchange with hot water produced by an indirectly fired thermal heater using propane or natural gas or by central heating. The heaters are provided with equipment to let the air come out horizontally, spreading it all over the litter. A schematic representation of the housing system with recirculating indoor fans, combined with indirectly fired heaters, is given in Figure 4.19.

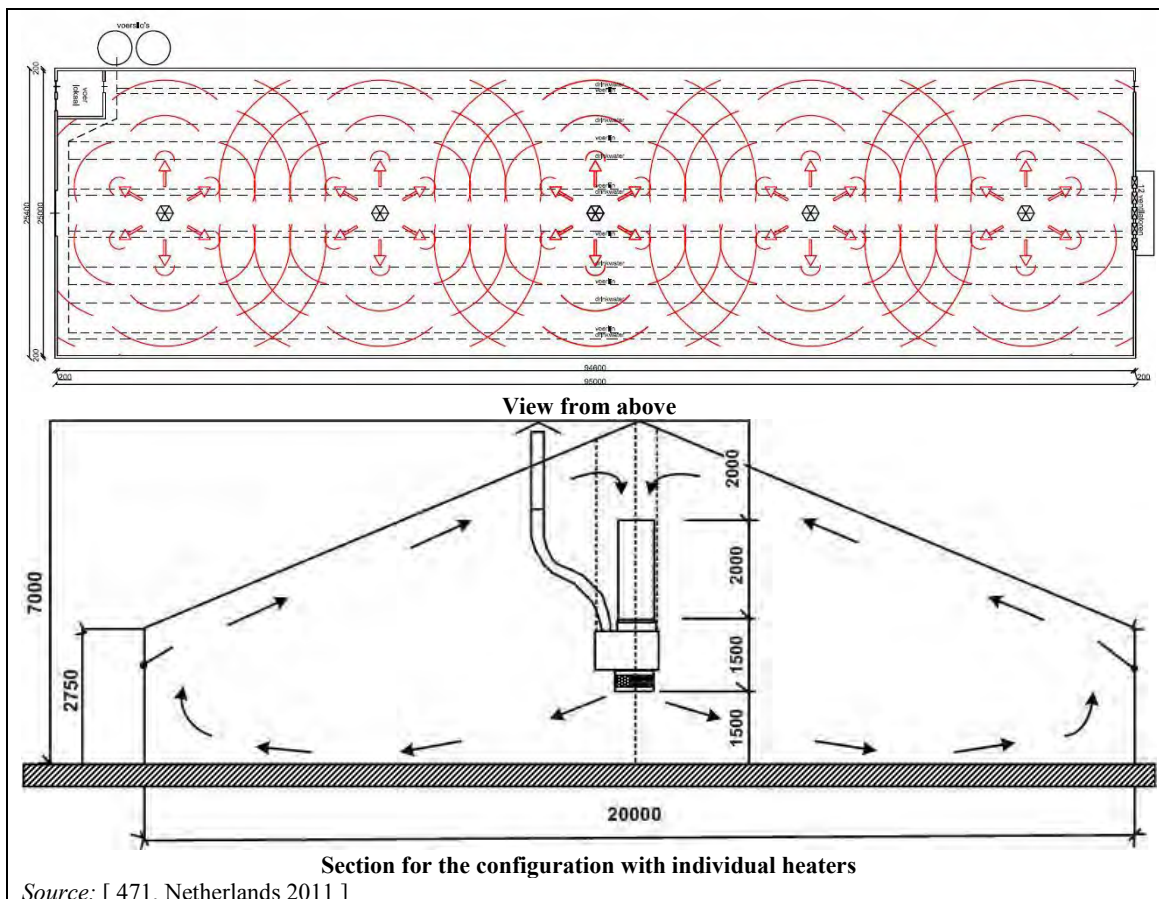

Figure 4.19: Plan and cross section of horizontal ventilation with air recirculated by indoor fans

Achieved environmental benefits

Ammonia reduction is achieved by drying the litter through warm air blowing. Ammonia emissions are reported to be 56 % lower than those corresponding to the reference system used in the Netherlands. An optimal indoor air climate is achieved at low heating costs. A reduction of energy consumption for heating of around 20 % is achievable, with the related cost reduction, as a result of the good mixing of warm air from the ceiling with colder air just above the housing floor.

Cross-media effects

Around 20 % additional electricity is used by the ventilators compared to the basic litter-based housing systems. However, because of the reduced CO₂ and moisture levels inside the house produced by heaters, the minimum ventilation rate at the start of the rearing period can be reduced. This saving can compensate for the extra electric energy used by the ventilators.

Environmental performance and operational data

The number of heaters installed depends on their heating capacity. In general, each heater should cover a maximum area of 450 m² and the distance between two heaters should not exceed 25 m. The maximum distance from the rooftop, where the suction of warm air is installed in order to convey it to the heater, is 2 m, whereas the heated air entering the housing system is released at 1.5 m, at the most, from the floor.

Normally, the ventilators are running at least 20 % of their maximum capacity. When the temperature is low and air needs to be warmed up, the heating is turned on and then the ventilators run at full capacity.

In the Netherlands, the following measured ammonia emissions are associated with the application of this housing system [[471, Netherlands 2011](#)]:

- broilers: 0.005–0.128 kg NH₃/ap/yr, with an average value of 0.035 kg/ap/yr;
- broiler breeders: 0.180 NH₃/ap/yr;
- turkeys: 0.489 NH₃/ap/yr;
- guinea fowl: 0.058 NH₃/ap/yr.

Dust and odour emissions associated with broiler rearing are equivalent to 0.022 kg PM₁₀/ap/yr and 0.24 ou_E/s per bird.

Technical considerations relevant to applicability

This system can be installed in new houses for broilers. When retrofitting existing houses, the applicability might depend on the height of the ceiling.

Driving force for implementation

The continuous mixing of warm air from the ceiling with the colder air at lower heights allows energy savings corresponding to about 20 % of the heating costs. The system can help to create a better indoor climate.

Economics

Investment and operating costs depend on the choice of fuel and are estimated as follows [[470, Netherlands 2011](#)]:

- investment requirements: EUR 1.5/ap, (EUR 1.3–1.7/ap);
- annualised investment costs: EUR 0.23/ap/yr, (EUR 0.20–0.26/ap/yr);
- annual operating costs: EUR 0.22/ap/yr, (EUR 0.15–0.28/ap/yr);
- total annual cost: EUR 0.45/ap/yr, (EUR 0.41–0.48/ap/yr).

Example plants

Around 15 % of the Dutch bird capacity was equipped with this system at the end of 2009.

Reference literature

[470, Netherlands 2011] [471, Netherlands 2011]

4.6.4.3 Perforated floor with a forced air drying system

Description

Birds are raised on an elevated and perforated double floor that is covered with litter (see Figure 4.20). Air is continuously blown through the perforations to dry the litter. The perforations cover a minimum surface area of 4 % of the total floor area and are protected by a plastic or metal grid. A continuous upward airstream flows through the perforated floor, with a minimum capacity of 2 m³ per hour per broiler place. Manure and litter remain on the floor for the whole growing period (about 6 weeks). The continuous airflow dries the litter (> 70 % dry matter) and this results in reduced ammonia emissions. Improved designs can improve the distribution of the drying air by channelling the airstream.

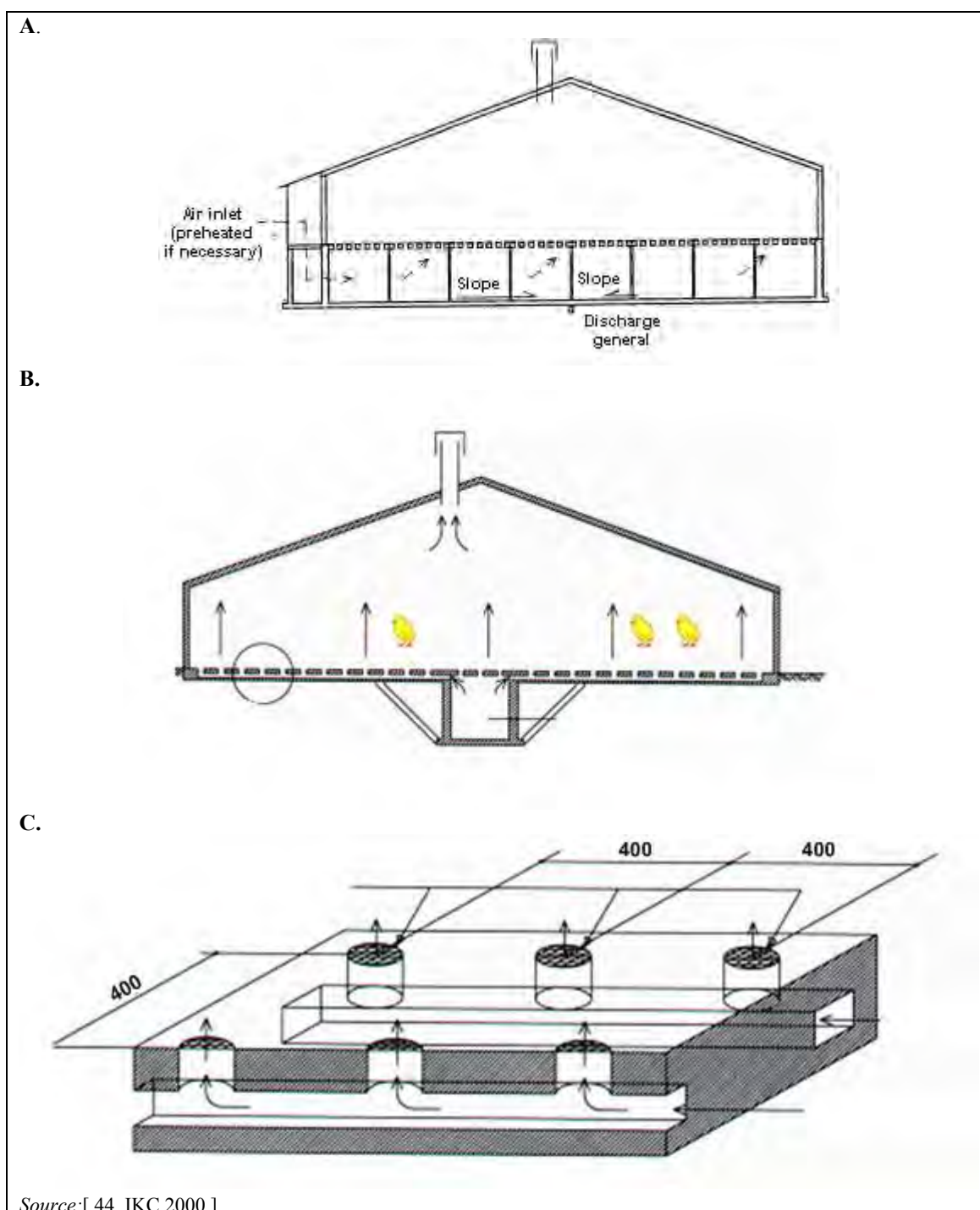

Source:[44, IKC 2000]

Figure 4.20: Schematic representation of a forced drying system with a perforated floor for broilers (A), an improved design (B), and a detail of the floor of the improved design (C)

Achieved environmental benefits

The aeration of the litter and droppings leads to a large reduction in ammonia emissions.

Cross-media effects

High energy input is required because of the forced ventilation, which doubles the power use and costs compared with the reference. The airflow through a very dry litter may result in higher dust emissions.

Environmental performance and operational data

The associated emission level for ammonia is 0.014 kg NH₃ per broiler place per year.

The dry matter content of the manure is as high as 80 %, causing a lot of dust in the broiler house. The birds are cleaner but the farmer needs to protect himself with a face mask. Mucking out and cleaning between growing periods requires more labour compared with other housing systems for broilers.

Technical considerations relevant to applicability

The system can only be used in new buildings, as a sufficient pit depth (2 m) under the perforated floor is necessary and will not normally be available in existing buildings. With an improved design, a shallower depth will be required.

Animal welfare considerations and high levels of dust emissions may preclude the application of this technique, unless it is combined with other measures, such as air cleaning systems. Indeed, the system is no longer applied in Germany, due to the high dust loads in the air and the increased energy demand for aerating the litter.

Economics

With the deep litter system taken as a reference, this housing system requires an extra investment of about EUR 3 per broiler place, which means that it is about 25 % more expensive. This corresponds to an extra investment of EUR 45.5 per kg NH₃ emissions reduced. A further calculation can be made to determine the extra investment costs for the perforated floor, which are equivalent to EUR 65.90 per m² and a stocking density of 20 broilers per m². In this case, the extra operating costs are EUR 0.37 per broiler place per year. Extra costs associated with cleaning out should also be considered. This system implies high energy costs and benefits are limited to a reduction in the NH₃ emissions only [506, TWG ILF BREF 2001].

Driving force for implementation

None reported. An increase in the DM content of the manure may be associated with other advantages, such as a reduction in the required storage space and the volume to be transported.

Example plants

In 2012, about 1 695 000 bird places in the Netherlands (2 % of the national broiler population) were fitted with this technique [468, CBS 2011].

Reference literature

[44, IKC 2000] [468, CBS 2011] [506, TWG ILF BREF 2001]

4.6.4.4 Litter on manure belt and forced air drying (in case of tiered floor systems)

Description

The broilers are kept in a multi-floor system on tiers equipped with manure belts, where a continuous downward or upward draught is applied through the tiered floor arrangement.

Bedding is added on the manure belts before placing the birds in the tiers. Corridors for ventilation are left between the rows of tiers. One corridor is used to bring the air to the tiers; the air is then conveyed towards the other corridor by means of the pressure drop generated by the ventilators. The air is directed towards the bedding material on the manure belt. The litter is removed together with the flock, at the end of the cycle. The manure belts are also used to remove the fattened broilers at the end of the cycle.

The system can be used in combination with a separate initial stage (described in Section 4.6.4.5) where broiler chicks are hatched and grown for a limited time on manure belts with bedding in a multi-tiered system [473, Infomil 2011].

A schematic overview of the tiered floor system, with bedding on manure belts and forced air drying, is shown in Figure 4.21. A cross section of the system, including the airflows, is presented in Figure 4.22.

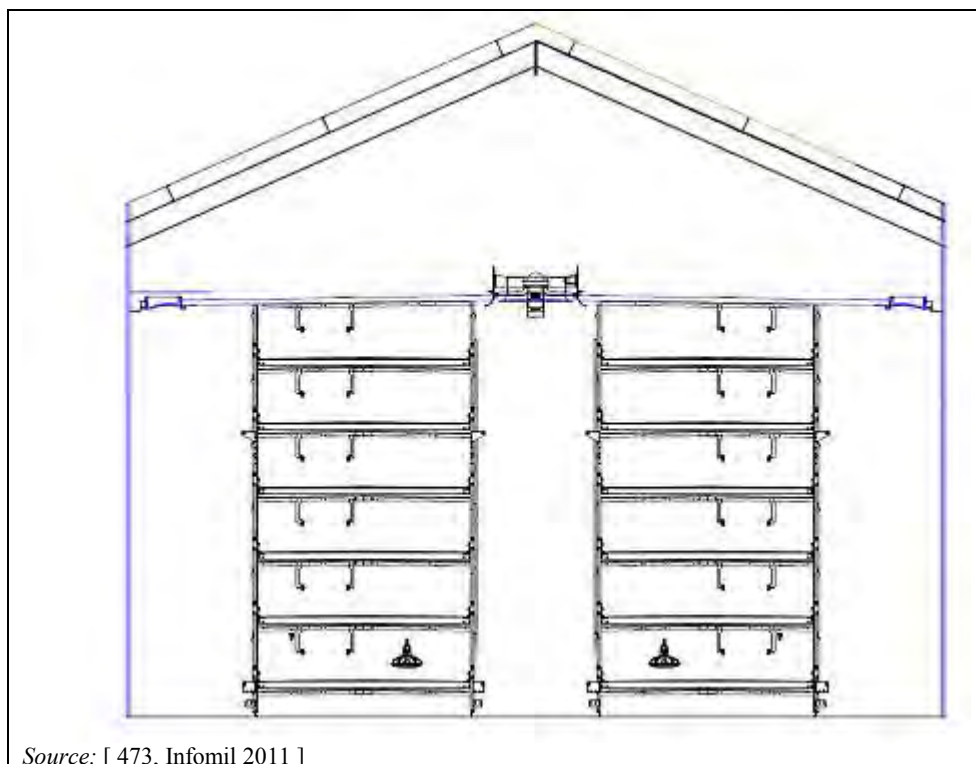

Figure 4.21: Schematic overview of the tiered floor system with two rows and six floors

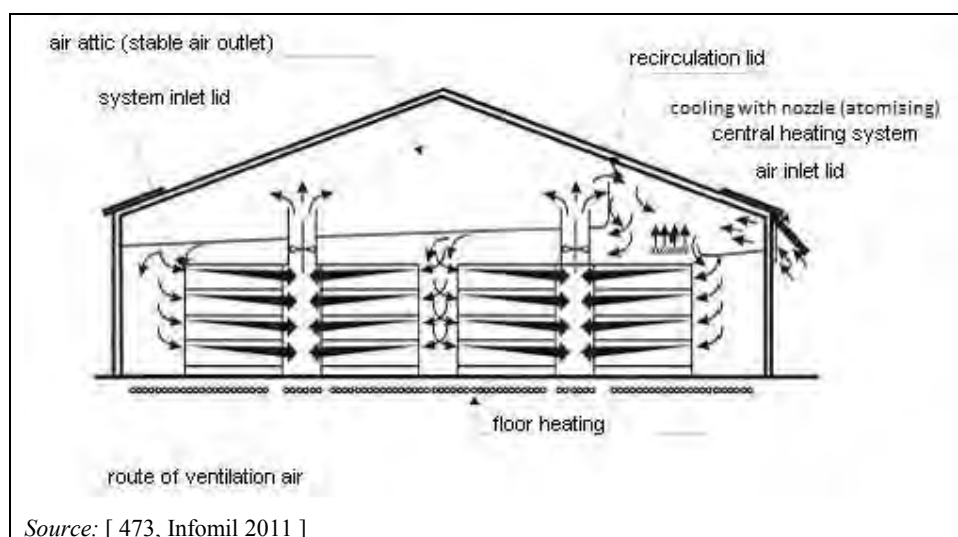

Figure 4.22: Schematic cross section and principle of a tiered floor system with forced drying for broilers

Achieved environmental benefits

Ammonia emissions are reduced as a result of the forced drying of the litter with air.

Cross-media effects

More electricity is needed to operate the ventilation air fans.

With the upward movement of the air and a manure dry matter content of 80 %, dust problems might arise and the use of a face mask is recommended for farmers. Dust is less of a problem with the downward flow design.

Environmental performance and operational data

The amount of bedding material needed is 0.6 kg/m². Ventilation is reported to vary from 0.5 m³/ap/h in the cold season to 2.4 m³/ap/h in the warm season. The space per bird is reported to be equivalent to 0.045 m² (22 birds per m²).

Ammonia emissions are reduced to 0.02 kg NH₃ per broiler place per year, corresponding to a reduction of 75 % compared to the reference system used in the Netherlands, for which an emission of 0.080 kg NH₃ per broiler place per year is considered.

Because of the tiered floor configuration, the number of birds per m³ of house is higher than in traditional Dutch housing systems. The heat distribution is improved by air blowing and the heating costs per bird place are reduced by 50 % [[587, Netherlands 2010](#)].

The system has high demands on the design of ventilation air to ensure fresh air to all the layers and the drying of litter on the belts. Drinkers without leakage are also needed.

Technical considerations relevant to applicability

This system can be applied to new and existing broiler houses. As the system is built up in tiers, existing buildings must have sufficiently high side walls to accommodate the system.

Economics

An extra investment of EUR 2 per broiler place (equivalent to an annualised cost of EUR 0.6/ap/yr) is required compared to a conventional housing system. The technique offers a benefit of EUR 0.6 per bird place per year, due to the reduced energy use, which fully compensates the extra costs.

Driving force for implementation

In summer there is less heat stress on the animals because of the airstream close to them. The system improves the indoor climate in the direct surroundings of the animals. Less labour is needed to keep more broilers.

Example plants

In the Netherlands, two farms with a reported number of 359 000 bird places were equipped with this system in 2008.

Reference literature

[[44, IKC 2000](#)] [[473, Infomil 2011](#)] [[585, Netherlands 2010](#)] [[587, Netherlands 2010](#)]

4.6.4.5 Separate hatching and growing of broiler chicks for a limited time (in case of tiered floor systems)

Description

This housing technique is a combination of two housing systems. The first consists of a multi-tiered system where the incubated eggs are hatched and the chicks are reared for a limited time on bedding on manure belts (patio system). The second system is where the broilers are brought up to their final weight; it may consist of a traditional house or the tiered floor system, as described in Section 4.6.4.4, where bedding is used on the manure belts [[473, Infomil 2011](#)].

Achieved environmental benefits

This system, combined with a second rearing stage for broilers, allows a more effective use of low-emission (but expensive) systems. Therefore, the overall annual ammonia emissions from

the two combined rearing stages are reduced due to the better exploitation of the second housing technique.

Cross-media effects

No specific cross-media effects have been reported. The cross-media effects depend on the combined housing system for the second rearing phase.

Environmental performance and operational data

Eggs are placed in the first system three days before hatching until the chicks are 13 or 19 days of age, when they are moved to the second housing system where they will reach their final weight. The chicks are kept in a multi-floor system on tiers, with bedding on the manure belts, which are also used to transport them out of the house. At the moment of the transfer, the maximum bird density is 71 or 48 birds per m² for 13 or 19 days of age, respectively. The longer the chicks stay in the separate hatching system, the shorter they stay in the second system.

The corridors between the stacks of tiers are used to direct the airflow. The side of the stacks facing the corridor, where the air is coming from, is closed, except for the air inlets; in this way, the flow is directed along the bedding material on the manure belt and then to the other side, where it is collected by ventilators placed on top of the house. The manure belts are emptied and then covered with new bedding each time a new flock is introduced. The collected manure is stored in covered containers and removed from the farm within 2 weeks.

The system optimises the start of young broilers in the first hours after hatching as they have immediate access to water and feed. Additionally, chicks need less heating as they live in a small boxed place. Birds are moved at an age when they are stronger and only over a very short distance, as the next rearing system should normally be on the same farm (in the Netherlands the system is only allowed on this condition). The two housing occupations are synchronised through all production stages, depending on the length of the stages, in order to optimise the occupation and displacements (see Figure 4.23).

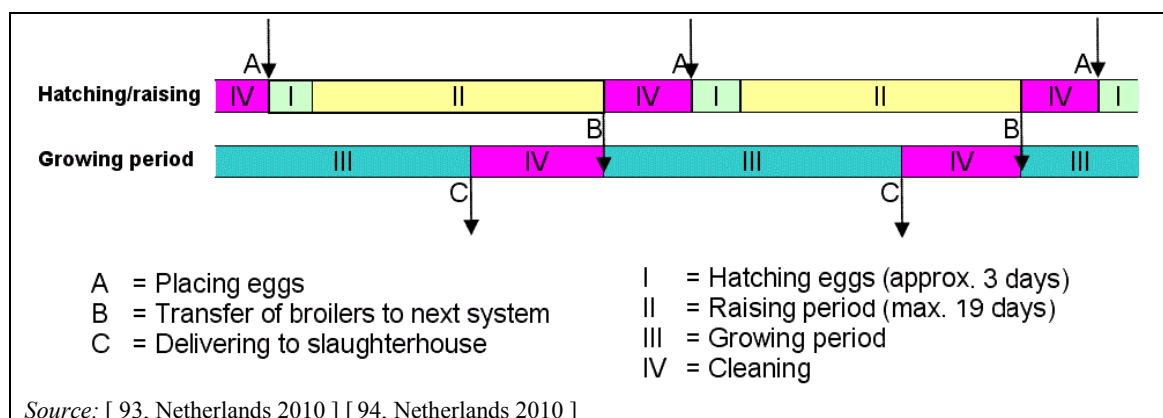

Figure 4.23: Example of a time flow pattern synchronising the patio hatching/raising cycle (19 days) with the finishing cycle in the different houses

Ammonia emissions from the separate hatching and growing system for young broilers are 3 g or 9 g per bird place per year, respectively for the 13 days and 19 days management, including the periods when the system is necessarily empty between cycles. These levels do not include emissions from the second system (second rearing stage). Total ammonia emissions are calculated as the sum of the emissions over the total standard length of rearing (6 weeks) in the two housing systems used in combination, and largely depend on which system is used for the second rearing stage, a low-emitting or standard housing system. This variation is reported in Table 4.64.

Not only is the total space needed at the farm level smaller for the same number of reared birds, but cycles in the house for the second stage are also run in shorter turns. The ratio between the numbers of bird places in the two systems depends on the duration of growing phases, and can vary from 1 : 1 to 1 : 2. The system has a high demand on the design of the ventilation system to ensure even distribution of fresh air to all the layers.

Technical considerations relevant to applicability

This system can be built in new houses but can only be retrofitted in existing houses that have high side walls.

Economics

More birds can be managed by one person. In general, the economic benefit of the farm is optimised by keeping more animals.

Driving force for implementation

The driving force is increased productivity due to the higher number of cycles per year, which is the result of raising young birds while there are also broilers present on the farm at the end of the growing period.

Example plants

Two farms in the Netherlands are equipped with these systems. Permitting authorities request that the housing where birds are moved to reach slaughter weight be equipped with low-emission systems.

Reference literature

[93, Netherlands 2010] [94, Netherlands 2010] [473, Infomil 2011]

4.6.4.6 Heated and cooled littered floor (combideck system)

See Section 4.5.5.3.

4.6.5 Techniques for housing of broiler breeders

The chain for producing broiler meat starts with the fertilised eggs that are produced in the broiler breeder farms. Hatching eggs are delivered to the hatchery plant, which normally return one-day-old chicks to the broiler farms. The two groups of males and females are uniformly bred.

In the reproduction phase, animals need to be reared together but should be fed separately to maintain reproductive efficiency. Separate feeding is done by means of feeding lines at different heights that hence are accessible only to animals of the right sizes.

Traditional systems were previously used to house breeders, like cages and fully littered floors (see Section 2.2.2). New systems allow lower emissions and more effective management, and are derived from cages, deep litter housing and aviaries. According to the provisions of the 'Recommendation concerning domestic fowl (*gallus gallus*)' (Appendix II) adopted by the Council of Europe in 1995, cages should be fitted with perches, a litter area and nest. Old cages not fulfilling these requirements may only be used till they are worn out. Descriptions in this section are simplified, as basic systems are described in Section 4.6.1 and Section 4.6.2 for the rearing of laying hens. A summary of reported achievable emission levels from housing systems applied for the rearing of broiler breeders is presented in Table 4.69.

Table 4.69: Summary of emissions in systems for rearing broiler breeders

Description	NH ₃	PM ₁₀	Odour	Source
	(kg/ap/yr)		(ou _E /ap/s)	
Section 4.6.5.1 Manure removal by belts (in case of cage systems)				
Group cage, manure belt, forced drying	0.080 ⁽¹⁾	NI	NI	[108, BE Flanders 2010]
Section 4.6.5.2 Manure belt or scraper (in case of deep litter with a manure pit)				
Deep litter	0.58	0.043	0.93	[638, BE Flanders 2014]
Deep litter with manure belts	0.245 ⁽⁴⁾ (0.216–0.31) ⁽²⁾	0.049–0.8 ⁽³⁾ ⁽⁵⁾	0.93 ⁽³⁾	[110, Netherlands 2010]
Deep litter with a scraper	0.290 ⁽³⁾	NA	NA	[108, BE Flanders 2010]
Section 4.6.5.3 Forced air drying of manure via tubes (in case of deep litter with a manure pit)				
Forced manure drying by horizontal pipes (in case of deep litter with a slatted floor)	0.25 ⁽⁴⁾ (0.183–0.287) ⁽²⁾	0.049 ⁽³⁾	0.93 ⁽³⁾	[112, Netherlands 2010]
Vertical tubes for forced manure drying (in case of deep litter with a slatted floor)	0.435 ⁽⁴⁾ (0.343–0.528) ⁽²⁾	0.043 ⁽³⁾ ⁽⁵⁾	0.93 ⁽⁴⁾	[109, Netherlands 2010]
Section 4.6.5.4 Forced air drying of manure using perforated floor (in case of deep litter with a manure pit)				
Forced drying using perforated floor (in case of deep litter)	0.23 ⁽⁴⁾ 0.210–0.248 ⁽²⁾	0.043 ⁽³⁾	0.93 ⁽³⁾	[111, Netherlands 2010]
Section 4.6.5.5 Litter-based system with circulating fans				
Deep litter system with circulating fans	0.183 ⁽²⁾ 0.188 ⁽⁴⁾	0.028 ⁽³⁾	0.18 ⁽³⁾	[114, Netherlands 2010]
Section 4.6.5.6 Manure belts (in case of aviary)				
Aviary with manure aeration on belts	0.170 ⁽⁴⁾ 0.13–0.202 ⁽²⁾	0.049 ⁽³⁾	0.93 ⁽³⁾	[108, BE Flanders 2010] [113, Netherlands 2010]
Aviary with manure aeration on belts and on litter	0.130 ⁽¹⁾	NI	NI	[108, BE Flanders 2010]
⁽¹⁾ Modelled values (e.g. results based on N balance). ⁽²⁾ Measured values. ⁽³⁾ Values derived by expert judgement based on conclusions by analogy. ⁽⁴⁾ Derived from measurements. ⁽⁵⁾ Values expressed as total dust. NB: NI = no information provided.				

Disease prevention is a particularly critical aspect for parent stock farms (breeders). Biosecurity requires the application of practices and procedures (e.g. cleaning, disinfection, 'all-in, all-out') aiming to prevent or reduce the entry (to the housing system) and spread of microorganisms that might cause a disease. In the evaluation of individual housing techniques, the possible interaction with biosecurity must be considered.

4.6.5.1 Manure removal by belts, forced manure drying (in case of cage systems)

Description

The birds are housed in cage systems fitted with perches, a litter area and nest. The manure falls through the floor onto the underlying manure belt and is dried with preheated air, and it is removed once a week. An air mixing cabinet may be equipped with a heating unit to preheat the air.

Achieved environmental benefits

Emission of ammonia is reduced through frequent removal and drying of the manure on the belt.

Cross-media effects

See Section 4.6.1.1.

Environmental performance and operational data

The drying system and the manure removal from the belt must be dimensioned to allow for a dry matter content in the manure of at least 50 %. Emissions are estimated at 0.080 kg NH₃ per bird place per year.

Technical considerations relevant to applicability

No technical restrictions are reported for the implementation of the technique.

Economics

No information provided.

Driving force for implementation

No information provided.

Example plants

In Belgium (Flanders), two farms of broiler breeders reported using a cage system [[467, BE Flanders 2010](#)].

Reference literature

[[467, BE Flanders 2010](#)]

4.6.5.2 Manure belt or scraper (in case of deep litter with a manure pit)

Description

The housing consists of a concrete littered floor where the birds can move around freely. Part of the floor is elevated and slatted, under which manure storage takes place. Wet droppings can be removed by a manure belt to a covered outside storage. The frequency of manure removal is at least twice per week. The dry matter content of the manure at the time of removal is at least 30 %.

Alternatively, a scraper that is fitted to a shallow manure pit with a polished and non-adhesive concrete floor can be used for daily removal of the manure under the slatted floor to a closed external storage.

Achieved environmental benefits

Ammonia emissions are reduced by the frequent removal of the droppings, in combination with aeration of the manure on the belts.

Cross-media effects

Increased energy consumption is required for operating the frequent manure removal by belt, with the associated indirect emissions for electric energy production.

Environmental performance and operational data

The maximum bird density is restricted to 7–8 animals per m². The available area is about half slatted and half bedded floor.

The drinking, feeding and resting equipment is situated above the slatted floor. At the start of each production cycle, a layer of litter of at least 3 cm has to be applied. The manure is removed at least twice a week from the belts, and at least once a day where the scraper is installed. In

order to minimise the emissions originating from the droppings in the littered area, the average dry matter content of the bedding should be maintained at least 70 %.

Ammonia emissions equivalent to 0.216–0.310 kg NH₃ per bird place per year have been reported for the system using manure belts [110, Netherlands 2010]. If a scraper is installed, NH₃ emissions of less than 0.290 kg NH₃ per bird place per year have been estimated, based on measurements performed in similar farms for laying hens [108, BE Flanders 2010]. The average reported ammonia emissions from the housing system with frequent removal by manure belts (0.245 kg NH₃/ap/yr) are 58 % lower than the emission levels of the reference system, corresponding to the traditional deep litter system used in the Netherlands (0.580 kg NH₃/ap/yr).

Technical considerations relevant to applicability

The placement of a manure belt or scraper underneath the slatted floor in an existing manure pit is not always possible and involves additional costs, compared with the application of the technique to a new housing system.

Economics

In the Netherlands, in the case of housing systems equipped with manure belts, the investment per bird place is evaluated to be in the range of EUR 14.40–19.80 and the extra cost for new houses is equivalent to EUR 3.5/ap/yr [110, Netherlands 2010].

Driving force for implementation

Frequent manure removal is an effective alternative to more expensive techniques.

Example plants

In the Netherlands, in 2008 around 8 % of broiler breeders were reared in houses with frequent manure removal by belts [110, Netherlands 2010]. The application of the alternative version with a scraper is reported in a new farm in Belgium (Flanders) [467, BE 2010].

Reference literature

[108, BE Flanders 2010] [110, Netherlands 2010] [467, BE Flanders 2010]

4.6.5.3 Forced air drying of manure via tubes (in case of deep litter with a manure pit)

Description

This system consists of a concrete littered floor where the animals can move around freely. Part of the floor is elevated and has a slatted floor under which the manure pit is situated. At least one third of the available area has to be a littered floor. Ammonia emissions are reduced by the aeration of the manure collected in the pit with air from an air mixing cabinet or a heat exchanger. The pipes through which the air is blown are situated underneath the slatted floor and can be placed horizontally or vertically.

In the horizontal version, the pipes are installed under the slatted floor parallel to the laying nests and can be moved vertically according to the manure level in such a way that the vertical distance between the pipes and the manure is always close to 20 cm. Alternatively, the aerating tubes can be installed vertically under the slatted floor (see Figure 4.24). The functional areas for feeding, drinking and resting are arranged above the slatted floor.

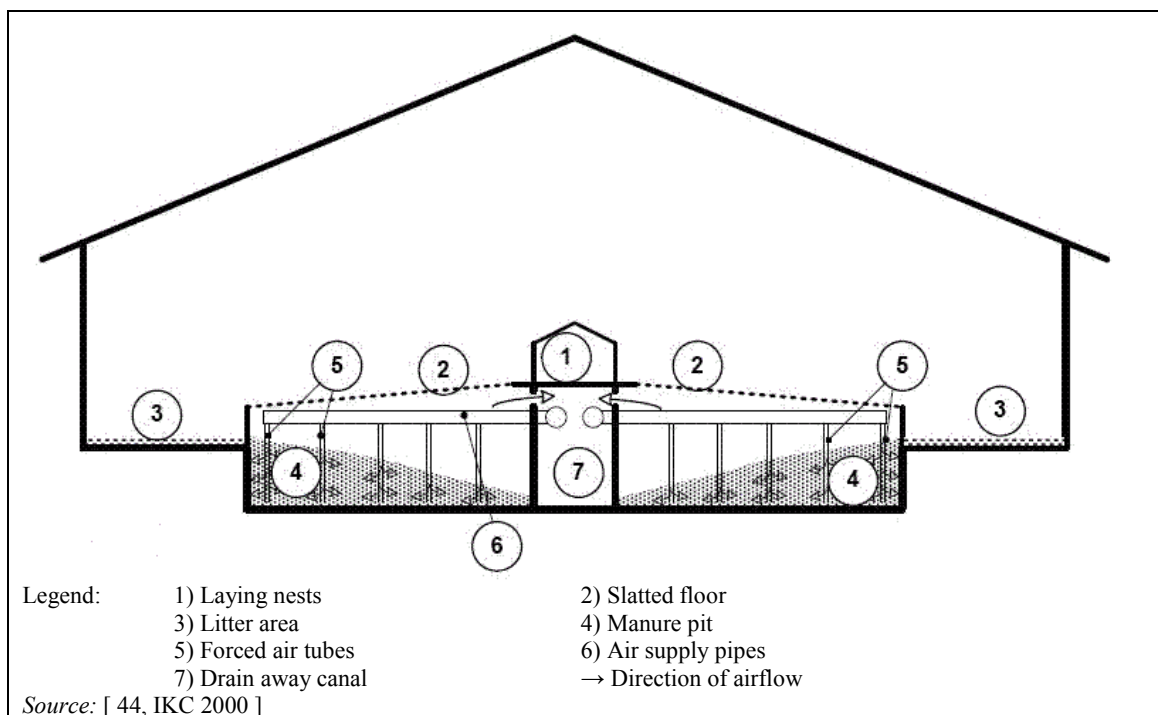

Figure 4.24: Cross section of system with forced air drying by vertical tubes

Achieved environmental benefits

See Section 4.6.2.1.3.

Cross-media effects

The system with the horizontally placed tubes implies additional energy consumption, depending on the air temperature and the amount of forced air used for drying the manure.

Environmental performance and operational data

The maximum animal density is restricted to 7–8 animals per m², including roosters. The volume of air blown over the manure by horizontal pipes is reported to be 2.5 m³ per bird per hour, at a minimum temperature of 24 °C; while 50 % of the inlet air comes from outside the house (fresh air).

The tubes installed vertically are robust. They blow air through small holes at a minimum rate of 1 m³ per hour per animal. At least 50 % of the used air comes from outside and is heated to a minimum temperature of 20 °C.

Ammonia emissions have been reported for the version with horizontal pipes ranging from 0.183 kg/ap/yr to 0.287 kg/ap/yr, and from 0.343 kg/ap/yr to 0.528 kg/ap/yr for the version with vertical pipes. The reported average values for ammonia emissions for the vertical configuration of pipes (0.435 kg NH₃/ap/yr) and for the horizontal configuration (0.25 kg NH₃/ap/yr) are, respectively, 57 % and 25 % lower than the emissions associated with the reference housing system in the Netherlands, consisting of a traditional deep litter system (0.580 kg NH₃/ap/yr).

Technical considerations relevant to applicability

See Section 4.6.2.1.3.

Economics

Cost data concerning deep litter systems with manure pit aeration for both configurations, with horizontal and vertical pipes, are presented in Table 4.70.

Table 4.70: Cost data for deep litter systems equipped with manure pit aeration through pipes

System configuration	Investment costs	Annualised investment costs	Annual operating costs (energy)	Total cost
	EUR/ap			
Horizontal pipes (drying from above)	17 (14.3–19.7)	1.7	4.6	6.65
Vertical pipes	16.6 (14–19.3)	1.67	0.51	2.18
<i>Source:</i> [109, Netherlands 2010] [112, Netherlands 2010]				

Data concerning extra investment and operating costs, in comparison with a reference traditional deep litter system, are also reported from the Netherlands and presented in Table 4.71.

Table 4.71: Extra costs for manure pit aeration through pipes (in case of deep litter systems), in comparison with a reference system

System configuration	Extra investment costs	Annualised extra investment costs	Annual extra operating costs (energy)	Total extra costs
	EUR/ap			
Horizontal pipes (drying from above)	3.40	0.36	4.6	4.96
Vertical pipes	3.05	0.31	0.51	0.82
<i>Source:</i> [589, Netherlands 2010]				

Driving force for implementation

See Section 4.6.2.1.3.

Example plants

In Belgium (Flanders), 10 housing systems are using the technique, including farms above and below the IED capacity threshold [467, BE 2010]. In the Netherlands, 8 % of birds are housed in systems equipped with manure pit aeration, applying the configuration with horizontal pipes.

Reference literature

[44, IKC 2000] [108, BE Flanders 2010] [109, Netherlands 2010] [112, Netherlands 2010] [467, BE Flanders 2010] [589, Netherlands 2010]

4.6.5.4 Forced air drying of manure using perforated floor (in case of deep litter with a manure pit)

Description

See Section 4.6.2.1.4.

Achieved environmental benefits,

See Section 4.6.2.1.4.

Cross-media effects.

See Section 4.6.2.1.4.

Environmental performance and operational data

In Belgium and in the Netherlands, values from 0.210 kg to 0.248 kg NH₃ per animal place per year for ammonia emissions are associated with this system.

Technical considerations relevant to applicability

The system is applicable to new and existing houses for broiler breeders.

Economics

The Netherlands reported investment costs from EUR 12.90 to EUR 17.80 per bird place, with annual operating costs of around EUR 0.25/ap/yr. The annualised investment costs are equivalent to EUR 1.5 /ap/yr and the total annual costs are about EUR 1.75/ap/yr. The extra costs for a new house are estimated to be equivalent to EUR 1.8 /ap/yr.

Driving force for implementation

See Section 4.6.2.1.4.

Example plants

In Belgium (Flanders), one farm for broiler breeders is reported to use this system [467, BE Flanders 2010].

Reference literature

[111, Netherlands 2010] [108, BE Flanders 2010] [467, BE Flanders 2010] [589, Netherlands 2010]

4.6.5.5 Litter-based systems with circulating fans

Description

In a deep litter system without a manure pit and where centralised ventilation is not fitted, vertical shafts equipped with ventilators are hung from the ceiling. At the bottom of the shaft, at a maximum of 1.20 m above the litter, a special element is placed to let the air come out in a horizontal direction. See Sections 4.5.4.2.1.1 and 4.6.4.2.1 for a full description of the technique.

Achieved environmental benefits

The ventilators mix the indoor air and allow for ammonia emission reductions and a better environment for the animals.

Cross-media effects

See Section 4.6.4.2.1.

Environmental performance and operational data

The shafts are placed in two rows along the length of the house at a rate of one ventilator every 150 m². Ventilators have a minimum capacity of 1.8 m³/hour per bird, without any pressure drop. At the beginning of the cycle (one-day-old pullets), the ventilators start at a capacity of 10 % and progressively reach 100 % capacity on day 40.

Associated emissions per animal place are 0.183–0.188 kg/yr of ammonia, 0.028 kg/yr of PM₁₀ and 0.18 ou_E/s/bird.

Technical considerations relevant to applicability

See Section 4.6.4.2.1.

Economics

From the Netherlands, the extra investment costs for the ventilation system are reported to be equivalent to EUR 1 per bird place. The operating costs are reported to be equivalent to EUR 0.135 per bird place per year.

Driving force for implementation

See Section 4.6.4.2.1.

Example plants

See Section 4.6.4.2.1.

Reference literature

[114, Netherlands 2010] [469, Netherlands 2011]

4.6.5.6 Manure belts (in case of aviary)**Description**

The system is basically an aviary system where the animals can move freely throughout the entire house, which consists of different levels (tiers) of slatted floor and littered area on a solid concrete floor (see Section 4.6.2.2.1). Manure removal belts are installed underneath the slatted floor. The manure is collected on these belts and can be dried by (preheated) forced air, conveyed through pipes above or along the belts. Additionally, the manure on the littered floor area can be dried by preheated air (e.g. from heating units), allowing a greater emissions reduction.

An extra level can be built on top of the laying nest (see Figure 4.25), allowing more birds (10–15 %) to be placed in the same house. Functional areas for feeding, drinking and resting are arranged above the dropping area.

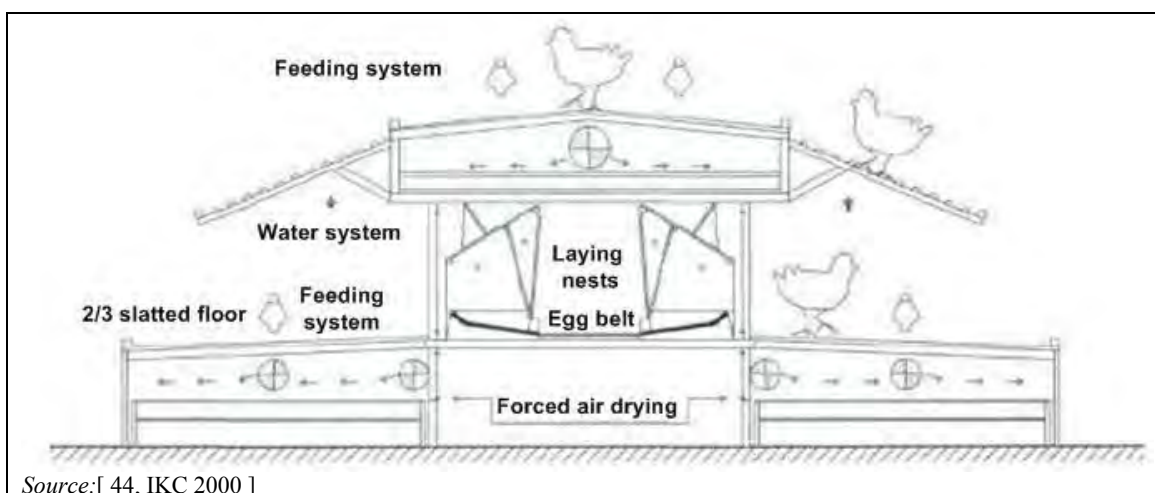

Figure 4.25: Scheme of an additional tier over the nests in an aviary system

Achieved environmental benefits

Ammonia emissions are reduced by the frequent removal and drying of the manure on the belts.

Cross-media effects

The additional tier above the nest gives the possibility for females to hide from the males. This can decrease the fertility and hatchability of the eggs.

Environmental performance and operational data

The manure on the manure belt should be removed from the housing at least once a week and at that time should have a dry matter content of at least 50 %.

Ammonia emissions were measured as 0.170 kg of NH₃ per bird per year (ranging from 0.130 kg to 0.202 kg NH₃/ap/yr), achieved with at least a weekly manure removal and manure drying with preheated air. The reported emissions of ammonia are 71 % lower than those associated with the use of the traditional reference system adopted in the Netherlands (deep litter with emissions equivalent to 0.580 kg NH₃/ap/yr).

Technical considerations relevant to applicability

See Section 4.6.2.2.1.

Economics

The system configuration with the added tier, is associated with investment costs from EUR 15.00/ap to EUR 20.60/ap, annualised investment costs of EUR 1.85/ap/yr, annual operating costs of EUR 0.50/ap and total annual costs of EUR 2.35/ap.

Driving force for implementation

See Section 4.6.2.2.1.

Example plants

See Section 4.6.2.2.1.

Reference literature

[44, IKC 2000] [108, BE Flanders 2010] [113, Netherlands 2010]

4.6.6 Techniques for housing of turkeys

4.6.6.1 Forced ventilation and a non-leaking drinking system (in case of solid floor with deep litter)

Description

Turkeys are reared in a closed, thermally insulated building, with forced ventilation. The solid floor is fully bedded with wood shavings and/or straw. If necessary, additional straw is added during the fattening period. No separate functional areas exist. Solid manure is removed at the end of the cycle when the building is cleaned prior to the next cycle. The cycle consists of rearing all turkeys of both genders for 4 to 6 weeks, which can be prolonged, after separating the stags, with the finishing period of the hens lasting until week 17. After sex separation, stags can be fattened in this system too, but more often they are finished in houses with natural ventilation (see Section 4.6.6.2). The drinking-water system design and operation are such that spillage on litter is prevented. See also Section 2.2.3.2.

Achieved environmental benefits

The absorbent material (e.g. straw) binds urine and faeces in the litter and provides a dry area; therefore emissions of ammonia are reduced. In addition, floor insulation (e.g. concrete, clay) prevents water condensation in the litter.

Cross-media effects

Dust emissions are typically increased in deep litter housing systems.

Environmental performance and operational data

The quantity of bedding added is 9–12 kg/m² in France, considering possible top-up additions during the fattening period. In Germany, the amount of bedding material required for the initial mixed gender rearing period is reported to be 2.2 kg/ap/yr of chopped straw, and for the fattening period 0.8 kg/ap/yr of wood shavings, plus 5.8 kg/ap/yr of chopped straw. From Finland, the typical quantity of wood shavings required is reported to be 2–5 kg/ap/yr.

In the first seven days after arrival, the birds are reared in confinement rings that are progressively made wider. Daily controls are needed for temperature, litter moisture and the height of the feeding and drinking equipment. The ventilation is controlled in order to provide the birds with the required air volumes, as reported in Table 4.72.

Table 4.72: Ventilation parameters in turkey rearing

Period	Young turkeys	Female turkeys	Male turkeys
	m ³ per bird per hour		
Cold season	0.1–1	1–3.6	1–5.5
Warm season	0.6–14.6	6–32	6–48.6
Source: [118, Germany 2010] [500, IRPP TWG 2011]			

Reported emission levels associated with the rearing of turkeys are presented in Table 4.73. Air cleaning systems used for the reduction of ammonia emissions from the rearing of broilers can be applied to turkey housing systems based on deep litter [131, Netherlands 2010]. However, except for scrubbers, the efficacy of the ammonia-reducing techniques will be lower than that achievable with broilers, due to the larger amount of manure and higher dry matter content of the litter. In the Netherlands, the effectiveness of ammonia-reducing techniques applied in turkey housing is considered to be half that achievable in broiler housing [508, TFRN 2014].

Table 4.73: Emissions from turkey rearing systems, with forced or natural ventilation (in case of deep litter)

Rearing phase and parameters	Emission levels			Source
	Ammonia	PM ₁₀	Odour (¹)	
	kg NH ₃ /ap/yr	kg PM ₁₀ /ap/yr	ou _E /s/bird	
Mixed gender starting rearing period (4–6 weeks; weight: 2 kg)	0.15 (²)	0.07 (³) (⁴)	0.007 (²)	[118, Germany 2010]
Mixed gender for the whole rearing period	0.263–0.374 (⁵)	NI	NI	[624, IRPP TWG 2013] [633, ITAVI 2013] [656, Ponchant et al. 2012] [624, IRPP TWG 2013] [633, ITAVI 2013] [656, Ponchant et al. 2012]
Female turkeys, fattening period (16 weeks; weight: 10–11 kg), forced/natural ventilation	0.387 (²)	0.3 (³) (⁴)	0.4 (²)	[118, Germany 2010]
		0.09 (²)		[119, Germany 2010]
Male turkeys, fattening period (20–21 weeks; weight: 21 kg), forced/natural ventilation	0.680 (²) (⁷)	0.8 (³) (⁴)	0.710 (²)	[118, Germany 2010]
		0.24 (²)		[119, Germany 2010]
Starting rearing period plus fattening of male turkeys (20 weeks; weight: 0.05–18 kg), forced/natural ventilation	0.138 (³)	0.9 (⁶)	NI	[500, IRPP TWG 2011] (UK)
Starting rearing period plus fattening of male turkeys (20 weeks; weight: 0.05–18 kg), forced/natural ventilation	0.66 (³) (⁸)	NI	NI	[102, UK 2010] [614, UK 2013]
<p>(¹) Values have been calculated from an emission of 32 ou_E/s per LU and an average weight of 1.1 kg for the starting rearing period for turkeys, 6.25 kg for female fattening, and 11.1 kg for male fattening.</p> <p>(²) Derived from measurements.</p> <p>(³) Measured values.</p> <p>(⁴) Values expressed as total dust.</p> <p>(⁵) Modelled values (e.g. results based on N balance).</p> <p>(⁶) Values derived by expert judgement based on conclusions by analogy.</p> <p>(⁷) An emission level of 0.68 kg NH₃/ap/yr is considered as the reference.</p> <p>(⁸) Derived from an emission of 93 g N/LU/d, and an average weight of 8 kg for male turkeys.</p> <p>NB: NI = no information provided.</p>				

Technical considerations relevant to applicability

The technique is applicable to both new and existing houses. It is used for the rearing of young turkeys and, afterwards, for the fattening of female turkeys; optionally, the technique may also be applied for the fattening of male turkeys.

Economics

Figures that have been modelled in Germany indicate required investments of between EUR 53 and EUR 84 per bird place, corresponding to annualised costs of between EUR 1.70 and EUR 7.30 per bird place per year. Annual operating costs are reported to be EUR 4.70 per bird place per year. The labour demand is reported to be 0.1–0.13 h/ap/yr, and the energy consumption for heating 0.12 kWh/ap/yr and for lighting 0.5 kWh/ap/yr.

Driving force for implementation

An increased productivity with structural flexibility combined with good indoor climate is achieved at low investment and operating costs, since energy requirements are low.

Example plants

The system consisting of the starting rearing phase and the fattening period of hens is normally used in Germany, in rotation with the system for rearing stags described in Section 4.6.6.2.

Reference literature

[102, UK 2010] [118, Germany 2010] [119, Germany 2010] [131, Netherlands 2010] [500, IRPP TWG 2011] [508, TFRN 2014] [614, UK 2013] [624, IRPP TWG 2013] [633, ITAVI 2013] [656, Ponchant et al. 2012]

4.6.6.2 Natural ventilation with a non-leaking drinking system (in case of solid floor with deep litter)

Description

After sex separation, stags are usually reared in houses with natural ventilation (with open side walls) until the end of the fattening period. The slaughter weight for stags is about 18–21 kg, achieved at an age of 20–21 weeks. A backup ventilation system can be made available by installing extraction fans on one side of the shed. In the UK, the birds can often access open free ranges. Solid manure is removed at the end of each growing period when the building is cleaned prior to the next cycle. This type of housing system can optionally be used for fattening hens (from 2 kg to 10–11 kg) or for the whole rearing cycle (from 0.05 kg to 18 kg). A scheme of the deep litter housing system for turkeys, with natural ventilation, is shown in Figure 4.26. The solid floor is fully covered with litter which can be added to depending upon necessity. The drinking-water system design and operation are such that spillage on litter is prevented. Naturally ventilated houses are reported to have a damp-proofing control applied to the floor to prevent moisture from passing into the interior [103, UK 2010].

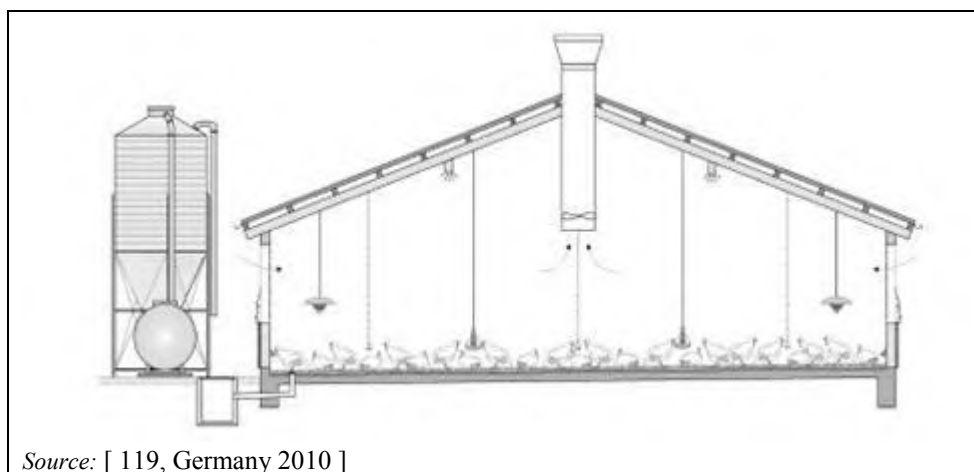

Figure 4.26: Scheme of a naturally ventilated house for turkey fattening

Achieved environmental benefits

Naturally ventilated houses demand lower energy consumption. A reduction of emissions is considered possible, due to the lower indoor average temperatures associated with the open climate design of the housing system.

Environmental performance and operational data

The bedding needs frequent top-ups which can be applied daily. Reported emissions from naturally ventilated turkey houses, with or without free ranges, do not show a difference from forced ventilated houses. Emission levels for both naturally ventilated and forced ventilated housing systems are presented in Table 4.73.

Technical considerations relevant to applicability

No technical restrictions are reported for the implementation of the technique. Considerations for natural ventilation are in Section 4.5.6.

Economics

The same cost figures as for the system in Section 4.6.6.2 have been reported. In addition, the annual operating cost, calculated for a house of 8 750 bird places in Germany, is reported to be equivalent to EUR 4.7/ap/yr.

Driving force for implementation

Open climate houses provide a better indoor climate, due to lower average indoor temperatures. Systems with a veranda and/or a yard offering access to external climate/stimuli are more animal-friendly.

Example plants

It is the most widespread system for stags in Germany.

Reference literature

[103, UK 2010] [119, Germany 2010]

4.6.7 Techniques for housing of ducks

4.6.7.1 Frequent litter addition (in case of solid floor with deep litter)

Description

Ducks are reared on solid floors with bedding, but without separate functional areas. Two different rearing systems may be used: 'all-in, all-out' or two separate growing periods. In the 'all-in, all-out' system, the complete rearing of the birds is carried out, and both the birds and the litter are removed at the end of the cycle. With the two separate growing periods system (starting and finishing rearing periods), the birds are moved to another house after the first period. In the starting rearing period, the space per animal is reported to vary between 0.067 m² and 0.072 m². In the 'all-in, all-out' system and in the fattening period for the two separate growing stages, the space per animal is reported to vary between 0.143 m² and 0.21 m². Litter is maintained dry by frequent addition (e.g. daily) of fresh material upon necessity.

Houses can be forced or naturally ventilated and manure is always removed at the end of the cycle. Houses that are used for the starting rearing period and for the 'all-in, all-out' system are of a closed type, well insulated, and equipped with forced ventilation and automatic feeding and drinking systems. If the finishing period is run separately, it may take place in a simpler open climate house, with natural ventilation. This housing system can be combined with a free-range system.

Achieved environmental benefits

Emissions are reduced as a result of the daily topping up with bedding material and the consequent increased absorption of humidity.

Cross-media effects

The management of litter in the surroundings of the water source provided for bathing can be difficult.

Environmental performance and operational data

The amount of bedding material used for the fully littered floor is reported from Germany to be equivalent to 7 kg/ap/yr for the starting rearing period, and 28 kg/ap/yr for the finishing period. From the Netherlands, the amount of bedding material is reported to be 1 kg of wheat straw per m², and from the UK 4 kg/bird, corresponding to around 23 kg/per bird place per year for 4.7 cycles/yr.

The reported ventilation rates in forced ventilated, fully littered housing systems for Pekin ducks are summarised in Table 4.74.

Table 4.74: Ventilation rate range for forced ventilated Pekin duck rearing houses

Rearing phase	Warm period	Cold period
	m ³ /bird place/h	m ³ /bird place/h
From 0.05 kg to 1.2–1.5 kg (1 to 21 days)	0.3–8	0.1–0.8
From 1.2–1.5 kg to 3 kg (21 to 47 days)	3.3–11.3	0.6–1.3

Source: [115, Netherlands 2010] [116, Germany 2010] [117, Germany 2010] [500, IRPP TWG 2011]

In general, the drier the litter, the lower the level of ammonia emitted [152, Link CR 2006]. Emissions have been measured in Germany for the two rearing periods and were found to be 0.05 kg of ammonia and 0.01 kg of total dust per animal place per year for the starting period and 0.15 kg of ammonia and 0.04 kg of total dust per animal place per year for the finishing period. Emission figures for the complete cycle reported from the Netherlands and the UK (estimated) are in the range of 0.11 kg to 0.227 kg for ammonia and 0.078 kg for methane.

Emission data for different deep litter housing systems used in the rearing of ducks are presented in Table 4.75.

Table 4.75: Reported emission data from deep litter systems for the rearing of ducks

Production system and rearing phase	NH ₃	Odour	PM ₁₀	Source
	kg/ap/yr	ou _E /s/bird	kg/ap/yr	
Deep litter with forced ventilation Pekin ducks, rearing (from 0.05 kg to 1.2–1.5 kg in 1 to 21 days)	0.05 ⁽¹⁾	0.098 ⁽¹⁾ ⁽²⁾	0.01 ⁽³⁾ ⁽⁴⁾	[117, Germany 2010]
Deep litter with forced ventilation Pekin ducks, fattening (from 1.2–1.5 kg to 3 kg in 21 to 47 days)	0.1457 ⁽¹⁾	0.29 ⁽¹⁾ ⁽²⁾	0.04 ⁽⁴⁾ ⁽³⁾	[116, Germany 2010] [474, VDI 2011]
Deep litter with forced ventilation Pekin ducks, fattening (up to 3.3 kg)	0.12	NI	NI	[646, COM 2013]
Deep litter with forced ventilation All-in, all-out (from 0.05 kg to 3.35 kg in 49 days)	0.21 (0.199–0.227) ⁽⁴⁾	0.49 ⁽⁵⁾	0.084 ⁽⁶⁾	[115, Netherlands 2010] ↓
Deep litter with forced ventilation All-in, all-out (from 0.04 kg to 3.3 kg in 49 days)	0.11 ⁽⁶⁾	NI	NI	[106, UK 2010]
Deep litter with forced ventilation (from 20 to 41 days)	0.17 ⁽⁴⁾ ⁽⁵⁾	NI	0.026 ⁽⁴⁾ ⁽³⁾ ⁽¹⁾	[152, Link CR 2006]
Deep litter with natural ventilation All-in, all-out (from 0.05 kg to 3.6 kg in 47 days)	0.11 ⁽⁶⁾	NI	NI	[104, UK 2010]
⁽¹⁾ Value is derived from an average of 0.11 g dust/kg of live weight/day, an average weight of 1.9 kg for duck fattening and 6 cycles per year. ⁽²⁾ Values have been calculated from an emission of 75 ou _E /s per LU and an average live weight of 0.65 kg for duck rearing and 1.9 kg for duck fattening [474, VDI 2011]. ⁽³⁾ Values refer to total dust. ⁽⁴⁾ Measured values. ⁽⁵⁾ Value is derived from an average of 0.713 g NH ₃ /kg of live weight/day, an average weight of 1.9 kg for duck fattening and 6 cycles per year. ⁽⁶⁾ Modelled values (e.g. results based on N balance). NB: NI = no information provided.				

Air cleaning systems used for the reduction of ammonia emissions from the rearing of broilers can be applied to duck housing systems with deep litter. However, except for scrubbers, the efficacy of the techniques will be lower than that achievable with broilers, due to the larger amount of manure and higher dry matter content of the litter. In the Netherlands, the effectiveness of air cleaning techniques applied in duck housing is considered to be half that achievable in broiler housing. For ducks provided with water bowls, the efficacy may be even lower [508, TFRN 2014]. Frequent fresh straw addition ensures a low concentration of ammonia in indoor air (4–8 ppm) [646, COM 2013].

Technical considerations relevant to applicability

No technical restrictions are reported for the implementation of the technique.

Economics

Comparable cost data are reported from Germany and the Netherlands, showing an investment of EUR 34–35 per bird place, for the 'all-in, all-out' housing systems and for the finishing period of the two-phase rearing system. The investment cost for the starting period of the two-phase system is reported from Germany to be equivalent to EUR 14 per bird place. In the UK, in forced ventilated housing systems, one operator is expected to attend to 24 000 birds in a 40-hour working week. In Germany, the labour demand is reported as 0.25 h/ap/yr.

Driving force for implementation

The version with deep litter with natural ventilation allows a better indoor climate, lower energy demand, and lower investment and operating costs than the closed version with forced ventilation. A housing technique without an outdoor run minimises leaching of nitrogen and phosphorus [[115, Netherlands 2010](#)].

Example plants

The technique is widely applied (e.g. in Poland and the UK) [[264, Loyon et al. 2010](#)]. It is the most widespread system used in Germany for the production of ducks.

Reference literature

[[104, UK 2010](#)] [[106, UK 2010](#)] [[115, Netherlands 2010](#)] [[116, Germany 2010](#)] [[117, Germany 2010](#)] [[152, Link CR 2006](#)] [[264, Loyon et al. 2010](#)] [[474, VDI 2011](#)] [[500, IRPP TWG 2011](#)] [[508, TFRN 2014](#)] [[646, COM 2013](#)]

4.6.7.2 Frequent litter addition (in case of deep litter combined with slatted floor)

Description

Ducks are reared on solid floors where litter is maintained dry by frequent addition (e.g. daily) of fresh material upon necessity. At 14 days old, young ducks have access to a slatted area where drinkers are placed, which cover around 25 % of the surface. Manure is completely removed at the end of the 'all-in, all-out' cycle.

The building is heated for the first 2 weeks of rearing. The ventilation system can be either natural or forced with side inlet and ridge extraction. The system can be combined with a free range with a hard-surfaced area, with dirty water collection.

Achieved environmental benefits

Keeping the litter dry by adding new bedding material daily reduces NH₃ emissions. The incorporation of slatted areas in the housing system, for accommodating the drinkers for the birds, allows the minimisation of moisture levels in the litter, whilst meeting all welfare regulations concerning drinker provision for the ducks [[152, Link CR 2006](#)].

Cross-media effects

More water is necessary for cleaning the houses at the end of the cycle, compared to fully slatted floor housing systems.

Environmental performance and operational data

All the environmental conditions are adjusted automatically or manually, depending on the age of the birds. In the UK, in 1 year, six to seven batches of birds are reared.

As reported from the UK, an example farm of 120 000 birds would require annually 2 160 tonnes of bedding material, around 152 000 kWh of electrical power, 75 tonnes of fuel and more than 10 000 m³ of water. Emissions are estimated at 0.11 kg of ammonia and 0.078 kg of methane per bird place per year.

Technical considerations relevant to applicability

For existing plants, applicability depends on the design of the existing structure.

Economics

The reported annual operating costs for a farm (without a free range) rearing annually 120 000 birds in six batches of 45 days (from 0.05 kg to 3.6 kg) are around EUR 700 000 for the production of 1 728 tonnes of meat.

Driving force for implementation

Improved animal welfare and lower costs [624, IRPP TWG 2013].

Example plants

The technique is used in farms in the UK and in the Czech Republic [264, Loyon et al. 2010].

Reference literature

[105, UK 2010] [107, UK 2010] [152, Link CR 2006] [264, Loyon et al. 2010] [624, IRPP TWG 2013]

4.6.7.3 Frequent manure removal (in case of fully slatted floor)**Description**

Slats cover the pit from where the slurry is collected and transferred to an external store with variable frequency. More frequent manure removal than at the end of the cycle is carried out by:

- permanent gravity flow to an external store;
- scraping with variable frequencies to an external store.

The housing system can be equipped with natural or forced ventilation and combined with a free-range system.

Achieved environmental benefits

The highest ammonia and odour emissions develop from deep stores and a long residence time of the slurry in the pit. The gravity flow with a sloped board or the removal by a scraper reduce the time the slurry is exposed to air due to the removal being more frequent than only at the end of the cycle. The emission reduction effect is greater in winter than in summer, but odour emissions are prevented in the warm season.

Cross-media effects

More water for cleaning is needed compared to litter-based housing. This technique was evaluated for its carbon footprint over the whole system in a comparative study against litter-based systems. It was shown that, despite higher greenhouse gas emissions due to the manure management, the fully slatted floor housing performs the same or better than systems based on straw-bedded housing, especially where straw is supplied from further away [475, Merlet et al. 2010].

For this floor type, it is likely to prove difficult to meet the requirements of including a sufficient area covered with an appropriate bedding material to enable all birds to rest simultaneously and of providing adequate litter, as far as possible, in a dry, friable state, according to the provisions of Article 10 (6) and Article 11(4) of the 'Recommendation concerning Muscovy ducks (*cairina moschata*) and hybrids of Muscovy and domestic ducks (*anas platyrhynchos*)' of the Council of Europe. In some countries (e.g. Sweden), fully slatted floors are not allowed due to animal welfare considerations.

Environmental performance and operational data

Manure removal by scraping is very common with this housing system. Scrapers are very reliable; the frequency of scraping must be adapted according to the age of animals, the season

(temperatures and ambient humidity) and the state and volume of droppings. Overly dry droppings and excessively low volumes degrade the state of the scrapers and ground, whereas excessively high volumes might harm the functioning of the scrapers.

Technical considerations relevant to applicability

The applicability is limited to the rearing of Barbary/Muscovy ducks (*cairina moschata*), due to sanitary reasons.

Economics

The indicative cost for the purchase of a scraper (electrical connections and labour demand included) is around EUR 8.3/m², excluding taxes. In the UK, the cost for the purchase of a scraper is around EUR 35–40 per bird place for a housing system equipped with natural ventilation, and EUR 40–45 per bird place with forced ventilation.

Driving force for implementation

In France, the majority of farms for the production of ducks use fully slatted floors with scrapers. The system is considered the best way to rear Barbary ducks as the highly diluted manure is considered to cause excessive degradation of the litter, especially in winter, meaning that eventually birds are subjected to sanitary problems [365, France 2010]. Local shortages of straw, due to competition from other livestock (frequent for the major French basin of production, the Loire Region and Brittany), make this technique a favourable alternative to deep litter housing.

Example plants

This system is the reference in France for the rearing of Barbary ducks (*cairina moschata*). It is also used in Poland and Belgium (Wallonia) [264, Loyon et al. 2010].

Reference literature

[264, Loyon et al. 2010] [365, France 2010] [368, France 2010] [475, Merlet et al. 2010]

4.7 Techniques for the reduction of emissions from pig houses

This section reflects the information submitted on techniques that aim to reduce emissions from pig housing facilities. The information available mainly focuses on NH₃ emissions to air whilst dust, odour and greenhouse gas emissions are also taken into consideration.

To enable easy comparison, techniques are described per pig category (mating and gestating sows, farrowing sows, weaners, fattening pigs). However, due to the fact that in some housing techniques the basic characteristics and operating principles are common for the various categories of pigs and in order to avoid repetition, Section 4.7.1 provides general information for the techniques that are similarly applied across several pig categories.

For comparing the performance and the cost data of reduction techniques, it is considered practical to select a reference technique for each pig category. This approach selects the technique associated with the highest ammonia emission levels and allows other techniques to be assessed for their relative environmental performance (reduction percentage); relative values give an indication of the achievable level.

The first technique that is described for each pig category is the fully slatted floor with a deep pit, which is generally considered the worst performing system in terms of ammonia emissions, and is commonly taken as the reference to calculate the emissions reduction achieved by other techniques [[508, TFRN 2014](#)]. In a similar way, economic data for the implementation of ammonia mitigation techniques are often given as 'extra costs' that would be required compared to fully slatted floors with a deep pit.

As regards costs, it has to be indicated that the renovations of existing houses and the associated investment costs are highly dependent on the size of the pens, the existing manure pit, the discharge points, the existence of a manure pit near load-bearing walls, etc. [[273, BE Flanders 2010](#)].

Note that not all submitted emission data are measured. Some have been calculated or derived from available information by expert judgment, in which case this has been indicated. The relationship between housing systems and animal welfare is also considered, since some techniques may entail potential disadvantages.

In pig housing, although techniques may be managed separately, they produce an integrated environmental impact in the house system. It is also important to note that all integrated measures to reduce emissions of NH₃ from pig housing will lead to a higher amount of nitrogen in the manure and to the amount that may potentially be emitted to air as ammonia during storage and landspreading.

Techniques for reducing emissions from pig housing can be separated into the following general categories:

1. Nutritional measures to reduce the amount of manure and its nitrogen content.

Nutritional measures, as described in Section 4.3, for preventing emissions from housing by reducing the concentration of nitrogen in manure and slurry, produce a reduction of emissions at all stages of the production chain.

2. Control of the indoor housing climate.

Emissions of pollutant gases increase at higher ambient temperatures and ventilation rates. However, it is important to notice that temperature and ventilation rate are interlinked as a high airflow lowers the air temperature. Designing the ventilation system properly and controlling the indoor ventilation rate, as well as the airflow patterns, in order to lower the indoor

temperatures and to reduce the airflow velocity over the slurry surface and above the housing floor, can moderate emissions from housing. Nevertheless, the minimum ventilation rate and temperature required for animal welfare and health reasons must be ensured, e.g. if too low a ventilation rate is applied, the indoor environment may become highly concentrated in ammonia, even though the overall emissions will be reduced.

The flow pattern of the air in the housing can be favourably influenced by the position and dimension of the supply and exhaust air apertures (e.g. side wall or gable extraction, or linear extraction through exhaust air ducting). If air inlets and outlets are located near the manure surface, emissions are increased due to the higher air exchange rate at the interface. Incoming air conduction through perforated ducts and porous ceilings results in low air velocities in the livestock area. Air inlet temperatures and volume flows can be reduced by, for example, locating the fresh air intake in shady zones, or ducting the air via the feeding passage or through a heat exchanger. In Germany, a reduction potential of 10 % for NH₃ emissions is reported with fresh air cooling achieved with a geothermal heat exchanger when the outdoor temperature is more than 25 °C [474, VDI 2011].

Moreover, the indoor climatic conditions may alter the pig behaviour with indirect effects on emissions. The control of ambient parameters, especially under hot conditions, has to ensure that the pigs foul the excretory area while the lying and exercise areas remain clean and dry. Keeping indoor temperatures low enough to avoid defecation in the solid part may prove difficult during the warmer seasons [261, France 2010].

These factors must be controlled to meet the pigs' needs and often require a certain energy input. The evaluation and quantification of emission reductions through the application of these techniques is complex.

3. Optimisation of pig housing design (floor type, pen design and manure management).

In pig production, housing systems are based on slatted or bedded floors. Within both floor types, a large range of techniques have been developed in order to reduce the environmental impact of pig production. Pig houses are carefully designed, paying attention to the combination of the floor system, arrangement of the functional areas in the pen, manure collection and the manure removal system, but also considering the variables influencing the indoor environment. The housing systems described involve some or all of the following principles:

- reducing emitting manure surfaces;
- increasing the frequency of slurry (or solid manure) removal from the pit or channel (or solid floor) to an external store;
- cooling the slurry;
- changing the chemical/physical properties of the manure, such as decreasing the pH;
- using surfaces which are smooth and easy to clean;
- controlling the characteristics of the indoor air: flow volumes, speed, temperature and inlet/outlet surfaces;
- steering excretory behaviour to minimise the fouled areas;
- absorbing excretions into bedding material and properly managing the litter (keeping it dry and clean).

A few general remarks are made below:

Slatted floor systems

i. Good drainage of manure through the slatted floor limits fouled areas which are significant sources of NH₃. In general, material characteristics (e.g. concrete roughness and porosity), slat

profile design (i.e. a trapezoidal cross section favours manure drainage, transverse slats are considered to perform better, round or semi-circular openings have a greater risk of clogging than traditional rectangular openings) and the width of openings (i.e. increasing the size of openings facilitates drainage) influence the drainage properties of the floor. In the same way, the application of a smoother material (cast iron- or plastic-coated instead of concrete) to slats with the same width, allowing manure to fall faster into the pit below without sticking, reduces ammonia emissions. Concrete slatted floors perform better with respect to the risk of slipping in comparison to slatted floors of plastic or metal but they are colder for the pigs to lie on and have less ability to absorb shocks [486, Pelletier et al. 2005] [487, Aarnink et al. 1997] [488, Pedersen et al. 2008] [590, Batfarm 2013].

ii. Reducing the surface area of the slatted floor reduces the emitting slurry surface and, consequently, reduces NH₃ emissions. Thus, partly slatted floor systems with a reduced slurry pit area are known to produce lower levels of NH₃ compared to fully slatted floor systems, as confirmed by numerous studies [590, Batfarm 2013]. Partly slatted floors covering 50 % of the floor area generally emit 15–20 % less NH₃, particularly if the slats are metal- or plastic-coated which is less sticky for manure than concrete and the risk of emissions from the solid part of the floor is avoided. Further reduction of the emitting area can be achieved by making both the partly slatted area and the pit underneath smaller. With the smaller slatted area, the risk of greater fouling of the solid area can be mitigated by installing a small second slatted area with a water canal underneath at the other side of the pen where the pigs tend to eat and drink [508, TFRN 2014].

In such systems, the pen is divided into solid lying areas and slatted dunging areas. However, pigs do not always use these areas in the desired way, using the solid area to dung and the slatted area to cool off in warm weather. Generally, pens should be designed to accommodate the desired excretory behaviour of pigs to minimise the fouling of solid floors. This is more difficult in regions with a warm climate [508, TFRN 2014].

It is important to choose the optimum ratio between slatted and non-slatted surface areas. Increasing the non-slatted area will result in more manure remaining on the solid part and possibly a rise in ammonia emissions. Whether this happens or not depends largely on the amount of urine and the speed with which it can run off, as well as with the distance to the pit. A convex inclined smooth floor will enhance urine removal, but animal safety needs to be taken into account.

On the other hand, some studies report similar emissions whatever the proportion of slatted floor or higher emissions with the partly slatted floor. Actually, there are cases when the excretory behaviour of the pigs, which tend to foul the solid area under specific conditions such as hot temperatures or a high animal density, does not allow a reduction in emissions with a partly slatted floor compared to fully slatted floor systems [590, Batfarm 2013]. For example in France, NH₃ emissions may increase by around 30 %, in comparison to fully slatted floor systems, when fattening pigs tend to excrete on the solid floor at around 24 °C. If lower indoor temperature conditions (i.e. 18 °C) are applied with partly slatted floors, compared to a higher temperature with fully slatted floors (i.e. 24 °C), emissions of ammonia and greenhouse gases are similar, but a deterioration of feed intake, growth rate, carcass backfat thickness and feed conversion ratio (FCR) is observed for the lower temperature applied. In addition, animal welfare and health may be affected by increased dirtiness. There may also be additional economic implications when dirty pigs are not accepted by slaughter companies. [261, France 2010] [493, Guingand et al. 2010]. Furthermore, pen fouling increases towards the end of the fattening period due to lack of space and the increased heat generated by the pigs themselves as they grow bigger, which will also increase emissions, due to an increased surface area emitting ammonia [439, Sommer et al. 2006].

In practical terms, the implementation of partly slatted floors implies a greater surface area needed per animal, leading to a reduction of the farm capacity compared to the fully slatted floor.

The installation of a sprinkler to cool the animals, or sufficient available space, could prevent an increase of emissions. Moreover, the proper design of housing conditions respecting the natural excretory/lying behaviour of the pig may contribute to limiting emissions, by preventing fouling of the solid areas. This includes, for example, the appropriate location of the feeding and watering facilities as most of the pigs urinate and defecate in the free corner of the pen, away from the feeder or drinker, indicating where the slats have to be placed. The pen partition type also impacts on the dunging behaviour. Closed pen partitions reduce air drafts, keep the sleeping area warmer and maintain a temperature gradient between the warmer lying area and the cooler dunging area [590, Batfarm 2013].

A reduction of the emitting manure surface can also be achieved by modification of the pit design, principally as a result of sloped pit walls or manure gutters. Limited information is available from scientific literature concerning the effect on ammonia and odour emissions of the pit depth underneath fully slatted floors. In general, a shallow pit will have the same surface area of slurry as a deeper pit and therefore the same potential with regards to ammonia emission [605, E.Magowan, AFBI 2010]. On the other hand, higher emissions occur for a deep pit where manure may be stored for the whole year and lower emissions for shallow pits (60 cm) and regular removal of manure (every few weeks) [500, IRPP TWG 2011].

An increase of the distance between slats and slurry, or an increase of the ventilation rate, will have an effect on the average air speed and the airflow pattern over the exposed slurry surface. Reducing the headspace (height) in the manure pit increases the air exchange, with an expected increase in ammonia emissions. However, a good correlation between ammonia emissions and headspace in the manure pit is not established and the effect of the distance from the slats to the surface of the slurry on ammonia emissions may be considered modest, especially if the slurry pit walls are vertical [439, Sommer et al. 2006]. In underfloor extraction, higher emissions occur if the distance between the slurry surface and the bottom edge of the slatted floor is less than 50 cm [43, COM 2003]. However, no such effect is verified in the Netherlands [500, IRPP TWG 2011]. In the case of underfloor air extraction, ammonia emissions depend not only on the distance between the slurry surface and the bottom edge of the slatted floors, but also on the design of the underfloor extraction system [606, Z.Ye et al. 2011] [605, E.Magowan, AFBI 2010].

iii. Frequent manure removal is considered an effective technique for reducing ammonia emissions (e.g. by scrapers, belts, flushing or vacuum). Total emissions including emissions from storage will be reduced provided that the outside temperature is lower than the inside one. From a practical point of view, the frequency of manure removal is the principle that can be most easily implemented by existing houses, provided there is enough outdoor storage capacity. Nevertheless, systems that produce turbulence in the slurry flow generate peaks of odours each time slurry pits are emptied, which is more important for farms close to sensitive receptors than for isolated farms [261, France 2010]. The physical structure of the manure and the smoothness of the pit floor surface may affect the reducing effect on the ammonia emissions that the removal through scraping usually provides.

Bedded systems

The use of litter in pig housing has been increased in many Member States as it is related to improved welfare and to the need for a better brand image of livestock production. However, in some countries, particularly in Denmark, the number of littered systems is reported to have declined dramatically, due to cross-media effects and economic considerations [500, IRPP TWG 2011].

Litter can be applied in conjunction with (automatically) controlled natural ventilation, in housing systems where the litter would allow the animals to control their own temperature, and would thereby reduce the amount of energy needed for ventilation and heating. On the other hand, this technique is associated with increased costs, principally due to the straw used and the labour for litter management, even if building costs are usually reduced. For existing buildings, this system can be quite easily applied for housing systems with a solid concrete floor.

Comparisons between bedded systems and traditional slatted floor systems show contradictory results regarding NH₃ and CH₄ emissions while N₂O emissions were systematically increased with the former but with a large variation between studies. These discrepancies can be explained by the wide range of rearing techniques for pigs on litter, the litter substrate, the amount of supplied litter, the space allowance and the litter management. These parameters influence the physical structure (density, humidity) and the chemical properties of the litter that interact to modulate gas emission levels [590, Batfarm 2013].

The production of solid manure instead of slurry manure is considered an advantage from the agronomical point of view, in so far as organic matter incorporated into the fields improves the physical characteristics of the soil, thereby reducing run-off and the leaching of nutrients to water bodies.

4.7.1 Common housing systems for various categories of pigs

This section presents the shared elements related to the description, achieved environmental benefits, cross-media effects and applicability restrictions and driving force for implementation for housing systems which have common characteristics for various pig categories. Housing systems for mating and gestating sows are listed in Section 4.7.2. Housing systems only applicable to farrowing sows are listed in Section 4.7.3. Housing systems for weaners are listed in Section 4.7.4. Housing systems for fattening pigs are listed in Section 4.7.5.

4.7.1.1 Deep pit (in case of a fully slatted floor)

This technique applies to mating and gestating sows, farrowing sows, weaners and fattening pigs.

Description

A deep pit lies under a fully slatted floor with concrete slats. The slurry is removed at variable intervals, usually after every rearing period, or even less frequently.

This type of housing is usually equipped with forced ventilation (normally with negative pressure) or ACNV. Ventilation removes gaseous components emitted by the stored slurry. Exhaust air is normally expelled through roof or side wall vents. Underfloor ventilation may also be applied; it is frequently used in some geographical areas, e.g. France.

Achieved environmental benefits

Since the emitting surface, which is a key factor concerning ammonia emissions, is as wide as the surface at the animals' disposition, emissions are expected to be the highest with this system, hence it is considered the reference for expressing the emission reduction brought about by other techniques. Ammonia emissions can be reduced if the technique is combined with other mitigation measures such as pH reduction of the slurry, slurry cooling, etc.

On the other hand, the system does not generate more ammonia emissions than other housing systems if it is well managed in terms of temperature and ventilation [269, France 2010] [270, France 2010].

Cross-media effects

The use of fully slatted floors makes it difficult to comply with the provisions of Directive 2008/120/EC, as it may be problematic to provide the pigs with permanent access to a sufficient quantity of material to enable proper investigation and manipulation activities, e.g. due to problems in slurry handling with bedding material [510, EFSA 2007]. Fully slatted floors have been identified as one of the factors involved in a compound risk for tail biting which is essential to be controlled when aiming to avoid tail docking. For instance, a high stocking density, associated with a lack of enrichment and fully slatted floors, has been assessed as a

significant risk for tail biting [495, EFSA 2007]. Routine tail docking is prohibited by Directive 2008/120/EC. In some countries (e.g. Sweden, Finland and Denmark from July 2015), fully slatted floors are not permitted by the animal welfare regulations.

However, there are a number of pieces of equipment and methods to provide manipulable material to the pigs, such as the provision of straw and hay in feeders or racks, which allow compliance with the provisions of the Directive if sufficient for the pigs to engage in investigation and manipulation activity [510, EFSA 2007] [624, IRPP TWG 2013].

Deep pits are not allowed in Denmark due to the risk of hydrogen sulphide formation inside the pig house, nor in Sweden for animal welfare reasons [624, IRPP TWG 2013].

Technical considerations relevant to applicability

No technical restrictions are reported for the implementation of the technique.

Driving force for implementation

The system is simple to run. Pigs remain clean and good conditions prevail for animals and workers [269, France 2010] [270, France 2010].

References

[189, Germany 2010] [261, France 2010] [269, France 2010] [270, France 2010] [495, EFSA 2007] [510, EFSA 2007] [624, IRPP TWG 2013]

4.7.1.1.1 Deep pit (in case of a partly slatted floor)

This technique applies to mating and gestating sows, farrowing sows, weaners and fattening pigs.

Description

Partly slatted floored pens are equipped with a manure pit of a sufficient depth that allows for the storage of the slurry between infrequent removals.

In France, pits of less than 1 metre deep are emptied one to three times per cycle. In Germany, overflow channels are preferred, with removal every 1 to 2 months (twice per cycle) or after every fattening period.

In overflow discharge systems (see Figure 4.27), the slurry flows continuously out into a receiving pit (or external slurry store). At the discharge end of the channel below the slatted floor, a barrier (e.g. 15 cm high lip) is built to retain a layer of slurry in the channel that prevents the build-up of solids that may block the channel. The slurry forms a 1.5–3 % slope towards the discharge, maintaining a freeboard of at least 25–30 cm below the slats [498, Cernák 1977].

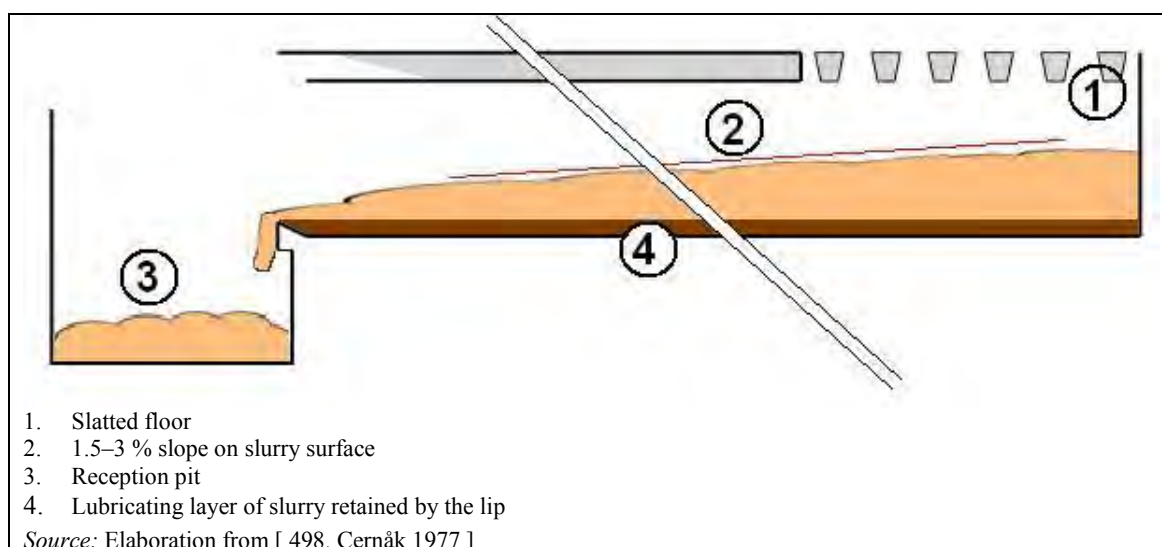

Figure 4.27: Principle of operation of the overflow slurry channel

Achieved environmental benefits

This housing system presents environmental performances comparable to those observed with fully slatted floors with a deep pit. See the general introduction of Section 4.7 on the potential benefits of partly slatted floors.

Cross-media effects

A partly slatted floor system may entail increased requirements in terms of temperature and general management, as solid floors can become soiled, particularly at high temperatures. Dirty floors also have implications for pig hygiene and health, for odour emission and for working conditions, causing discomfort. See also the general introduction in Section 4.7. Extra costs are also associated with the extra time needed for cleaning the pens. Water consumption increases with reduced slatted floor areas, due to the cleaning needs of the solid floor [500, IRPP TWG 2011].

Technical considerations relevant to applicability

No technical restrictions are reported for the implementation of the technique; however, it is not commonly used.

Economics

Investment costs are reported in Germany to be the same as for fully slatted floors [192, Germany, 2010].

Driving force for implementation

Improved animal welfare is the driving force. See also the general information in Section 4.7.

Reference literature

[192, Germany 2010] [271, France 2010] [272, France 2010] [498, Cernák 1977] [500, IRPP TWG 2011]

4.7.1.2 Vacuum system for frequent slurry removal (in case of a fully slatted floor)

This technique applies to mating and gestating sows, farrowing sows, weaners and fattening pigs.

Description

On the bottom of the pit under a fully slatted floor, outlets are placed that are connected to a discharge system moving the slurry to the external storage unit (see Figure 4.28). Slurry is discharged by opening a valve in the main slurry pipe. A slight vacuum develops and allows for a thorough slurry removal, better than by gravity alone. A certain depth of slurry needs to be obtained before the system can operate properly to allow the vacuum to develop and empty more slurry. The pit can be emptied once or twice a week; the evacuation frequency depends on the capacity of the pit or channel and on the weight of the pigs in the pens above, i.e. the same pit is filled up faster by 100 kg pigs than 20 kg pigs. The frequency of emptying will determine the volume of the external slurry storage required [261, France 2010] [175, Ecodyn 2010].

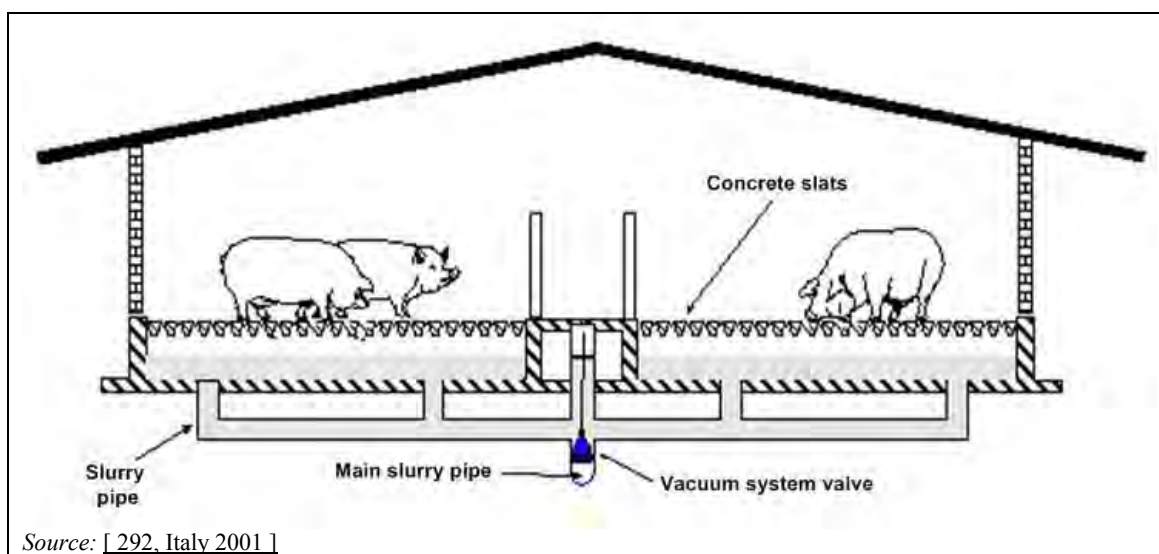

Figure 4.28: Vacuum system in case of a fully slatted floor

The exact area covered by each pipe outlet depends on the dimension of the pen. In general, for every 10–11 metres in length, one pipe outlet is placed to discharge the slurry contained over the corresponding surface. An excessive number of outlets might increase the leakage possibility. The pen area served by each outlet is not considered to affect the emptying capability, as the optimum height of slurry required for the system to work is considered to be the same regardless of the area covered. As a larger pen area will accommodate a proportionately larger number of pigs, the optimum height will not take longer to reach. An optimal slurry depth is approximately 800 mm, regardless of the number of days it takes to reach it. It should be noted that slurry can be removed at a shallower depth, the minimum being 500 mm; however, this does not allow a sufficient vacuum to develop and results in more slurry being left in the system.

High-powered submersible pumps are also used for infrequent intensive cleaning (every 2 years) with high-pressure water to remove crusting from around the tank edges. New houses can be fitted with pits with sloped bottom for an easier and complete emptying [175, Ecodyn 2010].

Achieved environmental benefits

The frequent removal of slurry reduces ammonia emissions and is likely to reduce methane emissions.

Cross-media effects

As the system is manually operated, no additional energy is required nor is the additional working time significant. Less water is needed to clean the floor compared with partly slatted or solid concrete floors. It is suggested that any aerosols which develop during the discharge of the slurry are removed by the vacuum created when opening the valves. Because of the reduced storage period of the slurry inside the buildings, an additional capacity/volume of the external slurry store may be needed.

This technique can generate odour peaks at the time of emptying the slurry pits. It is proposed that emptying should not be more frequent than one or two times per month. [261, France 2010]

In Finland and Sweden, housing systems with fully slatted floors are not allowed due to animal welfare regulations. See also 'Cross-media effects' in Section 4.7.1.1 for fully slatted floors.

Environmental performance and operational data

For the effectiveness of the removal, it is important that it takes place when the slurry is fresh. In order to evaluate the residence time of the slurry before being removed, the index of the ratio of volatile solids to total solids could be used. A value of about 75–80 % of the above ratio seems to be an index of acceptable fresh slurry [624, IRPP TWG 2013].

Frequent removal of slurry from the pit or channel reduces the pool of methanogenic bacteria within this environment [443, Chadwick et al. 2011]. A reduction of methane emissions equivalent to 65 % has been measured in Spain for fattening pigs [187, Spain 2010]. Reported ventilation rates used with this housing system are presented in Table 4.76.

Table 4.76: Reported ventilation rates applied in vacuum systems for frequent slurry removal (in case of a fully slatted floor)

Animal category	Cold season	Warm season	Reference
	m ³ /ap/h	m ³ /ap/h	
Fattening pigs	15.7 (1–64)	66.6 (15–120)	[187, Spain 2010]
Weaners	3.5 to 7	20 to 50	[182, Germany 2010]
Mating/gestating sows (group)	14 to 18	86 to 128	[156, Germany 2010]
Mating/gestating sows (individual)	16	220	[163, Germany 2010]

Average reported consumption data for energy, water and labour are shown in Table 4.77.

Table 4.77: Consumption related to the management of FSF systems equipped with vacuum slurry removal

Animal category	Cleaning water	Electricity	Fuel	Labour	Source
	l/ap/yr	kWh/ap/yr	kWh/ap/yr	h/ap/yr	
Weaners	150	12 9 (ventilation) 2 (lighting)	170	0.99	[182, Germany 2010]
Mating/gestating sows (group)	210	60	160	0.7 (1)	[156, Germany 2010]
Mating/gestating sows (individual)	340	60	160	2.6	[163, Germany 2010]
Fattening pigs	127	NI	NI	0.6	[267, UK 2010]

(1) 0.55 h/year per productive sow.
NB: NI = no information provided.

Technical considerations relevant to applicability

In existing houses, this technique is difficult to apply as the number of outlets per room cannot be modified [261, France 2010]. It may be applicable with:

- solid concrete floors with a sufficient height to build on top of the existing floor;
- renovation of an FSF with a storage pit underneath.

The technique may not be generally applicable to existing plants due to the costly modifications required for retrofitting the existing housing system.

Economics

The frequent removal of slurry by vacuum has practically no extra cost if it is carried out manually [187, Spain 2010] [508, TFRN 2014].

Extra costs may also be associated with the need for additional external slurry storage capacity [261, France 2010] [648, DEFRA 2011].

Driving force for implementation

Slurry removal by vacuum is simple and economical to implement and run.

Reference literature

[156, Germany 2010] [162, Germany 2010] [163, Germany 2010] [175, Ecodyn 2010] [180, Spain 2010] [182, Germany 2010] [187, Spain 2010] [261, France 2010] [267, UK 2010] [292, Italy 2001] [443, Chadwick et al. 2011] [508, TFRN 2014] [624, IRPP TWG 2013] [648, DEFRA 2011]

4.7.1.3 Vacuum system for frequent slurry removal (in case of a partly slatted floor)

This technique applies to mating and gestating sows, farrowing sows, weaners and fattening pigs.

Description

The way slurry is collected below the slatted floor and removed is the same as the one described in Section 4.7.1.2, with the only difference being that the dimensions of the manure channels are reduced in the same proportion as the slatted floor area is reduced in favour of solid floor (see Figure 4.29).

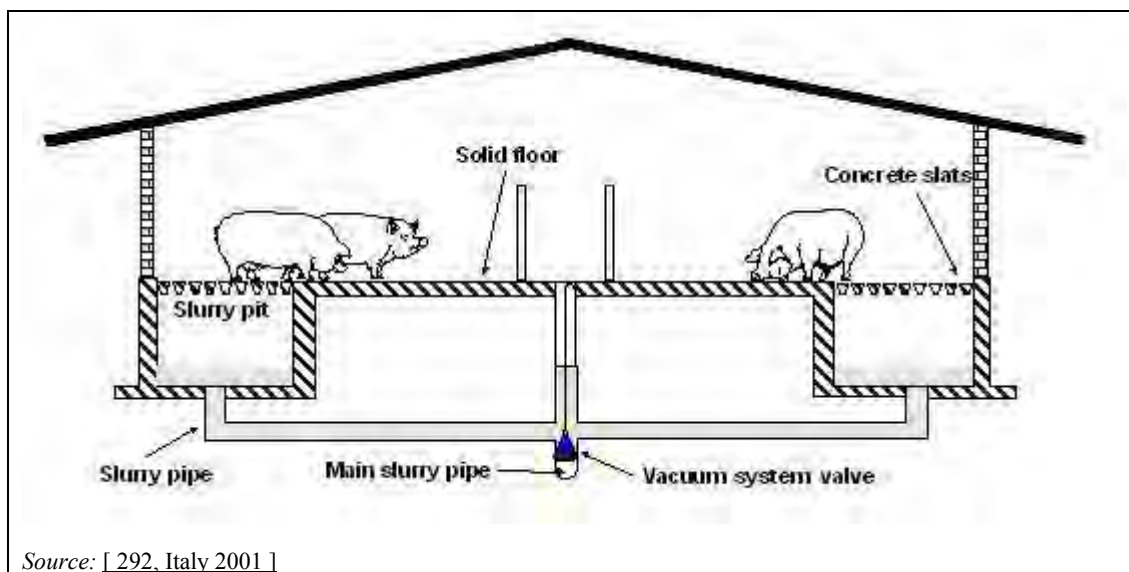

Source: [292, Italy 2001]

Figure 4.29: Vacuum system in case of a partly slatted floor

Achieved environmental benefits

The principles that lead to emission reductions, in comparison with a fully slatted floor system with a deep pit, are the reduction of the emitting surface by reducing the manure surface exposed and the frequent removal of slurry.

Cross-media effects

Due to the fact that pigs reared on a partly slatted floor, particularly finishing pigs, tend to excrete on the solid floor when a critical temperature is reached, the cleanliness of the area may thus deteriorate and ammonia emissions may increase compared with fully slatted floors. For this reason, a more pronounced reduction of the temperature in the room is often required, especially in warm periods. Dirty floors also have implications for pig hygiene and health, for odour emissions, as well as for working conditions. Because of the shorter storage period of the slurry inside the buildings, an additional capacity of outside storage should be considered.

This technique can generate odour peaks at the time of emptying the slurry pits. From France, it is proposed that the rate of emptying should not be more frequent than one or two times per month [261, France 2010].

A slight increase of water consumption is associated with a reduction of the slatted floor area, due to the greater cleaning needs of the solid floor [500, IRPP TWG 2011] [261, France 2010].

Technical considerations relevant to applicability

The technique may not be generally applicable to existing plants due to the costly modifications required for retrofitting the existing housing system. Since the number of outlets per room cannot be modified, it is difficult to implement this technique in existing buildings, at least for weaned piglet and fattening pig housing systems. For sows, plates could be placed on the floor to create a partly slatted floor, but the total surface of the pit will remain unchanged [261, France 2010] [500, IRPP TWG 2011]. Moreover, in existing housing applications, the technique is applicable only in the case of substitution of a partly slatted floor combined with a storage pit of a sufficient depth.

Economics

The frequent removal of slurry by vacuum has practically no extra cost if it is carried out manually [187, Spain 2010] [508, TFRN 2014]. Extra costs may also be associated with the need for additional external slurry storage capacity [261, France 2010] [648, DEFRA 2011].

Driving force for implementation

The vacuum system is considered easy to operate [291, IRPP TWG 2002]. The provision of areas with a solid floor makes pens more comfortable for animals, hence animal welfare is improved.

Example plants

The system is widely applied.

Reference literature

[163, Germany 2010] [187, Spain 2010] [261, France 2010] [276, Finland 2010] [291, IRPP TWG 2002] [292, Italy 2001] [500, IRPP TWG 2011] [508, TFRN 2014] [648, DEFRA 2011]

4.7.1.4 Slanted walls in the manure channel (in case of a fully or partly slatted floor)

This technique applies to mating and gestating sows, farrowing sows, weaners and fattening pigs.

Description

The sides of the manure channels beneath the slatted floors slope towards the bottom in order to reduce the surface area of manure from where ammonia is emitted. Instead of being square, the channel section is V-shaped and the discharge point is placed at the bottom.

The slanted walls are built with a manure-resistant material and are smooth-surfaced. The slope of the slanted walls is at least 45 ° against the floor and at least 60 ° in the middle that forms the V-shape.

Achieved environmental benefits

One or two slanted pit walls applied in the manure channel result in a decreased emitting surface when the height of slurry is lowered, due to frequent emptying of the channel. As a consequence, ammonia emissions are reduced; in combination with partly slatted floors and frequent manure removal, the technique can reduce emissions by up to 65 % [508, TFRN 2014].

Cross-media effects

When the surface of the slanted walls is not smooth, with no slurry sticking effect, and if slanted walls do not have the right sloping angle, manure retention may occur, leading to an increase of emissions. A partly slatted floor may entail increased requirements in terms of temperature and general management, as solid floors can become soiled, particularly at high temperatures (see the general remarks in Section 4.7). See also 'Cross-media effects' in Section 4.7.1.1 for fully slatted floors.

Technical considerations relevant to applicability

The technique may not be generally applicable to existing plants due to the costly modifications required for retrofitting the existing housing system.

Driving force for implementation

No information provided.

Reference literature

[165, Netherlands 2010] [166, Netherlands 2010] [265, BE Flanders 2010] [188, Spain 2010] [179, Spain 2010] [508, TFRN 2014] [589, Netherlands 2010]

4.7.1.5 Scraper for frequent manure removal (in case of a partly or fully slatted floor)

This technique is used for mating/gestating sows, farrowing sows, weaners and fattening pigs in combination with fully or partly slatted floors.

Description

The pen or the farrowing crate contains a slatted part (defecating area) and, in the case of a partly slatted floor, a solid concrete part (lying area) with a slope towards the slats. Slurry is collected in a concrete pit or channel underneath the slats, from which the manure, consisting of faeces, urine, waste bedding and feed, is removed frequently (e.g. daily) by a scraper to the manure pit outside. Urine can drain directly to a collection pit through a drain in the bottom of the manure channel (see Figure 4.51). The scraper is driven by a stationary mechanical or hydraulic power unit. It may comprise chains or cables fitted with metal flaps, blades or flights.

The standard flat scraper system consists of a shallow slurry pit with a horizontal steel scraper under the slatted floor, allowing the manure to be removed from the building several times a day. However, this type of manure removal seems to have no positive effect on NH₃ emissions as the surface under the slat is always soiled because the scraping spreads faeces and urine over the pit and the small film left creates a greater emitting area. In contrast, the V-shaped scraper system, which is described above, is effective in reducing emissions since it is associated with separation of urine from faeces. This system involves a channel with two inclined surfaces on each side of a central gutter. A longitudinal slope of around 1 % allows the liquid fraction to continuously run off by gravity towards the gutter, before being removed outside the building. The solid fraction remains on the inclined surface before being scraped off several times a day [590, Batfarm 2013].

Achieved environmental benefits

A reduced slurry surface and the frequent removal of slurry to an external store combined with the separation of urine from faeces reduce NH₃ emissions. The slat material, frequency of removal and smoothness of the pit floor all contribute to the reduction that can be achieved. By the installation of a V-shaped scraper under the slats, a general reduction of around 40 % can be achieved for NH₃ [590, Batfarm 2013].

Cross-media effects

The functioning of the system is vulnerable due to the wear of the floor. The addition of a coating on the scraped floor is recommended in order to achieve a smooth surface. In general this system works well, but operability is difficult because crystals, which hinder the scraper, can be formed on the pit floor [291, IRPP TWG 2002]. Nowadays, the system is considered reliable [641, IRPP IWG 2014].

Operating the scraper requires energy. The power consumption of scraping varies with the frequency. Frequent maintenance is required for this type of equipment, with a consequent increase in the demand for labour resources. For partly slatted floors, heat stress and defecation on the solid part have to be avoided. See also 'Cross-media effects' in Section 4.7.1.1 for fully slatted floors.

Technical considerations relevant to applicability

Scrapers can be applied in new houses. In existing houses, the applicability depends on the design of the existing manure pit and the building construction, e.g. walls and foundations. In this context, sanitary aspects also have to be taken into consideration as the scraper can go through several rooms with several animal categories [624, IRPP TWG 2013].

Driving force for implementation

The direct separation of urine and the solid part of the manure is an advantage for this technique. The scraper technique in Germany is used when slurry has a high dry matter content, or when the construction of a shallow manure pit is necessary because of the high hydrostatic level of groundwater [192, Germany 2010].

Example plants

This system is applied in Italy and Denmark. In the Netherlands, it is no longer allowed in new buildings. Scrapers in France are only associated with fully slatted floors, where the technique is implemented in some new buildings [261, France 2010].

Reference literature

[42, Netherlands 1999] [192, Germany 2010] [261, France 2010] [391, Italy 1999] [412, Italy 2001] [590, Batfarm 2013] [624, IRPP TWG 2013] [641, IRPP IWG 2014]

4.7.1.6 Convex floor and separated manure and water channels (in case of partly slatted pens)

This technique applies to weaners and fattening pigs.

Description

The emitting area in partly slatted pens is further reduced by making both the slatted area and the pit underneath smaller. The solid concrete floor is designed to slope in two directions so that slurry flows into two channels. Because of the smaller slatted area, the risk of greater fouling of the solid area is mitigated by installing a small second slatted area with a water channel underneath at the other side of the pen where the pigs tend to eat and drink. The channel is filled with water to dilute any manure that might potentially drop into it. At least after each rearing cycle, the channels are completely washed out and the pens are cleaned.

The solid floor that separates the channels can be inclined or convex. The reported width is 1.3 m. The water channel is placed under the feeding system (the minimum water depth is 10 cm for fattening pigs and 5 cm for weaners). As the pigs do not normally defecate in this area, the water channel collects spilled water and spoiled feed. This slatted area has low emissions because any manure dropped there will be diluted. The water in the channel also prevents flies from breeding and can be used to clean the manure channel at the end of the cycle. A maximum width of 0.65 m is reported. Water for cleaning the pens may be used to fill the water channels. The manure channel can also be built with flushed gutters or with slanted walls (see Section 4.7.1.4 and Section 4.7.1.9).

Achieved environmental benefits

Reduction of ammonia emissions is achieved by decreasing the emitting surface and reducing the risk of fouling of the solid area by the installation of an inclined solid floor and a water channel beneath the feeding area. Ammonia emissions can be further reduced by frequent slurry removal.

In general, the combined manure-channel and water-channel system can reduce NH₃ emissions by 40–50 % in comparison with a fully slatted floor system with a deep pit, depending on the size of the water channel [508, TFRN 2014].

Cross-media effects

Energy consumption varies depending on the slurry removal method, i.e. if slurry is flushed or removed by a discharge system. Odour peaks due to flushing may cause a nuisance when there are residential areas near the farm. It has to be decided on a case-by-case basis whether an overall load (thus applying a no-flushing system) or peak values are more important [291, IRPP TWG 2002]. For partly slatted floors, heat stress and defecation on the solid part have to be avoided.

Technical considerations relevant to applicability

In existing houses, the applicability depends on the design of the existing manure pit; retrofitting the system with two channels in existing houses can be difficult and costly. The entire ground plate of the manure pit may have to be removed in order to construct the discharge system for emptying the slurry and water, and digging operations may have to be performed near the load-bearing walls.

Driving force for implementation

The driving force is to achieve a low-cost housing system with a low ammonia emission rate. Partly slatted floors are considered to improve animal welfare. Building sloped walls and flush gutters is relatively easy in pens with a central convex or a partly slatted floor with an inclined concrete floor. Only a few alterations are needed to implement these features.

Reference literature

[42, Netherlands 1999] [22, Bodemkundige Dienst 1999] [176, Netherlands 2010] [186, BE Flanders 2010] [194, Netherlands 2010] [195, Netherlands 2010] [291, IRPP TWG 2002] [508, TFRN 2014]

4.7.1.7 Slurry cooling channels

This technique applies to mating and gestating sows, farrowing sows, weaners and fattening pigs.

Description

A cooling system is installed under the manure pit or the manure channel floor of a housing system, equipped with vacuum cleaning or with a scraper. Low-density polyethylene pipes for the refrigerating liquid are cast in the concrete floor, with a distance of 35–40 cm between each pipe loop (see Figure 4.30). Alternatively, cooling pipes can be installed above the concrete, at the bottom of the manure pits, especially for existing buildings. Pipes are connected to a heat exchanging device (pump or plate) to recover process energy which might be used for heating other parts of the farm (house for weaners, farrowing pens, private farmhouse or greenhouses, etc.). In the cooling circuit, glycol or other types of antifreeze can be added in order to allow the slurry to be cooled to temperatures even below 0 °C. However, extreme cooling reduces the heat pump efficiency. Usually, it is recommended that the system is designed to cool down to a temperature of +5 °C [499, AgroTech 2008]. For heat pumps, see Section 4.5.5.2.

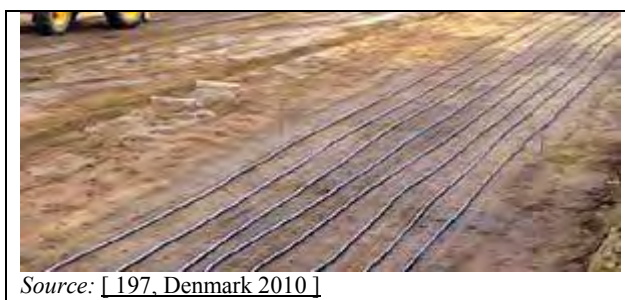

Figure 4.30: Example of PE pipes ready to be cast in concrete

Achieved environmental benefits

A reduction of the slurry temperature is induced to reduce ammonia emissions as at a lower slurry temperature less ammonium is volatilised. The ammonia reduction efficiency depends on the cooling intensity. Cooling manure is also expected to reduce greenhouse gas emissions (primarily CH₄) but the performance has not been verified [197, Denmark 2010].

Cross-media effects

Electrical power is needed to run the pumps (heat pump and circulation pump). If the recovered heat is utilised in other parts of the farm or for domestic heating, then the indirect greenhouse gas emissions, associated with the production of electricity, will be mitigated.

Due to the cooling effect, the application of this technique may result in a lower ventilation rate compared to standard ventilation. In this case, it is important to control it so that the health and safety requirements, in particular exposure to dust, ammonia and other gases (e.g. hydrogen sulphide), are met [499, AgroTech 2008]. The technique may present problems related to ice formation [500, IRPP TWG 2011].

Environmental performance and operational data

Channels need to be scraped daily or flushed on a frequent basis. If not, large volumes of slurry cannot be cooled by the relatively small heat exchanging surface.

Ammonia emission reduction depends on the type of pen floor design, but mostly on the cooling effect per square metre. Danish tests have shown that ammonia emissions are reduced by 10 % for every 10 W/m² of added cooling effect. In other words, ammonia volatilisation is reduced by 5–10 % for every degree the temperature is lowered [499, AgroTech 2008]. Based on the experiment results from Denmark, ammonia emission reduction (compared to non-cooled manure) can be estimated by the following formulae that refer to different manure collection and removal in the channels, combined with manure cooling:

- mechanical scraping and frequent removal: NH₃ emission reduction (%) = $-0.008 x^2 + 1.5$;
- traditional manure pit, vacuum removal and a maximum depth of the slurry in the pit of 40 cm: NH₃ emission reduction (%) = $-0.004 x^2 + x$;

where x = cooling effect per surface (W/m²) [197, Denmark 2010].

Cooling programmes are designed taking into account the possibility of reusing the heat. A heat exchange pump has a typical operating life of at least 15 years. In Denmark, the depth of the slurry in the pit should be no more than 40 cm.

Technical considerations relevant to applicability

This technique is not applicable when heat reuse is not possible. It is also not applicable when bedding is used because a layer of floating residue may develop on top of the slurry.

Manure cooling is not effective for large slurry volumes; therefore, it may be implemented in new or existing housing systems where slurry is frequently removed. Retrofitting is only possible in manure pits where the cooling pipes can be placed above the concrete.

Driving force for implementation

The system can be used on any farm but it is most convenient on integrated farms, where farrowing sows and weaners use the recovered heat from the cooled slurry in other sections. Apart from the environmental benefit of reducing ammonia emissions, the technique may offer a significant energy saving, e.g. reduction of electric energy consumption by a factor of 3 [500, IRPP TWG 2011].

Example plants

More than 300 farms fitted with this technique exist in Denmark. A system with the heat exchanger has been in operation in Finland since 2004.

Reference literature

[160, Denmark 2010] [197, Denmark 2010] [268, Denmark 2010] [276, Finland 2010] [499, AgroTech 2008] [500, IRPP TWG 2011]

4.7.1.8 Slurry surface cooling fins

This technique applies to mating and gestating sows, farrowing sows, weaners and fattening pigs.

Description

The cooling of the slurry surface in the underfloor pit is carried out by pumping groundwater through a floating heat exchanger. As the heat exchanger, arrays of plastic or metal fins are used which are filled with cold water and placed in the pit to float over the slurry. In each manure channel, fins are connected to one another in series and in parallel between manure channels ('Tichelmann' system), for a uniform cooling effect in all cooling elements over the whole slurry surface (see Figure 4.31).

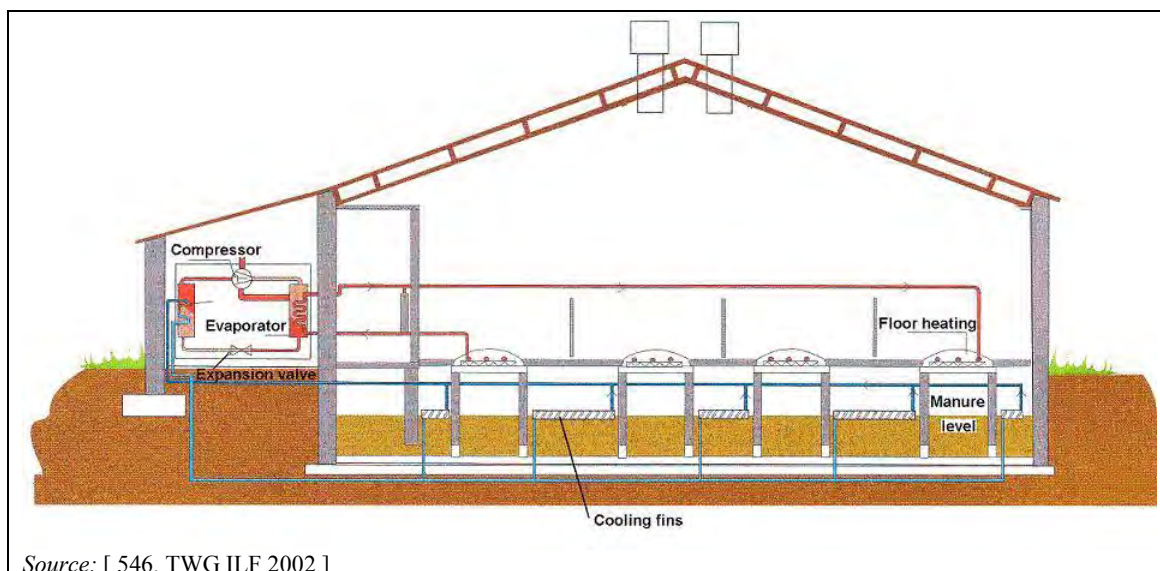

Source: [546, TWG ILF 2002]

Figure 4.31: Slurry surface cooling fins

Cold groundwater circulates through the floating fins as a coolant. By the use of a heat pump exchanger, heat can be obtained for floor heating (see Section 4.5.5.2). The temperature of the top layer of the manure should not exceed 15 °C, hence the water temperature needs to be lower than 12 °C. The technique does not require frequent slurry removal. It is applied in deep pit systems with reported slurry removal frequency in the range of 3–12 months.

Achieved environmental benefits

Ammonia emissions are reduced with a reduction efficiency of 45–75 % depending on the animal category and the surface area of the cooling fins [508, TFRN 2014]. In combination with a heat pump, there will be a reduction in fuel consumption for the heating of buildings (e.g. heating floors in the piglet area). Cooling manure is also expected to reduce greenhouse gas emissions, but the performances are unknown.

In a Dutch study in which cooling hoses floated on the surface of the slurry, a reduction of odour emissions of 20–25 % was measured by decreasing the temperature by 3 °C [499, AgroTech 2008].

Cross-media effects

The technique results in increased energy consumption for pumping water; however, the heat recovered by a heat exchanger can be used for other purposes [169, Netherlands 2010]. Lowering the temperature of the slurry and of the housing in general has to be controlled in order not to affect animal welfare and production.

Technical considerations relevant to applicability

On the basis of the experience in the Netherlands, the technique can be retrofitted in existing houses as the design and the size of the pen are not critical for the applicability of the system. However, other Member States are not of the same opinion and consider that this technique is not easy to operate or to apply. In particular, they have concerns over the fins' buoyancy, with the continuous generation of slurry from the pigs over the slatted floor, and the maintenance of the system and potential solutions are reported to be difficult and expensive [291, IRPP TWG 2002] [500, IRPP TWG 2011]. The technique is not applicable when straw bedding is used because a layer of floating residue may develop on top of the slurry impeding the cooling of the manure surface [168, Netherlands 2010] [508, TFRN 2014]. The technique is not applicable when heat reuse is not possible.

The technique is not applicable if pumping of groundwater is not possible (e.g. because there is no aquifer in the zone) [261, France 2010] [624, IRPP TWG 2013].

Economics

Table 4.78 shows the reported extra investment and annual costs from the Netherlands, together with the expected achievable ammonia emissions reduction (compared to an FSF system).

Table 4.78: Costs for the implementation of cooling fins for different animal categories and expected ammonia emissions reduction, in the Netherlands

Animal category	Cooling fins' surface/slurry surface	NH ₃ emissions reduction		Extra investment cost ⁽¹⁾	Extra annual costs ⁽²⁾
	%	%	kg/ap/yr	EUR/ap	EUR/ap/yr
Gestating sows – partly slatted floor	115 for individual housing, 135 for group housing	50	2.2	110	20
Farrowing sows	150	70	2.4	240	40
Weaners – fully slatted floor	150	75	0.15	19	3
Weaners – partly slatted floor	150	75	0.15	14	2
Fattening pigs – concrete slats, partly slatted floor	200	50	1.0	27	5
Fattening pigs – metal slats, partly slatted floor	170	50	1.4	35	6
Fattening pigs – metal slats, partly slatted floor	200	60	1.2	NI	NI

⁽¹⁾ The extra investment costs are calculated relative to a fully slatted floor with a deep pit.
⁽²⁾ Annual costs include depreciation, interest, maintenance and other operating costs such as energy, extra manure storage, manure management costs, and the costs of any additives.
 NB: NI = no information provided.
 Source: [43, COM 2003] [168, Netherlands 2010] [169, Netherlands 2010] [589, Netherlands 2010] [640, Netherlands 2013]

This technique is most economical if the collected heat can be exchanged to warm other facilities [508, TFRN 2014].

Driving force for implementation

Implementation is easy, both for new buildings and for retrofitting existing houses.

Example plants

In the Netherlands, the system is implemented in many rebuild situations and in some new buildings, where it is applied for fattening pigs, mating and gestating sows, farrowing sows and piglets.

Reference literature

[22, Bodemkundige Dienst 1999] [42, Netherlands 1999] [43, COM 2003] [168, Netherlands 2007] [169, Netherlands 2007] [291, IRPP TWG 2002] [499, AgroTech 2008] [500, IRPP TWG 2011] [508, TFRN 2014] [546, TWG ILF 2002] [589, Netherlands 2010] [624, IRPP TWG 2013] [640, Netherlands 2013]

4.7.1.9 Frequent slurry removal by flushing (in case of a fully or partly slatted floor)

This technique applies to mating and gestating sows, farrowing sows, weaners and fattening pigs.

Description

Slurry removal is performed once or twice a day by opening a gate valve or sluice gate and flushing out the contents of the collecting channels beneath the slatted floors with the liquid fraction of the slurry after mechanical separation (dry matter lower than approximately 5 %). The liquid fraction of the slurry can also be aerated before flushing. The objective of the technique is to reduce emissions by frequent removal of the slurry with a dilute recirculated liquid fraction. Water or the digestate from a biogas installation can be used as well. The flushing technique is used in combination with specific individual equipment at the bottom of channels or pits, as described below.

Gutters

Shallow plastic or metal channels (maximum 60 cm wide, 20 cm deep with sides sloping 60 °) are placed over the surface of slurry channels under fully slatted or partly slatted floors. The oval shape is intended to reduce the surface of manure exposed to the air and to naturally drain the urine (see Figure 4.32).

Tubes

PVC tubes are incorporated into the concrete under the slats and liquid drains into these through slots (see Figure 4.33). Alternatively, the bottom of the pit is arranged in channels by the construction of low walls in the blockwork [261, France 2010].

Flushing channels with a permanent slurry layer

Channels underneath the slatted floor are filled with a 10 cm layer of slurry manure (see Figure 4.34). A common feature of all variations is the inclination of the channels (around 0.5 %) that facilitates the slurry removal by flushing and allows for the natural continuous drainage of the urine.

The mechanically separated liquid fraction of the slurry that is used to flush the channels has a low dry matter content (no higher than approximately 5 %); it may be aerated before being used for flushing (see Section 4.12.3.1). The fermented slurry from the biogas installation is odourless and free of solid components and, therefore, optimal for use as a flushing liquid.

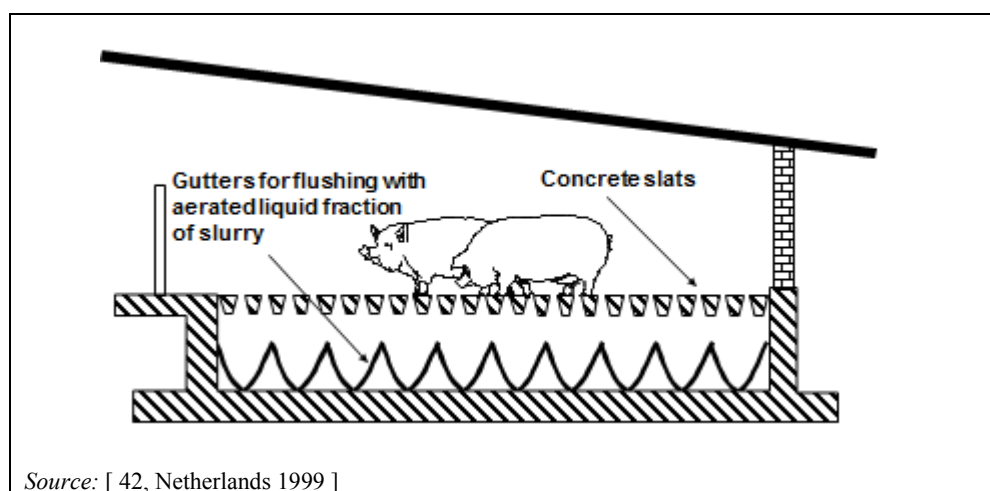

Figure 4.32: Fully slatted floor with flushing gutters

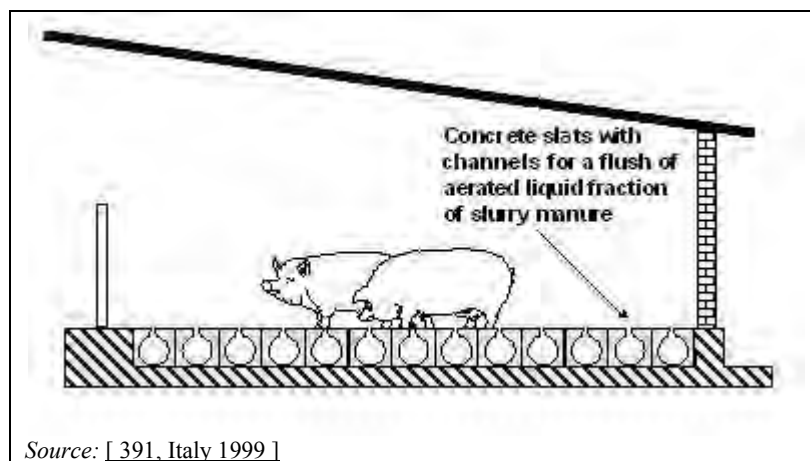

Figure 4.33: Fully slatted floor with flushing tubes

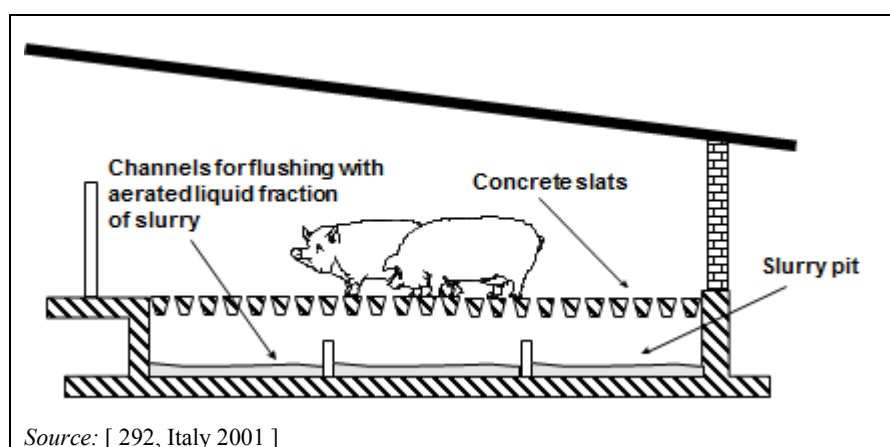

Figure 4.34: Fully slatted floor with flushing of a permanent slurry layer in channels underneath

Achieved environmental benefits

The reduction of the emitting slurry surface (gutters and/or partly slatted floors), the frequent removal of the slurry and the continuous draining of the urine all contribute to reduce NH_3 emissions. No difference is reported in terms of ammonia emissions between using tubes and gutters.

Shallow V-shaped gutters can reduce emissions in pig houses by 40 % to 65 %, depending on the pig category and the presence of partly slatted floors, after flushing twice a day with the liquid fraction of the slurry [508, TFRN 2014].

Frequent emptying of the slurry channel and flushing the channel with water or the liquid fraction of the separated slurry allow a lower emission reduction potential because the emitting surface remains the same. It is also reported that the largest reduction in emissions is achieved when the slurry is discharged from the gutters prior to flushing, resulting in a decrease in NH_3 emissions of about 70 % compared to those from a fully slatted floor system with a deep pit [439, Sommer et al. 2006].

The quality of the flushing liquid influences the efficiency of the system, meaning that ammonia volatilisation is facilitated by the transfer of urea during the flushing [261, France 2010]. The use of fresh water as the flushing liquid reduces CH_4 emissions as no slurry remains in the pit after emptying [590, Batfarm 2013]. Aerosols may also be reduced by frequent flushing.

Cross-media effects

The energy requirements for these systems show large variations, especially in combination with the aeration of the slurry. Energy consumption depends on the distance of the building from the treated slurry store.

Odour peaks due to flushing may cause a nuisance when there are sensitive receptors near the farm. The peaks are higher if flushing is done without aerated slurry. It has to be decided on a case-by-case basis whether an overall load (thus applying a no-flushing system) or peak values are more important [291, IRPP TWG 2002]. When flushing with water, odour peaks are avoided and less residues are left in the gutters. Because of the odour peak and the residue problems, flushing with slurry has almost been abandoned in the Netherlands [641, IRPP IWG 2014]. Frequent slurry removal by flushing is not considered appropriate in Sweden because it could increase the amount of sulphide concentration in the houses [624, IRPP TWG 2013].

The frequent flushing, the proper mechanical separation of slurry and the shallow depth of the gutters prevent sediments from accumulating and the bottoms from dehydrating, which would otherwise make the cleaning of the pit bottom difficult and cause fly infestations, particularly in the warm season [261, France 2010]. It is also reported from France that, when using slurry for flushing which underwent only a simple separation, sanitary risks from the flushing liquid exist on an integrated farm (e.g. young pigs' and sows' gutters cannot be flushed with liquid coming from fattening pigs) [500, IRPP TWG 2011]. Moreover, flushing with water dilutes the slurry and increases the volume of slurry produced in the unit. As a consequence, the minimum storage capacity required increases, as well as the cost of transportation [508, TFRN 2014] [624, IRPP TWG 2013].

Slurry aeration, as a technique for treating manure, is associated with potential negative effects (see Section 4.12.3.1). For partly slatted floors, heat stress and defecation on the solid part have to be avoided. See also 'Cross-media effects' in Section 4.7.1.1 for fully slatted floors.

Technical considerations relevant to applicability

In general, the applicability in existing houses depends on the design of the existing manure pit. Construction adaptations are only minor if the housing system is already equipped with a manure channel. In the event that the existing house consists of a fully slatted floor with a deep pit, major construction adaptations are required [500, IRPP TWG 2011]. Implementation in existing houses may be possible but costly for gutters, not practicable for tubes, and possible with little construction adaptations for the channels with a permanent layer of slurry.

With this technique, only over-floor extraction can be used in the ventilation system [261, France 2010]. The use of aerated slurry for flushing is possible only for farms already equipped for this type of slurry treatment. The possibility of using the effluent from the on-farm biological treatment of the liquid fraction of separated pig slurry is being explored in Belgium (Flanders).

Economics

Most Italian farms equipped with these systems are also fitted with natural ventilation which makes the investments of the farm interesting. In comparison to houses with deep pits, these systems are also advantageous for the reduced building needs in terms of digging the shallow manure pits that are required. As a consequence of these preconditions, the investment costs that were calculated in the past sometimes gave negative results, meaning that economic benefits resulted.

Only enlargements of farms with these systems already in place are known to be implemented. No economic values have been provided. In the case of existing houses, the costs for modification of the ventilation system should be considered when the buildings are equipped with underfloor extraction [261, France 2010]. The cost of an additional external slurry store should also be taken into account.

Driving force for implementation

The indoor air quality significantly improves, as does animal health as a consequence.

Example plants

Some farms in Italy are still equipped with these systems. Several farms in the Netherlands (350 farms in 2007 and 84 in the province of North Brabant alone in 2012) are equipped with the gutters systems and operate with non-aerated slurry. In France, the system is little developed and is only applied for fattening pigs and mating/gestating sows on fully slatted floor.

Reference literature

[42, Netherlands 1999] [261, France 2010] [291, IRPP TWG 2002] [292, Italy 2001] [391, Italy 1999] [412, Italy 2001] [439, Sommer et al. 2006] [500, IRPP TWG 2011] [508, TFRN 2014] [590, Batfarm 2013] [624, IRPP TWG 2013] [641, IRPP IWG 2014]

4.7.1.10 Kennel or hut housing (in case of a partly slatted floor)

This technique applies to mating and gestating sows, weaners and fattening pigs.

Description

The building is open and non-insulated (only the ceiling can be insulated) with a free (natural) ventilation system and separate functional areas in the pen. The lying area consists of a levelled insulated concrete floor with covered insulated boxes (huts or kennels) with a hinged roof that can be raised or lowered to control temperature and ventilation. The activity and feeding area can be located over a perforated or slatted floor. The manure generated is managed as slurry. Kennels have openings for air exchange.

Due to the sheltering effect of covered lying boxes, the room temperature can be lower than normal. Kennels are kept warm by the animals in winter and do not require heating. For this reason, the system is particularly suitable for naturally ventilated houses.

Achieved environmental benefits

The operating principle is that ammonia emission reduction is brought about due to the smaller emitting manure surface in the pit below the partly slatted floor. Ammonia emissions are also reduced due to the lower room temperature requirements and the separation of functional areas. Providing some straw on the solid concrete floor in the activity area prevents the floor from getting dirty and, therefore, reduces emissions to air. This system has a low energy demand due to the lower room temperature.

Cross-media effects

Careful management is required for the control of the indoor climate (temperature, airflow rate, etc.) [261, France 2010]. In hot climates, it must be ensured that pigs are offered the possibility of cooling down. For partly slatted floors, heat stress and defecation on the lying area have to be avoided.

Increased labour requirements for the management of the system, such as cleaning of the concrete floor area in the lying kennel, are necessary. Water consumption always slightly increases after reducing the slatted floor area, due to the cleaning needs of the solid floor.

Technical considerations relevant to applicability

This technique is only applicable to existing plants with natural ventilation. It is applied for fattening pigs, weaners, mating and gestating sows; it is not applied for farrowing sows. The benefits of natural ventilation are achieved when the building orientation is at a right angle to the main wind direction. In France, this technique is considered as an outdoor system for the implementation of Commission Regulation 2075/2005/EC on trichinellosis and leptospirosis.

Driving force for implementation

Improved animal welfare is the driving force. The main motivation for the construction of a naturally ventilated house is generally the animal-friendly housing and the securing of a good health status. Kennel housing is needed for organic farming [624, IRPP TWG 2013].

Example plants

The technique is available and is frequently used in southern Germany.

Reference literature

[155, Germany 2010] [183, Germany 2010] [190, Germany 2010] [261, France 2010] [547, IMAG-DLO 2001] [575, UBA Germany 2011] [624, IRPP TWG 2013]

4.7.2 Housing systems for mating and gestating sows

Mating and gestating sows can be housed either individually or in groups. However, Directive 2008/120/EC requires that Member States ensure that sows and gilts are kept in groups, during a period starting from 4 weeks after service to 1 week before the expected time of farrowing [158, EC 2008].

Requirements for flooring surfaces are included in the Directive. In particular, for gilts after service and pregnant sows when gilts and/or sows are kept in groups, the total unobstructed floor area available to each gilt and to each sow should be at least 1.64 m² and 2.25 m², respectively. When these animals are kept in groups of fewer than six individuals, the unobstructed floor area should be increased by 10 %. When these animals are kept in groups of 40 or more individuals, the unobstructed floor area may be decreased by 10 %. In addition, a part of the above available area equal to at least 0.95 m² per gilt and at least 1.3 m² per sow should be of continuous solid floor, of which a maximum of 15 % is reserved for drainage openings. Finally, when concrete slatted floors are used for sows kept in groups, the maximum width of the openings should be 20 mm for gilts after service and sows, and the minimum slat width should be 80 mm. Pens designed with a separate excretion area, with different functional areas and for larger group of sows, have a lower emission potential due to the reduced emitting surface [474, VDI 2011].

Ammonia emissions associated with the techniques used to rear mating and gestating sows are summarised in Table 4.79. Data concerning emissions of methane, dust and odour are also presented, when available.

Table 4.79: Emission levels of system-integrated housing techniques for mating and gestating sows

Section	Housing system	Variant	NH ₃	CH ₄	PM ₁₀	Odour	Source
			kg/ap/yr	kg/ap/yr	kg/ap/yr	ou _e /s/animal	
4.7.2.1	Deep pit (in case of a fully or partly slatted floor)	Individual housing	4.2	NI	NI	NI	[508, TFRN 2014]
		Group housing	3.12–3.7	NI	NI	NI	[43, COM 2003]
			4.2				[508, TFRN 2014]
			NI	NI	NI	57	[634, BE Flanders 2013]
4.7.2.2	Vacuum system for frequent slurry removal (in case of a fully slatted floor)	Group housing, concrete slats	4.8 ⁽¹⁾	NI	0.16 ⁽²⁾ ⁽³⁾	6.6 ⁽⁴⁾	[156, Germany 2010] [162, Germany 2010]
4.7.2.3	Vacuum system for frequent slurry removal (in case of a partly slatted floor)	Metal slats	2.40	NI	NI	NI	[43, COM 2003]
		Concrete slats	2.77	NI	NI	NI	[43, COM 2003]
		Individual housing (mating sows), concrete slats	4.8 ⁽¹⁾	NI	0.16 ⁽²⁾ ⁽³⁾	6.6 ⁽⁵⁾	[163, Germany 2010] [474, VDI 2011]
4.7.2.4	Slanted walls in the manure channel (in case of a fully or partly slatted floor)	Concrete slats	2.50 ⁽¹⁾ 2.60	NI	0.22 ⁽⁶⁾	18.7	[165, Netherlands 2010] [186, BE Flanders 2010]
		Metal slats	2.15 ⁽⁴⁾ 2.30	NI	0.22 ⁽⁶⁾	18.7	[166, Netherlands 2010] [186, BE Flanders 2010]
4.7.2.5	Scraper for frequent slurry removal (in case of a partly or fully slatted floor)	Metal slats	1.85	NI	NI	NI	[43, COM 2003]
		Concrete slats	2.22–3.12	NI	NI	NI	[43, COM 2003]
4.7.2.6	Frequent slurry removal by flushing (in case of a fully or partly slatted floor)	FSF	1.66–2.59	NI	NI	NI	[43, COM 2003]
		PSF	1.48–1.85	NI	NI	NI	[43, COM 2003]
4.7.2.7	Reduced manure pit (in case of a partly slatted floor)	Group housing	2.96	NI	NI	NI	[43, COM 2003]
		Individual housing	1.23	NI	NI	NI	[43, COM 2003]
			2.272 ⁽⁴⁾	18.2	NI	NI	[164, Spain 2010]
			2.40	NI	NI	NI	[43, COM 2003]
4.7.2.8	Kennel or hut housing (in case of a partly slatted floor)	PSF	3.75 ⁽²⁾	NA	0.16 ⁽²⁾ ⁽³⁾	6.6 ⁽²⁾ ⁽⁵⁾	[155, Germany 2010] [474, VDI 2011]
4.7.2.9	Slurry cooling channels	PSF	NI	NI	NI	NI	NI
	Slurry cooling fins	Individual or group housing	2.2 ⁽²⁾	NI	0.22 ⁽²⁾	NI	[168, Netherlands 2010] [169, Netherlands 2007]

Section	Housing system	Variant	NH ₃	CH ₄	PM ₁₀	Odour	Source
			kg/ap/yr	kg/ap/yr	kg/ap/yr	ou _E /s/animal	
4.7.2.10	Full litter system (in case of a solid concrete floor)	Full litter (no separate functional areas)	2.5–5.6	NI	NI	NI	[261, France 2010]
			3.7–5.2	NI	NI	NI	[43, COM 2003]
		Slatted defecating area	4.8 ⁽²⁾ ⁽⁷⁾	NI	0.8 ⁽²⁾ ⁽³⁾	6.6 ⁽²⁾ ⁽⁵⁾	[157, Germany 2010] [474, VDI 2011]
		Bedded lying area, separate defecating area and feeding area with electronic sow feeders	4.8 ⁽²⁾	NI	0.8 ⁽²⁾ ⁽³⁾	6.6 ⁽²⁾ ⁽⁵⁾	[161, Germany 2010] [474, VDI 2011]
			2.6	NI	NI	NI	[186, BE Flanders 2010]
Separate feeding area	1.96–3.5 ⁽⁴⁾ ⁽⁶⁾	5.5–6.2 ⁽⁶⁾	NI	NI	[230, Philippe et al. 2009]		
4.7.2.11	Feeding/lying boxes on a solid floor (in case of litter-based pens)	Solid floor	1	NI	NI	NI	[186, BE Flanders 2010]

⁽¹⁾ Values derived from measurements.
⁽²⁾ Values derived by expert judgement based on conclusions by analogy.
⁽³⁾ All stages of breeding sows, including piglets up to 25 kg.
⁽⁴⁾ Measured values.
⁽⁵⁾ Values calculated from an emission of 22 ou_E/s per LU and an average weight of 150 kg for early-pregnant or non-pregnant sows.
⁽⁶⁾ The upper value is related to ad libitum feeding; the lower value is related to restricted feeding.
⁽⁷⁾ In the event that there is a yard, additional emissions are likely.
 NB: NI = no information provided.

4.7.2.1 Deep pit (in case of a fully or partly slatted floor)

Description

See Section 4.7.1.1 for fully slatted floors and Section 4.7.1.1.1 for partly slatted floors. Group housing is compulsory for all mating and gestating sows (except for a four-week period after insemination and 1 week before farrowing).

Achieved environmental benefits

See Section 4.7.1.1 (fully slatted floors) and Section 4.7.1.1.1 (partly slatted floors).

Cross-media effects

See Section 4.7.1.1 (fully slatted floors) and Section 4.7.1.1.1 (partly slatted floors).

Environmental performance and operational data

The emission levels associated in the original ILF BREF [43, COM 2003] with a housing system with a fully slatted floor, forced ventilation and an underlying deep collection pit were between 3.12 kg and 3.70 kg NH₃ per sow place per year, whereas individual housing was associated with higher levels at 4.2 kg NH₃ per sow place per year. However, according to the UNECE guidance document on 'Options for ammonia mitigation', group housing has similar emission levels to individual housing and ammonia emissions for the system are considered to be equal to 4.2 kg NH₃ per sow place per year [508, TFRN 2014].

Odour emissions have been measured at 57 ou_E/animal/s [634, BE Flanders 2013]. Ventilation rates reported by Belgium (Flanders) are 6–20 m³/h/sow for the cold season and 20–80 m³/h/sow for the warm season [637, BE Flanders 2012]. The energy required for forced ventilation is variable, but on average in Italy this has been estimated as 42.2 kWh per sow per year [292, Italy 2001].

Technical considerations relevant to applicability

No information provided.

Economics

The average investment required in the Netherlands for a new integrated building for sow housing with a manure pit 0.8 m deep (including 130 farrowing pens with a fully slatted floor and 4.5 m² per pen; 2016 weaner places with 0.4 m² total surface per animal place and a partly slatted floor with a 60 % convex solid floor; 477 mating and gestating sow places with 2.25 m² total surface per place with a 60 % solid floor) are reported as EUR 2 240 per sow place, excluding any additional system aiming to reduce ammonia emissions. Investment costs per gestating sow place range from EUR 1 040 to EUR 1 160 depending on the volume and size of the pens [589, Netherlands 2010].

Driving force for implementation

See Section 4.7.1.1 for fully slatted floors and Section 4.7.1.1.1 for partly slatted floors.

Example plants

No information provided.

Reference literature

[43, COM 2003] [292, Italy 2001] [508, TFRN 2014] [589, Netherlands 2010] [634, BE Flanders 2013] [637, BE Flanders 2012]

4.7.2.2 Vacuum system for frequent slurry removal (in case of a fully slatted floor)

Description

See also Section 4.7.1.2. A housing system implementing slurry removal by vacuum (with a frequency of 2–8 weeks) is reported from Germany for gestating sows, where the lying area is drained by a perforated floor [[156, Germany 2010](#)]. The system is illustrated in Figure 2.14.

Achieved environmental benefits

See Section 4.7.1.2. A reduction of 25 % for NH₃ emissions is reported due to frequent removal of slurry in comparison with a fully slatted floor system with a deep pit [[508, TFRN 2014](#)].

Cross-media effects

See Section 4.7.1.2.

Environmental performance and operational data

Italian data reported about 2.77 kg NH₃ per sow place per year. The slurry removal frequency by vacuum is reported by Germany as 2 to 8 weeks, without any effect on ammonia emissions (4.8 kg NH₃/ap/yr) [[156, Germany 2010](#)] [[162, Germany 2010](#)]. Ventilation rates reported by Germany are 14–18 m³/h/animal for the cold season and 86–128 m³/h/animal for the warm season [[156, Germany 2010](#)]. See also Section 4.7.1.2.

Technical considerations relevant to applicability

See Section 4.7.1.2.

Economics

See Section 4.7.1.2.

Driving force for implementation

See Section 4.7.1.2.

Example plants

This technique is widely used in Germany. In France, this is the most commonly used system in buildings with shallow pits; however, slurry is stored during the whole rearing cycle [[261, France 2010](#)].

Reference literature

[[156, Germany 2010](#)] [[162, Germany 2010](#)] [[261, France 2010](#)] [[292, Italy 2001](#)] [[508, TFRN 2014](#)]

4.7.2.3 Vacuum system for frequent slurry removal (in case of a partly slatted floor)

Description

See also Section 4.7.1.3. A housing system with vacuum removal (with a frequency of 2–8 weeks) is reported from Germany for mating sows with temporary fixing in the insemination area in combination with a partly slatted floor (service centre) [[163, Germany 2010](#)]. The system is illustrated in Figure 2.9.

Achieved environmental benefits

See also Section 4.7.1.3. A reduction of 25 % for NH₃ emissions is reported due to frequent removal of slurry in comparison with a fully slatted floor system with a deep pit [[508, TFRN 2014](#)].

Cross-media effects

See Section 4.7.1.3.

Environmental performance and operational data

With a partly slatted floor and a vacuum system, NH₃ emissions are reduced to 2.77 kg per sow place per year on concrete slats, and to 2.40 kg per sow place per year on metal slats for group housing of gestating sows. The system was credited with allowing an emission reduction, compared to fully slatted floors with a deep pit, of 25 % with concrete slats or 35 % with metal slats, where less manure is retained [43, COM 2003]. In Germany, no ammonia emission reduction is associated with this housing system (emission factor of 4.8 kg NH₃/ap/yr) where the perforation or not of the lying area has no effect on ammonia emissions [162, Germany 2010].

Technical considerations relevant to applicability

See Section 4.7.1.3.

Economics

See Section 4.7.1.3.

Driving force for implementation

See Section 4.7.1.3.

Example plants

See Section 4.7.1.3.

Reference literature

[43, COM 2003] [162, Germany 2010] [163, Germany 2010] [291, IRPP TWG 2002]
[508, TFRN 2014]

4.7.2.4 Slanted walls in the manure channel (in case of a fully or partly slatted floor)

Description

See also Section 4.7.1.4. This housing system is reported to be applied for group housing of gestating sows on partly slatted floors without straw bedding, where the minimum surface per sow is 2.25 m², of which at least 1.3 m² (60 %) per sow is solid floor. A maximum emitting surface of 0.55 m² in the channel corresponds to each animal. A cross section and a plan view of the technique are shown in Figure 4.35.

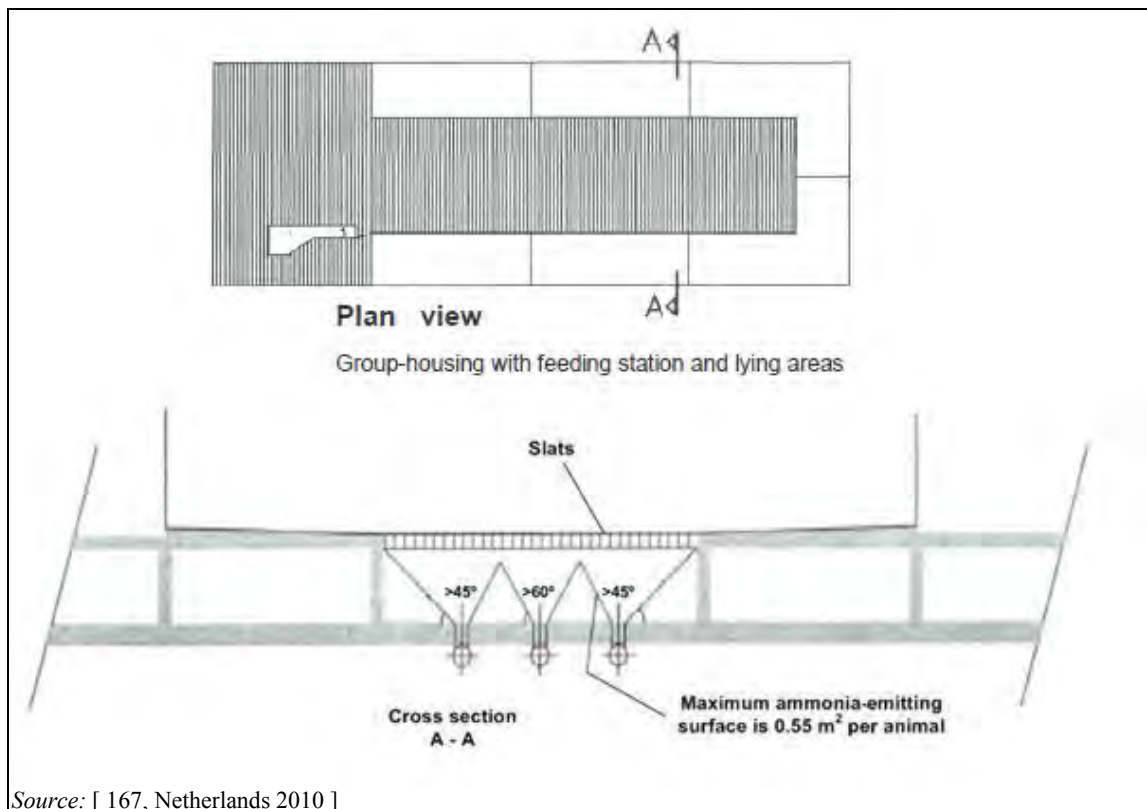

Figure 4.35: Cross section and plan view of the floor in a housing system for gestating sows with a manure channel with slanted walls

Achieved environmental benefits

See Section 4.7.1.4. An emission reduction efficiency of 45 % is reported for group housing of gestating sows with feeding stalls in comparison with a fully slatted floor system with a deep pit [508, TFRN 2014].

Cross-media effects

See Section 4.7.1.4.

Environmental performance and operational data

A potential reduction of ammonia emissions of up to 50 % is reported when combined with frequent emptying of the slurry channels [439, Sommer et al. 2006]. From the Netherlands, the room temperature in housing systems for gestating sows is reported to be around 20 °C and the minimum frequency for slurry removal twice a week. Triangular metal slats will further reduce ammonia emissions. Reported emissions associated with the technique are shown in Figure 4.79.

Table 4.80: Emission levels associated with slanted walls in the manure channel (in case of partly slatted floors)

Animal	NH ₃	CH ₄	PM ₁₀	Odour	Slurry removal frequency	Source
	kg/ap/yr			ou _E /s/animal		
Gestating sows, metal slats, emitting surface < 0.55 m ² /animal	2.15 (1.76–2.53) ⁽¹⁾	NI	0.175 ⁽¹⁾	18.7 ⁽¹⁾	Once every 2 weeks	[166, Netherlands 2010]
	2.3		NI	NI	Once each week	[186, BE Flanders 2010]
Gestating sow, concrete slats, emitting surface < 0.50 m ² /animal	2.5 ⁽²⁾	NI	0.175 ⁽¹⁾	18.7 ⁽¹⁾	Once every 2 weeks	[165, Netherlands 2010]
	2.6		NI	NI	Once each week	[186, BE Flanders 2010]
⁽¹⁾ Measured data. ⁽²⁾ Values derived from measurements. NB: NI = no information provided.						

Technical considerations relevant to applicability

In general, the system can be easily adapted to existing gestation pens, especially when individual housing is converted into group housing and the free run area between the rows of crates is wide enough. If this area is not wide enough, the crates can be placed above the control corridor. The solution can also fit other group housing systems without crates, for example those equipped with feeding stations [166, Netherlands 2010]. When the technique is adapted to existing gestation pens, and if the existing manure pit is already shallow (0.80 m to 1.2 m), the location of the already existing discharge openings will be crucial for retrofitting this system. See also Section 4.7.1.4.

Economics

In the Netherlands, depending on the material the slats are made from, extra investment costs for the implementation of the technique are reported as EUR 130 per animal place for triangular iron slats, and EUR 100 per animal place for concrete slats. The corresponding annual costs are EUR 15/ap/yr and EUR 10/ap/yr respectively (including depreciation, interest, maintenance and all other operating costs, such as energy) [165, Netherlands 2010] [166, Netherlands 2010] [589, Netherlands 2010]. The annual extra costs are reported as equal to EUR 16 per animal place and the cost efficiency EUR 10 per kg of NH₃-N reduced [508, TFRN 2014].

In Belgium (Flanders), the extra cost (compared to a fully slatted floor with a deep pit) is reported as EUR 292 per animal place (23 % higher) [300, BE Flanders 2010]. In the event that the existing manure pit is already shallow and existing discharge openings are usable, retrofitting costs are reported to amount to EUR 472 per gestating sow place (group-housed). If the existing discharge openings cannot be used, costs will be substantially higher [273, BE Flanders 2010].

Driving force for implementation

The technique offers an efficient solution for adapting existing sow housing systems from individual housing to group housing (in compliance with Directive 2008/120/EC) with lower ammonia emissions. With this housing system, the pens and the crates can be used for the group housing by using the central slatted floor between the rows of crates as a free run for the sows.

Example plants

In Belgium (Flanders), this technique is widely applied, with a total of 244 sow farms authorised (including farms below and above the production capacity threshold set by Directive 2010/75/EU). It is also widely applied throughout the Netherlands.

Reference literature

[165, Netherlands 2010] [166, Netherlands 2010] [167, Netherlands 2010] [186, BE Flanders 2010] [273, BE Flanders 2010] [300, BE Flanders 2010] [439, Sommer et al. 2006] [508, TFRN 2014] [589, Netherlands 2010]

4.7.2.5 Scraper for frequent slurry removal (in case of a fully or partly slatted floor)**Description**

See Section 4.7.1.5.

Achieved environmental benefits

See Section 4.7.1.5.

Cross-media effects

See Section 4.7.1.5.

Environmental performance and operational data

NH₃ emission levels reported by Italy of 1.85 kg (on metal slats) and 2.22 kg (on concrete slats), and by Denmark of 3.12 kg (concrete slats) per sow place per year are achieved with the technique. These levels represent a reduction of 50 % for metal slats and 15 % to 40 % for concrete slats compared to a fully slatted floor with a deep pit. Clearly, the frequency of scraping and the smoothness of the pit floor surface are factors which help determine the reduction that can be achieved. These emission levels were obtained under average conditions. The frequency of scraping was once a day. Application of metal slats gives lower emissions as slurry is removed faster into the pit.

Technical considerations relevant to applicability

See Section 4.7.1.5.

Economics

Data on capital costs are not available, but the operating costs per pig per year are considered to be high [291, IRPP TWG 2002].

Driving force for implementation

See Section 4.7.1.5.

Example plants

There are very few applications with an external alley design in Italy. This system is also in operation in Denmark and in the Netherlands, where it is no longer applied in new buildings. Scrapers in France are only associated with fully slatted floors [261, France 2010].

Reference literature

[42, Netherlands 1999] [261, France 2010] [291, IRPP TWG 2002] [391, Italy 1999] [412, Italy 2001]

4.7.2.6 Frequent slurry removal by flushing (in case of a fully or partly slatted floor)**Description**

See Section 4.7.1.9. Application is possible in pens with a partly or fully slatted floor, in individual stalls and in group housing systems. A design with flushing gutters in individual housing is illustrated in Figure 4.36. The manure surface should be no larger than 1.10 m² per sow.

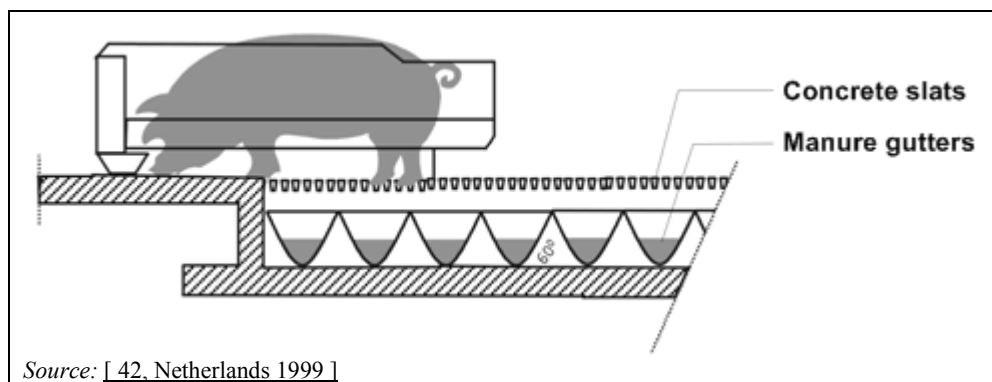

Figure 4.36: Flushing gutters in individual mating/gestating sow housing (in case of a partly slatted floor)

For group housing, the same description applies as that given in Figure 4.32. The pictures are only different in the sense that the concrete floor surface is larger and the slatted part with the slurry gutters/tubes underneath is smaller.

Achieved environmental benefits

See Section 4.7.1.9. An ammonia emission reduction of 40 % is reported for the flushing gutters technique when applied in gestating sow housing systems [508, TFRN 2014].

Cross-media effects

See Section 4.7.1.9.

Environmental performance and operational data

Emission data from flushing frequently channels, equipped with gutters or tubes or having a permanent slurry layer, with aerated slurry or non-aerated slurry, are presented in Table 4.81.

Table 4.81: Ammonia emissions from mating/gestating sow houses with frequent slurry removal by flushing

Variant	Floor	NH ₃ emission ⁽¹⁾		NH ₃ emission reduction	
		Non-aerated slurry	Aerated slurry	Non-aerated slurry	Aerated slurry
		kg/animal place/year		(%)	
Gutters/tubes	PSF	1.48	1.11	60	70
Gutters/tubes	FSF	2.22	1.66	40	55
Channels with a permanent slurry layer	FSF	2.59	1.66	30	55
Channels with a permanent slurry layer	PSF	1.85	1.48	50	60

⁽¹⁾ Elaboration based on data from the ILF BREF (2003).
 NB: Comparison with a system with FSF and a deep pit.
 Source: [43, COM 2003] [292, Italy 2001] [42, Netherlands 1999]

Energy consumption levels for operating the flushing systems, for separating the slurry and for aeration are reported in Table 4.82.

Table 4.82: Energy requirements for flushing systems applied in gestating sow houses

System	Energy requirement by operation (kWh/ap/yr)			Total (kWh/ap/yr)	
	Flushing	Mechanical separation of slurry	Aeration	Non-aerated slurry	Aerated slurry
FSF with flushing gutters	3.9	14.6	13.9	18.5	32.4
PSF with flushing gutters	2.4	12.03	15.6	14.4	30
FSF with flushing channels	8.2	14.6	17.5	22.8	40.3
PSF with flushing channels	3.4	18.3	16.8	21.7	38.5

NB: An extra energy consumption of 0.5 kWh per sow place is required for extra pumping when flushing is done twice a day.
Source: [43, COM 2003]

Technical considerations relevant to applicability

See Section 4.7.1.9.

Economics

The extra annual cost for new houses equipped with flushing gutters in comparison to fully slatted floors with a deep pit is estimated at EUR 33 per animal place and the cost efficiency at EUR 23/kg of NH₃-N abated [508, TFRN 2014]. For other designs, no cost data are reported.

Driving force for implementation

See Section 4.7.1.9.

Example plants

See Section 4.7.1.9. In 2001, in Italy, about 5 000 sows were kept on FSF with gutters and 7 000 sows on FSF with tubes. Examples with partly slatted floors were found in Italy and in the Netherlands.

Reference literature

[42, Netherlands 1999] [43, COM 2003] [292, Italy 2001] [391, Italy 1999] [412, Italy 2001] [508, TFRN 2014]

4.7.2.7 Reduced manure pit (in case of a partly slatted floor)**Description**

Ammonia emissions can be reduced by applying the principle of reducing the manure surface area, in particular by applying a small manure pit with an approximate width of 0.60 m. The manure pit is equipped with triangular metal slats or concrete slats.

Substantial reductions of the channel width are possible when sows are individually housed. Urine and faeces fall at the back of the stall into the narrow pit. As a consequence, the cleanliness and the welfare for animals and workers are improved. Gilts houses need a wider pit [261, France 2010].

The slurry is usually removed via a central sewer system by opening a valve and using a sloping manure channel. Some systems are equipped with scrapers (see Section 4.7.1.5).

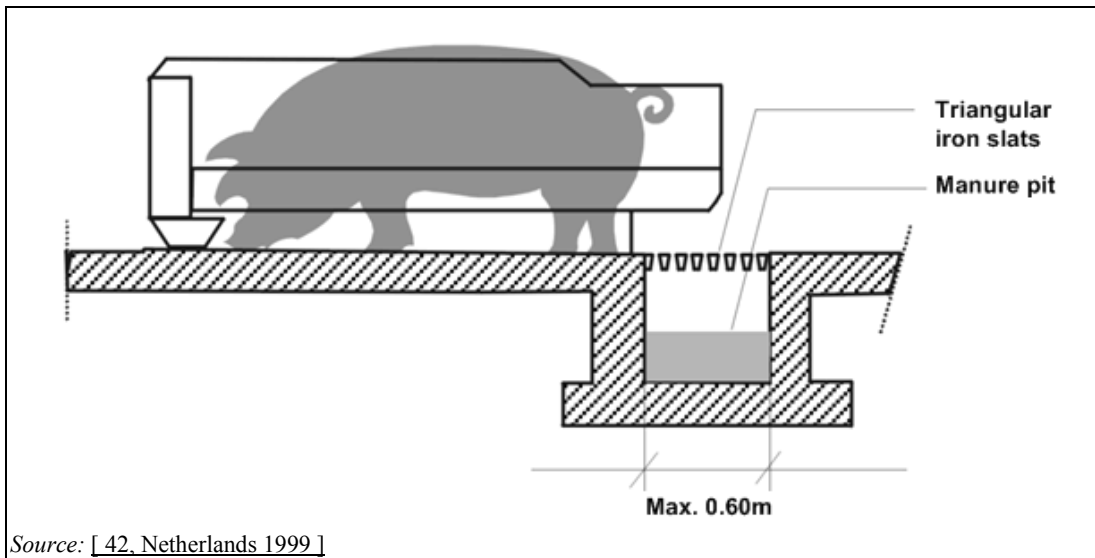

Figure 4.37: Individual housing with a small manure pit

In Italy, a house for loose gestating sows and fattening pigs was reported to be in use with a fully slatted external alley with the slurry pit underneath. Indoors, the animals are kept on a solid concrete floor and a hatched opening gives access to the external alley (see Figure 4.38). The environmental performance and operating conditions are comparable to those of the standard indoor system, but costs may be different.

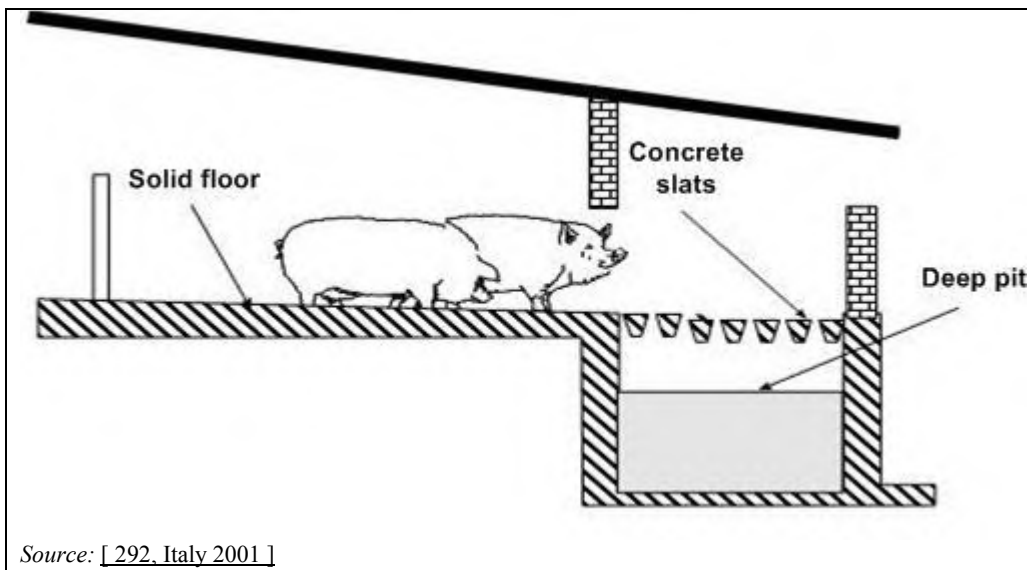

Figure 4.38: Solid concrete floor and fully slatted external alley with a storage pit underneath

Achieved environmental benefits

The reduction of emitting surfaces, attained by the smaller manure pit and the fast discharge of the manure (by using triangular slats), reduces the NH_3 emissions by 20 % to 40 %. The efficiency of the technique depends on the cleaning of the slats, otherwise there will be no positive effect.

Cross-media effects

In the case of the external slurry pit, a reduced emission will not benefit the internal environment, which can be considered one of the advantages of reducing the pit inside. A slight

increase of water consumption is associated with a reduction of the slatted floor area, due to the greater cleaning needs of the solid floor [500, IRPP TWG 2011] [261, France 2010].

Environmental performance and operational data

Reported emission data, concerning ammonia and methane, are summarised in Table 4.83. In Spain, a 49 % ammonia reduction was measured for individual housing of gestating sows [164, Spain 2010].

Table 4.83: Emissions from housing systems for gestating sows with a reduced manure pit

Housing system	NH ₃ emission	CH ₄ emission	Source
	kg/ap/yr	kg/ap/yr	
Gestating sows, group housing, solid concrete floor and external alley	2.96	NI	[43, COM 2003]
Gestating sows, individual housing, (maximum width of the pit of 0.60 m)	1.23–2.40	NI	[43, COM 2003]
	2.272 ⁽¹⁾	18.2 (1.5–55.5) ⁽¹⁾	[164, Spain 2010.]
⁽¹⁾ Measured data.			
NB: NI = no information provided.			

These houses can be naturally or mechanically ventilated. In Denmark, mechanical ventilation is applied and dimensioned for an output of a maximum of 100 m³ per hour per sow place. In areas with low outdoor temperatures, these units can also be equipped with auxiliary heating. Energy input is unchanged.

Technical considerations relevant to applicability

In existing houses, the applicability depends on the design of the existing manure pit, but it is mostly difficult, if not impossible, to apply. For existing housing with an internal solid concrete floor, an extension with an external alley with a storage pit might be possible [292, Italy 2001]. The application of a maximum width of 0.60 m may require more pit depth or more frequent removal and consequently increased outside manure storage. If a minimum pit size is imposed then, consequently, a reduction of emissions may not be possible (e.g. Ireland: > 0.90 m).

Economics

Extra costs have been calculated in Spain for the implementation of the technique (50 % reduction of the width the manure pit by reforming a fully slatted floor with a deep pit to a partly slatted floor with 50 % solid floor). Results are given in Table 4.84, including the cost efficiency of the technique. Additional emission reductions that can be achieved with increased removal frequency are not taken into account.

Table 4.84: Calculated extra costs for installing a reduced manure pit for gestating sows in existing houses with a fully slatted floor

NH ₃ emission reduction (%)	Extra cost (EUR/place per year)	Extra cost (EUR/t pig produced) ⁽¹⁾	Extra cost (EUR/kg NH ₃ reduced)	Additional reduction for frequent removal
35	5.69–6.83	2.1–3.0	6.0–7.0	25 %
⁽¹⁾ Calculated on the basis of an annual production of 2 666 kg of pig meat per gestating place.				
Source: [338, Piñeiro et al. 2009] [379, Spain 2009]				

In Belgium (Flanders), in individual housing for mating and gestating sows, the reported extra costs (including all construction works inside the pit, as well as the cost for the additional required storage capacity) for the housing construction, compared to houses with fully slatted floors and a deep pit of 1.2 m depth, are equivalent to EUR 450 per animal place in the case of

new houses, and EUR 671 per animal place for rebuilding existing housing. For group-housed sows, extra investment costs are reported to be EUR 292 per animal place in the case of new houses, and EUR 472 per animal place for retrofitting existing houses [274, BE Flanders 2010] [273, BE Flanders 2010].

Driving force for implementation

Partly slatted floors are considered to improve animal welfare. Energy savings are possible when forced ventilation is not required [292, Italy 2001].

Example plants

A common housing system for mating and gestating sows.

Reference literature

[42, Netherlands 1999] [43, COM 2003] [164, Spain 2010] [261, France 2010] [273, BE Flanders 2010] [274, BE Flanders 2010] [292, Italy 2001] [338, Piñeiro et al. 2009] [379, Spain 2009] [391, Italy 1999] [500, IRPP TWG 2011]

4.7.2.8 Kennel or hut housing (in case of a partly slatted floor)

Description

See Section 4.7.1.10 and to Figure 4.39. The activity and feeding area are placed on a perforated floor. Slurry is produced and removed at frequent intervals (every 2 to 8 weeks).

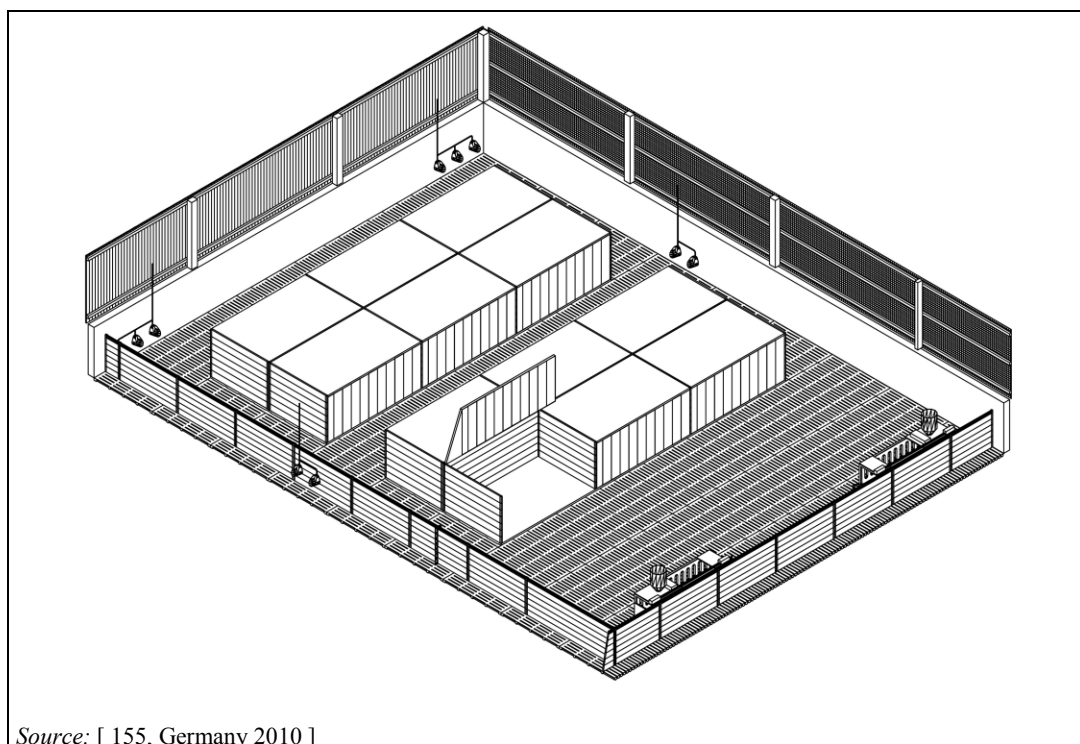
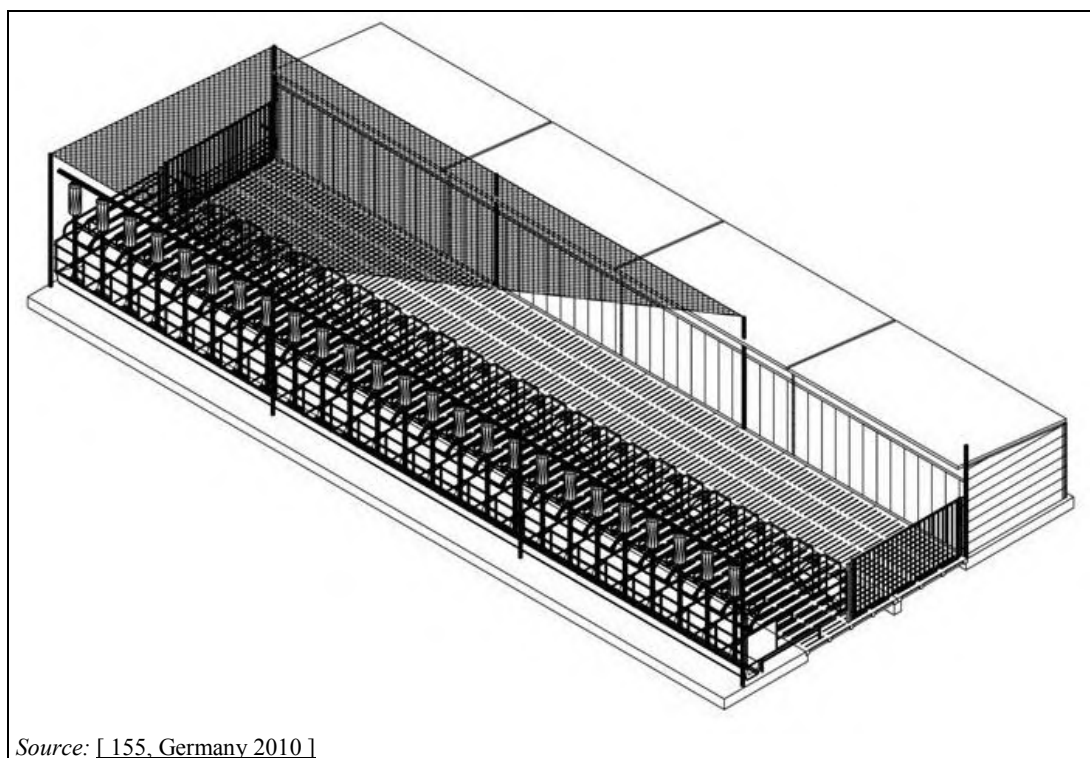

Figure 4.39: Kennel housing system for gestating sows

In a variant of the technique (see Figure 4.40), sow feeders are located in partly slatted individual stalls and the lying area in the kennels (huts) is littered. A covered yard is also combined. In this system, solid manure and slurry are produced.



Source: [155, Germany 2010]

Figure 4.40: Kennel housing for mating and gestating sows with individual feeding stalls

Achieved environmental benefits

See Section 4.7.1.10. From Germany, a reduction of 25 % of ammonia emissions is reported.

Cross-media effects

See Section 4.7.1.10

Environmental performance and operational data

The ammonia emission factor for naturally ventilated kennel housing for gestating sows in Germany is reported as 3.75 kg NH₃/ap/yr; PM₁₀ emissions are 0.22 kg/ap/yr and odour emissions 8 ou_E/s/animal [155, Germany 2010]. Data concerning energy consumption and labour requirements are presented in Table 4.85.

Table 4.85: Consumption and labour requirements for kennel housing systems for mating and gestating sows

Bedding kg/ap/yr	Electricity kWh/ap/yr	Fuel kWh/ap/yr	Cleaning water l/ap/yr	Labour h/ap/yr
140 ⁽¹⁾	16	0	250–360 ⁽¹⁾	1
⁽¹⁾ These values apply when the system with the littered hut is used.				
Source: [155, Germany 2010]				

In naturally ventilated kennel systems in Germany, mating and gestating sows are kept in groups of at least 40 animals. The reported available space per animal, applied in Germany, is 2.9 m²/sow.

Technical considerations relevant to applicability

See Section 4.7.1.10. For mating and gestating sows, forced ventilation can be applied.

Economics

No information provided.

Driving force for implementation, Example plants

See Section 4.7.1.10.

Reference literature

[155, Germany 2010]

4.7.2.9 Slurry cooling**Description**

Slurry cooling channels or slurry surface cooling fins can be used. See Section 4.7.1.7 for slurry cooling channels and Section 4.7.1.8 for surface cooling fins.

Achieved environmental benefits

See Sections 4.7.1.7 and 4.7.1.8.

Cross-media effects

See Sections 4.7.1.7 and 4.7.1.8.

Environmental performance and operational data

Danish tests with slurry cooling channels in gestating sow houses equipped with partly slatted floors and mechanical scrapers showed an ammonia reduction of 31 % for an average cooling intensity of 24 W/m² (the warmest period of 37 days in summer was omitted, as the cooling was switched off). The cooling programme was guided by the need to heat the piglet floors in farrowing pens [197, Denmark 2010]. In Denmark, the maximum ammonia emissions reduction that can be achieved in gestating sows houses with pens and a partly slatted floor is reported to be 30 %, compared to a corresponding housing system without cooling [499, AgroTech 2008]. The energy requirements for sows are in the range of 151–452 kWh per animal place per year, based on the cooling programme (see Table 4.86).

Table 4.86: Expected electricity consumption depending on the cooling programme applied

Pen design	Cooling area per pig place	10 W/m ²	20 W/m ²	30W/m ²
	m ²	kWh/ap/yr		
Group housing, partly slatted floor	1.75	151	302	452

Source: [197, Denmark 2010]

Ammonia emissions have been measured at 2.2 kg NH₃ per sow place per year for slurry cooling fins. The corresponding ammonia emission reduction is equal to 50 % in houses with partly slatted floors compared to houses with fully slatted floors with a deep pit. To achieve this performance, for individual housing, the manure surface under the slatted floors has to be adjusted to at least 1.0 m² per sow place and the ratio of the fins' cooling surface to the manure surface should be at least 115 %. For group housing, the corresponding values are 1.1 m² per sow place, and the ratio of cooling fins' surface to manure surface is 135 %. Dust and odour emissions per sow place and year are estimated at 0.22 kg and 18.7 ou_E respectively [168, Netherlands 2010] [169, Netherlands 2010] [640, Netherlands 2013].

For slurry cooling fins, the extra energy consumption is estimated at 19 kWh per gestating sow place per year for partly slatted floors [589, Netherlands 2010].

Technical considerations relevant to applicability

See Sections 4.7.1.7 and 4.7.1.8.

Economics

The extra costs for the implementation of the slurry cooling channels technique in a gestating sow house operating with a scraper system are reported from Denmark to vary between EUR -8 to EUR 38 per animal place per year. This means that a benefit of EUR 8 will be generated when 100 % of the recovered heat is used on farm to replace conventional fuels, while the cost of EUR 38/ap/yr corresponds to the situation in which no heat is utilised and a cooling effect of 30 W/m² is applied. In Denmark, the slurry cooling channels technique is reported to have lower maintenance costs, compared with other slurry cooling systems (i.e. floating surface cooling fins).

The extra investment costs for the application of surface cooling fins are calculated as EUR 110 per animal place and the extra annual costs as EUR 20 per animal place (see Table 4.78). An extra cost of EUR 19 per animal place per year for new buildings equipped with surface cooling fins and a cost efficiency of EUR 12 per kg of NH₃-N reduced are reported [508, TFRN 2014].

Driving force for implementation

See Sections 4.7.1.7 and 4.7.1.8.

Example plants

See Sections 4.7.1.7 and 4.7.1.8.

Reference literature

[160, Denmark 2010] [197, Denmark 2010] [168, Netherlands 2010] [169, Netherlands 2010] [499, AgroTech 2008] [508, TFRN 2014] [589, Netherlands 2010] [640, Netherlands 2013]

4.7.2.10 Full litter system (in case of a solid concrete floor)**Description**

Groups of sows are kept in pens on a fully concrete floor that is almost completely covered with a layer of straw or other lignocellulosic materials to absorb urine and incorporate faeces (see Figure 2.11). Solid manure is obtained, which has to be frequently removed in order to prevent the litter from becoming too moist. This housing system can have either natural or forced ventilation.

Litter is managed by the deep litter system (manure is removed at the end of the rearing period or after several successive production cycles) or the littered-floor system (manure is removed one to three times per week or more frequently and straw is replaced) [261, France 2010].

In a variant of the technique for gestating sows, reported from Germany for naturally ventilated buildings, separate functional areas are organised on a plane solid floor, combined with an external yard. The activity and lying area is on an insulated solid concrete floor covered with straw (about 1.4 m² per sow); the feeding area can be on a raised, slatted floor (producing slurry) and the external yard is on a concrete level (about 1 m² per head), fully littered with straw. Feeding and drinking systems are automatic. Manure is removed from the slatted area daily [157, Germany 2010]. The system is illustrated in the following figure (Figure 4.41).

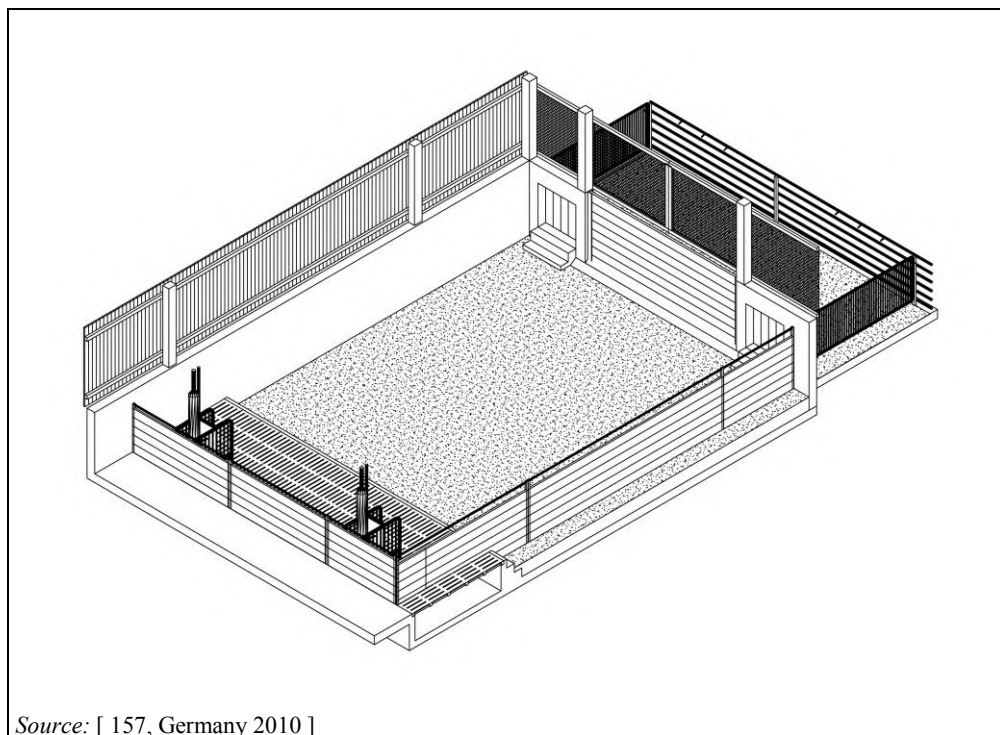

Figure 4.41: Littered floor with a slatted feeding area

In another design, the available space in the housing system is subdivided into a lying area, a dunging area on a solid floor and a feeding area. For each group of sows, a clear division between these areas should be provided. The lying area is fully littered and used by the sows as a resting area, and only a limited amount of manure spots should be present. The lying area commonly covers 1.3–1.5 m²/animal place in Belgium. The bedding has a depth of at least 0.15 m and 0.40 m at the most. The activity area consists of the following functional areas: passageway, waiting area, feeding area and drinking area. In the feeding area, electronic sow feeders (ESF) can be installed. The emitting manure surface is reported to be at a maximum 1.1 m² per animal place. In Belgium (Flanders), the total available pen area per sow is reported to be 2.5 m² maximum [186, BE Flanders 2010]. A tractor-mounted scraper is used daily to remove the manure from the solid floor area. The litter in the deep straw littered lying area is removed only once or twice a year [549, IMAG-DLO 1999]. Natural or forced ventilation can be applied.

A schematic representation of a solid concrete floor system with straw and electronic feeders is shown in Figure 4.42.

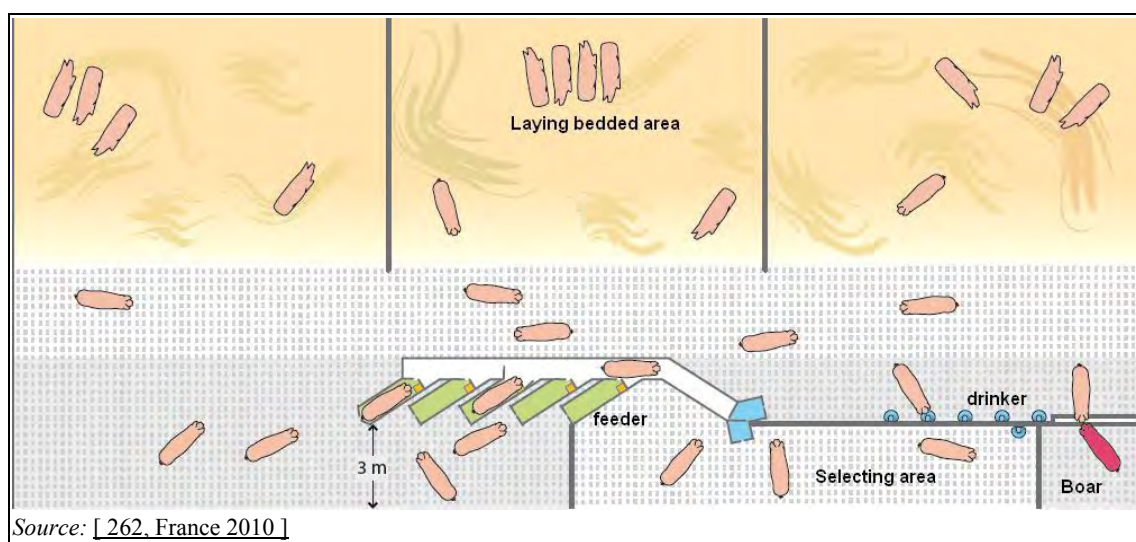

Figure 4.42: Solid concrete floor system with straw and electronic sow feeders

Another design of the technique also is applied in naturally ventilated houses for mating sows. Separate functional areas are organised: a deep littered activity area, a raised concrete feeding area, and a raised area with lockable insemination stalls; feeding and drinking systems are automatic. Group sizes are reported to be larger than 40 sows and the space per animal is 3.75 m². Solid manure is removed after each rearing period by tractor. Straw is provided each week and animals distribute it themselves [161, Germany 2010].

Achieved environmental benefits

Energy savings are achieved due to natural ventilation. The energy use is very low because this system does not usually require forced ventilation or heating.

The benefit of applying the system with separate functional areas depends on the animal behaviour, which is influenced by the pen design. Ammonia emissions are lowered by reducing the emitting manure surface, by steering the defecating behaviour of the sows and, in the cases when a slatted floor is also present, by altering the manure composition. This is achieved through a specific housing design aimed at encouraging the natural behaviour of the sows and the application of specific management of manure and straw [186, BE Flanders 2010].

Cross-media effects

The system requires increased management for handling of litter and manure removal. An increase in nitrous oxide emissions is generally expected due to the existence of aerobic and anaerobic zones in the litter, as well as higher dust emissions; reported nitrous oxide emissions vary in the range of 0.03–10 g/day [506, TWG ILF BREF 2001] [261, France 2010].

The effect of straw on methane emissions is controversial; methane emissions may increase due to the high dry matter content of manure, but aerobic conditions due to straw do not favour CH₄ production.

Environmental performance and operational data

Indicatively, in deep litter systems, fresh bedding material is added once a week, and the frequency of addition is adjusted according to the cleanliness of the litter and the season. In full litter systems, ventilation is dimensioned for a maximum output of 100 m³ per hour per sow place. Although the sows are capable of compensating for low temperatures by hiding in the deep litter mat, auxiliary heating is applied in colder parts of Europe to reduce humidity during reduced ventilation.

From Germany, the ventilation requirements for the naturally ventilated system for mating sows with separate functional areas are reported as at least 16 m³/ap/yr for the cold season and up to 220 m³/ap/yr for the warm season [161, Germany 2010].

Comparative measurements with fully slatted floor systems and a deep pit for gestating sows in Spain resulted in a reduction of ammonia and methane emissions of 14 % and 66 %, respectively, and in an increase of N₂O emissions of 178 %, for a properly managed littered system (two functional areas with weekly removal of litter) [379, Spain 2009]. In Germany, the emission factor for dust for integrated sow housing systems operating with solid manure is five times higher than for those following a slurry technique [474, VDI 2011].

Ammonia emissions of straw-based deep litter housing systems are reported in Table 4.87.

Table 4.87: Emissions of mating and gestating sows housed in littered systems

Housing system	NH ₃ emissions	PM ₁₀	Odour	Source
	kg/ap/yr	kg/ap/yr	ou _F /s/animal	
Deep litter	2.5–5.6	NI	NI	[261, France2011]
	3.7–5.2			[43, COM 2003]
Bedded lying area, separate defecating area and feeding area with electronic sow feeders	2.6	NI	NI	[186, BE Flanders2010]
	4.8 ⁽¹⁾	0.8 ⁽²⁾ ⁽³⁾	6.6 ⁽⁴⁾	[161, Germany 2010] [474, VDI 2011]
Bedded lying area, slatted defecating area	4.8 ⁽¹⁾ ⁽⁵⁾	0.8 ⁽²⁾ ⁽³⁾	6.6 ⁽⁴⁾	[157, Germany 2010] [474, VDI 2011]

⁽¹⁾ Values derived by expert judgement based on conclusions by analogy.
⁽²⁾ Measured data.
⁽³⁾ For all stages of breeding sows including piglets up to 25 kg.
⁽⁴⁾ Value calculated from an emission of 22 ou_F/s/LU, and an average weight of 150 kg per for early-pregnant or non-pregnant sows.
⁽⁵⁾ Additional emissions are likely due to emitting surfaces in the yard.
 NB: NI = no information provided.

Trials in Belgium (Wallonia) on group-housed gestating sows kept on straw deep litter have shown that feeding an *ad libitum* fibrous diet increased NH₃ emissions (3.52 kg NH₃/animal place/year) in comparison with gestating sows kept on deep litter and offered a restricted conventional diet (1.96 kg NH₃/animal place/year) [230, Philippe et al. 2009]. Resource requirements, as reported from Germany for two alternatives of the system, are presented in Table 4.88.

Table 4.88: Resources demand associated with solid floor housing systems covered with litter for mating/gestating sows, in Germany

System	Labour	Energy	Bedding material	Cleaning water	Source
	h/ap/yr	kWh/ap/yr	kg/ap/yr	l/ap/yr	
Deep litter for group-housed mating sows with separate functional areas. Natural ventilation	2.6	60	640	NI	[161, Germany 2010]
Deep litter for group-housed gestating sows with a yard and a slatted feeding area. Natural ventilation	1.8 (1.5–2)	15	420 (300–450)	220	[157, Germany 2010]

NB: NI = no information provided.

The quantity of straw required daily for gestating sows is 2.4 kg/sow for the deep litter housing system (weekly straw input and manure removal every 2 to 3 weeks, up to 1 month) and 1.7 kg/sow for the littered-floor housing system (scraping manure and adding straw once or twice a week) [262, France 2010].

Technical considerations relevant to applicability

Limitations for applying the technique were reported only for the electronic sow feeders in existing houses, for which the applicability depends on the design of the existing manure pits. The system may not be applicable to naturally ventilated plants located in warm climates.

Economics

Extra costs, as reported from Spain, in comparison with fully slatted floor systems, are shown in Table 4.89.

Table 4.89: Extra costs for the implementation of straw-littered solid floors with weekly replacement of bedding, in Spain

Production	Type of house	Extra costs	
		EUR/ap/yr	EUR/tonne pig produced
Gestating sows	New houses	72.71–80.45	27.3–30.2
	Existing houses	47.61–55.35	17.9–20.8
<i>Source: [379, Spain 2006]</i>			

Driving force for implementation

This system favours group housing. The technique improves animal welfare conditions as sows benefit from the group life, the comfortable lying area, the improved indoor conditions due to natural ventilation and the large space available for movement. Straw is a good occupational/investigation material for the animals.

Example plants

This system can be found in several Member States. In the Netherlands, more than 50 % of new buildings apply this system, and it is also implemented in retrofitted existing houses. In Belgium (Flanders), 27 farms have received authorisation for the system [300, BE Flanders 2010].

Reference literature

[43, COM 2003] [157, Germany 2010] [161, Germany 2010] [186, BE Flanders 2010] [230, Philippe et al. 2009] [261, France 2010] [262, France 2010] [300, BE Flanders 2010] [379, Spain 2009] [397, Denmark 2000] [412, Italy 2001] [474, VDI 2011] [506, TWG ILF BREF 2001] [549, IMAG-DLO 1999]

4.7.2.11 Feeding/lying boxes on a solid floor (in case of litter-based pens)

Description

Sows are housed in pens of 6 to 12 animals. Each pen is divided into two functional areas: the feeding/lying cubicles and the littered (straw) activity area. One cubicle with a solid floor is provided for each sow. The cubicles are 0.50 m to 0.65 m wide and the length of the solid floor of the cubicle is at least 1.55 m (see Figure 4.43).

At the beginning of each production cycle, the bedding area is littered with 30–40 cm of straw and, in any case, a sufficient quantity to ensure that the difference in height between the bedding area and the cubicle level is no more than 10 cm.

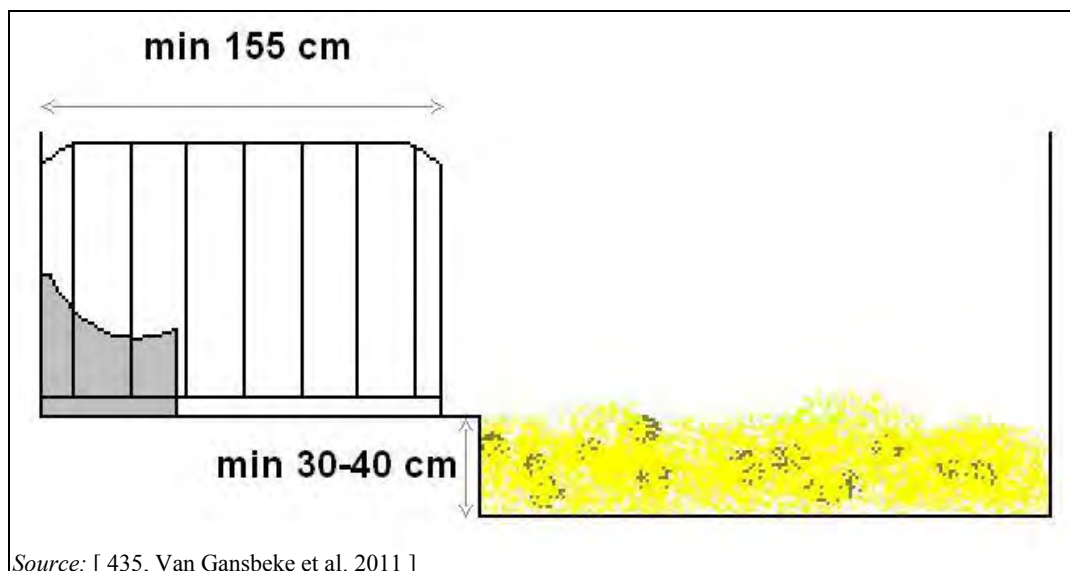

Figure 4.43: Scheme of the floor levels in litter-based pens with feeding/lying boxes

The bedded area is situated behind the feeding/lying cubicle at 0.30 m to 0.40 m below the floor level; a minimum littered surface of 1.5 m² is provided for each animal place.

Achieved environmental benefits

Lower ammonia emissions are achieved by keeping the bedding clean and dry, with regular supply and replacement of the straw.

Cross-media effects

It is generally considered that inefficient management of the bedding may lead to increased greenhouse gas emissions.

Environmental performance and operational data

Topping up of straw is done at least three times a week, so that no wet manure spots emerge in the bedding area. The bedding material is replaced every 5 weeks or when it reaches the maximum height of 50 cm. The total consumption of straw is estimated at around 2 kg per sow per day. A reported ammonia emissions factor for this housing system is 1 kg NH₃ per animal place per year (indicative measurements) [186, BE Flanders 2010].

Technical considerations relevant to applicability

The system can be applied in all new housing. It is not applicable to existing buildings without solid concrete floors.

Economics

No information provided.

Driving force for implementation

Compliance with Directive 2008/120/EC.

Example plants

In Belgium (Flanders), the system is applied in 18 farms (including farms above and below the capacity threshold set by Directive 2010/75/EU, Annex I).

Reference literature

[435, Van Gansbeke et al. 2011]

4.7.3 Housing systems for farrowing sows

In Europe, farrowing sows are generally housed in individual farrowing crates with metal, concrete or plastic slatted floors and a deep pit or channel underneath. In farrowing crates, sows are confined with restricted movement to prevent them lying on the piglets while the piglets are free to walk around. All houses have controlled ventilation and often a heated area for the piglets during their first few days after birth (see also Section 2.3.1.2.1).

The difference between fully and partly slatted floors is not as distinct for farrowing sows as it is for other pig categories because the sow is confined and excretion generally takes place in the same slatted area. Reduction techniques therefore focus on alterations in the manure pit [508, TFRN 2014].

Other housing systems allow free movement of the sow in individual pens with partly slatted floors to collect slurry and separate lying areas with a solid floor for the sow and the piglets (see Section 4.7.3.9). Farrowing sows are also kept in group pens on a solid concrete floor with plenty of litter. In this system solid manure is generated. No specific data are provided for such housing systems.

General information on techniques using one or a combination of measures for reducing ammonia emissions which apply to other pig categories as well is given in Section 4.7.1 and, thus, is not repeated in the following sections.

The reported ammonia emissions for techniques that are used to rear farrowing sows are summarised in Table 4.90. Data concerning emissions of dust and odour are also presented, when available.

Table 4.90: Emission levels of system-integrated housing techniques for farrowing sows

Section number	Housing system	NH ₃	PM ₁₀	Odour	Source
		kg/ap/yr		ou _E /s/animal	
4.7.3.1	Deep pit (in case of a fully slatted floor)	8.3–8.7	NI	84.4 ⁽¹⁾	[43, COM 2003]
		8.3			[508, TFRN 2014] [634, BE Flanders 2013]
		9.0 ⁽²⁾			[261, France 2010]
	Deep pit (in case of a partly slatted floor) (slurry removal once a month)	8.6 ⁽²⁾	NI	NI	[159, Austria 2010]
	Deep pit (in case of a partly slatted floor) (removal by vacuum system)	8.3 ⁽²⁾	0.16	8.0 ⁽³⁾	[171, Germany 2010] [474, VDI 2011]
4.7.3.1.1	Reduced manure pit (in case of a partly slatted floor)	NI	NI	NI	NI
4.7.3.2	Vacuum system for frequent slurry removal (in case of a fully or partly slatted floor)	NI	NI	NI	NI
4.7.3.3	Slanted walls in the manure channel (in case of a fully or partly slatted floor)	3.2	NI	NI	[186, BE Flanders 2010]
4.7.3.4	Scraper for frequent slurry removal (in case of a partly or fully slatted floor)	4–5.65	NI	NI	[43, COM 2003]
4.7.3.5	Frequent slurry removal by flushing (in case of a fully or partly slatted floor)	3.3	NI	NI	[43, COM 2003]
4.7.3.6	Slurry cooling (FSF or PSF with slurry surface cooling fins)	2.4	NI	NI	[43, COM 2003]
4.7.3.7	A combination of water and manure channels (in case of a fully slatted floor)	4	NI	NI	[43, COM 2003]
		2.9	NI	NI	[640, Netherlands 2013]
4.7.3.8	Manure pan (in case of a fully or partly slatted floor)	2.9	NI	NI	[186, BE Flanders 2010] [43, COM 2003]
4.7.3.9	Littered pens with combined manure generation	8.3 ⁽²⁾	0.16	8.0 ⁽³⁾	[172, Germany 2010] [474, VDI 2011]
⁽¹⁾ Measured data. ⁽²⁾ Values derived by expert judgement based on conclusions by analogy. ⁽³⁾ Values calculated from an odour emission of 20 ou _E /s per LU, and animal mass= 0.4 LU. NB: NI = no information provided.					

4.7.3.1 Deep pit (in case of a fully or partly slatted floor)

Description

In a forced ventilated building that is closed and insulated, individual slatted farrowing pens are equipped with crates. The floor in the farrowing crate can be fully or partly slatted. In fully slatted floors, a combination of different materials can be used for slats, e.g. plastic floors can be used for the comfort of suckling piglets. In the case of partly slatted floors, piglets are provided with a level concrete and heated nest. Slurry from the deep pit or slurry channel is removed once or twice a farrowing cycle. A scheme of the system is presented in Figure 4.44 and Figure 2.15.

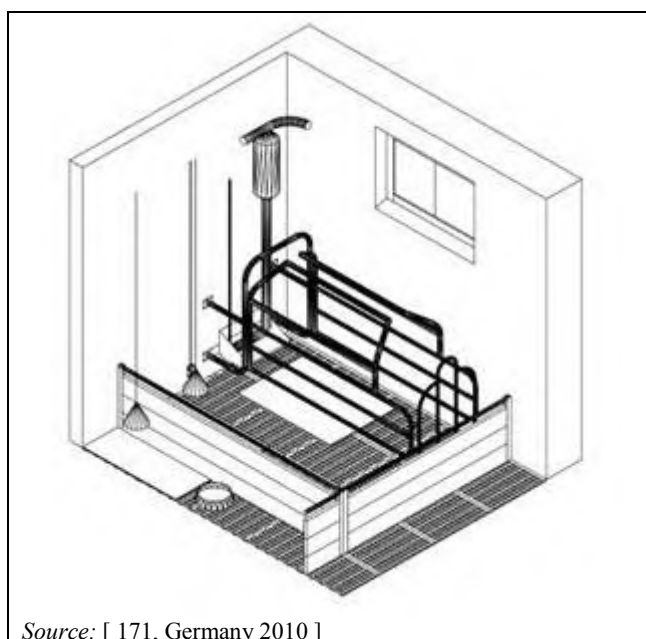

Figure 4.44: Farrowing crate with a partly slatted floor (solid floor in the lying areas)

The UK reported a variation of the standard farrowing crate (the 'Nooyen system'), which consists of a lifting farrowing crate with a movable flooring arrangement. Operated by air, the pen floor on both sides of the sow rises and falls depending on the sow's position. In particular, as soon as the sow lies down, the sow's floor will drop to the level of the piglet floor allowing piglets to suckle, and when the sows gets up again, the sow's floor will rise to a safe height; in this way the number of smothered and crushed piglets is reduced. The system design also aims to improve the ventilation and feeding management. The forced ventilation in an insulated building is controlled with real-time monitoring, with the air inlet next to the sow's snout, with cooling pipes installed under the sow and an air cooling system with a heat exchanger in place. The solid part of the floor can raise its temperature by 5 °C. Slurry is removed with a vacuum system (every 2 to 4 weeks). Suckling piglets do not have access to a nest. Feeding is controlled automatically [174, UK 2010] [494, EFSA 2007].

Achieved environmental benefits

With an improved ventilation design, fuel savings are reported, and a consequent reduction of indirect emissions from fossil fuel combustion. Ammonia emissions can be reduced if the technique is combined with other mitigation measures such as pH reduction of the slurry, slurry cooling, etc.

Cross-media effects

Housing of sows in farrowing crates severely restricts their freedom of movement which increases the risk of frustration [494, EFSA 2007]. It is anticipated that future consumer standards will not favour techniques that limit farrowing sows' freedom of movement, due to animal welfare considerations. Fixation of sows is not allowed in Sweden.

Nesting material is lacking in existing systems with fully slatted floors when the slurry system is not built for use of such nesting material; however, it is possible to use fully slatted floors in newly built farrowing systems in accordance with the provisions of Directive 2008/120/EC for the supply of suitable nesting material [494, EFSA 2007].

Environmental performance and operational data

Ammonia emissions from farrowing crates with fully slatted floors are reported to range between 8.3 kg and 9.0 kg NH₃/ap/yr [261, France 2010] [508, TFRN 2014]. From Belgium (Flanders), odour emissions are reported to be 84 ou_E/s/sow [634, BE Flanders 2013].

From Austria, an emission for NH₃ of 8.6 kg/ap/yr is reported, associated with a deep pit under a partly slatted floor (one third slatted and 2.05 m² per animal place) with a slurry removal frequency of once a month [159, Austria 2010].

In Germany, emissions for forced ventilated housing with partly slatted floors (solid lying areas for the sow and the piglets) are reported as 8.3/ap/yr for NH₃, 0.16 kg/ap/yr for PM₁₀ (for all stages of breeding sows including piglets up to 25 kg) and 8 ou_E/s/sow for odour (value derived from the reported emission factor of 20 ou_E/s/LU, for an average weight of sow with the piglets of 200 kg) [474, VDI 2011]. Ventilation rates of 22–27 m³ per animal per hour in the cold season and 125–127 m³ per animal per hour in the warm season are applied. Demand for resources is specified per animal place per year as 60 kWh for electricity, 850 litres of cleaning water, 680 kWh for piglet nest heating and 180 kWh for room heating. Labour needs are estimated at 3.9 hours per animal place per year [171, Germany 2010].

For the housing system with the lifting farrowing crate, a higher weaning weight of 1 kg is reported because of a higher feed intake. In addition, fuel savings of 40 % are reported for the system [174, UK 2010].

Technical considerations relevant to applicability

No information provided.

Economics

Costs for newly built houses are reported to be between EUR 2800 and EUR 2900 per animal place, from Germany for 180 farrowing pens, and are calculated as being equivalent to EUR 2877 per animal place in Belgium (Flanders) for a new farm with 95 farrowing pens [265, BE Flanders 2005]. For the housing system with the lifting farrowing crate, an increase in cost of at least 35 % is reported from the UK [174, UK 2010].

Driving force for implementation

Piglet mortality due to crushing has been reported to be lower in farrowing crates than in loose-housing systems, even though the primary cause of piglet mortality is often unknown [494, EFSA 2007]. The housing system offers production and technological advantages [171, Germany 2010]. For the housing system with the lifting farrowing crate and better control of ventilation and feeding management, pig health is improved and an increased weaning weight and lower mortality are achieved.

Example plants

This housing system technique is commonly applied system in Member States.

Reference literature

[159, Austria 2010] [171, Germany 2010] [174, UK 2010] [261, France 2010] [265, BE Flanders 2005] [474, VDI 2011] [494, EFSA 2007] [508, TFRN 2014] [634, BE Flanders 2013]

4.7.3.1.1 Reduced manure pit (in case of a partly slatted floor)

Description

Sows are individually housed in farrowing crates in systems with partly slatted floors with a narrow, shallow slurry pit. The design of this system is comparable with the design of the basic system (see Section 4.7.3.1) Slurry is often drained by means of discharge pipes, in which the individual sections of the manure channels are emptied via plugs. The manure channels can also be drained by means of gates. The channels are cleaned after each farrowing when the farrowing crates are disinfected, i.e. at intervals of about 4 to 5 weeks. Some manual cleaning is sometimes necessary.

This housing system is fitted with mechanical ventilation either in the form of negative pressure or balanced pressure plants. Ventilation is dimensioned for a maximum output of 250 m³ per hour per farrowing crate [397, Denmark 2000]. Ventilation can also be natural (ACNV with fan assistance in hot weather). In this case, zone heating is applied with heating elements in the floor or ceiling [173, UK 2010].

Achieved environmental benefits

A reduction of NH₃ emission is expected due to the reduction of the emitting slurry surface area. From Denmark, it is reported that systems for farrowing sows with partly slatted floors and a reduced manure pit have about half the emissions of systems with fully slatted floors [500, IRPP TWG 2011]. In ILF BREF, an ammonia reduction efficiency of 34 % was reported for the technique [43, COM 2003].

Cross-media effects

See Section 4.7.3.1.

Environmental performance and operational data

No information provided.

Technical considerations relevant to applicability

It is assumed that in existing houses the applicability will depend on the design of the existing manure pit, but that it is generally difficult, if not impossible, to apply.

Economics

In the UK, the investment cost for a new farm with ACNV for farrowing sows is around EUR 2 500 per farrowing crate, including building costs but not labour [173, UK 2010].

Driving force for implementation

See Section 4.7.3.1 for farrowing crates. The solid floor offers benefits in terms of animal welfare. For the system design with natural ventilation a better pig health, higher weaning weights and lower mortality is reported by the UK.

Example plants

This technique is widely practised in Denmark. The design with natural ventilation is common in the UK.

Reference literature

[43, COM 2003] [173, UK 2010] [397, Denmark 2000] [500, IRPP TWG 2011]

4.7.3.2 Vacuum system for frequent slurry removal (in case of a fully or partly slatted floor)

See Section 4.7.1.2 and Section 4.7.3.1 for farrowing crates.

4.7.3.3 Slanted walls in the manure channel (in case of a fully or partly slatted floor)

Description

Slurry is collected in a manure channel which has two sloped side walls in order to reduce the emitting surface; the back side wall has a slope of 60 ° and the front side wall a slope of 45 ° in relation to the bottom of the manure channel. Slurry is removed from the housing every 2 days by means of a discharge system. See also Section 4.7.1.4 and Section 4.7.3.1 for farrowing crates.

At the bottom of the manure channel there are discharge openings (at a maximum distance of two metres). Slurry is discharged before the slurry level reaches a height of 10 cm. To guarantee this height, an overflow is provided in the manure channel. A layer of slurry of 2 cm always remains in the channel to avoid manure sticking to it.

Achieved environmental benefits

See Section 4.7.1.4.

Cross-media effects

See Section 4.7.1.4 and Section 4.7.3.1.

Environmental performance and operational data

Associated ammonia emissions with the technique are reported as 3.2 kg NH₃/ap/yr [186, BE Flanders 2010].

Technical considerations relevant to applicability

In existing houses, the applicability depends on the dimensions of the existing manure pit.

Economics

No information provided.

Driving force for implementation

No information provided. See Section 4.7.3.1 for farrowing crates.

Example plants

The technique is used in Belgium (Flanders) as a low-NH₃ emission housing system.

Reference literature

[186, BE Flanders 2010]

4.7.3.4 Scraper for frequent slurry removal (in case of a fully or partly slatted floor)

Description

See Section 4.7.1.5 and Figure 4.45. Also, see Section 4.7.3.1 for farrowing crates.

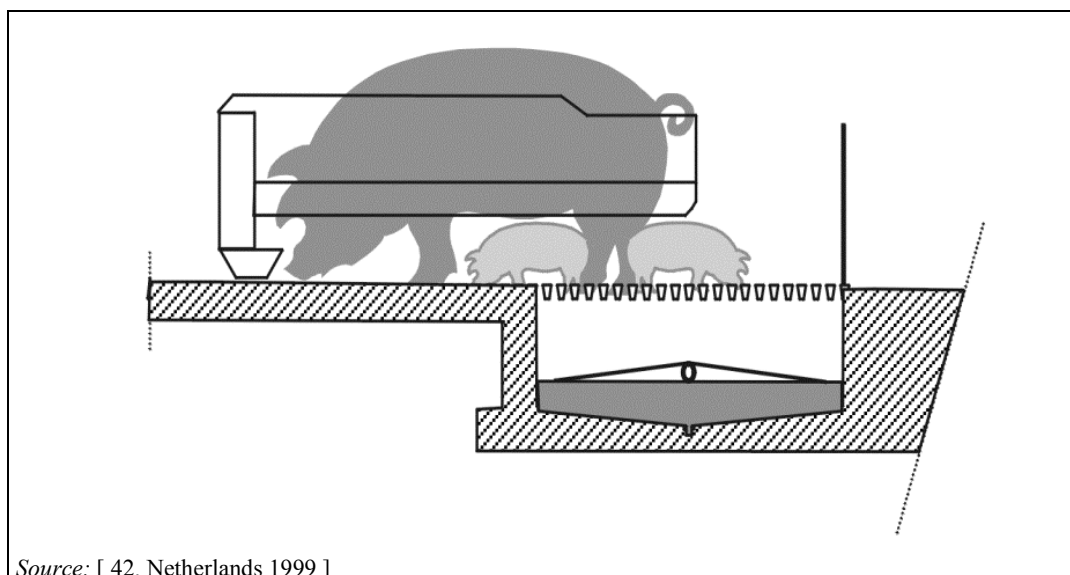

Figure 4.45: Farrowing crate with a manure scraper (in case of a partly slatted floor)

Achieved environmental benefits

See Section 4.7.1.5. A reduction in NH_3 emissions is achieved by reducing the slurry surface and by the frequent scraping of slurry and draining of the urine.

Cross-media effects

The power consumption of scraping varies with the frequency, with it being reported as 2.4 kWh (Italy) and 3.5 kWh (Netherlands) per sow per year. See also Section 4.7.1.5 for cross-media effects related to farrowing crates; for fully slatted floors, see Section 4.7.3.1.

Environmental performance and operational data

Ammonia emissions for the partly slatted design are 35 % (5.65 kg NH_3 per sow place per year (Italy)) to 52 % (4.0 kg NH_3 per sow place per year (Netherlands and Belgium)).

Technical considerations relevant to applicability

See Section 4.7.1.5.

Economics

No information provided.

Driving force for implementation

See Section 4.7.1.5 and Section 4.7.3.1 for farrowing crates.

Example plants

A few in the Netherlands although it is no longer applied in new buildings. Scrapers in France are only associated with fully slatted floors [261, France 2010].

Reference literature

[42, Netherlands 1999] [261, France 2010] [391, Italy 1999] [412, Italy 2001]

4.7.3.5 Frequent slurry removal by flushing (in case of a fully or partly slatted floor)

Description

See Section 4.7.1.9 and to Section 4.7.3.1 (farrowing crates). Application is possible in pens with a partly or fully slatted floor.

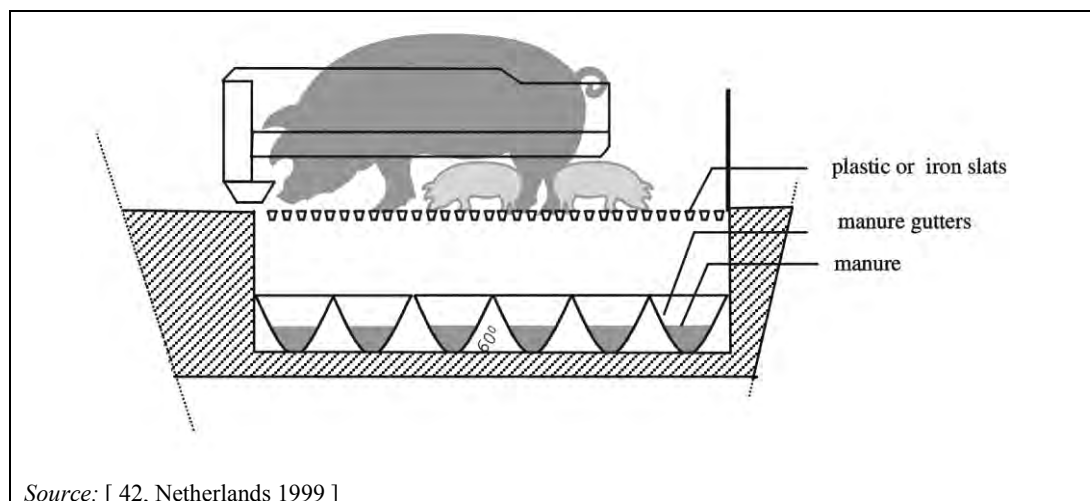

Figure 4.46: Flushing system with a manure gutter

Achieved environmental benefits

See Section 4.7.1.9.

Cross-media effects

See Section 4.7.1.9. For cross-media effects related to farrowing crates and fully slatted floors, see Section 4.7.3.1.

Environmental performance and operational data

Reducing the manure surface in the manure channel, in combination with the fast discharge of the manure from the slatted area by using triangular plastic or iron bars, and removal of the manure twice a day by flushing reduce NH_3 emissions by 60 % (3.3 kg NH_3 per sow place per year (Netherlands and Belgium)). However, data for other pig categories (fattening pigs and mating/gestating sows) suggest a 40 % emission reduction with the flushing gutters technique [508, TFRN 2014]. This system has an extra energy consumption of 8.5 kWh per sow place per year, relative to the flushing of the gutters.

Technical considerations relevant to applicability

See Section 4.7.1.9.

Economics

No information provided.

Driving force for implementation

See Section 4.7.1.9.

Example plants

See Section 4.7.1.9.

Reference literature

[42, Netherlands 1999] [508, TFRN 2014]

4.7.3.6 Slurry cooling

Description

Slurry cooling channels or slurry surface cooling fins can be used. See Section 4.7.1.7 for slurry cooling channels and Section 4.7.1.8 for slurry surface cooling fins.

Achieved environmental benefits

See Section 4.7.1.7 and Section 4.7.1.8.

Cross-media effects

See Section 4.7.1.7 and Section 4.7.1.8.

Environmental performance and operational data

The ammonia emission factor associated with the surface cooling fins technique in the Netherlands is 2.4 kg NH₃/ap/yr which corresponds to a 70 % ammonia emission reduction efficiency (150 % cooling fins' surface/slurry surface). From another source [508, TFRN 2014], the reduction achieved for the technique for farrowing sows is reported to be 45 %. The extra energy consumption is estimated as 73 kWh per farrowing sow place per year for surface cooling fins [589, Netherlands 2010]. No information is provided for slurry cooling channels.

Technical considerations relevant to applicability

See Section 4.7.1.7 and Section 4.7.1.8.

Economics

The extra investment costs for implementation of surface cooling fins in comparison with farrowing pens with fully slatted floors and 4.5 m² per pen are calculated as EUR 240 per animal place and the extra annual costs as EUR 40 per animal place (See Table 4.78). An extra cost of EUR 45 per animal place per year for new buildings and a cost efficiency of EUR 15 per kg of NH₃-N reduced are reported [508, TFRN 2014]. No information is provided for slurry cooling channels.

Driving force for implementation

See Section 4.7.1.7 and Section 4.7.1.8.

Example plants

See Section 4.7.1.7 and Section 4.7.1.8.

Reference literature

See Section 4.7.1.7 and Section 4.7.1.8.

4.7.3.7 A combination of water and manure channels (in case of a fully slatted floor)**Description**

The sow has a fixed place and as a result the defecating area is clearly identified. The manure pit is split up into a wide water channel at the front and a small manure channel at the back (see Figure 4.47 and Figure 4.48) with a reduced emitting slurry surface. In this way, the manure surface is greatly reduced, which in turn reduces ammonia emissions. The front channel is partly filled with water. The slats are made of metal or plastic.

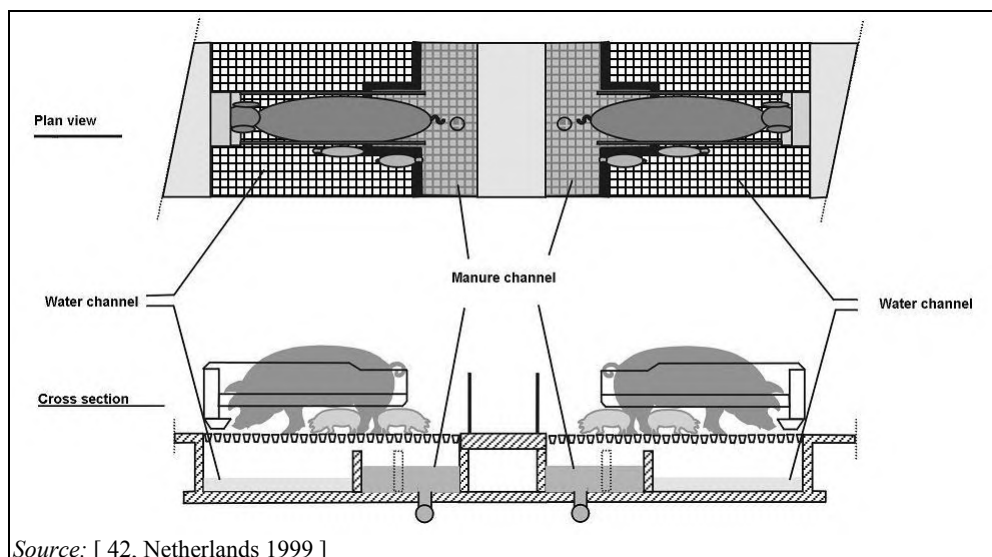

Figure 4.47: Combination of water and manure channels



Figure 4.48: Shallow slurry pits separating manure and water channels during construction

Achieved environmental benefits

The achieved environmental benefit is the reduced ammonia emission due to the limited emitting manure surface and frequent slurry removal by a discharge system.

Cross-media effects

See Section 4.7.3.1 for farrowing crates and fully slatted floors. The frequent removal of the slurry may require extra energy. Water is needed to fill the front pit.

Environmental performance and operational data

An emission level of 4.0 kg NH₃ per sow place per year (Netherlands and Belgium) can be achieved, which is more than 50 % lower, in comparison with the typical emission levels of 8.3–8.6 kg NH₃ per sow place per year reported for a crate housing system with a partly slatted floor with a deep pit. A 50 % ammonia emission reduction is reported for the technique [508, TFRN 2014]. In the Netherlands, the emission factor associated with the technique is 2.9 kg NH₃ per place per year [640, Netherlands 2013].

Supposedly the two pits are emptied into the same slurry sewerage system towards the slurry store. Water is changed after each cycle (approximately every 4 weeks). The front section is drained completely, cleaned, disinfected and then filled up again with fresh water.

Technical considerations relevant to applicability

For retrofitting this system into existing buildings equipped with fully slatted floors, the design of the pen is not critical in itself but the implementation depends on the conditions of the pit. Openings to a discharge system (e.g. tubing) are required to be placed underneath each crate. This means that the entire existing manure pit has to be removed and rebuilt in order to construct the discharge system and the openings. Proper support has to be considered when digging operations need to be performed near the load-bearing walls.

In cases where the existing house has crates with partly slatted floors, new crates have to be installed as the existing crates (fixed on the previous portion of solid floor) can no longer be used.

Economics

Investment cost data for a fully slatted floor housing system with water and manure channels in the slurry pit, as reported from Belgium (Flanders), are presented in the Table 4.91. Calculations are based on a compartment with 95 farrowing pens. Investment costs are 15 % higher than for a system with a fully slatted floor and a deep pit; extra investment costs are equivalent to EUR 433 per farrowing pen in new farms. Included in this extra cost is the cost of an additional storage volume consisting of a concrete storage tank of 300 m³, to compensate for the reduced slurry storage volume underneath the slats. Without the additional storage, the extra costs would be equivalent to EUR 316 per farrowing place.

Table 4.91: Investment costs reported for a fully slatted floor housing system with water and manure channels, in comparison with a fully slatted floor system with a deep pit

Parameter	Building costs	Additional costs	Total
	EUR/sow place		
Deep pit (conventional system)	1 354	1 523	2 877
Water and manure channels	1 354	1 956	3 310
Extra cost	0	433	433

Source: [265, BE Flanders 2010]

From Belgium (Flanders), cost data for the retrofitting of the technique in existing houses are also reported which amount to EUR 2434 per sow place for fully slatted floors and EUR 4565 per sow place for partly slatted floors [274, BE Flanders 2010].

Extra costs for the implementation of the technique, in comparison to crates with fully slatted floors with a deep pit, are reported from Spain and the cost efficiency is calculated for the measured ammonia abatement. Figures are given in Table 4.92.

Table 4.92: Extra costs for installing in FSF a combination of water and manure channels compared to a deep pit

Housing	Ammonia emissions reduction	Extra costs		
	%	EUR/ap/yr	EUR/tonne pig produced ⁽¹⁾	EUR/kg NH ₃ reduced
Retrofitting existing house	52	16.74–20.09	2.1–2.5	8.63–10.36
New house		3.29–3.95	0.4–0.5	1.70–2.04

⁽¹⁾ The pig meat produced is calculated on the basis of 8 000 kg of yearly production per farrowing sow place.

Source: [379, Spain 2009] [338, Piñeiro et al. 2009]

An extra cost of EUR 2 per animal place per year for new buildings and a cost efficiency of EUR 0.5 per kg of NH₃-N reduced are reported [508, TFRN 2014].

Driving force for implementation

See Section 4.7.3.1 for farrowing crates. The technique is relatively easy to implement in existing buildings.

Example plants

In Belgium (Flanders), 157 farms are equipped with this system (including farms above and below the capacity threshold set by Directive 2010/75/EU) [300, BE Flanders 2010]. In the province of North Brabant in the Netherlands, 126 farms with farrowing sows are equipped with the system.

Reference literature

[22, Bodemkundige Dienst 1999] [42, Netherlands 1999] [265, BE Flanders 2005] [274, BE Flanders 2010] [300, BE Flanders 2010] [338, Piñeiro et al. 2009] [379, Spain 2009] [500, IRPP TWG 2011] [508, TFRN 2014] [640, Netherlands 2013]

4.7.3.8 Manure pan (in case of a fully or partly slatted floor)

Description

A prefabricated container (pan) is placed under the slatted floor to collect slurry. Its dimensions have to encompass the entire slatted area (see Figure 4.49). The manure pan consists of a shallow recipient with a slope of at least 3 ° and slurry drainage at the lowest point towards a central slurry channel connected to a sewerage system. The slurry is discharged before its level reaches 12 cm. A reachable and clearly visible overflow drain assures the level is maintained. The pan can be subdivided into a water channel and a manure channel. Manure pans are made of smooth, corrosion-resistant, nonadhesive (to manure) and easy-to-clean material. A farrowing crate is combined with this system.

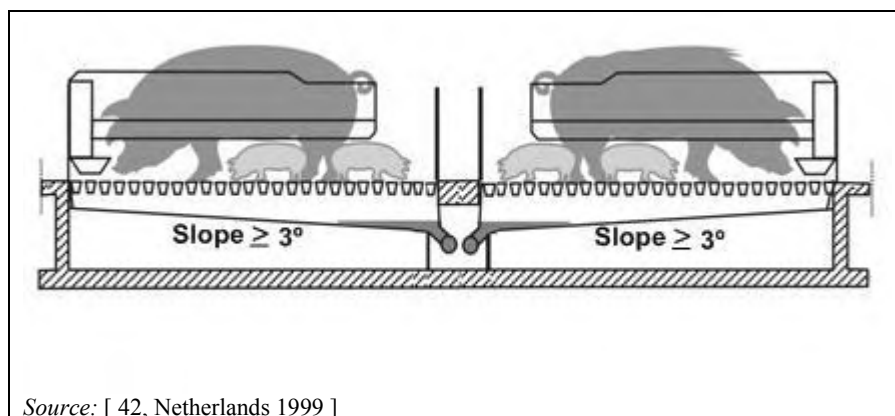

Figure 4.49: A manure pan (in case of fully slatted floor)

The inner diameter of the discharge openings should be at least 90 mm and the diameter of the discharge tube should be at least 110 mm. Where a dedicated water channel is in place, the level of the water needs to be maintained at at least 5 cm at all times. In addition, at the end of each production cycle the water and manure channels have to be discharged, after which the crate can be cleaned.

Achieved environmental benefits

Ammonia emissions are lowered by reducing the emitting manure surface to a maximum of 0.8 m² per animal place and by providing a manure pan with water and manure channels

underneath the crate. Frequent removal of the slurry by a sewerage system also contributes to a reduction of ammonia emissions. Overall, a reduction of 65 % in NH₃ emissions is achieved, in comparison with the emission of 8.3 kg NH₃/ap/yr associated with the technique of crate housing with a slatted floor and a deep pit. An ammonia emission reduction of 65 % for the technique is also reported by the UNECE guidance document for ammonia mitigation [508, TFRN 2014].

Cross-media effects

See Section 4.7.3.1 for farrowing crates and fully slatted floors. This technique typically has problems with flies.

Environmental performance and operational data

Emissions of 2.9 kg NH₃ per sow place per year were reported from the Netherlands and Belgium (Flanders). From trials carried out in Spain, the measured ammonia emissions reduction is reported to be 32 % compared to control pens with fully slatted floors with a deep pit. Ventilation requirements have been reported from Spain as 325 m³/h/ap for the warm season, with a maximum of 465 m³/h/ap.

Technical considerations relevant to applicability

The application does not depend on the pen design (e.g. crates placed either straight or diagonally) or on whether it is with a fully or a partly slatted floor. Although this system is easy to implement in retrofits of existing buildings, as well as in new buildings, in practice it may be costly to alter the slurry drainage system [508, TFRN 2014].

Economics

The extra costs have been calculated in Spain and are stated in Table 4.93. A comparison is made between fully slatted floors pens with a manure pan and control pens with fully slatted floors with a deep pit. The cost efficiency is also reported for a measured ammonia abatement of 32 %.

Table 4.93: Extra costs for installing in a FSF a manure pan in comparison to a deep pit, in Spain

Housing	Ammonia emissions reduction	Extra costs		
	%	EUR/ap/yr	EUR/tonne pig produced	EUR/kg NH ₃ abated
New house	32	17.52–21.02	2.2–2.6	14.7–17.62
Retrofitting existing house		30.98–37.18	3.9–4.6	26–31.23

Source: [170, Spain 2007] [379, Spain 2009] [338, Piñeiro et al. 2009]

In the Netherlands, the reported extra investment costs compared to the standard system are EUR 270 per animal place, and the annual costs are equivalent to EUR 40/ap/yr (including depreciation, interest, maintenance and all other operating costs, such as energy). In the case of a manure pan with water and manure channels, extra investment costs are reported as EUR 295 per animal place, and annual costs as EUR 40/ap/yr [589, Netherlands 2010].

An extra cost of EUR 40 to 45 per animal place per year for new buildings and a cost efficiency of EUR 9 per kg of NH₃-N reduced are reported [508, TFRN 2014].

Driving force for implementation

See Section 4.7.3.1 for farrowing crates. The technique is relatively easy to implement in existing buildings.

Example plants

In the Netherlands this system has been implemented in many retrofits, as well as in new buildings. In the province of North Brabant alone, 126 farms with farrowing sows are equipped with this system.

Reference literature

[42, Netherlands 1999] [170, Spain 2007] [186, BE Flanders 2010] [338, Piñeiro et al. 2009] [379, Spain 2009] [508, TFRN 2014] [589, Netherlands 2010]

4.7.3.9 Littered pens with combined manure generation (slurry and solid manure)

Description

Farrowing pens are equipped with separate functional areas: the lying area is bedded, the walking and defecating dung areas have slatted or perforated floors and the feeding area is on a solid floor. Piglets are provided with a littered and covered nest. Slurry is frequently (e.g. daily) removed under the slatted floor with a scraper. Solid manure is manually removed from the solid floor areas on a daily basis. Litter is provided regularly. A yard can be combined with the system.

A schematic representation of a housing system with littered pens with a yard is presented in Figure 4.50.

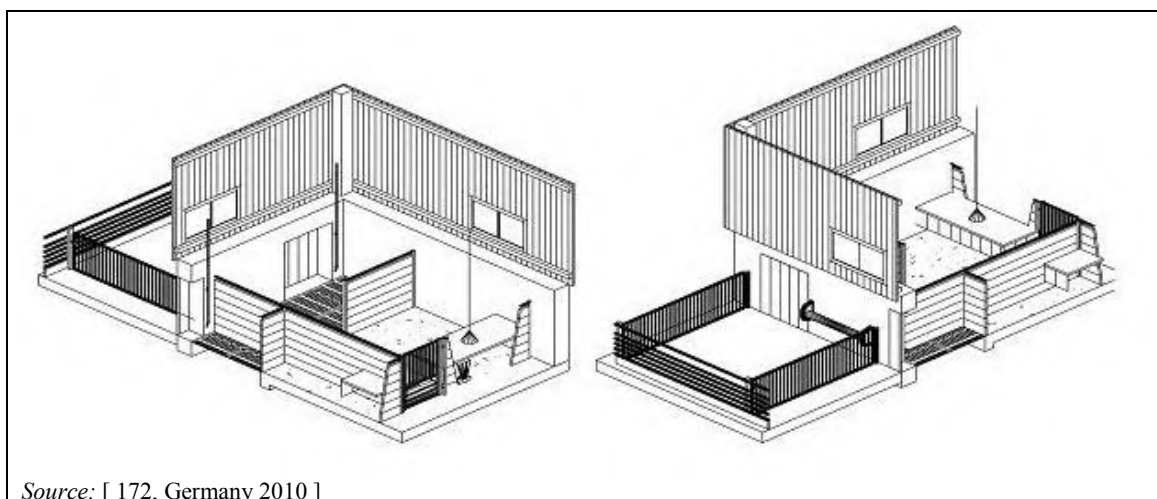

Figure 4.50: Littered farrowing pens with a yard

Achieved environmental benefits

No difference is reported in comparison to the commonly applied system with farrowing crates and a deep pit.

Cross-media effects

The system implies an increased risk of death for piglets especially in the first few hours after farrowing [624, IRPP TWG 2013]. Increased management requirements (e.g. frequent littering and regular cleaning of the yard). Additional emissions are likely due to emitting surfaces in the yard.

Environmental performance and operational data

In Germany, emissions are assumed to be 8.3 kg ammonia per animal place per year, 0.16 kg PM₁₀ dust per animal place per year (for all stages of breeding sows including piglets up to 25 kg) and 8 ou_E/s per sow (value derived from the reported emission factor of 20 ou_E/s/LU and

an average weight of a sow with piglets of 200 kg) [474, VDI 2011]. Ventilation is applied at rates of 22–27 m³/h/animal in the cold season and 125–187 m³ h/animal in the warm season. It is necessary to provide around 180 kg of bedding each year to the 7 m² of space per sow.

Technical considerations relevant to applicability

When retrofitting, applicability depends on the specific design of the existing pen.

Economics

The technique entails additional labour costs for daily mucking out, as well as the extra cost of the increased straw usage.

Driving force for implementation

The bedded housing improves animal welfare. A yard is mandatory in organic farming.

Example plants

This system is the standard for organic farming in Germany.

Reference literature

[172, Germany 2010] [474, VDI 2011] [624, IRPP TWG 2013]

4.7.4 Housing systems for weaners

Emissions associated with the techniques related to the rearing of weaners (also known as weaned piglets) are summarised in Table 4.94. Data concerning emissions of methane, nitrous oxide, dust and odour are also presented, when available.

Table 4.94: Emission levels of system-integrated housing techniques for weaners

Section number	Housing system	NH ₃ emission	CH ₄	PM ₁₀	Odour	Source
		kg/ap/yr	kg/ap/yr	kg/ap/yr	ou _E /s/animal	
4.7.4.1	Deep pit (in case of a fully slatted floor)	0.6–0.8 0.78 ⁽¹⁾ 0.60–0.75	NI	0.074	12.1	[43, COM 2003] [261, France 2010] [634, BE Flanders 2013]
4.7.4.2	Vacuum system for frequent manure removal (in case of a fully slatted floor)	0.5 ⁽²⁾ (0.2–0.7) 0.06–0.40 ⁽³⁾	2.81–5.86	0.08	3 ⁽⁴⁾	[182, Germany 2010] [180, Spain 2010]
4.7.4.3	Vacuum system for frequent manure removal (in case of a partly slatted floor)	0.39–0.60	NI	NI	NI	[43, COM 2003]
4.7.4.4	Slanted walls in the manure channel (in case of a fully or partly slatted floor)	0.17 ⁽¹⁾ 0.029–0.324 ⁽³⁾	1.8–5.98	NI	NI	[640, Netherlands 2013] [179, Spain 2010]
4.7.4.5	Scraper (in case of a partly slatted floor) Scraper (in case of a fully slatted floor)	0.18–0.36 0.39	NI	NI	NI	[43, COM 2003]
4.7.4.6	Frequent slurry removal by flushing, with: - non-aerated flush - aerated flush	0.36 (non-aerated flush) 0.30 (aerated flush)	NI	NI	NI	[43, COM 2003]
4.7.4.7	kennel or hut housing (in case of a partly slatted floor)	0.38 ⁽²⁾ (0.2–0.7) ⁽¹⁾	NI	0.08	3 ⁽⁴⁾	[183, Germany 2010]
4.7.4.8	Straw flow system (in case of a solid concrete floor)	0.21 ⁽²⁾	NI	NI	NI	[535, UK 2011]
4.7.4.9	Convex floor and separated manure and water channels (in case of partly slatted pens)	0.26 (frequent discharge) 0.21 (flushing) 0.20 (discharge) 0.14–0.22 (slanted walls) ⁽³⁾	NI	0.132 (slanted walls)	5.4 (slanted walls)	[43, COM 2003] [186, BE Flanders 2010] [176, Netherlands 2010]
4.7.4.10	Manure surface cooling fins (in case of a fully or partly slatted floor)	0.15	NI	NI	NI	[43, COM 2003]
4.7.4.11	Pens for weaning pigs, with a partly slatted floor	0.53 (two-climate system)	NI	NI	NI	[43, COM 2003]
		0.34 (with convex or sloped floor)	NI	NI	NI	[43, COM 2003]
		0.5 ⁽¹⁾ (0.2–0.7) ⁽³⁾	NI	0.08	3 ⁽⁴⁾	[184, Germany 2010]
4.7.4.12	Pens or flat decks with fully slatted flooring and a concrete sloped underground floor to separate faeces and urine	0.42	NI	NI	NI	[43, COM 2003]
4.7.4.13	Manure collection in water	0.13 ⁽³⁾ –0.16 ⁽¹⁾	NI	0.132	5.4	[177, Netherlands 2010] [608, Netherlands 2010]
		0.13–0.15 ⁽³⁾	0.28–0.30	NI	NI	[147, Cabaraux et al. 2009]

Section number	Housing system	NH ₃ emission	CH ₄	PM ₁₀	Odour	Source
		kg/ap/yr	kg/ap/yr	kg/ap/yr	ou _E /s/animal	
4.7.4.14	Full litter system (in case of a solid concrete floor)					
	Full litter and forced or natural ventilation. Manure removal at the end of the cycle	0.5 ⁽¹⁾ (0.2–0.7) ⁽²⁾	NI	NI	3 ⁽⁴⁾	[181, Germany 2010]
	Full litter and forced ventilation: - straw (manure removal after 5 cycles) - sawdust (manure scatter every 10 days)	0.43 ⁽¹⁾ 0.11 ⁽¹⁾	0.60 0.29	NI	NI	[532, Nicks et al. 2002]
	Full litter and forced ventilation: - straw (manure removal after 2 cycles) - sawdust (manure scatter every 10 days and manure removal after 2 cycles)	0.25 ⁽³⁾ 0.22 ⁽³⁾	0.70 0.48			[147, Cabaraux et al. 2009]
⁽¹⁾ Values derived from measurements. ⁽²⁾ Values derived by expert judgement based on conclusions by analogy. ⁽³⁾ Measured values. ⁽⁴⁾ Calculation based on an emission factor of 75 ou _E /LU per second and an average weight of 20 kg. NB: NI = no information provided.						

4.7.4.1 Deep pit (in case of a fully or partly slatted floor)

Description

Weaners are group-housed in pens or on flat decks (raised pens). The system is a combination of the classic pen with a fully slatted floor or partly slatted floor with slats made of plastic or metal elements, with slurry removal at the end of the cycle. This type of housing is equipped with mechanical ventilation, either negative-pressure or balanced-pressure ventilation. Auxiliary heating is also applied in the form of gas radiant heaters, electric fan or convection heaters or by a central heating plant with heating pipes.

Achieved environmental benefits

See Section 4.7.1.1 for fully slatted floors and Section 4.7.1.1.1 for partly slatted floors.

Cross-media effects

See Section 4.7.1.1 for fully slatted floors and Section 4.7.1.1.1 for partly slatted floors.

Environmental performance and operational data

The associated emission factor in the UNECE guidance document on 'Options for ammonia mitigation' is equal to 0.65 kg NH₃/animal place/yr [508, TFRN 2014].

In France, measured ammonia emissions in fully slatted floor systems with a deep pit for weaners are between 70 mg/h and 120 mg/h per weaned piglet, with an average of 97 mg/h. This figure corresponds to 130 grams per piglet produced in the 56 days of the cycle (6 batches/yr), equivalent to 0.78 kg NH₃ per weaner place per year [261, France 2010]. Measured NH₃ emissions for the system with a fully slatted floor reported by Belgium (Flanders) are 0.6–0.75 kg NH₃/animal place/yr and odour emissions 12.1 ou_F/animal/s [634, BE Flanders 2013] [638, BE Flanders 2014].

Table 4.95 presents ventilation rates reported from Spain, Belgium (Flanders) and Germany applied to houses with fully slatted floors.

Table 4.95: Ventilation rates (m³/h per animal place) applied to weaner houses with fully slatted floors

Cold season			Warm Season		
Spain	Germany	Belgium (FL)	Spain	Germany	Belgium (FL)
18.2 (7.5–57.8)	3.5–7.0	2–6	39.2 (10.7–50.3)	20–50	10–18
<i>Source: [179, Spain 2010] [182, Germany 2010] [637, BE Flanders 2012]</i>					

Technical considerations relevant to applicability

See Section 4.7.1.1 for fully slatted floors and Section 4.7.1.1.1 for partly slatted floors.

Economics

Investment costs for a new house for weaners with a partly slatted floor (0.4 m² total surface per animal) are reported to be between EUR 210 and EUR 240 per animal place [589, Netherlands 2010].

Driving force for implementation

See Section 4.7.1.1 for fully slatted floors and Section 4.7.1.1.1 for partly slatted floors.

Example plants

Commonly applied technique.

Reference literature

[179, Spain 2010] [182, Germany 2010] [261, France 2010] [508, TFRN 2014] [589, Netherlands 2010] [634, BE Flanders 2013] [637, BE Flanders 2012] [638, BE Flanders 2014]

4.7.4.2 Vacuum system for frequent slurry removal (in case of fully slatted floor)**Description**

See Section 4.7.1.2.

Achieved environmental benefits

See Section 4.7.1.2. A reduction of 25 % for NH₃ emissions is reported due to frequent removal of slurry in comparison with a fully slatted floor system with a deep pit [508, TFRN 2014].

Cross-media effects

See Section 4.7.1.2.

Environmental performance and operational data

An emission factor of 0.5 kg NH₃/ap/yr is associated with the system in Germany when plastic slats are used with a slurry removal frequency of 4 to 8 weeks. A shorter manure removal interval can also be applied (2 weeks) [182, Germany 2010]. From Spain, ammonia emissions of up to 0.4 kg NH₃/ap/yr were measured for a weekly removal [180, Spain 2010]. See also Section 4.7.1.2.

Technical considerations relevant to applicability

See Section 4.7.1.2.

Economics

Investment costs for the implementation of this housing system for weaners are equivalent to EUR 195/ap/yr; the corresponding annualised investment costs are EUR 18 per animal place per year [182, Germany 2010]. See also Section 4.7.1.2.

Driving force for implementation

See Section 4.7.1.2.

Example plants

See Section 4.7.1.2.

Reference literature

[180, Spain 2010] [182, Germany 2010] [508, TFRN 2014]

4.7.4.3 Vacuum system for frequent slurry removal (in case of partly slatted floor)**Description**

See Section 4.7.1.3.

Achieved environmental benefits

See also Section 4.7.1.3. A reduction of 25 % for NH₃ emissions due to frequent removal of slurry in comparison with a fully slatted floor system with a deep pit is reported [508, TFRN 2014].

Cross-media effects

See Section 4.7.1.3.

Environmental performance and operational data

In the ILF BREF [43, COM 2003], the ammonia emission reduction is assumed by analogy between 25 % and 35 % in comparison to fully slatted floor systems with a deep pit, which corresponds to emissions of 0.45 kg to 0.60 kg NH₃/ap/yr and 0.39 kg to 0.52 kg NH₃/ap/yr respectively.

Technical considerations relevant to applicability

See Section 4.7.1.3.

Economics

See Section 4.7.1.3.

Driving force for implementation

See Section 4.7.1.3.

Example plants

See Section 4.7.1.3.

Reference literature

[43, COM 2003] [292, Italy 2001] [508, TFRN 2014]

4.7.4.4 Slanted walls in the manure channel (in case of a fully or partly slatted floor)

Description

See Section 4.7.1.4.

Achieved environmental benefits

See Section 4.7.1.4. Having one or two slanted pit walls, in combination with a partly slatted floor and frequent manure removal, can reduce emissions by up to 65 % for weaners in comparison with a fully slatted floor system with a deep pit [508, TFRN 2014].

Cross-media effects

See Section 4.7.1.4.

Environmental performance and operational data

In Spain, with a continuous removal system, ammonia and methane emissions have been recorded in weaner houses equipped with fully slatted floors and manure channels with slanted walls; in particular, NH₃ emissions have been measured up to 0.324 kg/ap/yr, corresponding to approximately a 50 % emission reduction, and CH₄ emissions have been measured from 1.08 kg/ap/yr to 5.98 kg/ap/yr, corresponding to about a 65 % emission reduction, in comparison with a deep pit system [179, Spain 2010]. From the Netherlands, ammonia emissions associated with a partly slatted floor with slanted walls in the manure channel are reported to be equal to 0.17 kg per animal place per year for a maximum emitting surface per animal in the channel of 0.7 m² [640, Netherlands 2013].

Technical considerations relevant to applicability

The conversion of an existing house for weaners to this system is only possible if the pen has a length of at least 2.75 m [273, BE Flanders 2010]. See also Section 4.7.1.4.

Economics

From Belgium (Flanders), investment costs for implementing the technique in existing housing systems, with water and manure channels, are reported as EUR 51/ap, for houses equipped with partly slatted floors and EUR 44/ap for houses equipped with fully slatted floors. Reported extra costs for installation in new houses in Belgium (Flanders) are EUR 19 per weaner [265, BE Flanders 2010]. In the Netherlands, the reported extra investment costs for the implementation

of the technique are equivalent to EUR 13/ap and the total annual costs are EUR 2/ap/yr (including depreciation, interest, maintenance and all other operating costs, such as energy) [589, Netherlands 2010].

Extra costs compared to a fully slatted floor system with a deep pit emptied at the end of the cycle reported by Spain range from EUR 1.27/ap/yr (existing buildings with PVC pens) to EUR 2.67/ap/yr (existing buildings with fixed metallic pens) for retrofitting existing houses and up to EUR 0.23/ap/yr for new houses [179, Spain 2010]. Extra costs expressed per kg of marketed pig (on the basis of a production of 579 kg of pigs per weaner place annually) range from EUR 2.2 to EUR 4.64/tonne of pig produced for existing houses while for new houses they are reported to be EUR 0.4/tonne of pig produced. The cost efficiency of the technique corresponding to a 60 % ammonia abatement is calculated at EUR 0.5 per kg of NH₃ for new houses and up to EUR 6.2 per kg of NH₃ for existing houses [338, Piñeiro et al. 2009].

The annual extra costs are reported to be equal to EUR 2 per animal place and the cost efficiency EUR 5–6 per kg of NH₃-N reduced [508, TFRN 2014].

Driving force for implementation

No information provided.

Example plants

The technique is applied in Spain and the Netherlands.

Reference literature

[179, Spain 2010] [265, BE Flanders 2005] [273, BE Flanders 2010] [338, Piñeiro et al. 2009] [508, TFRN 2014] [589, Netherlands 2010] [640, Netherlands 2013]

4.7.4.5 Scraper for frequent slurry removal (in case of fully or partly slatted floor)

Description

See Section 4.7.1.5 and Figure 4.51. In pens or flat decks for weaners, plastic and metal slats are used.

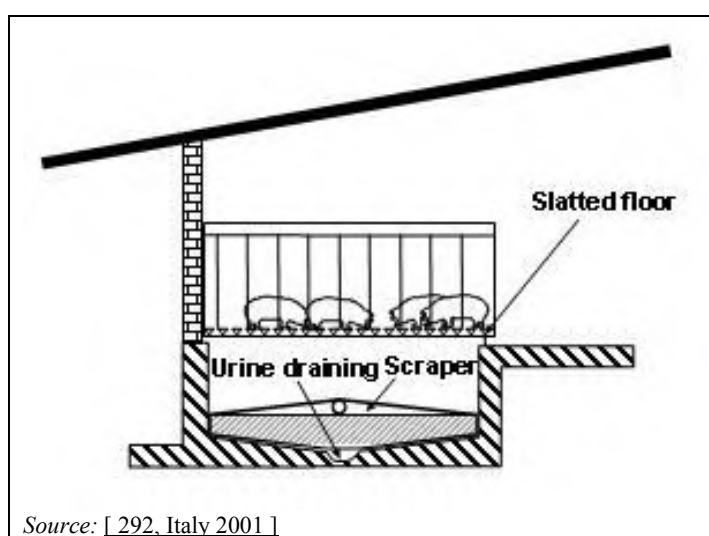

Figure 4.51: Flat deck system with a scraper under a fully slatted floor

Achieved environmental benefits

See Section 4.7.1.5.

Cross-media effects

See Section 4.7.1.5. The energy required for operating the scraper is estimated to be from 0.24 kWh per weaner place per year (fully slatted floor) to about 0.15 kWh per weaner place per year (partly slatted floor).

Environmental performance and operational data

Weaners in pens or on flat decks with fully slatted floors are associated with ammonia emissions of 0.39 kg NH₃/ap/yr (35 % reduction compared to a fully slatted floor with a deep pit) when the removal of the manure to the pit outside the building is frequent and there is a separate urine drain. In pens with a partly slatted floor and a manure scraper, frequently removing the manure from the manure pit outside the building reduces emissions by between 40 % (0.36 kg NH₃ per pig place per year (Italy)) and 70 % (0.18 kg NH₃ per pig place per year (Netherlands and Belgium)) compared to a fully slatted floor with a deep pit [[42, Netherlands 1999](#)] [[391, Italy 1999](#)].

Technical considerations relevant to applicability

See Section 4.7.1.5.

Economics

No information provided.

Driving force for implementation

See Section 4.7.1.5.

Example plants

Piglet places with partly slatted floors have been equipped in the Netherlands. See also Section 4.7.1.5.

Reference literature

[[42, Netherlands 1999](#)] [[292, Italy 2001](#)] [[391, Italy 1999](#)]

4.7.4.6 Frequent slurry removal by flushing (in case of a fully or partly slatted floor)

Description

See Section 4.7.1.9. Application is possible in pens with a partly or fully slatted floor.

Achieved environmental benefits

See Section 4.7.1.9. A 65 % emission reduction for the technique of flushing gutters applied in weaner housing systems is adopted by the UNECE guidance [[508, TFRN 2014](#)].

Cross-media effects

See Section 4.7.1.9.

Environmental performance and operational data

In pens or on flat decks with a fully slatted floor, limiting the manure surface in the manure channel and removing the manure twice a day by flushing achieves a reduction of 40 % (0.36 kg NH₃ per pig place per year) with non-aerated slurry, and of 50 % (0.30 kg NH₃ per pig place per year) with aerated slurry. Extra energy requirements for flushing fully slatted housing for weaners are reported to be between 1.9 kWh/ap/yr (non-aerated slurry) and 3.1 kWh/ap/yr (aerated slurry) [[391, Italy 1999](#)].

In pens with partly slatted floors, removing the manure twice a day by flushing and fast discharge of the manure on the slatted area by using triangular iron bars achieves a 65 % reduction (0.21 kg NH₃ per pig place per year). The energy requirements for flushing housing with partly slatted floors for weaners are 0.75 kWh/ap/yr [[42, Netherlands 1999](#)].

Technical considerations relevant to applicability

See Section 4.7.1.9.

Economics

The extra annual cost, in comparison with fully slatted floors with a deep pit, for new houses equipped with flushing gutters is EUR 5 per animal place and the cost efficiency is EUR 14/kg of NH₃-N reduced [508, TFRN 2014].

For other designs, no information is provided.

Driving force for implementation

See Section 4.7.1.9.

Example plants

See Section 4.7.1.9. In 1999, in the Netherlands, about 75 000 weaned piglet places were equipped with this system in combination with partly slatted floors.

Reference literature

[42, Netherlands 1999] [391, Italy 1999] [508, TFRN 2014]

4.7.4.7 Kennel or hut housing (in case of a partly slatted floor)

Description

See Section 4.7.1.10. Along the width of the pen, kennels are placed side by side, whilst the defecating areas are situated on the short sides of the pen. In the middle of the area is a solid floor with feeders. The floor can be littered with a small amount of straw for enrichment. Slurry is generated and removed at the end of the rearing period.

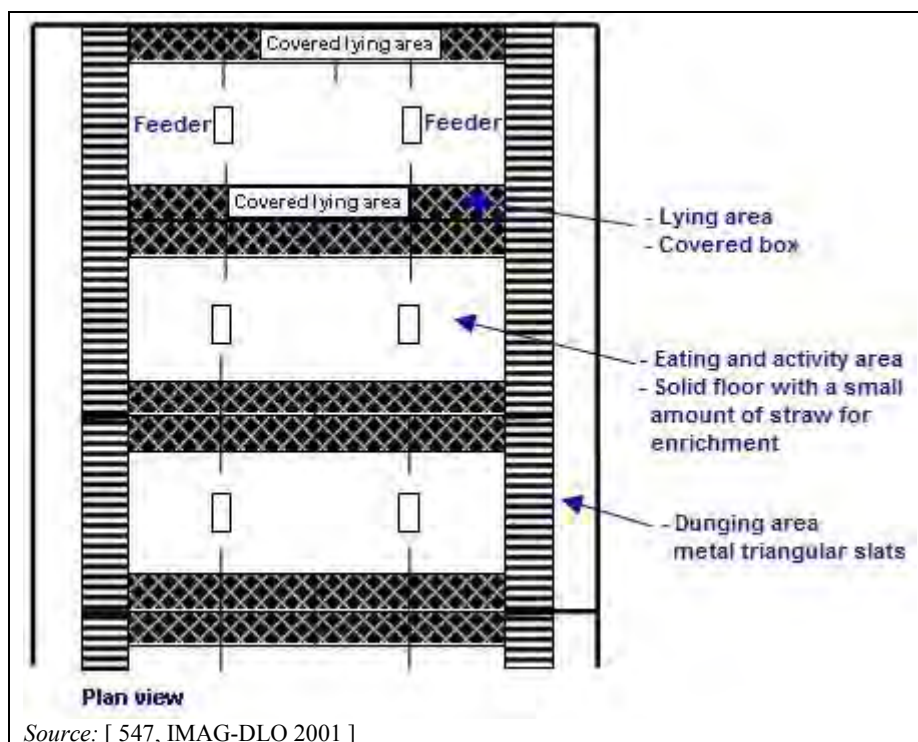

Figure 4.52: Kennel housing system for weaners

In a variant of the technique, bedding is provided and, therefore, solid manure is produced which is removed by tractor [183, Germany 2010]. Forced ventilation is also an option for the kennel system with partly slatted floors [547, IMAG-DLO 2001].

Achieved environmental benefits

See Section 4.7.1.10. From Germany, a reduction of 25 % of ammonia emissions is reported for weaners in naturally ventilated houses with kennels.

Cross-media effects

See Section 4.7.1.10. Under extreme climatic conditions, the reliability of the ventilation system in weaner houses must be assured.

Environmental performance and operational data

The ammonia emission factor for naturally ventilated kennel housing for weaners in Germany is 0.38 kg NH₃/ap/yr. PM₁₀ emissions are 0.08 kg/ap/yr and odour emissions 2.25 ou_E/s/animal [183, Germany 2010]. Data concerning energy consumption and labour requirements are presented in Table 4.96.

Table 4.96: Consumption and labour requirements for kennel housing systems for weaners

Bedding	Electricity	Fuel	Cleaning water	Labour
kg/ap/yr	kWh/ap/yr	kWh/ap/yr	l/ap/yr	h/ap/yr
26 ⁽¹⁾	2–3 ⁽²⁾	80	150	1.37
⁽¹⁾ When the variant with bedding is used. Equivalent to the provision of 80 g of straw per animal place per day. ⁽²⁾ This value can be achieved when a kennel of 20 piglets, from 3 to 5 weeks of age, is fitted with automatically controlled natural ventilation and when 1 kWh of heating is provided by underfloor heating elements [356, Carbon Trust 2005]. <i>Source:</i> [183, Germany 2010]				

In naturally ventilated kennel systems in Germany, weaners are kept in groups of up to 100 animals. Kennels for weaners can be heated with warm water piping. The solid floor covers 40 % of the floor area. The reported available space per animal, applied in Germany, is 0.41 m²/weaned piglet.

Technical considerations relevant to applicability

See Section 4.7.1.10.

Economics

For new houses in Germany, the reported investment needed per animal place is EUR 249. The corresponding total annualised costs are EUR 28 per animal place per year for weaners. In addition, more labour is needed, e.g. for the cleaning of the lying kennels. The additional expenses generated by these factors, however, are compensated for by energy cost savings in the unheated naturally ventilated housing.

Driving force for implementation

See Section 4.7.1.10.

Example plants

See Section 4.7.1.10.

Reference literature

[183, Germany 2010] [356, Carbon Trust 2005] [547, IMAG-DLO 2001]

4.7.4.8 Straw flow housing system (in case of a solid concrete floor)

Description

See Section 4.7.5.9. The system combines a regular straw supply, a sloped floor and frequent manure scraping. Weaners can be provided with littered kennels in cooler months in naturally ventilated houses.

Achieved environmental benefits

See Section 4.7.5.9.

Cross-media effects

See Section 4.7.5.9.

Environmental performance and operational data

Ammonia emissions from a naturally ventilated house with daily straw addition and scraping of the manure in the dunging passage are estimated as 0.21 kg NH₃/ap/yr [535, UK 2011].

Technical considerations relevant to applicability

See Section 4.7.5.9.

Economics

Labour requirements are low. From the UK, it has been reported that the total investment cost for a new house equipped with natural ventilation is around EUR 160 per animal place (EUR 1 = GBP 0.88) [535, UK 2011]. Buildings are simple, and easy to clean and maintain; hence, a long lifespan is expected.

Driving force for implementation

See Section 4.7.5.9.

Example plants

The system is used in farms in the UK.

Reference literature

[535, UK 2011]

4.7.4.9 Convex floor and separated manure and water channels (in case of partly slatted pens)

Description

See Section 4.7.1.6.

With this system, the total space available per weaner is reported as 0.4 m² with at least 0.12 m² solid floor corresponding to each animal. The reported minimum width of the manure channel is 0.6–0.9 m. The maximum emitting surface per animal, in the manure channel, is 0.10 m² when slanted walls are used in the manure channel. Slats over the manure channel are metal or plastic. The system can be combined with a flushing system or slanted walls in the manure channel. Two different designs are illustrated in Figure 4.53 and Figure 4.54.

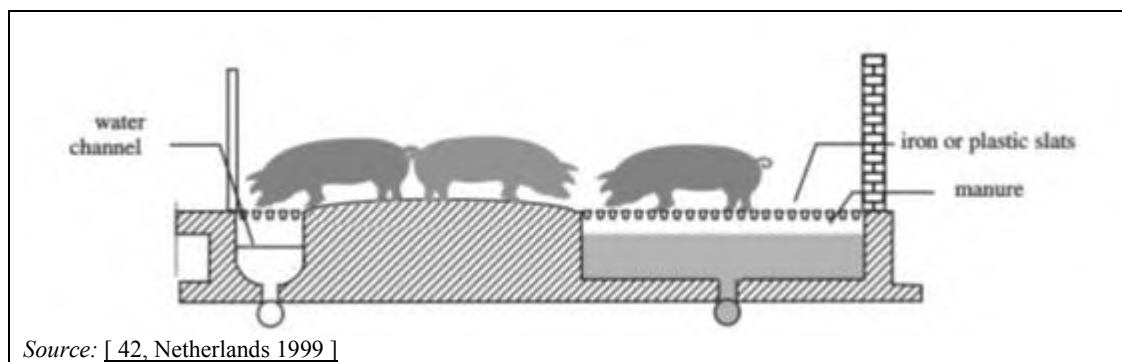

Figure 4.53: Partly slatted floor with a shallow manure pit and a water channel for spoiled drinking water in combination with a convex floor

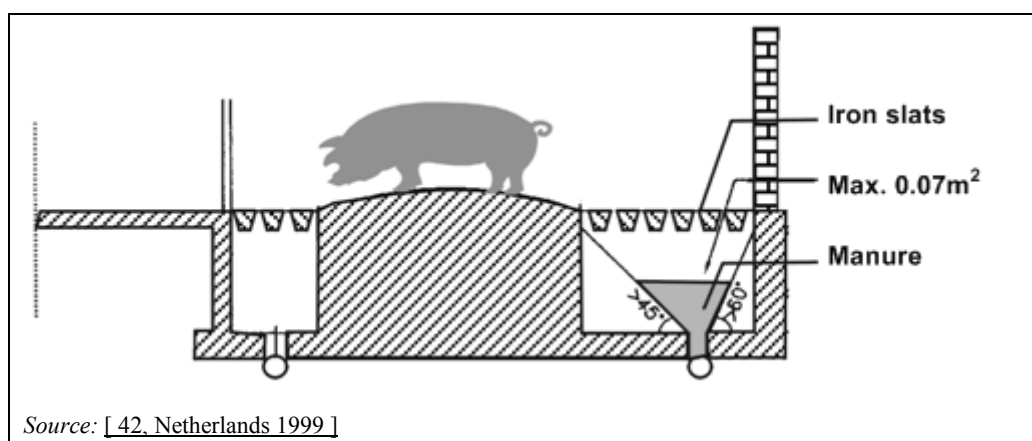

Figure 4.54: Convex floor with triangular metal slats in combination with a discharge system and slanted walls in the manure channel

Achieved environmental benefits

See Section 4.7.1.6. A 65 % ammonia emission reduction is reported when the technique is combined with slanted walls in the manure channel [508, TFRN 2014].

Cross-media effects

See Section 4.7.1.6. Flushing twice a day has an extra energy consumption of 0.75 kWh per weaner place per year.

Environmental performance and operational data

Ammonia emissions vary depending on the manure collection system and the emitting slurry surface per animal (see Table 4.97).

Table 4.97: Emissions of housing systems equipped with a convex solid floor and separate manure and water channels

Housing system variation	NH ₃	PM ₁₀	Odour	Reference
	kg/ap/yr	kg/ap/yr	ou _E /s/animal	
Frequent discharge, metal slats	0.26	NI	NI	[43, COM 2003]
	0.20			[186, BE Flanders 2010]
Flushing gutters	0.21	NI	NI	[43, COM 2003]
Slanted walls, metal slats	0.18	NI	NI	[497, BE Flanders 2010]
Slanted walls, metal slats, 0.1 m ² /ap	0.18 ⁽¹⁾ (0.14–0.22) ⁽²⁾	0.132 ⁽¹⁾	5.4 ⁽¹⁾	[176, Netherlands 2010]

⁽¹⁾ Values derived by expert judgement based on conclusions by analogy.
⁽²⁾ Measured data.
 NB: NI = no information provided.

Technical considerations relevant to applicability

See Section 4.7.1.6.

A minimum length of 2.75 m is reported as necessary for retrofitting pens for weaners [273, BE Flanders 2010].

Economics

Extra investment costs for the implementation of the technique with slanted walls in the manure channel, as compared to standard housing with a partly slatted floor with a 60 % solid floor and 0.4 m² available total surface per weaned piglet, are reported from the Netherlands as being equal to EUR 13 per animal place and the annual costs EUR 2 per animal place per year [589, Netherlands 2010].

Retrofitting a house for weaners, with a system with a manure pit with a combination of water and manure channels, equipped with slanted side walls, is reported to cost about EUR 45 per animal place [273, BE Flanders 2010].

No cost data are available for the combination of the technique with flushing gutters.

Driving force for implementation

See Section 4.7.1.6.

Example plants

In the Netherlands, this system has been implemented in most new buildings and modifications of existing houses [176, Netherlands 2010].

Reference literature

[42, Netherlands 1999] [43, COM 2003] [176, Netherlands 2010] [186, BE Flanders 2010] [273, BE Flanders 2010] [497, BE Flanders 2010] [508, TFRN 2014] [589, Netherlands 2010]

4.7.4.10 Slurry cooling**Description**

Slurry cooling channels or slurry surface cooling fins can be used. See Section 4.7.1.7 for slurry cooling channels and Section 4.7.1.8 for slurry surface cooling fins.

Achieved environmental benefits

See Section 4.7.1.7 and Section 4.7.1.8.

Cross-media effects

See Section 4.7.1.7 and Section 4.7.1.8.

Environmental performance and operational data

From the Netherlands, the ammonia emission reduction achieved by slurry cooling fins is reported as 75 % for weaner houses compared to FSF with a deep pit (150 % cooling fins' surface/slurry surface) and the associated emission factor is 0.15 kg NH₃/ap/yr [640, Netherlands 2013].

The ammonia emission reduction attained by the technique of surface cooling with fins combined with partly slatted floors is given as 75 % [508, TFRN 2014].

For surface cooling fins, the extra energy consumption is estimated to be 3 kWh per weaner place per year for partly slatted floors and 7 kWh per weaner place per year for fully slatted floors [589, Netherlands 2010]. No information is provided for slurry cooling channels.

Technical considerations relevant to applicability

See Section 4.7.1.7 and Section 4.7.1.8.

Economics

The extra investment costs for the implementation of surface cooling fins are calculated at EUR 14 to EUR 19 per animal place and the extra annual costs at EUR 2 to EUR 3 per animal place (see Table 4.78). An extra cost of EUR 3–4 per animal place per year for new buildings equipped with partly slatted floors and surface cooling fins and a cost efficiency of EUR 7 to EUR 10 per kg of NH₃-N reduced are reported [508, TFRN 2014]. No data are available for slurry cooling channels.

Driving force for implementation

See Section 4.7.1.7 and Section 4.7.1.8.

Example plants

See Section 4.7.1.7 and Section 4.7.1.8.

Reference literature

[508, TFRN 2014] [589, Netherlands 2010] [640, Netherlands 2013]

4.7.4.11 Pens for weaning pigs with partly slatted floor

Description

A partly slatted floor combined with a solid concrete floor with a smoothly finished surface is applied. The solid floor can be slightly inclined covering one side of the pen or convex with slats at both sides and two manure channels (see Figure 4.55). The slats can be metal, or plastic; concrete slats can also be used. In general, the buildings (walls and roof) are insulated.

Manure is handled as slurry and it is often drained through a pipe discharge system where the individual sections of the manure channels are drained via plugs or gates. The channels are usually drained after the removal of each group of pigs, in connection with disinfecting the pens, i.e. at intervals of 6 to 8 weeks.

This housing system is normally equipped with mechanical ventilation, either in the form of negative-pressure or balanced-pressure ventilation. The ventilation is dimensioned for a maximum output of around 40–50 m³ per hour per place. Auxiliary heating is available in the form of either electric fan heaters (room heating) or a central heating plant with heating pipes (floor heating). Naturally ventilated designs are also applied.

In Denmark, houses with partly slatted floors are called ‘two-climate systems’: the floor below the covered lying area is heated with hot water pipes during the first couple of weeks; heating is then turned off since the heat production of the pigs is sufficient for keeping them warm.

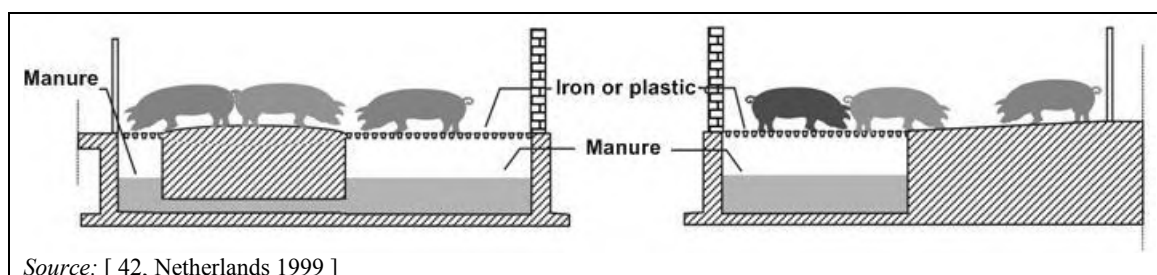

Source: [42, Netherlands 1999]

Figure 4.55: Partly slatted floor with a convex or sloped concrete floor

Achieved environmental benefits

Reducing the emitting surface in the manure channel achieves an ammonia emission reduction. The emission reduction is enhanced with the use of a convex or sloped floor as the risk of emissions from the solid part decreases.

The 'two-climate' design can offer a lower energy consumption. The naturally ventilated design uses less energy compared to the reference system.

Cross-media effects

A partly slatted floor may entail increased requirements in temperature control and general management, as solid floors can get soiled, in particular at high temperatures (see general remarks in Section 4.7). Dirty floors have implications for pig hygiene and health and for odour emissions. Water consumption is higher when the ratio of solid to slatted floor increases [261, France 2010].

Environmental performance and operational data

The proportion of slatted to solid floor is commonly around one to one. The average ammonia emissions are estimated at 0.5 kg NH₃ per animal place per year [184, Germany 2010]. Dust emissions are considered to be on average 0.08 kg PM₁₀ per animal place per year [184, Germany 2010].

Odour emissions are reported from Germany as being equivalent to 75 ou_E/s per livestock unit (LU). Odour emission factors vary depending on the growth stage of the animals, as displayed in Table 4.98.

Table 4.98: Odour emission factors for weaners, in Germany

Variable	Unit	Stage of growth		
		Up to 10	Up to 25	Up to 30
Live weight	kg			
Live mass	LU/animal	0.02	0.03	0.04
Emission factor	ou _E /s/animal	1.5	2.25	3.0
<i>Source: [474, VDI 2011]</i>				

The 'two-climate' system applied in Denmark is reported to have ammonia emissions 40 % lower than those from a fully slatted floor system [500, IRPP TWG 2011]. An emission factor equal to 0.53 kg NH₃/ap/yr was associated with the 'two-climate' system, analogous to a reduction of 34 % in relation to a fully slatted floor with a deep pit [397, Denmark 2000]. For pens with a partly slatted floor and a sloped or convex solid floor, the respective emission factor was reported as 0.34 kg NH₃/ap/yr by the Netherlands, corresponding to a reduction of 43 % in relation to a fully slatted floor with a deep pit [42, Netherlands 1999].

Technical considerations relevant to applicability

In existing houses, the applicability depends on the design of the existing manure pit. An adaptation of existing slatted floor pens would be possible by filling part of the slatted floor (without changing the total surface area of the pit).

Economics

Extra costs related to the retrofitting of this technique in existing buildings with fully slatted floors are shown in Table 4.99.

Table 4.99: Extra costs associated to the retrofitting of partly slatted floors in existing fully slatted floored pens for weaners, in Spain

System	Ammonia emissions reduction (¹)	Extra costs		
	%	EUR/ap/yr	EUR/tonne pig produced	EUR/kg NH ₃ reduced
Pens with partly slatted floor retrofitted in existing houses (piglets from 6 kg to 20 kg)	25–35	0.88–2.25	1–2.6	3.49–12.50
⁽¹⁾ Data refer to a comparison made against fully slatted floored pens.				
Source: [500, IRPP TWG 2011]				

Driving force for implementation

Partly slatted floors are considered more welfare friendly.

Example plants

Partly slatted floor systems for weaners are applied in the Netherlands and Germany. In Denmark, only housing systems with partly slatted floored pens are built, where it is estimated that at least 80 % of all weaners are housed in the 'two-climate' system. Dutch legislation does not allow this system in new buildings.

Reference literature

[42, Netherlands 1999] [184, Germany 2010] [261, France 2010] [397, Denmark 2000] [474, VDI 2011] [500, IRPP TWG 2011]

4.7.4.12 Pens or flat decks with a fully slatted floor and a concrete sloped underground floor to separate faeces and urine

Description

A board (concrete or another material) with a very smooth surface is placed under the slatted floors. The size can be adapted to the dimensions of the pen. The board has a slope of at least 12° towards a central slurry pit that allows the urine to drain continuously and the slurry to move towards the central pit. The slurry is removed weekly to a store by gravity or by pumping. Also, frequent emptying of the central slurry channel will enhance the emissions reduction. Emissions predominantly come from any slurry remaining on the board (Figure 4.56). At the end of the weaning period, dry faeces are easily removed by water jets.

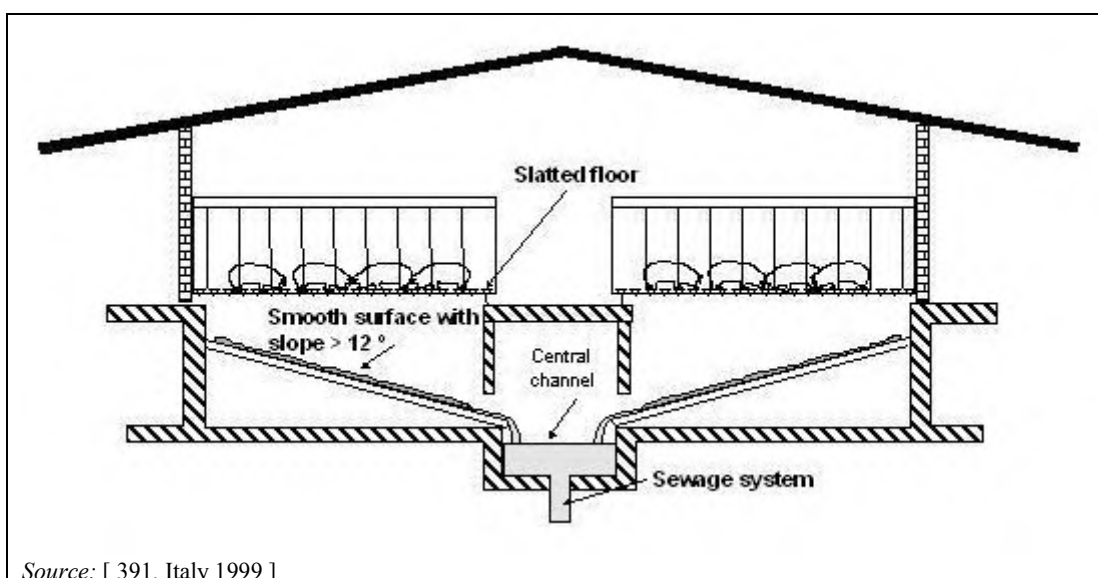

Source: [391, Italy 1999]

Figure 4.56: Flat decks or pens with an underground concrete slope to separate faeces from urine

Achieved environmental benefits

The immediate removal of manure to the central channel and the immediate draining of urine achieves a 30 % reduction of ammonia emissions. The benefit of applying this system depends on the smoothness of the board surface to allow the urine to drain continuously and the slurry to move towards the central pit.

Cross-media effects

Flies can be a serious problem, especially when the manure sticks to the slope [261, France 2010]. See also 'Cross-media effects' in Section 4.7.1.1 for fully slatted floors.

Environmental performance and operational data

An emission factor of 0.42 kg NH₃ per pig place per year is reported by Italy. No additional energy consumption is required.

Technical considerations relevant to applicability

With a manure pit of a sufficient depth, this technique can be easily applied to existing housing, but only if a discharge system is located in a central position in the pen for emptying the manure channel. If this is not the case, the entire floor plate of the manure pit has to be removed to install the discharge system, which is only possible at significant extra costs.

Economics

No information provided.

Driving force for implementation

No information provided.

Example plants

A few farms in Italy.

Reference literature

[261, France 2010] [292, Italy 2001] [391, Italy 1999]

4.7.4.13 Manure collection in water**Description**

Slurry is collected in the water that is kept in the channel after cleaning. After each rearing cycle, and before the pens are cleaned, slurry is removed from the manure channel. Cleaning water is kept in the channel which is automatically refilled until a level of around 120–150 mm is reached. The system can be combined with a fully slatted floor, a partly slatted floor with a slurry channel or a partly slatted floor with a central convex floor and slats at the back and the front side of the pen (see Figure 4.57).

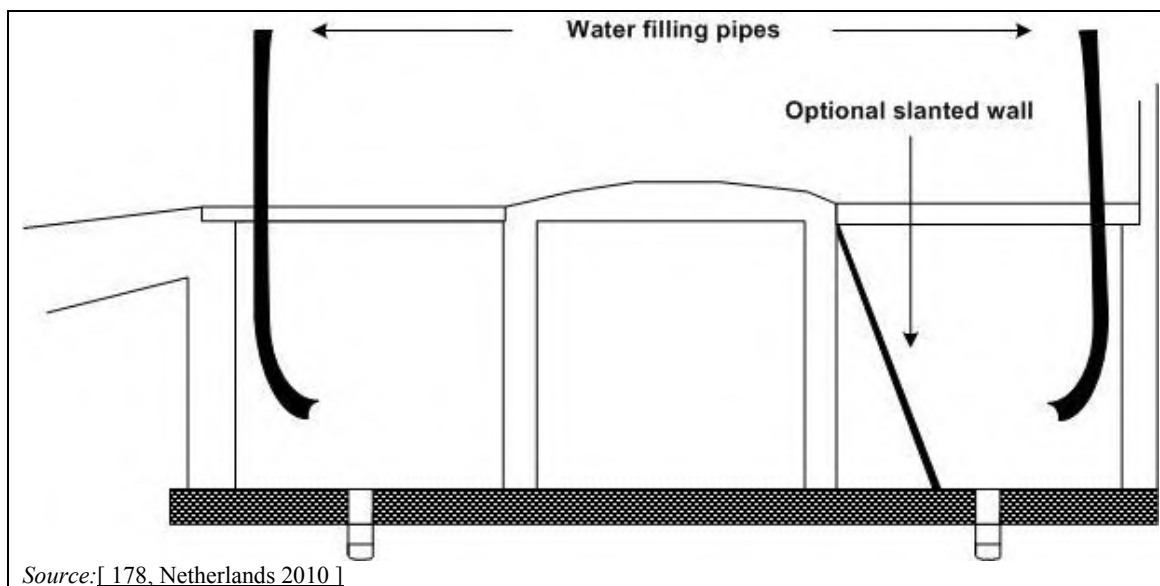

Figure 4.57: Cross section of a variation of a system for rearing weaners with manure collection in water

The minimum depth of the channel is 500 mm. The installation of slanted walls in the channel is possible for the further reduction of the ammonia-emitting surface. In the Netherlands, one slanted wall is installed.

Achieved environmental benefits

Ammonia emissions are reduced due to a reduced emitting surface and lower emissions from the diluted slurry in the manure channels.

Cross-media effects

Large quantities of water are required. Dilute slurry entails higher transport costs for storage and subsequent landspreading; furthermore, it is not suitable for biogas production.

Environmental performance and operational data

In the Netherlands, measured ammonia emissions are reported to be in the range of 0.13 kg per animal place per year if the available total surface area in a partly slatted floor system is lower than 0.35 m² per animal, and 0.16 kg per animal place per year when the available surface area per animal is higher than 0.35 m² [640, Netherlands 2013]. In addition, dust and odour emissions have been measured in the Netherlands at 0.132 kg PM₁₀/ap/yr and 5.4 ou_E/s/animal, respectively.

In trials carried out in Belgium (Wallonia), ammonia emissions in fully slatted floor systems were measured in the range 0.13–0.15 kg NH₃/animal place per year when water was poured into the pit at the start of the rearing cycle with the aim of establishing a water layer of 50 mm (values calculated from measured data reported in g/head per day, for 53 days' rearing time and 6.33 cycles a year) [147, Cabaraux et al. 2009].

Economics

Extra investment costs for a system with a partly slatted floor pen with a slanted wall in the manure channel are reported from the Netherlands as being equivalent to EUR 13 per animal place, with annual costs equivalent to EUR 2/ap/yr (including depreciation, interest, maintenance and all other operating costs) in comparison with a fully slatted floor system with a deep pit [589, Netherlands 2010].

Technical considerations relevant to applicability

The technique is difficult to implement in existing buildings due to the costly modifications required for retrofitting the existing housing system.

Driving force for implementation

This system is relatively inexpensive for new buildings.

Example plants

In the Netherlands, this system was very popular in new housing systems, for the reduction of ammonia emissions, before air cleaning systems (wet scrubbers) became widespread. In 2010, at least 50 000 weaners were kept in this housing system in the Netherlands.

Reference literature

[147, Cabaraux et al. 2009] [177, Netherlands 2010] [178, Netherlands 2010] [589, Netherlands 2010] [608, Netherlands 2010] [640, Netherlands 2013]

4.7.4.14 Full litter system (in case of solid concrete floor)

Description

The solid concrete floor is almost completely bedded with a layer of straw or other lignocellulosic materials (e.g. sawdust) to absorb urine and to incorporate faeces. Bedding material is regularly supplied to prevent wet surfaces. Solid manure is obtained, which has to be frequently removed in order to avoid the litter becoming too wet. In cooler regions, the floor area may be divided such that a fully insulated kennel or creep (heated) provides a lying area for the weaned pigs with access to a fully bedded dunging area. Some straw is provided in the kennel or creep. Automatic feeding and drinking systems are used and the group size is up to 100 animal places. Post-weaning rearing houses are mainly based on a manure management system with deep litter [262, France 2010]. The technique typically operates in open-climate, naturally ventilated houses. A schematic representation of the pen in a house with deep litter is given in Figure 4.58.

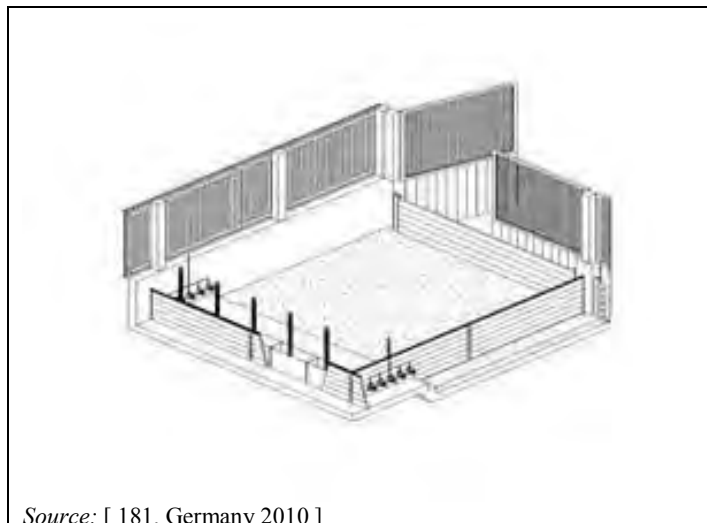

Figure 4.58: Housing system with deep litter for weaners

The technique can also be applied in closed, insulated, mechanically ventilated houses, in a variation that uses a smaller quantity of bedding for the littered floor at the beginning of the rearing period and regular addition during the cycle [185, Germany 2010].

The plane littered-floor variation can be combined with a fully bedded yard with a concrete floor, which is a requirement for organic farming. In a variation of this technique, a covered lying area is present. A plane littered-floor system with a bedded yard (with and without a covered lying area) is illustrated in Figure 4.59.

An elevated plane concrete feeding area may be constructed, to lead weaners to prepare themselves a defecating area where sufficient space is available [185, Germany 2010] [420, Ramonet 2003].

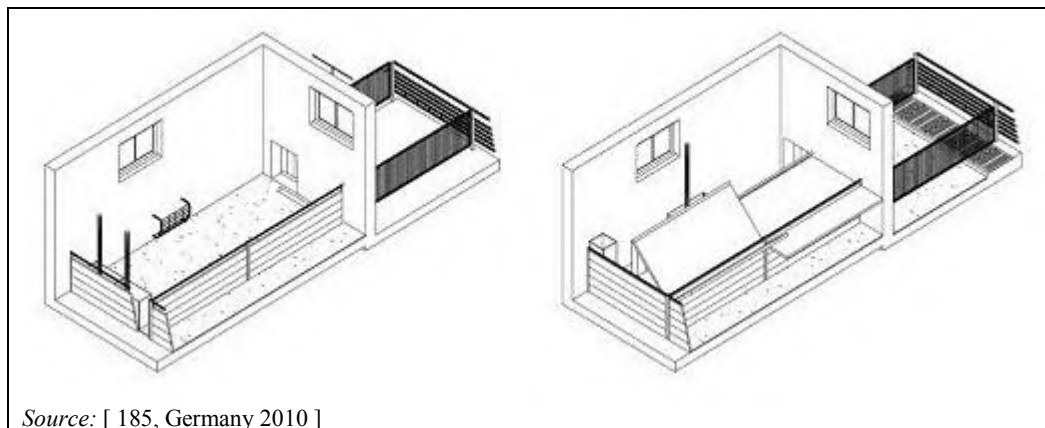

Figure 4.59: Housing system with a littered floor and a yard (with or without a covered lying area) for weaners

Achieved environmental benefits

See also Section 4.7.5.13. If the dunging area is cleaned regularly or an adequate quantity of straw is added in order to absorb urine to avoid wet surface areas, ammonia emissions are low. For naturally ventilated systems, low energy consumption is achieved. No additional energy for heating is required.

Cross-media effects

Poorly maintained litter (inadequate quantity of straw and insufficient frequency of addition) can lead to emissions of odours and ammonia higher than those measured with a fully slatted floor [261, France 2010]. Emission of greenhouse gases is also possible.

In the closed littered-floor system, the straw bed might warm up in the summer. The functional reliability of the system, under extreme climatic conditions, is not always guaranteed. Management requirements are higher, due to the necessary regular littering of the floor and possible need for dung removal.

Environmental performance and operational data

Buildings are kept cool, with plenty of straw to absorb urine. They are cleaned and dried completely between batches [535, UK 2011].

It is expected that the use of straw will allow weaners to control the temperature themselves in systems where insulated kennels or creeps are not used, thus requiring no additional energy for heating. The system requires cleared concrete areas in summer at feeding places for the pigs to cool down. If a covered lying area is present, the litter quantity needs to be adjusted to the temperature and the cover must be removed at high temperatures. Manual dung removal from the covered lying area may also be necessary.

In order to maximise their exposure to wind, naturally ventilated houses should be situated at right angles to the main wind direction [181, Germany 2010]. The ventilation rate for the mechanically ventilated configuration is reported as 3.5–7 m³/h/ap for the cold season and 20–50 m³/h/ap for the warm season [185, Germany 2010].

In Germany, for both the littered and the deep litter system and for a final live weight of 28 kg, the provided space per animal is reported to be up to 0.35 m², while in France with kennels the available space per animal is reported to be 0.5 m² to 0.6 m² in the deep litter housing system. In

the deep litter system, bedding is spread every week and manure is removed at the end of the rearing period.

In France, in deep litter systems for rearing weaners, a quantity of 6 kg of straw is used at the beginning of the cycle and straw is added once to twice a week. The total required straw quantity is 10–15 kg per piglet per cycle and the quantity of generated manure is estimated as 30 kg to 50 kg per animal [329, CORPEN 2003] [261, France 2010].

Sawdust can also be used instead of straw. A quantity of approximately 15 kg of sawdust is equivalent to 6 kg of straw per piglet per cycle (having about the same amount of dry matter), which results in the production of about 17 kg of 'composted' manure containing sawdust or straw at the end of rearing cycle [261, France 2010]. On a yearly basis, the quantity of straw used is approximately 30 kg to 60 kg per animal place.

The resources demand, as reported from Germany for two variations of the technique, are presented in Table 4.100.

Table 4.100: Resources demand for two different variations of solid concrete floor housing systems with litter for weaners (8–28 kg)

System	Electricity	Bedding material	Cleaning water	Fuel	Source
	kWh/ap/yr	kg/ap/yr	l/ap/yr	kg/ap/yr	
Deep litter, open climate, with natural ventilation	2	53 ⁽¹⁾ 40–60	150	NI	[181, Germany 2010]
Littered floor combined with yard, with forced ventilation	12	35	150	170	[185, Germany 2010]

⁽¹⁾ 150 g/animal per day.
NB: NI = no information provided.

Reported emissions from weaner houses have been measured under different conditions and are summarised in Table 4.101. Tests carried out in France showed that rearing weaners in a deep litter system with sawdust produced four times less ammonia than rearing them in the same system with straw, while the quantity of manure produced per piglet was identical. Emissions are presumed to be higher due to the external yard but have not been estimated [181, Germany 2010].

Table 4.101: Emission levels associated with straw-littered systems for rearing of weaners

System	NH ₃	CH ₄	N ₂ O	PM ₁₀	Odour	Source
	kg/ap/yr				ou _E /s/animal	
Littered floor with straw and forced ventilation	0.5 ⁽¹⁾ (0.2–0.7) ⁽²⁾	NI	NI	NI	3 ⁽³⁾	[185, Germany 2010]
Deep litter with straw and natural ventilation	0.5 ⁽¹⁾ (0.2–0.7) ⁽²⁾	NI	NI	NI	3 ⁽³⁾	[181, Germany 2010]
Deep litter with straw and forced ventilation, removal of litter after 5 consecutive batches, regular addition of straw ⁽⁴⁾ ⁽²⁾	0.43	0.60	0.16	NI	NI	[532, Nicks et al. 2002]
Sawdust litter and forced ventilation, no regular addition of sawdust, manual scattering of manure every 10 days ⁽⁴⁾ ⁽²⁾	0.11	0.29	0.57	NI	NI	[532, Nicks et al. 2002]
Deep litter with straw and forced ventilation, removal of litter after two batches, regular addition of straw ⁽⁴⁾ ⁽⁵⁾	0.25	0.70	0.02	NI	NI	[147, Cabaraux et al. 2009]
Deep litter with sawdust and forced ventilation. Removal of litter after two batches, no sawdust addition, manual scattering of manure every 10 days, manure removal after 2 cycles ⁽⁴⁾ ⁽⁵⁾	0.22	0.48	0.16	NI	NI	[147, Cabaraux et al. 2009]

⁽¹⁾ Conclusion by analogy.
⁽²⁾ Values derived from measurements.
⁽³⁾ Values have been calculated from an emission factor of 75 ou_E/s/LU (0.04 LU/head), for weaners up to 30 kg (average weight 20 kg).
⁽⁴⁾ Values calculated from measured data reported in g/head per day, for 53 days' rearing time and 6.33 cycles a year.
⁽⁵⁾ Measured values.
 NB: NI = no information provided.

Technical considerations relevant to applicability

In houses with natural ventilation, the technique may not be applicable to houses located in regions with a warm climate. The system can be applied in all new housing. The scarcity of bedding materials in some geographical areas may be a limitation to the use of such a system.

Economics

The annual operating costs are expected to be higher than for the reference system. [291, IRPP TWG 2002]. The cost of straw is reported to be increasing.

Driving force for implementation

Improved animal welfare.

Example plants

The technique is applied in Germany. According to a survey carried out in 2008 on livestock buildings (SCEES Survey of 2008), around 7 % of post-weaning places in France were using littered systems. About 4 % of the weaning pigs in Italy are kept on fully bedded systems. In the UK, kennels and creeps (with heat) in association with a fully bedded system are common, with group sizes of around 100 pigs of 7 kg (weaning) up to 15 kg or 20 kg.

Reference literature

[147, Cabaraux et al. 2009] [181, Germany 2010] [185, Germany 2010] [261, France 2010]
[262, France 2010] [291, IRPP TWG 2002] [329, CORPEN 2003] [420, Ramonet 2003]
[532, Nicks et al. 2002] [535, UK 2011]

4.7.5 Housing systems for growing and finishing pigs (fattening pigs)

Performances of housing techniques for fattening pigs concerning NH₃, CH₄, N₂O, dust and odour are summarised in Table 4.102.

Table 4.102: Emission levels of system-integrated housing techniques for fattening pigs

Section number	Housing system	NH ₃	CH ₄	N ₂ O	PM ₁₀	Odour	Source
		kg/ap/yr					
4.7.5.1	Deep pit (in case of a fully slatted floor)	2.39–3.0	NI	NI	NI	NI	[43, COM 2003]
		3.0	NI	NI	NI	NI	[508, TFRN 2014]
		2.2 (0.8–3.6) ⁽¹⁾	10.4 (1–19.8)	0.015 (0.003–0.028)	0.1 (0.07–1.3)	29.2	[642, BE Flanders 2013] [643, Van Ransbeeck et al. 2013] [634, BE Flanders 2013]
	Deep pit (in case of a fully slatted floor) Removal every 2 months	4.6 ⁽²⁾	NI	NI	NI	NI	[266, Austria 2010]
	Deep pit (in case of a fully slatted floor) Removal at the end of cycle	3.64 ⁽³⁾	1.0–6.0 ⁽¹⁾	0.02–0.15 ⁽¹⁾	0.24 ⁽²⁾	6.5 ⁽¹⁾	[189, Germany 2010] [474, VDI 2011]
		2.91 (1.37–3.95) ⁽¹⁾	NI	NI	NI	1.28 ⁽¹⁾	[269, France 2010]
		2.56 ⁽¹⁾	2.1 ⁽¹⁾	0.035 ⁽¹⁾	NI	NI	[270, France 2010]
		1.83 ⁽³⁾ (1.51–2.14)	5.6 ⁽¹⁾	0.24 ⁽¹⁾	NI	NI	[662, Philippe et al. 2007]
		4.9 ⁽²⁾ ⁽⁴⁾	10.5	1.1	NI	NI	[373, UBA Austria 2009]
		2.63 ⁽¹⁾	2.42 ⁽¹⁾	0.0432 ⁽¹⁾	NI	NI	[271, France 2010]
	Deep pit (in case of a partly slatted floor) Removal twice per cycle	3.64 ⁽¹⁾	4–30 ⁽¹⁾	0.02–0.15 ⁽¹⁾	0.24 ⁽²⁾	7 ⁽²⁾	[192, Germany, 2010]
		3.6 ⁽¹⁾	NI	NI	NI	1.14 ⁽¹⁾ ⁽³⁾	[272, France 2010]
	4.7.5.2	Vacuum system for frequent slurry removal (in case of a fully slatted floor)	2.25	NI	NI	NI	NI
0.54–1.85 ⁽¹⁾			0.42–2.35 ⁽¹⁾	NI	NI	NI	[187, Spain 2010]
4.7.5.3	Vacuum system for frequent slurry removal (in case of a partly slatted floor) with metal slats	1.55–1.95	NI	NI	NI	NI	[43, COM 2003]
	Vacuum system for frequent slurry removal (in case of a partly slatted floor) with concrete slats	1.8–2.25	NI	NI	NI	NI	[292, Italy 2001]
4.7.5.4	Slanted walls in the manure channel (in case of a fully slatted floor)	1.23–1.61 ⁽¹⁾	0.59–1.46 ⁽¹⁾	NI	NI	NI	[188, Spain 2010]
	Slanted walls in the manure channel (in case of a partly slatted floor)	1.0–1.2	NI	NI	NI	NI	[589, Netherlands 2010]
4.7.5.5	Scraper for frequent slurry removal (in case of a fully slatted floor)	NI	NI	NI	NI	NI	NI
	Scraper for frequent slurry removal (in case of a partly slatted floor)	1.5–1.8	NI	NI	NI	NI	[292, Italy 2001]

Section number	Housing system	NH ₃	CH ₄	N ₂ O	PM ₁₀	Odour	Source
		kg/ap/yr					
4.7.5.6	Frequent slurry removal by flushing PSF, concrete slats, aerated	0.90	NI	NI	NI	NI	[43, COM 2003]
	PSF, concrete slats, non-aerated	1.20	NI	NI	NI	NI	[43, COM 2003]
	PSF, triangular slats, non-aerated	1.00					
	FSF, permanent slurry layer, non-aerated	2.1	NI	NI	NI	NI	[292, Italy 2001]
	FSF, permanent slurry layer, aerated	1.35					
	PSF, permanent slurry layer, non-aerated	1.5					
	PSF, permanent slurry layer, aerated	1.2					
4.7.5.7	Reduced manure pit (in case of a partly slatted floor)	0.89–1.69 ⁽¹⁾	0.9–1.82 ⁽¹⁾	NI	NI	NI	[196, Spain 2010]
4.7.5.8	Kennel or hut housing (in case of a partly slatted floor)	2.4 ⁽³⁾ (1.0–6.0) ⁽¹⁾	1–4 ⁽¹⁾	0.11–0.15 ⁽¹⁾	0.24 ⁽²⁾	7 ⁽²⁾ ⁽⁶⁾	[190, Germany 2010]
4.7.5.9	Straw flow system (in case of a solid concrete floor)	1.9–2.1 ⁽¹⁾	0.54–1.24 ⁽¹⁾	0.025–0.04 ⁽¹⁾	NI	NI	[519, Amon et al. 2007]
		4.89 (3.62–6.15) ⁽¹⁾	3.26 ⁽¹⁾	0.25 ⁽¹⁾	NI	NI	[662, Philippe et al. 2007]
4.7.5.10	Convex floor and separated manure and water channels (in case of partly slatted pens), slanted walls, metal bars, 0.18 m ² emitting surface/animal	1.01 (0.99–1.02) ⁽¹⁾	NI	NI	0.153	17.9 ⁽¹⁾	[194, Netherlands 2010]
	Slanted walls, metal bars, 0.27 m ² emitting surface/animal	1.4 ⁽³⁾	NI	NI	0.153	17.9 ⁽¹⁾	[195, Netherlands 2010]
	Slanted walls, concrete slats, 0.18 m ² emitting surface/animal	1.2	NI	NI	NI	NI	[186, BE Flanders 2010]
4.7.5.11	Manure collection in water	NI	NI	NI	NI	NI	NI
4.7.5.12	Slurry cooling channels (in case of a partly slatted floor) 25–49 % solid floor, frequent removal by vacuum, no bedding and 10 W/m ² cooling effect	1.16 ⁽³⁾	NI	NI	NI	NI	[268, Denmark 2010]
	50–75 % solid floor, frequent removal by vacuum, no bedding and 10 W/m ² cooling effect	1.52 ⁽³⁾	NI	NI	NI	NI	[268, Denmark 2010]
	Partly slatted floor, manure scraper, straw addition in the solid part 10–50 W/m ² cooling effect	2.2–2.6 ⁽³⁾	NI	NI	NI	NI	[160, Denmark 2010]
	FSF or PSF with manure surface cooling fins Concrete slats	1.4 ⁽³⁾	NI	NI	NI	NI	[589, Netherlands 2010]
	Metal slats	1.2	NI	NI	NI	NI	[640, Netherlands 2013]
4.7.5.13	Full litter system (in case of a solid concrete floor)						

Section number	Housing system	NH ₃	CH ₄	N ₂ O	PM ₁₀	Odour	Source
		kg/ap/yr					
	Deep litter floor system with straw	4.2 ⁽³⁾ (1–6) ⁽¹⁾	1.6–18 ⁽¹⁾	0.6–3.7 ⁽¹⁾	0.32 ⁽²⁾	4.2 ⁽²⁾ (7)	[193, Germany 2010] [474, VDI 2011]
		4.58–5.12 ⁽¹⁾	1.87–2.78 ⁽¹⁾	0.01–0.79 ⁽¹⁾	NI	NI	[530, Nicks et al. 2003]
		4.46 (4.24–4.67) ⁽³⁾	NI	NI	NI	NI	[375, Philippe et al. 2007]
	Deep litter floor with sawdust or soft wood particles (removal at the end of cycle)	5.65–7.53 ⁽¹⁾	NI	NI	NI	NI	[531, Ramonet et al. 2002]
	Littered floor with removal once a week	2.43 ⁽³⁾ (1.0–5.0) ⁽¹⁾	0.8–2.8 ⁽¹⁾	NI	0.32 ⁽²⁾	4.2 ⁽⁶⁾	[474, VDI 2011] [191, Germany 2010]
4.7.5.14	Littered external alley (in case of a solid concrete floor)	2.4	NI	NI	NI	NI	[292, Italy 2001]
4.7.5.15	V-shaped manure belts (in case of a partly slatted floor)	1.05–1.20 ⁽³⁾	0.94 ⁽¹⁾	0.11 ⁽¹⁾	NI	5.9 ⁽¹⁾	[198, Netherlands 2010] [200, Netherlands 2010]
4.8.5	Floating balls in slurry channels	2.3 ⁽¹⁾	NI	NI	NI	NI	[213, Netherlands 2010]

(¹) Measured values.
(²) Values derived by expert judgement based on conclusions by analogy.
(³) Values derived from measurements.
(⁴) Includes emissions during storage.
(⁵) Value derived from an emission of 36 × 106 ou_E/year per animal place
(⁶) Calculation based on an emission factor of 50 ou_E/LU per second and an average weight of 70 kg.
(⁷) Calculation based on an emission factor of 30 ou_E/LU per second and an average weight of 70 kg.
NB: NI = no information provided.

4.7.5.1 Deep pit (in case of a fully or partly slatted floor)

Description

Pigs are group-housed in thermally insulated houses that are forced or naturally ventilated and divided into pens with a fully slatted floor system with no physical separation between the lying, feeding and dunging areas. Partly slatted floor systems are similar except that the floor is divided into a slatted area (for dunging) and a solid, non-slatted area (for feeding and lying).

Slurry is collected in a deep pit beneath concrete slats. The slurry is removed at variable intervals such as two or three times per cycle or, usually, after every fattening period, or even less frequently. Overflow channels can also be used to lead slurry to the storage pit (see Section 4.7.1.1.1).

Achieved environmental benefits

See Section 4.7.1.1 (fully slatted floor) and Section 4.7.1.1.1 (partly slatted floor).

In general, higher ammonia emissions are expected for longer storage of the slurry in the pit. Emptying the slurry pit once or twice within a fattening period has the potential to reduce ammonia emission but the effect cannot always be proven or is proven insufficiently [474, VDI 2011].

Cross-media effects

See Section 4.7.1.1 (fully slatted floor) and Section 4.7.1.1.1 (partly slatted floor).

In general, higher ammonia emissions are expected for longer storage of the slurry in the pit.

Environmental performance and operational data

Fully slatted floor systems

An overview of the reported emission data, including some data already included in the ILF BREF [43, COM 2003], is presented in Table 4.103.

Table 4.103: Emissions associated with a deep pit (in case of a fully slatted floor) or with an overflow channel for various categories of pigs

Description	NH ₃	CH ₄	N ₂ O	Odour	Source
	kg/ap/yr			ou _E /animal/s	
Deep pit - Manure removal every 2 months	4.6 ⁽¹⁾	NI	NI	NI	[266, Austria 2010]
Overflow channel - Manure removal at the end of cycle	3.64 ⁽²⁾	1.0–6.0 ⁽³⁾	0.02–0.15 ⁽³⁾	6.5 ⁽⁴⁾	[189, Germany 2010] [474, VDI 2011]
Deep pit - Manure removal at the end of cycle	2.91 (1.37–3.95) ⁽³⁾ ⁽⁵⁾	NI	NI	1.28 ⁽³⁾ ⁽⁶⁾	[269, France 2010]
	2.56 ⁽³⁾ ⁽⁷⁾	2.1 ⁽³⁾	0.035 ⁽³⁾	NI	[270, France 2010]
	4.9 ⁽¹⁾ ⁽⁸⁾	10.5 ⁽⁹⁾ ⁽⁸⁾	1.1 ⁽⁹⁾ ⁽⁸⁾	NI	[373, UBA Austria 2009]
	2.39–3.0	NI	NI	NI	[43, COM 2003]
	3.0	NI	NI	NI	[508, TFRN 2014]
	2.2 (0.8–3.6) ⁽³⁾	10.4 (1–19.8) ⁽³⁾	0.015 (0.003–0.028) ⁽³⁾	29.2 ⁽³⁾	[634, BE Flanders 2013] [642, BE Flanders 2013] [643, Van Ransbeeck et al. 2013]
	1.83 (1.51–2.14) ⁽²⁾ ⁽¹⁰⁾	5.6	0.24	NI	[662, Philippe et al. 2007]

⁽¹⁾ Values derived by expert judgement based on conclusions by analogy.
⁽²⁾ Values derived from measurements.
⁽³⁾ Measured values.
⁽⁴⁾ Calculation on the basis of an emission factor of 50 ou_E/s/LU and an average weight of 65 kg for fattening pigs from 25 kg to 110 kg.
⁽⁵⁾ The reported range corresponds to the minimum and maximum values measured at the beginning and at the end of the fattening period during the warm season.
⁽⁶⁾ Value is calculated from a reported emission of 3.8 X 10⁷ ou_E/animal place per year and 342 days in the finishing unit annually.
⁽⁷⁾ Average for the cold season.
⁽⁸⁾ Modelled values (e.g. results based on N balance).
⁽⁹⁾ Values include emissions during storage.
⁽¹⁰⁾ Value calculated from a measured mean daily emission (e.g. 4.98 ± 0.85 g/animal/day for NH₃) and for a typical mean rearing period of 117 days and 3.14 cycles per year.
 NB: NI = no information provided.

The resources demand and the breakdown for the different uses reported from Germany are presented in Table 4.104.

Table 4.104: Resources demand for the rearing of fattening pigs in houses with a fully slatted floor with an overflow channel

Resources	Unit	Demand	Breakdown values
Energy	kWh/ap/yr	26 (21–31)	Lighting: 4 (3–5) Ventilation: 20 (16–24) Feeding: 1 (0.8–1.2) Cleaning: 0.3 (0.2–0.5) Manure removal: 0.1
Fuel	kWh/ap/yr	70 (60–80)	Heating
Cleaning water	litres/ap/yr	55 (45–65)	For a large group of over 100 animals: 45
Labour	hours/ap/yr	0.90 (0.88–0.94)	Routine: 0.66–0.72 Special work: 0.22
Source: [189, Germany 2010]			

The energy required for forced ventilation is variable, but on average in Italy this has been estimated at 21.1 kWh per grower/finisher place per year [292, Italy 2001]. Table 4.105 presents ventilation rates reported from Spain, Belgium (Flanders) and Germany applied to houses with fully slatted floors.

Table 4.105: Ventilation rates (m³/h per animal place) applied to fattening pig houses with fully slatted floors

Cold season			Warm season		
Spain	Germany	Belgium (FL)	Spain	Germany	Belgium (FL)
15.7 (1–64)	7–15	6–20	66.6 (15–120)	50–115	20–80
<i>Source:</i> [187, Spain 2010] [189, Germany 2010] [637, BE Flanders 2012]					

The maximum required ventilation rates, on which the design of fattening pig houses is based, are reported to be equivalent to 80 m³/h/ap in the Netherlands and 100 m³/h/ap in Denmark.

Partly slatted floor systems

A summary of reported emission data associated with partly slatted floor systems for fattening pigs is presented in Table 4.106.

Table 4.106: Emissions from partly slatted floor systems for fattening pigs with infrequent manure removal

Slurry storage and frequency of removal	NH ₃	CH ₄	N ₂ O	PM ₁₀	Odour	Source
	kg/ap/yr				ou _E /s/animal	
Deep pit - Manure removal at least twice (2–3 times) in the cycle ⁽¹⁾	2.63 ⁽²⁾	2.42 ⁽²⁾	0.0432 ⁽²⁾	NI	NI	[271, France 2010]
Overflow channel - Manure removal at the end of the cycle or twice in the cycle (every 1–2 months)	3.64 (2–7) ⁽²⁾	4–30 ⁽²⁾	0.02–0.15 ⁽²⁾	0.24 ⁽³⁾	7 ⁽⁴⁾	[192, Germany 2010] [474, VDI 2011]
Deep pit - Manure removal twice in the cycle	3.6 ⁽²⁾	NI	NI	NI	1.21 ⁽⁵⁾	[272, France 2010]
⁽¹⁾ Indoor temperature 20.1. ± 1.0 °C (set-point temperature 18 °C). ⁽²⁾ Measured data. ⁽³⁾ Values derived by expert judgement based on conclusions by analogy. ⁽⁴⁾ Values have been calculated from an emission of 50 ou _E /s per LU and an average weight for fattening pigs of 70 kg. ⁽⁵⁾ Value derived from an emission of 36 × 10 ⁶ ou _E /year per animal place and 342 days of annual production time. NB: NI = no information provided.						

Values reported from Germany indicate a ventilation rate in the range of 7–15 m³/h/ap in the cold season and 50–115 m³/h/ap in the warm season [192, Germany 2010].

Technical considerations relevant to applicability

See Section 4.7.1.1 (fully slatted floor) and Section 4.7.1.1.1 (partly slatted floor).

Economics

The reported investment and operating costs for fattening pig houses with a fully slatted floor and an overflow channel are presented in Table 4.107, as well as the breakdown values.

Table 4.107: Investment and operating costs for fattening pig houses with a fully slatted floor with an overflow channel

Parameter	Average	Range	Breakdown values
Investment costs (EUR/ap)	350	350–420	For a large group of over 100 animals: 324
Annualised investment costs (EUR/ap/yr)	31	30–34	For a large group of over 100 animals: 33
Annual operating costs (EUR/ap/yr)	379	375–383	Feed: 200; animal: 138 Water, energy, heating: 13.5 Other: 12; labour: 14
Total cost (EUR/ap/yr)	410	NI	NA
NB: NI = no information provided; NA = not applicable.			
<i>Source: [189, Germany 2010]</i>			

Investment costs per fattening pig place in partly slatted floor housing (new plant of 4 200 places and with 0.8 m² pen surface per pig place and 40 % solid floor) without any additional system to reduce ammonia emissions are reported to be EUR 370 per fattening pig place [589, Netherlands 2010].

Driving force for implementation

See Section 4.7.1.1 (fully slatted floor) and Section 4.7.1.1.1 (partly slatted floor).

Example plants

In Germany, the variation with the overflow channel is the standard system used. In Belgium around 85 % and in France more than 80 % of the fattening and post-weaning animal places are on fully slatted floors [269, France 2010] and in Spain about a half [264, Loyon et al. 2010].

In France, 10 % of fattening pigs are reared on partly slatted floors with a deep pit; generally, in small and very old houses. Partly slatted floors with a deep pit are also reported to be rarely applied in Germany.

Reference literature

[43, COM 2003] [187, Spain 2010] [189, Germany 2010] [192, Germany 2010] [264, Loyon et al. 2010] [266, Austria 2010] [269, France 2010] [270, France 2010] [271, France 2010] [272, France 2010] [292, Italy 2001] [373, UBA Austria 2009] [474, VDI 2011] [508, TFRN 2014] [589, Netherlands 2010] [634, BE Flanders 2013] [637, BE Flanders 2012] [642, BE Flanders 2013] [643, Van Ransbeeck et al. 2013] [662, Philippe et al. 2007]

4.7.5.2 Vacuum system for frequent slurry removal (in case of a fully slatted floor)

Description

See Section 4.7.1.2.

Achieved environmental benefits

See Section 4.7.1.2. A reduction of 25 % for NH₃ emissions is reported due to frequent removal of slurry in comparison with a fully slatted floor system with a deep pit [508, TFRN 2014].

Cross-media effects

See Section 4.7.1.2.

Environmental performance and operational data

In fattening pig houses in France, emptying the slurry every 15 days reduces ammonia emissions by 20 %, compared to housing where slurry is stored throughout the whole rearing and fattening/finishing period [261, France 2010] [491, Guingand N. 2000].

Reductions of NH₃ emissions of between 30 % and 60 % are reported from Spain for fattening pigs. Ammonia emissions ranging from 0.54 kg to 1.85 kg NH₃/ap/yr were measured in Spain with a weekly removal of slurry [187, Spain 2010]. In the UK, a reduction of ammonia emissions of up to 25 % has been estimated, compared to fully slatted floors with a deep pit, due to the frequent removal of slurry by a vacuum system operated at least twice per week [648, DEFRA 2011] [500, IRPP TWG 2011]. The same performance for ammonia emission reduction (25 %) was reported by Italy, corresponding to an emission factor of 2.25 kg NH₃/ap/yr [292, Italy 2001].

Nitrous oxide emissions, from fully slatted floor housing systems with frequent removal of manure by vacuum, have been estimated in Germany for fattening pigs to be in the range of 0.02–0.15 kg N₂O/ap/yr [474, VDI 2011]. See also Section 4.7.1.2

Technical considerations relevant to applicability

See Section 4.7.1.2.

Economics

In UK, the investment costs for the implementation of this housing system in ACNV houses for fattening pigs are equivalent to EUR 270/ap/yr [267, UK, 2010]. See also Section 4.7.1.2.

Driving force for implementation

See Section 4.7.1.2.

Example plants

In Germany, the system represents the standard system for fattening pigs [500, IRPP TWG 2011].

Reference literature

[187, Spain 2010] [261, France 2010] [267, UK, 2010] [292, Italy 2001] [474, VDI 2011] [491, Guingand N. 2000] [500, IRPP TWG 2011] [508, TFRN 2014] [648, DEFRA 2011]

4.7.5.3 Vacuum system for frequent slurry removal (in case of a partly slatted floor)

Description

See Section 4.7.1.3.

Achieved environmental benefits

See also Section 4.7.1.3. A reduction of 25 % for NH₃ emissions is reported due to frequent removal of slurry in comparison to a fully slatted floor with a deep pit [508, TFRN 2014].

Cross-media effects

See Section 4.7.1.3.

Environmental performance and operational data

In the ILF BREF [43, COM 2003], the ammonia emission reduction is assumed by analogy to be between 25 % (concrete slats) and 35 % (metal slats) in comparison to fully slatted floor systems with a deep pit, which corresponds to ammonia emissions of 1.8 kg to 2.25 kg NH₃/ap/yr and 1.55 kg to 1.95 kg NH₃/ap/yr respectively.

A consumption of around 330 l/ap/yr of water is reported from Finland, representing about 1 % of the total water consumption (99 % drinking water); a labour demand of 1 h/ap/yr and bedding material consumption of 8.7 kg/ap/yr are also reported [276, Finland 2010].

Technical considerations relevant to applicability

See Section 4.7.1.3.

Economics

For a farm for 3 000 fattening pigs in Finland with a 70 % solid floor, providing 0.92 m² per animal in the pen, investment costs are reported to be EUR 400 per animal place [276, Finland 2010].

In the Netherlands, the investment costs for a fully equipped housing system that comprises 4 200 fattening pig places (40 % convex solid floor and 0.8 m deep manure channels without other ammonia abatement techniques) are reported as EUR 387 per fattening pig place (240 places per section, 0.8 m² pen surface per pig place) [589, Netherlands 2010]. See also Section 4.7.1.3

Driving force for implementation

See Section 4.7.1.3.

Example plants

See Section 4.7.1.3.

Reference literature

[43, COM 2003] [276, Finland 2010] [292, Italy 2001] [508, TFRN 2014] [589, Netherlands 2010]

4.7.5.4 Fully or partly slatted floor with slanted walls in the manure channel

Description

See Section 4.7.1.4.

Achieved environmental benefits

See Section 4.7.1.4. An ammonia reduction of up to 65 % can be attained for partly slatted floor system with a manure channel with one or two slanted walls in comparison with a fully slatted floor system with a manure pit [508, TFRN 2014].

Cross-media effects

See Section 4.7.1.4.

Environmental performance and operational data

Reported emissions associated with this technique are shown in Table 4.108.

Table 4.108: Emission levels associated with slanted walls in the manure channel

Animal	NH ₃	CH ₄	PM ₁₀	Odour	Slurry removal frequency	Source	
	kg/ap/yr			ou _E /s/animal			
Fully slatted floor, concrete slats	1.23–1.61 ⁽¹⁾	0.59–1.46 ⁽¹⁾	NI	NI	Monthly	[188, Spain 2010]	
Partly slatted floor, metal slats	1.0	NI			NI	NI	[589, Netherlands 2010]
Partly slatted floor, concrete slats	1.2						

⁽¹⁾ Measured data.
 NB: NI = no information provided.

Technical considerations relevant to applicability

See Section 4.7.1.4.

Economics

Extra costs for retrofitting the system in existing houses with fully slatted floors with a deep pit have been reported from Spain as being equivalent to EUR 6.45–7.74 per animal place per year. Referring to the produced pig, extra costs are calculated in the range of EUR 21.9–26.3 per tonne of pig produced. For new houses, the corresponding extra costs in comparison with a fully slatted floor system with a deep pit are reported from Spain to be in the range of EUR 0–0.73 per animal place or EUR 0–2.5 per tonne of pig produced [188, Spain 2010] [379, Spain 2009].

In Belgium (Flanders), the investment costs for retrofitting this system in existing houses, operating with a fully slatted floor with a deep pit, are reported as EUR 344 per animal place, including the modification of the manure pit to a water and manure channel system (see Section 4.7.1.6) [273, BE Flanders 2010]. In the case where the floor remains fully slatted after rebuilding, the above costs are reported to be equal to EUR 168 per animal place.

In the Netherlands, the reported extra investment costs for implementing the technique to standard housing with a partly slatted floor are EUR 39 per animal place when slats are triangular and made of metal, and EUR 30 per animal place when slats are made of concrete. The corresponding annual costs are EUR 5/ap/yr and EUR 3/ap/yr, respectively (including depreciation, interest, maintenance and all other operating costs, such as energy) [589, Netherlands 2010]. The same range of annual extra costs is reported by the UNECE guidance document on 'Options for ammonia mitigation' whereas the cost efficiency is equal to EUR 2 to EUR 3 per kg of NH₃-N reduced [508, TFRN 2014].

Driving force for implementation

No information provided.

Example plants

The technique is applied in Spain and the Netherlands.

Reference literature

[188, Spain 2010] [273, BE Flanders 2010] [379, Spain 2009] [508, TFRN 2014] [589, Netherlands 2010]

4.7.5.5 Scraper for frequent slurry removal (in case of a fully or partly slatted floor)**Description**

See Section 4.7.1.5. Concrete slats are used for fattening pigs.

Achieved environmental benefits

See Section 4.7.1.5. A study carried out in Denmark regarding growing/finishing pigs showed no difference in ammonia emissions between systems with scrapers and a slurry system which was emptied regularly by a vacuum system [500, IRPP TWG 2011].

Cross-media effects

See Section 4.7.1.5. From the previously mentioned Danish study, it was also observed that odour emissions are higher in systems with scrapers compared to a slurry system which was emptied regularly by a vacuum system [500, IRPP TWG 2011].

Environmental performance and operational data

In the ILF BREF [43, COM 2003], the ammonia reduction achieved for systems equipped with a partly slatted floor and a scraper was 40 % (concrete slats) to 50 % (metal slats).

The manure removal frequency in fattening pig houses with a partly slatted floor, as reported from Germany, is once to twice per day [192, Germany 2010]. A possible influence of the

design of the slatted floors on the performance of this technique is also reported (transverse slats are considered to perform better) by Denmark [500, IRPP TWG 2011].

Technical considerations relevant to applicability

See Section 4.7.1.5.

Economics

No information provided.

Driving force for implementation

See Section 4.7.1.5.

Example plants

See Section 4.7.1.5.

Reference literature

[43, COM 2003] [192, Germany 2010] [500, IRPP TWG 2011]

4.7.5.6 Frequent slurry removal by flushing (in case of a fully or partly slatted floor)

Description

See Section 4.7.1.9. A combination with a convex floor with separate slurry and manure channels is shown in Figure 4.60 (see also Section 4.7.5.10).

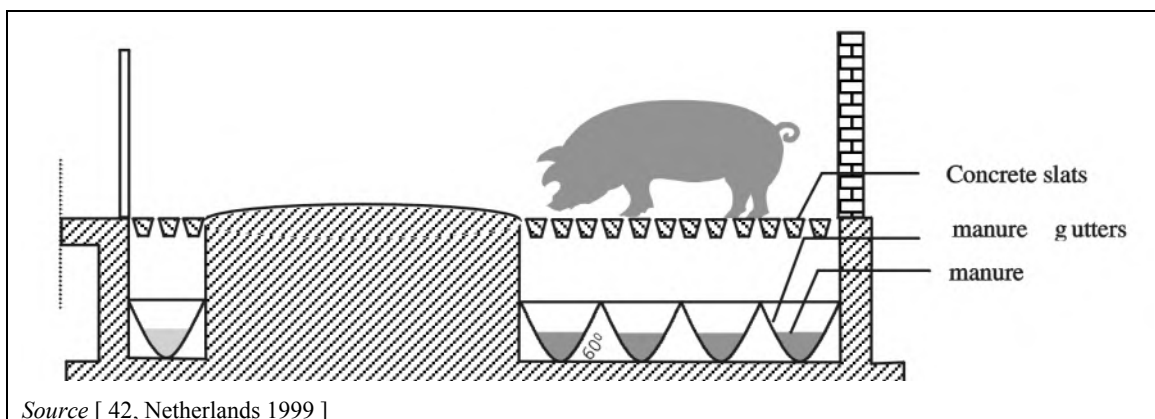
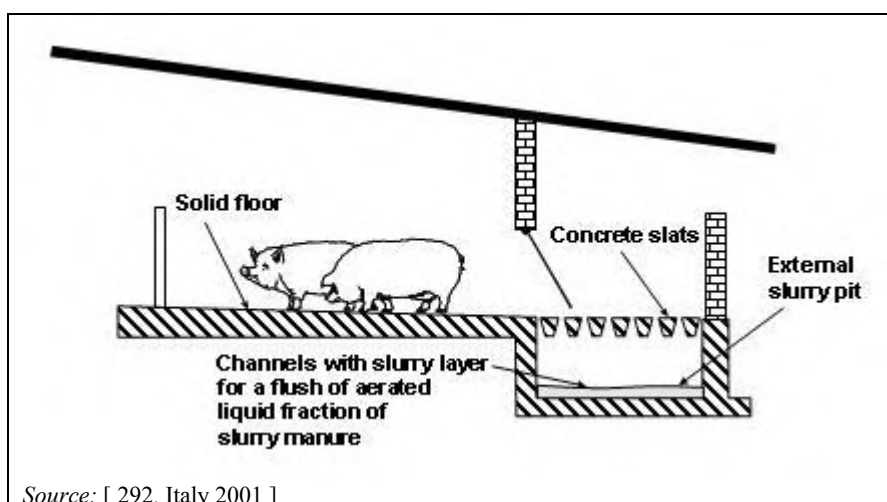

Figure 4.60: Convex floor in combination with a gutter system

The technique of flushing channels having a permanent slurry layer is also used in Italy for the management of slurry in external channels that run adjacent to the external walls (see Figure 4.61). See also Section 4.7.2.7 and Section 4.7.5.7.



Source: [292, Italy 2001]

Figure 4.61: Partly slatted floor and external alley with the flushing of a permanent slurry layer in channels underneath

Achieved environmental benefits

See Section 4.7.1.9. A 40 % ammonia emission reduction is reported for the flushing gutters technique when applied in fattening pig houses [508, TFRN 2014].

Cross-media effects

See Section 4.7.1.9.

Environmental performance and operational data

Emission data from frequently flushing channels equipped with gutters or tubes or having a permanent slurry layer with aerated slurry or no aerated slurry are presented in Table 4.133.

Table 4.109: Ammonia emissions from fattening pig houses with frequent slurry removal by flushing

Variant	Floor	NH ₃ emission ⁽¹⁾		NH ₃ emission reduction ⁽²⁾	
		Non-aerated slurry	Aerated slurry	Non-aerated slurry	Aerated slurry
		kg/animal place/year		(%)	
Gutters/tubes	FSF	1.8	1.35	40	55
Gutters/tubes	PSF concrete slats	1.2	0.9	60	70
Gutters/tubes	PSF metal slats	1	NI	67	NI
Channels with permanent slurry layer	FSF	2.1	1.35	30	50
Channels with permanent slurry layer	PSF	1.5	1.2	50	60

⁽¹⁾ Elaboration based on data from the ILF BREF (2003).
⁽²⁾ Comparison with a system with a FSF and deep pit.

NB: NI = no information provided.

Source: [43, COM 2003] [292, Italy 2001] [42, Netherlands 1999]

According to the data of the ILF BREF [43, COM 2003], in housing systems consisting of a partly slatted floor and separate manure and water channels, the energy consumption levels for flushing gutters are reported to be 1 kWh to 1.5 kWh per pig place per year for flushing, 5.1 kWh per pig place per year for liquid separation and 7.2 kWh per pig place per year for aeration (13.8 kWh per pig place per year in total). Overall energy requirements for houses with a fully slatted floor and flushing gutters range from 18.5 kWh per pig place per year (no

aeration) to 32.4 kWh per pig place per year (aeration). For flushing channels in partly slatted floor systems with a permanent slurry layer, the energy requirements are reported to be between 21.7 kWh per pig place per year (no aeration) to 38.5 kWh per pig place per year (aeration).

A study carried out in France showed that the system with a fully slatted floor and flushing gutters or flushing tubes allows the reduction of ammonia emissions, compared to the reference system, only at the beginning of fattening period. The emission levels are equivalent or even higher in the second half of the fattening period (finishing) [[261, France 2010](#)].

Technical considerations relevant to applicability

See Section 4.7.1.9.

Economics

The extra annual cost reported for new houses equipped with flushing gutters in comparison with fully slatted floor systems with a deep pit are estimated at EUR 10–15 per animal place and the cost efficiency at EUR 10–15/kg of NH₃-N reduced [[508, TFRN 2014](#)].

For other designs, no information is provided.

Driving force for implementation

See Section 4.7.1.9.

Example plants

See Section 4.7.1.9.

Reference literature

[[42, Netherlands 1999](#)] [[43, COM 2003](#)] [[261, France 2010](#)] [[292, Italy 2001](#)] [[508, TFRN 2014](#)]

4.7.5.7 Reduced manure pit (in case of a partly slatted floor)

Description

A partly slatted floor with a narrow manure pit. The manure pit is equipped with concrete slats. For the system using an external slatted alley, see Figure 4.38.

Achieved environmental benefits

The reduction of the emitting surface area reduces ammonia emissions. A 15 % to 20 % ammonia emission reduction is reported [[508, TFRN 2014](#)].

Cross-media effects

For partly slatted floors, heat stress and defecation on the solid part have to be avoided.

Environmental performance and operational data

Reported emission data, concerning ammonia and methane, are summarised in Table 4.110. From Spain, a 42 % ammonia reduction was measured for group housing of fattening pigs [[196, Spain 2010](#)].

Table 4.110: Emissions from housing systems for fattening pigs with a reduced manure pit

Animal category	NH₃ emission	CH₄ emission	Source
	kg/ap/yr	kg/ap/yr	
Fattening pigs, solid concrete floor and fully slatted external alley with storage pit	2.4	NI	[292, Italy 2001]
Fattening pigs, partly slatted floor with concrete slats, manure removal at the end of the cycle, maximum width of the pit 0.60 m	0.89–1.69 ⁽¹⁾	0.9–1.82 ⁽¹⁾	[196, Spain 2010.]
⁽¹⁾ Measured data. NB: NI = no information provided.			

Technical considerations relevant to applicability

In France, this system is used outdoors with wider channels (about 1.2 m). It is used for specific programmes against trichinellosis, with individual control before departure for slaughter.

Economics

No extra cost in comparison with a fully slatted floor system with a deep pit is reported for new houses [508, TFRN 2014]. Extra costs for the implementation of the technique in existing houses (i.e. narrowing of the manure pit by reforming a fully slatted floor with a deep pit to a partly slatted floor with one third solid floor) are reported by Spain and given in Table 4.111, including the cost efficiency of the technique. Any additional emission reduction due to frequent manure removal is not taken into account.

Table 4.111: Calculated extra costs for installing a reduced manure pit in existing houses with a fully slatted floor, in Spain

NH₃ emission reduction (%)	Extra cost (EUR/place per year)	Extra cost (EUR/t pig produced) ⁽¹⁾	Extra cost (EUR/kg NH₃ reduced)
30	3.61–4.33	12.3–14.7	3.8
⁽¹⁾ Calculated on the basis of an annual production of 294 kg of pig meat per place. Source: [379, Spain 2006] [338, Piñeiro et al. 2009]			

Driving force for implementation

Partly slatted floors are considered to improve animal welfare. Emission reduction is possible for new houses without extra costs in comparison to a deep pit with a fully slatted floor.

Example plants

In 2001 in Italy, 40 % of growers/finishers were kept in houses with an external slatted alley [292, Italy 2001].

Reference literature

[196, Spain 2010] [292, Italy 2001] [338, Piñeiro et al. 2009] [379, Spain 2009] [508, TFRN 2014]

4.7.5.8 Kennel or hut housing (in case of partly slatted floor)**Description**

See Section 4.7.1.10. The pen design is similar to the one illustrated in Figure 4.52 for weaners. The defecating areas are situated on the short sides of the pen. The covered lying area is situated along the width of the pen. Another design is shown in Figure 4.62 with the activity and feeding area over a slatted floor. Slurry is reported to be removed at the end of the cycle (overflow channel).

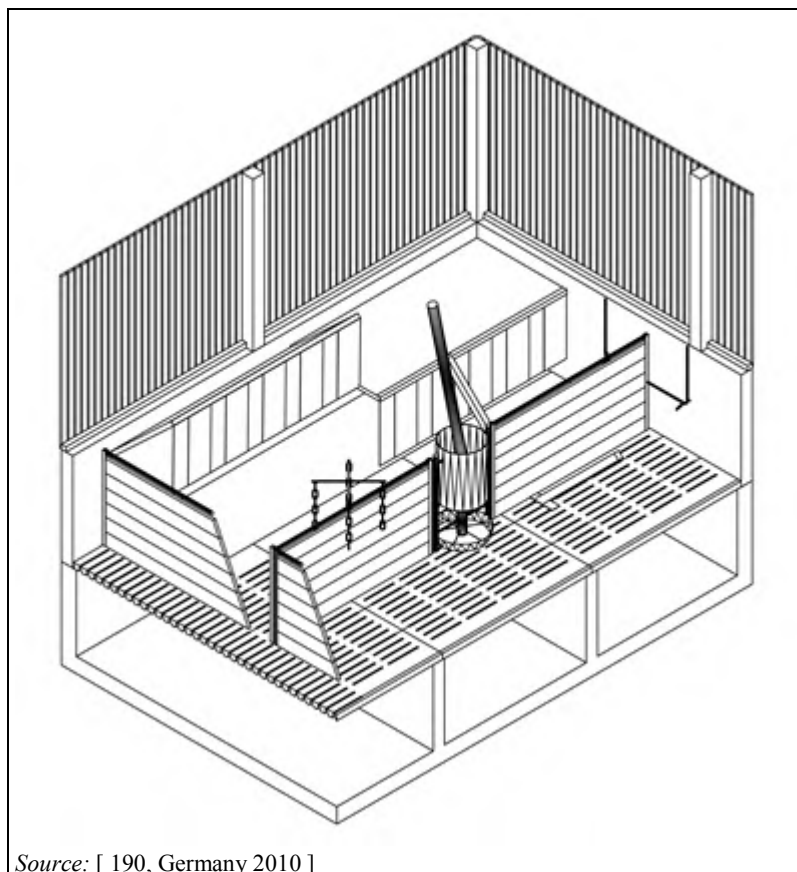

Source: [190, Germany 2010]

Figure 4.62: Kennel housing system for fattening pigs

Achieved environmental benefits

See Section 4.7.1.10.

Cross-media effects

See Section 4.7.1.10.

Environmental performance and operational data

For fattening pigs, the potential for ammonia emissions is approximately 35 % lower in naturally ventilated houses than in forced ventilated houses with fully slatted floors [575, UBA Germany 2011]. From the Netherlands, a reduction of 36 % is reported for the technique, compared to the fully slatted floor system, corresponding to an ammonia emission of 1.9 kg NH₃ per pig place per year [547, IMAG-DLO 2001].

Ammonia emissions for naturally ventilated kennel housing for fattening pigs are given at 2.4 kg NH₃/ap/yr. PM₁₀ emissions are estimated at 0.24 kg/ap/yr and odour emissions at 6.5 ou_E/s/animal [190, Germany 2010]. In the following table, data concerning energy consumption and labour requirements are presented.

Table 4.112: Consumption and labour requirements for kennel housing systems for fattening pigs

Bedding	Electricity	Fuel	Cleaning water	Labour
kg/ap/yr	kWh/ap/yr	kWh/ap/yr	l/ap/yr	h/ap/yr
0	2.5 (2–3)	0	75 (60–90)	1

Source: [190, Germany 2010]

In naturally ventilated kennel systems in Germany, fattening pigs are kept in large groups of up to 60 animals. The solid floor covers 50 % of the floor area. The reported available space per animal, applied in Germany, is 1.1 m²/fattening pig.

Technical considerations relevant to applicability

See Section 4.7.1.10.

Economics

Pig fattening in naturally ventilated houses requires greater investments, which means higher fixed expenses compared with forced ventilated fully slatted floor houses [575, UBA Germany 2011]. Additionally, the system requires a greater surface area per animal.

For new houses, the investment costs for naturally ventilated houses with a partly slatted floor and kennels are reported from Germany to be to EUR 470 per animal place. The corresponding total annualised costs are EUR 51 per animal place per year [190, Germany 2010]. The total additional costs of the technique in fattening pig housing, in comparison with a forced ventilated fully slatted floor house, are EUR 11 per animal place per year, which is equivalent to EUR 9.18 per kg of NH₃ removed, in comparison with forced ventilated fully slatted floor housing [575, UBA Germany 2011].

In addition, more labour is needed, e.g. for the cleaning of the lying kennels. The additional expenses generated by these factors, however, are compensated for by energy cost savings in the unheated naturally ventilated housing.

Driving force for implementation

See Section 4.7.1.10.

Example plants

See Section 4.7.1.10.

Reference literature

[190, Germany 2010] [547, IMAG-DLO 2001] [575, UBA Germany 2011]

4.7.5.9 Straw flow system (in case of a solid concrete floor)

Description

Pigs are reared in pens with solid floors, where a slightly sloped concrete lying area and an excretion area are clearly defined. Straw is provided to the animals daily, from a supply rack at the top of a sloped pen or dispensed from bales manually dropped into the pen. Pigs' activity pushes and distributes the litter down the pen's slope (4–10 %) to the solid manure collection aisle outside the pen (see Figure 4.63).

In the so-called straw flow system, only a small part of the pen is soiled with excreta because the pigs only excrete in the rear of the pen and keep the lying area dry and clean. The excretion area is operated as a straw-based system where farmyard manure is produced. As the straw travels down the slope, it is mixed with excreta; the daily use of straw absorbs urine, avoiding wet open surface areas. The solid fraction of the manure is removed frequently (e.g. daily) from the manure collection channels with a scraper or manually, whereas there is a drainage system for the effluent from the manure which is removed at the end of each batch or can be pumped automatically from the manure passage to a closed tank. Alternatively, the excretion area can be fitted with a slatted floor to operate the system as a slurry-based system, since only low amounts of straw are added.

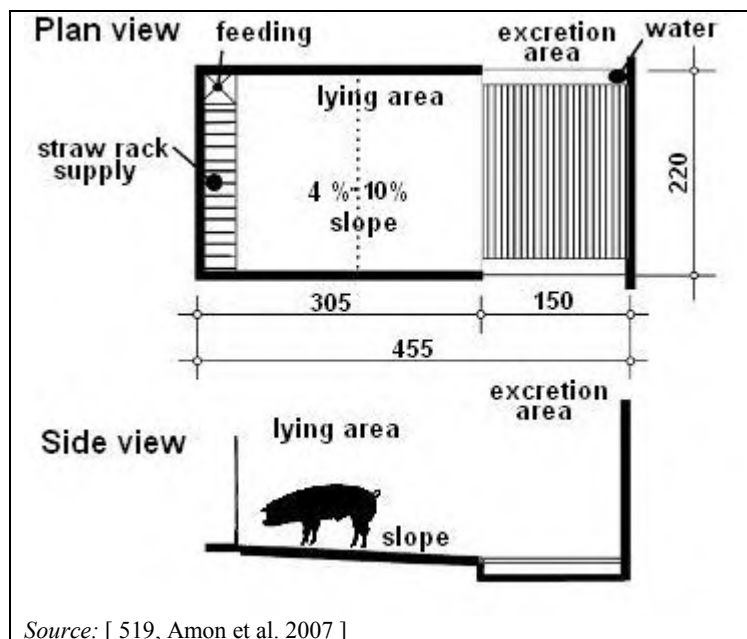

Figure 4.63: Design of the straw flow system for fattening pigs

The ventilation is frequently natural (e.g. in the UK), with systems placed in houses with open fronts or with curtains or vertical wooden planks not butted together. From the UK, it is also reported that the technique can be combined with kennels made of boards, curtains or bales of straw, in naturally ventilated houses with daily manure removal and with long straw addition [535, UK 2011].

Achieved environmental benefits

The absorption of urine into the straw and the collection of manure in the adjacent channel, which reduces the emitting surface, in combination with the frequent removal of manure from the dung channel, result in lower ammonia emissions. However, spreading of faeces and urine over the floor may enhance NH_3 volatilisation in place of promoting microbial nitrogen assimilation [590, Batfarm 2013]. The technique is efficient to reduce N_2O and CH_4 emissions due to the aeration of the manure during its management [590, Batfarm 2013].

Cross-media effects

The frequent scraping of the manure, which is removed outside, may require the covering of the manure store, in order to prevent ammonia and greenhouse gas emissions from storage [519, Amon et al. 2007] [535, UK 2011].

There is an associated risk of straw causing blocked slat voids and slurry channel blockages [624, IRPP TWG 2013].

Environmental performance and operational data

The length to width ratio of the pens is around 1.5 : 1 and the lying area to excretion area ratio is around 2 : 1, to induce pigs to dung in the rear of the pen. Sprinklers are installed in the excretion area, in order to avoid excretion on the lying area due to thermal stress in hot months [375, Philippe et al. 2007].

The reported straw consumption ranges from around 650 g/day per pig to as low as 50 g/day per pig, which is sufficient for ensuring animal welfare. With such small amounts of fibres, the excretion area can be fitted with slats or scrapers for the separation of the liquid fraction. Straw is normally provided in the form of long stems.

Reported emissions from straw flow systems are presented in Table 4.113.

Table 4.113: Emission levels from straw flow systems for fattening pigs

Housing system	NH ₃	CH ₄	N ₂ O	Source
	kg/ap/yr			
Frequent manure removal with a scraper (twice a day)	1.9 ⁽¹⁾	0.54 ⁽¹⁾	0.024 5 ⁽¹⁾	[519, Amon et al. 2007]
Infrequent manure removal without a scraper in the channel	2.1 ⁽¹⁾	1.24 ⁽¹⁾	0.039 9 ⁽¹⁾	[519, Amon et al. 2007]
Daily manual manure removal from the channel	4.89 (3.62–6.15) ⁽¹⁾ ⁽²⁾	3.26 ⁽¹⁾ ⁽²⁾	0.25 ⁽¹⁾ ⁽²⁾	[662, Philippe et al. 2007]
⁽¹⁾ Measured values. ⁽²⁾ Value calculated from a measured mean daily emission of 13.3 ± 3.45 g/animal per day for NH ₃ , 8.88 g/animal/day for CH ₄ and 0.68 g/animal/day for N ₂ O and for a typical mean rearing period of 117 days and 3.14 cycles per year.				

However, in a study in Belgium (Wallonia), this system showed ammonia emissions 2.7 times higher than a deep litter system using straw and, in addition, they were much higher compared to a conventional slurry system with slats, presumably due to the fast degradation of urea on the soiled surface of the pen, despite the separation of the liquid and solid fractions of manure and the storage of the liquid fraction (around a fifth of the total) in a closed tank. Moreover, daily manipulation in scraping solid manure may have favoured NH₃ emissions by aeration. In the same study, lower CH₄ emissions were measured but there was no difference in N₂O emissions in comparison with a fully slatted floor system with slurry removal at the end of the cycle [662, Philippe et al. 2007].

Technical considerations relevant to applicability

This technique is applicable to existing plants already equipped with a solid concrete floor, but it may not be applicable to naturally ventilated plants located in warm climates.

Driving force for implementation

This system gives the benefit of a reduced need for surface area, straw, labour and for manure storage, combined with improved animal welfare, as it allows the pigs to express their natural behaviour such as rooting, chewing and manipulation.

Economics

No information provided.

Example plants

The system is applied in many different Member States, in particular in the UK, Belgium (Wallonia) and Austria.

Reference literature

[375, Philippe et al. 2007] [519, Amon et al. 2007] [535, UK 2011] [590, Batfarm 2013] [624, IRPP TWG 2013] [662, Philippe et al. 2007]

4.7.5.10 Partly slatted pens with a convex floor and separated manure and water channels

Description

See Section 4.7.1.6. The minimum available surface area provided on the solid floor is 0.30 m² per fattening pig. The manure channel has a width of at least 1.10 metres. The maximum emitting surface per animal, in the manure channel, is reportedly between 0.18 m² and 0.27 m². If two slanted plastic walls are placed in the manure channel, the emitting surface can be

reduced further to 0.11 m² per pig. A maximum of 37 % of slatted floor for fattening pigs is reported. Slats over the manure channel are metal or concrete.

The system can be combined with a flushing system or slanted walls in the manure channel.

Achieved environmental benefits

See Section 4.7.1.6. A 40 % ammonia emission reduction is reported for fattening pigs and this increases to 60–65 % when combined with slanted walls in the manure channel [508, TFRN 2014].

Cross-media effects

See Section 4.7.1.6.

Environmental performance and operational data

Emissions are reported for the technique combined with the use of slanted walls in the manure channel and are summarised in Table 4.114.

Table 4.114: Emissions of housing systems equipped with a convex solid floor and separated manure and water channels

Housing system variation	NH ₃	PM ₁₀	Odour	Reference
	kg/ap/yr	kg/ap/yr	ou _F /s/animal	
Slanted walls, metal slats, emitting surface 0.18 m ² /animal	1.01 (0.99–1.02) ⁽¹⁾	0.153	17.9 ⁽¹⁾	[194, Netherlands 2010]
Slanted walls, metal slats, emitting surface 0.27 m ² /animal	1.4 ⁽²⁾	0.153	17.9 ⁽¹⁾	[195, Netherlands 2010]
Slanted walls, concrete slats, emitting surface 0.18 m ² /animal	1.2	NI	NI	[186, BE Flanders 2010]
⁽¹⁾ Measured data. ⁽²⁾ Values derived from measurements. NB: NI = no information provided.				

Technical considerations relevant to applicability

See Section 4.7.1.6.

Economics

The extra annual costs in relation to a fully slatted floor system with a deep pit reported for new houses are EUR 2 per animal place and the cost efficiency is EUR 2 per kg of reduced NH₃-N and EUR 2–3 per kg of NH₃-N reduced when combined with slanted walls at the manure channel [508, TFRN 2014].

Extra investment costs for the implementation of slatted pens with a convex floor and a manure channel with slanted walls are reported from the Netherlands to range between EUR 30 (concrete slats) and EUR 39 (metal slats) per animal place and the annual extra costs between EUR 3 and EUR 5 per animal place per year respectively. The comparison is made with a housing system with a partly slatted floor with 60 % solid floor, a total available surface of 0.8 m² per fattening pig and manure channels of 0.8 m [194, Netherlands 2010] [195, Netherlands 2010] [589, Netherlands 2010].

In Belgium (Flanders), the investment costs for implementing this technique (manure pit with water and manure channels, with slanted side walls) in an existing housing system with 880 animal places (operating with a fully slatted floor with a deep pit) are reported as EUR 344 per animal place for partly slatted floors or EUR 168 per animal place for fully slatted floors

[273, BE Flanders 2010] [274, BE Flanders 2010]. For newly built houses, the reported extra cost for implementing the above variation of the technique is in the range of EUR 86–109 per animal place for fully slatted floors [265, BE Flanders 2005].

Driving force for implementation

See Section 4.7.1.6.

Example plants

In the Netherlands, this system has been implemented in most new buildings and modifications of existing houses.

Reference literature

[42, Netherlands 1999] [186, BE Flanders 2010] [194, Netherlands 2010] [195, Netherlands 2010] [265, BE Flanders 2005] [273, BE Flanders 2010] [274, BE Flanders 2010] [508, TFRN 2014] [589, Netherlands 2010]

4.7.5.11 Manure collection in water

Description

See Section 4.7.4.13.

Achieved environmental benefits

See Section 4.7.4.13.

Cross-media effects

See Section 4.7.4.13.

Environmental performance and operational data

The system is under development for fattening pigs in France [500, IRPP TWG 2011].

Technical considerations relevant to applicability

See Section 4.7.4.13.

Economics

No information provided.

Driving force for implementation

See Section 4.7.4.13.

Example plants

See Section 4.7.4.13.

Reference literature

[500, IRPP TWG 2011]

4.7.5.12 Slurry cooling

Description

Slurry cooling channels or slurry surface cooling fins can be used. See Section 4.7.1.7 for slurry cooling channels and Section 4.7.1.8 for slurry surface cooling fins.

Achieved environmental benefits

See Section 4.7.1.7 and Section 4.7.1.8.

Cross-media effects

See Section 4.7.1.7 and Section 4.7.1.8.

Environmental performance and operational data

Ammonia emission values achieved by the slurry cooling channels for different housing systems and cooling effect levels are presented in Table 4.115.

Table 4.115: Ammonia emission values achieved by slurry cooling channels for different fattening pig housing systems and cooling effect levels

Housing system	Cooling effect	Ammonia emissions
	W/m ²	kg NH ₃ /ap/yr
Partly slatted floor (25–49 % solid floor), frequent removal by vacuum, no bedding	10	1.16
Partly slatted floor (50–75 % solid floor), frequent removal by vacuum, no bedding		1.52
Partly slatted floor, combined slurry and solid manure system with straw addition in the solid part, manure scraper	10–50	2.2–2.6
<i>Source:</i> [160, Denmark 2010] [268, Denmark 2010]		

In Denmark, in fattening pig houses with partly slatted floors and scrapers in manure channels, the assessed maximum ammonia emissions reduction achieved by slurry cooling channels is 40 % compared to a conventional house with a fully slatted floor, and 30 % compared to a partly slatted floor [499, AgroTech 2008].

Depending on the pen floor and system design, large variations in energy consumption may be observed. The energy requirements for the cooling channels technique for fattening pigs range between 21 kWh and 63 kWh per animal place per year depending on the cooling programme and the cooling surface of the partly slatted floor (see Table 4.116).

Table 4.116: Electricity consumption of cooling channels in partly slatted floors by the cooling effect applied

Pen design	Cooling area per pig place	10 W/m ²	20 W/m ²	30W/m ²
	m ²	kWh/ap/yr		
25–49 % solid floor	0.47	21	42	63
50–75 % solid floor	0.23	11	21	32
<i>Source:</i> [197, Denmark 2010]				

From a farm for fattening pigs in Finland, where the slurry cooling technique is implemented, but also where additives that may have an influence on emissions are used in the slurry, it is reported that ammonia and odour emissions are reduced by approximately 25 % compared with the system without the applied measures. Fuel savings are reported to be in the range of 70–80 %, due to heat recovery; approximately 90 % of the energy used for heating the housing system was obtained by recovered heat from slurry cooling. The annual fuel consumption is reported to be equivalent to 10 kWh per animal place per year, which roughly corresponds to one litre of oil per animal place per year. On the other hand, electricity requirements are reported as 60 kWh/ap/yr (the effect of energy-saving fans is also included in the value) [276, Finland 2010].

In a Danish study, in which cooling pipes were cast into the manure channels and the manure was scraped out daily, no reduction of odour emissions was observed [499, AgroTech 2008].

From the Netherlands, the ammonia emission reduction achieved by slurry cooling fins is reported to range between 50 % and 60 % in partly slatted floor systems compared to fully slatted floor systems with a deep pit and the associated emission factors range from 1.2 kg

NH₃/ap/yr (200 % cooling fins' surface/slurry surface and partly slatted floor with metal slats) to 1.4 kg NH₃/ap/yr respectively (170 % cooling fins' surface/slurry surface and partly slatted floor with metal slats or 200 % with concrete slats) [640, Netherlands 2013]. An ammonia emission reduction of 45 % is reported for fattening pig houses with partly slatted floors and slurry surface cooling [508, TFRN 2014].

For slurry cooling fins applied to partly slatted floors, the extra energy consumption is estimated as 10 kWh per fattening pig place per year [589, Netherlands 2010].

Technical considerations relevant to applicability

See Section 4.7.1.7 and Section 4.7.1.8.

Economics

In Denmark, the cooling channels technique is reported to have lower maintenance costs, compared with surface cooling fins.

From Denmark, the extra costs for the implementation of the cooling channels technique in a fattening pig house operating with a vacuum system are reported to vary in the range of EUR 0–6.8 per animal place per year, or from EUR -0.4 to EUR 1.7 per pig produced, meaning that there will be a surplus if all heat is reused elsewhere in the production.

The effect on costs of heat utilisation for different levels of slurry cooling (temperature reductions) applied to a housing system for fattening pigs, with a 50–75 % solid floor is illustrated in Figure 4.64. It shows that slurry cooling for the abatement of ammonia emissions is profitable when the system converts more than 50–60 % of the recovered energy from slurry pits into heating energy for other purposes.

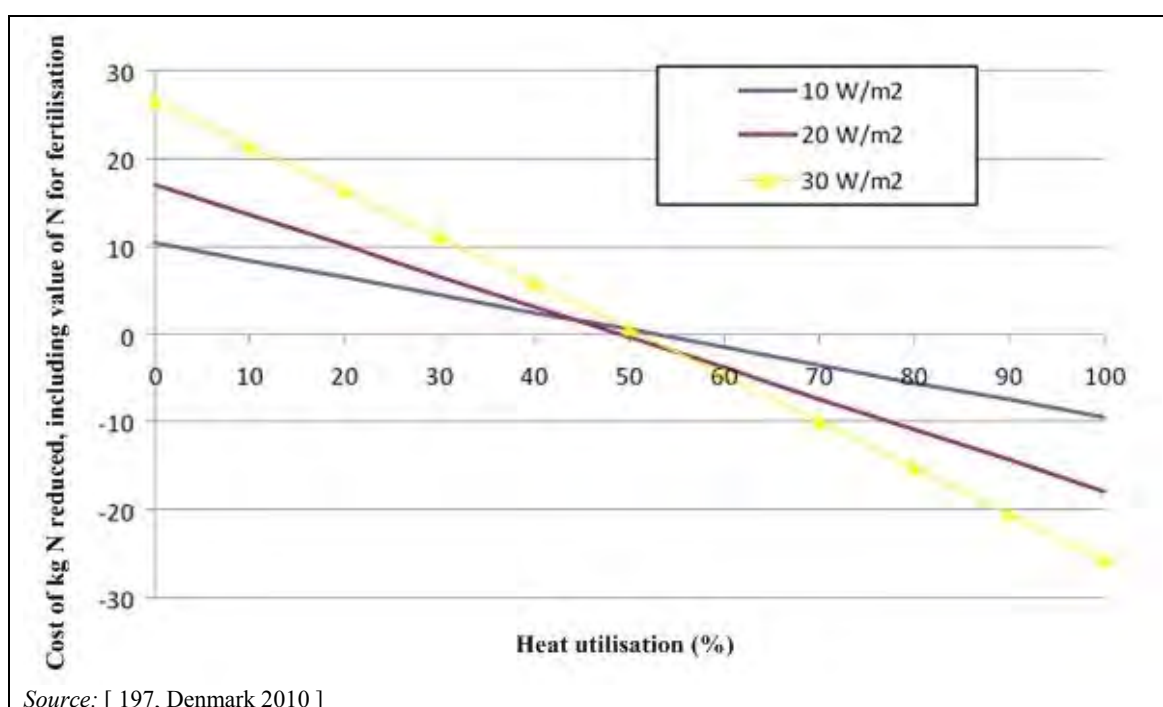

Figure 4.64: Effect on costs of heat utilisation for different levels of slurry cooling

From a farm with 3000 fattening pigs in Finland, the reported extra investment costs are equivalent to EUR 100/ap/yr, including the cost of energy-saving fans and the heat pump [276, Finland 2010].

The extra investment costs for implementation of surface cooling fins are calculated as EUR 27 to EUR 35 per animal place and the extra annual costs as EUR 5 to EUR 6 per animal place (see Table 4.78). An extra cost of EUR 5 to EUR 7 per animal place per year for new buildings equipped with partly slatted floors and surface cooling fins and a cost efficiency of EUR 4 to EUR 6 per kg of NH₃-N reduced are reported [[508, TFRN 2014](#)].

Driving force for implementation

See Section 4.7.1.7 and Section 4.7.1.8.

Example plants

See Section 4.7.1.7 and Section 4.7.1.8.

Reference literature

[[160, Denmark 2010](#)] [[197, Denmark 2010](#)] [[268, Denmark 2010](#)] [[276, Finland 2010](#)] [[499, AgroTech 2008](#)] [[508, TFRN 2014](#)] [[589, Netherlands 2010](#)] [[640, Netherlands 2013](#)]

4.7.5.13 Full litter system (in case of a solid concrete floor)

Description

Pigs are kept in one large pen or two smaller ones at both sides of the house with a central alley in between used for feeding and control. The solid floor is covered by an organic layer usually made of straw or lignocellulosic materials (e.g. sawdust). The organic layer absorbs urine, incorporates faeces and provides the animals with the opportunity to express their natural exploratory behaviour. Two basic systems are typically used for solid concrete floor houses: 'deep litter' and 'littered-floor' (see Section 2.3.1), depending on the amount of bedding material and the way it is managed, as well as on the manure removal frequency.

Littered-floor systems may be enhanced with outdoor yards; this configuration is mandatory in Germany in organic farming.

In the deep litter system, bedding is spread every week and manure is removed by front-end loaders at the end of the rearing period or after more cycles. In the littered-floor system, litter spreading and removal is carried out weekly in the indoor area and twice a week in the yard.

Generally, the main objective of the technique is to keep the bedding dry and clean. The abundance of bedding also provides protection against low temperatures. A schematic representation of a housing system with a solid concrete floor with litter is given in Figure 4.65.

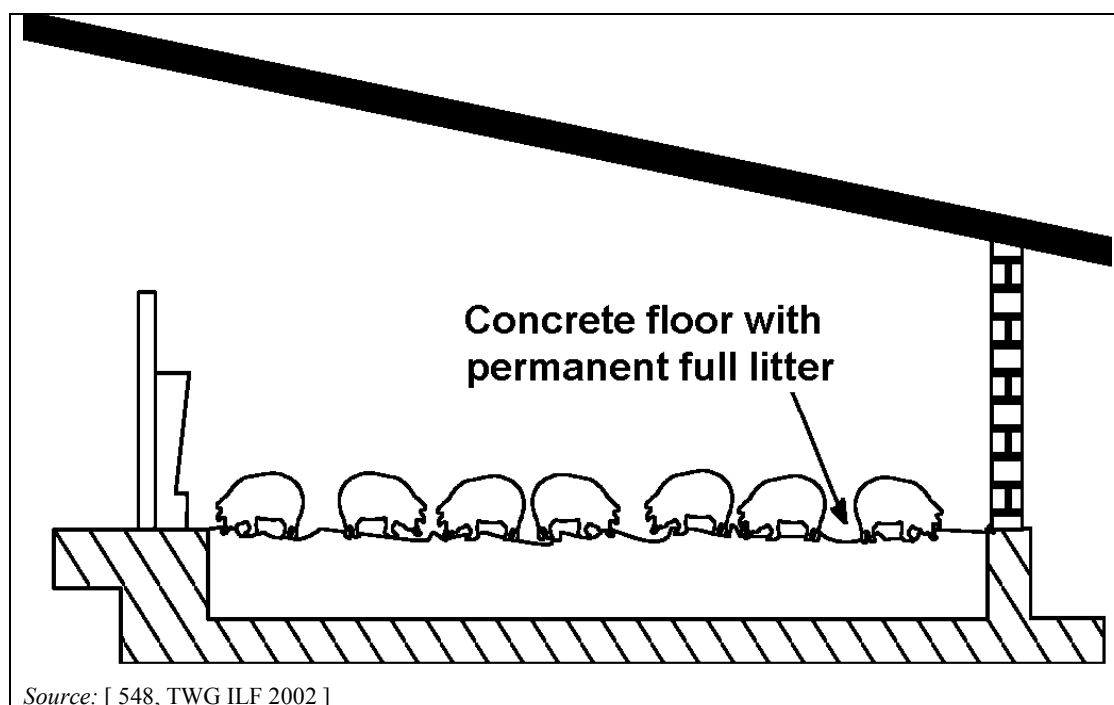

Figure 4.65: Pens with a solid concrete straw-bedded floor and natural ventilation

Littered-floor or deep litter floor houses for fattening pigs are mostly naturally ventilated. An exception is reported for deep litter systems, where a thin sawdust layer is used as bedding; in this case, closed buildings with forced ventilation are normally used [420, Ramonet 2003].

In pens with the deep litter system, the feeding area can be placed on a raised level in relation to the bedded defecating areas.

In both types of litter management (deep litter and littered-floor), automatic feeding and drinking systems are used. In general, 20–40 animals are housed per pen; the space provided per animal for the deep litter configuration is 1.1 m² and for the littered floor with an outdoor yard it is 1.5 m²/animal (0.5 m² in the yard and 1 m² in the house).

Achieved environmental benefits

Odour emissions are reduced compared to slurry-based housing systems, if the system is managed according to the best agricultural practices (e.g. supply of enough bedding material).

Energy requirements are reduced because straw, in conjunction with naturally ventilated housing systems, allows the animals to self-regulate their temperature with less ventilation and heating. The production of solid manure instead of liquid manure (slurry) is considered an advantage due to the organic matter content of the litter. Organic matter incorporated in the fields improves the physical characteristics of the soils, reducing run-off and the leaching of nutrients to water bodies.

According to some authors [289, MLC 2005] [530, Nicks et al. 2003], the NH₃ emissions arising from deep litter systems and from slatted floors are identical.

Cross-media effects

Increased dust emissions are reported. In general, in the case of poor management of the litter, ammonia, odour and nitrous oxide emissions are expected to be higher than from housing systems based on slurry. The composting process that may take place in the litter is associated with higher NH₃ and N₂O emissions (up to 1.5–3 times higher compared to slurry-based systems) [261, France 2010].

Methane emissions are considered to be low, unless anaerobic conditions prevail in the bedding material. Methane emissions are reduced if, in a deep litter system, the litter is used only for one batch [530, Nicks et al. 2003]. It is also reported that deep litter with sawdust produces lower NH₃ and CH₄ emissions than straw litter, but higher N₂O emissions [530, Nicks et al. 2003]. Management requirements for the littered-floor system are increased, since regular littering and cleaning of the yard are necessary. A more difficult control of sanitary risks is also reported from France and Denmark [500, IRPP TWG 2011].

Animal growth performance is generally affected. The average daily feed intake is reduced by 8 % and, at the same time, the average daily gain is reduced by 3 % and the food conversion ratio is reduced by 7 %. Finally, the carcass quality is slightly affected: fat and lean thickness at loin eye depth (positions G2 and M2) are increased by 1.3 mm and reduced by 2.8 mm, respectively [261, France 2010]. However, overall, the growth rate of animals is not significantly affected and the worst performance observed in litter-based farms, in comparison with slurry-based farms, is attributed partly to the specific type of production (higher age and weight at slaughter) [329, CORPEN 2003]. Other studies have found no significant differences in the performance and carcass quality of pigs housed on fully slatted floors in straw-based housing [289, MLC 2005].

Due to the higher nitrogen losses during storage and application of solid manures (by ammonia volatilisation and denitrification), there is a higher loss of fertiliser value compared to a slurry-based housing system; consequently, the use of mineral fertilisers may increase.

Environmental performance and operational data

It is expected that the use of straw will allow pigs to control the temperatures themselves in systems where insulated kennels or creeps are not used, thus requiring no additional energy for heating. The system requires cleared concrete areas in summer at feeding places for the pigs to cool down. If a covered lying area is present, the litter quantity needs to be adjusted to the temperature and the cover must be removed at high temperatures.

Emissions from fattening pig houses have been measured under various conditions of bedding material and management of the litter and are summarised in Table 4.117. Emissions due to the external yard have not been estimated [181, Germany 2010].

Table 4.117: Emission levels from housing systems with full litter for the rearing of fattening pigs

Type of litter	NH ₃	CH ₄	N ₂ O	PM ₁₀	Odour	Source
	kg/ap/yr				ou _E /s/animal	
Deep litter with straw, natural ventilation	4.2 ⁽¹⁾ (1.0–6.0) ⁽²⁾	1.6–18.0 ⁽²⁾	0.6–3.7 ⁽²⁾	0.32 ⁽¹⁾	3.9 ⁽³⁾ ⁽⁴⁾	[193, Germany 2010] [474, VDI 2011]
Deep litter with straw, forced ventilation, removal of litter after three consecutive batches, addition according to cleanliness ⁽⁵⁾	4.58–5.12 ⁽²⁾	1.87–2.78 ⁽²⁾	0.01–0.79 ⁽²⁾	NI	NI	[530, Nicks et al. 2003]
Deep litter with straw, removal at the end of cycle	4.46 (4.24–4.67) ⁽⁶⁾ ⁽¹⁾	NI	NI	NI	NI	[375, Philippe et al. 2007]
Littered floor with straw, weekly removal	2.43 ⁽¹⁾ (1.0–5.0) ⁽²⁾	0.8–2.8 ⁽²⁾	NI	0.32 ⁽⁴⁾	6.5 ⁽⁷⁾ ⁽⁴⁾	[191, Germany 2010] [474, VDI 2011]
Deep litter floor with sawdust or soft wood particles, mechanically ventilated, removal at the end of cycle ⁽⁸⁾	5.65–7.53 ⁽²⁾	NI	NI	NI	NI	[531, Ramonet et al. 2002]
⁽¹⁾ Values derived from measurements. ⁽²⁾ Measured data. ⁽³⁾ Value calculated from an emission of 30 ou _E /s/LU and an average weight for fattening pigs of 65 kg. ⁽⁴⁾ Values derived by expert judgement based on conclusions by analogy. ⁽⁵⁾ Calculations were made from measured data reported in g/head per day, for 120 days' rearing and 3.14 cycles a year. ⁽⁶⁾ Value calculated from a measured mean daily emission measurement of 12.1 ± 0.6 g/animal per day for NH ₃ and for a typical mean rearing period of 117 days and 3.14 cycles per year. ⁽⁷⁾ Value calculated from an emission of 50 ou _E /s/LU for an average weight for fattening pigs of 65 kg. ⁽⁸⁾ Calculations were made from measured data reported per animal place and for 3.14 cycles a year. NB: NI = no information provided.						

The amount of straw or other bedding material varies for different animal categories. For deep litter floors, the amounts of applied straw are approximately 1–1.2 kg per fattening pig per day, or 275–400 kg/animal place per year in Germany, while UK farms apply 250–300 kg/ap/year [624, IRPP TWG 2013]. For littered-floors, the amount of straw is in the range of 250–300 kg/animal place per year in Germany, while UK farms apply 125–150 kg/ap/year (see summary of resources demand in Table 4.118).

A summary of resource requirements as reported from Germany, for the two variants of the technique, is presented in Table 4.118.

Table 4.118: Resource requirements associated with deep litter and littered-floors applied to fattening pigs housing systems ⁽¹⁾

System	Electricity	Bedding material	Water	Fuel	Source
	kWh/ap/yr	kg/ap/yr	l/ap/yr	kg/ap/yr	
Deep litter	8 ⁽²⁾	350 275–400	120 100–180	NI	[193, Germany 2010]
Littered floor combined with yard	3 2.5–4	275 250–300	115 90–140	0	[191, Germany 2010]

⁽¹⁾ Data refer to open, non-insulated buildings, naturally ventilated, with solid concrete floors for fattening pig housing (28–118 kg).
⁽²⁾ Energy breakdown (kWh/ap/yr): feeding: 1; manure removal/cleaning: 4.8; lighting: 2.
 NB: NI = no information provided.

From France, it is reported that in deep litter systems when thick sawdust bedding (from 60 cm to 80 cm) is used, the average requirement for sawdust is about 60 kg per fattening pig, when only the surface layer is removed and, consequently, the deep layer can be used for several fattening periods. In thin sawdust bedding, the thickness of the litter is reduced to approximately 20 cm, and then the average requirement will be 30 kg per animal. When straw is used, the average requirement per pig is 70 kg for the deep litter system and 45 kg for the littered-floor system [329, CORPEN 2003].

Sawdust bedding should be replaced at least every two successive batches, in order to reduce ammonia emissions [530, Nicks et al. 2003]. The substitution of straw with other types of litter is done for similar amounts of dry matter [531, Ramonet et al. 2002] [532, Nicks et al. 2002].

The average characteristics of the solid manure, produced with the use of straw and sawdust as bedding material, are presented in Table 4.119, based on experimental datasets gathered in France for fattening pigs in deep litter.

Table 4.119: Average characteristics of solid manure produced by deep litter housing systems for fattening pigs, in France

	Unit	Straw	Sawdust
Type of bedding			
Quantity of bedding used	kg/pig	62.2 ± 15.4 (mixed) 54.4 ± 14.2 (dry)	58.1 ± 21.8 (mixed) 40.5 ± 11.7 (dry)
Quantity of produced manure	kg/pig	202 ± 52 (mixed) 61 ± 14 (dry)	141 ± 44 (mixed) 53 ± 18 (dry)
Manure composition			
Dry matter	%	30.5 ± 8	37.5 ± 6.3
Total N	g/kg of manure	9.7 ± 1.9	7.7 ± 2.5
Ammoniacal N	g/kg of manure	1.4 ± 0.7	1.2 ± 0.7
P	g/kg of manure	3.6 ± 1.5	4.2 ± 1.6
K	g/kg of manure	11.6 ± 3.9	11 ± 3.9

Source: [329, CORPEN 2003]

Technical considerations relevant to applicability

In houses with natural ventilation, the technique may not be applicable to houses located in regions with warm climates. The system can be applied in all new housing. For existing housing, this technique may be applicable in buildings with solid concrete floors. Design details will vary. The scarcity of bedding materials in some geographical areas may be a limitation to the use of these systems.

Economics

Investment costs are reported from Germany as EUR 400 per animal place for the deep litter system, which corresponds to an annualised investment cost of EUR 40/ap/yr, and EUR 454 per animal place for the littered floor with yard.

Straw prices and bedding availability vary considerably from area to area, inducing different economic results. Examples of extra costs, in comparison with the fully slatted floor system with a deep pit, as reported from Spain are shown in Table 4.120.

Table 4.120: Extra costs for implementation of straw littered housing systems for fattening pigs in comparison to a fully slatted floor system with a deep pit

Type of litter	Type of house	Extra costs ⁽¹⁾ (EUR/ap/yr)	Extra costs ⁽¹⁾ (EUR/tonne pig produced)
Littered system with weekly replacement of bedding and two functional areas	Existing houses	36.51–42.07	124.2–143.1
	New houses	20.16–25.72	68.6–87.5
⁽¹⁾ Extra costs include the cost of construction of a store (60 m ²) for manure until landspreading.			
Source: [379, Spain 2009] [338, Piñeiro et al. 2009]			

From the UK, the extra cost of production in a straw-based housing system, in comparison with a fully slatted floor system, was measured as approximately EUR 34 per tonne of pig meat produced (EUR 1 = GBP 0.88), due to the increased labour input and the requirement for bedding material [289, MLC 2005].

In Denmark, even though this system is less expensive than a traditionally insulated house operating with slurry, other economic factors do not favour the implementation of littered housing systems, such as:

- extra operating cost for purchasing straw;
- poorer growth performance;
- difficulty in controlling certain diseases;
- extra labour requirements;
- reduced utilisation of nitrogen (lower fertiliser value which will result in the need to use 1.1 kg of additional nitrogen from mineral fertilisers to compensate for the loss of 1 kg of nitrogen from the manure as compared to the use of slurry).

Concerning all these aspects, an extra cost of at least EUR 10 per pig produced is added for Danish conditions [500, IRPP TWG 2011].

Driving force for implementation

Improved animal welfare due to the comfort provided by the straw and the increased space available per animal is a driver. The energy requirements are also lower in the case of natural ventilation.

Example plants

In France, around 5 % of the fattening places were using littered housing systems in 2008. Furthermore, the use of deep litter systems with straw or thin sawdust bedding is increasing compared to the littered-floor systems with straw and the deep litter system with deep sawdust bedding [261, France 2010].

Reference literature

[39, Germany 2001] [157, Germany 2010] [181, Germany 2010] [185, Germany 2010] [191, Germany 2010] [193, Germany 2010] [261, France 2010] [289, MLC 2005] [291, IRPP TWG 2002] [292, Italy 2001] [329, CORPEN 2003] [338, Piñeiro et al. 2009] [375, Philippe et al. 2007] [379, Spain 2009] [420, Ramonet 2003] [474, VDI 2011] [500, IRPP TWG 2011] [519, Amon et al. 2007] [530, Nicks et al. 2003] [531, Ramonet et al. 2002] [532, Nicks et al. 2002] [548, TWG ILF 2002] [624, IRPP TWG 2013]

4.7.5.14 Littered external alley (in case of a solid concrete floor)

Description

The system combines an indoor solid concrete floor with no litter and a littered external alley. A small door allows the pigs to go out to defecate in an external alley with a concrete floor that is covered with straw (0.3 kg straw per pig per day) and that has a slight slope (4 %) that ends in a manure alley with a scraper (see Figure 2.23). By moving around in the external alley, the animals push the straw with the manure into the lateral channel. All the manure falls into the channel and is scraped one step down, and once a day it is scraped onto a manure belt. The lateral channel is fenced off, allowing space for the sludge to pass.

A scraper removes the sludge (3–7 kg solid matter per pig per day) to a solid manure heap. The sludge is moved along a channel that has a perforated area just before where the sludge is dragged upwards towards the manure heap and this allows most of the fluid to be drained. The manure heap itself is also drained, and the liquid is collected (approximately 0.5–2 litres of liquid per pig per day) in a suitable basin underneath the storage.

Achieved environmental benefits

A reduction in ammonia emissions of 20 % to 30 % is achieved compared to the fully slatted floor system.

Cross-media effects

The energy use of the system is about 6 kWh operating 0.5 hours per day in a housing unit for 450 pigs (2.43 kWh/animal place/year). Odour might be a problem if not enough straw is used [291, IRPP TWG 2002].

Environmental performance and operational data

Ventilation is natural and operated manually. Automatic (phase) feeding and watering is applied. Heating is not required. A reported associated emission factor is 2.4 kg NH₃/animal place/year.

Technical considerations relevant to applicability

Systems with an external alley are not applicable in cold climates. In France, this system is used for specific programmes against trichinellosis, with individual control before departure for slaughter.

The use of litter on the solid floor inside the house is not recommended for Italian heavy pigs because they are normally fed with liquid feed, and the litter becomes too moist in a very short time. Using litter only in the external alley prevents this negative effect and at the same time maintains the solid manure production. The solid manure is landspread where it has a positive effect on soil structure.

Economics

The costs for implementing and running this system are not expected to differ significantly from those given in Section 4.7.5.13.

Example plants

One farm in Italy (Reggio E. – Maccacani farm).

Reference literature

[291, IRPP TWG 2002] [292, Italy 2001]

4.7.5.15 V-shaped manure belts (in case of a partly slatted floor)**Description**

V-shaped manure belts roll inside the manure channels of partly slatted pens, covering the whole channel surface, so that all faeces and urine are dropped onto them. Belts are made of plastic, polypropylene or polyethylene and operate frequently (at least twice a day) to separately discharge urine and faeces from the animal house to closed manure storage.

Manure belts can fit channels in partly slatted pens with an inclined solid floor (4.5–5 °) at the front of the pen or with a convex solid floor with two manure channels at the front and at the back of the pen. The housing system is generally designed to provide a surface area in the pen in the range of 0.75–1 m² per animal place, of which at least 0.30 m² per animal should be solid.

In farms using this technique, one or two floors are possible in the house. Proper operation is monitored by the rotation frequency of the manure belts.

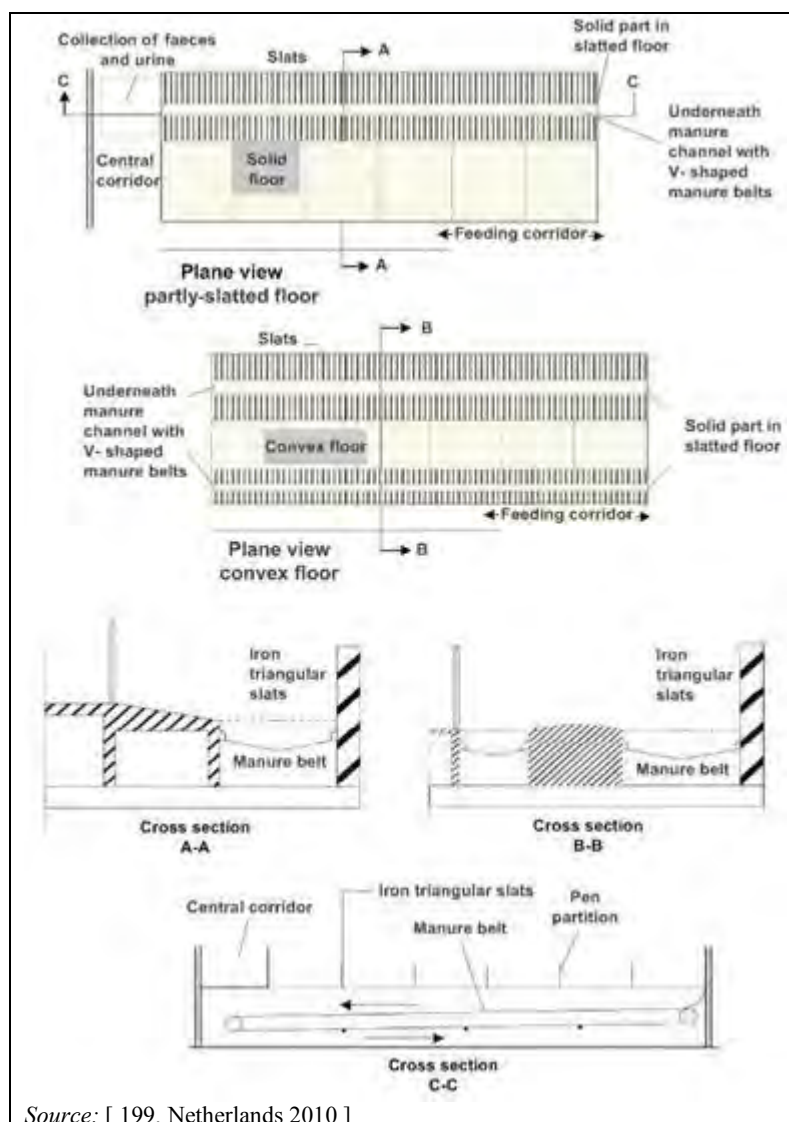

Source: [199, Netherlands 2010]

Figure 4.66: Schematic plans and sections of housing systems equipped with V-shaped belts

Achieved environmental benefits

The system allows a notable reduction of ammonia and odour emissions due to the daily separate removal of urine and solid manure, by means of the V-shaped belt, compared to a conventional house.

Cross-media effects

The system requires slightly increased energy consumption, to operate the manure belts.

Cleaning of the belts is needed after each production round. A maintenance contract is also reported as necessary, for a complete check of the belts and the whole equipment at least once a year.

If the equipment breaks down, then manure and urine accumulate rapidly, making the service more difficult and complex. In this case, alternative arrangements are necessary for the housed pigs [624, IRPP TWG 2013].

Environmental performance and operational data

Reported emissions are shown by surface in Table 4.121.

Table 4.121: Emissions associated with the use of the V-shaped belt system in partly slatted floor systems

Available surface area per pig	Ammonia	Methane	N ₂ O	Odour
	kg/ap/yr	kg/ap/yr	kg/ap/yr	ou _E /s/animal
0.8 m ² , of which 0.3 m ² is solid floor	1.05	0.94	0.11	5.9
1 m ² , of which 0.3 m ² is solid floor	1.20			
Source: [198, Netherlands 2010] [200, Netherlands 2010]				

With this technique, ammonia emissions measured in the Netherlands are 58–70 % (depending on the area per pig) lower than from a conventional housing system with a deep pit below the slatted floor, while odour emissions are 74 % lower in comparison with the standard emission factor used in the Netherlands for fattening pig houses (23 ou_E/s/animal).

Technical considerations relevant to applicability

The technique is applicable to both fattening pig farms and sow farms. However, it is only suitable for new buildings.

Economics

The total costs of the technique (including investment costs, electricity and gas costs and manure management costs) have been calculated in comparison with a conventional housing system; the results show an annual cost benefit equivalent to approximately EUR 8 per animal place for a house with one floor, and EUR 10 for a house with two floors due to the following reasons:

- In the Netherlands, separated urine has lower management costs than slurry. An average slurry generation of 1.1 m³ per animal place per year is assumed.
- The lower investment costs reported for the system, in comparison with a conventional house, are due to the higher share of steel among the materials for construction of the system and are based on early 2007 prices. If steel prices rise by 25 %, then an additional cost of EUR 0.8 per animal place for the house with a single floor and EUR 1.35 per animal place for the house have to be considered.
- In the house with two floors, energy costs are lower, because the heat from the bottom floor partly heats up the top floor.

Detailed investment and annual costs reported from the Netherlands, in comparison with a conventional system for growing/fattening pigs are presented in Table 4.122, including the case of a house with two floors.

Table 4.122: Investment and operating costs for partly slatted floor systems with V-shaped manure belts, compared to conventional houses, in the Netherlands

	PSF with V-shaped manure belts (one floor)	Conventional house	PSF with V-shaped manure belts (two floors)	Conventional house
Animal places	2 160	2 160	4 320	4 320
Investment costs, VAT included (EUR/ap)	436	501	423	467
Annualised investment cost ⁽¹⁾ (EUR/ap/yr)	50.26	55.91	48.02	52.19
Electricity and gas costs (EUR/average present pig)	6.9	6.9	3.5	6.9
Manure management costs (EUR/average present pig)	14.08	16.5	14.08	16.05
Total costs	71.24	79.31	65.6	75.9
⁽¹⁾ Costs include buildings plus devices.				
<i>Source:</i> [609, UR Wageningen 2007]				

Driving force for implementation

The direct separation of urine and the solid part of the manure is an advantage. This system has been designed in the Netherlands, where the pressure on the environment from livestock rearing is considered excessive, hence the system is seen as a way to improve the sustainability of pig rearing.

Example plants

This system is in use in two Dutch farms.

Reference literature

[198, Netherlands 2010] [199, Netherlands 2010] [200, Netherlands 2010] [609, UR Wageningen 2007] [624, IRPP TWG 2013]

4.8 Techniques for the reduction of emissions to air within housing

4.8.1 Introduction

Emissions to air arise from the bedding and manure that are kept inside livestock houses. Techniques are in use to improve the indoor air quality and remove air pollutants before they are released from the housing. At the same time, an improvement of the animals' living environment and the working conditions is attained as, mainly, excessive heat and dust are removed.

In general, it can be expected that all process-integrated measures for the reduction of dust emissions contribute to the prevention of epizootic diseases and the reduction of bioaerosol emissions [474, VDI 2011].

These techniques are presented separately from the end-of-pipe techniques that treat air as a last step before releasing it to the environment (see Section 4.9). Techniques presented in this section do not include those concerning the housing systems or techniques that achieve emission abatement by changing the properties of manure and, in this way, have an effect on the whole chain of manure management, e.g. slurry acidification. Techniques presented in the next sections are mostly 'secondary' measures, being additional processes that do not change the fundamental operation of the core process and that, in general, are characterised by a low level of complexity.

4.8.2 Ionisation

Description

The negative air ionisation system consists of two units. A high-voltage unit is used to convert the AC of the power supply system to a DC at -30 kV and a low amperage of below 2.0 mA to ensure safety. The unit is connected to a system of wires (discharge electrodes or ion generators) with needle-shaped pins that run along the length of the house, underneath the ceiling surface. The high voltage on the wires creates an electrical field between the wires and the ceiling and any other grounded surfaces (e.g. a grounded collection plate). The electrons emitted from the pins move over the field towards the ceiling, thereby charging negatively dust particles that are encountered, which are then directed towards the grounded plates and are collected by electrostatic attraction on grounded room surfaces or collector plates. The deposited fine dust is removed after each growing cycle by normal cleaning (see Figure 4.67).



Source: [377, Netherlands 2010]

Figure 4.67: Effect of dust attraction caused by ionisation on the roof of a poultry shed

Achieved environmental benefits

The indoor dust concentration and dust emissions are reduced.

Cross-media effects

Increased energy use is necessary to supply the high-voltage unit. Care has to be taken to ensure that the model of ioniser does not release significant quantities of ozone.

Environmental performance and operational data

Fine dust emissions are reduced by 36 % for PM₁₀ and 10 % for PM_{2.5} fractions during the whole broiler growing period [137, Netherlands 2010]; with average concentrations of 1.01 mg/m³ and 0.07 mg/m³ for PM₁₀ and PM_{2.5}, respectively [569, UR Wageningen 2009]. Reported values for dust emissions per broiler place per year are 0.0117–0.0201 kg for PM₁₀ and 0.00058–0.00142 kg for PM_{2.5} [137, Netherlands 2010].

The minimum current intensity from the high-voltage power supply is 1.3 mA. At least 0.45 m of discharge electrodes are placed per square metre of ground area. The minimum height of the discharge electrodes is 2.5 m above the floor. The minimum distance to the grounded surfaces is 0.2 m. The roof and equipment in the housing should be grounded to prevent the accumulation of electrostatic voltage. Emitters cannot be installed under fans or ventilation channels.

Adequate safety measures need to be applied. The installation needs to be made to the highest professional standards and checked by an expert before connecting to the power source. Weekly control is needed to maintain the correct functioning.

Technical considerations relevant to applicability

The technique may not be applicable to pig plants or to existing poultry houses due to technical and/or economic reasons.

Economics

Investment costs for the acquisition of the necessary equipment (source of ionising radiation and 200 m of wire with emitters), for treating a surface of approximately 450–600 m² in a fattening pig house, is reported as approximately EUR 2 000. The corresponding annual operating costs, including higher energy consumption, were reported as approximately EUR 8 per animal place [154, Czech Republic 2010].

For broilers, in the case of a Dutch farm with 90 000 bird places, the extra investment costs per animal place are reported as EUR 0.65, while the annual operating costs are EUR 0.01 per animal place. After amortisation (7 years) of the extra investment costs, the total annual extra cost is calculated as about EUR 0.1 per animal place [503, Vermeij 2011].

Driving force for implementation

Workers and animals can enjoy better conditions because of the lower dust concentration. The abatement of dust concentration also reduces the transportation of airborne transferable diseases.

Example plants

The technique is in use on two Dutch farms for broiler production, where extra measurements are carried out for validating the effective reduction of dust emissions.

Reference literature

[137, Netherlands 2010] [154, Czech Republic 2010] [377, Netherlands 2010] [503, Vermeij 2011] [569, UR Wageningen 2009]

4.8.3 Water fogging

Description

Water is sprayed by nozzles at a high pressure to produce fine droplets that fall by gravity to the floor, moistening dust particles of a similar size that become heavy enough to drop as well. At the same time, indoor air is cooled as water droplets absorb heat and evaporate. The frequency of the water injections is controlled by the ambient temperature or by the relative humidity.

At a droplet size of up to around 10 micrometres size (reached at a pressure of 70–100 bar), evaporation takes place very quickly, so that walls or animals are not moistened. The operation of these systems at a lower pressure (7–17 bar) produces a misting effect with the spraying of droplets of around 200 micrometres size.

Achieved environmental benefits

Dust emission reduction is achieved. Odour and ammonia emission reduction is possible by limiting the dispersion of dust particles, to which odorous compounds are attached, and by lowering indoor temperatures. However, positive results are not always consistent [[360, Boulestreau 2006](#)].

Cross-media effects

Water and energy consumption are increased. Fogging can have a significant impact on energy consumption, in particular at the start of the poultry rearing period. At the end of the rearing period for solid manure systems, when the nitrogen excretion is significant, it can provoke high ammonia and odour emissions due to excessive fogging or the big droplets applied [[624, IRPP TWG 2013](#)]. In addition, moist bedding/litter needs to be avoided as this may impact negatively on animal welfare, especially for poultry.

Environmental performance and operational data

The abatement of pollution in the indoor air of fattening pig houses is achievable in the range of 22–30 % for ammonia, 14–46 % for dust and 12–23 % for odour [[261, France 2010](#)].

The water and energy consumption depends on the climatic conditions where the technique is also used for cooling the indoor housing environment. In tests carried out in France for 3 years, average consumption levels of 264 kWh for electricity and 17 m³ for water were measured for each summer period of 90 days in a gestating sow house with 100 places, where a compressor of 1.1 kW was used for spraying 18 hours a day in a cycle of maximum length of 30 seconds.

Tests carried out in fattening pigs after the installation of a fogging system showed that a reduction of the water consumption by animals of about 0.5 litres per pig per day can compensate the water consumption of the fogging system (about 70 litres per pig) [[361, France 2010](#)].

The fogging system can reduce the ambient temperature by 4 °C to 7 °C during the warmer hours of the day, whereas a traditional cooling system allows a maximum reduction of around 4 °C [[358, France 2010](#)].

Technical considerations relevant to applicability

The technique is applicable to new and existing houses, for both pigs and poultry production. The applicability may be restricted for solid manure systems at the end of the rearing period due to high ammonia emissions.

Animals can feel a thermal decrease during fogging. Therefore, for the use of the technique, care must be taken at sensitive stages of the animals' life and with the climatic conditions. In cool areas with high humidity levels, maintaining suitable levels of relative humidity without over-ventilating heated pig houses is a challenge, in order to avoid the risk of provoking respiratory problems in the pigs [[624, IRPP TWG 2013](#)].

Economics

Investment costs to equip fattening pig housing are as low as EUR 3.8 to EUR 6 per animal, while costs per sow reach EUR 10. Table 4.123 compares fogging to other water spraying techniques that are in use for the purpose of cooling the indoor environment.

Table 4.123: Parameters and performances of fogging in poultry housing compared to other cooling systems techniques

Cooling system	Use	Investment (EUR/m ²)	Pressure (bar)	Advantages	Disadvantages
Water spraying of incoming air	Not used with natural ventilation. Only for temperatures below 35 °C	1.5–2	3–5	Low costs	Low cooling effect, higher water consumption
Medium-pressure water fogging	When ventilation is natural, internal mixing of air is needed. Temperature > 35 °C	2.5–3	20–70	Good cost/efficiency rate	Risk of moistening the litter, medium cooling effect
High-pressure fogging	When ventilation is natural, internal mixing of air is needed. Temperature > 35 °C	5–8	> 70	Highly efficient and homogenous cooling	Sensitive to water quality
Pad cooling	Not used with natural ventilation. Temperature > 35 °C	5–8	< 3	High cooling efficiency behind the pad, low sensitivity to the water quality	Sensitive to pathogen development

Source: [354, ITAVI 2004]

The estimated costs for the application of a fogging system to a standard broiler house of 1 000 m² are presented in Table 4.124.

Table 4.124: Estimation of the annual operating costs for a fogging system

Cost factor	Consumption of resources	Costs (EUR)
Water consumption	100 m ³ (EUR 0.76/m ³)	76
Maintenance	1 maintenance visit	150
Replacement parts	1 filter per year, oil for pump circuit, nozzles maintenance, pump replacement parts every 3 years	150
Electric consumption	5 CV pump (EUR 0.05/kWh)	55

NB: Data reported for a system operating 30 days for 10 hours/day in a standard broiler house of 1 000 m² in France.

Source: [354, ITAVI 2004]

For an amortisation over 5 years, the total annual costs (investment: EUR 8/m², annualised investment cost: EUR 1.6/m², annual operating cost: EUR 0.43/m², total annual costs: EUR 2.03/m²) would range from EUR 0.078 to EUR 0.156 per broiler place (animal density from 13 to 16 birds/m²).

Driving force for implementation

The reduction of mortality, especially in poultry, and the improvement of fertility parameters in sows are the most significant improvements achievable for animal productivity. The average improvement of fertility in mating/gestating sows in hot summers is reported to be 10 % after the installation of a fogging system [358, France 2010].

In hot summers, animal mortality due to heatstroke causes economic losses of about 12 % in chicken rearing and 6.5 % in turkey rearing. A reduction of these losses by about 90 % for broilers and 80 % for turkeys can be achieved with fogging (for a temperature of 35 °C and a humidity level of 40 %) [354, ITAVI 2004].

Example installations

Fogging has also been reported to be used at latitudes as high as Finland where it is financially supported for improving animal welfare [144, Finland 2010].

Reference literature

[144, Finland 2010] [261, France 2010] [354, ITAVI 2004] [358, France 2010] [360, Boulestreau 2006] [361, France 2010] [368, France 2010] [624, IRPP TWG 2013]

4.8.3.1 Misting of capturing and reactive agents

Description

The same equipment used for fogging is used. Specific hydrosoluble compounds are dispersed in a mist through diffusion devices operating at a high pressure. Their molecular structure allows them to capture odorant molecules (gaseous or dust-conveyed), to inactivate them and eventually to transform them into their stable and non-odorant form. Dispersion in a mist also maximises the compounds' reactive surface in contact with the odorous substances to eliminate them, or to transfer them from the gaseous phase to the liquid phase; in this way, the biodegradation of the odorous pollutants is accelerated.

Sprayed chemicals may have patented formulations. These products are formulated from active ingredients of plant origin and, from a chemical standpoint, the active substances are derivatives of carboxylic acids.

Achieved environmental benefits

Odours may be reduced.

Cross-media effects

Water consumption is increased. Documentation on the absence of environmental consequences or effects on animal or human health of the chemical compounds used was not provided for the drafting of this document. In general, chemical substances need to be registered and produced complying with the REACH regulation (Regulation 2006/1907 of the European Parliament and of the Council of 18 December 2006 concerning the Registration, Evaluation, Authorisation and Restriction of Chemicals). Producers are requested to certify the absence of cross-media effects on health and the environment.

Environmental performance and operational data

The applied amounts are adapted to the rearing conditions, temperature and humidity. The application in pig sheds can be done for example with diluted products at 1 % sprayed through nozzles with a capacity of 4 l/h, in treatments of 14 seconds at 6-minute intervals. For poultry, one example of dilution is 0.8 %, with spraying intervals of 30 seconds every 10 minutes.

The reduction efficiency achieved for indoor ammonia concentrations is reported to be 79 % for a fattening pig house, and 90 % for a broiler farm, with final NH₃ concentrations of around 2 ppm. Odours are reported no to be detected by experts within a range of 200–300 m around the buildings [279, Fefana 2010]. Achieved abatement efficiencies for a group of substances,

monitored on the basis of their nature and odour in laboratory trials, are reported in Table 4.125. A complete olfactory measurement was not provided.

Table 4.125: Odour abatement efficiencies achieved by misting of reactive agents in laboratory trials

Compound type	Formula	Odour threshold (mg/m ³)	Abatement efficiency (%)	Type of odour
Ammonia	NH ₃	20	91.4	Pungent, irritant
Hydrogen sulphide	H ₂ S	1×10 ⁻³ –5×10 ⁻³	54.0	Bad egg
Trimethylamine	(CH ₃) ₃ -N	0.5×10 ⁻³	89.2	Bad fish
Butyraldehyde	C ₃ H ₇ -COH	20×10 ⁻³ –50×10 ⁻³	50.2	Apple
Butyric acid	C ₃ H ₇ -COOH	4×10 ⁻³ –50×10 ⁻³	89.6	Rancid butter
<i>Source:</i> [279, Fefana 2010]				

Technical considerations relevant to applicability

No technical restrictions are reported for the implementation of the technique.

Economics

Costs per animal produced have been reported, depending on the amount of atomised product needed per capita. Average costs are shown in Table 4.126.

Table 4.126: Estimates of average costs for the atomisation of patented odour-abating chemicals by animal produced

Animal produced	Product consumption	Average operating cost (EUR/animal produced)	No of cycles	Average operating cost (EUR/animal)
Fattening pigs	1 (0.25–1.5) g/day per pig	1.70	3.14	5.34
Broilers	29.8 mg/day per broiler (25 kg per 30 000 broilers) in the final 4 weeks of rearing	0.014	6	0.084
Turkeys	66.2 mg/day per turkey (50 kg per 12 000 turkeys) in the final 9 weeks of rearing	0.071	2.5	0.18
Ducks	29.8 mg/day per duck (25 kg per 18 000 ducks) in the final 10 weeks of rearing	0.024	8.6	0.21
<i>Source:</i> [279, Fefana 2010]				

The installation costs and operating costs are largely the same as for the fogging technique described in Section 4.8.3.

Driving force for implementation

The improvement of animal respiratory comfort results in an improved FCR and growth rate of the animal.

Example plants

Less than 10 farms for weaned pigs are reported to use this technique [384, Fefana 2011].

Reference literature

[278, Fefana 2010] [279, Fefana 2010] [384, Fefana 2011] [360, Boulestreau 2006]

4.8.4 Oil spraying

Description

In littered houses, pure vegetable oil is sprayed on the bedding by nozzles fitted on pipes. Circulating dust particles are bound to the oil drops and are collected in the litter. Also, a thin layer of vegetable oil is applied on the bedding, thus preventing dust becoming airborne. Oil spraying is also possible in pig houses with slatted floors as a mixture of water and around 3 % vegetable oil.

Achieved environmental benefits

The reduction of fine dust emissions is an achieved benefit.

Cross-media effects

Issues concerning contamination from oil particles are still unsolved. Oil residues may cause slippery floors or even fire hazards. The safety of animals and workers has to be demonstrated and the medium- to long-term potential for wall dirtiness is unknown [500, IRPP TWG 2011]. Also, moist or sodden bedding/litter needs to be avoided as this may impact negatively on animal welfare, especially for poultry. The application of an oil film results in a slightly less loose bedding [582, Wageningen NL 2009]. Additional work is required to clean the oil residues from the walls and to clean the system itself.

Environmental performance and operational data

In broiler houses, less than 1 % of the oil droplets should be smaller than 10 micrometres size. Oil should be spread evenly over the total area of the house. Oil and air are sprayed simultaneously into the nozzles. Pipes and nozzles can be placed in the middle of the house or along the side walls (see Figure 4.68). There should be one nozzle per 28 m² of living area. A minimum of 12 ml of oil per square metre should be spread once a day. Operators should keep out of the house during application. The system lifetime is around 10–15 years. The extra time required for cleaning after treatment is approximately equivalent to a quarter of the time needed for cleaning when no treatment is applied [582, Wageningen NL 2009].

Dust reductions of 54 % were achieved in the Netherlands for the PM₁₀ fraction and 75 % for the PM_{2.5} fraction. In Denmark, the effect of low-pressure oil spraying (a mixture of water and 3 % rapeseed oil at 5 bar) on respirable dust was investigated in farrowing pens with partly slatted floors (where spray nozzles were placed above the slatted floor), and finishing pig houses with fully slatted floors. At a spraying rate of 8 g of oil/day for farrowing sows and 2–3 g of oil/day for finishers, there was a reduction of respirable dust emissions of 40 % for farrowing sows and 50 % for fattening pigs and a reduction of total dust emissions of 33 % for farrowing sows and 40 % for fattening pigs respectively. The dust concentration in the finisher unit on all days of measurement was less than 3 g/m³ [649, DAFC 1999].

In Germany, dust absorption by sprinkling a mixture of oil and water is considered an effective technical measure in order to reduce dust emissions in both pig and poultry farms [474, VDI 2011].

Technical considerations relevant to applicability

The system can be easily fitted in new and existing pig and poultry houses. For poultry plants, the technique is only applicable to birds older than around 21 days. Oil spraying is better suited for broilers than for layers, because less equipment is present in the shed that could become contaminated. It is also suitable for turkeys and pullets of broiler breeders [138, Netherlands 2010].

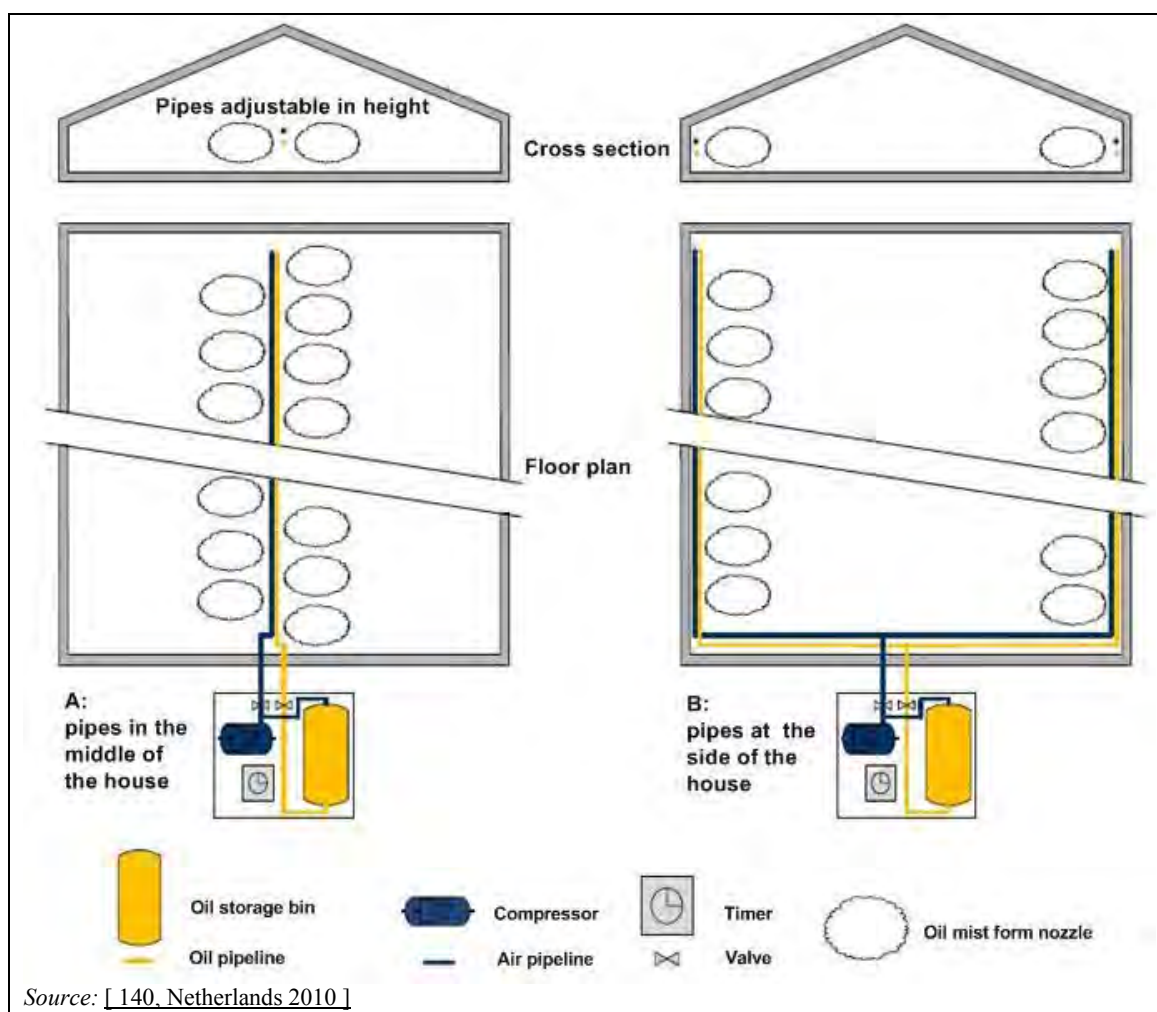

Figure 4.68: Schematic view of an oil spraying system

Economics

Extra costs were estimated in the Netherlands for common broiler and turkey housing systems and are presented in Table 4.127.

Table 4.127: Extra costs related to the technique of oil spraying in poultry housing

Type of animal	Extra investment (EUR/ap)	Annualised extra investment (EUR/ap)	Annual operating extra cost (EUR/ap)	Total annual extra cost (EUR/ap)	Total annual extra cost (EUR/produced animal)
Broiler, housing for 90 000 birds	0.5	0.09	0.09	0.18	0.026
Turkey, housing for 20 000 birds	2.2	0.39	0.93	1.32	0.46

Source: [503, Vermeij 2011]

Driving force for implementation

Better working conditions due to lower dust concentrations are a driving force. The application of an oil film reduces personal dust exposure by 75 % to 95 %, which is an important advantage in comparison with the use of end-of-pipe techniques for cleaning the exhaust air, such as wet scrubbers [582, Wageningen NL 2009].

Example plants

The system is in use on two farms in the Netherlands.

Reference literature

[138, Netherlands 2010] [140, Netherlands 2010] [474, VDI 2011] [500, IRPP TWG 2011]
[503, Vermeij 2011] [582, Wageningen NL 2009] [649, DAFC 1999]

4.8.5 Floating balls in slurry channels

Description

Balls half-filled with water and made of special plastic (e.g. high-density polyethylene) with a non-sticky coating float on the surface of manure channels below slatted floors, allowing the reduction of the ammonia-emitting surface. The ball axis changes when faeces drop on it and the ball tilts to drop the dung into the slurry in the channel. When slurry is removed, the balls remain in the pit and continue floating. The balls' diameter is around 225 mm. A schematic representation of the functioning principle of the technique is shown in Figure 4.69.



Source: [583, Netherlands 2010]

Figure 4.69: Schematic representation of the functioning principle of floating balls

Achieved environmental benefits

The emitting surface in the slurry channels is notably decreased as most of the surface is covered by balls, hence emissions are reduced.

Cross-media effects

Balls have to be disposed of at the end of their useful life. Additional work is needed for cleaning the balls after each rearing cycle, if necessary.

Environmental performance and operational data

The maximum potential reduction of the emitting surface is 70 % and it is achieved with 18 balls per m², which is the maximum number of balls that fit on 1 m² of the manure surface. The manure level in the pit should not be kept too high, in order to allow free mobility of the balls that need to tilt when faeces are dropped on them. Similarly, during the manure removal, a sufficient level of slurry has to be left to allow the balls to continue to float. The maintenance of the floating balls is minimal (no real costs), although it is recommended to regularly check manure adherence. Balls are cleaned after each rearing cycle, if needed. On delivery, the supplier should provide a certificate with at least the number and type of balls installed.

Tests carried out in the Netherlands credit this system with an average ammonia emissions reduction of 28 %, compared to the same housing system without floating balls. Measured ammonia emissions after the application of this technique in fattening pig housing systems are reported to be equivalent to 2.3 kg NH₃/ap/yr. In the case of a combination of the floating balls with the addition of 1 % benzoic acid, the ammonia emissions reduction is increased to 42 %.

The UNECE guidance document on 'Options for ammonia mitigation' indicates a 25 % emission reduction efficiency for the technique for all pig categories [508, TFRN 2014].

Technical considerations relevant to applicability

This system fits every pig production type but at the moment has only been applied and verified for fattening pigs. This system fits in existing pig houses equipped with pits that do not have slanted walls (i.e. only applicable to pits with vertical walls). No particular specification of floor is needed. The technique is not compatible with channel flushing or other techniques that remove all slurry from the pit.

Economics

Investment costs depend on the surface of the manure pit and, on average, are around EUR 31 (excluding taxes) per fattening pig place (around 1 m²). Extra costs are reported as EUR 2 per animal place per year and the cost efficiency of the technique as EUR 4 per kg of NH₃-N abated [508, TFRN 2014].

Driving force for implementation

The system is easy to use. The technique of floating balls, as it is used in the Netherlands, can be used in combination with other ammonia-reducing measures, e.g. benzoic acid addition.

Example plants

In 2013, approximately 10 housing systems in the Netherlands were equipped with floating balls, rearing around 4 000 fattening pigs.

Reference literature

[213, Netherlands 2010] [508, TFRN 2014] [583, Netherlands 2010] [584, Netherlands 2010]

4.8.6 Biological additives in poultry litter

Description

Biological additives are used to improve the quality of bedding. Additives consist of complexes of microorganisms containing *Lactobacillus* and *Bacillus*, a mixture of bacteria and mushrooms. The process of organic matter degradation is modified and a fast humification process starts after the addition, which improves the physical conditions and the performance of the litter (drier, low-emitting litter).

Achieved environmental benefits

Less ammonia is emitted into the air; the quality of the indoor environment is improved [368, France 2010]. The selected strains of microbes (*Bacillus subtilis*) included in the additive have a positive influence on the litter properties, according to their defined metabolic criteria. The physical status of the litter is improved and more nitrogen is bound in the humified form.

Cross-media effects

An increase in average nitrous oxide emissions has been observed, which is consistent with a drier litter [647, Rousset et al. 2012].

Environmental performance and operational data

The bedding inoculation is done at the beginning of the rearing cycle and no later than the tenth day of life of the chicks.

Experimental tests were carried out, on the basis of mass balances, comparing treated to untreated litters. Litters treated with biological additives always showed a higher overall nitrogen content, whereas the portion of ammoniacal nitrogen was not increased (same or lower NH₃-N/N_{total} ratio). This means that nitrogen is better linked and conserved in an organic form in the treated litter. The C/N ratio, which reflects the degree of degradation of the organic

matter, is as low as 10–15, in comparison with the level of 20–40 observed for untreated litter. Experimental data concerning the characteristics of treated and untreated litter are presented in Table 4.128 [502, Guinebert et al. 2005].

Table 4.128 Composition of treated and untreated turkey manure

Parameters	Type of litter			
	Straw bedding		Shavings bedding	
	Untreated	Treated	Untreated	Treated
Organic matter (% of DM)	40–50	60–72	50–60	60–75
Total N (% of DM)	2–2.5	5–6	2–3	3.5–4.5
NH ₃ (% of DM)	0.5–0.8	0.5–0.8	0.6–0.8	0.1–0.3
C/N ratio	20–40	8–15	20–40	2–10
<i>Source: [502, Guinebert et al. 2005]</i>				

The reduction in ammonia emissions, as a consequence of the litter treatment, is reported to be from 8.5 % to 36 %, as an average [501, Aubert et al. 2011] [647, Rousset et al. 2012]. The competition of the added bacteria with harmful microorganisms inside the litter enables a drastic reduction of the population of microorganisms such as enterobacteria and coliforms, with a consequent reduction of the risk of contamination of the birds [502, Guinebert et al. 2005]. A reduced animal mortality of about 27 % (from 4.3 % to 3.1 %) has been recorded [501, Aubert et al. 2011].

Technical considerations relevant to applicability

These products are especially used for broiler and turkey rearing, spread or pulverised over the bedding.

Driving force for implementation

Litters are richer in nitrogen, which can be used efficiently in landspreading. Animal mortality and pododermatitis also appear to be reduced, especially during a long rearing period [501, Aubert et al. 2011] [647, Rousset et al. 2012]. However, there is no regulatory framework adopted for manure additives in order to safeguard their performance.

Example plants

In France, the use of this technique is increasing in meat poultry production; one French farm has been using this technique since 1996.

Reference literature

[368, France 2010] [501, Aubert et al. 2011] [502, Guinebert et al. 2005] [647, Rousset et al. 2012]

4.9 End-of-pipe measures for the reduction of emissions to air from housing

4.9.1 Introduction

The treatment of the exhaust air from animal houses is a method that has lately gained importance since intensive farming needs to comply with stricter regulations and emission limits. Biofilters, biotrickling filters, acid scrubbers and multi-stage air cleaning systems are applied as an end-of-pipe technique for the removal of certain pollutants such as ammonia, odour and dust from the exhaust air of animal housing. An effective reduction of dust also reduces the emission of bioaerosols. Air cleaning systems operate on the basis of different physical, biological and/or chemical removal principles. They also differ in applicability and removal performance. The general operating principles of the two main categories of air cleaning systems (wet scrubbers and biofilters) are briefly described in Section 2.4.

The different air cleaning systems and their combinations in use are presented in Table 4.129, together with an indication of their applicability to the various animal categories and their removal performances.

Table 4.129: Types of exhaust air cleaning systems in animal housing, their applicability and removal performance

Type of air cleaning system	Applicability		Removal performance		
	Animal category	Manure removal system	Odour	NH ₃	Dust
Biofilter	Pigs	Liquid manure system	++	NS	+
Biotrickling filter	Pigs	Solid and liquid manure system	+	+	+
Acid scrubber	Pigs, dry manure store	Solid and liquid manure system	NS	++	+
MULTI-STAGE AIR CLEANING SYSTEMS					
Two stages					
Water scrubber + acid scrubber	All animal categories	Liquid and solid manure system	0/+	++	++
Water scrubber + biofilter	All animal categories	Liquid and solid manure system	++	0/+	++
Acid scrubber + biofilter	All animal categories	Liquid and solid manure system	++	++	++
Acid scrubber + biotrickling filter	All animal categories	Liquid and solid manure system	+	++	++
Three stages					
Water scrubber + water scrubber + acid scrubber	All animal categories	Liquid and solid manure system	++	+	+++
Water scrubber + acid scrubber + biofilter	All animal categories	Liquid and solid manure system	+++	+++	+++
NB: NS= not suitable; 0 = conditionally suitable; + = suitable ++ = good; +++ = very good					
Source: [424, VERA 2010]					

Wet scrubbers are required in some Member States in order to comply with acceptable emission levels for ammonia, PM₁₀ and odour, particularly in densely populated areas, in regions characterised by a high animal density or in vulnerable natural protected areas (e.g. Natura 2000 sites). However, they are still considered costly installations. Specific emission reduction efficiencies are usually associated with each type of air cleaning system.

Achieved environmental benefits

The maximum average ammonia removal efficiency that can be achieved with the different systems ranges from 70 % to over 90 %. In Germany, the required minimum removal efficiency

of air cleaning systems for ammonia and total dust is 70 % at any time. Ammonia separation is assessed with the aid of a nitrogen balance covering the entire production system. Dust removal efficiencies from 80 % up to more than 95 % are reported as achievable [514, KTBL 2008].

Odour removal is, on average, 30 % for acid scrubbers and 45 % for biotrickling filters, although wide ranges are reported for individual measurements, since the efficiency of odour reduction is highly dependent on the raw gas concentration. The minimum requirement for odour reduction of air cleaning systems applied in Germany is defined as an odour concentration in the clean gas not exceeding 300 ou_E/m³ and no typical process odours (e.g. animal house odour) are perceptible in the clean gas [514, KTBL 2008]. Odour intensity is a logarithmic function of concentration. Therefore, a 90 % removal might only reduce the intensity by around half [624, IRPP TWG 2013].

Environmental performance and operational data

In Germany, the Netherlands and Denmark, air cleaning systems are officially tested and reduction efficiency factors are certified for the removal of ammonia, odour and dust before being implemented on the farm. In order to harmonise the testing procedures and facilitate acceptance of the results in different countries, a joint initiative of parties from the aforementioned Member States developed a standardised protocol for testing and verifying different air cleaning systems: the 'Test Protocol for Air Cleaning Technologies' [424, VERA 2010]. Hence, by applying the test protocol, it is possible to fit a housing unit with an end-of-pipe technique that ensures a certain level of ammonia, odour and/or dust emissions. The assessment of the efficiency of air cleaning systems in animal housing is described in Section 4.18.6.

The maximum capacity of the scrubber in terms of airflow is designed in accordance with the maximum required airflow rate (warmer season) for the animals housed in the building, pen or compartment coupled to the unit. However, the airflow rate over the course of the year varies considerably, depending mainly on the outdoor temperature, and consequently the ventilation rate is only running at maximum capacity for a limited time over the year. As an example, a yearly average airflow of around 50 % of the maximum capacity is reported for Germany. In northern European coastal climates, for about half of the year the ventilation is applied at about 25 % of capacity in pig houses. That means, if an air cleaning system is able to clean the first 25 % of the maximum ventilation rate, then 100 % of the exhaust air is cleaned for about 50 % of the time during a year.

The example given in Figure 4.70 reflects the strategy of partial treatment of exhaust air at lower than the maximum ventilation capacity, for two different emission limit concentrations of ammonia in the treated air. According to the data presented, an air cleaning system with a cleaning capacity at 50 % of the maximum ventilation capacity still enables around 70–80 % of ammonia removal, with 20–30 % of the total ammonia emissions to be vented untreated. This strategy reduces investment and operating costs but hardly affects the average ammonia emission levels [13, Melse 2009] [55, Denmark 2010]. However, it may not be effective for the control of odour nuisance [624, IRPP TWG 2013].

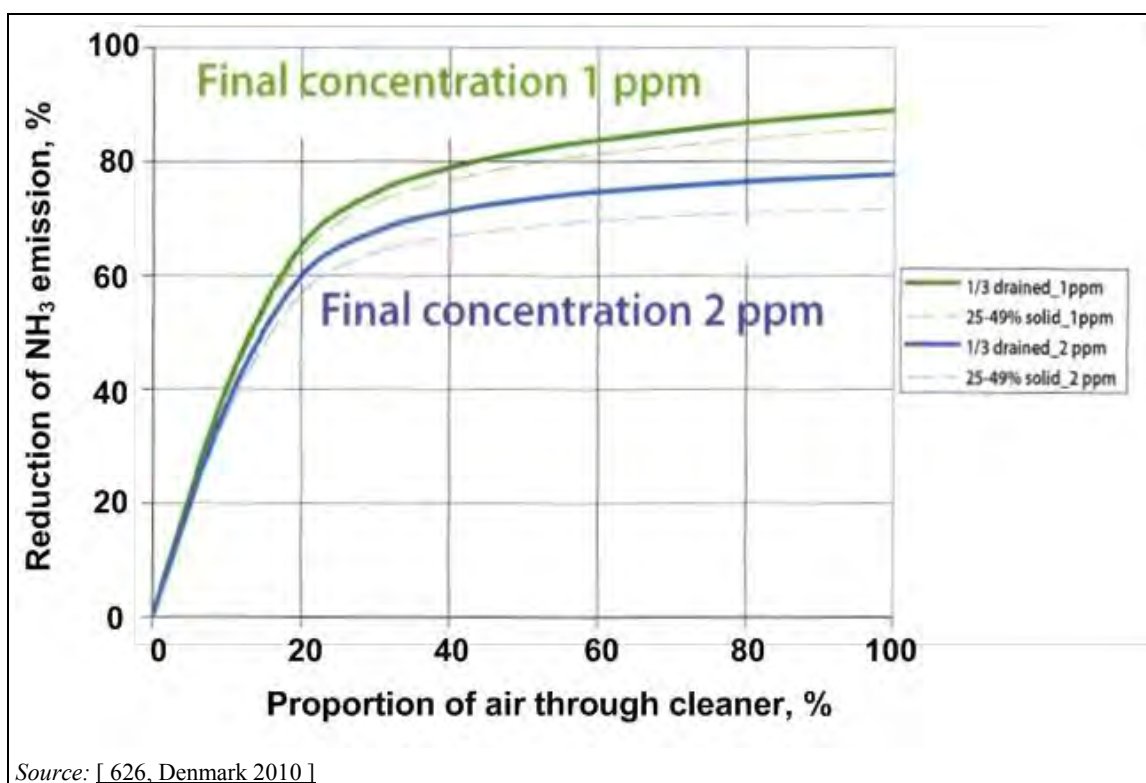

Source: [626, Denmark 2010.]

Figure 4.70: Ammonia removal efficiency as a function of the proportion of the treated air by the air cleaning system

The highest odour removal efficiency of air cleaning systems is achieved by adjustment of the design and operational strategy. Another approach is that of multi-stage scrubbing systems, where each stage aims to remove one type of compound.

The air that is treated in wet scrubbers typically leaves the systems with high levels of humidity, over 95 %. In order to avoid aerosol discharge, droplet separators can be installed at the point where the clean air leaves the system [121, Germany 2010]. The generation of aerosols from these air cleaning systems raises concerns about the potential presence of *Legionella*.

Technical considerations relevant to applicability

An essential constraint for the implementation of air cleaning system is the centralisation of air extraction; in existing buildings, the ventilation configuration does not always permit central ducting of exhaust air. Additionally, air cleaning systems significantly increase the flow resistance of the forced ventilation system. Therefore, the ventilation system must be planned and designed efficiently, which is relatively easy in newly planned houses as these requirements (i.e. channelling of the air to a single point, sufficiently powerful fans) can easily be taken into account at a reasonable cost [51, BE Flanders 2010].

Retrofitting existing houses will be difficult and expensive in most cases as the ventilation system is rarely adequate to support a scrubber since multiple air outlets may be present and flows might not be channelled to a single outlet point where the air could enter the scrubber. In addition, the design and capacity of the installed fans might not meet the increased capacity required to overcome the extra flow resistance that is inevitably introduced by the presence of a scrubber. Not only are the costs for the installation of air cleaning systems in existing houses normally significantly higher than those for the implementation of the same techniques in new houses, but the operating costs are also expected to be higher (compared to new housing), because of the difficult optimisation of the existing ventilation system. Air cleaning systems are not applicable to existing naturally ventilated houses.

In existing pig houses, separate air cleaning system may be also utilised to treat the exhaust air from each pen or compartment; in this way, the constraint of channelling the air extraction of the whole building can be overcome [261, France 2010].

Economics

Investment and operating costs of air cleaning systems for livestock operations are generally high and this limits the widespread take-up of the system across the EU. The fixed costs are related to the air cleaning system size. Costs for energy use are notable, to run water pumps and to overcome the increased resistance to the mechanical ventilation due to the presence of the filters. The maximum ventilation capacity is of great importance for the cost of air cleaning, since the size of the air scrubber is proportional; recommendations for maximum ventilation capacity across Europe are not the same.

Example plants

An example of the locally widespread application of air cleaning techniques can be found in Germany in only three districts, Cloppenburg, Vechta and Emsland of Lower Saxony, where between 370 and 400 pig farms (around 17 % of all pig farms) had installed air abatement techniques (as of 2010). Two out of three newly built houses are fitted with air cleaning systems, of which 75 % are bioscrubbers and multi-stage devices and 25 % are biofilters [504, KTBL 2010].

The two main categories of air cleaning techniques (wet scrubbers and biofilters), applied alone or in combination within the sector for the intensive rearing of poultry or pigs, are presented in the following sections.

Reference literature

[13, Melse 2009] [51, BE Flanders 2010] [55, Denmark 2010] [121, Germany 2010] [261, France 2010] [424, VERA 2010] [504, KTBL 2010] [514, KTBL 2008] [624, IRPP TWG 2013] [626, Denmark 2010]

4.9.2 Water scrubber

Description

The exhaust air from the housing is blown through a packed filter medium by transverse flow. Water is continuously sprayed on the packing material. The dust is taken up by water and settles in the water tank, which is emptied when full. No flushing with water is required. Water and air can also flow in the same direction. The technique is also used in combination with other air cleaning systems in multi-stage scrubbers (see Section 4.9.6.2).

Achieved environmental benefits

Reduction of dust from the exhaust air is an environmental benefit of the technique.

Cross-media effects

The collected dust needs to be disposed of. Water requirements increase as well as the energy consumption for running the pumps. As a result of the relatively low pressure drop in the filter, the extra energy for ventilation is negligible.

Environmental performance and operational data

For a filter surface load of 4 300 m³/m² per hour, and a thickness of the contact bed packing of 0.6 m, the reduction of fine dust (PM₁₀) is calculated in a pullet farm to be approximately 30 %. The reported average flow rate over the course of the year, in percentage of the maximum flow rate, is equivalent to 30 % [124, Netherlands 2010].

Every week the packing material should be controlled for blocking by dust, as should the amount of circulating water to be sprayed on the column. The packing material should be cleaned once a year.

Technical considerations relevant to applicability

In existing plants, the system is applicable only where a centralised ventilation system is used. Where the ventilation system has multiple fans or multiple outlet points, the implementation is hardly practicable.

Economics

The extra costs associated with the implementation of water scrubbers, estimated in the Netherlands for poultry housing, are reported in Table 4.130.

Table 4.130: Extra costs related to water scrubbers in poultry housing

Type of animal	Housing capacity in animal places (ap)	Extra investment costs (EUR/ap)	Annualised extra investment costs (EUR/ap)	Annual operating extra costs (EUR/ap)	Total annual extra costs (EUR/ap)	Total annual extra costs (EUR per animal produced)
Pullets	50 000	2.32	0.32	0.33	0.66	0.25
Laying hens (aviary)	40 000	2.97	0.41	0.45	0.86	0.98
Broiler grandparents	33 000	3.34	0.47	0.48	0.94	0.46
Broiler breeders	19 000	6.26	0.87	0.92	1.79	1.75
Broilers	90 000	3.26	0.46	0.46	0.92	0.134
Turkeys	20 000	22.36	3.15	3.19	6.34	2.19
Ducks	40 000	4.84	0.68	0.70	1.38	0.21

Source: [503, Vermeij 2011]

Driving force for implementation

In the Netherlands, the incorporation of the system in new or existing farms makes it possible to grant an environmental permit in situations where this would otherwise not be possible under the local legislation, due to exceeding the maximum permissible values for fine dust concentrations.

Example plants

This system has been applied in the Netherlands since 2009, where several farms use this technique.

Reference literature

[124, Netherlands 2010] [503, Vermeij 2011]

4.9.3 Bioscrubber (or biotrickling filter)

Description

This is a packed tower trickling filter with inert packing material that is normally maintained continuously wet. Pollutant removal is achieved by means of absorption of the contaminants in the liquid and breakdown by microorganisms on the filter. The terms bioscrubber and (bio)trickling filter are used as synonyms.

Contaminated exhaust air is passed upwards (counter-current in vertical bioscrubbers) or horizontally (cross-current in horizontal bioscrubbers) over the filter elements which are continuously sprinkled with water. Due to an intensive contact between air and water, dust,

ammonia and odour contained in the contaminated air are absorbed in the liquid phase and subsequently degraded by microorganisms, settling on the filter elements as a biofilm. The effluent is collected in a storage tank before being recycled back to the top of the scrubber. In this way, the biomass in the system grows partly as a film on the packing material of the filter and is partly suspended in the water that is recirculated [13, Melse 2009].

Ammonia is degraded by bacterial conversion into nitrites and nitrates (nitrification), while odorous compounds are oxidised by bacteria to CO₂, H₂O and by-products; dust is dissolved in water. Water circulation keeps the biolayer moist and provides the nutrients for the microorganisms; the accumulated nitrites and especially nitrates (which may be toxic to the microorganisms) are discharged with the scrubbing water, so that the pH remains in a favourable range (between 6.5 and 7.5) for microorganisms. The pH is determined by two counteracting processes: oxidation of NH₃ reduces the pH value in the scrubbing water whereas NH₃ input causes the pH value to increase. For this reason, a pH controller is often recommended with an acid metering system to maintain the pH value within the target range, even in unfavourable operational conditions (such as starting up, excessive ammonia input and temperatures < 12 °C) [514, KTBL 2008].

The bioscrubber can be preceded by a simpler filtering stage to reduce dust and odour as a first step, which often is done by a ‘water curtain’, where a simple flush of water and air flow in the same direction. A droplet separator can be installed before the cleaned air leaves the system. The typical workflow of a bioscrubber is shown in Figure 4.71.

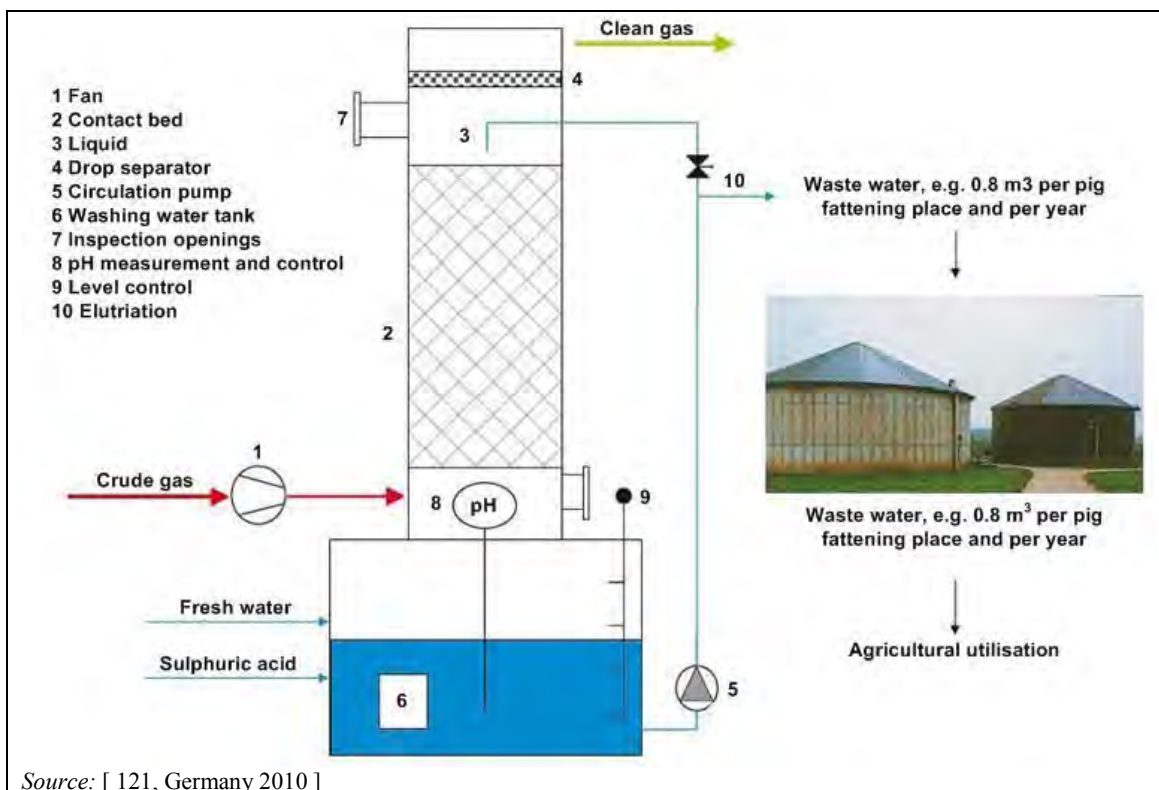

Figure 4.71: Bioscrubber workflow

Achieved environmental benefits

Ammonia, odour and dust emissions are simultaneously reduced. The odour reduction is effective for neutral compounds, as well as for odorous substances attached to dust particles.

Cross-media effects

Increased energy use is required to operate the pumps for water circulation and to overcome the increased flow resistance for ventilation. In addition, water consumption is increased, as is the requirement to discharge waste water. A discharge of water up to 10 times higher than with a chemical scrubber may result. If conditions in the bed media are not properly controlled, transient aerobic/anaerobic zones might risk N₂O emissions formation.

Environmental performance and operational data

Ammonia emission reductions between 70 % and 90 % have been reported. Removal efficiencies higher than 90 % have been measured only at high elutriation rates or at a pH-regulated and conductivity-controlled elutriation rate [121, Germany 2010] [129, Netherlands 2010] [127, Netherlands 2010] [135, Netherlands 2010] [51, BE Flanders 2010].

The odour reduction strongly depends on the raw gas concentration; the average achievable odour removal efficiency varies between 45 % and 76 %. The minimum requirement for odour reduction of air cleaning systems applied in Germany is defined as an odour concentration in the clean gas not exceeding 300 ou_E/m³ and no typical process odours (e.g. animal house odour) are perceptible in the clean gas [514, KTBL 2008]. A removal of total dust of at least 70 % can usually be obtained, while the reduction of the PM₁₀ fraction is reported to reach at least 70 %, and can be as high as 95 %, especially with the use of a dedusting filtering stage.

A summary of the emission reductions achieved by applying bioscrubbing in pig production is shown in Table 4.131, as reported by different Member States.

Table 4.131: Emission reductions achieved by the application of bioscrubbers in pig production

Achieved emission reductions (%)				
Ammonia	Odour	Total dust	PM ₁₀	Reference
92 ⁽¹⁾	76 ⁽¹⁾	70 ⁽²⁾ –90 ⁽²⁾	NI	[665, Riis 2012]
90 (70–95)	70 (50–90) ⁽³⁾	70–96	80	[121, Germany 2010]
70	45	NI	60	[135, Netherlands 2010]
⁽¹⁾ The level is achieved after two filters. ⁽²⁾ The level is achieved after three filters in summer. ⁽³⁾ The minimum requirement in Germany for odour concentration in the clean gas is < 300 ou _E /m ³ , which is comparable to a reduction efficiency of about 70 %. NB: NI = no information provided.				

Specific emission levels achieved with the application of bioscrubbers are presented in Table 4.132, as reported by Denmark and the Netherlands.

Table 4.132: Reported emission levels achieved with the application of bioscrubbers

System	NH ₃ reduction efficiency (%)	Animal category	Ammonia	PM ₁₀	Reference
			kg/ap/yr	g/ap/yr	
Bioscrubber with partial air treatment	50–85	Fattening pigs	0.44 (100 % air cleaned) 0.56 (60 % air cleaned) 0.88 (20 % air cleaned)	NI	[53, Denmark 2010]
Bioscrubber with droplet separator ⁽³⁾	70	Weaners	0.18–0.23 ⁽¹⁾	NI	[135, Netherlands 2010]
		Farrowing sows	2.5	NI	
		Mating/gestating sows	1.3	NI	
		Fattening pigs	0.8–1.1 ⁽¹⁾	NI	
Bioscrubber ⁽³⁾	70–95	Fattening pigs	0.12–0.75 ⁽²⁾	NI	[121, Germany 2010]
	70	Laying hens	0.095	21–33	[640, Netherlands 2013]
	70	Broilers	0.024	5–9	[644, Netherlands 2014]

⁽¹⁾ The higher end of the range is with more space available per animal.
⁽²⁾ Values are calculated from a standard emission from the housing system of 2.9 kg/ap/yr.
⁽³⁾ Ammonia emission data listed are based on the implementation of an air cleaning system in the reference housing system in the Netherlands.
 NB: NI = no information provided.

Energy is required to operate pumps for water circulation. In addition, in order to ensure the requisite air rates, particularly in the summer, higher capacity fans with a higher specific power requirement may be necessary due to the increased flow resistance. Airflow rates related to these systems are typically from 10 000 m³/h to 100 000 m³/h; volumes up to 255 000 m³/h are reported for farms with a capacity of 3 000 pigs.

Electricity consumption is associated with modules of 1 000 m³/h of the installed capacity of the scrubbing system (around 11.8 pig places covered at a flow rate of 85 m³/animal place per hour). On a yearly basis, the electricity consumption is around 12.7–15.3 kWh/animal place for the system's requirements (pumps, control, etc.) and 11–20 kWh/animal place to compensate for the additional pressure drop required to operate the ventilation system (up to 150 Pa for biotrickling beds) [121, Germany 2010]. In France, for a bioscrubber with a capacity of 150 000 m³/h in a farm with 2 100 fattening pig places, it is necessary to install a pump of 3 kW, which is equivalent to an electricity consumption of 12.5 kWh/fattening pig place/year [261, France 2010].

The total water consumption is composed of the required water discharge and the quantity which is evaporated. Evaporative losses range between 5 litres and 7 litres per 1 000 m³ of treated air. In general, a sufficient discharge of the contaminated scrubbing water is of vital importance for the operational reliability and the removal efficiency of the bioscrubber [514, KTBL 2008]. For example in Germany, for bioscrubbers without pH control, a removal efficiency of at least 70 % for ammonia emissions is only achieved at an elutriation rate of 0.2–0.3 m³ per kg of NH₃ input which corresponds approximately to 0.6–0.9 m³ water discharge per animal place per year [121, Germany 2010] [514, KTBL 2008]. Also in Germany, water consumption in the range of 1.6–2.4 m³/pig place per year is reported for modern systems, with pH control (in order not to exceed a set pH value above which ammonia is released from the scrubbing water into the exhaust air), and elutriation based on water conductivity; otherwise the

consumed volumes are higher. Furthermore, in Germany, around 0.3–0.4 m³ of waste water per fattening pig place per year are reported for systems equipped with pH control and elutriation based on water conductivity [500, IRPP TWG 2011]. In Denmark, the total water consumption per pig produced is estimated at around 0.25 m³ [53, Denmark 2010].

Data concerning total water consumption and the amount of water discharged from the scrubbing system are presented in Table 4.133 for different farms applying bioscrubbers for air treatment.

Table 4.133: Examples of water consumption and water discharges for fattening pig farms applying bioscrubbers

Location	Total water consumption (m ³ /ap/yr)	Water discharged from the air cleaning system (m ³ /ap/yr)	Remarks
Denmark	1	0.43	Calculated values with the assumption of 4 fattening pigs produced per year per animal place (values reported: 0.108 m ³ /pig produced, respectively)
Germany	1.6–2.4	0.3–0.4	Calculated values from 4 800–7 200 m ³ /yr reported for fresh water requirements (with pH control, elutriation according to water conductivity) for a capacity of 255 000 m ³ /h and for 85 m ³ /fattening pig/yr of airflow capacity
The Netherlands	0.9–3.1	1–4	With water curtain. Calculated values from the reported data: 1.9 m ³ /day for winter and 6.5 m ³ /day for summer, for a farm of 520 fattening pigs and 240 weaners
The Netherlands	0.8–1.8	0.17–0.68	With water curtain. Calculated values from the reported data: 2.27 m ³ /day for winter and 5.25 m ³ /day for summer, for a farm of 1 080 fattening pigs. This unit is reported to have a relatively low amount of flushing water due to an optimised flushing water management.
<i>Source:</i> [53, Denmark 2010] [121, Germany 2010] [135, Netherlands 2010] [127, Netherlands 2010] [129, Netherlands 2010] [624, IRPP TWG 2013]			

The waste water is usually stored with the slurry and landspread, taking into account the additional supply of nitrogen. It might also be treated in a subsequent denitrification stage, where in a separate reactor the nitrogen compounds are transformed into gaseous N₂, allowing for the reuse of the process water and its final discharge at lower costs.

Technical considerations relevant to applicability

In principle, this system is easy to implement, both as an addition to new buildings and in refurbishing existing buildings already applying forced artificial ventilation under a negative air pressure with centralised air extraction. In practice, the installation of a scrubber in an existing house requires, in most cases, a redesign of the ventilation system and the installation of new, more powerful, fans. Where the ventilation system has multiple fans or multiple outlet points, the implementation is not practicable. Therefore, the primary condition governing implementation in existing houses is the technical possibility to operate with centralised air extraction which depends on the configuration of the building [261, France 2010].

In pig housing, the design and the size of the pens are not critical for the applicability of the system. A dust filter may be necessary where dust levels are higher (straw systems), which will increase pressure in the system and also increase energy use.

Bioscrubbers are more suitable for pig production as in poultry houses the high dust and feather load of the ventilation air increases the risk of blockage of the packing bed, which decreases the efficiency of the scrubber and increases maintenance costs. To overcome this, a dust filter may be applied but with a consequent increase of the pressure drop and energy use [51, BE Flanders 2010]. In addition, in the all-in all-out system that is used at poultry farms, the microbes of the biolayer will be left without nutrients by the contaminated air for a certain period of time [135, Netherlands 2010]. During the periods when the animal house is empty, the bioscrubber can be fed by recirculating the liquid [624, IRPP TWG 2013].

Economics

Reference costs related to the application of bioscrubbers in the Netherlands are reported in Table 4.134.

Table 4.134: Associated costs for bioscrubbers in the Netherlands by pig category

Pig category	Housing capacity (animal places)	Associated costs ⁽¹⁾ ⁽²⁾			
		Investment costs (EUR/ap)		Annual costs ⁽³⁾ (EUR/ap/yr)	
		Without water curtain	With water curtain	Without water curtain	With water curtain
Weaners	2 016	15	16	3.0	4
Farrowing sows	130	170	170	30	35
Mating and gestating sows	477	90	100	20	23
Fattening pigs	4 200	40	50	10	12

⁽¹⁾ Bioscrubbers designed for 70 % ammonia removal efficiency and combined with a denitrification stage.
⁽²⁾ All cost data are given without VAT.
⁽³⁾ Annual costs include depreciation, interest, maintenance and all other operating costs.
Source: [135, Netherlands 2010] [589, Netherlands 2010]

Examples of investment, operational and total costs are presented in Table 4.135 for different housing capacities in pig production, expressed also by 1 000 m³/hour of capacity. For existing houses, higher costs are expected because of the additional costs for the adaptation of the ventilation system. From this table, it is deduced that, for example for applications to pig housing in Germany with 3 000 animal places, an investment of EUR 470 to EUR 720 is necessary for each 1 000 m³/hour of capacity. At the condition of standard ventilation of 85 m³/h per animal place, the annualised investments are around EUR 4–7 per animal place per year, and the annual operating costs vary between EUR 7.5 and EUR 9.5 per animal place per year [121, Germany 2010]. This system's lifetime is expected to be around 10 years.

Table 4.135: Cost ranges associated with the use of bioscrubbers for exhaust air treatment in fattening pig production, in Germany and Denmark

Housing capacity	Associated costs ⁽¹⁾							
	Investment costs		Annualised investment costs		Operating costs		Total costs	
	EUR per 1 000 m ³ /h	EUR/ap	EUR per 1 000 m ³ /h per yr	EUR per ap/yr	EUR per 1 000 m ³ /h per yr	EUR per ap/yr	EUR per 1 000 m ³ /h per year	EUR per ap/yr
Germany								
460–700 animal places (39 000–60 000 m ³ /h) ⁽²⁾	728–820	62–70	83–96	7.1–8.2	118–130	10.0–11.1	201–226	17.1–19.3
1 060–1 180 animal places (90 000–100 000 m ³ /h) ⁽²⁾	552–638	47–54	61–71	5.2–6.0	95–107	8.1–9.1	156–178	13.3–15.1
1 700–1 850 animal places (150 000–157 000 m ³ /h) ⁽²⁾	463–542	39–46	52–58	4.4–4.9	90–101	7.7–8.6	142–159	12.1–13.5
3 000 animal places (255 000 m ³ /h) ⁽³⁾	600 (470–720)	40–61	65 (50–80)	4–7	100 (90–110)	7.5–9.5	165 (140–190)	12–16
Denmark								
400 animal places ⁽⁴⁾ (40 000 m ³ /h)	678	NI	68	NI	NI	NI	NI	12
⁽¹⁾ All cost data are given excluding VAT and are related to new houses. ⁽²⁾ Costs are calculated on the following assumptions: amortisation period of 10 years for the installation and 20 years for the building, 6 % interest rate for 50 % of the investment, labour costs EUR 20/h, electricity EUR 0.12/kWh, water EUR 0.5/m ³ , acid EUR 0.25/kg, landspreading of waste water EUR 2.6/m ³ , maintenance 1 % of investment, additional costs for larger slurry store EUR 120/m ³ , additional costs for more powerful fans EUR 3 per 1 000 m ³ of installed air capacity. ⁽³⁾ Costs are calculated on the following assumptions: amortisation period of 10 years for the installation and 20 years for the building, 4 % interest rate, labour costs EUR 15/h, electricity EUR 0.15/kWh, water EUR 0.5/m ³ , acid EUR 0.35/kg, application of waste water EUR 3/m ³ , maintenance 1 % of investment, additional costs for larger slurry store and additional costs for more powerful fans are included. ⁽⁴⁾ Average from different system suppliers in Denmark. NB: NI = no information provided. Source: [121, Germany 2010] [514, KTBL 2008] [53, Denmark 2010]								

An example of costs for a biotrickling filter applied to a pig house, broken down for each cost factor, is given in Table 4.136.

Table 4.136: Investment and annual operating costs for a biotrickling filter applied to a newly built facility for pig production

	EUR/ap/yr
Investment costs ⁽¹⁾	43.5
Operating costs	
Annualised investment cost (10 %)	3.4
Maintenance (3 %)	1.8
Interest (6 %)	1.0
Electricity use (EUR 0.11/kWh)	3.8
Water use (EUR 1.0/m ³)	1.7
Chemical use (EUR 0.6/litre H ₂ SO ₄ , 98 %)	NA
Water discharge ⁽²⁾	2.5
Total annual operating costs	10.8
Total annual costs	14.3
⁽¹⁾ The investment costs are based on a maximum ventilation capacity of 60 m ³ /ap/h. ⁽²⁾ Waste water disposal costs are assumed to be equivalent to EUR 2/m ³ for discharge from biotrickling scrubber. NB: NA = not applicable. Source: [568, Melse et al. 2010]	

The annual costs associated with the installation of a bioscrubber correspond on average to EUR 3 per pig produced in Denmark. Costs are lower with partial air cleaning; the cost per pig produced is reduced to EUR 1.9 when cleaning 60 % of exhaust air and EUR 0.7 when only 40 % of the exhaust air is treated [55, Denmark 2010]. Cost data for the application of bioscrubbers in poultry housing are presented in Table 4.137.

Table 4.137: Extra costs related to the application of bioscrubbers in poultry housing

Type of animal	Size of housing in animal places (ap)	Extra investment (EUR/ap)	Annualised extra investment (EUR/ap)	Annual operating extra cost (EUR/ap)	Total annual extra cost (EUR/ap)	Total annual extra cost (EUR per bird produced)
Pullets	50 000	2.93	0.41	0.59	1.00	0.40
Laying hens (aviary)	40 000	3.41	0.50	0.63	1.13	1.29
Pullets of broiler breeders	33 000	4.24	0.60	0.86	1.46	0.70
Broiler breeders	19 000	8.26	1.15	1.76	2.90	2.83
Broilers	90 000	3.71	0.55	0.64	1.19	0.173
Turkeys	20 000	25.83	3.57	4.71	8.28	2.86
Ducks	40 000	5.75	0.78	1.15	1.93	0.30
Source: [503, Vermeij 2011]						

Driving force for implementation

In some Member States, air treatment systems are frequently required by environmental permits in situations where it would otherwise not be possible to comply with the maximum ammonia or odour emissions allowed by local regulations.

Example plants

This system is commonly used. In the Flemish part of Belgium, 190 farms have installed this technique. At least 243 German farms are using this technique [505, Hahne J. 2011]. In the Netherlands, the installed capacity of bioscrubbers for ammonia removal in 2008 was reported to be 14 million m³/hour for 90 farms [568, Melse et al. 2010].

Reference literature

[13, Melse 2009] [42, Netherlands 1999] [51, BE Flanders 2010] [53, Denmark 2010] [121, Germany 2010] [127, Netherlands 2010] [129, Netherlands 2010] [135, Netherlands 2010] [261, France 2010] [500, IRPP TWG 2011] [503, Vermeij 2011] [505, Hahne J. 2011] [514, KTBL 2008] [568, Melse et al. 2010] [589, Netherlands 2010] [624, IRPP TWG 2013] [640, Netherlands 2013] [644, Netherlands 2014] [665, Riis 2012]

4.9.4 Wet acid scrubber**Description**

The ventilation air of an animal house is passed through a filter (e.g. packed wall) where a circulating acid scrubbing liquid is sprayed. When the contaminated exhaust air is brought into contact with the scrubbing liquid, ammonia is absorbed in the low-pH solution and the clean air leaves the system ($2 \text{ NH}_3 + \text{H}_2\text{SO}_4 \rightarrow 2 \text{ NH}_4^+ + \text{SO}_4^{2-}$). The ammonium salt produced is removed from the system with the discharge water. Filters can be packed walls or made of lamellae of synthetic polymer fibres or plastic pads. No biofilm is formed on the contact surfaces. Diluted sulphuric acid is mostly used in this system and is automatically added to keep the pH of the circulating scrubbing water below 5 (1.5–5). Hydrochloric acid may also be used. The scheme of a wet acid scrubber does not differ substantially from the general design presented in Figure 2.27 (see Section 2.4).

Achieved environmental benefits

A significant reduction of ammonia emissions to air can be achieved. Also, dust can be removed. Acid scrubbers are less effective in reducing odorous compounds, due to the low pH value that inhibits the development of microorganisms in the filter wall, and, therefore, microbial odour degradation. Odour reduction is limited to compounds of an alkaline nature that can be diluted in an acid solution, as well as to odorous substances that can be attached to dust particles.

Cross-media effects

Where sulphuric acid is used, the discharged effluent contains ammonium sulphate that can be used as a fertiliser, taking into account the possible need to correct the acidity of the effluent (e.g. by liming). Smaller quantities of water have to be discharged in comparison with bioscrubbers. With the use of different acids, sludges might have to be disposed of.

Air cleaning systems result in increased energy use for ventilation, due to counter pressure in the filter material and ducting, plus power for water and acid pumps. The fan should be able to overcome a pressure difference of at least 100 Pa in addition to the flow resistance of the animal house without noticeable capacity loss.

Specific safety measures are required for the storage and handling of acids and chemical substances, according to national or local regulations. These may include constructional requirements, which may pose some limits to the possible implementation of the technique. Training of the staff on acid management minimises the risks to human health and environment.

Environmental performance and operational data

An ammonia reduction of at least 70 %, and up to 99 %, in the exhaust air can be achieved. The odour reduction efficiency varies between 30 % and 40 %, and raw gas odours can still be perceived in the clean gas. Acid usage also makes the scrubber ineffective at scrubbing odorous organic acids [624, IRPP TWG 2013]. As a result, acid scrubbers are not generally considered suitable for odour elimination as a single-step process.

A fine dust (PM₁₀) removal efficiency of around 60 % can usually be obtained. If combined with a dedusting neutral stage, the removal efficiency of the system is expected to improve. (see Section 4.9.4). Data concerning the removal efficiency of chemical scrubbers applied in different animal types are reported in Table 4.138.

Table 4.138: Examples of removal efficiencies of chemical scrubbers applied in pig and poultry housing systems

Animal category	Source	Emissions reduction (%)			
		Ammonia	Odour	Dust	PM ₁₀
Pigs	[514, KTBL 2008]	70–95	NI	> 70	NI
Pigs	[54, Denmark 2010]	90–99	NI	NI	NI
Pigs	[130, Netherlands 2010] [132, Netherlands 2010] [133, Netherlands 2010] [134, Netherlands 2010]	95–99 70 ⁽¹⁾	30	NI	60
Broilers	[374, Denmark 2010]	80–90	NI	NI	NI
Laying hens	[131, Netherlands 2010] [644, Netherlands 2014]	70–90	40	NI	35
Pullets					
Broiler breeders					
Broilers					
Ducks					
Turkeys					
⁽¹⁾ A lower removal efficiency (about 70 %) is achieved when the filter is operated with a higher filter surface area and, consequently, at lower costs. NB: NI = no information provided.					

In Table 4.139, reported ammonia emissions after treatment with an acid scrubber are presented.

Table 4.139: Reported emission levels achieved with the application of acid scrubbers

System	NH ₃ reduction efficiency (%)	Animal category	Ammonia	Odour	PM ₁₀	Reference
			kg/ap/yr	ou _E /s/animal	g/ap/yr	
Acid scrubber with partial air treatment	90	Fattening pigs	0.4 (100 % air cleaned)	NI	NI	[54, Denmark 2010]
			0.56 (60 % air cleaned)			
			1 (20 % air cleaned)			
Acid scrubber (6 500 m ³ /m ² /h surface filter load, pH 3–4, bed thickness 0.9 m)	95	Fattening pigs	0.13–0.18 ⁽¹⁾	12.5–16.1 ⁽²⁾	31–99	[130, Netherlands 2010] [133, Netherlands 2010]
		Weaners	0.03–0.04 ⁽¹⁾	3.8–5.5 ⁽²⁾	53	
		Mating and gestating sows	0.21	13.1	88	
		Farrowing sows	0.42	19.5	83	
Acid scrubber (10 000 m ³ /m ² /h surface filter load, pH 0.5–4, bed thickness 0.5 m)	70	Fattening pigs	0.8–1.1 ⁽¹⁾	12.5–16.1 ⁽²⁾	31–99	[132, Netherlands 2010] [134, Netherlands 2010]
		Weaners	0.18–0.23 ⁽¹⁾	3.8–5.5 ⁽²⁾	53	
		Mating and gestating sows	1.3	13.1	88	
		Farrowing sows	2.5	19.5	83	
Acid scrubber with droplet separator	90	Laying hens	0.032	0.2	59	[131, Netherlands 2010]
		Broilers	0.008	0.14	15	
		Turkeys	0.07	0.93	16	
		Pullets	0.017	0.11	21	
		Pullets of broiler breeders	0.025	0.11	16	
		Broiler breeders	0.058	0.56	30	

⁽¹⁾ The upper end of the range corresponds to more space being available per animal.
⁽²⁾ The lower end of the range is associated with low-NH₃-emitting housing systems.
 NB: NI = no information provided.

The pH at which each system operates is different: generally, when the liquid reaches pH 4, acid is added to the circulating liquid to obtain pH values of 3, 1.5 or as low as 0.5. The concentration of ammonium sulphate should not exceed 2.1 mol/l to prevent the risk of crystallisation. On average, 90 litres of water and 3 litres of 96 % sulphuric acid are needed to remove 1 kg of ammonia from input air, which means a concentration of 0.3 mol/l [55, Denmark 2010]. The replacement of the circulating liquid is automatic and can be done after the pH has been corrected to the value needed a number of times (e.g. pH correction to 0.5 five times) [134, Netherlands 2010] [130, Netherlands 2010]. Hence the system management

can be controlled by using electronic devices to control operating parameters. Filters and components need frequent maintenance and control.

Under optimal conditions, it is reported from Germany that approximately 40 litres of scrubbing water need to be drained per fattening pig place per year in slurry-based pig housing. The fresh water requirements to compensate for evaporation losses amount to 5–7 l/1 000 m³ exhaust air [514, KTBL 2008]. For the high NH₃ removal efficiency of 95 %, the waste water production is about 0.2 m³/kg of NH₃ removed per year, which equals a yearly amount of 70 litres per fattening pig place or 2 litres per broiler place [13, Melse 2009].

In broiler houses, emissions are significant only after days 15–20 of the cycle and only at this time does cleaning of exhaust waste air become justifiable (see Figure 4.72).

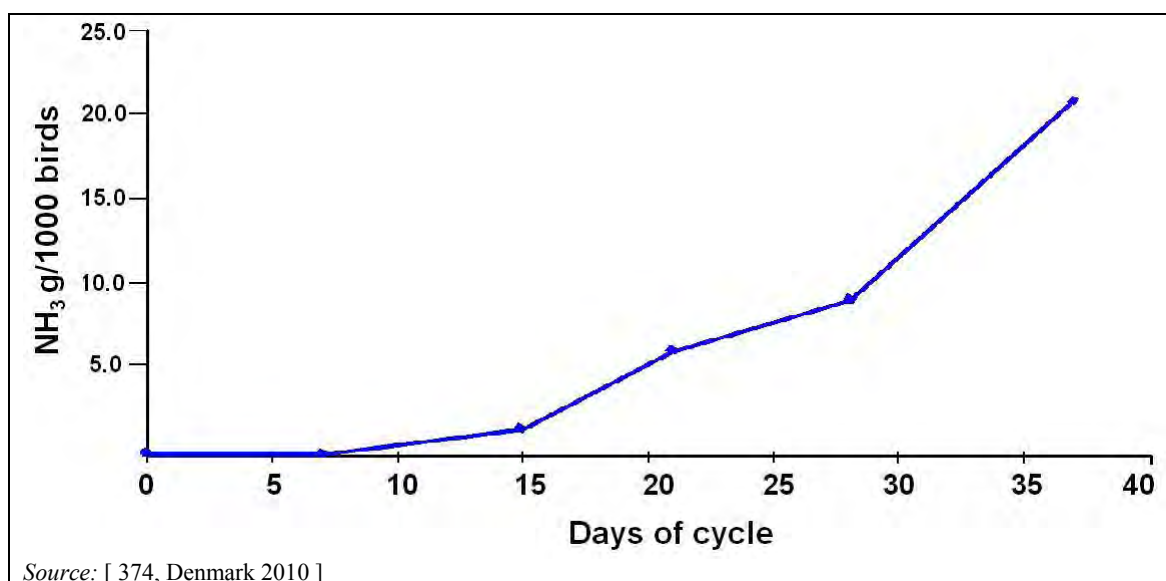

Figure 4.72: Ammonia emissions from a broiler house

Table 4.140 presents data from Denmark concerning the additional energy consumption in relation to the proportion of airflow at the maximum ventilation rate that is treated.

Table 4.140: Additional energy consumption associated with air cleaning by an acid scrubber applied in pig farms in Denmark

Animal type	Partial air cleaning capacity at the maximum ventilation rate (%)	Additional energy consumption (kWh/animal produced)
Fattening pigs (30–100 kg)	31	2–4 ⁽¹⁾
Weaners (30 kg)	100	6.8
Weaners (30 kg)	34	1.3
Gilts	100	24

⁽¹⁾ These values correspond to 8–16 kWh/ap/yr.

Source: [55, Denmark 2010]

Technical considerations relevant to applicability

This system can be implemented in new and existing housing applying forced ventilation with centralised air extraction. Implementation in existing houses may be technically difficult depending on the configuration of the building due to the required installation of the necessary ducts for channelling the exhaust air (see Section 4.9.1).

In pig housing, the design and the size of the pen are not critical for the applicability of the system. In poultry housing, high dust levels in the exhaust air from the housing can affect the scrubbing performance; hence a dust filter may be necessary, which will increase pressure in the system and increase the energy use. The system can be easily turned on and off, making it suitable for poultry farms that apply all-in, all-out animal management.

Economics

Average costs have been calculated in the Netherlands and are reported in Table 4.141.

Table 4.141: Associated extra costs for acid scrubbers by associated ammonia reduction efficiency and animal category in the Netherlands

Animal category	Housing capacity (animal places)	Associated costs ⁽¹⁾			
		Investment costs (EUR/ap)		Total annual extra costs (EUR/ap/yr) ⁽²⁾	
NH ₃ removal efficiency		70 %	90 %	70 %	90 %
Pigs					
Weaners	2 016	10	12	2	3.5
Farrowing sows	130	105	120	20	30
Mating and gestating sows	477	60	70	15	20
Fattening pigs	4 200	30	35	8	11
Poultry					
Broilers	90 000	NI	2.7	NI	0.63
Broiler breeders	25 000	NI	8.55	NI	2.37
Laying hens	30 000 (aviary)	NI	3.10	NI	0.96
Laying hens	30 000 (deep litter)	NI	3.95	NI	1.09
⁽¹⁾ All cost data are given without VAT. ⁽²⁾ Annual costs include depreciation, interest, maintenance and all other operating costs. NB: NI = no information provided. Source: [131, Netherlands 2010] [132, Netherlands 2010] [133, Netherlands 2010] [589, Netherlands 2010]					

An example of investment and annual costs for an acid scrubber applied to a newly built facility for pig production, broken down for each cost factor, is given in Table 4.142 with separate values for each cost factor.

Table 4.142: Investment and annual operating costs for an acid scrubber applied to a new house for pig production

	EUR/animal place/yr
Investment costs ⁽¹⁾	32.8
Operating costs	
Annualised investment cost (10 %)	2.6
Maintenance (3 %)	1.5
Interest (6 %)	0.8
Electricity use (EUR 0.11/kWh)	3.3
Water use (EUR 1.0/m ³)	0.6
Chemical use (EUR 0.6/litre H ₂ SO ₄ , 98 %)	1.4
Waste water discharge ⁽²⁾	0.6
Total annual operating costs	8.2
Total annual costs	10.8
⁽¹⁾ The investment costs are based on a maximum ventilation capacity of 60 m ³ /ap/h. ⁽²⁾ Waste water disposal costs are assumed to be equivalent to EUR 10/m ³ for discharge from acid scrubbing. Source: [568, Melse et al. 2010]	

From Denmark, extra costs for the installation of new systems are reported to be in the range of EUR 0.5–5/ap/yr, depending on the farm size [54, Denmark 2010]. Extra costs based on the share of the maximum ventilation rate treated by the chemical scrubber range from EUR 2 to EUR 2.4 per pig produced when the air cleaning capacity of the scrubber is equal to the maximum ventilation rate. Meanwhile, extra costs of between EUR 0.1 and EUR 1.2 per pig produced are reported for a 20 % partial air cleaning capacity of the maximum ventilation rate, with the low value corresponding to a large farm with approximately 8 000 fattening pig places [55, Denmark 2010].

Examples of extra cost data, for different animal categories and sizes of housing in the rearing of poultry, are presented in Table 4.143.

Table 4.143: Extra costs related to the application of acid scrubbers in poultry housing

Type of animal	Size of housing animal places (ap)	Extra investment (EUR/ap)	Annualised extra investment (EUR/ap)	Annual operating extra cost (EUR/ap)	Total annual extra cost (EUR/ap)	Total annual extra cost (EUR per animal produced)
Pullets	50 000	2.77	0.37	0.50	0.87	0.34
Laying hens (aviary)	40 000	3.44	0.46	0.63	1.10	1.25
Growing pullets of broiler breeders	33 000	3.95	0.52	0.71	1.23	0.60
Broiler breeders	19 000	7.59	1.00	1.40	2.40	2.35
Broilers	90 000	3.69	0.50	0.62	1.12	0.163
Turkeys	20 000	24.7	3.39	4.37	7.76	2.68
Ducks	40 000	5.65	0.76	0.93	1.69	0.26

Source: [503, Vermeij 2011]

Driving force for implementation

Local regulations on ammonia emissions can set maximum emission loads. In some Member States, air treatment systems are frequently required by environmental permits in situations where it would otherwise not be possible to comply with ammonia emission limit values.

Example plants

This system is commonly used in the Netherlands, Germany and Denmark. About 25–30 pig farms were reported to be applying acid scrubbers in Denmark [54, Denmark 2010], whereas one broiler farm was reported for the poultry sector [374, Denmark 2010]. In the Netherlands, the installed capacity of acid scrubbers for ammonia removal, referring to the year 2008, was reported as 64 million m³/h installed on a total of 790 farms [568, Melse et al. 2010]. In the Flemish part of Belgium, 145 farms are equipped with acid scrubbers.

Reference literature

[13, Melse 2009] [42, Netherlands 1999] [54, Denmark 2010] [55, Denmark 2010] [130, Netherlands 2010] [131, Netherlands 2010] [132, Netherlands 2010] [133, Netherlands 2010] [134, Netherlands 2010,] [374, Denmark 2010] [503, Vermeij 2011] [514, KTBL 2008] [568, Melse et al. 2010] [589, Netherlands 2010] [624, IRPP TWG 2013] [644, Netherlands 2014]

4.9.5 Biofilter

Description

The exhaust air of the animal house is led through a filter bed of organic material, such as root wood or wood chips, coarse bark, compost or peat. These materials are generally arranged in layers, i.e. the filter bed consists of coarse material on the untreated exhaust air side and finer material on the clean air side. Fine-grained filter materials have a relatively large specific surface area that facilitates mass transfer but, on the other hand, causes higher pressure losses.

The filter material is kept sufficiently moist at all times, so that microorganism populations can form a film. This is achieved by either humidifying the exhaust air to a relative humidity of at least 95 % and/or by controlled intermittent sprinkling of the surface of the filter material. Moistening of the entire filter surface is required in order not to compromise performance, even if the air entering is saturated; in particular in summer and in open surface filters, it is necessary to compensate for evaporation losses. Gaseous compounds are absorbed by the moisture film of the biofilter material and are oxidised or degraded by microorganisms living on the moisturised filter material.

Achieved environmental benefits

Biofilters are mainly used to eliminate odours arising from houses with no bedding material. They can also be used in litterless housing for dust separation, if coarsely structured filter material (which does not tend to clog) is used at least on the crude gas side.

Ammonia is also degraded in biofilters, but the possible cross-media effects need to be taken into account. This aspect, together with the unknown decline of the performance over time, makes the ammonia removal efficiency of biofilters controversial.

Cross-media effects

The system involves an extra pressure drop of roughly 30–150 Pa [514, KTBL 2008], which depends on the filter surface load, the type and height of the filter material and its age. Ventilating fans must be able to overcome the added resistance; therefore, additional energy consumption is required for ventilation. The water consumed for moistening the substrate is reported to be in the range of 5–7 litres per 1 000 m³ of exhaust air.

The system is not suitable as a sole process for ammonia reduction from exhaust air from livestock houses with a high ammonia load. Due to the separation of ammonia, the microbial activity is influenced and the pH value is significantly lowered (no adjustments are possible), while the formed salts cannot be removed. Finally, secondary trace gases are formed, such as nitrous oxides and N₂O, which risk the functionality of the whole system.

If the bed scrubber filter material consists of peat, a significant emission of greenhouse gases (GHG) would be associated with the peat mining process, while GHG emissions from the farm system itself may become significant due to the potential formation of N₂O.

Environmental performance and operational data

Biofilters function properly if:

- the pollutants to be treated are water-soluble and biodegradable;
- the residence time of the exhaust air to be cleaned is long enough that the odorants can be separated and degraded by microorganisms without these components or reaction products accumulating in the biofilter material;
- the operating conditions guarantee a sufficient supply of oxygen, water and nutrients to the microorganisms at temperatures of 10 °C to 35 °C [514, KTBL 2008].

A capacity of 440 m³/h of exhaust air per m² of filter surface has been reported. Based on this value and knowing the airflow rate that has to be treated, the dimensions for a filter module can be estimated. The thickness of the active filter layer is normally between 0.3 m and 1.4 m, depending on the material (for coarser materials a large bed height is necessary), whereas the residence (contact) time ranges from 4 seconds to 20 seconds depending on the filter height and surface load. Upscaling or downscaling of the treatment capacity, due to the modular design, is possible.

The sprinkling of the filter with fresh water (approximately 5–7 litres of water/1 000 m³ of outgoing air, achieving a 60–70 % material moisture) is automatically controlled on the basis of the airflow volume. The filter is moistened from the surface by two nozzles per filter module.

The resource demand for operating a biofilter with a capacity of 255 000 m³/h exhaust air volume, corresponding to an animal house of 3 000 animal places for fattening pigs, is reported in Table 4.144. About 21 kWh/animal place per year of energy is needed for pressure compensation in the ventilation system. Furthermore, 1.53 m³/animal place per year of water consumption is necessary.

Table 4.144: Annual resources demand for the operation of a biofilter, in Germany

Resource	Unit	Consumption (per 1 000 m ³ /h capacity) (¹)	Average annual consumption for 255 000 m ³ /h of capacity
Energy – Operation of the air cleaning system	kWh/yr	3.3	840
Energy – Additional consumption for ventilation	kWh/yr	250 (220–280)	63 400
Fresh water	m ³ /yr	18 (14–22.5)	4 600
Labour	h/yr	0.35–0.40	90
NB: NA = not applicable.			
Source: [120, Germany 2010]			

As for all air cleaning systems, the odour removal efficiency depends on the crude gas concentration and is reported to be from 84 % to 97 % [120, Germany 2010]. The minimum requirement for odour reduction of air cleaning systems applied in Germany is defined as an odour concentration in the clean gas not exceeding 300 ou_F/m³ and no typical process odours (e.g. animal house odour) are perceptible in the clean gas. Biofilters achieving a removal efficiency for odour of over 70 % have only been verified in pig housing [514, KTBL 2008].

The dust abatement efficiency is reported to be from 80 % to 100 % [120, Germany 2010] [644, Netherlands 2014]. Measurements of the finest dust fraction, PM_{2.5}, indicate an abatement efficiency of 63 % [515, UR Wageningen 2010].

In Germany, the application of biofilters for ammonia reduction is not recommended, but, at the same time, it is acknowledged that a biofilter can also be operated as an ammonia abatement technique under certain conditions (e.g. in combination with a water curtain) and if carefully operated (comparable to the requirements for bioscrubbers) [500, IRPP TWG 2011]. The ammonia abatement efficiency is reported to be over 70 % [516, TÜV 2009] and up to 89 %, but it is not clear whether the removal efficiency can stay high over time due to the secondary effects previously described (see 'Cross-media effects') [515, UR Wageningen 2010] [500, IRPP TWG 2011].

In order not to undermine the removal capacity of the bed, regular replacement of the biofilter packing is necessary. Pretreating the air in order to remove the main part of the ammonia load before it enters the biofilter minimises the formation of nitrite/nitrate salts and allows a much

longer packing lifespan and thus reduces refilling costs [568, Melse et al. 2010]. Used biofilter materials are applied to land. No additional waste water is produced.

Technical considerations relevant to applicability

Biofilters are mainly used in houses with no bedding material (slurry-based plants). As the filter area requirement is approximately 0.2–0.25 m² per animal place, a sufficient area must exist outside the facilities to accommodate the filter packages.

The implementation in existing houses with forced ventilation must be planned with the adaptation of exhaust air ducts and with significant additional requirements for ventilation, making biofilters in practice only applicable where a centralised ventilation system is used.

Economics

Data are given for a capacity of 255 000 m³/h exhaust air volume, equivalent to 3 000 fattening pig places. A total annual cost of between EUR 11.60/ap and EUR 13.10/ap results from the amortisation (20 years for construction and 4 % interest rate) of the investment requirements (EUR 59–64/ap, annualised investment costs from EUR 6.5/ap to EUR 6.8/ap) added to annual operating costs of EUR 5.10–6.30 per animal place.

Driving force for implementation

Local high emission loads or insufficient spatial distances from odour-sensitive receptors are drivers.

Example plants

At least 267 German farms are using this technique [505, Hahne J. 2011].

Reference literature

[52, BE Flanders 2010] [120, Germany 2010] [500, IRPP TWG 2011] [514, KTBL 2008] [515, UR Wageningen 2010] [516, TÜV 2009] [568, Melse et al. 2010] [644, Netherlands 2014]

4.9.6 Multi-stage scrubber

Multi-stage air cleaning system clean exhaust air from forced ventilation livestock buildings that usually comprise two or three stages that work on different principles, e.g. acid scrubber to remove ammonia and a biofilter to remove odour. As a consequence, theoretically, there are many possible combinations. At least 438 German farms are using techniques of this type [505, Hahne J. 2011]. There are several two- and three-stage exhaust air treatment techniques, which can differ substantially each other. The following descriptions are limited to a two-stage acid scrubber with a downstream bioscrubber and a three-stage installation with a water scrubber and acid scrubber as well as a downstream biofilter.

4.9.6.1 Two-stage scrubber: wet acid scrubber combined with bioscrubber

Description

The air cleaning system consists of two stages in series: a chemical scrubber and a bioscrubber. The first stage is an acid scrubber to separate ammonia and dust (see Section 4.9.4). It consists of filter beds made of synthetic polymer fibres arranged in parallel with a high water storage capacity, followed by a drip separator. The filter beds are intermittently sprinkled with acidified water. Ammonia reacts with sulphuric acid, forming ammonium sulphate. With the aid of a controlled acid metering system, the pH value of the scrubbing water of the chemical stage is kept within a certain range (e.g. at a level of 1.5). When the pH value reaches a higher level (e.g. 4) due to ammonia absorption, acid is added until the pH value is reduced again. This cycle repeats itself a fixed number of times (e.g. five times). If again a high pH value has been achieved, complete blowdown takes place. Afterwards, the water storage tank is refilled with

fresh water and acid with a low pH value (e.g. 1.5). In the case of implementation in littered houses where dust loads are high, more frequent elutriation and cleaning are indispensable on the basis of differential pressure measurements [514, KTBL 2008].

The second stage is a biologically active wet scrubber, which is completely separated from the acid stage. Due to the biological activity in this step, odour is mainly reduced; fine dust is also reduced. The filter bed packing is made of plastic and is permanently sprinkled with water. The scrubbing water from this stage flows back into the water tank, which is equipped with an additional submerged contact bed for the improvement of the biological degradation of residual emissions of odorants. For the separation of aerosols from this stage, another drip separator is installed at the clean air outlet. Both stages are of transverse flow of exhaust air.

A scheme of a two-stage system for air scrubbing is presented in Figure 4.73.

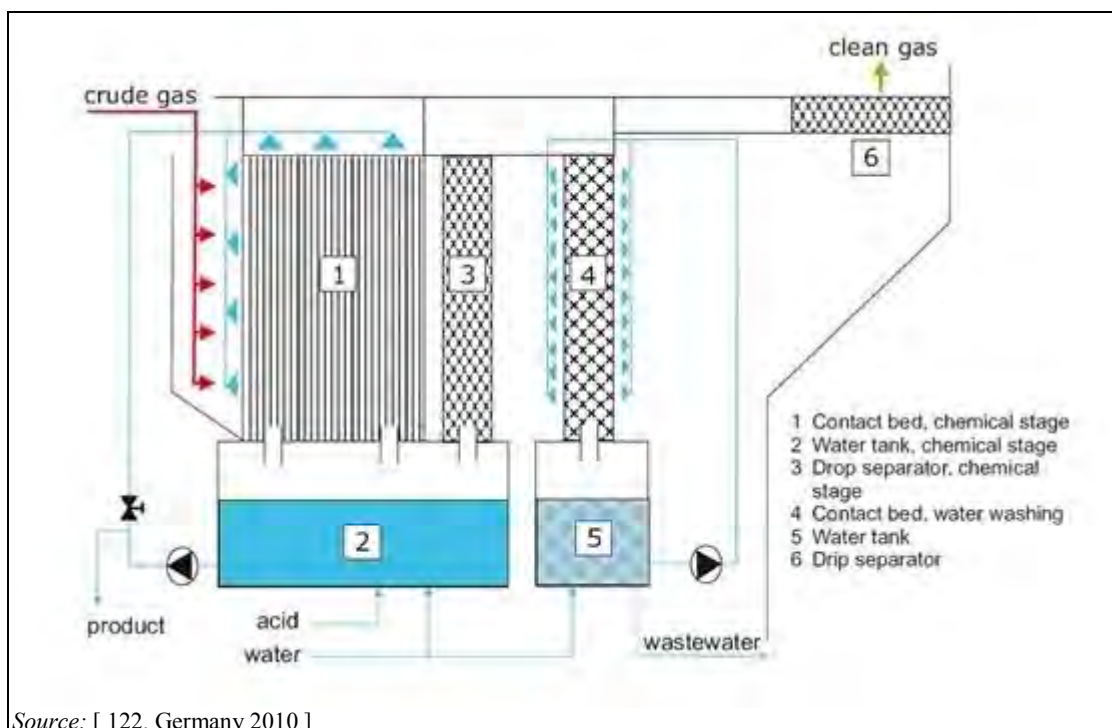

Source: [122, Germany 2010]

Figure 4.73: Two-stage scrubber: acid scrubber combined with bioscrubber

Another reported option for the first treatment stage is to install a water curtain before the bioscrubber, which is operating as a water scrubber [127, Netherlands 2010] [129, Netherlands 2010].

Achieved environmental benefits

Reduction of emissions of odorants, ammonia, and dust is an achieved environmental benefit.

Cross-media effects

The energy consumption is increased as the fans have to overcome a maximum pressure loss of 150–200 Pa (total for the ventilation system in the housing and the air cleaning system) without any loss of capacity.

The scrubbing water in the chemical stage, which contains ammonium sulphate, must be stored in a separate storage tank, whereas the scrubbing water from the separate water stage can be pumped into the external slurry store. Nitrogen has to be taken into account for fertiliser planning. Compared to a single-stage acid scrubber, the elutriation rate of the two-stage system corresponds to approximately threefold the amount.

Environmental performance and operational data

The amount of water that has to be rejected from the chemical stage amounts to 0.05 m³ per kg of NH₃ input, and from the biological stage 0.04 m³ per kg of NH₃ input. Its volume generally corresponds to 1.65 m³ per 1000 m³/h (0.14 m³/pig place per year) in the first cleaning stage (acid scrubber), and to 1.34 m³ per 1000 m³/h (0.11 m³/pig place per year) in the second cleaning stage (bioscrubber). Water losses due to evaporation and the necessary elutriation have to be compensated by fresh water addition; this supply is automatically controlled and separate for each stage [122, Germany 2010]. Ranges for the resource demand related to a capacity of 1000 m³/h are shown in Table 4.151.

Ammonia reductions are achievable in the range of 70 % to 96 %, along with a total dust reduction from 85 % to 98 %. The minimum requirement for odour reduction of air cleaning systems applied in Germany is defined as an odour concentration in the clean gas not exceeding 300 ou_E/m³ and no typical process odours (e.g. animal house odour) are perceptible in the clean gas [514, KTBL 2008]; on average, these results are equivalent to 70 % efficacy.

Data concerning the emission reductions achieved by applying two-stage scrubbers in pig production are presented in Table 4.145. Reported emissions in pig production after treatment of exhaust air with two-stage air scrubbers are presented in Table 4.146.

Table 4.145: Emission reductions achieved by the application of two-stage scrubbers in pig production

Achieved emission reduction (%)				Reference
Ammonia	Odour	Dust	PM ₁₀	
70–96 80 (average)	60–77 70 (average)	85–98 96 (average)	NI	[122, Germany 2010]
84–93 85 (average)	40–72 70 (average)	94–96	80	[125, Netherlands 2010]
84–93 85 (average)	40–72	94–96	80	[129, Netherlands 2010]
87–98	75	94–96	80	[127, Netherlands 2010]

NB: NI = no information provided.

Table 4.146: Emission levels achieved with the application of two-stage scrubbers in pig production

System	NH ₃ reduction efficiency (%)	Animal category	Ammonia (1)	Odour (2)	PM ₁₀	Reference
			kg/ap/yr	ou _E /s/animal	g/ap/yr	
Bioscrubber combined with water curtain	85	Weaners	0.09–0.11	1.4–2.0	26	[127, Netherlands 2010] [129, Netherlands 2010]
		Farrowing sows	1.25	7.0	42	
		Mating/gestating sows	0.63	4.7	44	
		Fattening pigs	0.38–0.53	4.5–5.8	55	
Acid scrubber combined with biological/water scrubber	85	Weaners	0.09–0.11	1.6–2.3	26	[125, Netherlands 2010]
		Farrowing sows	1.25	8.4	42	
		Mating/gestating sows	0.63	5.6	44	
		Fattening pigs	0.38–0.53	5.4–6.9	55	

(1) The higher end of the range for weaners and fattening pigs corresponds to more space being available per animal.
(2) The lower end of the range for weaners and fattening pigs is associated with low-NH₃-emitting housing systems.

Ammonia emissions between 0.062 kg and 0.065 kg/animal place/year were reported from an animal house for ducks, equipped with a two-stage scrubber, in Germany [646, COM 2013].

Technical considerations relevant to applicability

Two-stage air cleaning systems are also applicable to littered housing. The bioscrubber stage is preceded by the acid scrubber, which contributes to dust and feather removal. Additionally, a simpler filtering stage (water curtain) can be added to reduce dust as a first step.

The housing ventilation system requires proper planning (air inlet/outlet) and design (sufficient capacity of the fans for the increased pressure loss). In retrofitting existing houses, there are significant additional requirements for the adaptation of the air ventilation outlets and for the upgrading of the fans, making the system applicable only where a centralised ventilation system is used. Additionally, significant space must be available to host the various hardware.

Economics

Economic figures have been modelled in Germany for modules with a capacity of 1 000 m³/h, equivalent to 11.8 pig places at a standard ventilation of 85 m³/h per animal place. Results are given in Table 4.147.

Table 4.147: Cost ranges associated with the use of two-stage scrubber systems for exhaust air treatment in fattening pig production, in Germany

Housing capacity	Associated costs ⁽¹⁾							
	Investment costs		Annualised investment costs		Operating costs		Total costs	
	EUR per 1 000 m ³ /h	EUR/ap	EUR per 1 000 m ³ /h per yr	EUR/ap/yr	EUR per 1 000 m ³ /h per yr	EUR/ap/yr	EUR per 1 000 m ³ /h per year	EUR/ap/yr
460–700 animal places (39 000–60 000 m ³ /h) ⁽²⁾	826–884	70–75	107–112	9.1–9.5	116–127	9.9–10.8	223–239	19.0–20.3
1 060–1 180 animal places (90 000–100 000 m ³ /h) ⁽²⁾	796–851	68–72	102–107	8.7–9.1	107–118	9.1–10.0	209–225	17.8–19.1
1 700–1 850 animal places (150 000–157 000 m ³ /h) ⁽²⁾	746–802	63–68	94–99	8.0–8.4	102–113	8.7–9.6	196–212	16.7–18.0
3 000 animal places (255 000 m ³ /h) ⁽³⁾	745 (720–770)	61–65	85 (80–85)	6.8–7.2	130 (120–140)	10–12	215 (200–225)	17–19

⁽¹⁾ All cost data are given without VAT and are related to hew houses.

⁽²⁾ Costs are calculated on the following assumptions: amortisation period of 10 years for the installation and 20 years for the building, 6 % interest rate for 50 % of the investment, labour costs EUR 20/h, electricity EUR 0.12/kWh, water EUR 0.5/m³, acid EUR 0.25/kg, landspreading of waste water EUR 2.6/m³, maintenance 1 % of investment, additional costs for larger slurry store equal EUR 120/m³, additional costs for more powerful fans are EUR 3 per 1 000 m³ of installed air capacity.

⁽³⁾ Costs are calculated on the following assumptions: amortisation period of 10 years for the installation and 20 years for the building, 4 % interest rate, labour costs EUR 15/h, electricity EUR 0.15/kWh, water EUR 0.5/m³, acid EUR 0.35/kg, landspreading of waste water EUR 3/m³, maintenance 1 % of investment, additional costs for larger slurry store and additional costs for more powerful fans are included.

Source: [514, KTBL 2008] [122, Germany 2010]

Data related to the investment and total costs are reported in Table 4.148 for different system capacities in pig production in the Netherlands.

Table 4.148: Costs associated with the use of two-stage scrubbers with an 85 % NH₃ reduction efficiency, in the Netherlands

Pig category	Housing capacity (animal places)	Associated costs ⁽¹⁾	
		Investment costs (EUR/animal place)	Annual costs ⁽²⁾ (EUR/animal place/year)
Weaners	2 016	16	4
Farrowing sows	130	170	35
Mating and gestating sows	477	100	23
Fattening pigs	4 200	50	12

⁽¹⁾ All cost data are given without VAT.
⁽²⁾ Annual costs include depreciation, interest, maintenance and all other operating costs.
Source: [589, Netherlands 2010]

Driving force for implementation

In densely populated areas (e.g. the Netherlands) or in areas with a high animal density, air cleaning systems give farmers the only possibility to construct new housing facilities or expand the existing farming activity and still comply with the maximum allowed levels for ammonia, dust or odour emissions. It allows large-scale farms to remain in operation in areas located close to residential areas and sensitive ecosystems.

The capacity to remove PM₁₀ and PM_{2.5} has made multi-pollutant air cleaning systems more interesting for application in poultry facilities located in areas exceeding fine dust threshold levels in the air [424, VERA 2010].

Example plants

Several farms in Germany use the technique.

Reference literature

[122, Germany 2010] [125, Netherlands 2010] [127, Netherlands 2010] [129, Netherlands 2010] [424, VERA 2010] [514, KTBL 2008] [589, Netherlands 2010] [646, COM 2013]

4.9.6.2 Three-stage scrubber: water scrubber combined with wet chemical scrubber and biofilter

Description

This combination consists of three stages (see Figure 4.74). The first stage is a water scrubber that generally removes dust and converts part of the ammonia into nitrate and nitrite by means of the microbial activity in the washing water. Different materials and designs can be used for the plastic packing of the filter beds (e.g. having a specific surface area of around 320 m²/m³ and one filter bed with a thickness of 0.15 m). The recirculating water is not mixed with water from the next stage. Given the large filter bed surfaces, it is particularly important for this type of installation that the ventilation system can achieve an even airflow under all climatic conditions.

The second stage is an acid scrubber. The filter bed is continuously sprayed with diluted sulphuric acid solution and removes the main part of the ammonia content, as long as the pH is kept low (e.g. below 5), and dust. It is possible to use different combinations of specific surface area and filter bed thickness. A complete blowdown is needed after a fixed interval (e.g. 2 months). Water losses due to evaporation and elutriation are compensated by fresh water addition.

The third and last treatment stage is a biofilter (see Section 4.9.5) made of a column packed with coarse root wood, which is frequently sprayed with water to keep it moist. The spraying frequency depends on the weather conditions. This filter has a larger bed height (at least 0.6 m) compared to the scrubbing stages. In this third step, microbes that are present on the root wood substrate remove odour compounds and part of the ammonia left from the previous stages.

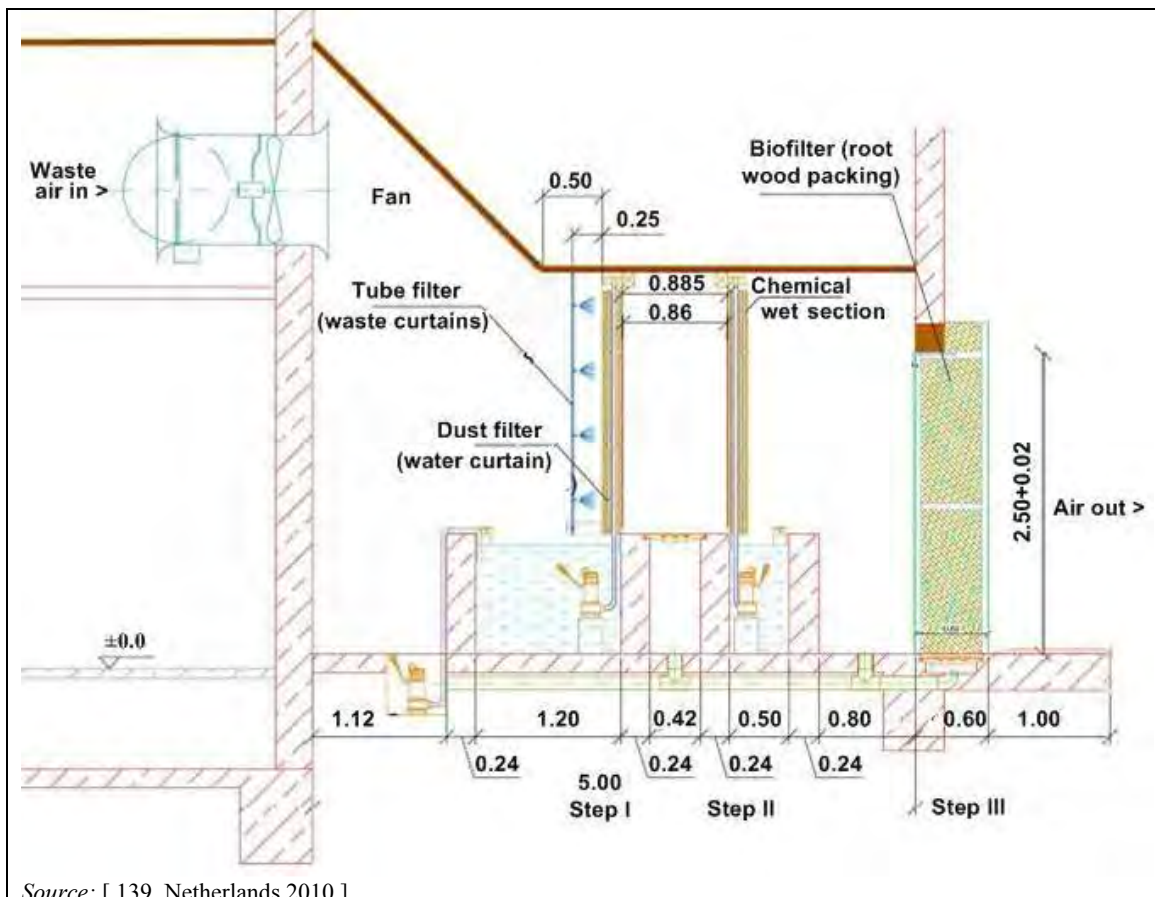

Source: [139, Netherlands 2010]

Figure 4.74: Three stage scrubber: water scrubber combined with wet acid scrubber and biofilter

Achieved environmental benefits

Emissions to air of ammonia, odour and dust are reduced. A reduced waste water volume is produced, in comparison with the application of a bioscrubber, as reported under 'Environmental performance and operational data'.

Cross-media effects

Additional energy consumption is required to run pumps and, especially, fans in order to overcome the increased pressure drop without any capacity loss (up to 150 Pa); the resulting energy consumption may double. Increased water consumption is required due to the necessary elutriation. Waste water can be disposed of or reused as fertiliser, e.g. together with the slurry for landspreading (see 'Environmental performance and operational data'), in which case the related load of nitrogen has to be taken into account for a correct planning of the fertiliser. Water from the acid scrubbing stage must be stored separately. Noise emissions can be associated with the intense operation of the fans.

Environmental performance and operational data

Emission reductions have been measured in pig farms in the Netherlands under the Dutch Livestock Farming Regulation. Ranges for ammonia reduction were from 64 % to 84 %, and for odour reduction ranges were from 64 % to 87.9 %. The achievable dust removal is from 94.8 % to 97.8 %, of which 80 % is related to PM₁₀. The performance of three-stage systems applied in

housing for pigs and sows is reported in Table 4.149, expressed as removal efficiencies for ammonia, odour and dust.

Table 4.149: Examples of removal efficiencies achieved with a three stage scrubber system (water scrubber, wet acid scrubber and biofilter)

Housing system characteristics	Removal efficiencies			
	Ammonia (%)	Odour (%)	Dust (%)	PM ₁₀ (%)
3 000 animal places for fattening pigs	70–95	50–90	70–95	NI
1 320 animal places for fattening pigs Filter surface load 3 020 m ³ /(m ² h)	82.5–97.5 (warm period) 68.1–96 (cold period) 85 (Dutch ammonia and livestock farming regulation)	79–87.9 (warm period) 71.1–82.3 (cold period) 75 (based on Dutch odour nuisance and livestock farming regulation)	94.8–97.8	80
600 animal places for sows Filter surface load 3 020 m ³ /(m ² h)	70.1–79 70 (Dutch ammonia and livestock farming regulation)	64–84 80 (Dutch odour nuisance and livestock farming regulation)	95	80
NB: NI = no information provided.				
Source: [123, Germany 2010] [126, Netherlands 2010] [128, Netherlands 2010] [514, KTBL 2008]				

Reported emissions in pig production after treatment of exhaust air with three-stage air scrubbers are presented in Table 4.150.

Table 4.150: Emission levels achieved with the application of three-stage scrubbers in pig production

System	NH ₃ reduction efficiency (%)	Animal category	Ammonia	Odour ⁽²⁾	PM ₁₀	Reference
			kg/ap/yr	ou _E /s/animal	g/ap/yr	
Water scrubber + acid scrubber + biofilter combined with water curtain	70	Weaners	0.18–0.23 ⁽¹⁾	1.1–1.6 ⁽²⁾	26	[128, Netherlands 2010]
		Farrowing sows	2.49	5.6	42	
		Mating/gestating sows	1.26	3.7	44	
		Fattening pigs	0.75–1.05 ⁽¹⁾	3.6 ⁽²⁾	55	
Water scrubber + acid scrubber + biofilter combined with water curtain	85	Weaners	0.09–0.11 ⁽¹⁾	1.4–2 ⁽²⁾	26	[126, Netherlands 2010]
		Farrowing sows	1.25	7	42	
		Mating/gestating sows	0.63	4.7	44	
		Fattening pigs	0.38–0.53 ⁽¹⁾	4.5–5.8 ⁽²⁾	55	
⁽¹⁾ The higher end of the range corresponds to more space being available per animal. ⁽²⁾ The lower end of the range is associated with low-NH ₃ -emitting housing systems.						

Data for energy consumption and other resources demand, related to a capacity of 1 000 m³/h that is equivalent to 11.8 fattening pig places, are shown in Table 4.151.

Table 4.151: Annual resources demand for the operation of a multi-stage scrubber, in Germany

Resource	Unit	Three-stage scrubber (consumption per 1 000 m ³ /h of capacity)	Two-stage scrubber (consumption per 1 000 m ³ /h of capacity)
Energy - Operation of the air cleaning system	kWh/yr	130 (100–150)	190
Energy – Additional consumption for ventilation	kWh/yr	215 (180–250)	250 (220–280)
Fresh water	m ³ /yr	20 (16–25)	21 (14.9–25.5)
Sulphuric acid	kg/yr	27 (20–34)	100
Labour	h/yr	0.3–0.4	0.4

Source: [122, Germany 2010] [123, Germany 2010]

The waste water arising from the bioscrubber, equivalent to about 1.8 m³ per 1 000 m³/h (0.15 m³/pig place/yr) should be stored (e.g. pumped into the slurry container) and reused taking into account the added nitrogen load. Waste water from the acid scrubber stage needs a separate storage; their volumes are around 0.7 m³ per 1 000 m³/h (0.06 m³/pig place/yr).

A reduced amount of waste water is produced by a three-stage scrubber in comparison with a bioscrubber. While in the bioscrubber, a good removal efficiency can only be guaranteed if at least 0.2 m³/kg NH₃ input are elutriated; in three-stage installations, whose removal efficiency is at least equal to bioscrubbers, only 0.055–0.083 m³/kg NH₃ input has to be discharged separately. The difference in the scrubbing waste water produced is presented in Table 4.152, for a house of 1 000 pigs located in Germany.

Table 4.152: Waste water volume produced by air cleaning system in a housing system for 1 000 fattening pigs

Air cleaning system	Elutriation rate (m ³ /kg NH ₃ input)	Quantity of waste water (m ³ /year)
Bioscrubber	0.2	730
Three-stage scrubber	0.055–0.083	200–300

NB: Results are based on an emission factor of 3.64 kg NH₃/ap/yr (no crude-protein-adapted feed).

Acid consumption can be reduced considerably if the system is operated in such a way that the nitrification provides biogenous acid formation at the first scrubbing stage and the scrubbing water is changed often [123, Germany 2010].

Technical considerations relevant to applicability

Three-stage air cleaning systems are also applicable to littered housing since the biofilter is preceded by the wet scrubbers which remove dust and/or feathers.

The ventilation system requires proper planning (air inlet/outlet) and design (sufficient capacity of the fans for the increased pressure). In retrofitting existing houses, there are significant additional requirements for the adaptation of the air ventilation outlets and for the upgrading of the fans, making the system applicable only where a centralised ventilation system is used. Additionally, significant space is needed to host the various pieces of hardware.

Economics

Economic data for exhaust air treatment have been modelled in Germany for modules of a capacity of 1 000 m³/h, equivalent to 11.8 pig places at a standard ventilation of 85 m³/h per animal place. Results for different system capacities in fattening pig production are given in Table 4.153.

Table 4.153: Cost ranges associated with the use of three-stage scrubber systems (combining a water scrubber, wet acid scrubber and biofilter) in fattening pig houses

Housing capacity	Associated costs ⁽¹⁾ ⁽²⁾							
	Investment costs		Annualised investment costs		Operating costs		Total annual costs	
	EUR per 1 000 m ³ /h	EUR/ap	EUR per 1 000 m ³ /h per yr	EUR/a p/yr	EUR per 1 000 m ³ /h per yr	EUR/ap/yr	EUR per 1 000 m ³ /h per year	EUR/ap/yr
460–700 animal places (39 000–60 000 m ³ /h)	700–1100	60–94	82–116	7.0–9.96	128–166	10.9–14.1	210–282	17.9–24.00
1 060–1 180 animal places (90 000–100 000 m ³ /h)	531–671	45–57	60–68	5.1–5.8	103–122	8.8–10.4	163–190	14.9–16.6
1 700–1 850 animal places (150 000–157 000 m ³ /h)	474–589	40–50	52–59	4.4–5.0	101–112	8.6–9.5	153–171	13.4–15.1
3 000 animal places (255 000m ³ /h)	500–615	43–52	50–60	4.2–5	80–100	6.80–8.5	130–160	11–13.5

⁽¹⁾ All cost data are given excluding VAT.
⁽²⁾ Costs are calculated on the following assumptions: amortisation period of 10 years for the installation and 20 years for the building, 6 % interest rate for 50 % of the investment, labour costs EUR 20/h, electricity EUR 0.12/kWh, water EUR 0.5/m³, acid EUR 0.25/kg, landspreading of waste water EUR 2.6/m³, maintenance 1 % of investment, additional costs for larger slurry store equal EUR 120/m³, additional costs for more powerful fans are EUR 3 per 1 000 m³ of installed air capacity.

Source: [514, KTBL 2008] [123, Germany 2010]

Investment and operating costs related to the application on a newly built facility of a three-stage system with a bioscrubber as the third stage, in place of a biofilter, are reported in Table 4.154.

Table 4.154: Investment and annual operating costs for a three-stage scrubber (water and acid scrubber + biotrickling) applied to a newly built facility for fattening pig production

	EUR/animal place/yr
Investment costs ⁽¹⁾	50.3
Operating costs	
Annualised investment cost (10 %)	4.2
Maintenance (3 %)	2.0
Interest (6 %)	1.2
Electricity use (EUR 0.11/kWh)	3.7
Water use (EUR 1.0/m ³)	0.6
Chemical use (EUR 0.6/litre H ₂ SO ₄ , 98 %)	0.7
Water discharge ⁽²⁾	1.0
Total annual operating costs	9.2
Total annual costs	13.5

⁽¹⁾ The investment costs are based on a maximum ventilation capacity of 60 m³/ap/h.
⁽²⁾ Waste water disposal costs are assumed to be equivalent to EUR 10/m³ for discharges from acid scrubbing and EUR 2/m³ for discharges from biotrickling or water scrubbing. Discharge water from the biotrickling and water scrubbing stages is reused in the acid scrubbing stage.

Source: [568, Melse et al. 2010]

Driving force for implementation

In individual cases of insufficient spatial distance from the nearest existing or planned residential buildings or other odour-sensitive constructions, as is the case in densely populated areas (e.g. in the Netherlands), or from nitrogen-sensitive ecosystems (e.g. forests), air cleaning systems give farmers the only possibility to expand the activity and still comply with the maximum levels allowed for ammonia, dust or odour emissions.

The capacity to remove PM₁₀ and PM_{2.5} has made multi-pollutant air cleaning systems more interesting for application in poultry facilities located in areas exceeding fine dust threshold levels in the air [424, VERA 2010].

Example plants

The system is in operation in several pig farms in the Netherlands and Germany.

Reference literature

[122, Germany 2010] [123, Germany 2010] [126, Netherlands 2010] [128, Netherlands 2010] [139, Netherlands 2010] [424, VERA 2010] [514, KTBL 2008] [568, Melse et al. 2010]

4.9.7 Partial air treatment in air cleaning systems

Description

In forced ventilated houses, ventilation rates depend on the production stage and climatic conditions; the ventilation system does not operate at its maximum capacity over the course of the year. Therefore, maximum (for summer) and average exhaust airflow rates can be defined and air cleaning systems can be dimensioned accordingly. In this case, it is possible to install an air bypass system so that a portion of the exhaust air can be expelled from the house without being treated, whilst the remaining exhaust air passes through the air cleaning system. Hence the air cleaning systems are operated at designated airflow rates, which are lower than the maximum ventilation rates that can occur in the animal house.

Achieved environmental benefits

The size of the air cleaning system is reduced, resulting in an increased efficiency of scrubber utilisation (kg of NH₃ removed per m³ of scrubber volume). The technique of partial treatment of exhaust air ensures that ventilation needs are met for the health and welfare of the animals and that air cleaning systems can be still operated efficiently.

Cross-media effects

The disadvantage of this technique is that peak emission management is not possible (e.g. summer heat, heavier animals requiring high ventilation rates). For ammonia emission levels, which are generally set in terms of yearly averages, this disadvantage may be irrelevant; however, for other pollutants such as dust and odour, for which peak emission levels are usually established, it may cause an above average nuisance to the neighbourhood.

Environmental performance and operational data

Ammonia emission levels and the associated costs for implementing the cleaning system are presented in Table 4.155. Data for a two-stage bioscrubber and for a two-stage chemical scrubber are reported for different percentages of exhaust air treated by the air cleaning system.

Table 4.155: Emission levels and cost data for different percentages of exhaust air treated by two-stage air cleaning systems

Type of cleaning system	Percentage of exhaust air treated (%)	Ammonia emissions (kg NH ₃ /ap/yr) ⁽¹⁾	Total costs (EUR/ap/yr) ⁽¹⁾
Bioscrubber	100	0.44	12
Bioscrubber	60	0.56	7.6
Bioscrubber	40	NI	2.8
Bioscrubber	20	0.88	NI
Acid scrubber	100	0.40	NI
Acid scrubber	60	0.56	NI
Acid scrubber	20	1	NI

⁽¹⁾ Cost data are calculated on the basis of a production of four pigs per animal place per year.
 NB: NI = no information provided.
Source: [53, Denmark 2010] [54, Denmark 2010]

Technical considerations relevant to applicability

Bypasses may only be installed if local regulations allow (e.g. in the Netherlands, bypasses are not allowed). The principle of the technique is independent of the animal category; therefore, it is applicable in pig and poultry rearing.

Economics

The investment cost per m³ of exhaust air to be treated will be only slightly higher due to the additional costs of the bypass itself. On the other hand, the total costs for air cleaning are reduced as the investment and operating costs of scrubbers are related to their size.

Driving force for implementation

Low emission levels can be achieved at reduced costs of treatment with air cleaning system. In this way, it is possible to design the ventilation/cleaning system on the basis of the required reduction levels set for a specific location by the competent authorities.

Example plants

This technique is commonly used in Denmark upon permit specification.

Reference literature

[13, Melse 2009] [53, Denmark 2010] [54, Denmark 2010] [514, KTBL 2008]

4.9.8 Dry filters**Description**

The air being drawn to the exhaust outlet passes through a filter, placed in a plenum chamber in front of the exhaust fan, made of multi-layered plastic or paper filters for example, which forces the air to change direction many times within the body of the filter (see Figure 4.75). The centrifugal force of air circulating in the many cavities of the filter separates the dust from the airflow, allowing dust particles to fall and be collected in V-shaped filter pockets.

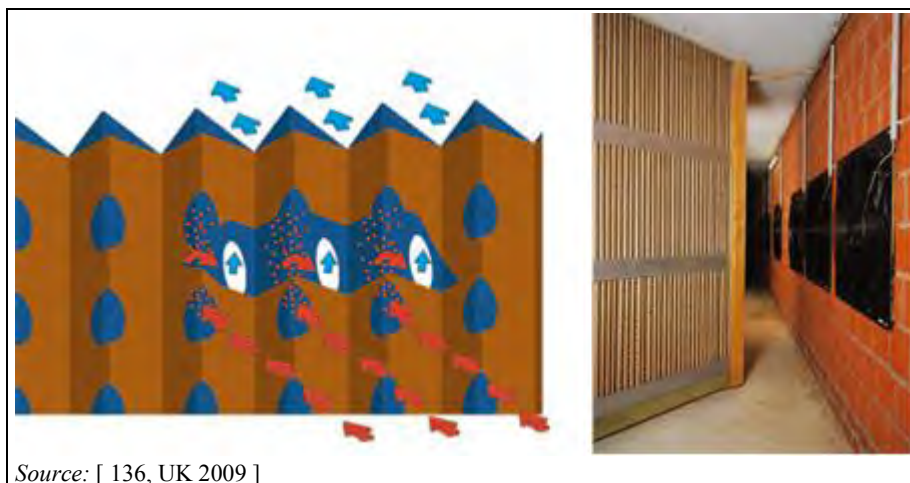

Source: [136, UK 2009]

Figure 4.75: Schematic of a dry filter installed in a broiler house

Achieved environmental benefits

Reduction of dust emissions is the achieved environmental benefit.

Cross-media effects

The filters need to be cleaned regularly, and the collected dust can be spread on land with the manure. Filters do present a resistance to airflow, so fans must operate at a higher pressure. Therefore, the system must allow for the high air volume and air speed necessary for heat stress relief in broilers.

Environmental performance and operational data

Commercial results suggest a 70 % reduction in visible exhaust dust. The dust removal efficiency has been measured in one broiler farm as 41 % \pm 4 for PM_{2.5} and 64 % \pm 6 for PM₁₀ fractions. Bacteria and fungi concentrations were reduced by 1 % and 20 % (on a logarithmic scale), respectively.

Technical considerations relevant to applicability

The system can be retrofitted in poultry houses with a tunnel ventilation system.

Economics

Investment, operating and maintenance costs are significantly reduced compared to wet scrubbing systems used for air treatment. The capital cost for the installation of a dry filter is estimated to be about EUR 1.14 (EUR 1 = GBP 0.88) per 30 m³ of air, the same cost as for treating 3–4 m³ of air with a wet scrubbing system.

Driving force for implementation

Local regulations imposing limit values for dust emissions are the driving force.

Example plants

Several examples have been fitted in UK broiler farms.

Reference literature

[136, UK 2009]

4.9.9 Water trap

Description

The exhaust air is directed downwards onto a water bath (e.g. 15 cm pit containing water) to soak up dust particles, and then redirected 180 ° upwards to the air to disperse any pollutants further (see Figure 4.76). The water bath needs to be filled regularly to compensate for evaporation.

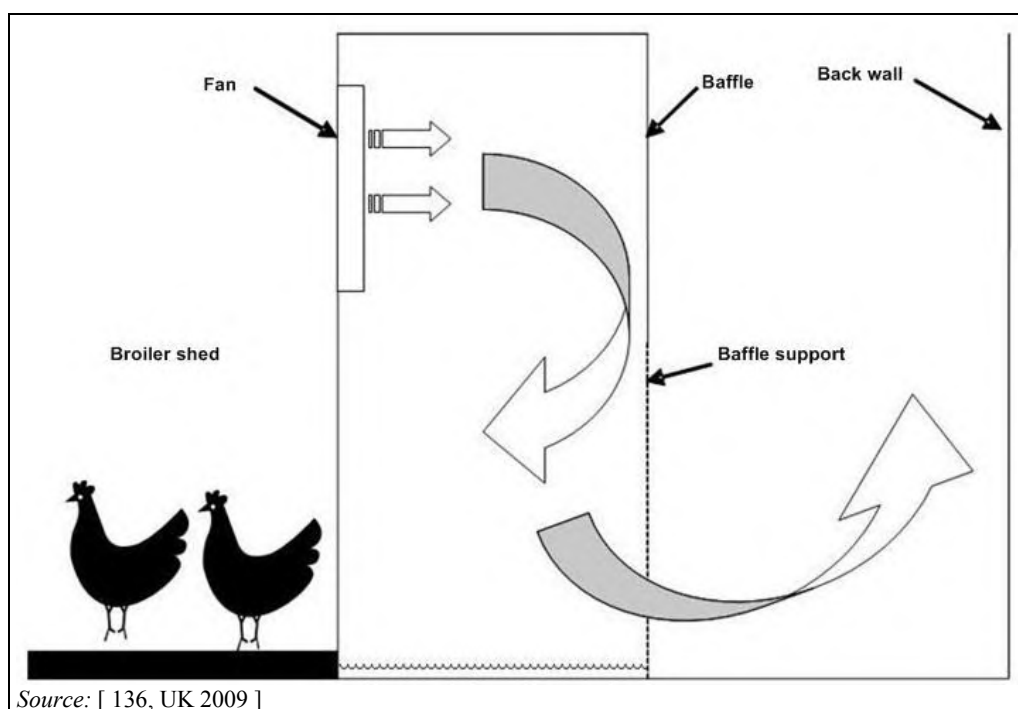

Figure 4.76: Scheme of the water trap

Achieved environmental benefits

Dust emissions are reduced.

Cross-media effects

None reported.

Environmental performance and operational data

Abatement of emissions has been reported for PM_{2.5} and PM₁₀ as 19 % and 22 %, respectively. Abatement of bacteria and fungi has also been reported to be equivalent to 16 % and 4 %, respectively, on a logarithmic scale. Water can be landspread.

Technical considerations relevant to applicability

The system can be retrofitted in poultry houses with a tunnel ventilation system.

Economics

No information provided.

Driving force for implementation

Local regulations may impose limit values for dust emissions.

Example plants

The technique is used in poultry farms in the UK. One example has been reported from a farm that rears more than 30 000 broilers.

Reference literature

[136, UK 2009]

4.10 Techniques for the reduction of odour emissions

Odours are indigenous to all livestock production operations. Odour mainly originates from the microbial conversion of feed (protein and fermentable carbohydrates) in the intestinal tract of pigs and by the microbial conversion of urinary and faecal compounds in the manure under anaerobic conditions. Odour is a complex mixture of many different compounds, such as sulphurous compounds (e.g. H₂S, mercaptans), indolic and phenolic compounds, volatile fatty acids (e.g. acetic acid, n-butyric acid), ammonia and volatile amines [511, Le et al. 2007] [270, France 2010].

Odour is the principal concern of local communities in relation to both pig and poultry farms. Odour arises from animal housing, as well as from manure transfer, storage, and spreading. The odours are diffused in gas form and/or are conveyed by dust.

The level of odour that arises from pig or poultry farms varies significantly and the degree of nuisance of a particular odour level varies according to location and context [204, IMPEL 2009]. Small volumes of very strong odours can, under unfavourable circumstances, travel far and cause a strong odour intensity to be perceived by persons downwind. As this perception can be of a high intensity, this can trigger annoyance and exacerbate nuisance [668, IE EPA 2001].

4.10.1 General measures for odour prevention

Odour can be reduced in a number of other ways, including:

- by good housekeeping;
- by storing the manure outside under a cover;
- by preventing an airstream from passing over the manure;
- by keeping straw-based manure under aerobic conditions in order to rapidly break down the odorous substances.

For reasons relating to odour, application times and techniques have been developed for landspreading. Some additional techniques to reduce odour in the vicinity of the farm are applied on farm to animal houses with forced ventilation. These include:

- horizontal air outlet channel, which does not mean a reduction of odour, but which diverts the emission point of air from the housing to a different side of the farm, so as to reduce the potential impact for odour-sensitive receptors (e.g. residential areas);
- dilution of the concentration, which is explained below and is based on the proper design of the housing and dimensioning of the ventilation.

4.10.1.1 Dilution of odorants

The odorant concentration depends, essentially, on the degree of dilution of the odorants emitted during atmospheric transport in the airstream. Important factors affecting pollutant concentration are:

- the odorant flow rate;
- the distance from the source;
- the effective source height and relative elevation of the source and the receptor;
- atmospheric conditions, local topography and features (surface roughness).

In addition, atmospheric dilution increases with the degree of turbulence in the atmosphere and the airstream. Mechanical turbulence can be achieved through the effective placement of flow barriers (e.g. vegetation).

The interaction of the above factors and the share of each one will finally determine the odour dilution. In many cases, distancing the source from the receptor is the only meaningful way to dilute odorants since the alternative measures described in this section may entail restrictions and disadvantages (e.g. outlet height, exhaust speed). Using standard distances for new farms in land use planning is a good practice [204, IMPEL 2009].

In many MS, in order to protect residents against significant odour nuisance, minimum distance regulations for the assessment of odour and the spatial separation of farms and dwellings or residential areas have been established, for instance in Germany by the Association of German Engineers (VDI; Guideline VDI 3894/2 'Emissions from and impacts of livestock operations - Method to determine separation distances – Odour', 2012-11). In Germany, odour impacts are assessed as significant and legally not allowed if a frequency of odour perception of 10 % (general residential areas) or 15 % (village areas) of the time is exceeded for an odour concentration of $1 \text{ ou}_E/\text{m}^3$ [590, Batfarm 2013].

In the Netherlands, the regulatory system is also based on the principle that the odour loads on surrounding areas of livestock operations are predicted by a standardised odour dispersion model. This model (V-Stacks), modified from the national Gaussian plume model, calculates 98th percentile values for the surrounding residential homes, and makes use of nationally standardised odour emission values. In the case of permitting procedures for livestock operations (new or modified farms), the odour load is calculated for the applied new situation and the calculated percentile values are checked to ensure that they do not exceed the allowed maximum percentile values in specific residential areas. Default maximum odour loads are nationally defined by the Ministry of Environment for different types of residential areas. Municipalities are allowed to deviate from this default value and to define, within a preset range, their own local standard. The model input is based on a regulatory national list with odour emission factors for the different animal categories and their housing systems expressed as $\text{ou}_E/\text{s}/\text{animal}$ [153, Netherlands 2010].

4.10.1.2 Discharge conditions

The principles of natural ventilation and forced ventilation result in different waste air discharge conditions. While the exit apertures for the housing air are limited to a narrow cross section in the case of forced ventilated housing, with naturally ventilated housing, they are occasionally quite large. In those housing systems, the cross sections through which air enters and exits are adjustable in accordance with the meteorological and local climatic conditions outside the housing, and with the livestock-specific ventilation requirements inside the housing. Common to both systems are thermal upcurrents in the housing caused by the heat output of the livestock and the possible presence of heating equipment.

Essentially, an unimpeded incoming and outgoing flow of outside air must be ensured in the immediate vicinity of the housing (approximately three to five times the building height). With forced ventilation, the use of the area in the immediate vicinity of the housing determines the discharge conditions to be selected, e.g. side wall ventilation leading into the yard, or high discharge stacks above the ridge. In the case of naturally ventilated housing, a local odour may be regarded as acceptable, where the emphasis is predominantly on the effect of the housing emissions further afield.

Forced ventilation

As a rule, with forced ventilated housing the focus in terms of impact reduction is on achieving sufficient dilution of the waste air by the wind. In order to protect the local neighbourhood, it may be generally advisable to ensure that the emission airstreams pass at a certain minimum

height over and beyond local dwellings by raising the source height, so that entrainment of the waste air plume in the wake zone of the building (downwash effect) can be kept to a minimum. This effect can be achieved by increasing the waste air exit velocity and/or raising the height of the waste air discharge stack.

The exhaust air should be discharged through sufficiently high stacks vertically upwards above the roof level without any flow-inhibiting hoods or covers. To this end, the local area and the farm/plant location should be examined to determine whether, for example, the exhaust air discharge stack could be raised to a higher level at the gable of a barn building for example where this barn towers over the livestock building.

The waste air plume can be given a further upward boost by imparting to it greater mechanical momentum by increasing the waste air discharge velocity. The waste air velocity can, for example, be increased upon necessity, e.g. by gang-switching multiple series of fans in a main central air duct.

The installation of an additional bypass fan is effective as an impact-reducing measure only in certain cases and for the local area, and usually tends to have no effect. Apart from the increase in investment outlay and energy consumption, the additional noise emissions also have to be taken into account.

When planning a waste air discharge system, it is important to consider the influences of livestock buildings and flow barriers in the immediate environment on both the windward and lee sides of the facility (e.g. the roof ridge of neighbouring buildings, and trees). Livestock buildings and flow barriers give rise to a plume downwash effect.

In the case of a single livestock building, the downwash effect depends on the relationship between the effective source height and the building height. The downwash effect describes the influence of the building on the waste air plume and the subsequent reduction in the effective source height. Undisturbed airflow is attained at a height which corresponds to twice the building height.

Side wall ventilation apertures may be regarded as desirable in individual cases if they are provided with a deflector cover which directs the waste air towards the ground, and if the air is dispersed on the housing side which faces away from the sensitive receptor requiring protection. When comparing the effects caused by side wall ventilation on the one hand and exhaust air discharge via the ridge on the other, the air pollution encountered in locations further afield tends to be similar.

In the case of facilities with several livestock buildings, the position and height of the waste air sources play a subordinate role in relation to their impact in terms of air pollution at remote locations. In such cases, the total area of the facility may be so large that the waste air plumes descend to ground level within the facility site, even if the original source heights are large. The overall facility is then considered to have the same effect as a single ground-level surface source.

With a different approach, forced ventilation has the advantage of allowing the easy implementation of air cleaning techniques.

Natural ventilation

In order to ensure sufficient functional efficiency with natural ventilation, certain requirements have to be met, for example the following:

- roof pitch angle of at least 20 ° for eaves-ridge ventilation in order to generate the necessary thermal upcurrent;
- mean height difference of at least 3 metres between the inlet air apertures and the waste air apertures with shaft ventilation;
- dimensioning of the air inlet and waste air apertures in accordance with the livestock occupancy and thermal upcurrent lift height;
- guaranteed disturbance-free flows of incoming fresh air and outgoing waste air into and from the housing;
- ridge axis aligned transverse to the prevailing wind direction for new plants.

If buildings are located upstream and/or downstream of an open housing system, it must be ensured that the livestock building is not located in zones with very low or significantly accelerated air movement. The distance from the housing to the neighbouring buildings should be at least three to five times the height of the neighbouring buildings.

In the case of pig and poultry housing systems, the installation of devices for changing the air inlet and waste air aperture cross sections has proven to be successful.

By aligning a new livestock building in relation to the prevailing wind direction, a decisive influence can be exerted on both the internal environmental conditions of the housing and the emissions emanating from it. Different concentration and velocity fields occur, depending on whether the housing is subjected to transverse, diagonal or ridge-parallel through-flow. With ridge-parallel flow patterns in particular, the degree of ventilation compared with cross-flow patterns is reduced by approximately 50 %. It is under these conditions that the highest odorant and ammonia concentrations arise in the housing.

In order to combat this effect, apertures in the gable wall can enhance the wind-induced volume flow. Apertures at the centre of the ridge additionally assist thermal upcurrent flow. With a slot aperture running along the entire ridge, higher throughput rates are achieved than with shafts. The ridge axis of the housing should therefore be aligned to the wind so that in the course of the year the prevailing direction of wind flow produces the best possible through-ventilation effect.

The air inlet and waste air apertures of housing systems with eaves-ridge ventilation have to be dimensioned so that in times of high outdoor temperatures there is still sufficient air circulation. Otherwise, doors must be opened, which generally results in the emissions dispersing at the ground level and in an uncontrolled fashion.

Housing systems of an open design with large lateral cross sections, ridge slots and gable-end apertures, located in a free-standing position, can be regarded as desirable in terms of the impact effects encountered further afield (e.g. box stalls with separate functional areas).

4.10.1.3 Dietary effects

Dietary protein is a precursor of odour production in the intestines of animals and in manure as the excretion of protein and its metabolites (e.g. urea) in the excreta of pigs provides substrates for bacteria to generate odour; thus, it is logically expected that odour emissions can be reduced as the dietary crude protein level decreases.

On the other hand, it is also reported that there is no significant influence of feeding strategies on odour emissions, although the odour quality may change [513, Mol and Ogink 2002]. Other trials on the effect of reduced protein levels in the diet found no difference at all when a relatively low-protein diet was already used [330, Denmark 2010] [326, Germany 2010].

Some experiment results reported a decrease in odour concentration and emission from pig manure, when dietary crude protein was reduced (by nearly 80 % by reducing the crude protein from 18 % to 12 % and supplementing essential amino acids [511, Le et al. 2007]). This reduction was relevant for specific odorous substances (idolic, phenolic and sulphurous compounds). Other results show that the composition and the quality of odour are influenced by the protein level supplied in the diet, while the odour concentration hardly reacts [512, Andree et al. 2003].

Also, fermentable NSP (non-starch polysaccharides) are important dietary components that determine the concentration of volatile fatty acids in the manure and, consequently, have an influence on odour emissions [513, Mol and Ogink 2002]. It is suggested that odour emissions can be reduced by decreasing protein fermentation through an optimum balance between available protein and fermentable carbohydrates in the large intestine [448, Aarnink et al. 2007].

Odour strength and offensiveness are measured by olfactometry and results are not always clear as it is difficult to assess odours objectively [512, Andree et al. 2003] [590, Batfarm 2013]. This might explain the difference in reported effects of dietary modifications on odour emissions. As a concluding remark for the relationship between nutrition and odour emission, more research is needed but it seems that there is great potential for environmental benefits [324, Netherlands 2010].

4.10.1.4 Air cleaning systems

Local conditions may be decisive for the adoption of abatement techniques, as is the case of densely populated areas in the Netherlands. The applicability, cross-media effects and costs might generally limit the adoption of the techniques given below or, alternatively, the positive effect on odour abatement in addition to the ammonia emission reduction may encourage their implementation.

Once the air can be ducted to a central point for treatment, there are a number of options for reducing the odour concentration in the exhaust air. A number of options have been listed here:

- Bioscrubber, see Section 4.9.3.
- Biodegradation, by leading the air from the housing through a biofilter of fibrous plant material, odorous elements are broken down by bacteria. The effectiveness depends on moisture content, composition, airflow per square metre of filter bed, and filter height. In particular, dust can be a problem, creating high air resistances (see Section 4.9.5).
- Two-stage or three-stage air cleaning system, see Section 4.9.6.

4.10.1.5 Odour management plan

Description

An odour management plan is compatible with the concept of the environmental management system (EMS) approach as described in Section 4.2. The odour management plan can be a part of the EMS of the farm.

As odour arises from different operational areas, it is good practice for the odour management plan to include all potential sources of odour in the farm operations (housing, manure storage and spreading) and to seek to control them in an integrated way [204, IMPEL 2009].

An odour management plan includes the following elements:

- a protocol containing appropriate actions and timelines;
- a protocol for conducting odour monitoring;
- a protocol for response to identified odour nuisance;
- an odour prevention and elimination programme designed, for example, to identify the source(s), to monitor odour emissions (see Section 4.18.4), to characterise the contributions of the sources and to implement elimination and/or reduction measures;
- a review of historical odour incidents and remedies and the dissemination of odour incident knowledge.

Some MS, such as the UK, implement an odour management plan when there is an issue with odour from the site, as a first step in reducing odour emissions [624, IRPP TWG 2013]. The approved odour management plan may be made available to the public.

Achieved environmental benefits

The minimisation of odorous emissions is the achieved environmental benefit. Many of the management techniques to reduce odour will also simultaneously reduce other emissions to air, including ammonia.

Cross-media effects

There are no cross-media effects associated with the implementation of this technique.

Environmental performance and operational data

No information provided.

Technical considerations relevant to applicability

The technique is applicable to new and existing farms provided that an odour nuisance at sensitive receptors is expected and/or has been substantiated.

Economics

No information provided.

Driving force for implementation

Management systems are likely to be less of a cost burden, or may even improve financial returns for producers, as they often imply lower capital costs and lower resource (energy, water, chemicals etc.) usage than end-of-pipe treatments.

Example plants

No information provided.

Reference literature

[19, Environment Agency (England and Wales) 2011] [204, IMPEL 2009] [624, IRPP TWG 2013]

4.10.2 Good operational practice in pig housing

Sources of odour in and around buildings and practices to reduce odour emissions in pig housing include the following:

- **Cleanliness:** It is good operational practice to keep the pigs and the surfaces in and around buildings clean. Pigs with manure on their skin will have a significantly increased odour emission, as the body heat of the animal will accelerate the release of odours significantly. In addition, reducing the exposed area of manure and avoiding spilled feed induce a direct reduction in odour emissions.
- **Dryness:** Optimum control of the housing environment, particularly during summer, can contribute to ensuring that pigs excrete in the dunging area while the lying and activity area remain clean and dry. Drinking water losses should be avoided by employing low-loss drinking equipment. For litter-based systems, the level of odour emissions decreases as the quantity of litter per livestock unit increases.
- **Slurry removal:** In liquid manure systems, the odour emissions from the houses can be reduced if the dung and urine are removed from the housing at short intervals or in a continuous process. Long residence times in a manure storage pit and large storage volumes increase the emissions of odourants. As a general principle, pig manure has to be removed to adequate storage pits or be subjected to an appropriate treatment, including landspreading, as quickly as practicable, e.g. by shallow channels with a flushing system for rapid discharge.

It is generally considered that most techniques described in the previous sections which are mostly intended for abating ammonia and dust emissions can have a reducing effect on odour emissions. However, a research programme carried out in the Netherlands [[513, Mol and Ogink 2002](#)] [[153, Netherlands 2010](#)] showed that odour emissions from livestock operations were highly variable both within individual farms (in time) and between farms. Measured differences reflect to a major extent uncontrolled management effects. Even when corrected for the significant effect of the ventilation rate, it was difficult to make significant distinctions between the various systems. The major conclusions were:

- ammonia-reducing housing systems do not necessarily reduce odour emission;
- this effect is not consistent throughout all animal categories, depending on the characteristics of their odour emissions;
- small significant differences between conventional and low-ammonia-emission housing systems were proved only for fattening pigs.

In some circumstances, such as housing systems for pigs with frequent removal of manure by flushing gutters underneath the slats, ammonia emissions can be significantly reduced, while odour emissions may be high, with levels during flushing events 3 to 3.5 times higher than those from other housing systems. Various other factors, like farm hygiene, type and feeding regime, and water to feed ratio, have a significant influence on odour emissions from livestock buildings and can conceal the emission-reducing effects of the housing systems [[513, Mol and Ogink 2002](#)].

A measurement research campaign in the Netherlands, aiming to minimise the effects of management factors, showed that on three of the five tested farms statistically significant differences between the conventional housing system (partly slatted floor) and an ammonia-reducing housing system (restricted emission surface or a manure-cooling system) were only found for weaners and fattening pigs. The average odour reduction percentages for these systems were 35 % (restricted emission surface) and 23 % (manure cooling) respectively [[153, Netherlands 2010](#)].

In general, with regard to odorant emissions per unit of live animal mass, generally only small differences between the different housing techniques have been proven [474, VDI 2011].

The main principles utilised by low-ammonia-emission housing systems for reducing emissions to air from pig housing are:

- limiting the exposed area of stored manure;
- frequent removal of manure by a sewerage system, flushing or scraping;
- cooling manure, lowering the temperature of stored manure;
- faster discharge of the manure from slats, by using triangular iron bars, which are easily cleaned;
- decreasing the temperature of the indoor environment, the airflow and velocity over the manure surface while maintaining an acceptable living environment for the animals;
- keeping the litter dry and under aerobic conditions in litter-based systems.

Further details on specific housing systems for pig housing and on their associated odour emissions can be found in Section 4.7.

4.10.3 Good operational practice in poultry housing

Odour from broiler housing is reported to increase in offensiveness with the moisture content of the litter.

Sources of odour in and around buildings and practices to reduce odour emissions in poultry housing include the following:

- Cleanliness and dryness: Drinking water losses should be avoided by employing low-loss drinking equipment (e.g. nipple drinkers). The level of odorant emissions decreases as the quantity of litter per livestock unit increases.
- Manure removal: In liquid manure systems, the odorant emissions from the housing can be reduced if the manure is removed from the housing at short intervals or in a continuous process. Long residence times in a manure storage pit and large storage volumes increase the emissions of odorants. As a general principle, manure must be removed to adequate storage pits or be subjected to an appropriate treatment, including landspreading, as quickly as practicable.

A Dutch research programme did not show consistent differences in odour emissions between conventional housing systems and those designed for low ammonia emission (e.g. with drying of the manure collected on belts) in each specified poultry category. The assigned odour emission value was based on all available measurements. For air scrubbers, the observed mean removal percentage of chemical scrubbers (30 %) was included for the different poultry categories [153, Netherlands 2010].

4.10.4 Slurry storage

Slurry storage can be a highly significant source in terms of odour annoyance potential. Under anaerobic conditions, high concentrations of odorants can be formed in slurry, which can be released in highly concentrated ‘puffs’ when slurry is being handled. Turbulence, resulting from stirring and pumping, can increase the emissions from the surface by an order of magnitude (factor 10) compared to a still surface. In assessing the relevance of slurry storage for odour

annoyance potential, it helps to realise that odour concentrations over slurry, or in headspaces, can reach tens or even hundreds of thousands of ou_E/m^3 , whereas the odour concentration in pig house ventilation air rarely exceeds $5\,000\ \text{ou}_E/\text{m}^3$ [668, IE EPA 2001].

The techniques for storage having a significant effect on odour emissions are (see Section 4.11):

- covering of slurry or solid manure during storage;
- location of the store taking into account the general wind direction and/or adopt measures to reduce the wind speed around and above the store (e.g. trees, natural barriers);
- minimisation of the stirring of slurry.

4.10.5 Manure processing

The techniques for manure (solid or slurry) processing having a significant effect on odour emissions are (see Section 4.12):

- aerobic digestion (aeration) of liquid manure/slurry;
- composting of solid manure;
- anaerobic digestion.

4.10.6 Landspreading

The techniques for landspreading having a significant effect on odour emissions are (see Section 4.13):

- use of a band spreader, shallow injector or deep injector for landspreading of slurry;
- incorporation of manure as soon as possible.

4.11 Techniques for the reduction of emissions from manure storage

The Nitrates Directive (91/676/EEC) lays down minimum provisions on manure storage in general with the aim of providing all waters with a general level of protection against pollution, and additional provisions on storage in designated Nitrate Vulnerable Zones. As a general rule, it is essential to take national and/or regional regulations concerning the avoidance of water pollution into account when designing and locating manure stores. Techniques for reducing emissions from manure storage are described in the sections below.

4.11.1 Reduction of emissions from storage of solid manure

This section refers to techniques to reduce emissions to air, soil and water from the storage of solid manure. These techniques are also applied to the solid fraction from the mechanical separation of slurry (see Section 4.12.2).

4.11.1.1 General practice for the batch storage of solid manure in the field

Description

The storage of solid manure after removal from livestock housing can be carried out in heaps (or stacks) in the field in separate batches before landspreading.

In temporary heaps in the field, solid manure is stacked directly on the soil over a limited period of time prior to landspreading (e.g. for a few days or for several weeks, such as in the UK where storage in separate batches before landspreading lasts for at least 90 days). An adequate separation distance between field heaps and surface and/or underground watercourses such as drains, boreholes, wells, surface waters and springs reduces the risk of any leachate from a heap running over the soil surface directly into a watercourse or flowing through the soil and transporting nutrients, faecal indicator organisms and oxygen-depleting pollutants to watercourses.

Temporary field heaps should be located at different places each year; this procedure is mandatory in some Member States, e.g. France. Where clay soils prevail and heaps change location, no accumulation of harmful amounts of nutrients is expected and special measures do not need to be applied to the bottom of the heap. To prevent water from entering the manure heap, the accumulation of rainwater at the base of the heap needs to be avoided.

For field heaps that are made in the same place every year or for stockpiles located on soils with high water tables, solid impermeable floors are applied for the storage of solid manure to prevent water and soil pollution by leaching. Equipping the store with drains and/or applying a convenient slope on the floor and connecting the drains with a closed container allow the collection of liquid fractions and of any run-off caused by rainfall. For impermeable floors made of concrete with leachate collection facilities, further information is presented in Section 4.11.1.4.

Storage areas away from sensitive receptors are preferred, and any advantage that can be taken of natural barriers, such as trees or height differences, should be exploited. Walls (wood, bricks or concrete) can also be erected to surround storage heaps. These can serve as windscreens, with the opening of the storage on the lee side of the prevailing wind direction.

The smaller the ratio between the emitting surface area and the volume of the manure heap, the lower the ammonia and odour emissions. In order to reduce the manure surface exposed to air, manure can be compacted or a three-sided wall store can be constructed to increase the height.

Compacting solid manure when stored is a management option for reducing ammonia emissions to air. The high density achieved by compaction reduces the air transfer in the heap so that self-heating (i.e. passive composting) can be avoided. A high density may be also a consequence of a high water content and of a low content of bedding material like straw or wood chips [441, Webb et al. 2011]. The air exchange in combination with the elevated heap temperature due to aerobic decomposition will promote losses of ammoniacal nitrogen [517, Petersen et al. 2011].

Achieved environmental benefits

Siting temporary solid manure field heaps as far as possible from surface and/or underground watercourses reduces risks of pollution of soil and water by surface run-off. Benefits are likely to be greatest on medium/heavy soils where surface run-off risks are highest and field drains are likely to be present. The direct loss of pollutants in surface run-off and drain flow is prevented if the storage of solid manure takes place on an impermeable base with leachate collection.

Microbial pathogen emissions during landspreading are reduced compared with fresh manure applications (i.e. immediately after removal from housing). Reducing the ratio between the emitting surface area and the volume of the manure heap can reduce ammonia losses to air.

Cross-media effects

If the heaps are uncovered or not covered completely or compacted to reduce air transfer, then composting (self-heating) may occur. In this case, ammonia emissions will increase with the increasing heap temperature [590, Batfarm 2013] [441, Webb et al. 2012].

Nitrous oxide emissions may rise when increasing the manure density, due to the stimulation of nitrification and heterotrophic denitrification by an increased number and volume of sites with relatively low oxygen availability [517, Petersen et al. 2011] [441, Webb et al. 2012].

Environmental performance and operational data

In Finland, the heap must be at least 100 m from watercourses, main ditches, or from a well from which water is drawn for household use, and 5 m from (small) ditches [624, IRPP TWG 2013]. In the UK, the applied distances are 10 m from watercourses and 50 m from springs, wells, boreholes or other sources of water intended for human consumption [506, TWG ILF BREF 2001]. In France, the minimum distance from watercourses is reported to be 100 m [500, IRPP TWG 2011]. In Belgium (Wallonia), the dry farmyard manure has to be stored at least 20 m from any drain, well or surface water. In Ireland, the national legislation implementing the Nitrates Directive demands the heap to be placed within 250 m of an abstraction point, 50 m of any borehole, spring or well used for abstraction of water for human consumption, 20 m of a lake, 50 m of exposed cavernous or karst limestone features, 10 m of any surface water. In Italy, temporary manure storage is not permitted within a distance of 5 m from drains, 30 m from river sides, and 40 m from the bank of lakes, as well as from the coastline [624, IRPP TWG 2013].

Additional requirements in Member States for temporary field heaps are presented in Table 2.20. Microbial pathogen numbers decline during solid manure storage, with the rate of decline accelerated if self-heating (i.e. passive composting) occurs in the heap; this happens naturally in most FYM and poultry litter heaps. Hence, there are fewer microbial pathogens in the manure when it is spread and therefore less risk of microbial pathogens in surface run-off and drain flow. Storage is effective at reducing bacterial numbers, but is less effective at reducing populations of the protozoan parasite *Cryptosporidium* [648, DEFRA 2011].

The effect of temperature in solid manure heaps is significant and is related to the porosity, air permeability and water content of the heap because temperature is related to aerobic microbial activity. The heap temperature declines with an increasing heap density [590, Batfarm 2013].

On the basis of experimental data, the following algorithms have been proposed to calculate ammonia emission factors in relation to the heap density: $F(D) = 6.5 - 7.6 \cdot D$. $F(D)$ is an

ammonia emission factor given as \ln (% of TAN) in manure and D is the heap density in kg/m^3 . The algorithm reflects that the NH_3 emission declines exponentially with an increasing heap density [441, Webb et al. 2012].

Technical considerations relevant to applicability

The storage of solid manure on an impermeable base equipped with a drainage system and a collection tank for the run-off is generally applicable. The storage of solid manure in field heaps placed away from surface and/or underground watercourses is only applicable to temporary field heaps which change location each year.

Economics

Costs based on the construction of a concrete floor and leachate collection facilities and the associated areas for vehicle movements (amortised over 20 years) in the UK are reported as EUR 1.15/tonne of solid manure (EUR 1 = GBP 0.87).

Driving force for implementation

Where field heaps can be used for batch storage prior to landspreading, siting solid manure field heaps away from watercourses and field drains is simple to implement.

Example plants

The techniques for solid manure storage in heaps in the field are commonly applied.

Reference literature

[441, Webb et al. 2012] [500, IRPP TWG 2011] [506, TWG ILF BREF 2001] [517, Petersen et al. 2011] [590, Batfarm 2013] [624, IRPP TWG 2013] [648, DEFRA 2011]

4.11.1.2 Application of a covering to solid manure heaps

Description

Covering materials are applied to solid manure heaps in the field or manure stores. These can be peat, sawdust, wood chips or a tight UV-stabilised plastic cover. The purpose of the cover is to provide a physical barrier reducing the release of ammonia from the manure heap to the air and preventing the run-off of rainwater. Air exchange and microbial activity (self-heating) in the manure heap decrease, resulting in a reduction of emissions to air. Covering the heaps tightly will most probably stop air from being exchanged between the heaps and surrounding air and NH_3 emission from heaps may be assumed to be negligible [590, Batfarm 2013] [441, Webb et al. 2012]. This technique mainly applies to broiler manure and dried layer droppings but could be applied to all solid manures in outdoor stores.

Manure heaps are often covered with 500–1 000 gauge plastic sheeting (1 gauge = 0.0254 mm) [205, ADAS 2000]. Geotextile covers let gases flow from the mass below while being waterproof but are relatively expensive. Other types of covers on the market are those used for silage and weaved covering [259, France 2010], or membrane-covered enclosed systems [624, IRPP TWG 2013].

If a cover is to be applied, heaps must be covered as soon as possible after they are made, since most of the ammonia evaporates during the first few days. Applying the covers is relatively easy, as no complex equipment or machinery is involved. Long, low field heaps would require large amounts of sheeting for covering; so heaps should be shaped to minimise their overall surface area [648, DEFRA 2011].

The principle behind the application of peat was reported by Finland [26, Finland 2001]. The use of peat (as a 10 cm layer) is based on its ability to bind cations. Ammonia is absorbed into the peat in a chemical reaction in which the NH_3 molecule is transformed into a fixed NH_4 ion. The higher the acidity of the peat, the more ammonia it can absorb. The peat-littered manure of

broilers is very suitable for depositing in heaps on the field, because liquid does not seep from it and nearly all rainwater is absorbed in the heap. Peat used as litter absorbs ammonia effectively.

Achieved environmental benefits

Benefits include the reduction of ammonia and odour emissions, as well as the prevention/reduction of leaching due to rainwater.

Cross-media effects

Peat is a non-renewable resource whose extraction is associated with high CO₂ emissions; the environmental benefit of its use for manure heaps is debated [506, TWG ILF BREF 2001].

Environmental performance and operational data

Ammonia emissions from covered heaps of solid manure are estimated to be reduced by up to 50 % compared to uncovered heaps [227, Denmark 2010].

In the UK, experimental studies have shown a wide range of reduction efficiencies by covering solid manure heaps with an impermeable sheet (from 14 % to 89 %), with an average ammonia emissions reduction value of 65 %. The reported values are associated with conditions where the manure heap is created, sheeted and left undisturbed. This condition might apply to broiler farms, where the sheds are cleared and the manure is stored and left undisturbed until the end of the next crop cycle, or to laying hen farms where manure from deep pit housing is cleared from the shed and stored. Where frequent additions to the heap are performed, for instance at farms with a weekly manure removal by belts, and the sheeting has to be removed and replaced, the evidence suggests that there is no significant reduction of ammonia emissions when compared to a conventional manure heap without a cover. The same effect is also reported where polyethylene covers were damaged by high winds and, even though they were replaced within 24 hours, there was no difference in ammonia losses from covered and uncovered stores. These cases should therefore be treated as an uncovered store [500, IRPP TWG 2011].

Comparing different types of poultry manure, experiment results showed that ammonia emissions were highest during the first 100 days of storage (uncovered or covered), while the heap covers reduced ammonia emissions by 33 % for broiler litter, 52 % for laying hen manure from a deep pit, and 74 % for laying hen manure removed by belts. These differences in ammonia emissions reduction reflect the higher available ammoniacal nitrogen content and higher temperatures measured during storage of the broiler litter and laying hen manure from a deep pit, compared with the laying hen manure removed by belts, which favour ammonia volatilisation during the early storage period [205, ADAS 2000].

Data concerning ammonia emissions from covered and uncovered poultry manure heaps are reported in Table 4.156.

Table 4.156: Ammonia emissions from covered and uncovered poultry manure heaps

Parameters		Broiler litter	Manure from laying hens, with a deep pit	Manure from laying hens, with removal belts
		Ammonia emissions (g NH ₃ /m ² ground surface area)		
Losses during first 100 days of storage	Uncovered	169	110	116
	Covered ⁽¹⁾	113	53	30
	Reduction	33 %	52 %	74 %
Total losses for a 350-day storage period ⁽²⁾	Uncovered	271	192	159
	Covered ⁽¹⁾	245	156	56
	Reduction	10 %	19 %	65 %

⁽¹⁾ Covered with 1 000 gauge polythene sheeting.
⁽²⁾ Including emissions from heap disturbance.
Source: [205, ADAS 2000]

Data concerning nitrogen losses as a percentage of the total nitrogen content in solid manure (ex-housing), stored for more than 100 days, with or without a cover, are presented in Table 4.157. Values reported are the result of large-scale field experiments carried out under different climatic conditions in northern Europe.

Table 4.157: Nitrogen losses from covered and uncovered solid manure heaps

Manure type	Type of storage	Nitrogen losses (% of total N (ex-housing))		
		N-NH ₃	N denitrification (¹)	Total N losses
Pigs (FYM or litter)	Uncovered	25	15	40
	Covered	13	15	28
Laying hens (FYM or litter)	Uncovered	10	10	20
	Covered	5	10	15
Broilers, ducks and turkeys (litter)	Uncovered	15	10	25
	Covered	8	10	18
(¹) Estimated values. Source: [442, Hansen et al. 2008]				

Covers also reduce leachate, in volume and content (N, P, K) [205, ADAS 2000]. Total N and NH₄-N leachate losses were equivalent to about 0.5 % and 0.25 % of total N and NH₄-N inputs to the uncovered heaps, and were less than 0.1 % of total N and NH₄-N inputs to the covered heaps, respectively. Total P and K losses were equivalent to 0.2–0.3 % and 2–3 % of total P and K inputs to the poultry manure heaps. At the same time, the covers were very effective in reducing leachate production, as the mean volume of leachate from the covered heaps was 85 % lower than from the uncovered heaps. No significant effect of heap covering on ammonia losses during landspreading was reported [205, ADAS 2000].

The results of a Danish study show that the application of an airtight cover to prevent composting during the storage of slurry fibre fractions results in a reduction of NH₃, N₂O, and CH₄ emissions by 12 %, 99 % and 88 %, respectively. During a 120-day storage period without a cover, 4.8 % of the total nitrogen was lost as N₂O, while only 0.04 % was lost when using a cover. Nitrification activity is a precondition for N₂O emissions, which may explain the mitigation potential of an airtight cover [526, Hansen et al. 2006].

Nitrous oxide emissions from broiler litter were found to range from 0.55 % to 0.70 % of the total N of the manure stored in a sheeted heap, while, for the conventionally stored litter (uncovered), the values ranged from 0.17 % to 0.81 % [250, IGER 2004]. The effects on the balance of N₂O emissions at the farm scale are uncertain [648, DEFRA 2011].

Dry peat and sawdust absorb rainwater. Straw is not a good covering material because it does not absorb ammonia and it also prevents a natural crust from forming on the surface of the manure. A crust prevents the volatilisation of ammonia from the fresh surface of the manure under it better than a covering of straw does. It is clear that tight covers can be reused if properly applied, whereas other covering materials will need to be purchased for each new heap. These other covering materials, such as peat, will be incorporated and then treated (applied) as part of the manure. Peat will not create a hazard for grazing animals.

Technical considerations relevant to applicability

The technique is generally applicable when solid manure is dried or pre-dried in animal housing. A sheet covering may not be appropriate for undried solid manure management systems that involve the regular additions of material to existing manure heaps (e.g. daily, twice weekly), as there would be a continual need for sheet removal and replacement.

Economics

Reported costs of covers (tax included) from France are EUR 1.45–2.45/m² for geotextile cover, EUR 0.95–1.10/m² for weaved cover, and EUR 0.17–0.24/m² for cover for silage [259, France 2010].

In the UK, costs for the provision of sheeting are estimated as EUR 0.57/tonne of solid manure (EUR 1 = GBP 0.87) [648, DEFRA 2011]. Calculations have shown that the covering of solid manure heaps is economically profitable, as the cost of the covering material is lower than the value of the amount of nitrogen retained in the manure [499, AgroTech 2008]. Investment costs, related to a farm producing 17 500 fattening pigs per year, may reach EUR 5 per animal place, depending on the type of cover (ranging from a simple shelter cover to a closed manure shed).

Driving force for implementation

Covering manure stores (or heaps) reduces the total ammonia emissions of the production process, albeit by a smaller proportion compared to emissions from housing and/or manure landspreading which are much more significant; however, it is one of the easiest measures to monitor and control. Indeed, covers are important where stores are sited near residential areas or other sensitive receptors [337, Webb et al. 2005].

This technique is a less expensive alternative to silos, to enable on-field storage to protect ground or surface water from nutrient run-off or leaching. Sheeting may have the additional benefit of minimising contamination by flies.

Example plants

In France, the application of a covering to solid manure heaps is an obligation for poultry manure only. In the Netherlands, covering is mandatory for manure heaps situated in the field for more than 2 weeks. In the UK, it is mandatory to cover field heaps of laying hen manure with an impermeable sheet in NVZs. In the Netherlands and the UK, covers are used on solid manure heaps to prevent odour when there are homes near the heaps [641, IRPP IWG 2014]. In Denmark, covered storage of the solid fraction from the mechanical separation of slurry is mandatory.

Reference literature

[26, Finland 2001] [205, ADAS 2000] [227, Denmark 2010] [250, IGER 2004] [259, France 2010] [337, Webb et al. 2005] [441, Webb et al. 2012] [442, Hansen et al. 2008] [499, AgroTech 2008] [500, IRPP TWG 2011] [526, Hansen et al. 2006] [506, TWG ILF BREF 2001] [590, Batfarm 2013] [624, IRPP TWG 2013] [641, IRPP IWG 2014] [648, DEFRA 2011]

4.11.1.3 Storage of dried solid manure in a barn

Description

Dried solid manure is normally stored in a barn. It is removed from the animal housing by front-end loaders or by means of a belt, and transported to the shed, where it can be stored for a longer period of time without the risk of remoistening. The barn is usually a simple, straightforward closed construction with an impermeable floor and a roof. It is equipped with sufficient ventilation openings to avoid anaerobic conditions and condensation, and an access door for transport.

To keep emission of gaseous compounds low, the relatively high dry matter percentage of solid manure has to be maintained, e.g. remoistening of the droppings should be prevented as this will lead to a release of odorants. This is helped by keeping solid manure protected against outdoor influences such as rain and sunlight. Droppings storage sheds should not be built so high as to allow self-heating to occur in the stored droppings.

Achieved environmental benefits

Drying manure in the housing reduces the emissions to air of gaseous compounds (ammonia).

Cross-media effects

Odour levels may be kept low, but aerobic and anaerobic conditions can affect this. If a new barn is planned, it is a potential source of odour, so thought should be given to its location with respect to sensitive receptors in the vicinity of the farm. It is important to have sufficient ventilation to avoid anaerobic conditions. A monitor of the internal temperature of the manure pile is necessary, to prevent litter overheating and spontaneous autoignition (combustion).

Environmental performance and operational data

The manure is protected against the outdoor climate by the barn construction.

Technical considerations relevant to applicability

If sufficient space is available in the farmyard there are no limits to the construction of a new barn for the storage of solid manure. Existing barns may be used, but attention must be paid to the impermeability of the floor.

Economics

Costs are for the construction and maintenance of a barn. For an existing barn, renovation of the flooring may be needed.

Driving force for implementation

In cases where poultry manure is already dry (e.g. litter from broilers and laying hens, air-dried laying hen excreta collected on manure belts), a barn with an impermeable floor and sufficient ventilation will keep the manure dry and prevent remoistening, compared with any further long-term storage elsewhere [508, TFRN 2014]. With permanent storage structures, field heaps and, consequently, the associated pollution risks are also avoided or reduced.

Example plants

The storage of poultry manure in barns is applied in nearly all Member States.

Reference literature

[24, LNV 1994] [26, Finland 2001] [508, TFRN 2014]

4.11.1.4 Concrete silo for solid manure storage**Description**

This is a three-sided, rectangular or square structure with a concrete floor. The floor slopes towards the open side (e.g. gradient of 2 %) where a gutter collects seepage/drainage from the stacked manure that is stored separately in a concrete leak-tight pit underneath the storage platform. Elevated edges, supporting side walls or other constructional means, e.g. a perimeter channel, are necessary to make sure that liquid fractions can flow into the storage pit underneath and to prevent run-off from surrounding areas from entering the platform. Roofing over the storage platform helps to decrease the volume requirement of the storage pit. The reinforced concrete side walls allow manure stacking in a space-efficient way.

Achieved environmental benefits

Benefits include improved protection of the soil, surface and groundwater, by a complete control of leakages.

Cross-media effects

The liquid fraction collected in the pit has to be managed. It can be spread at a later date when soil conditions are suitable and the nutrients can be utilised by crops, or it may be readded to the heap or to a slurry store. In the case of pig manure storage, it is treated as slurry.

Environmental performance and operational data

In addition to proper planning and construction, in accordance with the relevant regulations, water protection is ensured by careful operation and, particularly, by proper maintenance of the facility. In Germany, the facility operator is required to run regular checks of the leakproofness of containers, pipes, etc. Leak testing (e.g. pressure tests) of underground pipes should be repeated approximately every 10–12 years. In areas with water protection legislation in place or in special cases, shorter testing intervals are required following the instructions of the competent authorities. Stores with an area of up to 2 000 m² can be built with manure stacked up to 5 metres high.

In order to store broiler manure for 4 months, from a building of 1 000 m² (150 tonnes of manure/year), a surface of between 48 m² and 80 m² is needed, depending on the height of the side walls and their number (three or four). A pig house of 550 places for fattening pigs, producing 1 tonne of manure/place per year (460 kg/m³ approximately), will need a 400 m² concrete platform with three walls of 1 metre high to store the manure for 4 months [259, France 2010].

Technical considerations relevant to applicability

No technical restrictions are reported for the implementation of the technique.

Economics

From Germany, the investment costs are reported to be in the range of EUR 65–77 per m³ of manure storage capacity, including the storage pit for drainage collection. The total annual costs are between EUR 5.8 and EUR 6.8 per m³ of storage capacity. Cost data related to the construction of a silo for the storage of solid pig manure are presented in Table 4.158.

Table 4.158: Cost data of a silo for the storage of solid pig manure

Parameters	Value	Remarks
Silo characteristics		
Storage capacity	1 100 m ³	For 2 000 pig places
Surface area	520 m ²	
Height of side walls	2 m	
Durability	30 years	
Manure density	0.8–0.9 t/m ³	
Cost data		
Investment costs	EUR 73/m ³ (EUR 65–77/m ³)	Additional pit with a volume of 1 000 m ³ for urine and seepage is included (EUR 3/m ³)
Total costs	EUR 6.4/m ³ /yr (EUR 5.8–6.8/m ³ /yr)	Including additional costs for a liquid manure pit for seepage/drainage collection (EUR 0.27/m ³ /yr)
Source [212, Germany 2010]		

Driving force for implementation

This technique is used to efficiently store solid manure in cases when a storage capacity over several months is legally required. Other driving forces are:

- manure management is easier and the volume of manure to be transported is reduced;
- the use of field heaps and associated pollution risks are also avoided or reduced.

Example plants

This technique is reportedly in use in Belgium (Flanders), Germany and in the UK.

Reference literature

[212, Germany 2010] [259, France 2010] [648, DEFRA 2011]

4.11.2 Reduction of emissions from the storage of slurry

4.11.2.1 General aspects

It is common practice for farmers to have storage facilities for pig slurry with a sufficient capacity to hold the slurry until further treatment or application is carried out (see also Section 2.6). The required capacity depends on the climate, and the duration of the periods in which landspreading is not possible. For example, the capacity can differ from the manure that is produced on a farm over a 4- to 5-month period in a Mediterranean climate to that produced over a 7- to 8-month period in Atlantic or continental conditions, and again to that produced over a 9- to 12-month period in boreal areas [537, COM 1999]. Specific examples, concerning procedures applied in different Member States, are presented in Table 2.15.

Not only should the store be of a sufficient size to avoid landspreading at times of the year when there is a risk of emission to water (e.g. through nitrate leaching) but it should also be adapted to allow landspreading at the ideal time with regard to the nitrogen demand of the crops. Slurry stores can be constructed in such a way that the risk of leakage of the liquid fraction can be minimised (see also Section 2.6.5.1 and Section 4.11.2.6). They are built using the appropriate concrete mixtures, and, in many cases, a lining is applied to the concrete tank wall or an impermeable layer to steel sheets. Bags, lined or unlined earth-banked lagoons, or GRP tanks are also used.

Ammonia emissions from liquid manure (slurry) mainly depend on the chemistry of the liquid ammonia dissolved in the transfer mechanism of gaseous ammonia at the manure surface. Various parameters have an influence on ammonia emissions from manure storage, among them: manure surface area, temperature, and wind speed [439, Sommer et al. 2006].

Emissions to air during the storage period can be reduced by applying the measures given below related to the design and management of the slurry store:

- Reducing the emitting surface area/volume (i.e. capacity) (SA/V) ratio of the storage. For example, the surface area of a 1 000 m³ slurry store can be reduced by 40 % if the height of the container is increased by 2 m, from 3 m to 5 m. The container then has a diameter of 16 m instead of 20.6 m. In order to enable mixing in circular stores, the height of the store should be at least one fourth to one third of its diameter [337, Webb et al. 2005]. For rectangular stores, the proportion of height to surface area should be 1: 30–50. On the other hand, an excessive height of the slurry store above the soil surface represents an added safety risk. Other cross-media effects are the higher consumption of energy due to increased pumping requirements, potential problems in the gravity flow of slurry from houses to the tank, construction costs for increased tank heights, and visual effects on the landscape [624, IRPP TWG 2013]. For uncovered tanks, the height of the store is recommended to be at least 3 m [508, TFRN 2014]. This technique may not be generally applicable to existing tanks.
- Operating a lower level of fill in uncovered stores to take advantage of the wind shielding effect created by the freeboard. As a result the wind velocity and air exchange on the slurry surface are reduced. When dimensioning the store, annual precipitation has to be taken into account in order to maintain a sufficiently high freeboard for safety [624, IRPP TWG 2013]. This technique may not be generally applicable to existing tanks.
- Emptying the stores in spring, before the onset of the warm season, so that the lowest possible slurry quantity is stored during summer. The stored slurry temperature in above-ground tanks follows the air temperature, and at higher temperatures gaseous emissions will increase. This procedure applies for above-ground tanks in regions where there is a significant temperature rise in the summer. The temperature of the slurry in underground storage tanks warms up at a slower rate.

- Frequently transferring slurry from a housing facility to an outdoor store. Since the temperature of the slurry tends to match the ambient temperature, this technique represents a relevant ammonia mitigation option in cool and temperate regions, whereas in warmer climates the effect may be limited or even negative [517, Petersen et al. 2011].
- Performing the discharge of liquid manure in open storage containers as close to the base of such containers as possible (infilling below the liquid surface level) without impairing the emission control effect of the crust or cover. Unnecessary homogenisation and circulation pumping of slurry should be avoided and should preferably be performed when the wind is blowing away from any sensitive sites requiring protection.
- Reducing the NH₃ volatilisation from the slurry surface. A low volatilisation rate can be maintained if the stirring of slurry is kept to a minimum and is done only before emptying the slurry tank for the homogenisation of the suspended matter.

Apart from the above general measures, the main abatement technique to reduce ammonia losses and odour emissions from slurry stores consists of covering open stores, therefore increasing the transport resistance from the manure surface (source of emission) to the atmosphere. A distinction is made between covers, as various types of covers can be applied. The main types are rigid covers, tent covers, floating covers, or a floating layer of straw or natural crust.

In particular, covers in the form of roofs of PVC, wood or similar materials that create an impermeable lid over the storage will reduce emissions. Porous floating surface material has also been shown to reduce NH₃ emissions, because it creates a stagnant air layer above the slurry, through which NH₃ has to be transported by the slow process of diffusion. This material may be porous textiles, a natural surface crust formed by solids floating on the surface, a cover of straw, peat or floating expanded clay particles. The lowest reductions occur when the surface is covered by a natural crust, the air temperature is low or the cover on the treated slurry is submerged. At low air temperatures, NH₃ emissions from stored uncovered slurry are low and emissions from covered storage are therefore not much lower than those from the reference system [590, Batfarm 2013].

An overview of the different types of covers applied in slurry storage is presented in Table 4.159, with an indication of their applicability to round containers and earth-banked lagoons.

Table 4.159: Overview of the different types of covers applied in slurry storage

General category	Type of cover	Applicability	
		Round container (concrete or steel)	Earth-banked lagoon
Rigid covers	Concrete covers	X	NA
	Fibreglass panels	X	NA
Flexible covers	Tent cover, dome-shaped or tended flat	X	NA
	Floating sheeting covers	X	X
	Air-inflated covers	X	X
Floating covers	Natural crust	X	X
	Straw (crust)	X	X
	Peat	X	X
	Light bulk material (e.g. LECA, perlite, zeolite)	X	X
	Plastic pellets (polystyrene balls)	X	NI
	Rapeseed oil	X	NI
	Plastic blankets and foil	X	X
Geometrical plastic tiles	X	X	
NB: NA = not applicable; NI = no information provided.			

Care must be taken to prevent the temperature of the slurry from rising to a point at which biochemical reactions can occur, otherwise these may result in unwanted odorant production and a degradation of the quality of the slurry [443, Chadwick et al. 2011].

Covering reduces or eliminates the oxygen exchange between manure and air and results in an increase of temperature of the slurry by approximately 2 °C. Under these conditions, methane can be formed; its recovery and use for energy production is possible but involves an extra cost [259, France 2010]. Generally, the covering of slurry stores is an effective means of reducing ammonia emissions, but may pose problems in application, operation and safety. The lack of oxygen reduces nitrification and (consequently) denitrification, and hence nitrous oxide emissions could be significantly reduced or prevented. With some covers, e.g. LECA, oxygen can still enter the slurry, which means that (de-)nitrification processes can occur and hence emissions of nitrous oxide are likely to increase.

Closed impermeable covers prevent rainfall diluting the slurry, so that a reduced volume of slurry is achieved and an increased effective storage period is provided by the store. In areas with moderate to high rainfall, these types of cover can be cost-effective, limiting transportation and spreading costs [525, BPEX 2011] [259, France 2010].

In the UK, for pig slurries with a very low dry matter content of less than 1 % produced by diluting slurry with washing water or contaminated rainwater run-off, the store may not need to be covered. The criterion for this to be acceptable is a regular control of the slurry store to confirm that the DM remains annually below 1 % [524, UK EA 2012].

Ammonia emissions from storage over 6 to 12 months have been measured or estimated in Denmark and are shown in Table 4.160.

Table 4.160: Ammonia emissions as a percentage of the total stored nitrogen in slurry containers in Denmark

Type of cover	Emission (% of total N) (ex-housing)
Untreated slurry	
Uncovered	9.0
Natural organic cover	2.0
Floating fabric cover	1.5
Tent	1.0 ⁽¹⁾
Concrete cover	1.0
Digested slurry	
Uncovered	21
Covered (chopped straw, plastic, natural crust, etc.)	4
Tent or concrete cover	2.0
⁽¹⁾ Estimation.	
Source: [210, Denmark 2010] [442, Hansen et al. 2008]	

Slurry bags are large prefabricated bags made from reinforced fabric bags coated with PVC or polyester sitting within an earth structure, for storing slurry or liquid manure. They are restrained at the sides, fitted with gas vents to prevent the build-up of gases, and the cover provides part of the structural integrity of the store [525, BPEX 2011]. They are an alternative to steel or concrete stores and can provide long-term storage and make a cost-effective alternative. This technique is mainly suitable for small farms (e.g. < 150 fattening pigs). Available bag sizes may limit the use on larger livestock farms. The cost of this technique is reported to be EUR 2.5/m³ per year including both the storage structure and the cover. Ammonia emissions reduction is reported as almost 100 % [508, TFRN 2014].

4.11.2.2 Application of a rigid cover to slurry stores

Description

Rigid covers are tight covers (e.g. a roof or a lid) which are made from inflexible material such as concrete, fibreglass panels or polyester sheets with a flat deck or conical shape (see Figure 4.77). They should be well sealed or 'tight', in order to minimise air exchange, but fitted with gas vents to prevent the accumulation of flammable gases. They fully cover the slurry surface, preventing rain and snow from entering, and so enable a more predictable storage capacity. Covering small slurry stores is in general more straightforward than covering larger ones. If the cover is made of a lighter material, then the span can be larger than for concrete covers exceeding 25 m and with a central support.



Source: [204, IMPEL 2009]

Figure 4.77: Rigid cover for slurry storage, with conical shape

Achieved environmental benefits

The covering of store surfaces is known to significantly reduce odour and ammonia emissions.

Cross-media effects

Accumulation of toxic (e.g. H₂S) or explosive (methane) gases may occur which must be considered for safety reasons. Some small openings (which do not undermine the minimum sealing required), or a facility for venting, are needed to prevent the build-up of such gases.

Environmental performance and operational data

A concrete cover allows the achievement of ammonia emission reductions of 90 % [575, UBA Germany 2011]. Purpose-built (rigid) covers are reported to give reductions of at least 80–90 % for ammonia and odour emissions associated with manure storage. Generally, NH₃ emission levels from slurry storage under warm climates are higher than under cold climates; therefore, the reduction efficiency of covering slurry stores is expected to be higher in warm climates when it is expressed in relation to an uncovered store.

Gaseous emissions were measured during field experiments, for the relatively warm and cold climates related to Austria. The experiment concerned the storage of slurry produced by a straw flow system, with the use of a solid cover in underground pilot stores, compared with uncovered stores. The observation periods were 50 days and 200 days of storage in warm conditions and 50 days of storage in cold conditions. A summary of the results is given in Table 4.161. Ammonia and methane emissions are reduced in both climatic conditions. The rigid cover seems to only have a positive effect on nitrous oxide emissions in cold conditions.

Table 4.161: Reduction of gaseous emissions from the storage of slurry with the use of a rigid cover in underground pilot stores, compared to uncovered stores

Parameter	Reduction (%)	
	Warm conditions ⁽¹⁾ ⁽²⁾	Cold conditions ⁽¹⁾ ⁽³⁾
Ammonia (NH ₃)	28–44	15
Methane (CH ₄)	32–70	38
Nitrous oxide (N ₂ O)	-4 ⁽⁴⁾ –30	50
⁽¹⁾ The results for warm conditions have been tested for 50 and 200 days of storage. For cold conditions, the observation period was equivalent to 50 days of storage. ⁽²⁾ Average slurry temperature 17 °C (from 13.6 °C to 21.9 °C). ⁽³⁾ Average slurry temperature 12 °C (from 8.1 °C to 16.6 °C). ⁽⁴⁾ Increase of 4 %. Source: [519, Amon et al. 2007]		

Technical considerations relevant to applicability

Rigid covers are usually installed at the same time as the store. A fixed cover may not be suitable for retrofitting in existing tanks, as it requires the store to be structurally suitable and may involve additional reinforcement to withstand the extra load [525, BPEX 2011] [508, TFRN 2014]. For technical reasons, rigid covers cannot fit widely dimensioned earth-banked lagoons and geomembrane-lined stores, such as the typical French slurry stores used for duck manure [259, France 2010].

Economics

Retrofitting a cover to an existing store is reported to be expensive. In the UK, the cost of a covered store is 50 % more expensive than the cost of an uncovered one [175, Ecodyn 2010]. Costs for rigid covers are reported from France and presented in Table 4.162.

Table 4.162: Costs for rigid polyester covers reported from France

Type of cover	Investment cost	
	EUR/t pig produced ⁽¹⁾	EUR/m ³ slurry/year ⁽²⁾
Rigid resin polyester cover without central post ⁽³⁾	10	-
Polyester cover with central post ⁽⁴⁾	5	0.8–1
⁽¹⁾ Farm with 550 fattening pig places. ⁽²⁾ Farm of 1 000 m ² , for duck rearing. ⁽³⁾ Tax excluded, on-farm installation included. ⁽⁴⁾ Tax and on-farm installation excluded. NB: Costs calculated for a depreciation period of 20 years (without interest charges and subsidies). Source: [259, France 2010]		

From Germany, cost data associated with various types of covers, applied for slurry storage, are reported, expressed per m³ of slurry stored, per m² of surface or per kg of NH₃ abated. [575, UBA Germany 2011]. Comparisons of costs for rigid, flexible and floating covers applied to round slurry tanks of different capacities are presented in Table 4.163. Emission reduction costs for the different types of covers are given in Table 4.164, together with mitigation costs, which take into account the fertiliser value (conserved nitrogen) and the costs associated with the extra volume of water from precipitation that would have to be landspread, and the tank freeboard needed to contain precipitation water.

Table 4.163: Cost data for different covers of slurry tanks, in Germany

Dimensions ⁽¹⁾						
Usable storage capacity	500 m ³	1 000 m ³	3 000 m ³	5 000 m ³		
Diameter	13.7 m	17.7 m	27.9 m	35.5 m		
Investment and annual costs ⁽²⁾						
Type of cover	Annual storage costs (EUR/m ³ /yr)	Investment costs (EUR/m ²)	Annual storage costs (EUR/m ³ /yr)	Annual storage costs (EUR/m ³ /yr)	Annual storage costs (EUR/m ³ /yr)	Investment costs (EUR/m ²)
Uncovered (reference)	1.78	NR	1.57	1.29	1.17	NR
Concrete cover	2.74	NI	2.38	1.96	1.82	NI
Tent cover	3.67	100	2.74	2.00	1.74	46
Floating flexible cover	2.7	34	2.14	1.66	1.47	16
Light bulk materials	2.03	10.2	1.73	1.43	1.3	7.6
Geometrical plastic tiles	2.42	39.5	2.11	1.73	1.6	39.5
Straw ⁽³⁾	2.2	NR	1.86	1.49	1.35	NR

⁽¹⁾ A residual volume of 0.5 m (depth) and a freeboard of 0.2 m have been considered.
⁽²⁾ For the cost calculation, a storage duration of 6 months was assumed; the expenses presented are based on an annual slurry quantity which is twice as large as the usable capacity.
⁽³⁾ Costs are based on two coverings per year. Additional operating costs depend on the thickness of the layer.
NB: NI = no information provided; NR = not relevant.
Source: [575, UBA Germany 2011]

Table 4.164: Ammonia emissions mitigation costs for different covers of slurry tanks, in Germany

Storage capacity					
Usable storage capacity		500 m ³	1 000 m ³	3 000 m ³	5 000 m ³
Emission reduction and mitigation costs					
Type of cover		EUR/kg NH ₃	EUR/kg NH ₃	EUR/kg NH ₃	EUR/kg NH ₃
Concrete cover		1.25	1.25	1.25	NI
	⁽¹⁾	(0.44)	(0.45)	(0.47)	NI
Tent cover		2.45	1.81	1.33	1.09
	⁽¹⁾	(1.64)	(1.01)	(0.55)	(0.32)
Floating flexible cover		1.27	0.94	0.73	0.60
	⁽¹⁾	(1.07)	(1.29)	(0.52)	(0.40)
Light bulk materials		0.36	0.28	0.28	0.27
	⁽¹⁾	(0.17)	(0.09)	(0.09)	(0.08)
Geometrical plastic tiles		0.88	0.88	0.88	0.88
	⁽¹⁾	(0.67)	(0.67)	(0.67)	(0.67)
Straw		0.63	0.53	0.43	0.41
2 times per year ⁽²⁾	⁽¹⁾	(0.47)	(0.36)	(0.26)	(0.24)
4 times per year ⁽²⁾	⁽¹⁾	(1.17)	(0.94)	(0.74)	(0.69)

⁽¹⁾ Cost data take into account the value of conserved nitrogen, the expenses for landspreading of precipitation water and the cost of the tank freeboard for precipitation water.
⁽²⁾ Costs are given for slurry application frequencies of two and four times per year.
Source: [575, UBA Germany 2011]
NB: NI = no information provided.

Driving force for implementation

Rigid covers like plastic or concrete lids and roofs are characterised by a long service period. The dilution of the slurry, as can occur in uncovered manure pits due to rain lowering the solid matter and the nutrient content, is avoided. In some Member States, all new and substantially enlarged slurry stores are required to be covered (e.g. the UK). In Denmark, it has been a requirement since 1986 to store slurry in tanks with a tight cover.

Example plants

Several applications of rigid covers are present throughout the European Union.

Reference literature

[26, Finland 2001] [11, ADAS 2000] [175, Ecodyn 2010] [204, IMPEL 2009] [259, France 2010] [508, TFRN 2014] [519, Amon et al. 2007] [525, BPEX 2011] [575, UBA Germany 2011]

4.11.2.3 Application of a flexible cover to slurry stores

Description

A cover made from flexible or pliant sheet material such as reinforced plastic sheeting or strong canvas that is stretched taut over the store. Various types of flexible covers exist. Descriptions of the main types and characteristics are given below.

Tent covers (or covers held up by a central post)

Tent covers have a central supporting pole with spokes radiating from the top. A fabric membrane or a polyester material with a high density (800–900 g/m²) is spread over the spokes and is secured at the edge of the tank, e.g. tied to a rim brace which is a circular pipe that is located on the outside around the circumference, just below the top of the store. The cover is tightened over the store by evenly spaced vertical straps between the rim brace and the tent rim.

The pole and spokes are designed to withstand wind and snow loads. Whilst it is important to guarantee that covers are well sealed to minimise air exchange, there must be small openings or a facility for venting to prevent the build-up of gases under the cover. The cover also incorporates an opening for an inlet pipe and a hatch that can be opened for inspecting the store's contents.

Dome-shaped covers

Curved structural frames are installed over round stores without needing a central pole. Steel components are assembled by bolted joints during the installation on farm. Installations can have around 600 m² of round surface. Inspection windows can be adjusted in the flexible cover.

A similar design for rectangular pits exists consisting of galvanised steel arches holding a tunnel-shaped cover (600 g/m²) [259, France 2010].

Flat covers

These covers consist of a flexible and self-supporting composite material, held by stainless plugs on a galvanised steel structure all around the pit. For geomembrane pits, the construction of a concrete longitudinal beam around the pit is necessary. A system is generally incorporated to carry away the rainwater (impluvium with pump).

Achieved environmental benefits

Reductions of ammonia emissions of 80–90 % have been reported for tent covers or plastic covers, compared to storage tanks with no cover. During necessary stirring and pumping, odour emissions may arise, but, overall, odour emissions are reduced.

Cross-media effects

Accumulation of toxic and flammable gases may occur, which must be considered for safety reasons. The development of H₂S may cause some corrosion, which can affect the structure and the cover. The recovery and utilisation of methane from the biogas may be a possibility, but at an extra cost.

Environmental performance and operational data

Covers must be durable and need to completely cover the slurry surface. Normally, masts are erected after the container is emptied and cleaned, although some installers can fit masts while slurry is in the tank. Ammonia reductions are in the range of 50 % compared to the natural floating layer (see Table 4.160).

Technical considerations relevant to applicability

Flexible covers are not applicable in areas where prevailing weather conditions can compromise their structure. The larger the diameter of the store the more difficult the application of the cover will be, as the cover must be evenly taut in all directions to avoid uneven loads.

From a UK survey, it appeared that tent-type covers can be applied to 50–70 % of the existing steel-type stores with only modest modifications needed. Typically this consists of fitting an additional stiffening angle strip around the rim of the store. Tent covers can be fitted to existing concrete stores without modifications for diameters under 30 m, but a technical survey is recommended beforehand. It is important to calculate the required strength of the construction to ensure it can withstand wind and snow loads, for both the store and the store with cover.

Most tent covers are held by structures that cannot be applied to existing square or rectangular concrete stores, which are common in many EU countries [506, TWG ILF BREF 2001]. With earth-banked slurry lagoons, this system presents significant technical difficulties for its implementation. In Belgium (Flanders), flexible covers should maintain their characteristics for at least 10 years [255, BE Flanders 2010].

Economics

The installation of a tent cover on an existing container normally requires that the tank be emptied first and cleaned, an operation that costs, in Denmark, approximately EUR 1/m³ (EUR 2 000 for a 2 000 m³ store). The installation of the tent itself costs around EUR 10 per cubic metre for a slurry storage capacity of 7 700 m³, which corresponds to 17 500 fattening pigs produced annually. The annualised investment costs are reported as EUR 0.2/m³ and costs expressed per fattening pig are equivalent to EUR 0.25, including savings from reduced use of mineral fertiliser, and due to reduced ammonia emissions [210, Denmark 2010].

Costs for the purchase in France of flexible covers are given in Table 4.165.

Table 4.165: Costs for different types of flexible covers in France

Type of cover	Investment costs ⁽¹⁾	
	EUR/t pig produced ⁽²⁾	EUR/m ³ slurry/year ⁽³⁾
Tent covers	10	0.9–2.9
Flat covers	10–20	1.2–2.6
Tunnel-shaped cover	10–20 ⁽⁴⁾	1–2 ⁽⁴⁾

⁽¹⁾ Tax and installation cost excluded. Includes capital payback time of 10 years (8 years for tunnel-shaped covers).
⁽²⁾ Refers to a farm with 550 places for fattening pigs.
⁽³⁾ Refers to a duck rearing farm of 1 000 m².
⁽⁴⁾ Installation costs included in the upper end of the range.
Source: [259, France 2010]

Annual costs, as well as ammonia reduction costs, reported from Germany for tent covers applied on slurry storage are included in Table 4.163 and Table 4.164 (see Section 4.11.2.2), in

comparison with a concrete cover and floating covers. Cost data for a fixed flexible tent cover applied to an above-ground slurry tank with a capacity of 1 037 m³ and a surface area of 314 m² (20 m in diameter and 3.6 m in height) are reported from the UK and presented in Table 4.166.

Table 4.166: Costs for covering an above-ground slurry tank with flexible covers, in the UK

Type of cover	Investment cost (EUR/m ²) ⁽¹⁾	Investment cost (EUR) ⁽¹⁾	Annualised cost (EUR/year) ⁽¹⁾ ⁽²⁾
Fixed flexible tent cover ⁽³⁾	68.2	21 400	2 050
⁽¹⁾ Cost data based on exchange rate EUR 1 = GBP 0.88. ⁽²⁾ Includes capital payback time of over 20 years, interest costs and maintenance costs. ⁽³⁾ Investment costs include tank strengthening, central supporting pole, radial webbing straps, etc.; potential savings, due to avoided rainfall to be spread with slurry, are not included. Source: [524, UK EA 2012]			

Driving force for implementation

Slurries that are the output from biogas production, or from slurry separation processes, cannot develop natural floating layers because of their low dry matter content. In these cases, a tent cover could be relevant.

In some Member States, all new and substantially enlarged slurry stores are required be covered (e.g. the UK). In the UK, all existing slurry stores also have to be covered by 2020 [524, UK EA 2012]. In Denmark, it has been a requirement since 1986 to store slurry in containers with a tight cover [499, AgroTech 2008].

Example plants

Applications have been reported in the UK and the technique is widely spread in France. In Denmark, there are roughly 1 500 slurry tanks with tent covers applied on containers of 500 m³ and over. On smaller containers, concrete covers are normally used.

Reference literature

[11, ADAS 2000] [210, Denmark 2010] [255, BE Flanders 2010] [259, France 2010] [499, AgroTech 2008] [506, TWG ILF BREF 2001] [524, UK EA 2012]

4.11.2.4 Application of a floating cover to slurry stores

Description

Floating covers comprise a substance or material that rests on the surface of the slurry. There are different types of floating covers, such as:

- natural crust;
- straw (crust);
- peat;
- light bulk material (e.g. LECA, LECA-based products, perlite, zeolite);
- plastic pellets (polystyrene balls);
- oil-based liquids (e.g. rapeseed oil);
- floating flexible cover (e.g. plastic sheets, blankets);
- geometrical plastic tiles;
- air-inflated cover.

Natural crust

This represents the simplest method of slurry covering. A floating crust is formed on the surface of stored slurry with a high dry matter content, to which the crust thickness is closely related [575, UBA Germany 2011]. Slurry containing litter and feed residues will naturally separate into a fraction with a high solids content and a fraction with virtually no solids. Depending on the type of feed residues and litter contained in the slurry, solids will either sink (e.g. usually feed residues) or rise to the surface (e.g. straw bedding) [499, AgroTech 2008]. Natural crust formation over the slurry is enhanced by gasification, i.e. the release of gases that are transported from the slurry to the store surface by means of bubbles which adhere to fibres and particles that will float on the store surface. During winter, with little anaerobic activity and ebullition, the crust layer may sink and leave the slurry uncovered. This may not be a major problem because ammonia emissions from uncovered slurry are low during cold seasons [590, Batfarm 2013]. Crusting is unlikely to occur in stores with a slurry dry matter content of < 2 % [439, Sommer et al. 2006]. Under Mediterranean (e.g. Spain) climatic conditions, a natural crust is easily formed at a rate of about 1 cm in 2 weeks. Minimising stirring and introducing new slurry below the surface of stored slurry help the build-up of a natural crust. Emptying slurry from the bottom prevents the breaking of the crust.

Straw or manure with a high content dry matter

The formation of a fibrous floating layer on the surface of stored slurry is facilitated by adding chopped straw or other fibrous material. Straw is a floating cover that is not suitable for very dilute pig slurry, as it may sink immediately, or, if it floats, it will be easily affected by wind and rain. It may also lead to blocked pumps and drains. However, when the pig slurry has a dry matter content of 5 % or higher, it is then possible to obtain a straw-induced crust that performs well [11, ADAS 2000] [209, Denmark 2010]. Longer chopped straw in a thick layer (e.g. 4 cm long) can bind and float more easily [624, IRPP TWG 2013].

Straw covers should be at least 10 cm thick. A thick layer of coverage consisting of manure or deep litter with a high dry matter content is very similar to a straw layer and will therefore have the same effect.

Peat and light bulk material (e.g. LECA, LECA-based products, perlite, zeolite)

A floating layer is formed on the surface of stored slurry or liquid manure produced by the addition of a suitable material. These covers have been more extensively researched and, from literature, appear to be easily applied. They cannot be reused and have to be replenished every year.

When granulates such as light expanded clay aggregates (LECA) are used, material losses are lower than in the case of straw. Granules float up again shortly after the slurry has been stirred, therefore only a small amount of them is spread with the slurry [575, UBA Germany 2011].

Polystyrene balls (EPS)

Tank covers made of polystyrene balls of 20 cm in diameter and 100 g in weight (density of 23.8 kg/m³) are used and are easy to implement [259, France 2010].

Oil-based liquids (e.g. rapeseed oil)

Generation of a floating, biodegradable cover on the slurry.

Floating flexible covers (blankets, sheets)

Canvas (porous textile membranes) or flexible plastic sheets rest on the slurry surface. The cover is fixed to the rim of the store (e.g. by vertical ropes) or is designed to float freely on the surface. They are equipped with an inspection hatch, ventilation openings, and openings for filling and mixing the slurry. Also, a pump is used to drain any rainwater collected on top of the cover. Plastic sheets consist of a treated flexible synthetic fabric (anti-UV, salt spray, moulds, etc.) of variable density (660 g/m² to 950 g/m²).

The canvas can be fixed, or kept in place by counterweights hanging over the rim of the store. Floating covers in round stores may rise and fall with the slurry depth, sliding their floating edges on a galvanised steel structure, or they may be stretched over and tensed around a plastic hoop, which floats on the surface by the perimeter walls. This metal structure channels the rainwater to the centre of the cover. The rainwater is generally collected in a sump and evacuated using a pump. An opening generally allows easy access to the inside (for mixing of the slurry, etc.).

Geometrical plastic tiles

Hexagonal plastic bodies (bricks) fit together on the slurry surface to maximise the covering (see Figure 4.78). These bodies are modular, can practically cover a surface of any shape and size and adapt to changes in the slurry level. They can also be placed on empty stores. Depending on the geometry of the container and the slurry's dry matter content, around 95 % of the surface can be covered. These covers can stop light rainfall from entering the slurry due to their design [525, BPEX 2011]. An enhanced version with an activated carbon filter allows the filtering of gaseous emissions [14, Spain 2014].



Source: [14, Spain 2014]

Figure 4.78: Geometrical plastic tiles in a slurry tank

Air-inflated covers

A treated high-density (915 g/m²) PVC fabric is supported by an inflatable pocket that floats over the slurry. The fabric is fixed by a guy rope to a structure peripheral to the pit, made out of galvanised steel. The inflatable pocket is supplied by a low-pressure blower. An inspection door allows frequent inspection [259, France 2010].

Achieved environmental benefits

Covering the slurry surface with floating covers has a significantly restrictive effect on ammonia volatilisation from slurry stores and thus reduces ammonia emissions. Covers greatly decrease the air exchange rate between the surface of the slurry and the atmosphere by creating a stagnant air layer above the slurry through which NH₃ has to be transported by the slow process of diffusion, which also decreases the ammonia losses [439, Sommer et al. 2006].

Odour emissions are reduced because the surface covering forms a physical barrier, but also because the biological conversion of odorous substances (oxidation of the odorous components by microorganisms) can take place in the covering, as is the case for straw covers [209, Denmark 2010]. There is some evidence that floating covers may reduce CH₄ emissions from slurry stores [518, Sommer et al. 1999]. Geometrical plastic tiles with an activated carbon filter allow an extra reduction of ammonia, odour and other emissions to air.

Cross-media effects

Obviously, some floating covers that mix with or are dissolved in the slurry may affect the quality of the slurry or be harmful to grazing animals. The disposal of end-of-life inorganic floating materials also has to be taken into account. A slight effect on N₂O emissions has been observed. It appears that, in relation to the water balance of the crust, a cover could increase N₂O emissions when dry conditions prevail.

Natural crust and straw crust

Organic floating layers, like straw covers, might increase CH₄ and N₂O emissions but there is still great uncertainty about the quantification of how much of this increase is due to floating crusts. The Intergovernmental Panel on Climate Change, IPCC (2006 IPCC Guidelines for National Greenhouse Gas Inventories) suggests an emission factor for N₂O emissions of 0.005 kg of N₂O-N per kg of nitrogen excreted from slurry with an organic crust, which, compared to the emission factor for direct emissions from manure landspreading (0.01 kg N₂O-N), is considered substantial [659, IPCC 2006]. The effect of straw and crust on the overall emissions of greenhouse gases is not fully known; however, covering slurry stores with organic floating layers is not expected to significantly modify the emissions of greenhouse gases, compared to uncovered stores [209, Denmark 2010]. It is estimated that stirring of the slurry would need approximately 10–12 litres of gasoline per tonne of added straw.

Peat and light bulk material (e.g. LECA)

Peat is a non-renewable resource and its digging is related to high indirect CO₂ emissions. It has been measured that peat covers increase methane emissions by 30 % [259, France 2010]. Peat mixes with slurry during stirring, gets waterlogged and has to be renewed after each stirring. However, peat is a natural product and does not create a waste problem.

Polystyrene balls (EPS)

When plastic balls roll around, they expose the slurry sticking to the previously submerged face to the open air and therefore increase emissions. Wide stores are subjected to the wind effect and loose material (i.e. plastic pellets and balls) can accumulate on one side and uncover the slurry surface. Therefore, it is necessary to regularly add balls to cover the uncovered zones, due to the turbulence induced by the configuration of the containers [259, France 2010] [522, Loyon et al. 2007].

Oil-based liquids (e.g. rapeseed oil)

Effects due to a reaction between the floating biodegradable cover (rapeseed oil by about 60 %) and the slurry may increase the emission of methane. In the case of rapeseed oil, anaerobic reactions may produce surfaces with a strong, rancid odour.

Floating flexible covers

Accumulation of gases generated by slurry under closed (plastic) covers may occur which must be considered for safety reasons, hence the necessity for vents. If practicable, gases may be used in a biogas installation.

Geometrical plastic tiles

No information provided.

Environmental performance and operational data

In general, floating covers are easily applied, but cannot be placed on empty stores.

Natural crust and straw crust

In order to maintain the crust, stores are preferably filled from below [337, Webb et al. 2005]. Straw should not be chopped too short, to prevent it flying away. For the same reason, good operation to reduce wind blowing consists of mixing straw with slurry at the time of slurry addition. Agitation is done with a pump or with a tractor-driven propeller in large slurry tanks [209, Denmark 2010].

In Germany, the minimum requirement in order to build up a floating cover of chopped straw with a reduction efficiency for ammonia emissions of 80 % is achieved with a layer of 10 cm (addition of 5–10 kg of straw per m² slurry surface) [474, VDI 2011]. In Denmark, it is recommended to use 10–15 kg of straw per m² slurry surface, which will result in an approximately 15–20 cm thick floating layer. A reduction in ammonia emissions of between 60 % and 70 %, on average, is reported from the UK [11, ADAS 2000].

Application of straw to the slurry surface is preferably done with a forage harvester [575, UBA Germany 2011]. The abatement achieved is effective at a low cost but has a short lifetime, as it deteriorates with rainfall and due to the climate. The floating layer of straw has a short lifespan and should be regenerated every year.

Natural organic covering, whether a natural floating layer or with the addition of chopped straw, is used in Denmark as the reference for emissions from slurry stores. A factor of 2 % is assumed for nitrogen losses from the total stored nitrogen (total N).

Farmyard manure or deep litter can also be used to establish a floating layer. A recommended quantity to use is 0.2–0.4 m³ of manure per m² of slurry surface [499, AgroTech 2008] [591, Denmark 2009]. However, this type of cover is rarely used in pig farms, although it is typically found in cattle farms [591, Denmark 2009].

Peat and light bulk material (e.g. LECA, perlite)

Light bulk materials, such as LECA, LECA-based products, perlite and zeolite, or peat are added to the slurry surface to form a floating layer. A floating layer of 10–12 cm is recommended. Smaller LECA particles are generally more effective than larger particles; they can be relatively effective with a 3–5 cm layer. LECA is a permeable floating cover. It allows air to penetrate the floating layer and provides sufficient moisture and an adequate surface area for a population of aerobic bacteria to develop. In this way, an improved effect on odour reduction is provided [592, R.Burns, L.Moody 2007]. The material does not prevent rain entering the slurry store. Wet LECA is less effective, so a greater thickness of the cover could achieve a better efficiency. An annual replacement of 10 % of the material is required. It is easy to install in new and existing slurry stores and has a relatively long lifetime.

LECA can provide a maximum emission reduction of about 80 %. In Germany, a reduction efficiency in ammonia emissions of 80–90 %, compared to an open store, is achieved with the use of LECA [474, VDI 2011].

The efficiency of floating peat covers for reducing ammonia emissions is reported to be in the range of 80–90 %. However, in France, the results of field tests were not completely satisfactory, with an ammonia emission reduction of approximately 25 %, in comparison with uncovered pig slurry storage.

Perlite floats easily on the slurry surface, but its effectiveness in reducing ammonia emissions is variable and it was found to be easily blown by wind [592, R.Burns, L.Moody 2007]. The size of the lightweight aggregate material used for floating covers is 4–8 mm in Denmark; it can be delivered by truck, and spread evenly on the slurry. The reported quantity necessary is 20 kg per m² of slurry surface, resulting in a floating layer of 10–12 cm [499, AgroTech 2008].

Polystyrene balls (EPS)

As for light bulk materials, plastic pellets can be distributed in smaller layers. Turbulence over the surface are induced by the geometry of the container, hence uncovered spots and deteriorated elements need to be regularly refilled or replaced [259, France 2010]. A study has shown that the use of a layer of polystyrene balls reduced ammonia emissions during storage by up to 80 % whatever the season [522, Loyon et al. 2007].

Oil-based liquids (e.g. rapeseed oil)

Rapeseed oil (or derivatives with high percentages of rapeseed oil) is very easy to apply and does not easily mix with pig slurry. However, it is biodegradable, loses its surface integrity over time and also greatly increases methane emissions. Oil covers, tested in pilot studies, have shown to reduce emissions; while a 3 mm of oil layer had little effect, a 6 mm layer proved to be very efficient [590, Batfarm 2013].

Floating flexible covers

No structural alteration is necessary. Agitation is possible. Rainwater can be pumped off. Access for desludging is difficult.

Geometrical plastic tiles

This type of cover is easy to install in both new and existing slurry stores. However, they do not prevent rain from entering the store. Emissions are reduced by 50–95 %, compared with uncovered containers. The degree of reduction depends on the amount of covered surface, e.g. a reduction of 90 % in ammonia emissions is assumed for a surface coverage of 95 % and 80 % for a 90 % surface coverage. Odour abatement is estimated to be in the range of 80–90 %. For the enhanced version with an activated carbon filter, the reduction efficiency for NH₃ is reportedly 79 % and for odour compounds (mercaptans, phenol, acetic acid and putrescine) > 94 % and at least 50 % in all cases and for all emissions to air.

Emissions

The emission reduction efficiency varies with the cover type applied and is generally higher in summer than in winter. Table 4.167 gives an overview of the reduction efficiencies reported for different types of floating covers applied on slurry stores. The baseline for estimating the mitigation efficiency of different covers is the emission from the same type of store, without any cover on the surface.

Table 4.167: Performance of different types of floating covers

Type of cover	Source	NH ₃ (%)	CH ₄ (%)	Odour (%)	H ₂ S (%)	Cover durability (years)
Natural crust	[575, UBA Germany 2011]	20–70	NI	NI	NI	NI
	[208, Spain 2010]	28	NI	NI	NI	0.5 or more
	[520, Fleming R. 2006]	10–90	NI	NI	10–90	NI
	[209, Denmark 2010]	80	NI	NI	NI	NI
Straw crust	[214, Germany 2010] [575, UBA Germany 2011]	80 (Up to 90)	NI	NI	NI	NI
	[209, Denmark 2010]	80	NI	80	NI	1.2
	[43, COM 2003]	60–70	NI	NI	NI	NI
	[520, Fleming R. 2006]	60–90	NI	40–90	80–95	NI
	[26, Finland 2001]	71	NI	NI	NI	NI
Peat	[43, COM 2003]	Up to 90	NI	Up to 90	NI	2
	[259, France 2010]	25	+ 30	NI	NI	NI
	[26, Finland 2001]	92	NI	NI	NI	NI
	[521, Portejoie et al. 2003]	77–100	NI	NI	NI	NI
	[474, VDI 2011]	80–90	NI	NI	NI	NI
LECA	[592, R.Burns, L.Moody 2007]	65–95	NI	90	NI	NI
	[26, Finland 2001]	75–82	NI	NI	NI	NI
	[474, VDI 2011]	80–90	NI	NI	NI	NI
	[217, Denmark 2010]	80	NI	NI	NI	NI
Zeolite	[521, Portejoie et al. 2003]	93–98	NI	NI	NI	NI
Perlite	[520, Fleming R. 2006]	63–91	NI	30–93	64–84	NI
Plastic pellets (EPS balls)	[522, Loyon et al. 2007]	Up to 80	+ 20	NI	NI	NI
Rapeseed oil	[43, COM 2003]	Up to 90	+ 60	Up to 90	NI	NI
	[26, Finland 2001]	92–93	NI	NI	NI	NI
	[520, Fleming R. 2006]	85	NI	NI	NI	NI
Floating flexible covers (blankets, sheets)	[43, COM 2003]	Up to 90	NI	Up to 90	90–95	10
	[26, Finland 2001]	92	NI	NI	NI	NI
	[521, Portejoie et al. 2003]	99	NI	NI	NI	NI
Geometrical plastic tiles	[216, Denmark 2010]	80 (50–95)	NI	80–96	NI	25
	[520, Fleming R. 2006]	95	NI	NI	NI	NI
Geometrical plastic tiles with activated carbon	[14, Spain 2014]	79	65	> 94	82	25 (10 % filter replacement each year)

NB: NI = no information provided.

Technical considerations relevant to applicability

Floating bodies such as plastic pellets, light bulk materials and geometrical plastic tiles are only suitable for slurry without a natural floating layer. When the slurry is stirred and discharged, it should be ensured that floating bodies are not sucked in with the slurry in order to avoid losses, clogging and damages [575, UBA Germany 2011]. In particular, for viscous slurry capable of forming a natural floating layer, expanded clays and perlite are not suitable as they cannot automatically distribute on the slurry surface and cover it. Similarly geometrical plastic tiles can be only used in low dry matter slurry without a natural crusting tendency (e.g. digestate from anaerobic digestion) [624, IRPP TWG 2013].

Agitation during stirring, filling and emptying may preclude covering with some floating materials. They may cause sedimentation or blockages in pumps [524, UK EA 2012]. For example, geometrical plastic tiles are not suitable where a frequent spreading of slurry requires mixing [624, IRPP TWG 2013].

Natural crust formation is an option for farms that do not have to mix the manure and disturb the crust in order to spread slurry frequently. A crust may not form in cool climates and/or on slurry with a low dry matter content [508, TFRN 2014].

The use of straw covers in large slurry stores (i.e. lagoons) may be problematic, since the larger the slurry storage structure the more difficult it is to achieve a uniform application of materials. In rainy climates, the use of dry straw is not recommended because, when rained on, the rate at which the straw sinks dramatically increases [592, R.Burns, L.Moody 2007].

The use of floating flexible covers on slurry stores that are emptied on an annual or semi-annual basis or that have high sides [508, TFRN 2014], and hence have a large variation in manure level, also requires special installation considerations, to allow an impermeable synthetic cover to move up and down as the level of stored manure changes [592, R.Burns, L.Moody 2007].

Economics

Normally, floating covers have the same costs for both new and existing tanks. Where natural crusts with a sufficient thickness are possible, and slurry is introduced below the crust, a significant ammonia reduction can be achieved at little or no cost [508, TFRN 2014].

The straw price varies locally and as a function of annual climatic conditions. In 2012, the price per kg of straw reported from Spain was around EUR 0.04–0.10.

The initial purchase of straw represents about 55 % of the total costs, while the remaining 45 % is distributed on machine and staff hours. The floating straw layer may have a lifespan of 1 to 2 years [209, Denmark 2010].

Annual costs, as well as ammonia reduction costs, reported from Germany for floating covers are presented in Table 4.163 and Table 4.164 (see Section 4.11.2.2), in comparison with a concrete cover and a tent cover. Investment cost data for some types of floating covers in Denmark are summarised in Table 4.168.

Table 4.168: Investment costs for some types of floating covers, in Denmark

Type of cover	Investment costs		Annualised investment costs	Remarks
	EUR/m ³	EUR/m ²	EUR/m ³ /yr	
Geometrical plastic tiles	8–10	35–40	0.5	Based on a durability of 25 years and a surface area of approximately 1 000 m ² (height of storage tank: 4 m)
LECA	1.75	7	0.2	Based on a supplement/refill of 10 % of the surface material
Straw cover	NI	1	0.25	The floating layer is assumed to be regenerated every year (height of storage tank: 4 m)

NB: NI = no information provided.
Source: [216, Denmark 2010] [217, Denmark 2010] [209, Denmark 2010]

Some indicative cost data reported by France are shown in Table 4.169.

Table 4.169: Investment costs for different types of floating covers in France

Type of cover	Investment costs ⁽¹⁾	
	EUR/t pig produced ⁽²⁾	EUR/m ³ slurry/year ⁽³⁾
Air-inflated covers ⁽⁴⁾	10	1.8
Floating flexible covers ⁽⁵⁾	3–10	0.4–1.3

⁽¹⁾ Tax and installation costs excluded. Includes capital payback time of 10 years.
⁽²⁾ Refers to a farm with 550 places for fattening pigs.
⁽³⁾ Refers to a duck rearing farm of 1 000 m².
⁽⁴⁾ For an air-inflated cover, the energy consumption for the blower is considered negligible.
⁽⁵⁾ For a floating cover, the energy consumption for operating the pump for the drainage of rainwater is negligible.

Source: [259, France 2010]

Cost data for a floating flexible cover applied to an above-ground slurry tank with a capacity of 1 037 m³ and a surface area of 314 m² (20 m in diameter and 3.6 m in height) are reported from the UK and presented in Table 4.170.

Table 4.170: Costs for covering an above-ground slurry tank with floating flexible covers, in the UK

Type of cover	Investment cost (EUR/m ²) ⁽¹⁾	Investment cost (EUR) ⁽¹⁾	Annualised cost (EUR/year) ⁽¹⁾ ⁽²⁾
Floating flexible cover ⁽³⁾	28.4	9 000	910

⁽¹⁾ Cost data based on exchange rate EUR 1 = GBP 0.88.
⁽²⁾ Includes capital payback time of over 20 years, interest costs and maintenance costs.
⁽³⁾ Potential savings, due to avoided rainfall to be spread with slurry, are not included.

Source: [524, UK EA 2012]

From Spain, the investment cost for the use of a floating flexible cover is reported to be EUR 20/m², corresponding to an extra cost of EUR 2.3/m³ or EUR 28.8/t of pig produced [379, Spain 2009]. Investment costs for geometrical plastic tiles with activated carbon filters are reported to be EUR 123/m² and the annualised costs EUR 2.3/m³ (tanks) or EUR 5.8/m³ (lagoons) [14, Spain 2014].

Driving force for implementation

In some Member States, local regulations require that slurry stores are covered (e.g. Denmark and Germany from the mid-1980s). In the UK, all new and substantially enlarged slurry stores should be covered before use and all existing slurry stores must be covered by 2020 [524, UK EA 2012].

Inorganic covers, like geometrical plastic tiles, are an alternative to organic material covers, and require less maintenance. The ammonia that is not emitted can potentially generate more yield on the field, due to the increased nitrogen application per hectare. Inorganic covers may be useful for slurries that, coming from other treatments (biogas, separation, etc.) for example, do not have the ability to create natural floating layers because of their low dry matter content [216, Denmark 2010].

Example plants

It is estimated that 10 % of the Danish covers are made of light bulk material [217, Denmark 2010]. In Denmark, natural floating covers or straw crusts are estimated to represent the majority of the total covered slurry surface (about 80 %) [209, Denmark 2010]. In 2004, the proportion of stores with a natural crust applied on Danish pig farms was less than 50 %; 5 % were equipped with a fixed roof, around 5 % used peat or LECA, and almost half of stores were covered with straw added without stirring.

Peat is used in Finland.

Reference literature

[11, ADAS 2000] [14, Spain 2014] [26, Finland 2001] [43, COM 2003] [208, Spain 2010] [209, Denmark 2010] [214, Germany 2010] [216, Denmark 2010] [217, Denmark 2010] [259, France 2010] [379, Spain 2009] [439, Sommer et al. 2006] [474, VDI 2011] [499, AgroTech 2008] [506, TWG ILF BREF 2001] [508, TFRN 2014] [520, Fleming R. 2006] [521, Portejoie et al. 2003] [522, Loyon et al. 2007] [524, UK EA 2012] [556, ADAS 2000] [575, UBA Germany 2011] [590, Batfarm 2013] [592, R.Burns, L.Moody 2007] [624, IRPP TWG 2013]

4.11.2.5 Application of covers to earth-banked slurry stores (lagoons)**Description**

Lagoons tend to have a larger surface area per unit volume than tanks. Emissions to air can be reduced by decreasing the airflow across the surface by installing floating covers.

Flexible plastic sheet covers for earth-banked slurry stores are based on flexible impermeable UV-stabilised plastic sheets (e.g. HDPE) that are secured at the bank tops. Floats and tubes are installed to keep the cover in place (prevent the cover from turning during manure mixing and being lifted off by wind) and to allow it to float over the slurry as the level of liquid increases and decreases, while maintaining a void beneath the cover for the purpose of gas collection. Covers may be fitted with collection piping (gas vents) for the gases that develop on the covered surface or to negatively pressurise the cover [520, Fleming R. 2006]. Rainwater can be pumped off the top, preventing dilution [525, BPEX 2011].

Other applied floating covers are geometrical plastic tiles (e.g. hexagonal bodies), chopped straw, peat or a natural crust (see Section 4.11.2.4). The use of LECA and LECA-based products is also possible for smaller lagoons.

Achieved environmental benefits

Reductions in ammonia and odour emissions can be achieved. Ammonia emission reductions of about 95 % or more have been reported. Reduced ammonia emissions of 82 % are reported with the application of LECA. Chopped straw covers are reported to reduce ammonia emissions by 70 %, whilst natural covers reduce them by 28 % [379, Spain 2009].

Cross-media effects

For covering a lagoon, a large amount of plastic is needed. This can measure up to 70 % more than the actual lagoon surface area, depending on the depth and inclination of the edges. A benefit is that the cover can be reused, whereas other covers are consumables.

Floating covers such as chopped straw, LECA, peat, and oil-based liquids do not divert rainwater and require management time during store filling, mixing and emptying [648, DEFRA 2011].

There is the potential to apply the rainwater that gathers on top of plastic sheet covers to irrigation, but it would require careful monitoring of the water for slurry leakage or other contamination. Farmers are not in favour of recycling, for reasons of hygiene and disease control.

Stirring of the slurry would mix the slurry and its LECA layer, which would then increase ammonia emissions temporarily. It has been observed that the LECA cover re-establishes itself very quickly after stirring and that emissions again drop to a reduced level. However, LECA as a cover does create problems with landfilling. N₂O emission may be enhanced by the organic crust that develops on the surface.

Environmental performance and operational data

By keeping rainwater out, plastic covers could effectively increase the capacity of a lagoon by as much as 30 %. This would either give more storage flexibility over time or provide a larger capacity in case of an expansion in farm stocking.

The lagoon must be emptied completely of slurry and sludge to allow the fitting of the cover. Wind damage is not a problem if the cover is well fixed on the sides and if some rainwater is kept on top to weigh it down. Modifications to current agitation and emptying methods may be necessary but, with the relatively low dry matter content of pig slurry, mixing is not a problem. If adequate agitation cannot be performed, problems with sludge accumulation may arise after a number of years.

Lifetimes of flexible plastic sheet covers of up to 10 years have been reported. Precautions are recommended for the winter season to prevent the plastic sheet cover from tearing, i.e. removal of rainwater on top of the cover to minimise ice formation [520, Fleming R. 2006].

LECA can be blown onto the slurry surface or pumped with the slurry. The latter technique causes less dust and loss of material and has a higher rate of distribution. Mixing and pumping with slurry may damage the material and should be performed gently.

An artificial floating crust cover is the minimum mandatory requirement in Germany (5–10 kg of chopped straw per m², depending on the kind of slurry) to obtain a minimum reduction of 80 % of ammonia emissions compared to the uncovered surface.

Technical considerations relevant to applicability

Plastic sheeting is well tested on small earth-banked lagoons [508, TFRN 2014]. Plastic sheets can be difficult to fit and manage on larger lagoons [648, DEFRA 2011]. If lagoon walls are not accessible or structurally sound to allow anchoring of the plastic sheet, secured covers cannot be used; then the application of floating materials is possible [524, UK EA 2012]. Therefore, plastic sheets may not be applicable to large existing lagoons due to structural reasons.

Straw and light bulk materials may not be applicable to large lagoons where wind drift does not permit the lagoon surface to be kept fully covered. The use of light bulk materials is not applicable to naturally crusting slurries.

Agitation of the slurry during stirring, filling and emptying may preclude the use of some floating materials which may cause sedimentation or blockages in the pumps. Natural crust formation may not be applicable in cold climates and/or on slurry with a low dry matter content. Natural crusts are not applicable to lagoons where stirring, filling and/or discharging of slurry frequently disturbs the surface.

Economics

Total annual costs and emission reduction costs for different covers of earth-banked slurry stores (lagoons), in comparison with uncovered lagoons, are reported in Table 4.171 from Germany.

Table 4.171: Cost data for different covers of earth-banked slurry stores (lagoons), in Germany

Type of cover	Investment and annual costs ⁽¹⁾		Emission reduction and mitigation costs	
	Annual costs (EUR/m ³ /yr)	Investment costs (EUR/m ²)	EUR/kg NH ₃	EUR/kg NH ₃ ⁽²⁾
Uncovered (reference)	1.08	NI	NI	NI
Floating flexible cover	1.34	11.5	0.42	0.22
Light bulk materials	1.23	NI	0.26	0.07
Straw	1.35	NI	0.48	0.31 (2 times per year) 0.84 (4 times per year) ⁽³⁾

⁽¹⁾ Cost data refer to a lagoon with a capacity of 7 500 m³ (75 X 25 m). A storage duration of 6 months was assumed; the expenses presented are based on an annual slurry quantity which is twice as large as the usable capacity.
⁽²⁾ Cost data take into account the value of conserved nitrogen, the expenses for landspreading of precipitation water and the cost of the tank freeboard for containing precipitation water.
⁽³⁾ Costs are given for slurry application frequencies of two and four times per year.
 NB: NI = no information provided.
 Source: [575, UBA Germany 2011]

From the UK, examples of costs are reported for covering a slurry lagoon with a capacity of 4 540 m³ and a surface area of 2 000 m² (50 m × 40 m at the top of the lagoon and 4 m deep).

Table 4.172: Investment costs for covering a slurry lagoon in the UK

Type of cover	Investment costs ⁽¹⁾		Annualised costs ⁽²⁾
	EUR	EUR/m ²	EUR/yr
Floating flexible cover ⁽³⁾	75 000	37.5	5 681
Light bulk material (LECA) ⁽⁴⁾	75 000	37.5	NI
Geometrical plastic tiles	56 800	28.4	4 261 ⁽⁵⁾

⁽¹⁾ Values in EUR as per exchange EUR 1 = GBP 0.88.
⁽²⁾ Include capital repayment over a 20-year payback period, interest costs and maintenance costs.
⁽³⁾ Investment costs include the supporting grid and pump to remove rainwater, but do not include potential savings due to not having to spread rainfall with slurry.
⁽⁴⁾ 10 % annual replacement is included for 20 years.
⁽⁵⁾ Geometrical plastic tiles are 25 % cheaper than a floating flexible cover, but they do not prevent rainfall from entering the store, with the consequent need to dispose of the water with the slurry.
 NB: NI = no information provided.
 Source: [524, UK EA 2012]

The cost of constructing or expanding an impermeable lagoon store ranges between EUR 12.74 and EUR 24 per m³ of slurry in Spain. The variation depends on the soil type, dimensions of the lagoon and material utilised. Furthermore, the unit cost for chopped straw used for floating covers is reported as EUR 0.04–0.1/kg of straw [379, Spain 2009].

Additional costs will be incurred on farms where modifications are needed to the structure, or to emptying and agitation methods. Efficient rainwater management determines the differences in operating costs, where LECA-covered lagoons may coincide with higher slurry application costs and where application costs will be higher where rainwater can enter the slurry.

The cost of spreading the rainfall collected from an uncovered lagoon is estimated at EUR 1.6 per m³. Rainwater collected on the top of a floating flexible cover remains clean and can be pumped to ditches and watercourses. Every 500 mm of rainfall on a 2 000 m² slurry lagoon is equivalent to 1 000 m³ of water. Not having to spread it, at a cost of EUR 1.60 m³, gives a saving of EUR 1 600 per year. In areas with high rainfall, a cover could almost be cost-neutral [524, UK EA 2012].

With plastic coverings, net costs depend on the possibilities for reuse of water for irrigation. The use of biogas (methane) depends on the purpose (heating or engine) and on the installation requirements. It might be profitable but the cost recovery period might be quite long (over 20 years).

Driving force for implementation

In areas with high rainfall, placing a plastic sheet cover over the slurry surface can result in a significant reduction in overall slurry volumes with subsequent savings due to not having to transport and landspread the avoided larger volume of slurry and rainwater [524, UK EA 2012].

Example plants

In the Netherlands, covers on lagoons have been in use for many years [11, ADAS 2000].

Reference literature

[11, ADAS 2000] [208, Spain 2010] [379, Spain 2009] [508, TFRN 2014] [520, Fleming R. 2006] [524, UK EA 2012] [525, BPEX 2011] [556, ADAS 2000] [575, UBA Germany 2011] [648, DEFRA 2011]

4.11.2.6 Techniques to protect soil and water against emissions from slurry storage

Emissions of nitrate and phosphate to soil and water can be prevented by implementing certain requirements for the construction, maintenance and inspection of installations used for the collection and piping of liquid manure (channels, drains, pits, pipes, slide gates) and the storage of slurry.

4.11.2.6.1 Storage tank construction and auxiliary equipment for slurry collection and transfer

Description

Above-ground storage tanks are large, normally open-top, circular vessels made of steel or concrete. The base plate is concrete cast *in situ*, without joints whenever possible. Walls are concrete or made of circular sections of prefabricated steel with corrosion-resistant coating. The structure may have a covering lid. Slurry flows over the rim or below the slurry surface. Unloading pipes are fitted with at least two safety devices and sliding gates and pumps are easily accessible. The reinforced concrete that is used should be impermeable, with high frost and chemical resistance (see also Section 2.6.5.1).

For tanks made of prefabricated concrete elements and a concrete framework, the internal wall surfaces and a 0.5 m wide strip of the base need to be protected with a suitable permanently elastic coating or lining to bridge the cracks. The suitability of this should be attested by an inspection certificate.

Above-ground steel tanks require a coating (enamel or paint) to protect against corrosion. The suitability of the seal at the joint of the wall with the tank base needs to be certified. Base plates are made of concrete *in situ* and should be at least 18 cm thick.

Underground silos are built *in situ* with the same characteristics as the above-ground concrete silos, but obviously the base is not observable from the outside. In Germany, leakage checks are mandatory (geomembrane with drainage and leakage control) (see also Section 2.6.5.1).

Slurry pits are constructed of precast blocks or bricks, reinforced concrete, coated steel, polymer plastics and other suitable materials; they need to be leak-proof with an internal sealing or

lining. The same requirements apply to tanks of precast concrete blocks. The maximum slurry level may rise no higher than 10 cm below the pit cover or the floor grille.

Collection facilities such as channels, drains, pits, pipes and gate valves for the collection and piping of liquid manure, slurry and effluents (manure removal channels), the inlet to the slurry pit or pump station, and the slurry pit or pump station itself should all be fabricated of corrosion-resistant material. Return flow pipes of the storage tank are fitted with at least two safety devices. Gate valves have to be adjusted in such a way that they are easily accessible and are in an impermeable shaft. Pumps should be easily accessible. Constructions of the slurry pit and pump station have to be sealed and impermeable.

Transfer facilities are all structural/technical facilities intended for the homogenisation and transfer of slurry. This category also includes transfer areas with the relevant installations used for transfer (pumps, gate valves). Areas in which slurry is transferred must be impermeable to water and designed to drain into a tank without an outlet (e.g. slurry tank, pump station).

An example of an underground slurry tank made of concrete cast *in situ* with a liquid-tight geomembrane fixed to the tank is shown in Figure 4.79.



Source: [593, UBA Germany 2013]

Figure 4.79: Underground slurry tank with liquid-tight geomembrane

Achieved environmental benefits

Nutrient input (nitrates and phosphates) into underground and surface water is prevented.

Cross-media effects

None reported.

Environmental performance and operational data

After emptying a slurry store, inspection and maintenance will prevent a further risk of leakage. The application of double valves in pipes used for emptying the tank will minimise the risk of an unwanted discharge of slurry into the farmyard and surrounding premises (surface water). The use of block floodgates is an extra tool to limit leak risks [259, France 2010]. In Germany, construction of underground silos in areas with water protection legislation in place is not allowed.

Technical considerations relevant to applicability

The building of storage tanks that are able to withstand mechanical, chemical and thermal influences is generally applicable. The construction of leakproof facilities and equipment for collection and transfer of slurry is generally applicable.

Economics

The investment costs for underground tanks are higher than for above-ground tanks. Cost data reported for the construction of above-ground and underground silos for slurry storage are presented in Table 4.173.

Table 4.173: Cost data for above-ground and underground slurry silos

Type of silo ⁽¹⁾	Investment costs (EUR/m ³)	Total costs (EUR/m ³ /yr)	Source
Above-ground	35 (30–39)	3.2 (3.0–3.5)	[426, Germany 2010]
Above-ground, in water protection area	40 (35–45)	3.7 (3.5–4)	[214, Germany 2010]
Underground	55 (45–60)	5 (4.4–5.5)	[215, Germany 2010]

(¹) Silos with 1 500 m³ storage capacity; usable net volume (diameter 20 m, building height 5.2 m, usable height 4.7 m, freeboard 0.5 m).

Driving force for implementation

Local regulations and location in areas with water protection legislation in place are drivers.

Example plants

In Germany, the procedures for defining the dimensions, constructional design and materials for slurry stores, together with instructions on maintenance and inspection, are described in DIN Standards and are widely applied.

Reference literature

[214, Germany 2010] [215, Germany 2010] [259, France 2010] [426, Germany 2010] [593, UBA Germany 2013]

4.11.2.6.2 Measures to prevent and inspect leakage from slurry stores**Description**

In order to allow inspection of storage tanks for leaks during operation, the construction of a drainage system below the base plate is necessary, in addition to the basic requirements for the construction of slurry tanks to prevent leakage as described in Section 4.11.2.6.1.

Leakage inspection systems collect liquids in a leak-proof space below the base plate of slurry tanks. They consist of the following components:

- impermeable layer;
- drainage layer;
- drainage pipe;
- inspection pipe or shaft.

The impermeable layer is usually made of a heat-sealed flexible geomembrane, which is fixed liquid-tight to the tank to prevent infiltration of rainwater (see Figure 4.79). Alternatively, membranes may only overlap if there is a slope. Above the impermeable layer, the drainage layer is built up of gravel or plastics. Drainage pipes are embedded as a circumferential or area drainage system to discharge leaked slurry from the tank to the inspection pipe or shaft.

Circumferential drainage systems are adequate only in the case of heat-sealed geomembranes. They consist of a drainage pipe that is located below the rim of the base plate around the whole tank [214, Germany 2010].

In the case of area drainage systems, the drainage pipes are located in an array below the base plate. The drainage layer should have a minimum thickness of 20 cm and drainage pipes should be covered with a layer of at least 10 cm. The single drainage pipes are bundled in an inspection shaft.

Inspection pipes are placed at the above-ground level. They should be at least 20 cm in diameter, in order to allow sampling of water. Inspection shafts are usually made from shaft rings with a diameter of 80 cm (see Figure 4.80). Inspection pipes and the shaft are covered and liquid-tight to prevent infiltration of rainwater.

If water occurs in the inspection devices, contamination by slurry will be detected in water samples that will indicate a leakage of the slurry tank. The distance between the inspection devices should not exceed 15 m.

Achieved environmental benefits

Leakage inspection systems are an effective measure to protect soil and water against nutrient (N and P) losses.

Cross-media effects

Not relevant.



Source: [593, UBA Germany 2013]

Figure 4.80: Inspection shaft for area drainage pipes from a slurry store

Environmental performance and operational data

In addition to proper planning and construction according to the relevant local regulations, water protection requires careful operation and facility maintenance. The responsibilities of the facility operator include regular checks of the tightness of slurry tanks, pipes, and fittings, as well as the operability of the inspection equipment. The operator of a facility is required to monitor its compliance with regards to operation and leak-proofing at all times before and during operation of a slurry tank. In the case the filling-level inspection or inspection of the structural condition of the facility give rise to any suspicion of leakage, an immediate notification to the competent authorities is required.

In Germany, leakage checks (e.g. pressure tests) of underground pipes must be repeated approximately every 10–12 years. The results of the tests have to be kept on file and made available to the competent authorities on request.

Technical considerations relevant to applicability

The installation of a leakage detection system is only applicable to new stores. Checking the structural integrity of stores at least once a year is generally applicable.

Economics

Examples of investment costs for slurry tanks equipped with leakage inspection systems are reported by Germany and presented in Table 4.174.

Table 4.174: Investment costs for slurry tanks and leakage inspection systems in Germany

Dimensions				
Useable storage capacity ⁽¹⁾	500 m ³	1 500 m ³	3 000 m ³	5 000 m ³
Height	4.0 m	5.0 m	6.0 m	6.0 m
Inner diameter	13.5 m	20.5 m	26.5 m	34.0 m
Investment costs (EUR)				
Construction and materials				
Concrete (<i>in situ</i>)	29 800	48 500	80 500	115 300
Precast concrete elements	34 800	56 500	97 000	139 600
Steel, enamelled	39 200	63 800	107 200	153 300
Additional leakage inspection system ⁽²⁾	400	7 300	10 500	15 000
⁽¹⁾ With 20 cm freeboard and 30 cm buffer for rainwater.				
⁽²⁾ Circumferential drainage system with two inspection shafts.				
Source: [593, UBA Germany 2013]				

Driving force for implementation

General requirements of water legislation (Nitrates Directive, Water Framework Directive) are drivers. A leakage inspection system is mandatory for most slurry tanks in Germany and, at least, for tanks in areas where water resource management is a priority (e.g. areas with water protection legislation in place).

Example plants

Several hundred slurry tanks with leakage inspection systems are in operation in Germany.

Reference literature

[593, UBA Germany 2013]

4.11.2.6.3 Impermeable lining for earth-banked slurry lagoons

Description

Earth-banked lagoons are constructed with water-impermeable base and walls, e.g. with clay or plastic lining (see Section 2.6.5.2). Clay can be applied *in situ* or an appropriate clay lining is applied. A double-layered geomembrane can also be used.

Achieved environmental benefits

Nutrient leaching to surface and groundwater is prevented.

Cross-media effects

Not relevant.

Environmental performance and operational data

In Germany, for double-layered geomembrane lagoons, leakage control is mandatory. Pipelines are made of corrosion-resistant material and those for the return flow from the storage tanks are fitted with at least two safety devices. Slide gates and pumps are easily accessible. The slurry pit and pump station are sealed in an impermeable construction. Areas in which liquid manure/slurry is transferred are fenced and are designed to drain into a tank without an outlet (e.g. slurry tank, pump station). In addition to proper planning and construction according to the relevant regulations, water protection requires careful operation and facility maintenance. The facility operator is required to perform regular checks of the leakproofness of containers, pipes and fittings, as well to verify the good operating condition of the control equipment. Leak testing (e.g. pressure tests) of underground pipes should be repeated approximately every 10–12 years. Within areas with water protection legislation in place, the intervals are shorter.

Technical considerations relevant to applicability

Storing slurry in earth-banked stores (lagoons) with an impermeable base and walls, e.g. with clay or plastic lining (or double-lined), is generally applicable.

Economics

In Germany, for double-layer lining, investment requirements range from EUR 18 to EUR 24 per m³, for lagoons with a usable volume of 1 500 m³. The reported total annual costs are EUR 1.9–2.0/m³/yr.

Driving force for implementation

The solution implies lower investment costs than those for concrete silos. Water legislation in Germany requires that earth-banked lagoons are built with a double-layered geomembrane and a floating crust cover as a minimum.

Example plants

This technique is commonly applied.

Reference literature

[211, Germany 2010]

4.12 Techniques for the on-farm processing of manure

4.12.1 Introduction

Several techniques are available for manure processing and can be classified into four main categories:

- techniques for treating raw manure or a mixture with other organic matter;
- techniques for treating slurries (raw manure);
- techniques for treating liquid fractions after separation of raw manure;
- techniques for treating solid fractions or solid manures [594, Agro Business Park 2011].

Site-specific conditions, constraints and opportunities present at the local level, as well as farm requirements reflecting the local environmental conditions, determine the optimal combination of techniques belonging to the above groups (e.g. the nitrogen surplus) [590, Batfarm 2013]. In the event that local conditions are such that alternative costs (i.e. transport out of the region) are lower than the treatment itself, the treatment of manure is not to be pursued (e.g. in Ireland poultry manure is exported off site for use in the production of mushroom compost).

For example, in particular areas it is possible to find a combination of a high concentration of farms together with a lack of available land for spreading the manure in the vicinity of the farm. In these cases, in order to avoid an excess of nutrients in the soil, manure processing by one or more techniques which have the ability to reduce the nitrogen content in the slurry is an option. In other cases, treatment is necessary as there may be a critical situation in terms of odour nuisance due to landspreading, because of the proximity of residential areas. Treatment to minimise odour emissions can then allow more flexibility for identifying suitable sites and weather conditions for landspreading [624, IRPP TWG 2013].

Manure processing is mainly applied with the objective of improving manageability and utilisation of livestock manure; this includes balancing the quantity of nutrients with the crop requirements, wider options for returning the organic matter and nutrients to land in a more controlled way and improving the stability and plant availability of nitrogen and phosphorus. However, if conditions allow (e.g. large enough spreading area, local nutrient demand, compliance with local regulations), the spreading of untreated slurry in order to fertilise crops has to be preferred. For example, in the Baltic region, the over-supply of phosphorus with fertilisation has been studied and more than 40 techniques for manure processing have been identified [218, Baltic Sea 2020 2010].

Other objectives of manure processing may be the reduction of emissions to the atmosphere (NH₃, odours, GHG, etc.), the production of energy through anaerobic digestion, the removal of pathogens, or the removal of xenobiotic compounds (emerging pollutants). A processing strategy can consist of a single process or a combination of various unitary processes. Schematic representations of a number of manure processing strategies, which can be applied in cases of nutrient surplus, are presented in Figure 4.81.

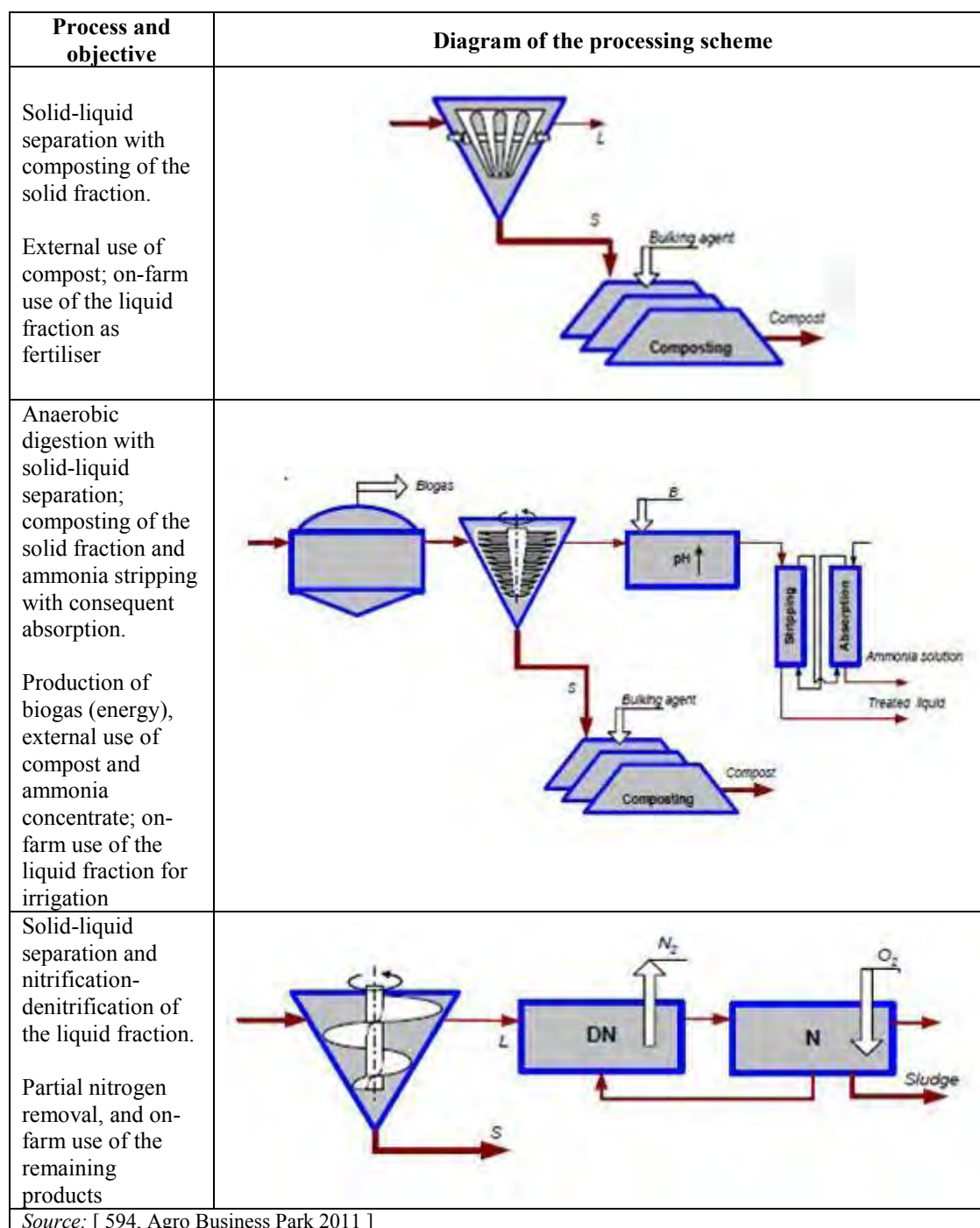

Figure 4.81: Examples of manure processing strategies

The technical and environmental performances of a manure processing technique, or a combination of different techniques (processing strategy), can be affected by:

- the characteristics of the manure;
- the features of the individual treatments applied;
- the way the techniques are operated.

The off-farm treatment of manure is not within the scope of this document, but it is widely applied and is likely to increase further in the future.

The attention given to manure processing is strongly influenced by the management costs of untreated manure. In the Netherlands, the on-farm treatment of manure is mainly based on mechanical separation techniques that are applied for intensive livestock farms without sufficient land and which have problems with manure transportation to other places. The basic separation techniques were developed in the 1990s and, although new separation techniques have been developed on an experimental scale (like membrane separation), the practical application of the techniques at the farm level has not really changed since then.

In Belgium (Flanders), the total costs of the most common techniques vary between EUR 20 and EUR 30 per treated m³. The economic analysis performed showed that manure processing is only economically feasible for 30 % of the pig farms. In areas with a medium to high manure pressure, slurry treatment is feasible only if farms are able to spread at least 80 % on their own farmland. In areas with a high quantity of manure produced, the pressure for implementing manure processing is even higher.

Economic analyses showed that large-scale, high-tech processing techniques are expensive and may only be affordable for farms with a high turnover, or in regions with high livestock densities, where all alternative solutions for manure management are even more expensive. In these cases, the cooperation between several farmers in the processing facility is necessary.

A summary of the main characteristics of the techniques for processing manure, as described in this section, is given in Table 4.175. Full descriptions and references are given in the relevant subsections.

Table 4.175: Summary of the main characteristics of techniques for processing manure

Section	Processing technology	Aim	Main environmental benefits	Main cross-media effects
4.12.2	Mechanical solid-liquid separation of slurry by: <ul style="list-style-type: none"> • screw press • decanter centrifuge • coagulation-flocculation • sieves-drum filters • filter press • air flotation • natural settling 	Separation and concentration of the solid and liquid fractions of slurry	Solid fractions easily exported outside the farm, reducing problems derived from nutrient surplus, reducing phosphorus accumulation and nitrate leaching to water	Risk of gaseous emissions. Indirect CO ₂ emissions due to electricity consumption
4.12.3	Aeration of liquid manure/biological treatment: <ul style="list-style-type: none"> • aerobic digestion • nitrification-denitrification 	Biological decomposition of organic matter. Removal of ammoniacal nitrogen as N ₂ gas	Pathogen and odour emissions reduction. Removal of biodegradable organic matter	Under non-optimal conditions, odour, CH ₄ and N ₂ O emissions may occur. NH ₃ emissions and loss of N fertilising value of slurry when combined with a nitrification-denitrification stage

Section	Processing technology	Aim	Main environmental benefits	Main cross-media effects
4.12.4	Composting of solid manure: <ul style="list-style-type: none"> • composting • co-composting of poultry manure with green residues • composting with a biological inoculum 	Obtain a stable product with a low moisture content and retaining most of the initial nutrients, free of pathogens	Substantial reduction of transport costs and related CO ₂ emissions, due to significant reduction of mass (water evaporation). Production of organic fertiliser. Removal of pathogens. Reduction of odour emissions	Emissions of NH ₃ , odour and CH ₄ during the process operation
4.12.5	Anaerobic treatment	Production of biogas. Mineralisation and stabilisation of organic matter	Reduction of GHG emissions by: <ul style="list-style-type: none"> - decreasing potential CH₄ emissions - decreasing fossil fuel consumption Reduction of pathogen content and increased hygienisation. Reduction of offensive odour	Uncontrolled leakages of biogas with a consequent emission of CH ₄ . Potential emissions from digestate storage (CH ₄ , H ₂ S, NH ₃ , N ₂ O)
4.12.6	Anaerobic lagoon system	Combined slurry stabilisation, separation and storage	Improved quality of solid and liquid fractions	High CH ₄ emissions
4.12.7 4.12.13	Evaporation and drying of manure. Slurry and wet manure belt dryer	Increase nutrients and organic matter concentration. Reduced volume for easier and cheaper transport	Dried, concentrated and hygienised product easy to handle, with moderate-high concentration of nutrients (N and P)	Heavy metals are concentrated in the concentrate stream that can limit product application or landspreading. Direct or indirect CO ₂ emissions, depending on the energy source used. High NH ₃ volatilisation
4.12.8	External tunnel for manure drying	Reduction of ammonia emissions by drying droppings collected by manure belts	Reduction of ammonia and odour emissions	Energy consumption, with indirect CO ₂ emissions
4.12.9	Slurry acidification	Reduction of ammonia emissions by lowering the pH of manure, with consequent ammonium (NH ₄ -N) retention in the manure	Reduction of ammonia emissions Possible reduction of CH ₄ emissions	Emissions of VOCs and odours from the oxidation reaction due to the addition of a strong acid
4.12.10	Combustion of poultry litter	Energy production by thermal oxidation of organic material. Energy recovery with possible transformation into electricity	Energy savings. Fertiliser value of the produced ashes	Emissions to air from combustion (NO _x , SO _x , etc.). Loss of N as fertiliser and organic matter of manure

Section	Processing technology	Aim	Main environmental benefits	Main cross-media effects
4.12.11	Ammonia stripping	Removal of ammonia through volatilisation from a liquid phase, with subsequent recovery in an acidic solution as ammonium salt or by condensation	Less nitrogen content in slurries, with consequent easier management on farm. Reduced odour emissions from manure landspreading. Recovery of a valuable nutrient (nitrogen)	Energy consumption, with indirect CO ₂ emissions
4.12.12	Manure additives	Facilitate handling and management of manure. Stabilisation of manure and reduction of the pathogen contents	Reduced ammonia, odour and GHG emissions. Reduced content of pathogens	High variability in efficiency

Other techniques are being studied, with promising results. These techniques are not yet available for on-farm application at reasonable costs, but are worth mentioning [256, VITO 2006]:

- Membrane filtration: after pre-filtration, reverse osmosis is used to separate nitrogen, potassium and phosphorus salts from water.
- Struvite (magnesium ammonium phosphate) precipitation: the addition of MgO or MgCl₂ and H₃PO₄ results in the precipitation of magnesium ammonium phosphate, with the consequent possible recovery of both phosphorus and ammoniacal nitrogen. Treatment plants based on this technique have been set up in the Netherlands and Germany.
- Algae culture.
- Activated carbon filtration.
- Ion exchange.
- Wet oxidation.

4.12.2 Mechanical separation of slurry

4.12.2.1 Introduction

Description

The mechanical separation of coarse, fibrous material from liquid manure, especially slurry, aims to produce a more free-flowing liquid fraction and a stackable solid fraction. These products are easier to manage than slurry.

The liquid fraction can be stored and/or transported/pumped to fields for landspreading with a lower nutrient content. It can also be further processed *in situ* (e.g. aeration) before its use for rinsing/cleaning purposes or as fertiliser. The liquid fraction requires less power for pumping through pipes, for mixing and for aeration and is less likely to form a crust or sediment during storage.

The solid fraction is managed as solid manure (e.g. it can be stored on a concrete pad) and can be spread on remote areas with a nutrient demand or can be applied in other processes (e.g. composted, anaerobically digested). Nutrients (N, P, K) and organic matter are concentrated in the solid fraction, thus enhancing the capability of manure/slurry management.

There are several different types of machines with different principles of operation that produce liquid and solid fractions in different proportions and with different dry matter contents. These include:

- screw press separator (see Section 4.12.2.2);
- decanter-centrifuge separator (see Section 4.12.2.3);
- separation by sieves (see Section 4.12.2.5);
- filter pressing (see Section 4.12.2.6).

Separation can be enhanced by coagulation-flocculation of solid particles as part of the treatment process (see Section 4.12.2.4).

Achieved environmental benefits

Mechanical separation of slurry does not create any environmental benefits in itself. However, positive environmental effects can be derived from how the liquid and solid fractions are stored and used after separation. The benefits of slurry separation strongly depend on the separation efficiency, which can vary significantly, making slurry separation unattractive if the efficiency of the process is poor. The management of two separated fractions, the liquid with the higher nitrogen content and the solid richer in phosphorus, allows for a more accurate dosing of the nutrients, thus limiting the risk of an excess supply of nitrogen and phosphorus.

Mechanical separation of slurry may help to reduce an excess of nutrient supply at a local level (nitrate leaching and phosphorus accumulation), e.g. in areas that drain to vulnerable aquatic environments such as Natura 2000 sites, lakes, fjords, and sensitive zones for drinking water supply. In this case, it is assumed that the solid fraction is not delivered as fertiliser in the same area along with the liquid fraction but, instead, is further processed (e.g. as substrate in biogas plants) or used for purposes other than agriculture (e.g. for incineration), or delivered as fertiliser in areas with a low livestock density and/or nutrient deficiency or where fields are not commonly supplied with organic matter [223, Denmark 2010].

In Denmark in 2007, over half of the solid fraction produced was applied to the farmland, around 40 % was delivered to biogas plants, while only a small proportion was incinerated or utilised in some other way [227, Denmark 2010].

Landspreading of the thinned, separated liquid fraction results in a faster penetration into the soil, because of the low dry matter content, with consequently lower ammonia and odour emissions and lower contamination of the crops. The organic load in terms of COD and BOD is lower. The faster infiltration into the soil also allows better handling and evenness of spread [203, ADAS 2005].

An overall assessment of the environmental benefits achievable with slurry separation includes avoided CO₂ emissions from reduced transport (which are counterbalanced by increased electricity demand during the process of separation and depend on the distance that the solid fraction is transported) and from possible biogas production, as well as reduced indirect emissions associated with the avoided production of the mineral fertilisers for the supply of phosphorus [499, AgroTech 2008].

Cross-media effects

A common potential cross-media effect for all separation techniques is that during operation some ammonia volatilisation and odour emissions may occur, depending on the specific system in operation, as a result of the high level of exposure to air due to increased mixing of the slurry or systems that employ considerable stirring. In closed systems (e.g. a centrifuge separator or a press auger), and when coverings are in place, the release of odour is limited. Likewise, the slurry separation may result in a marked increase in NH₃ and N₂O emissions during the storage phase of the two fractions, because of the large emissions from the stored solid fraction, if it is

not covered [624, IRPP TWG 2013]. The solid fraction may result in N₂O emissions of up to 4.8 % of the initial total N over a 4-month period of storage [443, Chadwick et al. 2011].

Additionally, in areas where only low-phosphate fertilisation is allowed, a cross-media effect will be that the organic material cannot be spread on agricultural soils [624, IRPP TWG 2013].

Environmental performance and operational data

The main technical characteristics of some of the applied techniques for mechanical separation are summarised in Table 4.176, as reported by the Netherlands. Among other factors, the energy consumption needed to separate manure depends on its dry matter content. Efficiencies and solid phase characteristics normally depend on the slurry type and equipment used for the separation.

In general, a high dry matter content yields a better separation result of all dry matter, N, P, and K, hence separation of fresh manure is preferred because stored manure usually has a lower dry matter content [219, Netherlands 2010].

Table 4.176: Characteristics and technical data of common slurry separators in the Netherlands

Technique	Flow rate (m ³ /h)	Capital cost (thousand EUR)	Phosphorus separation efficiency (%)	Dry matter content in solid phase (%)	Specific energy consumption (kWh/m ³ slurry) ⁽¹⁾	Remarks
Inclined sieve, drum filter, drum filter with press rolls, etc.	10–20	10–30	< 30	< 25	0.5	Some types have very low P separation efficiency
Screw press	4–15	> 25	20–40	25–35	1.0	Average separation efficiency
Filter belt press	4–30	> 70	50–75 ⁽²⁾	20–25	0.1	Additives needed, high efficiency
Centrifuge-Decanter	4–100	> 100	60–70 ⁽³⁾	25–30	4.0	High efficiency, high maintenance

⁽¹⁾ The energy consumption of a slurry separation installation is often given excluding the basic peripherals such as mixers, pumps, conveyor belt systems, compressors, etc. This leads to an underestimation of the costs in this table. For example: a mobile centrifuge with a high capacity could be outfitted with a generator for the required electrical power. Fuel consumption of this generator could be estimated to be 1 litre of diesel/m³ of manure processed (this yields about 10 kWh/m³ of manure treated).

⁽²⁾ Using additives.

⁽³⁾ Without using additives.

Source: [219, Netherlands 2010]

Sequential separation using different techniques with recycling of liquids and solids can yield a higher concentration of the solid fraction. With the use of additives, the phosphate separation efficiency can be increased to over 60 %.

It should be considered that a single separation process is very rarely sufficient to achieve both a highly concentrated solid fraction and a clarified liquid. A multi-stage process, with recycling of liquids and solids, is needed if both objectives are important [203, ADAS 2005]. When the size of solids in the slurry is very heterogeneous, a combination of separation systems may be applied, such as the use of a grid followed by a finer separation stage, in order to separate big particles that can block transfer elements such as pumps and pipes.

Separation, but also other manure processing techniques, should be carried out in such a way that the final product is competitive with mineral fertilisers and untreated manure by adjusting its properties (e.g. nutrient composition) according to the needs of farmers.

Technical considerations relevant to applicability

The technique is only applicable when:

- the farm is situated in an area with a nutrient surplus and a reduction of the nitrogen and phosphorus content is needed due to the limited land available for manure application;
- manure cannot be transported for landspreading at a reasonable cost.

Economics

Costs vary widely reflecting sophistication and performance. Normal depreciation periods could be 5, 7 or 10 years, whereas maintenance costs could represent between 2.5 % and 40 % of the initial investment. Mobile separation units serve several sites but have higher maintenance needs than on-farm separator units. Costs of mechanical separators in the Netherlands are presented in Table 4.177.

Table 4.177: Costs of slurry mechanical separation in the Netherlands for an annual capacity of 5 000 m³

Technique	Investment	Depreciation	Electricity	Maintenance	Additives	Total
	EUR	EUR per treated m ³ of liquid manure				
Sieve separators	25 000	0.50	0.06	0.25	0	0.81
Screw press	30 000	0.60	0.12	0.30	0	1.02
Filter belt press	70 000	1.40	0.01 ⁽¹⁾	0.70	1.00 ⁽²⁾	3.11
Centrifuge separator	100 000	2.00	0.48	1.00	Option ⁽³⁾	3.48

⁽¹⁾ 1 kWh equals EUR 0.12.
⁽²⁾ Additionally needed: flushing water (10 bar), compressed air (8 bar).
⁽³⁾ Additionally needed: anti-foam agent (PM).
Source: [219, Netherlands 2010].

Driving force for implementation

The major driving force for implementing slurry separation is related to local regulations and conditions, such as scarce availability of land for manure application (e.g. in the Netherlands) or restrictions on the application of phosphorus.

The separated fractions (solid and liquid) are easier to transport. In addition, separation enables greater flexibility in manure management and application timing. Storage requirements and transportation costs of the liquid fraction are reduced as a 5–10 % reduction of volume is typically achieved by separation [648, DEFRA 2011], the solid fraction can be transported more easily and material is more homogeneous for landspreading.

Example plants

A survey showed that slurry separation was practised in about 11 000 farms of different sizes, with 80 % of the farms located in Italy, corresponding to about 45 % of the total treated manure covered by the survey. The most commonly used separation techniques are drum filters, screw pressing and separation by sieves, representing respectively 42 %, 33 %, and 18 % of the total European farms applying a slurry separation system [595, Agro Business Park 2011].

In the district of Vendée in France, a mobile separator moves from farm to farm to separate the duck slurry. The solid fraction is composted [259, France 2010].

Reference literature

[203, ADAS 2005] [219, Netherlands 2010] [220, Germany 2010] [221, Denmark 2010] [222, Denmark 2010] [223, Denmark 2010] [227, Denmark 2010] [259, France 2010] [443, Chadwick et al. 2011] [499, AgroTech 2008] [595, Agro Business Park 2011] [624, IRPP TWG 2013] [648, DEFRA 2011]

4.12.2.2 Screw press separator

Description

This technique is based on the application of pressure to separate by filtration the suspended solids contained in the slurry into a solid and a liquid fraction. A screw or auger rotates inside a cylindrical metal tube, squeezing out the liquid fraction and discharging the solid fraction at the end of the tube.

Slurry is either pumped into the separator directly or it flows through a funnel with the aid of a vibration unit to facilitate the even material flow into the press, in particular when slurry is thick. At the press, the slurry enters a cylindrical screen (0.5–1 mm) by means of a rotating screw, which conveys the slurry into the pressure zone. The liquid passes through the screen and is collected in a container surrounding the screen. At the end of the axle, the fraction rich in dry matter is pressed against a cylindrically shaped screen. The slurry filter cake is compressed during pressure filtration, producing a solid fraction with a high dry matter content. Increasing the applied pressure increases the dry matter content of the solid fraction.

A schematic representation of a screw press is given in Figure 4.82.

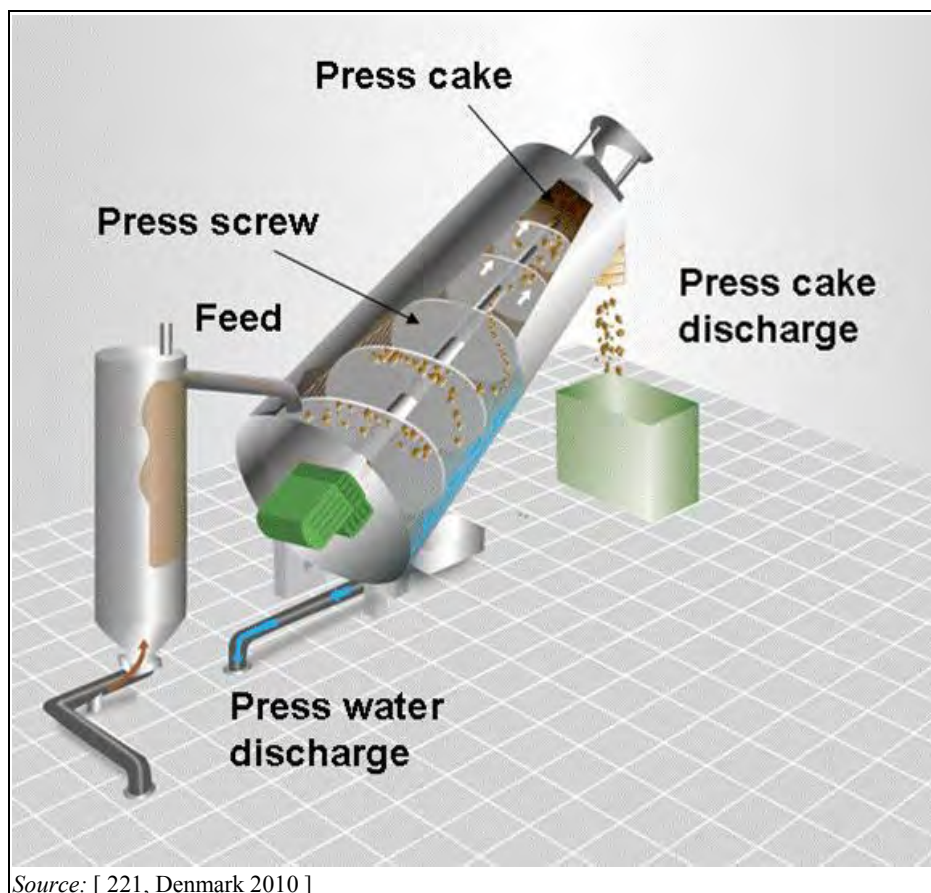

Source: [221, Denmark 2010]

Figure 4.82: Screw press scheme

Achieved environmental benefits

The separation of the initial nitrogen and phosphorus content of the slurry into two fractions (liquid and solid) allows a reduction of the problems related to a nutrient surplus, i.e. phosphorus accumulation and nitrate leaching to water. See also Section 4.12.2.1.

Cross-media effects

Cross-media effects may include energy consumption (electricity) to run the equipment, with associated indirect emissions. During operation, ammonia volatilisation and odour emissions may occur, depending on the specific system in operation.

Environmental performance and operational data

4–20 tonnes of slurry per hour can be treated, depending on the type of separator used and the dry matter content of the slurry. Examples from Germany and Denmark, concerning the characteristics of input and output materials, show that after processing slurry with a dry matter content of 6.5–7 % in a screw press, a liquid fraction of 3–4.4 % and a solid fraction of 20–30 % of dry matter content can be separated. The range of performance of a screw press is presented in Table 4.178.

Table 4.178: Separation performance range of a screw press

Parameter	Liquid fraction	Solid fraction
	% of input	
Mass flow	75–85	15–25
Total solids	40–80	20–60
Volatile solids	30–70	30–70
COD	40–70	30–60
Nitrogen	60–90	10–40
Phosphorus	20–70	30–80
<i>Source: [561, Flotats et al. 2004]</i>		

The energy consumption (electricity) to run the equipment depends on the input material (slurry, digestate) and varies from 0.3 kWh to 1 kWh per tonne of input material.

Technical considerations relevant to applicability

The technique is generally applicable to a wide range of dry matter contents of the slurry, as well as for processing digestate from biogas production. Only slight adaptation is necessary in existing farms, e.g. inclusion of a storage plate for the solid fraction.

Economics

Investment costs for a unit with a capacity of 8–20 tonnes/hour are reported to be in the range of EUR 20 000–45 000. Depending on the capacity of the processing unit and the dry matter content of the slurry, investment costs can also be expressed as EUR 2 000–5 000 per tonne per hour. With an amortisation period of 10 years and a 6 % interest rate, the annualised investment costs are EUR 260–650 per tonne of treated slurry or EUR 3 300–4 600 per unit. From a plant located in Spain treating 10 000 m³/year, the estimated investment cost of the screw press is reported to be EUR 28 000 [594, Agro Business Park 2011].

Extra operating costs are reported from Germany in the range between EUR 0.6 and EUR 1.25 per animal place per year, or between EUR 0.9 and EUR 1.87 per tonne of treated slurry. These are calculated for a unit with a treatment capacity of 10 m³/h, 5 kW of power installed (cost of electricity EUR 0.15/kWh), serving farms of 2 000 or 5 000 animal places, respectively, which produce 1.5 m³ of slurry per animal place annually. Treatment costs are also reported as EUR 0.5–0.9 per m³ of input slurry; for a unit with a treatment capacity of 10 000 m³/h, operating costs are reported as EUR 0.66/m³ [594, Agro Business Park 2011].

From Denmark, annual operating costs are estimated to be in the range of EUR 0.14–0.17 per tonne of input. The labour demand in Denmark is estimated to be approximately 0.1–0.25 hours per working day. In the Netherlands, for a capacity of 4–15 m³/h and an annual treated quantity of 5 000 m³, investment costs of over EUR 30 000, and operating costs of at least EUR 1.02/m³, are reported (see Table 4.176).

Driving force for implementation

Local restrictions on nutrient supply and lower transportation costs due to reduced transported volumes are drivers. See also Section 4.12.2.1.

Example plants

In 2009, at least 3 600 screw presses for the separation of slurry were in operation in Europe.

Reference literature

[220, Germany 2010] [221, Denmark 2010] [561, Flotats et al. 2004] [594, Agro Business Park 2011] [595, Agro Business Park 2011]

4.12.2.3 Decanter-centrifuge separator

Description

This mechanical separator relies on rapid rotation generating a sufficient centrifugal force to cause the separation of solids from the liquid. There are vertical and horizontal types of decanter centrifuges. The slurry enters the decanter centrifuge in the centre of the machine, which rotates at a high speed, typically 3 000–5 000 rpm. The centrifugal force separates solids and liquids at the wall into an inner layer with a high dry matter concentration and an outer layer consisting of a liquid containing a suspension of colloids, organic components and salts. The solid particles of the slurry are conveyed towards the conical end and let out through the solid discharge openings, whereas the supernatant flows towards the larger end of the cylinder formed by the bowl and the flights of the conveyor. The liquid phase is discharged through openings at the wide end of the decanter centrifuge. A macerator can be used before the decanter to shred the large particles into smaller ones.

A schematic representation of a decanter-centrifuge slurry separator is shown in Figure 4.83.

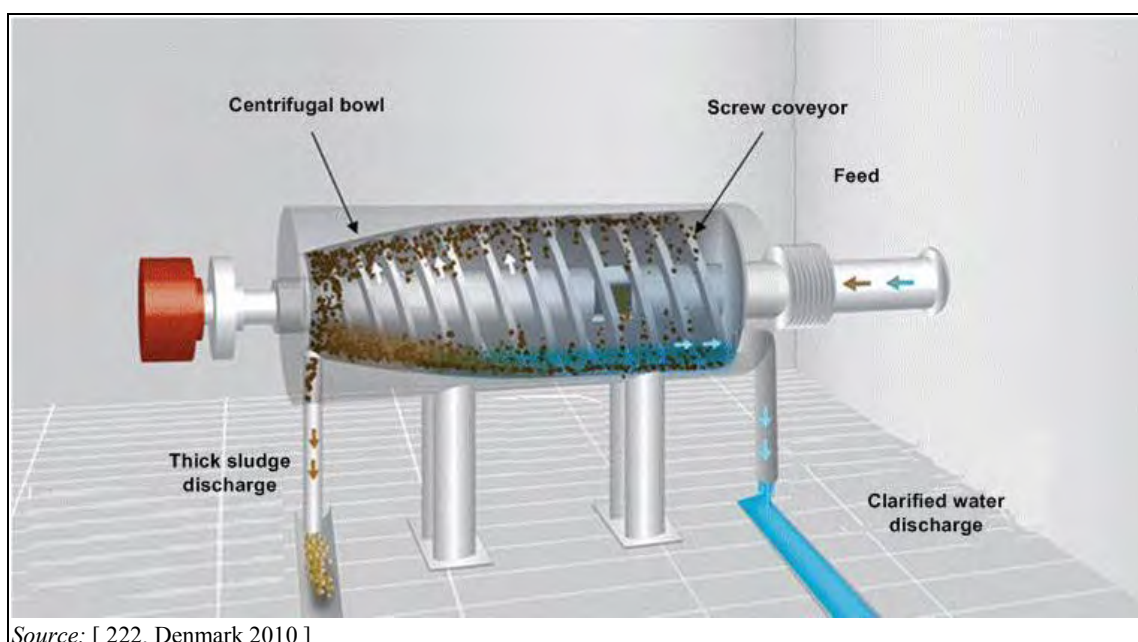

Figure 4.83: Schematic of a decanter centrifuge for slurry separation

Achieved environmental benefits

The separation of the initial nitrogen and phosphorus content of the slurry into two fractions (liquid and solid) allows a reduction of the problems related to a nutrient surplus, i.e. phosphorus accumulation and nitrate leaching to water. See also Section 4.12.2.1.

Cross-media effects

Energy consumption (electricity) is required to run the equipment, with associated indirect emissions.

Environmental performance and operational data

Fixed systems have a capacity of approximately 6 tonnes per hour, whereas mobile units can have a larger capacity of 10–25 tonnes per hour. In order to enhance the separation efficiency, the use of polyelectrolytes is normally considered. The main characteristics of the input and output flows of a decanter centrifuge for separation of typical pig slurry in Denmark are shown in Table 4.179.

Table 4.179: Characteristics of the separated fractions from a decanter-centrifuge separation of typical pig slurry in Denmark

Treated matter	Dry matter (%)	Total N (kg/t)	Total P (kg/t)
Input	5.0	4.0	1.0
Output: separated liquid phase	2.2	3.2	0.3
Output: separated solid phase	18	6.6	4.3
<i>Source: [222, Denmark 2010]</i>			

Centrifugation is the technique that reports the higher separation efficiencies. The average efficiency of centrifugation, as a separation technique, expressed as proportions of the solid fraction, is reported to be: 14 vol-%, 61 % dry matter, 28 % Total N, 16 % NH₄-N, and 71 % Total P. In Denmark, the proportion of total nitrogen in the dry matter fraction from the centrifuge is between 18 % and 28 % and the proportion of phosphorus in the solid fraction after separation is between 60 % and 70 %. Additional operational data are reported in Table 4.176.

Increasing the retention time by reducing the volumetric feed rate has been observed to increase the efficiency of the separation of slurry. The separation efficiency of dry matter increases with a higher dry matter content of the slurry. There are differences in the capacity between fixed centrifuges and mobile centrifuges. In Denmark, fixed systems have a capacity of approximately 5–7 tonnes/hour, whereas mobile units can have a higher capacity of 10–25 tonnes/hour [596, Denmark 2009].

The energy consumption for the operation of a decanter centrifuge is reported to be in the range between 2 kWh/m³ and 4 kWh/m³ [594, Agro Business Park 2011]. From Denmark, the energy consumption is reported as about 2.5 kWh per tonne of treated slurry.

Technical considerations relevant to applicability

There are no restrictions for the application of this technique.

Economics

The cost of the fixed configuration of the equipment is reported from Denmark to be in the range of EUR 19 000–21 000 per hourly tonne of capacity, or approximately EUR 115 000 for a system with a capacity of six tonnes per hour. The operating costs have been measured as EUR 0.3–0.6 per tonne of treated slurry. Labour requirements are estimated to be approximately 0.25 h/working day.

Other reported data indicate investment costs of between EUR 40 000 and EUR 60 000, for a treatment capacity of 1.5–2 m³/h, and treatment costs are reportedly in the range of EUR 0.6–2.3 per m³ of input slurry [594, Agro Business Park 2011]. From the Netherlands, for a capacity of 4–100 m³/h, investment costs are reported to be over EUR 100 000 and operating costs at least EUR 3.48/m³ for an annual treated quantity of 5 000 m³ (see Table 4.176).

Driving force for implementation

Local restrictions on nutrient supply for agriculture can force the use of systems that reduce transport costs by means of reduced volumes to be transported. See also Section 4.12.2.1.

Example plants

The technique itself is known and widely used in the industry, in waste water treatment, and in biogas plants. In Denmark, five units, mobile or fixed, are in use for the separation of pig slurry; another three units are reported to be in operation in Spain. The system is widely used in France, combined with biological treatment (aerobic and anaerobic) and for on-farm filtration.

Reference literature

[222, Denmark 2010] [594, Agro Business Park 2011] [596, Denmark 2009]

4.12.2.4 Coagulation-flocculation

Description

Coagulation-flocculation is not a separation treatment in itself; it is a chemical pretreatment that improves the subsequent mechanical solid-liquid separation of the slurry. Multivalent cations (e.g. $Al_2(SO_4)_3$, $FeCl_3$) and/or polymer flocculants (e.g. polyacrylamide, chitosan) are added to the slurry in order to achieve particle aggregation.

Flocculant agents aggregate suspended particles into larger particles whose size and other physical properties make them easy to separate from the liquid fraction. The addition is done in a small mixer tank, to achieve a satisfactory particle aggregation, before mechanical separation in a screw press, band filter, or decanter-centrifuge system. Prior to flocculation, a pretreatment step may be needed (e.g. by a filter belt press to remove 1–2 % of the dry matter content) in order to avoid the risk of clogging during the process and to lower the required consumption of chemicals. The aggregated clumps can be removed by sedimentation, filtration or flotation.

A schematic representation of the coagulation-flocculation process is shown in Figure 4.84.

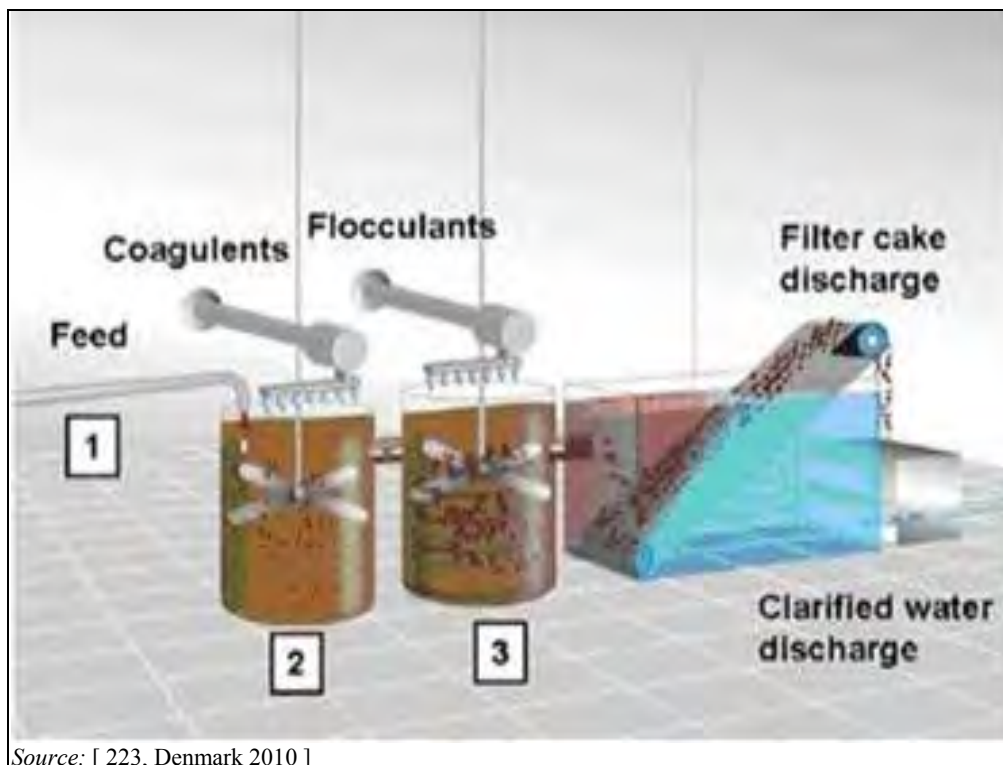

Figure 4.84: Schematic representation of a coagulation-flocculation pretreatment for slurry separation

If both additives are used, the multivalent ion is added first to the slurry. Several minutes of slow stirring are necessary to ensure homogeneous distribution of ions and dry matter and for charge neutralisation and coagulation to occur. Afterwards, the polymer is slowly added in small doses during vigorous stirring, followed by slow stirring, which is necessary for polymer bridging and patch flocculation to occur. The stirring conditions applied by the impeller (i.e. time and speed) have a large impact on the formation of the aggregates; too slow stirring causes the aggregates to be non-uniform and unstable with a low particle catchment, while too much stirring causes the aggregates to be destroyed [594, Agro Business Park 2011].

Achieved environmental benefits

The technique can significantly increase the efficiency of the separation of organic matter and nutrients in the solid fraction compared with other solid-liquid separation techniques. See also Section 4.12.2.1. The liquid fraction resulting from a mechanical separation treatment which is enhanced by chemical flocculation contains very low levels of phosphorus and has a low dry matter content (e.g. about 1 %) which allows a fast infiltration of slurry into soil after landspreading and, therefore, NH₃ emissions to air are reduced.

Cross-media effects

Electrical energy is needed to run the pretreatment (coagulation-flocculation), with associated indirect emissions. The environmental and health consequences of emission of flocculants to the environment, when applied to land, have not been fully investigated. The monomers of polyacrylamide (PAM), used in most slurry separation studies, can be toxic, and potentially carcinogenic. It has been shown that PAM degradation is rather limited in soil; it accumulates in the environment, does not degrade in the biogas production process, and easily dissolves in water, making it difficult to trace [527, Hamelin et al. 2010].

On the other hand, the results of a study carried out on separated slurry products report the risk to be minimal if a biological post-treatment is applied, since PAM is degraded in biological processes without acrylamide accumulation [594, Agro Business Park 2011].

Environmental performance and operational data

The characteristics of the treated fractions are shown in Table 4.180, for typical pig slurry, in Denmark and in Finland.

Table 4.180: General characteristics of the incoming slurry and the produced fractions after a mechanical separation process including flocculation

Treated matter	Dry matter (%)	Total N (kg/t)	Total P (kg/t)
Input	5.0	3.78–4.0	1.0–1.1
Separated liquid fraction	1.0–1.5	1.8–2.9	0.1–0.3
Separated solid fraction	30	8.6–11.0	7.0–7.9

Source: [223, Denmark 2010] [447, Finland 2013]

In Denmark, the proportion of total nitrogen in the dry matter fraction after separation with flocculation and a screw press is equal to 27 %. The respective proportion of phosphorus is reported to be 55 % [223, Denmark 2010]. In Finland, a flocculation-enhanced separation consisting of a belt filter and a screw press removes from the raw slurry almost 50 % of the nitrogen and more than 90 % of the phosphorus [447, Finland 2013]. Additional operational data from the Netherlands are also presented in Table 4.176 (see Section 4.12.2.1).

The process is reported to be very sensitive to the polyacrylamide concentration; an increase from 120 mg/kg to 140 mg/kg is capable of almost tripling the total dry matter of the solid fraction, but increases the ammonia and organic contents. As a result, the use of a

polyacrylamide concentration greater than 120 mg/kg is not recommended where further anaerobic treatment is required [203, ADAS 2005].

Energy consumption for the application of this pretreatment (coagulation-flocculation) in combination with sieve separation treatment is reported to be in the range of 0.7 kWh to 2.0 kWh per tonne of manure. In a combined system in Finland, consisting of a filter belt, flocculation and a screw press, the energy requirement is reportedly around 3 kWh per m³ of treated manure [447, Finland 2013]. Flocculation is often used in combination with screw presses.

Technical considerations relevant to applicability

The technique is generally applicable to all types of slurry. The use of polyacrylamide as a flocculant may not be applicable due to the risk of acrylamide formation.

Economics

From Denmark, a cost of EUR 20 000 is reported for each tonne/hour of capacity, for the application of coagulation-flocculation in combination with a sieve separator, which means approximately EUR 140 000 for a system with a capacity of 7 tonnes per hour. The annual operating costs have been calculated as EUR 1.3 per treated tonne. From other sources, operating costs are reported as EUR 0.8 per tonne of input slurry, and the investment costs around EUR 50 000 [594, Agro Business Park 2011]. From Finland, the annual cost of polymers for flocculation is reported to be EUR 3 000 for treating 6 000 tonnes of slurry per year [447, Finland 2013]. The labour demand in Denmark is estimated at approximately 0.25 h per working day.

Driving force for implementation

Sedimentation and separation are enhanced. A higher efficiency of mechanical separation techniques is achieved by modification of the particle properties, especially for separating particles belonging to the smallest particle fraction. The sediment of the flocculation and the solids from the subsequent mechanical separation treatment can be dried or further separated (e.g. using a screw press) into a solid fraction that contains most of the phosphorus from the raw slurry. The costs of manure storage, transport and application are reduced, which are key factors in areas with intensive livestock production. See also Section 4.12.2.1.

Example plants

The technique is relatively well known and is widely used for waste water and sewage treatment. It is estimated that in 2009 there were between 30 and 40 units in operation in Denmark for the separation of slurry with chemical precipitation by coagulation-flocculation, most of which are for pig slurry. In 2013 in Finland, this technique was in use on two pig farms and one dairy farm. The technique is also applied in France and Spain.

Reference literature

[203, ADAS 2005] [223, Denmark 2010] [447, Finland 2013] [527, Hamelin et al. 2010] [594, Agro Business Park 2011] [447, Finland 2013]

4.12.2.5 Sieve separation

Description

Sieve separators may be static (inclined), vibrating or rotating (drum). The liquid slurry flows through a screen of a specified pore size, which allows only solid particles smaller in size than the openings to pass through, and is drained off. Sieve separation is used as a pretreatment in order to avoid sedimentation during slurry storage, as a conditioning process before pumping, or in combination with more efficient separation systems.

In vibrating sieves, slurry is fed onto a mechanically vibrated, perforated screen so that a liquid fraction drains through. In inclined sieves, slurry flows down a sloping wedge-wire screen

designed so that a liquid fraction drains through. In drum sieves, slurry is squeezed through a large perforated metal cylinder by a pair of rollers. The material flows through the inside and the liquid passes through the drum. Eventually, the drum can be mounted with a fibre cloth on the outside to optimise the separation. An example of a rotating (drum) sieve separator is given in Figure 4.85.



Source: [594, Agro Business Park 2011]

Figure 4.85: Illustration of a rotating (drum) sieve separator used for slurry

Achieved environmental benefits

The separation of the initial nitrogen and phosphorus content of the slurry into two fractions (liquid and solid) allows a reduction of the problems related to a nutrient surplus, i.e. phosphorus accumulation and nitrate leaching to water. See also Section 4.12.2.1.

Cross-media effects

See Section 4.12.2.1.

Environmental performance and operational data

This type of separator generally works better for slurry with a low solids content (< 2 %). A compromise between sieve size, separation performance and risk of clogging is normally selected. Indeed, sieve clogging is one of the most common problems of static screens. This risk is lower in vibrating sieves due to the vibration. If the flow is too high, a large amount of water can remain in the solid fraction. On the other hand, such devices need a constant supply of slurry to prevent the particles drying out.

The separation efficiency for drum filters, expressed as a proportion of the solid fraction, is reported to be: nitrogen 20 %, phosphorus 30–55 %, total volume 25–27 %, and dry matter 12 %. An example of drum separation applied to pig slurry is presented in Table 4.181.

Table 4.181: Example of pig slurry separated with a drum sieve

	Dry matter (%)	Total N (kg/t)	NH ₄ (kg/t)	P (kg/t)	K (kg/t)
Untreated slurry	4.9	5.0	3.5	1.0	3.5
Solid fraction	10.4	5.3	3.5	1.4	3.8
Liquid fraction	2.9	4.7	3.4	0.8	3.3

Source: [594, Agro Business Park 2011]

Drum filtration is often used in combination with chemical flocculation. The drum sieve often has a lower capacity compared to a centrifuge, but it has fairly good separation efficiency in

relation to its low investment cost. The energy consumption for a drum sieve is reported to be equal to 1 kWh/m³ of slurry. Additional operational data are presented in Table 4.176.

Technical considerations relevant to applicability

No technical restrictions are reported for the implementation of the technique.

Economics

Investment costs are reported to be EUR 3 500–8 000 for a static sieve, EUR 15 000 for a vibrating sieve and EUR 25 000 for a drum sieve (with a capacity of 2–3 m³/h). The operating costs for the drum sieve are reported as EUR 0.35 per m³ of slurry.

For a capacity of 10–20 m³/h, investment costs ranging between EUR 10 000 and EUR 30 000 are reported from the Netherlands, with operating costs of at least EUR 0.81/m³ for an annual treated capacity of 5 000 m³ (see Table 4.176).

Driving force for implementation

See Section 4.12.2.1.

Example plants

Several plants are reported to exist, with sieve separators accounting for more than 40 % of the total slurry separation systems in use on farms [594, Agro Business Park 2011].

Reference literature

[594, Agro Business Park 2011]

4.12.2.6 Filter presses

Description

Most filter-press separators are screen-type devices with a large variety of designs in use. The main presses are as follows:

- Rotary press: Slurry is squeezed through a pair of curved perforated screens by rotating rollers and brushes. The liquid fraction passes through the screens as the solid fraction advances within the channel. The solid material continues to dewater as it travels through the channel, eventually forming a cake near the outlet of the press. The frictional force of the slow-moving screens, coupled with the controlled outlet restriction, results in the extrusion of a dry cake. The use of a polyelectrolyte is normally included, in order to enhance the separation efficiency.
- Filter belt: Slurry is fed onto a perforated, moving belt and it is pressed between constantly turning rollers, and thereby, the liquid part passes through the filter. The filter cake is continuously removed as the belt rotates, so that the raw slurry loading area and solid fraction unloading area change over and are continuously cleaned. Often the belt separator is followed by a screw pressing unit, to further increase the dry matter content in the fibre fraction.

A schematic representation of a filter-pressing separator is given in Figure 4.86.

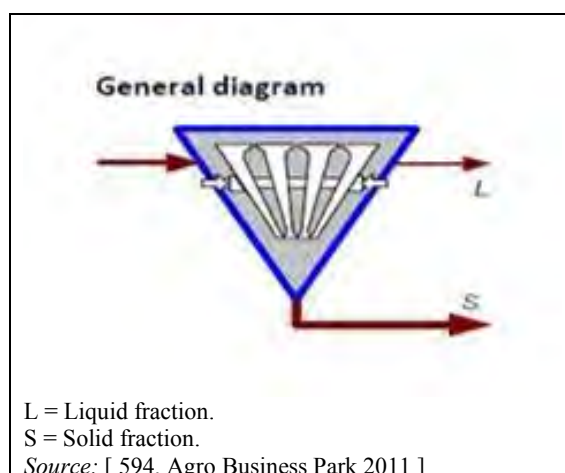

Figure 4.86: Schematic representation of a filter-pressing separator

Achieved environmental benefits

The separation of the initial nitrogen and phosphorus content of the slurry into two fractions (liquid and solid) allows a reduction of the problems related to a nutrient surplus, i.e. phosphorus accumulation and nitrate leaching to water. See also Section 4.12.2.1.

Cross-media effects

See Section 4.12.2.1.

Environmental performance and operational data

Polyelectrolytes (for coagulation-flocculation) are normally applied in combination with filter pressing, in order to enhance separation efficiency. In this case, attainable separation efficiencies of 30 % total Kjeldahl nitrogen and 70 % phosphorus, in the solid fraction, are reported. The dry matter of the separated solid fraction is in the range of 25–35 %. For a rotary presses, the energy consumption is reported to be 0.5 kWh per m³ of input slurry.

Technical considerations relevant to applicability

No technical restrictions are reported for the implementation of the technique.

Economics

Investment costs are reported to be in the range of EUR 25 000–125 000, depending on the dimensions and type of separator. For a band filter (filter belt), operating costs are reported to be equivalent to EUR 1.5 per tonne of input slurry.

From the Netherlands, investment costs for a system with a capacity of 4–30 m³/h are reported to be over EUR 70 000, with operating costs of at least EUR 3.11 per m³, for an annual treated capacity of 5 000 m³ (see Table 4.176).

Driving force for implementation

See Section 4.12.2.1.

Example plants

At least 100 plants are reported to exist.

Reference literature

[594, Agro Business Park 2011]

4.12.3 Biological treatment of slurry

4.12.3.1 Aerobic digestion (aeration) of slurry

Description

Aerobic digestion consists of the biological decomposition of organic matter to carbon dioxide and water by exposing organic matter to biological growth under aerobic conditions. Sufficient oxygen is dissolved in liquid manure through aeration to stimulate the growth of aerobic bacteria. Heat released by the decomposition of the organic matter results in thermophilic temperatures inside the reactor above 45 °C and up to 75 °C. Under thermophilic conditions, only the biodegradable organic matter can be removed, and nitrogen is conserved in the liquid phase. The technique may thus be combined with another stage for the removal of nitrogen through nitrification-denitrification.

The main variables concerning aerobic digestion are the retention time, the aeration intensity and whether the process is continuous or carried out in batch mode. Variations in the slurry characteristics and incomplete mixing can considerably reduce the treatment efficiency and consistency.

Stored slurry is aerated by means of submerged or floating aerators in a continuous or batch process (see also Section 2.7.2.). The residue can be used as fertiliser (composted or not) after concentration.

Achieved environmental benefits

Aerobic digestion produces an odourless product with a lower pathogen content, due to the biological oxidation of volatile organic compounds and the associated heat generation and thermophilic temperatures of the process. Up to 60 % of the organic load (COD) is removed, depending on the level of aeration. Organic matter is also stabilised.

Cross-media effects

Associated cross-media effects are linked to the effort of changing the conditions from anaerobic to aerobic by aeration, which is energy-intensive. The temperature increase generated by aeration and the possible presence of anaerobic zones lead to a high risk of increased methane emissions, compared to a well-covered conventional anaerobic storage. Moreover, if anaerobic/aerobic transition zones arise as a result of the process, N₂O emissions will occur.

Inadequate control of the aeration process can lead to increased releases of sulphides and other odorous organic compounds when anaerobic conditions resume. Furthermore, gaseous emissions may occur in the form of ammonia when the aeration intensity is too high, and as methane and nitrous oxide at low pH levels and in other suboptimal conditions.

When aerobic digestion is combined with nitrification-denitrification, ammoniacal nitrogen may be partly (or completely) removed from the manure and emitted into the air (as nitrogen), resulting in a loss of fertiliser value. Technical assistance to the farmer may be necessary for running the aerobic treatment installation properly [43, COM 2003].

If additives are used for the sedimentation of floating substances, the residual sludge may be difficult to dispose of. Aeration requires significant energy consumption, which is associated with indirect emissions for electricity production. Using this technique on duck slurry, a notable quantity of foam is produced which has to be controlled by means of biological additives [561, Flotats et al. 2004].

Environmental performance and operational data

Batch aeration (especially at thermophilic temperatures) is better at reducing pathogen numbers and, in theory, is a more consistent process than continuous treatment. However, it is difficult to control and leads to wide variation in aeration levels. In batch treatments of a short duration, the rapid increase in biological activity in the first days can exceed the aeration capacity, resulting

in an excessive foam release and increased NH_3 loss. Following an incomplete aerobic treatment, anaerobic conditions can occur in the stored slurry, with a consequent formation of nitrous oxide or denitrification of nitrates to nitrogen gas (N_2); in this way, nitrogen losses in the range of 50–70 % are reported [203, ADAS 2005]. It is important to monitor the redox potential or oxygen content of the slurry closely, as partially anoxic conditions can result in the formation of nitrous oxide (N_2O).

The aeration of pig manure may lead to a sludge that is difficult to precipitate and a dosage of chalk may then be necessary. Temperature is an important factor, particularly in colder regions where it may be difficult to maintain the required aeration level during winter. However, intermittent aeration (15 minutes/hour), in combination with an achieved BOD_5 reduction of about 50 %, results in good deodorisation and very limited sludge production [506, TWG ILF BREF 2001].

Aeration requires a high amount of energy, but the levels vary with the equipment applied and the size of the installation. Air is added to the system at an approximate rate of 1.5 kg O_2 /kg organic matter oxidised. Energy consumption also depends on the composition of the slurry, in terms of BOD and nitrogen (when nitrification is allowed). Levels of 10–38 kWh per m^3 of aerated liquid manure have been reported. Good management of the aeration frequency may reduce the energy consumption, but will lead to ammonia volatilisation.

Technical considerations relevant to applicability

The technique can be applied on pig slurry, and other types of liquid manure such as duck slurry or the liquid fraction coming from the mechanical separation of slurry [259, France 2010].

Due to cross-media effects, the technique is only applicable when pathogen and odour reduction is important prior to landspreading. In cold climates, it may be difficult to maintain the required level of aeration during winter.

Economics

Investment costs for slurry treatment plants operated in Brittany, France, are reported to vary between EUR 45 and EUR 53 per m^3 of annual capacity [203, ADAS 2005]. The total costs, including investment and operating costs, are reported to vary greatly, depending on the level of treatment and the annual volumes involved. Costs for an aerobic treatment without mechanical separation, with an annual capacity of 4100 m^3 , are reported to be about EUR 8.2 per m^3 , in Brittany, France. In cases where a mechanical separation stage is coupled with the aerobic treatment plant, total costs were reported to range from EUR 10.7 per m^3 for the smaller plants (5 600 m^3 slurry per year) to EUR 7.6 per m^3 for the larger plants (16 300 m^3 slurry per year). It is also reported that in France the on-farm use of aerobic treatment receives incentives of financial support [203, ADAS 2005].

In the UK, the typical net cost of aeration was found to be around EUR 4.7 per m^3 of pig slurry (EUR 1 = GBP 0.88). Costs reported by Finland ranged from EUR 0.7–2 per m^3 of aerated liquid manure in a storage tank to EUR 2.7–4 per m^3 of aerated liquid manure in a separate tank. In France, the cost of duck slurry aeration is estimated as EUR 2.2 per m^3 of slurry, including the cost of the anti-foam treatment [370, Franck et al. 2003].

Driving force for implementation

A homogenised product with reduced odour is more convenient for landspreading. Pathogen dissemination is also avoided. The resulting aerated liquid manure can be used for the flushing of manure gutters, tubes or channels to reduce ammonia emissions from housing.

Example plants

This technique is applied in a number of Member States, e.g. about 90 farms are reported in the UK and 20 in Finland. In Spain, the technique is applied to large facilities treating an average of 55 000–65 000 tonnes of pig slurry annually [595, Agro Business Park 2011].

Community facilities for aerobic digestion form an integral part of the NVZ Action Programme in parts of Brittany, France and Flanders, Belgium. In 2005, around 190 aerobic treatment units were reported to be in operation in Brittany, France [203, ADAS 2005].

Reference literature

[26, Finland 2001] [43, COM 2003] [203, ADAS 2005] [259, France 2010] [370, Franck et al. 2003] [409, VITO 1997] [506, TWG ILF BREF 2001] [561, Flotats et al. 2004] [594, Agro Business Park 2011] [595, Agro Business Park 2011]

4.12.3.1.1 Aerobic biological manure processing in a serial tank configuration

Description

This technique represents a special configuration of an aerobic digestion process in combination with specific features. The input material is the homogeneous liquid fraction with a dry matter content of about 1 % that results from an enhanced solid separation step prior to treatment. This step combines techniques of mechanical separation (band filter and screw press) and flocculation (see Section 4.12.2.4).

The liquid fraction of the slurry is continuously pumped into an aerated continuous-flow tank system consisting of six treatment tanks connected in series. The design of the serial reactor configuration aims to enhance the treatment efficiency and stability, to achieve improved odour reduction and to provide more advanced process control.

The initial stage of the process is biological based on an amendment of an enriched soil microbe population. Under aerobic conditions, liquid manure is converted to an odourless effluent and organic molecules to a form that is easy to precipitate and separate. Rotameters are used to regulate aeration in each tank using high-pressure blowers through membrane diffusers for fine bubble aeration. Limited aeration is applied in a system in order to keep nitrogen in the ammonia form, preventing nitrate formation. Feedback effluent from the last tank is used to inoculate the first tank.

The treatment tanks are covered and insulated. Ammonia released during aeration is collected and led to a sulphuric acid scrubber. During the biological treatment, the process is producing heat (the temperature in the insulated treatment tanks increases above 40 °C) that can be recovered by a heat pump to heat the farm building. The biologically treated liquid manure is used as nitrogen fertiliser. The separated solid fraction can be used as concentrated phosphorus fertiliser on the field, composted or used for biogas production.

Achieved environmental benefits

The final effluent after the treatment (enhanced solid separation and biologically treated liquid manure) is completely odourless and considerably lower in pathogenic organisms. Due to the consistently low level of dry matter content, the treated liquid fraction can easily infiltrate into soil, thus reducing NH₃ emissions to air.

Cross-media effects

Electrical energy is required to operate the system.

Environmental performance and operational data

Data are reported from a pig farm in Finland with an annual manure production of about 2 200 m³ (about 6 m³ of slurry per day) that applies a combination of an enhanced solid separation stage and aerobic biological treatment in tanks connected in series. The quantities and composition of the different streams are summarised in Figure 4.87.

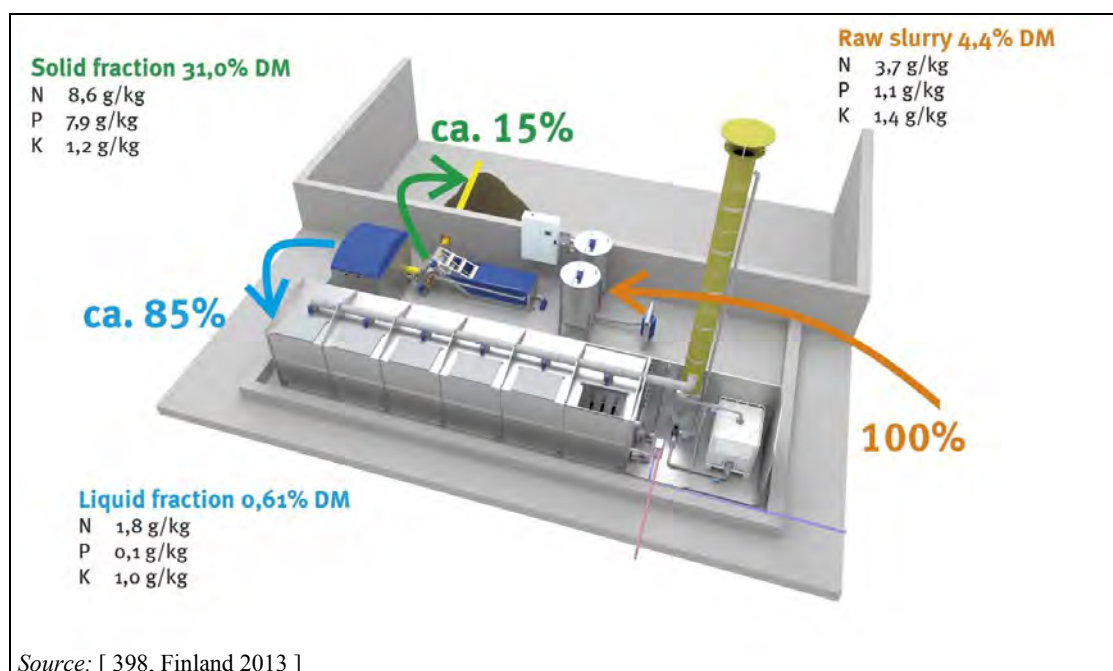

Figure 4.87: Mass balance and composition of the different streams resulting from a combination of a mechanical separation stage with flocculation and a biological aeration treatment with serial tank configuration

The energy use for the biological aeration treatment is reported as 5.83 kWh per m³ of raw manure.

Technical considerations relevant to applicability

No restriction is reported for the application on either existing or new farms.

Economics

Depending on the size and the system, the costs of an installation consisting of the complete biological treatment system (including the air scrubber) may vary from EUR 80 000 to EUR 160 000 when the system is combined with an enhanced separation stage prior to treatment. The energy cost is estimated to be around EUR 0.88 per tonne of treated manure. In the case of heat recovery by the application of heat exchange technology (35 °C → 4 °C), the energy production can have a value of EUR 4.5/tonne of manure.

Driving force for implementation

Pathogen and odour reduction can be key factors in areas with intensive livestock production.

Example plants

In Finland, three farms applying a combination of an enhanced solid separation stage and biological aeration treatment are in operation.

Reference literature

[224, Finland 2010] [398, Finland 2013] [621, Alitalo et al 2011]

4.12.3.2 Nitrification-denitrification of slurry

Description

Biological conversion of ammoniacal nitrogen is performed in two main steps: nitrification and denitrification. In the nitrification stage, the ammoniacal nitrogen is oxidised into nitrate by nitrifying bacteria which use an inorganic carbon source for growing (autotrophic organisms). This process takes place under aerobic conditions, in the presence of free oxygen and agitation.

In the denitrification stage, the nitrate is biologically reduced to gaseous nitrogen (N_2). Denitrification takes place under anoxic conditions (i.e. absence of free dissolved oxygen) and in the presence of organic carbon by denitrifying bacteria (heterotrophic organisms).

The activated sludge and treated liquid flow from the aeration basin into another (secondary) settling basin. In this basin, the sludge settles, with part of it being reused in the aeration basin. The mass of separated solids is captured in a storage basin to concentrate it further. This concentrated residue can be used as fertiliser (sometimes it is composted first). The typical treatment system has two different outputs: treated liquid effluent and biological sludge.

Achieved environmental benefits

Ammoniacal nitrogen is removed from the slurry in the form of inert N_2 gas. Nitrogen removal can improve the manageability of slurry, especially in areas with a nitrogen surplus. Odour is reduced compared to untreated slurry. COD reduction occurs as a function of aeration.

With the application of a biological treatment, emissions of greenhouse gases (methane and nitrous oxide), as well as ammonia emissions, are reported to be reduced, compared with manure storage alone (based on 6 months storage before spreading) [597, Loyon et al. 2007].

Cross-media effects

Energy consumption is increased in comparison with a solid-liquid separation, due to the operation of aeration and pumps. A higher quantity of sludge is produced (from microbial activity) compared with anaerobic treatment systems. The fertilising value of slurry is decreased when there is no nutrient surplus, and, therefore, nitrogen has to be provided by mineral fertilisers. Mineral nitrogen production is very energy-intensive and consumes a lot of fossil energy sources.

Another disadvantage is that part of the nitrogen emitted into the air is not in the form of N_2 but, potentially, NH_3 or N_2O , if the process is not well managed. The design and proper functioning of this technique are very important to prevent environmental problems being transferred from water to air media.

Environmental performance and operational data

The maximum attainable nitrogen removal efficiency is up to 70 % of the total N in the untreated slurry (the rest of the nitrogen will be separated in the solid fraction, assimilated by the biological sludge, or will remain in the liquid effluent). If the nitrogen removal efficiency is evaluated on the liquid phase, it may be higher than 90 %.

Aeration is one of the main operational parameters during nitrification, with theoretical requirements of around 4.6 kg O_2 per kg of nitrogen. The organic load during denitrification is required to be approximately 6.0 kg COD per kg of nitrate-N. Pretreatment, such as separation and anaerobic digestion, may constrain the availability of biodegradable organic carbon during denitrification.

A prior mechanical separation treatment of slurry can reduce the oxygen demand, and thereby energy costs, and avoid possible problems during the process due to the high sludge production level, sedimentation and clogging of the equipment. The optimal process temperature is 35 °C.

The results of a study comparing a nitrification-denitrification treatment (intermittent aeration) to a conventional slurry storage of 6 months before spreading report a reduction of 30–52 % in ammonia emission for a biological system combined with mechanical separation (centrifuge or screw press). A higher ammonia emissions reduction (68 %) is reported for a combination without separation, consisting of storage, biological treatment and decanting. A reduction of greenhouse gas emissions (CH_4 and N_2O) of about 55 % (calculated as CO_2 equivalent) is also reported for any type of biological treatment plant [597, Loyon et al. 2007].

The technique requires the control of a number of operating parameters, such as composition of the effluent, applied loads, bacteria populations, and temperature. The process is sensitive to the presence of toxic substances and other substances which can inhibit microbial activity. The resulting sludge needs proper management.

The biological process needs continuous operation. It is necessary to ensure that slurry has sufficient inorganic carbon for the nitrification stage, and organic carbon for the denitrification process. During the process, the oxygen consumption to oxidise organic matter in the aerobic stage should be carefully controlled. Intensive aeration to remove excess nitrogen from livestock slurries has been shown to increase N₂O emissions by up to 19 % of the total N in pig slurry [443, Chadwick et al. 2011].

The energy consumption depends on the composition of the stream to be treated, the efficiency of transferring oxygen of the aeration equipment, the operational conditions applied, etc. Values in the range of 10–25 kWh/m³ are reported, in comparison with an effective solid-liquid separation, for which the energy consumption can be less than 10 kWh/m³ [594, Agro Business Park 2011].

Data are shown below for a farm in Brittany with 250 sows and 5 000 finishers per year with a yearly manure production of about 5 000 m³. The solids are sieved from the liquid. The results, in terms of mass balance, quantities and composition of the products for mechanical separation and biological treatment at this specific farm are summarised in Table 4.182 and Table 4.183.

Table 4.182: Mass balance of the mechanical separation and biological treatment of pig slurry

Component	In	Out			Calculated emissions to air	
	Manure	Separated solid fraction	Sludge	Effluent		Total
Mass	1 000	57	260	580	897	103
Dry matter	56	20	21	5	46	10
Susp. solids	48	NI	NI	0.3	NI	NI
Water	944	37	239	575	851	93
COD	52	NI	NI	1	NI	NI
BOD	6.6	NI	NI	0.05	NI	NI
N	4.4	0.5	0.7	0.05	1.25	3.15
P ₂ O ₅	3.3	0.6	2.0	0.4	3	0.3
K ₂ O	3.5	0.2	0.9	1.8	2.9	0.6
Cl	1.9	NI	NI	0.8	NI	NI

NB: NI = no information provided.
Source: [409, VITO 1997]

Table 4.183: Composition of manure and products in g/kg

Component	Manure	Separated solid fraction	Influent to secondary basin	Sludge	Effluent
Dry matter	56	350	39	80	8.5
Susp. solids	48	NI	29	NI	0.5
Water	944	650	961	920	991.5
COD	52	NI	36	NI	1.8
BOD	6.6	NI	6.1	NI	0.09
N	4.4	8.1	4.2	2.7	0.08
P ₂ O ₅	3.3	9.9	2.9	7.5	0.6
K ₂ O	3.5	3.4	3.4	3.4	3.0
Cl	1.9	NI	1.9	NI	1.4

NB: NI = no information provided.
Source: [409, VITO 1997]

The sieve removes a small mass with a relatively high DM content and phosphate level. The solid fraction contains about 35 % dry matter and can be stacked. The tables show that much of the nitrogen (72 %) is lost into the environment due to nitrification and denitrification. Only about 1 % of the nitrogen appears in the effluent. Most of the P₂O₅ is retained in the activated sludge. It should be noted that the information source did not report if BOD was measured over 5, 7 or 20 days.

Technical considerations relevant to applicability

The technique is not applicable to new plants/farms due to the cross-media effects. In existing farms, it is only applicable when the removal of nitrogen is necessary due to there being limited land available for manure application. The applicability is limited by the high investment costs and the operating costs for the electrical energy required for aeration.

Proper process control is essential, but may be difficult on farm; outsourcing could thus be a solution. Particularly in colder areas, the minimum winter temperatures required for sufficient biological activity to occur may be difficult to maintain. Ammonia levels can rise and lead to inhibited nitrification.

With more solid types of manure, such as the manure of finishers, large amounts of residual sludge can be expected. In practice, this limits the application of this technique to the treatment of sow manure with a DM content of no more than 6 %. A mechanical separation stage can be utilised to reduce the dry matter content.

Concerning the poultry sector, the technique is theoretically suitable for duck slurry, but the volume needed and the treatment costs are still not economical for its common on-farm use [[259, France 2010](#)].

Economics

For a unit with a capacity to treat 15 000 m³ of pig slurry per year, the reported investment costs are EUR 240 000–300 000. For a capacity of 50 000 m³ of pig slurry per year, the investment costs are EUR 700 000–1 200 000.

Operating costs are dependent on the composition of the manure to be treated and are reported to be in the range of EUR 0.5–3.0 per tonne of slurry [[594, Agro Business Park 2011](#)] [[561, Flotats et al. 2004](#)]. In the case when solid-liquid separation is carried out prior to nitrification-denitrification, and the solid fraction is composted as a post-treatment, costs can increase to EUR 2.5–5.2 per tonne.

Driving force for implementation

In areas with a nitrogen surplus, the economic investment and operating costs for the removal of nitrogen from slurry could be attractive, if they are lower than the costs for transportation to and application in areas far away where there is no nitrogen surplus.

Example plants

In Brittany, France, around 300 units are in use. About 240 farms in the region of Brittany, most of which is classified as a Nitrate Vulnerable Zone under the EC Nitrates Directive, have opted biological treatment using nitrification-denitrification (intermittent aeration) [[597, Loyon et al. 2007](#)]. In Belgium (Flanders), Spain and the Netherlands, the technique is also widely applied [[595, Agro Business Park 2011](#)].

Reference literature

[[259, France 2010](#)] [[409, VITO 1997](#)] [[410, Greece 2001](#)] [[443, Chadwick et al. 2011](#)] [[561, Flotats et al. 2004](#)] [[594, Agro Business Park 2011](#)] [[595, Agro Business Park 2011](#)] [[597, Loyon et al. 2007](#)]

4.12.4 Composting of solid manure

Composting can be applied as a further treatment, after the drying of fresh (poultry) manure, after mechanical separation of the solid fraction of slurry or after the addition of enough dry organic material (bulking agent) to liquid manure in order to obtain a solid mixture.

Composting installations handling manure are subject to the specific provisions of Regulation (EC) 1069/2009, concerning animal by-products, and have to be approved in accordance with Article 24 of the Regulation. The requirements applicable to composting plants regarding hygiene, operational parameters and standards of derived product are set out in Article 10 and Annex V of Regulation (EC) 142/2011. The competent authority shall only approve composting plants if they comply with the above-mentioned requirements. Furthermore, it has to be ensured that the obtained final product corresponds to the specifications set by potential buyers.

4.12.4.1 Composting

Description

Composting is the controlled aerobic degradation of organic matter. In the IRPP sector, solid manure, mixed or not with vegetal organic matter, is used in the process. Aerobic conditions can be achieved by mechanically turning or mixing a heap or pile with a tractor loader, for example, to incorporate air or by more specialised equipment.

The aim of the technique is to facilitate naturally occurring microflora to degrade cellulose and other carbon compounds in the manure to produce a material that is friable and sufficiently stable for storage and transport and that has a reduced volume. Compost, which is the final product, consists of stabilised organic matter, has a low moisture content and retains most of the initial nutrients.

In the initial phase of the process (decomposition), exothermic reactions produce a temperature increase in the composting matrix, above 50 °C in the thermophilic temperature range up to 70 °C, with consequent hygienisation of the product by the elimination of pathogens in the manure. Aerobic conditions are needed in order to enable the microorganisms to convert the input material by using the available nutrients, oxygen and water. When oxygen is depleted, manure heaps cool down and aeration should be restored by mechanical turning of the heap, as well as by forced aeration [528, ITAVI 2001].

In a second, curing, stage, complex organic matter is degraded and humic and fulvic acids are produced. The temperature slowly decreases in the mesophilic temperature range (below 40 °C) to room temperature. The whole process lasts between 8 and 16 weeks. Run-off liquids are collected by shafts and pumped to a tank, from where they can be recycled on the composting silo or windrow [257, France 2010].

The different composting systems are described below.

Composting with mechanical reversal of heaps

On farm, the manure is usually arranged in windrows (long heaps with a trapezoidal or triangular section, typically 1–3 metres high, 2–5 metres wide and of indeterminate length) and monitored for temperature and moisture. The temperature needs close monitoring, especially during the first days. Run-off waters or slurry can also be added to increase moisture. The windrows are turned over and mixed periodically using conventional loading machinery (e.g. a bucket loader) or other available farmyard machinery (e.g. windrow turner).

In the first week of composting, it is recommended to turn the solid manure windrow twice to facilitate aeration and the development of high temperatures within the windrow [648, DEFRA 2011]. Later, reversals are necessary at intervals of 10 days to 3 weeks, in order to maintain the airflow in the middle of the heap. After the last reversal, it is then necessary to wait at least 3 more weeks [528, ITAVI 2001].

Reversals have an immediate effect on the temperature. Several reversals are essential to ensure that all the compost has been subjected to a high temperature. The operation of reversal ensures homogenisation of materials, increases passive aeration, and provides the proper conditions for the aerobic decomposition. The period that active composting normally lasts ranges from 8 to 12 weeks.

Static aerated piles

This is an alternative method, which uses air supplied by perforated piping or a porous floor below the pile, therefore avoiding the reversal and mixing. Aeration can be forced (air is forced into the composting material) or passive (convective movement of air into the composting material).

Composting in-vessel (with forced aeration)

Composting is carried out in closed, aerated concrete silos/tanks or channels (composting vessels). The bottom of these modules is equipped with a system of perforated pipes, allowing forced aeration by blowing air into the substrate. The system is controlled by temperature sensors, allowing the aeration to be recorded and adjusted. Once the silo is charged with solid manure, a cover is anchored on the walls of the silo. Forced aeration is maintained for 6 weeks and then the silo is uncovered and emptied for the compost to mature in a heap [257, France 2010]. Composting drums can also be used.

Achieved environmental benefits

The technique produces an organic fertiliser (compost) with part of the original inorganic, readily available nitrogen content converted to organic forms, and most of the phosphorus in a concentrated form (due to water evaporation). The organic matter is humified and the product is odourless and pathogen-free. As a result, during landspreading of the composted product, reduced odour and NH₃ emissions, and emissions of nitrogen compounds from leaching, are expected [203, ADAS 2005] [257, France, 2010].

The benefits in terms of the fertiliser product obtained depend on the type of manure, the pretreatment technique, the additives, and on the composting technique, and cannot be quantified in a general sense.

In France, the product of composting (compost manure) is considered an organic fertiliser, deodorised and hygienised. It supplies organic matter to the ground, and the organic form of nitrogen allows a gradual release to the plants. A priori, compost manure may be applied in the autumn and winter without risking an increase in nitrate leaching [528, ITAVI 2001].

Cross-media effects

In partly aerobic conditions, such as in unsealed manure heaps, part of the inorganic nitrogen (10–55 % of the nitrogen) is lost through volatilisation as ammonia emissions. N₂O emissions and NO₃⁻ losses as leachate may also occur [624, IRPP TWG 2013]. The nitrogen losses reduce the fertiliser value of the manure, resulting in the need for supplementing it with a mineral fertiliser, with consequent increased indirect emissions for its production. Loss of carbon during composting also reduces the nutrient content of the resulting product.

Conditions during composting imply a risk of increasing emissions of greenhouse gases, since aeration leads to a temperature increase and, thereby, also to much higher activity of the anaerobic bacteria. Methane emissions are very likely to occur if anaerobic zones are developed inside the composting mass, as are nitrous oxide emissions in the case of improper aeration of the whole manure heap (i.e. anaerobic zones in the centre imply that there may be aerobic/anaerobic transition zones in the compost).

The volatilisation of nitrogen can also be reduced by means of a cover. Peat is suggested as the cover, as acid sphagnum peat (*Sphagnum fuscum*) has a better nitrogen-binding capacity than straw, sawdust or cutter chips for example. However, peat is a non-renewable resource and its extraction leads to significant emissions of greenhouse gases. On the other hand, it is also

reported that covers were not found to have any significant effect on aerial emissions during composting in a study carried out in France [528, ITAVI 2001].

Air scrubbing systems for manure composting facilities are well tested as an additional method to reduce NH₃ emissions from this source, but have significant costs [508, TFRN 2014]. No composting installation at the farm scale is reported to be equipped with air cleaning systems [595, Agro Business Park 2011].

If the heap is put on soil and not on an impermeable base, part of the nitrogen that sinks into the soil evaporates, and plants use part of it after the heap is removed. Depending on the amount of run-off, the soil surface and the soil type, part of the nitrogen may also leach into the surface waters or groundwater.

About half of the potassium in manure may be lost due to composting. Potassium is lost only in run-off water, and these emissions can be reduced by means of a watertight cover over the compost. The cover prevents the leaching caused by rainwater, but it does not prevent the liquids produced in the compost from sinking into the ground. If composting is performed in a barn, losses to the soil or from leaching during the composting process are non-existent.

In the composting process, suboptimal conditions may eventually result. Odour emissions would be indicative of the occurrence, as odorous compounds are mostly volatile organic sulphur compounds produced under anaerobic conditions. In the case of silo composting with forced aeration, odours are controlled by incorporation of a neutralising product into the dry air. Energy consumption is required, in particular when forced aeration is used for composting. Water is needed in the process to maintain a suitable moisture content of the manure [594, Agro Business Park 2011].

Environmental performance and operational data

Composting periods may last up to 6 months or more, but can be shortened by frequent turning and aeration. The required operational parameters for composting using animal by-products (including manure) are specified in European Regulation 142/2011, as well as the specifications of the final compost products. The key operating parameters and transformation requirements are reported below.

- Moisture content between 40 % and 70 % [203, ADAS 2005]. Below 30 %, bacteria activity is inhibited. In general, solid manures from deep litter housing systems (broilers, turkeys, guinea fowl) are not suitable for a smooth composting process, due to the high dry matter content, ranging between 65 % and 80 %. The ideal dry matter content should be about 40 % to 50 %; for the purpose, moisture (water, slurry, etc.) in sufficient quantity has to be added at the beginning of composting, at the time of building the windrows. As an example, one tonne of solid manure with a dry matter content of 75 % requires 500 litres of water in order to reach a dry matter content of 50 %. A very moist mixture does not favour composting because it prevents aeration [528, ITAVI 2001].
- Oxygen supply > 0.5 mg/l.
- Porosity of the heap between 30 % and 60 % (as air-filled porosity).
- Carbon/Nitrogen ratio (C/N) in the range of 20–35.
- Temperature of the heap between 50 °C and 60 °C. Product hygienisation is ensured by monitoring the temperature as an indicator. In general, if the material remains at 50 °C for over 6 weeks, most pathogens will be destroyed (viruses, bacteria and parasites), while, at a temperature of between 40 °C and 50 °C for 6 weeks, only parasitic worms are destroyed. At a temperature below 40 °C for 6 weeks, no sanitation occurs. A general practice is to maintain the temperature above 55 °C for 25 to 30 days [528, ITAVI 2001]. Hygienisation is also achieved if the temperature is kept above 55 °C for 2 weeks or above 65 °C for 1 week [561, Flotats et al. 2004].

Regulation 142/2011 sets the minimum temperature (70 °C) that all material must remain at without interruption for 60 minutes. However, the competent authority may authorise the use of other specific requirements provided that they guarantee an equivalent effect regarding the reduction of pathogens.

The use of tarpaulins for covering the windrows limits odour emissions and flies, allows better integration of windrows in the landscape (positive psychological effect on the neighbourhood), provides health protection from birds and rodents, and essential protection in case of heavy rain. A semi-permeable geotextile cover offers the advantage of being permeable to gas and allows good drainage of water on the surface of the windrow [528, ITAVI 2001].

For the application of the composting technique in the UK, the readily available nitrogen content of FYM is typically reduced from 20–25 % to 10–15 % of total N (in composted FYM) due to $\text{NH}_4\text{-N}$ conversion to $\text{NO}_3\text{-N}$ and organic nitrogen. Composting has a smaller effect on the proportion of readily available nitrogen in poultry manure. Composting typically results in 40–50 % of the total N in FYM and around 15–20 % in poultry litter being lost (either as NH_3 , N_2O or in leachate) [648, DEFRA 2011].

For composting poultry manure in France, if reversals are very frequent, losses can be as high as 50–60 % of the total N present. With three reversals, losses are generally around 30–40 % of the total N present. After composting solid poultry manure, the volume and weight reduction is reported to be typically in the range of 30–50 % [528, ITAVI 2001].

Ammonia emissions can be reduced by composting manure with a high C/N ratio (20–35), and by carefully balancing the frequency of heap reversals, in order to achieve sufficient aeration with minimum disturbance. Nitrogen losses as high as 70 % have been reported, through ammonia volatilisation [594, Agro Business Park 2011]. The supply of air to composting (and aerobic digestion systems) requires a fine balance; too high airflows encourage NH_3 volatilisation, while low flows encourage methane and nitrous oxide emissions [203, ADAS 2005].

The typical dimensions of windrows do not exceed 1.8–2 m in height and 3.5–4 m in width [528, ITAVI 2001]. If the windrow height is excessive (more than 3 m), the resulting compression will not let air pass. If windrows are too small, they will be susceptible to cooling down easily [561, Flotats et al. 2004]. The area needed for composting manure coming from a 1 000 m² building is reported to be 800 m² for turkeys and between 750 m² and 1 000 m² for broilers [528, ITAVI 2001]. Windrows of approximately 3.5 m wide and 2 m high (corresponding to 6 m³/m of linear length) are needed. Also, a traffic lane of 4 m for the machines and 10 m to 15 m at the end of windrows is generally needed for facilitating manoeuvres.

The energy use depends on the composting technique applied. Without aeration and turning of the heaps, the energy use would be negligible. The energy consumption varies between 5 kWh/tonne of raw manure for turning only, and between 8 kWh and 50 kWh/tonne of raw manure for farms that apply ventilation through or over the heaps as well. From France, the energy consumption for composting by forced ventilation is reported to be 1 980 kWh of electricity per year and 480 l of fuel per year, to treat 600 t of manure [259, France 2010]. Water needs are reported to be between 250 l and 650 l/tonne of manure [594, Agro Business Park 2011]. A comparison of composting applied to different pig solid manures are described below in Table 4.184, as reported by France.

Table 4.184: Nitrogen and weight losses during composting of solid pig manure, in France

Composting material	Nitrogen loss (%)	Weight reduction (%)
Straw-based pig manure	40–50	30–35
Sawdust- and pine-bark-based pig manure	40–48	15–30
Sawdust-based pig manure	20	4
⁽¹⁾ Manure removed after two cycles of fattening pig production (8 months). NB: Three reversals carried out during composting at day 0, day 10 and day 20, and 4 months of composting. <i>Source:</i> [259, France 2010]		

Technical considerations relevant to applicability

Due to cross-media effects, the technique is applicable when manure cannot be transported for landspreading at a reasonable cost and pathogen and odour reduction is important prior to landspreading. The technique requires enough space available for windrows to be established.

The process is relatively simple and can be applied on small-scale individual farms, using standard farm equipment, but it needs proper control to avoid anaerobic processes that could lead to an odour nuisance. If process control and emission reduction are required, then the composting installation needs to be larger for (cost-)efficient operation.

In France, the process can also be implemented for temporary field heaps of solid manure on flat soil with low permeability (in different places every year and without using the same field for at least 3 years). The process should not last more than 2 months.

Composting should not be carried out on filtering soils, on waterlogged soils, or on sloped land. All measures should be taken to avoid stagnation of storm water under windrows and to accommodate the disposal of contaminated water [528, ITAVI 2001]. Specially designed composting machines or windrow turners do a more efficient job, but the high costs limit their use to large individual farms only. As a result, composting machinery is usually provided by cooperatives or machinery rings [203, ADAS 2005].

Economics

Composting with mechanical reversal of heaps (windrow composting)

The operating cost, including the clearing out of the buildings, the formation of the windrows, two reversals and the spreading of the compost, is reported from France as follows [259, France 2010]:

- for a pig farm with 550 fattening places, the cost is EUR 0.01–0.02 per kg of pig produced;
- in a poultry meat farm of 1 000 m², the cost is between EUR 7.9 and EUR 9.9 per tonne of manure produced per year.

The purchase of necessary reversing tools in France is often shared, e.g. in CUFÉ (Cooperative of Use of Farm Equipment). The investment cost for a machine of 4 m in width, for working with windrows, is reported to be about EUR 42 000 [259, France 2010]. Other examples of investment costs for the necessary composting equipment are reported in Table 4.185.

Table 4.185: Investment costs for equipment used in composting plants

Type of machinery	Investment costs (EUR)	Capacity (m ³ /h)
Windrow turner	30 000	100
Windrow turner	100 000	1 000–15 000
Windrow turner	180 000	2 500
Tractor	50 000	NI
Mixers	20 000–50 000	10–100
Drum sieve	70 000	100
Composting plant using mechanical reversal of heaps	35 000–100 000	2 000 t/yr manure + 1 360 t/yr sawdust Cost depends on the buildings or covers constructed
NB: NI = no information provided.		
Source: [594, Agro Business Park 2011]		

The operating costs are reported to be equal to EUR 20/tonne produced, and the income from compost sales ranges from EUR 15 to EUR 30 per tonne [594, Agro Business Park 2011].

Composting in vessels with forced aeration

This system is economically viable only for large manure volumes in France. In a reported example, the investment costs for the equipment to treat 600 tonnes of manure per year is amortised over 10 years, resulting in an annualised investment cost of EUR 10 per tonne of pig produced (manure resulting from 2 700 fattening pigs per year), or EUR 6.2 per tonne of poultry manure (four buildings of 1 000 m² each with 150 t of manure per building per year). The operating cost of the system (including clearing out of the buildings, handling of the silos and spreading of the compost) is obviously variable, depending on the production and the size of the farm. From France, the operating cost is reported to be equal to EUR 0.02 per kg of pig produced and EUR 11.4 per tonne of poultry manure [259, France 2010].

Driving force for implementation

Composted solid manure has little odour, is more stable, contains fewer pathogens and is relatively dry. This improves handling, storage, transportation and landspreading without the risk of transferring diseases (e.g. landspreading on ready-to-eat crops) [506, TWG ILF BREF 2001] [648, DEFRA 2011]. Transport costs are reduced due to the significant reduction of mass due to water evaporation.

Example plants

The technique is applied at farm level, as well as in centralised plants, in various Member States; for example, 400 farm-scale plants are reported in the UK, 127 in Spain (Catalonia), 32 in Romania and 100 in France [595, Agro Business Park 2011]. In France, around 200 farms are affiliated with one commercial organisation using the forced aeration variant of the technique.

Reference literature

[26, Finland 2001] [203, ADAS 2005] [257, France 2010] [259, France 2010] [409, VITO 1997] [410, Greece 2001] [506, TWG ILF BREF 2001] [508, TFRN 2014] [528, ITAVI 2001] [561, Flotats et al. 2004] [594, Agro Business Park 2011] [595, Agro Business Park 2011] [624, IRPP TWG 2013] [648, DEFRA 2011]

4.12.4.2 Co-composting of poultry manure with green residues

Description

See also Section 4.12.4.1. To control the composting process and to achieve a better quality final product, substances of plant origin can be added to raise the carbon content. The application of additives aims to increase the porosity and binding of the nitrogen, thereby avoiding emissions to air.

Poultry manure can be mixed with green residues, preferably woody crushed residues, by avoiding moving, in proportions from 1 to 1 (and up to 3 to 1) in weight (manure/green residues). Pig manure or slurry (liquid or solid fraction) can also be blended with organic materials for composting.

Achieved environmental benefits

Depending on the origin of the manure and the co-substrate (vegetal matter) that is co-composted, a dilution effect of the nitrogenised load by 30 % to 60 % can be obtained.

Cross-media effects

NH₃ emissions can be controlled by proper management of the process, on the basis of the C/N ratio; otherwise, they can be considerable. Greenhouse gas emissions are very likely to occur during composting (see also Section 4.12.4.1).

Environmental performance and operational data

A typical poultry manure composition is 18 % bedding material, 50 % droppings and 32 % water, even though generally this does not correspond to the ideal composition for composting. Poultry manure contains cellulose and nitrogen, but moisture and the C/N ratio are relatively low. A more favourable C/N ratio for composting is 25–30, which is achieved by adding green wastes. Regarding moisture, it is necessary to increase the level by adding water from an external supply. Indicative values of the C/N ratio for different materials are presented in Table 4.186.

Table 4.186: Indicative values of the C/N ratio for different materials

Material	C/N
Slurry solid fraction	9
Cattle manure	18
Laying hen manure	13
Garden residues	23
Straw	128
Sawdust	511
Pine bark	723
<i>Source: [561, Flotats et al. 2004]</i>	

In one example, poultry manure was mixed with pine bark, at an excreta/bark ratio of 3/1 on a total weight basis. In a comparison with other kinds of auxiliary substances, the pine bark showed the best results for pH level, nitrogen volatilisation and carbon content (organic material).

The composting took place at a temperature of 55–60 °C. A minimum porosity of the manure/bark mixture was maintained to allow an adequate oxygen supply. The test on compost produced with the addition of pine bark showed an unchanged (70 %) organic matter content (on a DM basis) after 90 days. The nitrogen losses reached about 35 % (on a DM basis) at 90 days and increased by 1–2 % over the next 90 days. The pH at 90 days was below 8, and reached 7.5 at 180 days.

In another reported example, straw pig manures were co-composted with woody pig manures (containing wood chips or sawdust). The weight reduction was 24–30 % and the nitrogen

reduction 35–50 %. The presence of straw allowed a temperature increase of 10–15 °C, in comparison with composting the sawdust manure alone, over the last 3 months of composting [259, France 2010].

The maturation time for compost in a heap, after a co-composting treatment, is reported to be longer. In particular, a duration of 4 to 5 months is needed for maturation when manure is composted with wood waste, in comparison with 6 weeks of active composting when only solid manure is composted [528, ITAVI 2001].

The composition of turkey manure composted with wood waste in a proportion of 1/1 in weight is shown in Table 4.187.

Table 4.187: Composition variation of turkey manure co-composted with green residues (ratio 1/1 in weight)

Parameter	Unit	Before composting			After composting	
		Untreated manure		Humified mix of green residues and manure	Final compost	
		Raw product	Dry matter		Raw product	Dry matter
Dry matter	%	65	NI	50	74	NI
Minerals	%	17	31	15	33	44
Organic matter	%	53	69	34	41	56
C/N	NA	8.5	NI	9.8	9.4	NI
N	%	3.0	3.9	1.9	2.2	3.0
NH ₄	%	1.0	1.5	0.7	0.5	0.7
Organic N	%	1.9	2.4	1.2	1.7	2.2
P ₂ O ₅	%	2.7	3.7	1.8	2.2	2.9
K ₂ O	%	2.9	3.7	1.9	1.9	2.6
Cu	mg/kg	62	86	43	89	121
Zn	mg/kg	215	238	144	253	344

NB: NI = no information provided; NA = not applicable.
 Source: [528, ITAVI 2001]

Data on energy consumption for the equipment used in composting and co-composting plants are presented in Table 4.188.

Table 4.188: Energy consumption of equipment used in composting and co-composting plants

Equipment/operation	Energy consumption (kWh/t)
Drum sieve	3
Magnet separator	0.5
Shredding and crushing	2.6
Container composting (11 days)	10
Waste gas purification (11 days of intensive composting)	8.1
Waste gas purification (8 weeks)	19.3

Source: [594, Agro Business Park 2011]

Technical considerations relevant to applicability

See also Section 4.12.4.1. The bark needs to be dried and ground before it can be added to the manure. Green residues can be pre-composted before their use.

When co-composting is applied with wood waste, the necessary available area that composting normally needs should be multiplied by 1.5, in order to take into account the increased volume [528, ITAVI 2001].

Economics

See Section 4.12.4.1.

Driving force for implementation

See also Section 4.12.4.1. Properly composted solid manure significantly reduces the volume of material to be transported and landspread and the amount of odour released. During composting, a high temperature is achieved and the product is stabilised and sanitised.

Composting and co-composting allow the reduction of the quantity of nitrogen to be spread, at relatively low investment costs, where constraints to manure landspreading may exist and where local markets for alternatives to conventional fertilisers can be found.

Farmers can participate in recovering compostable residues on behalf of the local community, offering an opportunity to solve problems of green waste locally.

Example plants

The technique is widely applied in Catalonia, Spain, where it is reported that there are 127 farm-scale plants and 21 medium-scale plants where organic materials are mixed with manure in aggregated composting activities [595, Agro Business Park 2011]. In general, across Europe, the technique is widespread, mainly at centralised plants where other organic wastes may be included for co-composting [203, ADAS 2005].

Reference literature

[259, France 2010] [528, ITAVI 2001] [561, Flotats et al. 2004] [594, Agro Business Park 2011] [595, Agro Business Park 2011]

4.12.4.3 Composting of poultry manure with a biological inoculum

Description

Microorganisms of the optional aerobic-anaerobic type (which do not necessarily need oxygen to develop) are used to degrade the organic matter. The manures are inoculated by sprinkling, preferably before exiting the building. They are then placed in windrows in the same way as for conventional composting. Windrow reversal is not necessary. At the end of 6 weeks to 2 months, the compost is moved from the windrow to a maturation heap.

The bacterial inoculum is a complex of bacteria of the types *Bacillus* and *Lactobacillus* (1 dose = 10 ml of lactic bacteria and 10 ml of *Bacillus*), selected according to their metabolic criteria and for their aptitude to develop on an environment which has not significantly degraded. They all belong to the classification AFNOR IA, posing no danger to humans, animals or the environment. Oxygen addition may not be necessary when biological inoculums are used.

Achieved environmental benefits

Fermentation which takes place make it possible to reduce 10 % to 55 % of the nitrogenised load, essentially the ammoniacal nitrogen. This reduction varies according to the origin of the manure, the type of litter used (straw, sawdust, conifer shavings, etc.) and the mode of housing for the pigs (deep litter, scraped litter, etc.).

Emissions of odour are considerably decreased, since bacteria preferentially use the volatile fatty acids (odorous substances) as energy nutrients. Nitrogen losses by volatilisation in the form of NH₃ are also lower than with other composting systems [259, France 2010].

Spreading volumes of manure are reduced, with a consequent energy saving associated with less transport being required for spreading. Less energy is required compared to the other composting processes that require reversal or forced ventilation.

Cross-media effects

In the event that there is no aeration, the risk of methane formation is high.

Environmental performance and operational data

The bacterial inoculum presents no danger; it is harmless to humans, animals and the environment. It is pulverised with one dose in 10 litres of water for 10 tonnes of matter. The composting can be carried out within a period of 6 to 8 weeks, without needing to turn windrows over. If a platform is necessary, it is of the same dimensions as for normal windrow composting.

In a reported example of this technique, a mixture made of 57 % poultry manure and 43 % hen slurry was composted after inoculation with a bacterial complex (aqueous solution of 5–8 litres for 10 tonnes of mixture to compost). After 127 days of composting, the dry matter content reached about 69 % (an increase of more than 50 %), ammoniacal nitrogen decreased from 54 % to 24 %, whereas the organic matter was around 79 % of the dry matter and therefore very high. Temperatures inside the windrow ranged between 45 °C and 60 °C, and were maintained until the end of the test, without reversal. Complete sanitisation was achieved on day 52 of the trial, eliminating the original contaminants, including salmonella and *Listeria*. Odour emissions were substantially reduced [371, Penaud et al. 2007].

Technical considerations relevant to applicability

See also Section 4.12.4.1. There are no specific technical restrictions for on-farm application.

Economics

Indicative operating costs are EUR 0.02 per kg of fattening pig produced and EUR 10.2–11.9 per tonne of poultry manure per year. Investment and labour costs are lower, in comparison with conventional composting techniques.

Driving force for implementation

This technique makes composting simpler than the process with periodically reversed windrows or with forced aeration. Less material, machinery, space and energy than for other processes (with reversal of the windrows or forced ventilation) are needed and no reversal is required. As for the conventional composting, the degradation leads to the formation of a product that is rich in organic matter, more stable and properly hygienised.

Example plants

This technique is used in France for poultry manure. The technique is also used in hatcheries, by mixing hatchery waste with poultry manure.

Reference literature

[257, France 2010] [259, France 2010] [371, Penaud et al. 2007]

4.12.5 Anaerobic digestion of manure in a biogas installation

Description

Anaerobic microorganisms decompose the organic matter in manure, in an airtight and heated vessel or reactor in the absence of oxygen, leading to biogas production. The controlled degradation of the organic matter, without oxygen, is influenced by the pH value and temperature. The main components of biogas are methane (50–70 %) and carbon dioxide (40–50 %) depending on the substrate used. Other minor components are: H₂S, H₂O, NH₃ and N₂O. The higher the methane content, the richer in energy is the gas. Biogas production strongly depends on the type of biomass feedstock used in the process. During anaerobic decomposition, four biochemical processes are distinguished: hydrolysis, acidogenesis (fermentation), acetogenesis and methanogenesis.

The produced biogas is collected and can be used to produce heat, i.e. hot water in a boiler, combined electricity and heat in a CHP plant, or it can be used as an alternative fuel in vehicles or as a substitute for natural gas after upgrading to biomethane. Some of the heat generated may be recycled in the process.

Anaerobic digestion of slurry generates a slurry-like digestate. Solid poultry and pig manure or the solid fraction from mechanically separated slurry can be co-digested with slurry and other organic co-substrates in wet digestion. The stabilised residue (i.e. digestate) can be landspread as a soil conditioner and source of nutrients (see also Section 2.7.4). Composting is an option before landspreading of digestate in the case of sufficiently solid digestate. An example of a biogas installation following anaerobic treatment of manure is presented in Figure 4.88.



Source: [594, Agro Business Park 2011]

Figure 4.88: Example of biogas installation, following anaerobic treatment of manure, located in Denmark

The requirements for plants producing biogas using animal by-products (including manure) are specified in Regulation (EC) 142/2011 (e.g. hygiene requirements, equipment, location and other parameters).

Achieved environmental benefits

Environmental benefits (direct and indirect) of the process of anaerobic digestion, with energy recovery from the produced biogas, are as follows:

- Reduction of CH₄ emissions, which would otherwise have been emitted from the outdoor storage of untreated slurry.
- Substitution of fossil fuel consumption by electricity and/or heat produced by power-heat biogas cogeneration and/or by biomethane produced from biogas, avoiding associated indirect greenhouse gas emissions.
- Reduction of NH₃ emissions at landspreading compared to untreated manure; since the digestate is more homogenous and spreadable, it can seep more easily and evenly into the crop root area, enabling better nutrient uptake by crops.
- Improved bio-availability of nitrogen, leading to decreased use of mineral fertilisers. Anaerobic digestion does not change the overall N/P ratio but converts part of the organic nitrogen into ammonium, which is readily available for the crops. This results in an increased concentration of ammonium in digested slurry, up to 30 % depending on the manure digested, compared to untreated slurry. Due to the higher NH₄-N content of the digestate, overall ammonia emissions are reduced provided the digestate storages are covered and the digestate is spread with low-emission methods.
- Reduction of pathogens in digested manure (higher in a thermophilic range).
- Reduction of odour emissions. The odour from digestate is not as strong and pungent as from untreated slurry, and it also disappears faster from a fertilised field, partly because the digested slurry percolates faster into the soil due to its lower DM content, lower particle size and viscosity.
- Substantial reduction of COD and BOD, due to organic matter breakdown.

Slurry can also be mechanically separated at the farm with only the solid fraction transported to a centralised biogas plant for digestion. A study reports that the associated environmental benefits in comparison with slurry landspreading without any prior treatment are dependent on the efficiency of the separation technology used. The separation of volatile solids (biodegradable carbon) should be as high as possible; a polymer addition may increase the efficiency. In addition, the solid fraction should be transported directly to the plant and immediately fed into the digester. If storage is needed, it should be short and in covered storages to minimise emissions of ammonia and greenhouse gases [527, Hamelin et al. 2010] [624, IRPP TWG 2013].

In all biogas plants digesting manure, the digestate directly from the digester is still biologically active and contains degradable organic matter, the degradation of which continues in the vessel into which the digestate is directed. This vessel should be made into a gas-tight post-digestion tank which collects the biogas still produced. With energy use of this post-biogas in conjunction with the biogas from the digester, significant reductions in greenhouse gas emissions can be obtained [624, IRPP TWG 2013].

Cross-media effects

Emissions of unburnt biogas through the biogas motor/engine are around 2 % but can be up to 4 % from older technology engines. Leakages of biogas (e.g. from the anchoring points of the meters) can lead to significant emissions of CH₄ and other biogas components (NH₃, H₂S, etc.). Such emissions are known to vary significantly with equipment quality and the standard of maintenance. Best practice should aim to minimise fugitive methane emissions, since the operational efficiency of the digestion process will also be enhanced, thus maximising the production of energy [206, Silsoe 2000]. Including emissions during storage, total methane emissions of 6 kg CH₄ per tonne of pig slurry, or 4–6 tonnes CH₄ per tonne of poultry manure are reported from Belgium (Flanders).

In general, anaerobically digested slurry has a larger share of total N in the form of NH₄-N. The higher content of NH₄-N, in combination with the increased pH of the digested slurry, can lead to higher ammonia losses from storage and/or landspreading, compared with raw slurries. Due to the reduced content of organic matter, a natural crust is seldom formed on top of the liquid when it is stored in tanks, leading to a higher potential for emissions to air [533, Baltic Sea 2020 2011]. Ammonia emissions from storage of the digested slurry can be high and stores should be covered and/or slurry immediately cooled, although losses during landspreading are reported to be lower than for untreated slurry [500, IRPP TWG 2011]. These effects may counterbalance the positive effect of a faster infiltration to the soil, so overall losses may be similar with untreated slurry after surface application.

A high level of technical knowledge is needed on-farm to manage the whole process.

Environmental performance and operational data

In general, digesters operate with a maximum dry matter content of 12 %, and at a constant temperature (with up to 2 °C variation) of 30–45 °C (mesophilic) or 52–55 °C (thermophilic, with an accepted temperature variation of only 0.5 °C). Plants operating at mesophilic temperatures are therefore easier to run, so most farm-scale plants, as well as many centralised plants, are of this type [594, Agro Business Park 2011].

The process of mesophilic anaerobic digestion takes place in large digestion tanks, in one or two stages, and the hydraulic retention time is 15–40 days. Propellers are normally installed in the digestion tanks to ensure the digestate remains homogeneous and gives a maximum release of biogas. In the case of thermophilic digestion, the digester is heated to 55 °C and digestion takes 12–14 days. However, the technology is more expensive, since more energy and more sophisticated control instrumentation are needed. The advantages of thermophilic plants are higher levels of biogas production, faster throughput, improved hygienisation of the digestate, and lower viscosity during the process, facilitating mixing [594, Agro Business Park 2011].

Very short retention times decrease the level of degradation and thus may result in higher emissions later in the management of the digestate [624, IRPP TWG 2013]. The condition necessary for the successful formation of methane is a minimum water content of 50 % in the initial substrate [373, UBA Austria 2009].

The biogas production potential depends largely on the type of manure. Around 14–25 m³ of biogas production per m³ of slurry may be obtained (or even higher when pig slurry is digested), containing around 60–65 % methane. Calculations for biogas plants in Denmark show an average production of 22 m³ of biogas per tonne of pig slurry containing 6 % dry matter (on average) [594, Agro Business Park 2011].

In order to maintain digestion, part of the heat produced during CHP production is used to maintain the temperature of the biogas plant. About a third of the heat produced from such combined heat and power (CHP) units is typically used for the anaerobic digestion process itself [355, Warwick 2007]. This amount depends on scale and configuration. Net biogas power production is reported as 2.5 kWh per m³ of biogas and net biogas heat production as 2.0 kWh per m³ of biogas (after own use of heat and power in the process) [594, Agro Business Park 2011].

To reach the required temperature, manure may be warmed up using part of the produced biogas or by heat exchange with the water cooling the gas engines. In farm-scale applications, heating of the manure is not always applied. The required parasitic energy load to maintain the digester is estimated to be around 5–20 % of the gross energy production of the installation, depending on the scale and configuration. The use of 20–25 m³ of biogas in the CHP plant can produce 35 kWh to 40 kWh of electricity and 55 kWh to 75 kWh of heat energy [203, ADAS 2005].

From Germany, net biogas power production is reported to be 2.5 kWh per m³ of biogas, and, 2.0 kWh per m³ of biogas as net heat production (after own use of heat and power in the process) [594, Agro Business Park 2011]. The resource efficiency of a combined heat and power (CHP) system is about 35 % for the electrical production, or about 85 % if all the produced heat is recovered [259, France 2010].

The biogas is stored in a gas buffer before being used in a heater or a gas engine. Before the biogas can be used, sulphur must be removed by a biological, adsorptive (active coal or ferrosulphate) or chemical technique (quenching) in larger installations, in order to protect the gas engine. A double membrane cover system is used to collect a quantity of biogas from the heated slurry digestate storage tank during the cooling phase of a continuous digester [517, Petersen et al. 2011].

Due to the general manure management required by the anaerobic digester, it is estimated that total farm emissions in Finland are reduced by 40 % for ammonia, while odour and methane are reduced by 80 % [229, Finland 2010]. N₂O emissions associated with anaerobic digestion are reported to be negligible, compared to the overall annual N₂O emissions from the farm.

Since only a small proportion of the total manure mass is decomposed in a sealed anaerobic digester, the total content of nutrients in the digested manure does not differ much from raw slurries. However, data show a reduction in the slurry dry matter content of around 25 % between raw and digested slurries. The organic forms of nitrogen and phosphorus are converted into water-soluble and readily available NH₄-N and phosphorus. Digested manures show a 10–30 % higher proportion of NH₄-N.

Calculations made for the quantification of avoided greenhouse gas emission, as a result of fossil fuel substitution with biogas, show that the CO₂-neutral energy produced by the biogas process saves 2 kg CO₂ equivalent emissions per m³ of biogas. In addition, model calculations applied in Denmark show a reduction of naturally developed greenhouse gases (methane and nitrous oxide) of approximately 1.2 kg CO₂ equivalent per m³ of biogas. In total, a potential of

3.2 kg CO₂ equivalent reduction in greenhouse gases emissions per m³ of biogas are estimated [499, AgroTech 2008].

Technical considerations relevant to applicability

This technique may not be generally applicable due to the high implementation cost. There are no technical restrictions to its on-farm application. The cost efficiency is likely to increase with an increasing volume of fermented manure. The minimum farm size according to the literature (see Reference literature below) is 50 LU [506, TWG ILF BREF 2001].

The biogas production capacity of pig slurry is relatively low; hence, it often requires the addition of a proper co-substrate to increase efficiency. Possible sources of such substances are energy plants, green wastes, sewage sludge, and food residues [373, UBA Austria 2009]. For this reason, in France, Denmark and Spain, biogas production is not considered technically and economically viable with only slurry as a substrate [259, France 2010]. In Spain, a slurry biodigestion plant has been developed, with the objective of reducing greenhouse gases in the livestock sector.

Economics

The economics of anaerobic digestion systems are highly site-specific and depend on factors such as land and labour costs, effluent discharge regulations, and prices for energy produced by other sources. Where government incentives include a premium price for the electricity produced and in the case of environmental pressures that force farmers and related industries to consider alternative means to manage manure and organic wastes, the technique with associated biogas production can be economically viable.

A reported example from Finland of a farm with 263 places for farrowing sows and 784 places for weaners indicates an investment of EUR 3 536 per animal place and an operating cost of EUR 40 per animal place per year. The annualised costs are given as EUR 656 per animal place. Electricity generated on-farm is reported to be 453 000 kWh and the produced heat 700 000 kWh (equivalent to 77 000 litres of fuel oil), allowing the farm to be self-sufficient in heat and electricity [229, Finland 2010].

An example of a biogas plant for a small-scale farm is reported from Denmark, where pig slurry alone is used as a substrate for biogas production. The farm has a capacity equivalent to 2 950 fattening pig places (> 30 kg) and 500 sow places. Operational data and costs associated with the production of biogas are presented in Table 4.189.

Table 4.189: Operational and cost data for a biogas plant applied on a small-scale farm, operating with pig slurry only

Parameter	Values
Slurry produced (tonnes/year)	9 650
Products sold	100 % electricity 50 % excess heat
Prices for products (EUR/kWh)	Electricity: 0.103 Heat: 0.040
Methane produced (Nm ³ /year)	118 985
Total investment costs (EUR) ⁽¹⁾	624 000
Annual operating costs (EUR)	43 405
Annual capital costs (EUR) ⁽²⁾	60 118
Total annual costs (EUR)	103 523
Annual income (EUR)	55 040
Annual (negative) earnings after tax (EUR)	-48 483
⁽¹⁾ No financial incentives were received.	
⁽²⁾ Interest rate of 7.0 %, inflation rate of 1.5 %, taxation of 30 % and amortisation over 15 years.	
Source: [533, Baltic Sea 2020 2011]	

Driving force for implementation

High investment and operating costs are a major deterrent for the implementation of this technique; therefore, the availability of grants and high renewable energy prices would be needed to motivate the implementation of on-farm anaerobic digestion facilities [648, DEFRA 2011]. For this reason, in some Member States, the use of biogas in connection with the covering of the pig slurry stores is stimulated by financial incentives (e.g. Italy, France, Germany and Spain).

Farms can achieve self-sufficiency in electricity [229, Finland 2010]. The heat produced by cogeneration of heat and power can also be transferred to external users for residential district heating and commercial heating requirements.

Environmental policy targets for renewable energy, together with uncertainty about oil prices, may encourage the use of this technique. Co-processing with animal wastes from the food and meat industry may increase due to the increased costs of disposal brought about by the Animal By-products (ABP) Regulations [203, ADAS 2005].

Example plants

Centralised manure co-digestion installations where manure and/or energy crops and organic biological waste are used as inputs are common. In 2011, there were 180 anaerobic digesters in the Netherlands and 23 in agricultural areas of Belgium (Flanders). Around 30 farm-scale digesters are located in the UK and 3 in Belgium (Flanders). A biogas plant in Austria has been reported to be in operation since 1995. In 2003, in Italy about 50 low-cost digesters were installed, using gas which develops under the covers on slurry storage operating at low temperatures.

For the Baltic Sea region, the number of existing biogas plants for manure digestion and the amount of manure digested (estimated for the year 2012) are presented in the following table.

Table 4.190: Number of existing biogas plants for manure digestion and the amount of manure digested in the Baltic Sea region countries (estimated for year 2012)

Country	No of biogas plants treating manure	Small-scale manure digestion (reactor volume < 1 000 m ³)	Large-scale manure digestion (reactor volume > 1 000 m ³)	Amount of manure digested (t/year)
Finland	17	13	4	180 000
Sweden	40	25	15	350 000
Denmark	80	60	20	2 500 000
Germany	7 320	NI	NI	NI
Poland	16	0	16	269 000
Latvia	30	0	30	725 000
Estonia	2	0	2	140 000
NB: NI = no information provided.				
Source: [658, Baltic Manure 2013]				

An example plant is reported from Austria (Hirnsdorf) where a farm-scale biogas plant is loaded with pig slurry and other materials (laying hen manure or wastes). The biogas reactor has a volume of 750 m³ and treats around 4 500 m³ of substrate every year in bimonthly batches (the residence time is 50–60 days on average). The gas that is produced is desulphurised and fed to a CHP plant made up of two engines, with a maximum electrical power of 2 × 57 kW. Excess gas is stored in a dry gas silo reservoir. The electricity produced supplies the farm's own requirements and the excess power is fed into the public grid (between 2 000 kWh and 6 000 kWh per month). However, for the in-farm peak demands, external power has to be bought. The waste heat from the process is recovered and used in winter to heat the sorting hall

and the pig houses, as well as to fully condition the gas reactor itself. From March to September, the heat is also used to feed the maize-drying facility in the continuous flow dryer system.

Reference literature

[39, Germany 2001] [203, ADAS 2005] [206, Silsoe 2000] [229, Finland 2010] [259, France 2010] [355, Warwick 2007] [373, UBA Austria 2009] [203, ADAS 2005] [355, Warwick 2007] [499, AgroTech 2008] [500, IRPP TWG 2011] [506, TWG ILF BREF 2001] [517, Petersen et al. 2011] [527, Hamelin et al. 2010] [533, Baltic Sea 2020 2011] [594, Agro Business Park 2011] [595, Agro Business Park 2011] [624, IRPP TWG 2013] [648, DEFRA 2011] [658, Baltic Manure 2013]

4.12.6 Anaerobic lagoon system

Description

This type of liquid manure storage system is designed and operated to combine manure storage and slow anaerobic treatment under ambient temperature conditions. Slurry is stored in lagoons of at least 2 m deep where microorganisms break down organic matter in the absence of free oxygen. The lagoon may be covered to retain heat and collect biogas.

Slurry is placed in a settling basin (or lagoon), from where it overflows or is pumped into the anaerobic lagoon system (often three to five earth-banked structures). The solid part (sludge sedimentation) is used in landspreading, while the liquid fraction, after anaerobic treatment, is used to irrigate and fertilise fields or may be recycled as flushing water. Anaerobic treatment can be followed by a final aerobic stage before the liquid fraction is applied or discharged, if the characteristics and legal conditions allow for it [364, Portugal 2010].

The technique may involve mechanical separation of slurry before filling the lagoon, with subsequent separate treatment of the solid and liquid fractions; with the liquid being sent to the lagoon system. Mechanical separation of slurry can prevent the capacity decrease of lagoons caused by sludge sedimentation and can reduce the organic matter in the liquid part.

Anaerobic lagoons are designed for varying lengths of storage (up to 1 year or longer), depending on the climate, the content of volatile solids of the slurry, and other operational factors.

Achieved environmental benefits

The aim of the treatment is to improve the characteristics of both solid and liquid manure fractions so that they can be used as fertiliser. In particular, the organic load (BOD, COD) is reduced. Manure is stabilised and odour is reduced. More homogeneous manure is produced that is easier to manage and pump.

Information on anaerobic lagoons also refers to the discharge option or to application in situations where otherwise this would have had an unwanted environmental impact. It is questioned whether in these cases anaerobic lagoons solve or add to the problem of manure application.

Cross-media effects

In general, CH₄ emissions from an anaerobic system are expected to be significant. Odour may develop from the lagoons, as well as NH₃ and N₂O emissions [506, TWG ILF BREF 2001]. After separating out the liquid fraction, a solid fraction remains, which then has to be treated (e.g. composting).

Energy is required for the separation of the solid fraction and for pumping the liquid between basins. Natural height differences in the countryside are used to make the liquid flow by gravity from one lagoon to another. At the end of the separation, a liquid fraction remains that has to be disposed of.

Large surfaces, especially in warmer climates, are subjected to high evaporation rates and a consequent increase of salt content in the slurry. This effect needs to be taken into consideration at the time of landspreading.

Environmental performance and operational data

The lagoon system is considered to be relatively easy to operate. Generally, an installation separates the solid fraction mechanically. The liquid manure that remains can stay in the different lagoons for up to a year. The final aerobic step is optional, consequently not all farms have an aeration installation.

In cold weather (below 22 °C), CH₄ emissions are linearly related to the slurry temperature. At higher temperatures, the variation of CH₄ emissions depends on the slurry composition, wind speed and air temperature [496, Sharpe et al. 1999]. IPCC guidelines (2006) propose a methane emission factor for uncovered anaerobic lagoons from 66 % to 80 % of the methane potential of the volatile solids, for temperatures in the range of 10–28 °C; the technique is the manure management method with the highest methane emissions [659, IPCC 2006].

Results reported by Portugal for slurry treatment in anaerobic lagoons as the final step of a combination of treatments are presented in Table 4.191. The associated emission levels for the most important parameters indicate that effluents from anaerobic lagoons could be used for landspreading, but would not be compatible with discharge in watercourses, since the liquid would not comply with the emission limit values set for waste water discharges to surface waters, in particular for BOD₅ (40 mg/l O₂) and total suspended solids (60 mg/l) [364, Portugal 2010].

Table 4.191: Characteristics of effluents from slurry treated in anaerobic lagoons

Treatment	BOD ₅ (mg/l O ₂)	Total suspended solids (mg/l)	Total N (mg/l)	Total P (mg/l)
Mechanical separation, plus 4–5 anaerobic lagoons	191–500	147–200	526–1 100	21–27
NB: Data refer to annual averages of analyses carried out in three different farms. Source: [364, Portugal 2010]				

Technical considerations relevant to applicability

Anaerobic lagoons are applied to farms with sufficient land to allow for a series of lagoons to be applied to cover the different treatment steps. Lagoons are particularly suitable for large capacities. Note however that the temperature requirements for the anaerobic process make the technique less suitable for areas that experience cold winters.

Economics

Costs vary, depending on the geophysical characteristics of the soil, the size of the farm, and on the intended purpose for the treated slurry.

Driving force for implementation

Lagoon systems offer odour abatement, a long-term reservoir for liquid manure, and high flexibility for the timing of landspreading of the manure. The technique provides combined slurry stabilisation, separation and storage.

Legislation on landspreading of waste water or discharge to surface waters has contributed to the application of anaerobic lagoons in some Member States, such as Portugal and Greece. Legislation in Portugal was enforced to limit the discharge in watercourses, setting stricter values, which are seldom achievable by the use of anaerobic lagoons.

Example plants

In Portugal, the treatment of pig slurry in anaerobic lagoons, preceded by mechanical separation of the solids, is usually applied. The technique is also applied on farms in Greece and Italy.

Reference literature

[364, Portugal 2010] [410, Greece 2001] [496, Sharpe et al. 1999] [506, TWG ILF BREF 2001] [659, IPCC 2006]

4.12.7 Evaporation and thermal drying of manure

Description

The objective of this treatment is to obtain a dried, easy-to-handle product from solid manure or slurry, retaining most of the nutrients (nitrogen, phosphorus) and organic matter of the original material. Depending on the required moisture content of the final product, a preliminary evaporation step is required, where water is removed from the slurry. The heat source employed for the evaporation may consist of recovered waste heat from a combined heat and power engine or from other processes. There are two variations of the evaporation technique:

- Vacuum evaporation: At temperatures lower than 100 °C (typically 50–60 °C) and pressure conditions below the vapour pressure of the liquid, water and other volatile components evaporate and are subsequently recovered by condensation. Evaporation units are usually formed by two or multiple steps. If the pH inside the evaporator is maintained under 5.5, it is ensured that the ammonium will be recovered in the concentrate.
- Atmospheric evaporation: Evaporation takes place at atmospheric pressure and a moderate temperature from the liquid fraction of aerobically treated slurries. In this case, the manure is ground and mixed first. Using a heat exchanger, the manure is then heated to 100 °C by means of warm condensate and kept at this temperature for about 4 hours, while degassing occurs. Any foam that has been formed is degraded.

Following the evaporation stage, the manure is dried by a drying machine and compressed (1.4 bar). Any water vapour that is formed is compressed, which raises the temperature to 110 °C. This hot vapour is then used in a heat exchanger, thereby drying the manure using the sensible heat of the vapour. The vapour is finally recovered as condensate.

Achieved environmental benefits

The technique allows a dried product to be obtained with a higher nutrient concentration, which facilitates its management, with a relatively low energy consumption and reduced emissions to air and water. Organic matter is sanitised (depending on the time and temperature of the process).

Cross-media effects

Energy consumption is required for the thermal drying of manure. For an industrial-scale facility, a reported estimation of the thermal requirements is 15–18 kW/m³ for an acidified digested slurry entering the evaporator with a dry matter content of 25–30 % [594, Agro Business Park 2011]. The application of mechanical vapour compression (drying machine) has an energy consumption of about 30 kWh per tonne of water evaporated.

In the case of atmospheric evaporation, emissions of ammonia, VOCs and non-condensable odorous compounds occur, while, with vacuum evaporation, there are no emissions to air, since the evaporated fraction is recovered as condensate. If atmospheric evaporation is preceded by aerobic treatment (aerobic digestion and total or partial nitrification-denitrification, with carbon and nitrogen removal), emissions will be limited [256, VITO 2006] [594, Agro Business Park 2011].

The potential gaseous emissions from the drying step have to be recovered (e.g. by scrubbing), in particular to avoid ammonia (NH₃) or organic volatiles (VOC) emissions. If the input slurry comes from the anaerobic digestion process, the volatilisation of organic matter is reduced and the heat from a CHP engine using biogas produced by the anaerobic digestion can cover part (10–20 %) of the thermal energy needs. Ammonia emissions from the dryer can also be controlled by using the input slurry from a previous nitrification-denitrification or acidification process.

Copper, zinc and other metals are present in the dried product (depending on their concentration in the raw manures); this could limit the landspreading of dried manure. The product of drying, because of the NH₃ volatilisation, will not have an equilibrium between carbon and nitrogen for subsequent uses [624, IRPP TWG 2013]. The volume of slurry/manure is reduced (reducing the transport costs).

Environmental performance and operational data

The products of this technique are pulverised manure with 85 % dry matter content and an effluent, which is the residual condensate. This condensate is low in nitrogen and phosphorus and has a COD of less than 120 mg/l. A water removal efficiency of over than 85 % is reported. In addition, 95 % of the nitrogen (if previously acidified), and almost all of the phosphorus and potassium of the input manure could be conserved in the dried product.

The maximum dry matter content of the concentrate that can be achieved with the vacuum evaporation technique is around 25 % [256, VITO 2006]. It is also reported that a pig slurry with 2.5–3.5 % dry matter can be concentrated up to 25–30 %. If the pH is maintained below 5.5, the recovery of nitrogen remaining in the concentrate will be higher than 98.0 %. The efficiency of atmospheric evaporation is high (up to 90 % nutrient recovery), but highly dependent on previous treatments (organic matter removal/nitrogen removal or acidification treatment) [594, Agro Business Park 2011].

The system is affected by the heterogeneity of the manure, foam formation and corrosion. The selection of the construction materials is of great importance, in particular resistance to high temperature and corrosion.

Concerning energy consumption, an increasing number of evaporation steps results in a significant decrease in energy consumption. A single-step evaporator requires 1.1–1.25 tonnes of steam for each tonne of water evaporated, while a five-stage vacuum evaporator requires 0.25 tonnes of steam per tonne of water evaporated [256, VITO 2006]. The estimated heat needed for a large-scale unit, operating with vacuum evaporation, treating 6–8 m³/h of acidified pig slurry with a dry matter content of 0.9–1.2 %, is reported as 250–280 kW/m³ [594, Agro Business Park 2010].

Technical considerations relevant to applicability

The technique has been developed for use on large farms. The maximum capacity is 15–20 m³ per day. Subsidies (e.g. for power production) are usually necessary to make these kind of treatment facilities economically feasible [594, Agro Business Park 2011].

Economics

Costs depend on several factors and a general indication is difficult. Investment costs are (partly) determined by the water evaporation capacity, type of evaporator, configuration used (e.g. number of stages), the construction material, available heat, etc. An example of investment and operating costs reported from Belgium (Flanders) is presented in Table 4.192, for a vacuum evaporation plant with a capacity of 14 000 tonnes per year, treating pig slurry [256, VITO 2006].

Table 4.192: Costs for a vacuum evaporation plant for pig slurry, with a capacity of 14 000 tonnes/year

Parameter	Unit	Costs
Investment costs	EUR	490 000
Annualised investment costs	EUR/t	6
Operating costs (including pretreatment)	EUR/t	4.5
Total costs (including storage, buildings, infrastructure)	EUR/t	17
<i>Source:</i> [256, VITO 2006]		

At the industrial scale, vacuum evaporation units are usually formed by two or multiple steps. The energy consumption for single-step evaporators is very high and accounts for most of the cost of the evaporation system. Each added evaporation step reduces the energy consumption by 33 % (although investment costs are increased).

Driving force for implementation

Local restrictions on nutrient supply may force the use of such a technique, since the resulting concentrated product is easier and cheaper to transport and spread on the land. Another benefit of the concentration by vacuum evaporation is that it has practically no negative effects regarding direct emissions, including odours, since evaporated water is recovered as a condensate, which could then be reused [203, ADAS 2005] [594, Agro Business Park 2011].

The dried product could be considered as sterilised (depending on the time and temperature of the process) and, depending on its quality, it may represent a source of income as organic fertiliser.

Example plants

The technique is used in Belgium (Flanders) in several manure processing systems. Three plants are reported to operate in Spain with atmospheric evaporation. Vacuum evaporation is applied in at least three plants in Spain and one plant in France [594, Agro Business Park 2011].

Reference literature

[409, VITO 1997] [203, ADAS 2005] [256, VITO 2006] [594, Agro Business Park 2011] [624, IRPP TWG 2013]

4.12.8 External tunnel for manure drying

Description

Manure is collected on manure belts from the laying hen house and is conveyed to separate, perforated belts in a ventilated tunnel for drying. The tunnel is ventilated with warm air that is extracted from the hen house. The manure is dried in about 2 to 3 days, reaching an average dry matter content of 60–80 %. The tunnel is usually built at the side of the hen house.

In the design shown in Figure 4.89, the incoming manure is sent to the top of the tiered belt and is carried along each belt from one end to the other and then drops to the lower belt that rolls in the opposite direction. Droppings have to be spread in relatively thin layers (5–15 cm) over the perforated belts in which the holes or perforations increase airflow through the droppings for drying. After drying, the manure is sent to a separate covered storage facility or to a container.

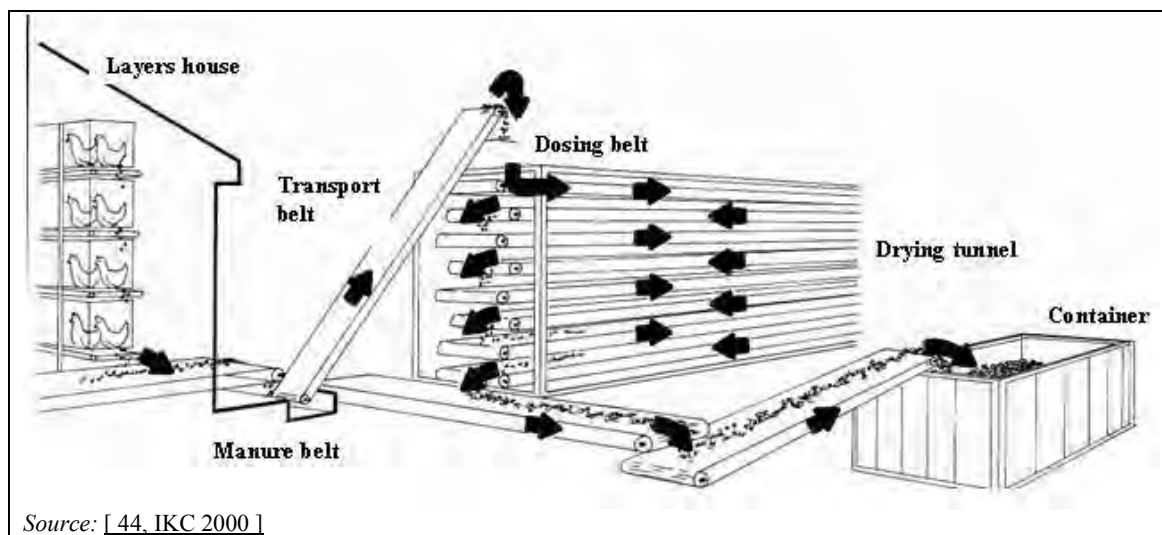

Source: [44, IKC 2000]

Figure 4.89: Principle of external drying tunnel with perforated manure belts

Achieved environmental benefits

The high dry matter content that is achievable with this technique reduces ammonia and odour emission from subsequent manure storage and landspreading, in comparison to systems with a lower dry matter content in the manure.

Cross-media effects

Only limited extra energy (electricity) is needed to operate this system, because the fans for the drying tunnel are the same as those used for the ventilation of the hen house; however, at the same time more belts have to be operated, so extra energy is required to run the additional belts. The ventilation system needs 20–30 % more power to overcome the resistance due to the additional room where the drying system is hosted [150, CRPA 2008].

If the process is not fast or complete enough to dry the droppings (e.g. 80 % in 72 h), an inverse effect may occur where NH_3 is formed and extracted to the air by the blowing drying air. If regular container transport is not possible, a separate storage facility will be necessary for the dried manure.

Environmental performance and operational data

From Italy it is reported that the dry matter content of the manure leaving the hen house varies by season from 26 % to 47 %; it can be dried in the tunnel to a dry matter content ranging from 55–60 % in winter to over 85 % in summer. If the manure is dried to 60 % DM as fast as possible before uric acid hydrolysis takes place, then further drying will not lead to NH_3 emission [508, TFRN 2014]. In France, manure drying is sometimes coupled with a system for pelletising the droppings [368, France 2010].

Emissions during storage and landspreading of the dried manure are significantly reduced. Measurements during storage show that ammonia losses amounted to 4 % of the total N in the heap and that during landspreading they amounted to 1.1 % of the applied total N and to 10.4 % of TAN. The reduction of ammonia emissions from landspreading of dried hen manure with respect to wet droppings was over 90 % with respect to total nitrogen and 65 % with respect to N-NH_4 [141, Italy 2010]. Similar results are obtained by other studies where losses of total N after landspreading amounted to 1.1 % in summer and 0.5 % in autumn for the dried manure, in comparison with 15.2 % and 7.7 % of total N for the untreated manure [150, CRPA 2008].

Over the whole year, average emissions of ammonia and some greenhouse gases from the laying hen house and from the drying tunnel are those reported in Table 4.193.

Table 4.193: Average ammonia, methane and nitrous oxide emissions from the laying hen house and drying tunnel

Emission	Layers house		Drying tunnel	
	Yearly average	Min.–Max.	Yearly average	Min.–Max.
	kg/ap/yr	kg/ap/yr	kg/ap/yr	kg/ap/yr
NH ₃	0.152	0.044–0.290	0.167	0.126–0.210
N ₂ O	0.002	0.000–0.017	0.001	0.000–0.003
CH ₄	0.094	0.000–0.354	0.010	0.003–0.028
<i>Source: [141, Italy 2010]</i>				

During operation of the drying tunnel, ammonia emissions are higher at the first stage of processing but decline steadily over the second and third day.

Considering the seasonal trends of overall emissions of the hen house and of the drying tunnel, it is measured that emissions from the hen house are higher in summer and that those from the drying tunnel are higher in winter. This is due to the drastic reduction of NH₃ emissions when the dry matter content of the manure goes over 60 % which is achieved early in the first part of the tunnel during the summer with a minimal contribution to emissions from the final part, whereas, in winter, the manure from the laying hen house is wetter and most of the dehydration occurs in the tunnel, which shows higher emissions than from the house itself.

Measurements of odour concentration in the air extracted from both the hen house and the drying tunnel fans showed low values, on average equal to 63 ou_E/m³ (23 144 ou_E/m³) in the case of the hen house and 86 ou_E/m³ in the case of the tunnel (26 195 ou_E/m³) [141, Italy 2010].

Technical considerations relevant to applicability

This system is only applicable to manure from laying hen houses. It is applicable to existing houses with manure belts as it hardly interferes with the existing structures. It just requires a means of extracting warm air to supply the drying tunnel.

Economics

Cost data relate to its application in Italy. Although investment costs have not been reported, the extra investment costs for the tunnel may be offset by the fact that the cost for the external manure storage is lower. The extra costs for energy are limited, equal to only EUR 0.03 per bird place per year. The total extra operating cost (including capital + operating costs) is EUR 0.06 per bird place per year. This means that, with a 70 % NH₃ reduction, the cost is EUR 0.37 per kg of NH₃ abated [43, COM 2003].

Driving force for implementation

Once the manure is very dry, only very low levels of emissions of ammonia and odour will occur in the storage period. This technique could offer an advantage where odour is a local social constraint.

Example plants

It has been reported that the system has gained interest among Italian poultry farmers. Variations of the technique have been developed in France.

Reference literature

[43, COM 2003] [44, IKC 2000] [141, Italy 2010] [150, CRPA 2008] [259, France 2010] [368, France 2010] [508, TFRN 2014]

4.12.9 Slurry acidification

Description

Slurry acidification is a technique for reducing ammonia emissions from pig farms by adding sulphuric acid to the slurry. The equilibrium between $\text{NH}_4\text{-N}$ and NH_3 in solutions depends on the pH (acidity). A low pH favours retention of $\text{NH}_4\text{-N}$ (in the form of ammonium sulphate) at the expense of ammonia ($\text{NH}_3\text{-N}$) volatilisation.

The slurry is pumped from the pig houses to a process tank by means of a valve pit, where the right dose of sulphuric acid is added to lower the pH to 5.5. The amount of sulphuric acid is controlled by a pH sensor. In the process tank, slurry is also aerated and homogenised by injecting compressed air, to prevent sulphate ions changing into noxious hydrogen sulphide and to improve the fluidity of the slurry as part of the dry matter content is degraded. Part of the treated slurry may be used to flush the storage pits under the housing floors, in a sufficient quantity to allow 10–15 cm of slurry, ensuring that the pH in the slurry pits is kept at about 5.5. In this way, ammonia volatilisation from further dung dropping into pits is inhibited.

The rest of the treated slurry is pumped from the process tank into a storage tank, from where it can be transported and spread on the field as fertiliser at a later stage. All process steps are automatically controlled and monitored [594, Agro Business Park 2011].

A schematic representation of the slurry acidification system is shown in Figure 4.90.

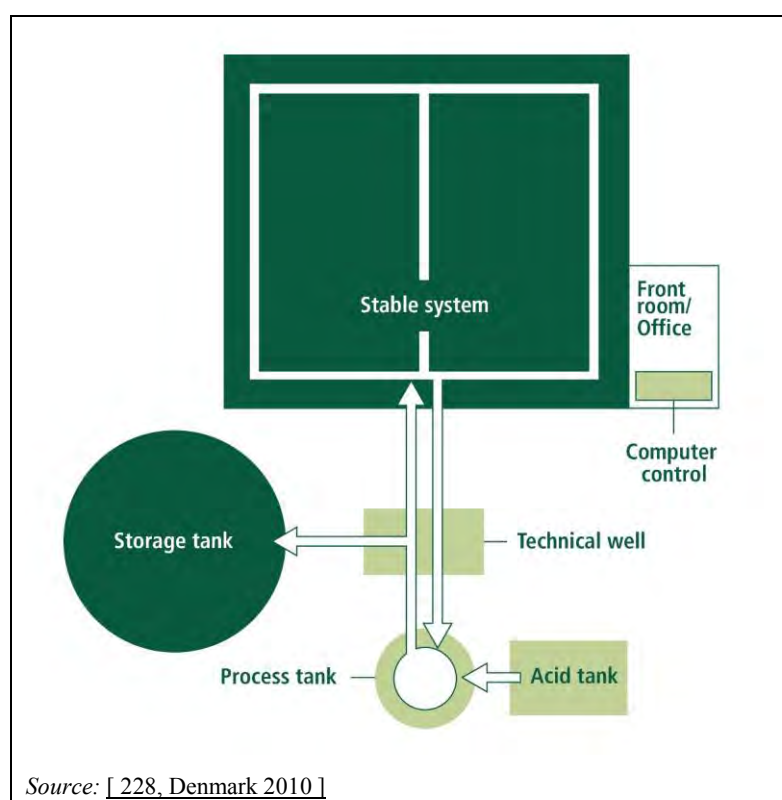

Figure 4.90: Schematic representation of a slurry acidification system

One reported variation of the technique is based on the acidification of the slurry directly in the storage tank, by adding sulphuric acid while the slurry is agitated, just before it is transferred to the field for landspreading (see Figure 4.91).



NB: In the picture on the left, the aggregate is agitating the slurry via pumping, while sulphuric acid is added to the pipe. In the picture on the right, slurry is agitated by a propeller, while sulphuric acid is added to the pipe.

Source: [599, Denmark 2012]

Figure 4.91: Systems for slurry acidification directly in the storage tank

Acidification can also be applied continuously during landspreading of the slurry. Sulphuric acid is transported and stored in a suitable (officially approved) container mounted on the front of the tractor that pulls the liquid manure spreader/slurry tanker (see Figure 4.92). The acid is pumped through pipes, from the container positioned in front of the tractor to the outlet of the manure spreader, where the liquid manure is mixed with the acid in a static mixer before the slurry is pumped into the device used to apply the acidified slurry on the soil, such as a trailing hose. The system continuously controls the rate of acid being added to the slurry by online pH measurement of the acidified slurry. The amount of spread slurry is also continuously measured.

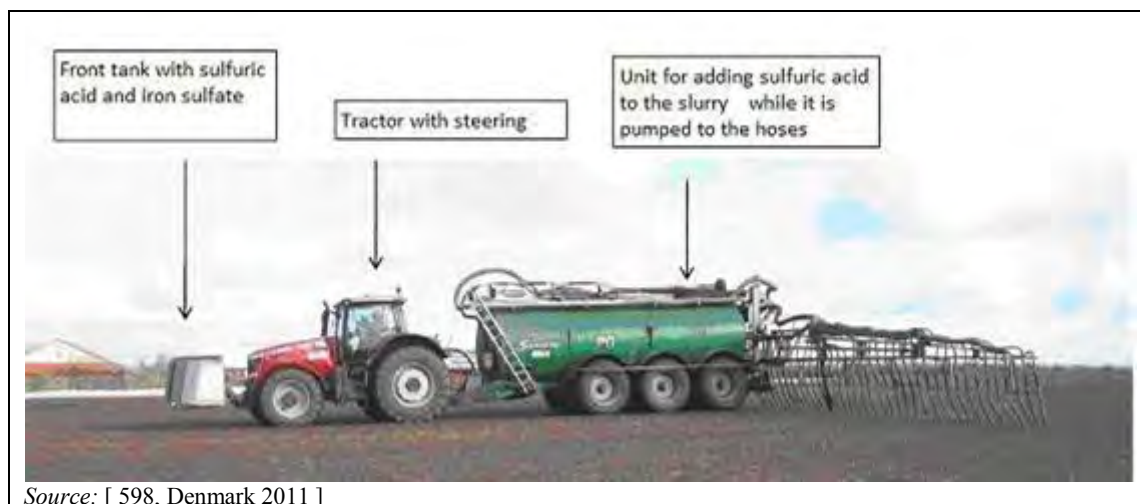

Source: [598, Denmark 2011]

Figure 4.92: Equipment for slurry acidification during spreading

Achieved environmental benefits

Slurry acidification strongly inhibits ammonia volatilisation, by formation of ammonium sulphate, from all production stages of pig rearing where acidified slurry can be used: housing, storage and landspreading. As a result of inhibition of ammonia volatilisation, acidified slurry retains more nitrogen, making the treated slurry richer in nutrient value, which will eventually result in measurably higher crop yields when spread as fertiliser. The reduction of ammonia emissions significantly improves the air quality in the animal houses, providing improved animal welfare and a better working environment.

In theory, methane emissions from housing and outdoor storage could be substantially reduced, due to inhibition of methanogenic bacteria at the low pH. Similarly, potential nitrous oxide

emissions from storage could be reduced, if acidification prevents a surface crust formation, due to the reduced microbial activity in the slurry.

Cross-media effects

Handling strong acids on farms is hazardous [508, TFRN 2014]. A fully automated system, with no manual contact with sulphuric acid and automated management of the slurry (including discharging operations), is necessary for safety reasons [228, Denmark 2010]. Also, corrosion may occur [571, Eurich-Menden et al. 2011].

Slurry acidification leads to qualitative changes in odour emissions, rather than an increase in overall odour. Odour peaks can arise as a result of daily aeration/mixing and pumping of manure. There is potential for gaseous hydrogen sulphide emission if sulphate is reduced to H₂S in stored slurry, provoking odour problems [598, Denmark 2012]. If acidified slurry is used in a plant producing biogas, there is a theoretical risk of bacterial inhibition based on the high proportion of acidified slurry.

The technique may lead to marginal soil acidification, increasing the need for liming. All practical experience shows this is a minor issue corresponding to less than 10 % of the additional liming needed. Theoretically, 1.4 kg lime should be landspread to neutralise each kg of sulphuric acid used for slurry acidification. In Denmark, most farmers take soil samples about every fourth year, to estimate the need for fertilisers and lime. If acidified slurry has been applied within that period of time, a larger amount of lime than usual will have to be added to neutralise the soil pH, but the frequency of application does not change. Liming and landspreading of acidified slurry do not necessarily take place at the same time [598, Denmark 2012].

In the case of acidification inside the slurry storage tank, due to foaming of the slurry, a freeboard of 0.8–1 m is required in the tank; therefore, the storage capacity of the tank cannot be fully utilised.

Environmental performance and operational data

Untreated slurry has typically a pH of 6.5–8. In order to ensure the reducing effect on ammonia volatilisation, the acidification should bring the pH to a level no higher than 6.0. In commercial operations, the pH is often brought down to a value of 5.5, in consideration of the instability of acidified slurry and its varying buffer effect. The target pH depends on the time span from acidification until landspreading. Therefore, slurry that is acidified to a pH below 6.0 should be landspread as fertiliser within 24 hours; the pH should be maintained below 5.5 in cases when the slurry is not spread on the fields within 21 to 90 days. If spreading of the acidified slurry is delayed more than 90 days, then the pH should be verified in order to ensure that it is still less than 6.0, or more acid should be added.

In general, the amount of sulphuric acid needed for a tonne of slurry is approximately 2.5–3 litres, corresponding to about 4.6–5.5 kg of acid [599, Denmark 2012]. Other sources report a consumption of sulphuric acid in the range of 5 kg to 7 kg for each tonne of raw slurry, to reduce the pH to between 5.5 and 6 [594, Agro Business Park 2011].

Installations are farm-fitted with a process tank, automated valves, and piping systems where necessary. The technology typically requires the slurry to be treated only once. The whole process is fully automated, allowing the farmer to continuously monitor all operational and environmental aspects of the slurry management system (continuous measurement of pH, amount of slurry treated and stored, and status of sulphuric acid supply).

Comparative data from a whole-farm assessment carried out in Denmark, concerning the application of slurry acidification, report that gaseous nitrogen emissions produced per growing/finishing pig (30–100 kg live weight) without slurry acidification are 0.50 kg N from housing, 0.24 kg N from manure storage, and 0.25 kg N from application of slurry to land. When using acidified slurry, emissions are 0.15 kg N, 0.03 kg N, and 0.10 kg N, respectively,

for housing, storage and landspreading. The nitrogen balance at the base of the whole-farm assessment is presented in Figure 4.93, where data for the acidified slurry are compared with those for untreated slurry.

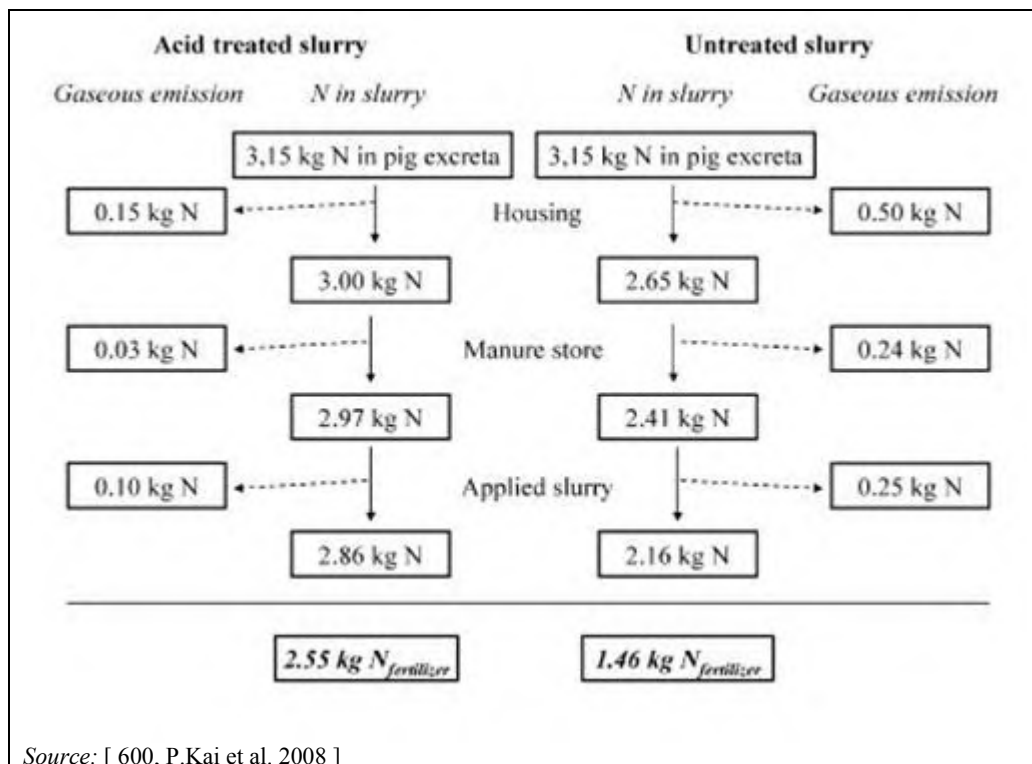

Figure 4.93: Whole-farm assessment of the slurry acidification effect on the nitrogen available for plant uptake

From a whole-farm assessment carried out in Denmark on the basis of laboratory tests simulating slurry storage, the reduction of methane is reported as being from 3.29 kg to 2.2 kg per tonne of slurry stored in houses, and 1.94 kg to 0.78 kg per tonne of slurry in stores. The reduction of N₂O is reported as being from 0.013 kg to 0.0022 kg per tonne of slurry from housing, and 0.033 kg to 0.021 kg per tonne of slurry from stores [228, Denmark 2010].

A total reduction of 65–70 % for ammonia emissions is also reported by another source, for housing and slurry storage [594, Agro Business Park 2011]. An estimated 60 % reduction in ammonia emissions is reported when slurry is acidified during landspreading [508, TFRN 2014]. In summary, emissions are reduced by 75 % in houses with fully slatted floors, and by approximately 80 % in houses with partly slatted floors. Another 50 % reduction is induced in covered storages, 90 % in uncovered storages, and 67 % in landspreading of slurry by trailing hoses.

The increased energy, associated with the use of slurry, is estimated as 1.8–3 kWh/m³ of slurry [594, Agro Business Park 2011]. Examples of increased odour problems have been reported as occurring locally near the process tank of the acidification unit. Elimination of the problem is feasible by mounting a carbon filter in the process tank.

Technical considerations relevant to applicability

No technical restrictions are reported for the implementation of the technique. Around 80 % of existing Danish houses can be retrofitted with the technique without major renovations.

The alternative of acidification during spreading has not been tested with irrigation systems and broadcast spreading. With injection techniques, the effect of the emissions reduction is expected to be limited.

Economics

The investment required for the installation of one acidification unit for a pig house (which can handle up to six sections, with 400 m³ of slurry each) is about EUR 200 000. The annualised investment cost is around EUR 13 300, based on a 15-year depreciation period. The annual operating costs consist of the maintenance cost (EUR 2 000), the extra electricity consumption (about 3 kWh per tonne of treated slurry), and the costs for the sulphuric acid. Suppliers' estimations of the total annual costs range from EUR 1 to EUR 2 per tonne of treated slurry.

The extra costs for the technique are reported to vary between EUR 1.4/ap/yr and EUR 7/ap/yr. The extra operating costs for the slurry acidification technique, reported by Denmark in relation to the number of fattening pigs produced, are presented in Table 4.194.

Table 4.194: Cost data reported for slurry acidification in relation to the number of pigs, in Denmark

Fattening pigs (32–107 kg) produced	Total annual extra costs ⁽¹⁾	Total extra costs per pig produced ⁽²⁾ ⁽³⁾		Total extra cost per kg N reduced incl. value of saved N
	EUR/yr	EUR/pig	%	EUR/kg N reduced
2 700	20 130	6.8	10	14.4
5 400	22 300	3.4	5	7.5
9 000	24 600	2.1	3	4.4
18 000	33 000	1.2	2	2.5
27 000	41 600	0.8	1	2.0
34 200	48 100	0.7	1	1.6

⁽¹⁾ Value of N is excluded.
⁽²⁾ Value of saved N is included.
⁽³⁾ Reference for production cost: EUR 69 per pig produced.
Source: [594, Agro Business Park 2011]

For a slurry acidification unit treating 10 000 m³ of slurry per year, the breakdown of estimated operating costs is reported in Table 4.195.

Table 4.195: Operating costs for a slurry acidification unit treating 10 000 m³/yr, in Denmark

Parameter	EUR/m ³
Energy consumption	0.17
Acid consumption	0.72
Maintenance and service	0.29
Total costs	1.18

Source: [594, Agro Business Park 2011]

A total additional cost of approximately EUR 20 per ha is reported where acidified slurry is applied, for both variations of slurry acidification: in storage tanks and during landspreading; this extra cost includes depreciation of the investment.

Driving force for implementation

The reduction of ammonia emissions significantly improves the air quality in the animal houses, providing improved animal welfare and a better working environment. Farmers in Denmark are required to adopt low-emission measures to obtain an environmental permit to expand their production capacity. The higher nitrogen content of slurry generates economic benefits due to

the lower use of mineral fertilisers. The use of slurry acidification during landspreading facilitates the application of the acidification technique, since it is not dependent on alterations within the pig housing.

Example plants

Slurry acidification is reported to be in operation in Denmark (around 125 farms) and Spain (over 20 farms with medium- and large-scale applications) [508, TFRN 2014] [595, Agro Business Park 2011]. The systems for slurry acidification in storage tanks and during landspreading are relatively new technologies.

Reference literature

[228, Denmark 2010] [508, TFRN 2014] [571, Eurich-Menden et al. 2011] [594, Agro Business Park 2011] [598, Denmark 2012] [599, Denmark 2012] [600, P.Kai et al. 2008]

4.12.10 Combustion of poultry litter for energy recovery

In general, on-farm combustion plants for poultry litter have capacities below the threshold value of three tonnes per hour set by the Industrial Emissions Directive (2010/75/EU), Annex I, Activity 5.2: 'Disposal or recovery of waste in waste incineration plants or in waste co-incineration plants for non-hazardous waste'.

Description

Untreated deep poultry litter, the solid fraction from slurry mechanical separation, thermally dried or other solid manure with a low moisture content can be combusted and converted into energy. The recovered thermal energy can also be transformed into electricity.

Air (oxygen) is introduced in excess to thermally oxidise ($T > 900\text{ }^{\circ}\text{C}$) carbon, hydrogen and sulphur contained in manure's organic matter. In the case of complete combustion, all volatile solids are transformed to gases and the ashes will contain only inorganic material. If combustion is not complete (insufficient oxygen or low degree of turbulence), volatile solids can be found in the ashes and CO in the exhaust gases. Once the installation has started, no additional fuel is necessary to incinerate the litter given its DM content of 55 %.

A steam generator is used to recover thermal energy. The steam generated can be transformed to electricity in a steam turbine. For manure with a high moisture content, a previous drying (and pelletising) process may be appropriate in order to increase the energy efficiency of the plant [594, Agro Business Park 2011].

Different types of furnaces can be used, such as grate incinerators, rotary kilns or fluidised bed reactors. See the WI BREF for more detailed information about combustion technologies and thermal treatment systems [705, COM 2017].

Conventional combustion chambers (grate incinerators)

Broiler litter is automatically fed from storage into a first combustion chamber at a temperature of $400\text{ }^{\circ}\text{C}$, where it is gasified on a moving grate by an airflow supplied at the bottom of the litter layer. During the gasification process, the poultry litter is transported over the grate through a second combustion chamber where the mixture is rapidly heated, (i.e. within 3 seconds), up to a temperature of $1\,000\text{ }^{\circ}\text{C}$ to $1\,200\text{ }^{\circ}\text{C}$ with a controlled oxygen supply. The hot flue-gases leaving the second chamber go through a heat exchanger, in which water is heated to a temperature of about $70\text{ }^{\circ}\text{C}$.

Fluidised bed combustion

Combustion air is blown from below through a 'bed' of sand or other inert material at a high enough velocity to keep the material suspended. The sand is preheated to raise the temperature so that incoming material will ignite and burn efficiently. The constantly moving mass provides good heat transfer within the bed, which helps to deal with the high ash and variable moisture

content. Fluidised beds suspend solid fuels on upward-blowing jets of air during the combustion process. The result is a turbulent mixing of fuel, gas and solid sand particles. The tumbling action provides more effective chemical reactions and heat transfer [553, bhs1 2011] [500, IRPP TWG 2011].

A tall furnace maintains combustion gases at a temperature over 850 °C for over 2 seconds in accordance with the Animal By-Product Regulation (EC) 1069/2009. Temperature is regularly monitored. The retention time is calculated based on the flow rates of gas and the height of the stack.

The litter is transferred from poultry sheds to a bio-secure storage area, from where no further contact takes place with the farm production or operatives. The fuel is automatically transferred into the combustion chamber and the whole process is remotely managed. The heated water that is produced after the combustion is used for heating production houses.

Achieved environmental benefits

The combustion of poultry litter as fuel for the production of heat allows for the substitution of fossil fuels with renewable sources. The calorific value of poultry litter is reported to range between 10.8 MJ/kg and 12 MJ/kg of dry matter [564, bhs1 2012] [553, bhs1 2011] in the UK and between 14 MJ/kg and 16 MJ/kg of dry matter in Belgium (Flanders) [256, VITO 2006].

The main factor affecting energy recovery is the water content of the manure. Based on data from incinerators in the UK, the combustion of poultry manure can produce about 500 kWh of electrical energy from each tonne of chicken manure with 60 % dry matter [256, VITO 2006].

Changing from indoor LPG or propane combustion to biomass heating reduces moisture production and therefore humidity in the poultry houses, thus avoiding the generation of a damp atmosphere and the acceleration of NH₃ formation from droppings. The reduced humidity in the houses also enables a more efficient management of the ventilation and reduced litter requirements (up to 20 %).

Another benefit of this technique is the production of an ash that can be used as a fertiliser since it is rich in phosphorus and potassium. However, the availability of phosphate to crops is still under study [594, Agro Business Park 2011] [256, VITO 2006].

Cross-media effects

There is a potential risk of emissions (e.g. NO_x, SO_x, H₂S, HCl, PCDD and PCDF, dust, metals). Equipment to control emissions from the combustion process is required in all cases. Odour emissions are low due to the high temperatures achieved in the combustion chamber. SO₂ emission can be limited as a result of added chalk. Losses of nutrients and organic matter are due to manure combustion, which have to be replaced by manufactured mineral fertilisers [624, IRPP TWG 2013].

The flue-gases are filtered through a dust filter that reduces the dust concentration. Ashes removed by the air cleaning system have to be disposed of in controlled landfills [594, Agro Business Park 2011].

Environmental performance and operational data

Poultry litter comprises a heterogeneous mixture of manure, bedding material, waste feed, broken eggs and feathers removed from the poultry sheds. The composition seems consistent enough over geographic areas due to animal by-product rules and the industry's own quality production standards (e.g. bedding materials and feed used). The technique results in a substantial reduction of volume and mass (70–90 % mass reduction). This residue can be sold as fertiliser.

Reported fluidised bed combustion units have a range of capacities of 2.4 tonnes, 5.5 tonnes and 12–13 tonnes per day of litter manure, with thermal outputs from 200 kWh to 995 kWh. Any

fall in combustion temperature is detected by the automatic control system that allows supplementary fuel to be used to keep the operating temperature at 850 °C. This temperature is required to ignite moist fuels, to prevent the agglomeration of potassium, to achieve 100 % combustion of fixed carbon, and to thermally decompose all organic pollutants present in poultry litter.

Examples of associated emission levels from a fluidised bed combustion plant for poultry litter, in comparison with the combustion of virgin wood shavings, are given in Table 4.196. Data are compared with the emission limit values (ELVs) for waste incineration plants set by Directive 2010/75/EU. The plant used for combustion of the poultry litter has a capacity of 5 tonnes/day, a thermal output of 500 kW of heat and 50 kW of electricity (wood shavings used as bedding material). The plant is equipped with a dust abatement system and continuous monitoring of emissions.

Table 4.196: Achievable emission levels from a fluidised bed combustion plant for poultry litter, in comparison with fresh wood shavings and ELVs set by Directive 2010/75/EU for waste incineration plants

Parameter	Unit	Directive 2010/75/EU ELVs (daily average) ⁽¹⁾	Associated emission levels	
			Emissions from poultry litter ⁽²⁾	Emissions from virgin wood shavings
NO _x	mg/Nm ³	400	359.86	380.91
SO ₂	mg/Nm ³	50	0.03	5.21
Dust	mg/Nm ³	50 ⁽³⁾	0.97	56.13
Heavy metals	mg/Nm ³	0.5	0.04	NI
Mercury	mg/Nm ³	0.05	0	NI
Cd and Tl	mg/Nm ³	0.05	0	NI
Dioxins and furans	ng/Nm ³	0.1	0.09 ⁽⁴⁾	NI
PAH	µg/Nm ³	Value not specified	40.40	NI
CO	mg/Nm ³	100	30.67	88.71

⁽¹⁾ All values refer to standard conditions: temperature 273.15 K, pressure 101.3 kPa, dry gas. Concentrations are corrected to reference conditions of 11 vol-% oxygen.
⁽²⁾ Bedding material: virgin wood shavings with < 40 % moisture content.
⁽³⁾ Emission limit value for co-incineration of biomass (waste).
⁽⁴⁾ Euro environmental emissions data.
 NB: NI = no information provided.
 Source: [553, bhsl 2011]

NO_x emissions ranging from 258 mg/Nm³ to 498 mg/Nm³ at 6 % O₂ are reported from Belgium (Flanders). Several techniques are available for controlling solid and gaseous emissions from combustion plants applied for incinerating poultry litter. The techniques are described in detail in the WI BREF [705, COM 2017].

Technical considerations relevant to applicability

No technical limitations are reported to its application on a farm scale; however, the energy recovery from manure with a high moisture content may not be sufficient to justify the implementation of the technique. For manure with a dry matter content below 30 %, the process would result in a net energy consumption. For a dry matter content of 30 % and above, energy can, in theory, be recovered in a well-designed combustion plant, with higher net energy production for dry matter contents of about 60 %. If pre-drying of the manure is needed, the applicability of the technique should be assessed on a case-by-case basis.

High investment costs for emission control equipment and detailed measurements, requested for compliance with Chapter IV of Directive 2010/75/EU, make the technique difficult for farms to apply.

Economics

Cost data are reported for a farm in the UK with an annual capacity of around 3 200 tonnes of poultry litter, 75 % of which (around 2 400 tonnes) comes from a farm with 378 000 broiler places. The plant operates 5 976 hours per year, producing hot water which is piped to the bird houses to heat the next batch of broilers. The approximate investment costs amount to EUR 1.58 million (based on EUR 1 = GBP 0.88), which comprises the following [564, bhs1 2012]:

- Plant and fuel handling: EUR 810 000. This includes the installation of the fluidised bed combustion system, all material and labour costs.
- Building a bio-secure fuel storage area: EUR 160 000. This automatically conveys the litter to the combustion unit without contact from farm staff.
- Heating network (water supply, buffer tanks, internal and external piping, pumps and controls, etc.): EUR 510 000. This refers to the heating infrastructure that stores, pumps and delivers heat into the poultry houses, including all installation and materials.
- Project management and contingency: 7.5 % of expenditure.

The payback time of the above investment, on a farm using LPG as the energy source, is reported to be 3.64 years and the free cash flow over 10 years is EUR 4.7 million, taking into account the following assumptions:

1. approximately 10 % of the litter used in the plant is recovered as ash, having a value after transportation of around EUR 68 per tonne;
2. UK incentives equivalent to EUR 53 per MWh of heat used for the first 1 313 MWh each year, followed by EUR 22 for each subsequent MWh [564, bhs1 2012];
3. benefits deriving from improved housing conditions for the birds (from optimised heating and ventilation) and consequent better performance.

For an installation that is operated for about 5 000 hours per year and a yearly input of 2 500 tonnes of manure, the gross operating costs are reported to be about EUR 18/tonne of litter, based on cost data and emissions monitoring requirements [565, NFU 2012]. Comparable costs are reported for a farm with a capacity of 0.5 tonnes manure per hour, with a dry matter content of 55 %. Investment costs in the range of EUR 300 000–350 000 are reported from Belgium (Flanders), with operating costs of EUR 18 per tonne, assuming an annual operation of 5 000 hours [256, VITO 2006].

An approximate estimation of the investment cost for the required emission monitoring equipment and testing, in order to comply with Directive 2010/75/EU, Annex VI, Part 6, is in the range of EUR 130 000–150 000. These costs may be considered too high, making the technique unviable and unsustainable for small, farm-scale plants [553, bhs1 2011].

Driving force for implementation

Farms can become self-sufficient in heat supply. Excess heat, not needed by the farm, can be supplied to a local public heating system or used to generate electricity. The sales of energy will, therefore, bring revenue, depending on individual EU Member State regulations and the market price.

Example plants

In general, incineration of solid manure is a technology growing within the broiler production sector [264, Loyon et al. 2010]. The technique is applied in Germany. In the Netherlands, one large centralised installation is in operation, with an installed capacity of 36 MW, designed to transform 420 000 tonnes of poultry litter (with a minimum dry matter content of 55 %) per year into electricity (240 GWh annually) and reusable minerals for agriculture. Farmers from all over the country can bring their poultry litter to be incinerated. A large-scale centralised installation was also reported from the UK, where 12.7 MW are produced using approximately

140 000 tonnes of litter per year. Around 30 % of broiler and turkey litter is sent for incineration in England [648, DEFRA 2011].

In France, companies attempted to set up systems of smaller dimensions; however, no installation of this kind has been successful due to technical and legislative problems [259, France 2010].

In 2010, a small-scale fluidised bed combustion system was installed in Norfolk, England operating on virgin wood chips and awaiting appropriate regulation to operate with poultry litter [565, NFU 2012]. Around 30 % of broiler and turkey litter is sent for incineration in England [648, DEFRA 2011].

Reference literature

[256, VITO 2006] [259, France 2010] [264, Loyon et al. 2010] [409, VITO 1997] [500, IRPP TWG 2011] [553, bhs1 2011] [564, bhs1 2012] [565, NFU 2012] [594, Agro Business Park 2011] [624, IRPP TWG 2013] [648, DEFRA 2011]

4.12.11 Ammonia stripping

Description

Removal of ammonia is achieved through volatilisation from a liquid phase, by means of pH and temperature increase and a gaseous counter-flow (air or steam), and subsequent recovery by absorption in an acidic solution as ammonium salt or by condensation.

The liquid phase is charged in the upper part of a vertical column (stripping tower), where a stripping gas is introduced from the bottom (air or steam for 'air stripping' or 'steam stripping'). The gas flows through the column countercurrently to the liquid, thus extracting ammonia (stripping) in gas form. To enhance the liquid-gas contact, the columns are filled with specifically shaped pieces of inert material (packed column). The treated liquid is collected at the bottom of the tower and the ammonia-loaded gases leave the tower at the top, for further treatment.

Stripped ammonia is recovered by absorption in a second column (absorber), where the ammonia-laden gases are washed countercurrently with acid solution (e.g. sulphuric acid, iron sulphates, iron oxides) to dissolve ammonia and to produce a concentrated ammonium salt solution. In steam stripping, the output gas from the stripping tower is condensed to eventually produce a water solution of ammonia. The end product of the technology can be used as a fertiliser.

Achieved environmental benefits

The removal of ammonia from the slurry results in a mitigation of potential ammonia emissions. During slurry landspreading, odours are also reduced. Nitrogen is recovered in a concentrated form as a salt or in a liquid solution, therefore nutrient management is easier and transport costs are reduced.

Cross-media effects

Energy consumption is increased. Depending on the working temperature, heating energy requirements may play a primary role in energy consumption [594, Agro Business Park 2011].

Environmental performance and operational data

The two fundamental control parameters of the process are the temperature and the pH, as they establish the equilibrium between ammonia (NH_3) and ammonium (NH_4^+). The pH is usually set between 9 and 10, by adding an alkaline solution of soda or lime, or by previous CO_2 stripping, so that ammonia can be released as a gas. For air stripping, typical working temperatures are set below 100 °C, whereas higher temperatures are characteristic of steam stripping. An ammonia reduction of up to 95 % is reported, under optimal conditions [594, Agro Business Park 2011]. Organic nitrogen, nitrites and nitrates are not removed.

The electricity consumption for air stripping is dependent on the process temperature, since, at higher temperatures, less air needs to be sent through the column. The consumption of electrical energy is reported from Belgium (Flanders) as 2.3 kWh/m³ of liquid, if the process is run at 20 °C, and 0.85 kWh/m³ if the operating temperature is 50 °C. The energy consumption for the stripping column only is reported as 14 kWh/kg of stripped nitrogen [594, *Agro Business Park 2011*]. In the case of steam stripping, the electricity consumption is 0.45 kWh/m³ liquid, while the consumption for thermal energy is equivalent to the production of 100 kg of steam per m³.

Technical considerations relevant to applicability

The quality of the ammonia salts or ammonia concentrate obtained increases when volatile organic matter has been previously removed. Therefore, mechanical separation of the solid-liquid fractions is usually required as a pretreatment, to reduce the dry matter content and avoid clogging.

The technique may be used in combination with anaerobic digestion, as a pretreatment that improves the ammonia stripping efficiency, reduces contamination of the final product by organic matter, and provides energy and heat required for the process. Due to the high heat demand, the technique may not be economically sustainable if heat from biogas production is not available [624, *IRPP TWG 2013*].

Economics

Investment costs are reported from Italy as EUR 350 000. For a plant located in Slovenia, treating 15 m³/h of slurry, the estimated investment cost for the stripping column was reported to be EUR 250 000 [594, *Agro Business Park 2011*].

For a mobile unit combining a centrifugal solid-liquid separator and ammonia stripping equipment, followed by a catalytic ammonia process, investment costs are reported to be in the range of EUR 350 000–400 000. The related operating costs are EUR (125 × 2) per m³ of treated slurry, for the displacement of the integrated mobile unit, EUR 3.10 per m³ for the separation stage, and EUR 4.46–4.95 per m³, for ammonia stripping plus the catalytic oxidation stage [256, *VITO 2006*] [529, *Veneto Agricoltura 2012*].

Operating costs have been reported as EUR 2.5–4.5 per kg of stripped nitrogen (only for the stripping column). For the absorption stage, at least an equivalent range of costs should be considered. In Denmark, ammonia stripping is considered disproportionately expensive [499, *AgroTech 2008*].

Driving force for implementation

Both liquid ammonia solution or solid ammonia salts obtained by condensation and evaporation can be used directly as fertilisers, as feedstock in the fertiliser industry or sold to other industrial applications (e.g. waste water treatment in the paper industry). The reported income is up to EUR 0.35 per kg of nitrogen recovered in a 0.1 ammonium sulphate solution, to be sold to fertiliser manufacturers. The end product concentrate (which contains phosphorus and nitrogen) is partially hygienised (depending on the operation time/temperature).

Example plants

In Belgium (Flanders), a mobile system is in use. A farm in Slovenia and one in Italy (with an annual capacity of 32 000 tonnes of manure) are also reported to operate the technique [594, *Agro Business Park 2011*] [595, *Agro Business Park 2011*].

Reference literature

[256, *VITO 2006*] [499, *AgroTech 2008*] [529, *Veneto Agricoltura 2012*] [594, *Agro Business Park 2011*] [595, *Agro Business Park 2011*] [624, *IRPP TWG 2013*]

4.12.12 Manure additives

Description

Manufactured or naturally occurring products or substances are added to manure or feed to change the biological, chemical or physical properties of manure. The objectives for the addition of each additive may be different: reducing ammonia and odour emissions, improving the indoor environment in animal housing, stabilising pathogenic microorganisms and preventing insects' development, increasing the fertilising value of the manure, or facilitating the handling and use of manure by increasing its fluidity. The use of some specific feed additives is covered in Section 4.3.6.

Many types and categories of manure additives are commercially available. These include:

- masking and neutralising agents;
- absorbents;
- urease inhibitors;
- pH regulators;
- oxidising agents;
- flocculants;
- disinfectants and antimicrobials;
- biological agents.

Achieved environmental benefits

A better use and management of manure on the farm can be achieved with a more homogeneous manure, namely because having greater homogeneity makes it easier to dose the manure in landspreading. A lesser volume of manure can be produced due to less water being used in the easier cleaning of the pits. In some cases, a decrease in ammonia and odour emissions could be achieved. Savings of energy are possible because of a reduced use of cleaning machines. Savings in water are also achieved. Specific potentially achieved environmental benefits are also reported under 'Environmental performance and operational data'.

Cross-media effects

No significant cross-media effects have been reported. Specific cross-media effects are reported under 'Environmental performance and operational data'.

Environmental performance and operational data

One of the main problems is the lack of standard techniques to test and analyse the results. Another problem with their use is that many trials have only been developed under experimental conditions in laboratories and not on-farm, where large variations in nutrition, the management of nutrition, pH and temperature can be found. Besides this, there is also sometimes a huge volume of manure to be mixed with the additive in a pit or lagoon, and the results achieved often depend a lot more on the mixing efficiency than on the lack of efficacy of the additive. Improving the flow characteristics seems to be strongly related to a good mixing.

The effectiveness of each additive is highly dependent on the correct dosing, right timing and good mixing with the manure. It is also reported that satisfactory results are not always achievable [561, Flotats et al. 2004] [499, AgroTech 2008]. For example, trial results in France demonstrated that the efficiency of slurry additives aiming to reduce ammonia and odour emissions from pig housing is not consistent, and it varies according to the product and season (e.g. efficiency for odour abatement ranged from 0 % to 40 %) [257, France 2010] [259, France 2010]. In general, for most of the manure additives, the effects documented by scientific trials are poor so their effectiveness is uncertain [594, Agro Business Park 2011].

- Masking and neutralising agents. These are a mix of aromatic compounds (e.g. heliotropin, vanillin) with a strong scent that work by either masking the manure odour with a more pleasant odour or neutralising the odorous volatile compounds. The effectiveness of masking agents is difficult to predict due to varying odour characteristics and changing weather conditions. The individual constituents of odours remain unchanged and the additive tends to separate from the odour downwind. Masking agents are susceptible to degradation by the microorganisms in the slurry. Frequent application is required [560, IGER 2000]. Masking agents can also be added to the feed (e.g. artemisia extract, mint oil) [561, Flotats et al. 2004].
- Absorbents. There are a large number of substances such as peat or clay minerals (e.g. zeolite) that depend on physical absorption (e.g. for ammonia, odorous compounds) for their effect. These materials have a high surface area and the quantities required for effective abatement could be very large [561, Flotats et al. 2004] [624, IRPP TWG 2013]. Some types of zeolites called 'clinoptilolites' can be added either to the manure or to feed for their high cation exchange capacity and affinity for NH_4^+ . Clinoptilolites have been extensively studied, but results of nitrogen binding are controversial and costs are relatively high [151, Link CR 2005] [205, ADAS 2000]. An increase in ammonia emission in duck rearing was reported in association with the use of clinoptilolites [152, Link CR 2006]. The use of other clay minerals, such as bentonite, has been reported as having odour-reducing effects [560, IGER 2000] [561, Flotats et al. 2004]. In experiments with the addition of zeolite and bentonite to pig slurry, it has been found that microbial activity sharply decreases, with a consequent reduction of odorous substances released by manure. Other reported results of trials carried out in Denmark suggest that the addition of a rock mineral containing silicon, derived from zeolite, had no effect on odour or ammonia emissions [499, Agro Tech 2008]. The substances mentioned above are also able to improve soil structure and have the added benefit that they are not toxic or hazardous. Peat gives similar results and is also sometimes used. However, the extraction of peat is associated with significant biogenic CO_2 emissions.
- Urease inhibitors. These compounds stop the degradation of urea, which is contained in the urine, to ammonium, the breakdown of which releases ammonia. There are three main types of urease inhibitor:
 - Phosphoramides. Applied directly to the soil, they show a good effect. They work better in acid soils, but could affect soil microorganisms.
 - Yucca extract (*Y. schidigera*). Many trials have been done to assess its potential but the information available is controversial, showing good results in some cases, but no effect at all in others. It is added in the feed and not absorbed by the animals; thus, it reaches manure in a uniform way. There is also evidence that it improves the feed conversion ratio and weight gain. Nevertheless, the way these additives function is not well investigated [561, Flotats et al. 2004] (see Section 4.3.6.4).
 - Straw, considered an adsorbent in many references. However, besides the absorbing effect, it also increases the C : N ratio. Its use is controversial because in many works it shows an increase in ammonia emissions.
- pH regulators. There are three main types:
 - Acidifying agents. Inorganic acids (phosphoric, hydrochloric, sulphuric) or chemical compounds that decrease the pH of liquid manure. The addition of acids (e.g. H_2SO_4) for lowering the pH (pH 4 to 5) keeps nitrogen in the NH_4 form which does not volatilise as ammonia; it slows down the activity of methanogenesis bacteria preventing the formation of CH_4 and allowing the carbon to remain in the manure [228, Denmark 2010]. More details are given in Section 4.12.9. In the case of broiler litter, aluminium sulphate has been used to reduce the pH of the litter; this will reduce ammonia emissions during housing, storage and landspreading and precipitate P into a form that is not water-soluble which is less susceptible to soluble P loss in run-off. Aluminium sulphate is added to poultry

litter at a rate equivalent to 5–10 wt-%, which is equivalent to adding 50–90 g per bird [648, DEFRA 2011] [508, TFRN 2014].

- Lime. Lime addition stabilises manure and reduces the content of pathogens. By mixing quicklime (CaO) with solid manure, the temperature rises exothermically to between 55 °C and 70 °C and the pH increases to 9–11, with a resulting bactericidal effect which blocks fermentation in litter. The reactive lime used in the process promotes drying of the manure; it is also a 'liming agent' for changing the soil pH, in view of manure application.
- Ca and Mg salts. These salts interact with manure carbonate, decreasing the pH and therefore reducing the potential for ammonia emissions. They could increase the fertilising value of the manure but could also increase the salinity of the soil (chlorides). They are used mainly in combination with other additives. Superphosphate (mixture of calcium salt and orthophosphoric acid) is the product most often used in poultry farms; it has a draining action on the litter. It has been used in doses of 100–200 g/m² and remains active over five days. Superphosphate and phosphoric acid were studied in poultry farms in France, as inhibitors of microbial growth [259, France 2010]. On the other hand, the addition of phosphorus to manure may represent a local problem, where specific regulations concerning phosphorus are applied (e.g. in the Netherlands).
- Oxidising agents. These are intended to have a similar effect to aerobic treatment. Their effects are through:
 - oxidation of the odour compounds (e.g. sulphides);
 - providing oxygen to aerobic bacteria; aerobic conditions promote oxidation of hydrogen sulphide and other malodorous gases by microorganisms;
 - inactivating the anaerobic bacteria that generate odorous compounds.

The most active oxidising agents are hydrogen peroxide, potassium permanganate, chlorine gas, or sodium hypochlorite. They are hazardous and not recommended for farm use. Some of them (e.g. formaldehyde) could be carcinogens. Ozone (O₃) is also used as a strong oxidant that can react with specific odorous compounds in the slurry and also reduce microbial activity. Its use to treat the slurry results in a pH increase, with consequent increased ammonia emissions and a lower fertiliser value of the treated slurry. Ozone treatment can be combined with acidification. Ozone application has demonstrated its efficacy, but operating costs are very high.

- Flocculants. These are mineral compounds (ferric or ferrous chloride and other iron or zinc salts) or organic polymers. These additives react with sulphides [561, Flotats et al. 2004] and reduce BOD, suspended solids, and PO₄³⁻ in the liquid stream, generating an insoluble precipitate, usually with a high content of P (see Section 4.12.2.4).
- Disinfectants and antimicrobials. These are chemical compounds that are intended to have a sanitation effect on liquid manure. Consequently, they inhibit the activity of the microorganisms involved in odour generation. They are expensive to use, and with sustained use an increase in dosing is needed.
- Biological agents. The addition of microorganisms and nutrients in the slurry increases the microbial activity, which degrades organic matter not digested by animals. In addition, odorous substances are reduced and N is transformed to its organic form. Furthermore, thinner slurry is expected, which is easier to handle and deliver. Nutrients may be fats, sugars, or extracts from plants and algae [499, AgroTech 2008] [561, Flotats et al. 2004]. Biological agents are available as lyophilised preserved cultures or live cultures of natural strains or adapted decomposition strains (stimulators of microorganisms that are naturally present in the substrates). They can be divided into the following:
 - Enzymes. Enzymes are complex protein structures, promoting catalytic regulation and direct/indirect stimulation of biochemical processes and decomposition of the

organic structures [287, Jelínek et al. 2007]. Their use is to liquefy solids. They are not hazardous. The actual effect depends strongly on the type of enzyme, the substrate and proper mixing.

- Bacteria (see also Section 4.8.6):
 - Exogenous strains. Their competition with natural strains makes getting good results more difficult. Their use is better in anaerobic pits or lagoons to reduce the organic matter producing CH₄ (sowing of methanogenic bacteria is more efficient and sensitive to pH and temperature). The efficacy is high but frequent resowing has to be carried out.
 - Natural strains adding carbonate substrates (increased C:N ratio). Their effect is based on the use of ammonia as a nutrient, but natural strains of bacteria need a sufficient source of C to develop an efficient synthesis process, changing ammonia into the organic nitrogen of cell tissue. Resowing has to be carried out too, to avoid reverting to the starting point. They are not hazardous and no significant cross-media effects have been reported.
- Some biotechnological agents, containing a selected absorbent, adsorb odour substances or other harmful gaseous catabolites of organic matter decomposition. According to their nature, biotechnological agents can be applied to the feed or drinking system, litter, floor or under slats. New biotechnological agents are marketed to reduce ammonia and greenhouse gases, but their efficacy is controversial and should be verified on a case-by-case basis [287, Jelínek et al. 2007]. The way these additives function is not well investigated [561, Flotats et al. 2004].

Of all the additives described, those aimed at changing the physical properties of the manure to make it easier to handle, in particular biological agents, are most commonly used at the farm level, and in most cases have a positive effect. These additives are not hazardous. Their use results in an increase in manure flow, the elimination of natural crusts, a reduction of soluble and suspended solids and a reduction in the stratification of the manure. However, these effects were not demonstrated in all, comparable, cases. Moreover, the increased homogeneity of the manure facilitates its agricultural use (i.e. allowing for better dosing).

A summary of the main characteristics reported for the different groups of manure additives is given in Table 4.197.

Table 4.197: Summary of the main characteristics for different groups of manure additives

Type of additive	Characteristics	Advantages	Disadvantages
Masking agents	Aromatic oils with a strong odour that masks manure's odours	<ul style="list-style-type: none"> • Quick effectiveness • Low cost • Simple and safe to use 	<ul style="list-style-type: none"> • Short-term efficiency and not predictable • No effect on ammonia
Blocking/Neutralising agents	Aromatic oils that neutralise the volatile compounds causing odours	<ul style="list-style-type: none"> • Relatively quick effectiveness • Simple and safe to use 	<ul style="list-style-type: none"> • Highly variable efficacy, difficult to reproduce • No effect on ammonia
Absorbents	Compounds with a high surface area that absorb odorant compounds	<ul style="list-style-type: none"> • Can reduce odour under specific circumstances 	<ul style="list-style-type: none"> • Highly variable efficacy
Chemical additives	<ul style="list-style-type: none"> • Oxidising agents • Precipitating agents • pH control agents • Electron acceptors 	<ul style="list-style-type: none"> • Can reduce emissions of some compounds 	<ul style="list-style-type: none"> • Can have undesirable effects on other compounds • Occasionally, dangerous products or difficult to manipulate
Microbiological agents	Bacterial populations degrading the organic substances	<ul style="list-style-type: none"> • Can reduce odour and gaseous emissions • Can reduce crust formation and improve fluidity • Can transform ammoniacal N into organic N • Can improve efficiency of solid-liquid separation of slurry 	<ul style="list-style-type: none"> • Very variable efficacy, not reproducible • Efficacy on-farm not as good as in laboratory trials

Source: [561, Flotats et al. 2004]

The purchase cost, quantity required, frequency of application, and hazard potentials of an additive are the most important parameters for its use. As slurry will be continually accumulating in a store, manure additives will need to be added at some frequency. The use of additives can be considered situation-specific, mainly depending on the needs of the farmer [560, IGER 2000]. Additional equipment for distributing and mixing the products might be required.

Technical considerations relevant to applicability

In most cases, additives can be used in existing or new farms with no technical restrictions.

Economics

In general, the operating costs are typically equivalent to the type and price of the additive. Estimated costs are reported as being from EUR 5 to EUR 30 per fattening pig; while other studies report levels of EUR 0.25–1.25 per fattening pig [561, Flotats et al. 2004]. Costs of aluminium sulphate in poultry litter are estimated as EUR 3.5/t of litter (EUR 1 = GBP 0.86) [648, DEFRA 2011]. Costs for urease inhibitors are reported to be very high by Germany [474, VDI 2011].

Driving force for implementation

In general, the benefits of manure additives, compared to end-of-pipe solutions, are that a better indoor air quality is provided to both the animals and farmers and, at the same time, they are relatively easy to implement in existing housing [499, AgroTech 2008] [259, France 2010]. As problems with slurries are influenced in some way by microbially mediated processes, manipulation of these processes by bacterial/enzymic agents may be an effective means of control.

Example plants

There are many commercial products available. Many farms in different Member States use them routinely.

In Czech Republic, about 35 tested biotechnological agents are offered as manure additives. The efficacy of the products is validated on a case-by-case basis [287, Jelínek et al. 2007]. In France, the use of biological (see Section 4.8.6) and chemical additives in poultry litter (broilers and turkeys) is increasing [624, IRPP TWG 2013] [257, France 2010]. A survey carried out in France showed that more than 80 products are available for treating pig slurry [257, France 2010].

Two farms in Belgium use manure additives (excluding pH regulators). In the UK, 500 farms use additives in the form of bacteria and enzymes in livestock manure (assuming 10 % of them to be pig farms and 90 % cattle farms). In France, 20 farms use additives, especially in response to odour problems [595, Agro Business Park 2011].

Reference literature

[151, Link CR 2005] [152, Link CR 2006] [205, ADAS 2000] [228, Denmark 2010] [257, France 2010] [259, France 2010] [287, Jelínek et al. 2007] [405, Tengman C.L. et al. 2001] [474, VDI 2011] [499, AgroTech 2008] [560, IGER 2000] [561, Flotats et al. 2004] [594, Agro Business Park 2011] [595, Agro Business Park 2011] [624, IRPP TWG 2013] [648, DEFRA 2011]

4.12.13 Slurry and wet manure belt dryer**Description**

This technique is used to dry the non-stackable solid fraction that is obtained in mechanical slurry separation processes, the solid residue produced from biogas plants, or the non-separated slurry mixed with dried manure. It aims at a product with a reduced volume and higher dry matter content by using heat convection for drying. The input material is dried by means of a belt through which warm air flows.

The transport belts are made of wire material or perforated steel plates, and heated air flows through them. In drying chambers, one or several transport belts are arranged one above the other (see Figure 4.94), allowing matter to drop from each.

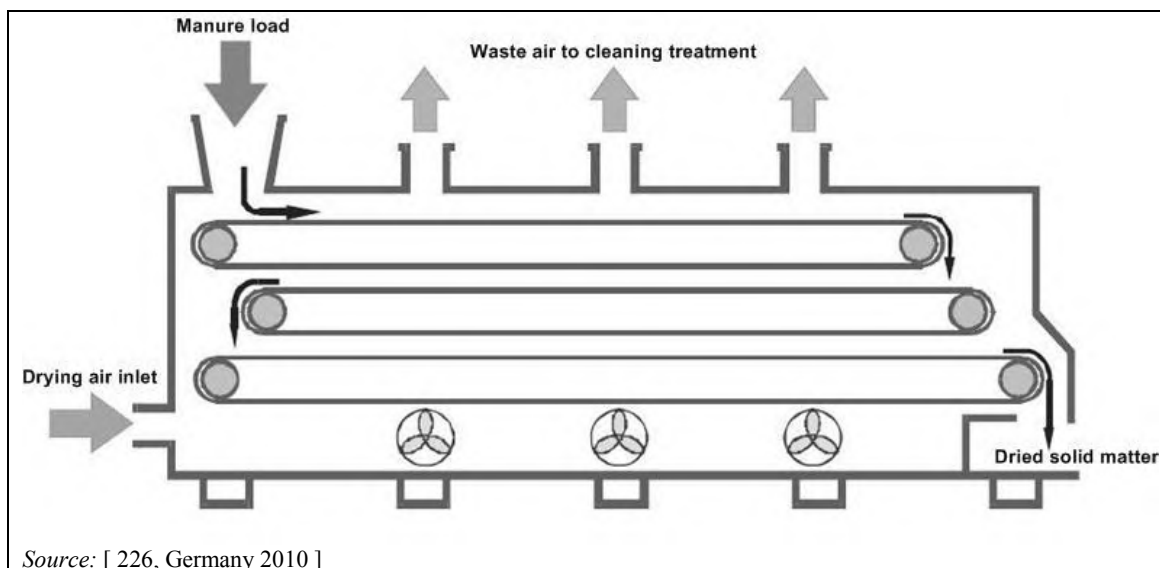

Figure 4.94: Scheme of a manure belt dryer

When the material reaches the lower belt, it is mixed and homogenised. The lowest degree of air turbulence and the optimal vapour content are sought, in order to minimise dust and to maximise moisture removal.

Achieved environmental benefits

Relatively solid matter is processed into a dry, stable product that is suitable for storage and transportation and that develops no, or only slight, odour. The technique is commonly used in combination with biogas production and also in a CHP system.

Cross-media effects

The exhaust drying air can contain high levels of ammonia and so needs to be cleaned by an acid scrubber. The ammonium salt produced is removed from the scrubber with the discharge water and has a fertilising value (6–7 % of nitrogen in ammonium sulphate solution). In the scrubber, 8–12 kg of sulphuric acid are needed per tonne of digestate.

Specific thermal energy consumption of 700 kWh per tonne of solid matter is required to heat up the drying air, which is available on-farm at no additional cost when a CHP system is used to burn the biogas. Additional electric energy is needed to run the belt system, about 2–5 kWh per tonne of raw slurry, before separation.

Environmental performance and operational data

Equipment is available with a capacity of 1–2 tonnes per hour of separated solid fraction (corresponding to 5–10 tonnes per hour of raw slurry, before separation). An example of the input/output characteristics of manure processed with a belt dryer is presented in Table 4.198.

Table 4.198: Input and output characteristics of the manure processed in the manure belt drying process

	Dry matter	Total N	NH ₄ -N	P ₂ O ₅	K ₂ O
	kg/t	kg/t	kg/t	kg/t	kg/t
Input	300	8.4	2.7	10.1	3.0
Output	800	14.5	0.74	27.11	8.0

Source: [226, Germany 2010]

It is assumed that around 90 % of NH₄-N is extracted from the treated matter during the drying process, which corresponds to 0.30 kg of nitrogen per tonne, or to 0.66 % of the total nitrogen

load. When the technique is combined with an acid scrubber, almost all the ammoniacal nitrogen would be collected; otherwise it would be lost as emissions.

The solid fraction obtained after separation is stabilised and reduced in volume. Non-separated slurry can be dried by mixing it with previously dried material. From a treated digestate, a solid mass is obtained having 8–9 % of the original volume, which is also sanitised of most pathogens.

Technical considerations relevant to applicability

Only slight adaptation to the farm equipment is necessary, since only a screw press separator (see Section 4.12.2.2) is required for raw slurry for the first slurry separation stage. The technique is preferably used in farms with over 2 000 animal places, or in combination with biogas production, to dry the fermentation residues by using the heat from CHP plants.

Economics

Investment costs for drying units are reported from Germany to be in the range between EUR 300 000 and EUR 400 000 per unit, which corresponds to EUR 80 000–120 000 per tonne per hour. With an amortisation period of 10 years and 6 % interest rate, the investment can be annualised as EUR 10 000–15 600 per tonne, or EUR 39 000–52 000 per year, per drying unit.

A complete installation for biogas digestate, inclusive of building and stores, costs about EUR 700 000 in Italy. Annualised investment costs are reported as EUR 3–4 per tonne of dried material produced, while annual operating costs are reported from Italy to range between EUR 0.8 and EUR 1.5 per tonne of dried digestate produced. The maintenance and control of the system requires 0.01–0.02 hours of labour per tonne of dried material per year.

Driving force for implementation

This technique may have an economic value depending on the transport costs of undried manure. Storage volumes are significantly reduced.

Example plants

It has been reported that one farm in Italy is running the technique, and that others are planning to be equipped with the system.

Reference literature

[226, Germany 2010] [231, Italy 2010] [259, France 2010]

4.13 Techniques for the reduction of emissions from manure landspreading

Manure (liquid or solid) landspreading and the irrigation of waste water are commonly applied techniques. Slurries and solid manures are valuable fertilisers but may also be potential sources of pollution. Different amounts of valuable mineral elements (i.e. plant nutrients) contained in the manure can be lost as emissions during and after landspreading, if landspreading is not done properly.

The amount of farm manure available and its nutrient content depend on the farm-specific animal feeding practice, animal performance and the use of extra water (see Sections 4.3 and 4.4). Manure landspreading is the last stage of farm manure handling and represents a crucial step to reduce emissions and maintain the benefit of abatement techniques applied upstream to control emissions.

Seasonal timing of manure application, to synchronise with crop nutrient needs, is as important as the equipment or technology applied for landspreading [590, Batfarm 2013]. In addition, soil characteristics and other factors, such as proximity of watercourses and climate/weather conditions, are important factors to consider particularly with regard to crop nutrient use efficiency and environmental impacts. The chemical analysis of the soil is a useful method in order to define the real needs of fertilisation and evaluate possible overloads caused by excessive and repeated landspreading.

Landspreading involves a number of tasks or actions that need to be coordinated, including the following:

- Assessing the land receiving the manure, in order to identify risks of run-off and prevent water pollution and the transfer of pathogens to water, and then deciding whether or not to landspread. In Nitrate Vulnerable Zones (NVZ), this aspect is essential.
- Avoiding weather conditions in which the soil could be seriously damaged or when the risk of run-off and the leaching of nutrients could be significant.
- Keeping safe distances from watercourses, boreholes and neighbouring properties (including hedges) to prevent run-off to water and spread of pathogens.
- Identifying an appropriate application rate, taking into account a risk assessment plan, when it is required (e.g. in NVZ), the specific nitrogen and phosphorus contents of the manure derived from testing a representative sample or from typical values of the nutrient content of manures based on the analysis of a large number of samples, the seasonal crop requirements, and the characteristics of the soil (e.g. nutrient content).
- Checking that machinery is in good working order and properly set at the correct application rate.
- Setting travel routes to avoid bottlenecks.
- Ensuring that there is adequate access to the slurry store and that loading can be done effectively and without spillage, i.e. by checking the operation of pumps, mixers and sluice gates or valves.
- Assessing the spreading fields at regular intervals to check for any sign of run-off and respond properly when necessary.
- Ensuring that all staff are trained for their responsibilities so that they can prevent accidents and take the right action if something goes wrong.

However, as NH₃ emissions occur mainly at the soil surface, specific abatement measures are needed to reduce ammonia emissions, such as application of technologies like liquid manure injection or fast incorporation [337, Webb et al. 2005].

National Codes of Good Agricultural Practice are required by the Gothenburg Protocol (see Section 1.4.1) to reduce emissions of acidifying and ozone-producing gases, in particular to reduce NH₃ emissions. Codes should take into account local soil conditions, the manure type and farm structure.

The knowledge of the real content of nutrients contained in the manure is another crucial factor in limiting unnecessary fertilisation. Published typical nutrient content figures provide useful estimates. The testing of manure, in order to establish its nutrient content, provides the best information but may not always facilitate accurate assessments, as it is affected by the sample representativeness. Technologies are developed for instant analysis of nutrient content with portable equipment. Of these new technologies, NIRS (near-infrared reflectance spectroscopy) and EC meters (electrical conductivity meters) are now commercially available and in use for on-farm testing of slurries (e.g. in the UK).

The manure application equipment should operate accurately to ensure that the intended amount of nutrients in the manure is applied to the crop with an even spread pattern [390, ADAS 2001].

Techniques to reduce the emissions from landspreading could be divided into two categories:

- techniques that reduce emissions that occur during or immediately after manure landspreading; these are predominantly emissions to air (ammonia and odour) and noise;
- techniques to reduce emissions after or as a consequence of manure landspreading; these concern emissions to soil, to surface water and groundwater (N, P, etc.), and to some extent to air.

4.13.1 Balancing the spreading of manure with the available land and soil/crop requirements

Description

Essentially, emissions from manure application to soil and groundwater can be minimised by balancing the application rate with the requirements of the soil, expressed in terms of the capacity for nutrient uptake by soil and vegetation, in order to avoid the application of excess nutrient levels.

Nutrient storage by soil and nutrient uptake by vegetation are complex processes and depend on the soil characteristics and weather conditions during application, the season, and the type of grass or crop that is grown. Ideally, to prevent the application of excess nutrients, no more manure should be applied than the soil/crop requirements allow. Given a certain nutrient content in the manure and manure volume to apply, a maximum amount for manure application can be determined for the requirements of a given crop. In addition, available nitrogen and nitrogen potentially mineralised in the soil should be taken into account, in order to avoid an excessive nitrogen addition with the manure.

Achieved environmental benefits

It is difficult to directly quantify the effect of the use of the soil nutrient balance. The aim is to avoid having an excess of nutrients in the soil from manure landspreading. Sometimes it is possible to deliberately cause a temporary excess of a nutrient, such as phosphorus, to make it available to crops to be grown on the same land.

Balancing the nutrients can reduce the environmental impact on soil and groundwater. If it results in lower application rates, the use of a soil nutrient balance will also affect emissions to air associated with manure application). On mixed livestock farms, between 10 % and 40 % of the nitrogen surplus is related to NH₃ emissions [508, TFRN 2014].

Cross-media effects

None reported.

Environmental performance and operational data

Tools that can be used for balancing the amount of nutrients applied with manure to the available land are:

- a soil nutrient balance;
- a rating system, i.e. rating the number of animals to the available land;
- fertilising norms for nitrogen and phosphorus and manure standards.

A field nutrient balance calculates the difference between the total input of nutrients applied to the soil and the total output of nutrients, e.g. by harvest in a defined space-time unit. Various tools have been developed to calculate the amounts of nutrients (nitrogen and phosphorus) applied and removed from the field in order to estimate the efficiency of nutrients used in crop production. Calculations for nutrient input consider the soil buffer, the use of mineral fertiliser, manure and other organic wastes, the atmospheric deposition of nitrogen and biological nitrogen fixation, as well as crop use.

In general, the application rate is calculated by the ratio of nutrients content in the manure and the manure volume applied, considering the area available for landspreading and the time period (kg/ha per year). Typically, in pig and poultry manure, the ratio between P_2O_5 and the nitrogen content is roughly equivalent to the typical crop demand ratio for these nutrients.

In most EU Member States, decision support systems and nutrient balancing tools for crop production are in use to help farmers make effective 'fertilising plans' and calculations. Furthermore, these tools support the farmers by recording input and output data at the field level. Nutrient recommendations for crops and grassland are also available. These tools are typically used to achieve NVZ compliance in relevant areas and are mandatory in some Member States for legal reporting. Fertiliser planning is a regulatory requirement within some MS regulations (e.g. UK in NVZ).

An example of a tool used for determining a proper balance between manure spreading and available land in the UK is the 'Tried & Tested Nutrient Management Plan'. This software tool guides farmers in planning and recording plant nutrients applications [336, UK 2010]. It is complemented by a decision support system that can accurately predict the fertiliser nitrogen value of applied manures on a field-specific basis, taking into account the manure type, composition (total N, ammonium N and uric acid N), soil type, application date and technique, ammonia and nitrate losses, and organic nitrogen mineralisation. It can be used either before applying manure, to check the likely effect of a spreading policy, or to assess the actual fertiliser nitrogen value of a spread manure using manure application details and weather data. Another tool in use in the UK is called 'PLANET', a nutrient management software tool available for farmers. It consists of several modules that carry out different calculation, record-keeping and reporting functions.

Rating the number of animals to the available land is a more pragmatic approach at farm level, and is applied in, for example, Italy, Portugal and Finland. The EC has calculated the nitrogen balance and Nitrogen Production Standards for different animal categories [558, COM 1999]. Table 4.199 gives an example for the maximum allowable number of animals per hectare of land, calculated on the basis of 'standard' emission factors for nitrogen (kg N/ap/yr), applied in the EU and a yearly maximum load of nitrogen per hectare of soil equivalent to 170 kg N/ha/year (Nitrates Directive).

Table 4.199: Calculated maximum allowable animal number per hectare

Type of livestock	N production standard (kg N/animal/year)	Maximum allowable number of animals per hectare to comply with the EU limit of 170 kg N/ha
Sows with piglets (till 25 kg)	21–32	5.3–8.1
Fattening pigs (25–105)	7.5–13.1	13–23
Laying hens	0.35–0.82	207–486
Broilers (1.8 kg)	0.23–0.52	327–739
Ducks (3.3 kg)	0.41–0.97	175–415
Turkeys (13 kg)	0.90–1.68	101–189
<i>Source: [558, COM 1999]</i>		

Fertilising norms enable the balanced dosing of nutrients in the manure in relation to the crop requirements. The presence of manure standards is a prerequisite for the efficient use of phosphorus and nitrogen norms on a large scale. Manure standards are official references that describe as a minimum the amount of manure produced per animal per year or per animal produced and the composition of that manure in terms of the dry matter percentage and nitrogen and phosphorus content (potassium is normally part of official manure standards as well). Phosphorus fertilisation norms are presented in Section 4.13.1.1.

Technical considerations relevant to applicability

No technical restrictions are reported for the implementation of the technique. On the basis of these estimates, necessary reductions of nutrient inputs from manure (and fertilisers) could be predicted and used as recommendations in policy instruments for reducing nutrient loads. These recommendations will affect the application of techniques used to reduce nutrient losses (e.g. volatilisation of ammonia, nitrate leaching) and will encourage the development of new application techniques.

Economics

Costs are associated with the administrative tasks of the application of a soil nutrient balance on-farm. However, cost benefits exist when over-application of fertiliser is prevented and the crop yield is maintained or improved.

Driving force for implementation

In several Member States, the application of a nutrient balance has been made obligatory by legislation. The designation of Nitrate Vulnerable Zones (NVZ) as defined in the Nitrates Directive (91/676/EEC) and increasing economic and environmental pressures have promoted an increased use of nutrient balances (N-balance).

Concerning phosphorus, it is likely that the implementation of Programmes of Measures under the Water Framework Directive (2000/60/EC) will require action in some drainage basins to reduce phosphorus losses and this may result in further restrictions on manure spreading [204, IMPEL 2009].

Example plants

This type of management appears to be common all over Europe. In the Netherlands, a nutrient balance system is applied. In the UK, the 'Tried & Tested Nutrient Management Plan' is in use; tools and publications such as the 'UK MANNER-NPK' and DEFRA fertiliser recommendations are also used for fertiliser planning. In France, the national regulation requires farmers to manage their fertilisation by using a proper fertilising programme. In Denmark, a system where each farmer has to report his fertilising plan for the next growing season is used. Several software systems or publications can be used for computing the 'fertilising plan'. The rating of the number of animals to the available land is applied in different countries (e.g. Italy, Portugal and Finland).

Reference literature

[44, IKC 1993] [204, IMPEL 2009] [249, Webb et al. 2001] [336, UK 2010] [500, IRPP TWG 2011] [508, TFRN 2014] [555, MAFF 1998] [558, COM 1999] [624, IRPP TWG 2013]

4.13.1.1 Phosphorus fertilisation norms

Using phosphorus fertilisation norms is a way to reduce the risk of over-application of phosphorus when fertilising with livestock manure. Over-application of phosphorus is common when fertilising planning merely considers the stipulated nitrogen fertilising norm in the Nitrates Directive (maximum 170 kg N/ha per year).

Sweden, Estonia, Finland and Germany have adopted official maximum allowed phosphorus norms, whilst Denmark, Lithuania and Poland have recommended norms. There are two important differences between official and recommended phosphorus fertiliser norms:

- official norms specify the maximum permitted use of plant nutrients to reduce leaching of phosphorus to water from the fields, while recommended norms describe how the crops should be fertilised as a minimum, in order to give an expected yield;
- official norms are built into the legislation, and are enforced via control and sanctions, while recommended norms are simply advisory.

Phosphorus fertilisation norms can be flat rate (without respect to the specific crop or other parameters) or more detailed (considering for example the type of crop and the phosphorus content of the soil). When flat-rate norms are used, the exact phosphorus norm is determined on a national basis according to prevailing crop rotations on land where manure is used as fertiliser. In Sweden and Estonia the official norms are determined as a maximum allowed flat rate, while Finland and Germany have adopted a more detailed regulation, considering the specific conditions on fields and for crops. The efficiency of a phosphorus fertiliser norm increases if it is used in combination with a P Index (see below), especially when flat-rate phosphorus norms are used.

Reference literature

[619, Baltic Sea 2020 2011]

4.13.2 Groundwater protection schemes

Description

The main components of a groundwater protection scheme are:

- a land surface mapping to display groundwater sources and resources (aquifers), which together define groundwater protection zones;
- the groundwater protection responses for potentially polluting activities, depending on factors such as risk (hazard) and aquifer category.

Achieved environmental benefits

Defined vulnerable areas (e.g. groundwater) can be protected from contamination by excess nitrogen, phosphorus microbial pollutants or specific heavy metals. The schemes are considered tools that can direct landspreading (e.g. advise on distances to vulnerable zones) to less vulnerable areas.

Cross-media effects

The application of groundwater protection schemes is likely to restrict the surface area where landspreading is allowed, and as a consequence less area is available to apply the manure produced. Furthermore, it may be necessary to develop a programme in parallel that deals with the possible ways to treat the excess manure, such as on-farm treatment as discussed in Section 4.12.

Environmental performance and operational data

Every case is assessed individually, taking into account all local factors in order to find the best solution, achieve sustainability and match the standards set within the specific area. This means different decisions may be taken if the farm is located within, or is impacted by, a water protection zone; here a decision should be made concerning the technique to apply in order to meet the requirements, taking into account costs and profitability.

Technical considerations relevant to applicability

Groundwater schemes can be applied wherever a potential risk of groundwater contamination exists.

Economics

The economic impact of groundwater schemes is related to the individual measures that can or must be applied.

Driving force for implementation

Schemes have been developed in many Member States based on the European Water Framework Directive (2000/60/EC), the Groundwater Directive (2006/118/EC) and national legislation for the protection of groundwater.

Example plants

Groundwater protection schemes are applied in several Member States.

Reference literature

[23, EPA (UK) 1999]

4.13.3 Manure landspreading management practices**Description**

A proper management of manure landspreading takes account of the nutrient balance (see Section 4.13.1), as well as surface water and groundwater protection schemes (see Section 4.13.2). It combines the following aspects:

- application on suitable areas;
- defining and observing buffer zones;
- proper timing of application;
- defining of spreading rate (in relation to nutrient content).

Codes of practice advise setting up an application plan and distinguishing between different planning stages [386, DEFRA 2009].

In the first stage, suitable areas are selected. Land is excluded, where manure should not be spread at any time or where there is a considerable risk of run-off, such as (very) steep slopes and surroundings sensitive to smell. Buffer zones should be defined and observed, in particular to avoid contamination of watercourses or the farmyard. Specific rules apply, such as minimum distances (50–100 m) to springs, wells or boreholes. These distances increase when the springs

or shallow wells are downhill. Decisions at this stage may benefit from the latest developments in soil testing and field mapping.

In the second stage, the amount of nutrients supplied by the manure must be matched with the potential nutrient uptake of the crop to be grown. Determination of the spreading rate (kg/ha or m³/ha) should be based on land availability, crop (or grass) nutrient requirements, and the nutrient content in the slurry, taking into account the nutrient status of the crop and other manures and mineral fertilisers applied. In most reports, reference is made to the potential leaching of nitrate and a maximum of 250 kg of total N/ha from manure per year is recommended for land outside NVZ. This amount should be lower where already high available phosphorus contents in the soil limit the potentially applicable amount of manure.

The third stage optimises seasonal application timing by estimating the risk of emissions from spreading. The aims are to minimise run-off and run-through to field drainage systems, according to the characteristics of the land concerned, as well as emissions to air (e.g. ammonia, odour), considering in particular soil and weather conditions (e.g. spreading when it is cooler and less windy) [[508, TFRN 2014](#)].

Achieved environmental benefits

A management system for seasonal timing landspreading operations, and for recording solid and liquid manure application amounts at different times, may result in quantifiable farm-scale reductions in ammonia emissions. The planning of landspreading can also reduce emissions of odour, loss of nutrients due to leaching, and run-off. Potential emission reductions achievable through these measures will vary depending on farm-specific soil and climatic conditions [[508, TFRN 2014](#)].

Cross-media effects

Individual manure management strategies may present some adverse effects when mitigating one pollutant, with possible shifting from one environmental media to another or increased emissions of other pollutants. Safety aspects associated with machinery operations carried out at certain times, particularly during hours of darkness, should also be considered.

Environmental performance and operational data

The seasonal timing of the application aims to optimise the use of the available nutrients in manures. Soil, nutrient status, weather conditions and the crop requirements in accordance with its growing season must be taken into account when planning manure application.

Soil type and conditions

Land with a very high risk of run-off (water-saturated, snow-covered, frozen, flooded areas, watercourses, etc.) should be avoided. Limits to the spreading rate are suggested at 50 m³/ha for slurry and 50 tonnes/ha for dry manure (UK) on high-risk land. For poultry, this usually means 5–15 tonnes/ha. Manure should not be landspread on fields that are cracked, or on fields that have been drained within the last year either.

As an example, the application of 50 m³/ha of a pig slurry with 4 % dry matter, containing 4.0 kg/m³ of total N, will supply 200 kg/ha of total N. If this is applied in December to the surface of arable land on a heavy-textured soil, it will provide 80 kg/ha of N (i.e. 40 % of the 200 kg/ha total N) for the nitrogen requirement of the crop that will grow towards spring. If the same amount of slurry with the same characteristics is applied on a sandy soil, the amount of available nitrogen for the next crop would be 50 kg/ha of N (25 % of the 200 kg/ha total N) [[389, ADAS 2001](#)].

Weather conditions

Landspreading should be avoided in periods that are too dry and windy, such as in the summer months. However, in some areas where heavy winter rains occur, the soil has a reduced bearing capacity and will compact faster in those periods, so the drier season needs be taken advantage of. Ammonia emissions can be reduced by optimising the timing of application, i.e. cool and

humid conditions, in the evening and night, before or during light rain (though water-logging of soils can make spreading conditions unfavourable), and by avoiding spreading during warm weather [508, TFRN 2014].

Crop growing season

Manure should be spread as close as possible to the main uptake period of crops so that a maximum nutrient uptake will occur.

Results of studies carried out in the UK investigating the timing of manure application on free draining soils and for different types of plants have concluded the following:

- For winter cereals, for the application of pig slurry in autumn on cropped land, N leaching losses were equivalent to 20 % of the total N applied, which indicates a lack of crop N uptake (by the winter wheat crops). Compared with the autumn application, spring landspreading results in lower leaching losses of the nitrogen applied and the highest crop nitrogen uptake of the applied manure. However, different soil conditions, such as water-saturated arable soils in spring and 'dry' grassland soils in summer, may potentially lead to increased ammonia emissions, because infiltration rates into the soil are lower than at other times of year; warmer weather conditions could also increase ammonia emissions. Therefore, slurry applications are often limited to the period between February and May, due to the highest crop nitrogen uptake being during this period and the potential mechanical crop damage caused by application after this period.
- On grassland, spring slurry applications before silage harvest (first cut) are likely to cause the least diffuse pollution from N compounds, because the risks of nitrate leaching losses are low and crop N uptake will be the greatest, reducing the soil mineral N pool available for nitrous oxide production. However, slurry applications to short grass swards in summer are likely to lead to elevated levels of ammonia emissions compared with autumn to spring application timings [244, ADAS 2006].

In another study, carried out using a fertilising planning tool called 'MANNER' simulating UK conditions (e.g. rainfall, soil and crop conditions), results suggest that, in order to avoid increased NO_3^- leaching from $\text{NH}_4\text{-N}$ conserved in the manure, as a consequence of measures to reduce NH_3 emissions, manures and slurries should not be incorporated to autumn-sown crops, but should be applied from October onwards to grassland and, where possible, to late autumn-sown combinable crops, or to arable land which will be planted in the spring. Additional conclusions of the study propose that manure from laying hens and broilers should not be incorporated before October, on any type of soil. If increased NO_3^- leaching is to be avoided, incorporation needs to be delayed until January on most soil types, and until early March on light soils in wet areas [249, Webb et al. 2001].

Of the many complaints about unpleasant odours from farms, most relate to manure landspreading. The following points should, therefore, be considered before spreading:

- respect the recommended or mandatory timing set by local rules, and avoid spreading when people are more likely to be at home, unless it is absolutely necessary;
- pay attention to wind direction in relation to neighbouring houses;
- avoid spreading in warm humid conditions;
- use spreading systems which minimise the production of dust or fine droplets;
- cultivate land as soon as possible after landspreading.

Technical considerations relevant to applicability

The management of manure application can be performed without any limitation or requirements. The planning of manure application should play a vital role in the planning of new units and should consider any limitations that already exist.

Economics

In most cases, in order for farmers to comply with an application management plan, which will result in increased efficiency of slurry nitrogen utilisation and a reduction of emissions (nitrate leaching, ammonia and/or nitrous oxide emissions), extra storage capacity is required. A greater manure storage capacity enables farmers to shift manure application from autumn/early winter to spring. In addition, advanced spreading equipment, in particular for slurry application, will be necessary (e.g. band spreaders, injectors), to optimise nitrogen utilisation by crops with minimal soil compaction and crop damage [244, ADAS 2006]. From the UK, in particular, costs associated with an application management plan combined with extra storage capacity, shift of the application technique from broadcast spreaders to trailing hose, and designed to avoid autumn/winter slurry applications, are presented in Table 4.200.

Table 4.200: Costs for implementing spring slurry application practices in a typical pig farm in the UK in order to limit nitrate leaching losses

Parameter	Investment costs	Annual amortised costs ⁽¹⁾	Remarks
	EUR ⁽²⁾	EUR/year ⁽²⁾	
Extra storage capacity	50 000	3 980	Assumed slurry storage costs: EUR 40/m ³ . Annual amortised repayment costs based on an interest rate of 5 % over a 20-year period
Slurry tanker fitted with a trailing hose boom	28 400	3 700	Annual amortised repayment costs based on an interest rate of 5 % over a 10-year period
Total cost	NI	7 680	NI
Savings in fertiliser N applications ⁽¹⁾	NI	465–750	Based on a N fertiliser cost of EUR 0.34/kg
Net cost	NI	~ 9 600	Amortised over 10–20 years
⁽¹⁾ Savings in N mineral fertiliser applications, resulting from reduced nitrate leaching losses in spring, compared with autumn/winter application timings and from reduced ammonia emissions from band spreading. ⁽²⁾ Costs calculated at the exchange rate of EUR 1 = GBP 0.88. NB: NI = no information provided. <i>Source:</i> [244, ADAS 2006]			

Driving force for implementation

Requirements for compliance with existing legislation and Codes of Good Agricultural Practice.

High fertiliser prices, improved handling and advanced spreading equipment, and improved awareness and knowledge of farmers and advisers facilitate better planning and use of manure as a valuable fertiliser during landspreading. The improved nitrogen availability achieved by the efficient manure utilisation soon return a profit on the investment in low-emission spreading equipment. Once the benefits become evident, measures related to a proper application management plan tend to be adopted routinely.

Legal procedures from neighbouring residential areas and fines for pollution of watercourses can be avoided by properly planning the application. It is considered that planned manure application management can save costs rather than generate costs.

Example plants

‘Codes of Good Agricultural Practice’ describing farm manure management are commonly applied.

Reference literature

[31, MAFF 1999] [244, ADAS 2006] [249, Webb et al. 2001] [386, DEFRA 2009] [389, ADAS 2001] [390, ADAS 2001] [508, TFRN 2014] [554, EPA (IE) 1998] [624, IRPP TWG 2013]

4.13.4 Manure application systems

4.13.4.1 Use of low-emission manure (solid or liquid) application techniques

Description

Different application techniques are used for solid manure and for slurry. Generally, their use is followed by incorporation of the manure (solid or liquid), except for the direct-injection techniques used for the application of slurry.

Application of solid manure

Section 2.8.3 describes the following three main types of spreaders used for spreading solid manure:

- Rotaspreader: a side-discharge spreader with a rotor that throws the solid manure out to the side, while spinning.
- Rear discharge spreader: a trailer body fitted with a moving floor or other mechanism which delivers solid manure to the rear of the spreader. The spreading mechanism can have either vertical or horizontal beaters, plus in some cases spinning discs.
- Dual-purpose spreader: a side-discharge spreader with an open-top V-shaped body capable of handling both slurry and solid manure.

The latter two are much better for achieving an accurate application rate and even spread distribution. However, for reducing ammonia emissions from landspreading solid manure, the important factor is not the technique on how to spread but rather the incorporation.

Application of slurry

Nitrogen is preserved better during the storage and spreading of liquid manure than in the solid manure handling chain. Ammonia losses mostly occur immediately after spreading.

The following slurry application systems are applied (see also Section 2.8):

- low-pressure broadcast spreader;
- band spreader;
- trailing shoe;
- injector (open slot);
- injector (closed slot);
- high-pressure injector;
- irrigator.

The low-pressure broadcast spreader and the techniques described in Sections 4.13.4.2.1, 4.13.4.3 and 4.13.4.4 are spreading systems for slurry that can each be fitted onto a vacuum tanker or pumped tanker or used with an umbilical system as described in Section 2.8.

The low-pressure broadcast spreader consists of a tanker equipped with a discharge nozzle and a splash plate applicator. It spreads the slurry over the whole soil surface ('broadcasts') and is considered the reference (baseline) for assessing emission reduction efficiencies from slurry applications performed with other techniques, when not followed by quick incorporation [508, TFRN 2014]. This technique does not significantly contribute to lower ammonia losses. In addition, if slurry is applied on a growing arable crop, incorporation is not possible [35, Netherlands 2010]. Due to the aforementioned characteristics, the technique is not discussed further in the following sections.

High-pressure injection forces the slurry into the soil under pressure, without needing to break the soil using tines or discs. The technique does not seem to have gained widespread application; therefore, it is not discussed in the sections below.

Acidification of slurry, prior to or while spreading, is also applied using standard equipment (see Section 4.12.9). A summary of the main characteristics of slurry distribution systems (excluding irrigators because of the lack of data) is presented in Table 4.201 and some further information is given in the text.

Table 4.201: Characteristics of four different slurry application techniques

Features	Broadcast spreader	Diluted slurry irrigators	Band spreader (Trailing hose)	Band spreader (Trailing shoe)	Injector	
					Open slot (shallow)	Closed slot (deep)
Reduction of NH ₃ emissions (%)	Reference	30	30–50	40–65	56–80	80–90
Land use	NI	Grassland, arable land	Grassland, arable land	Mainly grassland and arable at early stages or with widely spaced rows	Arable land, grassland	Arable land, bare soil
Range of dry matter	Up to 12 %	< 2 %	Up to 9 %	Up to 6 %	Up to 6 %	Up to 6 %
Applicability	NI	Flat land, any cultivation growth stage, size and shape of fields Not applicable where irrigation is not required	Slope (for tankers < 15 %, for umbilical systems < 25 %), not for viscous slurry or with high straw content, size and shape of fields should be considered, growing crop Can be used on solid-seeded crops and wide units may be compatible with tramlines	Slope (for tankers < 20 %, for umbilical systems < 30 %), not viscous slurry, size and shape of the field, grass height should be > 8 cm Not suitable in growing solid-seeded crops, but possible use in the rosette stage and in row crops	Slope < 12 %, greater limitations for soil type and conditions, not viscous slurry Unsuitable on high stone content, shallow soils, high clay soils (> 35 %) in very dry conditions, peat soils (> 25 % organic matter content). Tile-drained soils susceptible to leaching	(See open slot)
Requires separation or chopping	No	Clarification	Up to 6 % no Over 6 % yes	Yes	Yes	Yes
Relative work rate	●●●	●●●	●●	●●	●●	●
Uniformity across spread width	●	●●●	● (simple) ●●● (advanced)	●●●	●●●	●●●
Crop damage	●●	●●●	●●●	●●●	●●●	●●●
NB: NI = no information provided. ● Normal (lowest grade). ●● Improved. ●●● Advanced (best evaluation). Source: [42, Netherlands 1999] [389, ADAS 2001] [390, ADAS 2001] [236, Denmark 2010] [237, Denmark 2010] [238, Denmark 2010] [500, IRPP TWG 2011] [35, NL 2010] [440, Webb et al. 2010] [508, TFRN 2014] [575, UBA Germany 2011] [387, Denmark 2010] [603, Denmark 2009] [604, Denmark 2009] [234, Spain 2010] [235, Spain 2010] [236, Denmark 2010] [237, Denmark 2010] [238, Denmark 2010] [500, IRPP TWG 2011]						

Achieved environmental benefits

Each technique has its limitations and is not applicable in all circumstances and/or on all types of land. Techniques that inject slurry give the highest reduction, but techniques that spread slurry on top of the soil followed by incorporation shortly afterwards can also achieve a high reduction [35, Netherlands 2010].

The emission reduction levels achieved by applying different techniques are considered to be very site-specific and vary according to the slurry's dry matter content, the prevailing weather conditions, the soil type and conditions, and the crop conditions, but mostly according to the amount of ammoniacal nitrogen (TAN) spread on the land.

Techniques for landspreading solid manure do not, in general, influence ammonia emissions. Incorporation by ploughing or harrowing after application reduces ammonia losses by burying the majority of the manure [441, Webb et al. 2011].

Cross-media effects

The use of heavy equipment causes soil compaction and damage, with a consequent potential risk of water pollution, especially in late winter/early spring. Surface broadcasting is typically uneven, especially under windy conditions, and may also damage grass swards and contaminate crops with microorganisms that could impede silage fermentation. Techniques that reduce NH₃ emissions may induce an increase in N₂O emissions, due to the higher rate of nitrogen entering the soil and the less aerobic conditions (deeper and wetter soils). However, under some circumstances, such increases do not always occur [440, Webb et al. 2010].

Environmental performance and operational data

The conditions during slurry application greatly affect the performance of the techniques. In particular, ammonia abatement efficiencies vary depending on the following:

- Ammonia volatilisation. This may be reduced by minimising exposure of the manure surface to air and by increasing contact with the soil.
- Slurry dry matter content. Dilution of the slurry, or separating out the solids, reduces NH₃ emissions. It is considered that from a slurry with 6 % dry matter (DM), ammonia emissions are typically 20 % higher than those from a 2 % DM slurry. Reduced losses from low-DM slurries are associated with faster infiltration into the soil, compared with high-DM slurries which remain longer on the soil or plant surface [389, ADAS 2001]. Dilution requires water and creates a larger volume to be applied, whereas removing solids requires the handling of a solid fraction and a liquid fraction as well. The higher the accuracy of application, the lower the dry matter content of the slurry can be, thus requiring some chopping or separation before the slurry can be applied. Injection or incorporation of manure minimises exposure to the air.
- Prevailing weather conditions. Ammonia emissions increase with increasing air temperature, wind speed and solar radiation [508, TFRN 2014] [440, Webb et al. 2010].
- Soil type. Well-draining and dry soils, which allow faster infiltration, can give rise to lower emissions than wet soils with a reduced infiltration rate. However, some soils may become hydrophobic when very dry, which can also reduce infiltration and therefore increase emissions [508, TFRN 2014].
- Crop conditions. Spreading slurry with trailing hoses on crops reduces ammonia losses compared with application on bare soil, as crops can restrict solar heating and wind speed, and as a certain proportion of the volatilised ammonia can be absorbed by the crop. The crop height is important, mainly in band spreading in cereal crops, which are significantly tall. In contrast, slurry application on grass crops takes place in early spring or immediately after cutting. At these times, the grass crop height is so short that the crop does not influence volatilisation of ammonia from the applied manure [442, Hansen et al. 2008].

- Nitrogen application rate. Ammonia emissions are normally increased with increasing TAN concentration and application rate. The level of emission also varies for different manure types [508, TFRN 2014].

The application of solid manure is always followed by incorporation. Even short delays (4 to 6 hours) in incorporating the manure after application will reduce the efficacy of controlling ammonia emissions. Hence, incorporation should be done as soon as possible (see Section 4.13.5) [440, Webb et al. 2010]. Other factors that may influence ammonia and nitrous oxide emissions following solid manure spreading are as follows:

- Higher application rates, increasing the proportion of nitrogen lost as ammonia.
- Climatic conditions, such as air temperature, radiation, wind speed and rainfall, may affect emissions. Ammonia losses are expected to increase with increasing temperature. However, crusting of the surface layer of manure at higher temperatures may reduce emissions. The formation of N₂O increases with temperature.
- Rainfall is a parameter which influences NH₃ emissions in a contradictory way. On one hand, due to NH₄-N leaching from manure to the soil, less ammonia is emitted but, on the other hand, due to increased hydrolysis of uric acid to NH₄⁺, more NH₃ can then volatilise.
- While no influence of soil type on NH₃ emissions from solid manure has been demonstrated to date, N₂O emissions from agricultural soils were found to be higher from fine soils than from coarse-textured soils. Nitrous oxide production can increase with increasing soil moisture. However, increasing soil moisture and decreasing temperatures (e.g. over the winter period) are expected to favour the reduction of N₂O to N₂.

Technical considerations relevant to applicability

A number of factors must be taken into account in determining the applicability of each technique. These factors include:

- soil type, condition and texture (soil depth, stone content, wetness, travelling conditions);
- topography (slope, size of field, evenness of ground);
- manure type and composition (slurry or solid manure);
- crop type and its growth stage.

Economics

The costs of landspreading techniques are in the range of EUR 0.1–5/kg NH₃-N saved, with the lowest costs corresponding to application with immediate incorporation. Costs are very sensitive to farm size and whether or not specialist contractors are involved [601, ALTERRA-IIASA 2012] [508, TFRN 2014].

The investment costs of slurry spreading systems vary considerably, depending on the specifications for each machine, and whether they have hydraulic/electric controls, single/double/triple axles or other extras. Slurry tankers constructed to take attachments will have a stronger chassis or special brackets fitted, compared to stand-alone slurry tankers.

Examples of cost data, estimated in the UK and Germany, in relation to reduction rates of ammonia emissions, and expressed as the value of the extra nitrogen uptake due to conserved nitrogen (bonus), are presented in Table 4.202. The value of the conserved nitrogen (bonus) depends on fertiliser prices and the ammonia abatement efficiency. A reduction technique is cost-neutral if the reduction costs are identical or lower than the amount of the corresponding bonus. The estimations have been made in comparison with the use of a broadcast spreader, assumed as the reference technique.

Table 4.202: Bonus for conserved nitrogen, achieved by applying low-emission spreading techniques for slurry

Technique	Example from Germany		Example from UK	
	Associated NH ₃ emission reduction (%)	Bonus (EUR/m ³ slurry)	Associated NH ₃ emission reduction (%)	Bonus ⁽¹⁾ (EUR/m ³ slurry)
Trailing hose	30	0.27	40	0.53
Trailing shoe	50	0.45	65	0.85
Open slot injector (discs)	60	0.54	80	1.07
Closed slot injector (cultivator)	90	0.81	NI	NI
Immediate incorporation	NI	NI	95	1.27
Incorporation within 1 h	90	0.81	NI	NI
Incorporation within 4 h	70	0.63	NI	NI
<i>Source</i>	[575, UBA Germany 2011]		[254, Webb J.M. et al. 2009]	
⁽¹⁾ Values are calculated at the exchange rate of EUR 1 = GBP 0.88.				
NB: NI = no information provided.				

Costs for the spreading of slurry and associated ammonia emission reduction costs depend on the equipment used, the exploitation of its capacity for slurry application, and the farm size. Cost data from Germany, related to the spreading of slurry, are presented in Table 4.203 for different spreading and incorporation techniques and farm sizes. In general, the capital cost of ownership is high; most individual UK farmers use contractors [440, Webb et al. 2010].

Table 4.203: Costs for slurry spreading and associated ammonia emission reduction costs for different application techniques and farm sizes, in Germany

Farm size and characteristics						
Annual process capacity (m ³ /year)	1 000	3 000		10 000	30 000	100 000
Characteristics	Single farm, with necessary equipment	Slightly larger farm or a cooperative of smaller farms, sharing equipment		A cooperative or a larger farm	Contractors and large farms	
Process capacity (m ³ /h)	Low	High	Low	Low	NI	NI
Spreading costs (EUR/m ³ slurry)						
Broadcast spreader ⁽¹⁾	6.61	3.22	4.31	3.04	3.19	2.49
Trailing hose	8.76	3.99	5.08	3.38	3.32	2.57
Trailing shoe	9.68	4.63	5.87	4.11	4.10	NI
Open slot injector (discs)	9.97	4.89	6.16	4.37	4.67	2.89
Closed slot injector (cultivator)	10.38	5.71	7.49	4.96	5.30	3.04
Incorporation within 1 h	7.43	4.04	5.13	3.86	4.02	3.31
Incorporation within 4 h	7.10	3.71	4.80	3.53	3.69	2.98
Dilution with water 1:1	11.1	6.08	8.81	6.49	5.95	4.4
Ammonia emissions reduction costs (EUR/kg NH ₃)						
Trailing hose	8.80	3.16	3.16	1.42	0.50	0.34
Trailing shoe	6.29	2.89	3.20	2.20	1.86	NI
Open slot injector (discs)	4.60	2.28	2.53	1.82	2.02	0.55
Closed slot injector (cultivator)	3.43	2.27	2.89	1.75	1.91	0.50
Incorporation within 1 h	0.75	0.75	0.75	0.75	0.75	0.75
Incorporation within 4 h	0.81	0.81	0.81	0.81	0.81	0.81
Dilution with water 1:1	7.37	4.69	7.37	5.65	4.52	3.13
⁽¹⁾ Reference system.						
NB: NI = no information provided.						
Source: [575, UBA Germany 2011]						

Driving force for implementation

High fertiliser prices, improved handling and spreading equipment, improved awareness, and farmers' and advisers' knowledge facilitate better operability and manure utilisation.

Reduced ammonia losses result in a reduced use of expensive mineral fertilisers. Therefore, the improved nitrogen availability makes the investment in low-emission spreading equipment more profitable.

Compared to broadcast spreading, these techniques minimise the occurrence of herbage contamination; this is particularly relevant for grassland, where slurry contamination can reduce grazing palatability or silage quality and can transfer pathogens between farms if manure or equipment is shared.

These techniques also allow slurry application for growing arable crops (particularly cereals), which, in general, are not suitable to receive slurry applied by broadcast spreaders (splash plate). The use of low-emission techniques can increase the flexibility of slurry application [601, ALTERRA-IIASA 2012].

Band spreading and injection techniques considerably reduce the odour associated with manure application, therefore allowing application on areas or at times that would otherwise be unavailable due to complaints. Additionally, band spreading and injection techniques can allow more accurate slurry application rates than broadcasting (reference technique) [508, TFRN 2014].

Example plants

All techniques are applied in Europe. In the UK, there has been a large general increase in the uptake of reduced-NH₃-emission machines over the past years [440, Webb et al. 2010].

In the last decade, several livestock farmers have outsourced manure application to specialised contracting firms, which use large machines with high capacities in terms of m³ of manure and/or m² of land applied per man-hour. This has led to considerably lower costs and to the use of available techniques on a much larger scale in many more countries [601, ALTERRA-IIASA 2012].

Reference literature

[35, Netherlands 2010] [42, Netherlands 1999] [234, Spain 2010] [235, Spain 2010] [236, Denmark 2010] [237, Denmark 2010] [238, Denmark 2010] [254, Webb J.M. et al. 2009] [387, Denmark 2010] [389, ADAS 2001] [390, ADAS 2001] [406, Netherlands 2002] [440, Webb et al. 2010] [441, Webb et al. 2012] [442, Hansen et al. 2008] [500, IRPP TWG 2011] [508, TFRN 2014] [575, UBA Germany 2011] [601, ALTERRA-IIASA 2012] [603, Denmark 2009] [604, Denmark 2009]

4.13.4.2 Slurry dilution

Ammonia emissions from dilute slurry (less than 2 % dry matter content) application are generally less than for undiluted slurry because of the faster infiltration into the soil. Dilution can be achieved in water irrigation systems or by adding water before landspreading either in the slurry store or in the mobile tank. Other methods to reduce the dry matter content of slurry include anaerobic digestion (see Section 4.12.5) and solid-liquid mechanical separation (see Section 4.12.2).

4.13.4.2.1 Low-pressure water irrigation systems

Description

Controlled quantities of untreated slurry, or the clarified fraction from mechanically separated slurry, can be mixed with irrigation waters and applied to grassland or growing crops on arable land. The amounts of slurry are calculated to match the nutrient requirements of the crops. Slurry is pumped from the stores, injected into the irrigation water pipeline and brought to low-pressure sprinklers, pivots or travelling irrigators, which spray the mix onto land [508, TFRN 2014] (see Figure 4.95).



Source: [242, CRPA 2009]

Figure 4.95: Irrigation boom fitted with hanging nozzles to spray the water-slurry mixture close to the soil surface

Achieved environmental benefits

Ammonia emissions from dilute slurries, with a low DM content, are lower than those from undiluted slurries, due to the faster infiltration into the soil, which prevents both ammonia volatilisation and formation of crusts on the ground, and also due to the lower $\text{NH}_4\text{-N}$ concentration in the slurry [508, TFRN 2014]. The use of intermittent operation may also limit the odour nuisance. The energy requirement for low-pressure irrigators is low. Reduced soil damage and compaction are also achieved.

Cross-media effects

With dilute slurry irrigation systems, the duration of landspreading is much longer. Also, the high volumes of dilute slurry applied by irrigation may exceed the infiltration capacity of the soil, leading to higher emission rates in the period immediately after landspreading.

When diluting slurry, extra storage capacity may also be needed. Since volumes for storage and application increase, the associated costs are also amplified [508, TFRN 2014] [624, IRPP TWG 2013].

Environmental performance and operational data

The emission reduction is proportional to the extent of dilution. For undiluted slurry, dilution with water (reduction in dry matter content) of 50 % (1 : 1 water to slurry) can reduce emissions by 30 % [508, TFRN 2014]. Dilution rates may be up to 50 : 1 water to slurry [601, ALTERRA-IIASA 2012]. If the system is properly operated, sprays are directed close to the ground, reducing losses from evaporation and aerosol drifts.

Ammonia emissions during irrigation (before reaching the soil) of dilute pig slurries (0.5–0.9 % DM) were measured as 0.1 % to 2.6 % of the TAN applied, with an average of 1.3 %. Emissions are expected to be greater from a high-pressure raingun than from boom-mounted splash plate systems. Emissions following irrigation are estimated as approximately 10 % of the applied TAN.

Technical considerations relevant to applicability

Landspreading of diluted slurry by water irrigators is possible at almost any growth stage, allowing the maximum utilisation of nitrogen by plants. Due to the risk of contamination, irrigation with diluted slurry would not be appropriate for crops grown to be eaten raw.

Application of the technique is often only possible in areas easily connected to a farmstead by fixed pipework. The pumping distance is influenced by the pump capacity, topography and the pipe dimensions; therefore, it may pose an added limitation. The application of dilute slurry with irrigators should meet crop water needs; otherwise, dilution of slurry would result in

increased hauling costs and may exacerbate nitrate leaching or manure run-off, especially on sloped fields. Application volumes and soil type and conditions (e.g. not saturated with water, not very compacted) should allow for rapid infiltration.

Economics

Costs are in the range of EUR 0.5–1.0 per kg of NH₃ abated [508, TFRN 2014].

Driving force for implementation

The technique can be used where there is a need for water irrigation systems.

Example plants

It is estimated that approximately 20 % of the total pig slurry output in the UK is landspread by irrigation systems, including rainguns, boom-mounted, pulse-jet and rotary boom systems. The technique of low-pressure irrigators is in common use in the UK, particularly for dirty water application. Static sprinklers are used for smaller applications, whereas travelling low-rate irrigators are used for larger applications. Irrigation techniques with sprinkler systems are moderately spread in Italy in farms with anaerobic digestion plants [240, Italy 2010].

Reference literature

[240, Italy 2010] [242, CRPA 2009] [247, IGER 2003] [508, TFRN 2014] [601, ALTERRA-IIASA 2012] [624, IRPP TWG 2013]

4.13.4.2.2 Pulse-jet irrigator

Description

A hosepipe is mounted on a rotating arm and delivers a pulse of slurry or dirty water every 30–150 seconds over some 60 m along the radius of the circle. The arm rotates in 9 ° steps to give a circular pattern and achieve full coverage over a number of rotations (see Figure 4.96).

About 100 litres of liquid are gradually pumped into a pressure accumulator tank and are discharged when the pressure reaches a preset level. The slurry emerges from large jets (49 mm and 19 mm diameter) as a solid stream for about 3.5 seconds and breaks up into large droplets as it passes through the air. Then, the pressure tank refills, the nozzle moves round and the next pulse is discharged, typically about 45 seconds later, depending on the size of pump used.



Source: [246, Basford 2010.]

Figure 4.96: Pulse-jet irrigator in operation

Achieved environmental benefits

There is virtually no risk of soil compaction and minimal risk of water pollution due to the controlled landspreading.

Cross-media effects

The disadvantage of increased aerial emissions compared to low-level placement techniques is relatively low, due to the very large droplet size. The energy use of the technique is about 0.5–0.8 kWh/m³.

Environmental performance and operational data

The ultra-low application rate (0.1–2 mm/hour) and high degree of accuracy allow nitrogen to be supplied to crops when needed. There is virtually no risk of soil compaction and minimal risk of water pollution as the application rate can be kept below the rate of infiltration into the soil, for any soil type (e.g. 4 mm/hour for a clay soil on level ground, and 1 mm/hour on a 16° slope).

Adjoining circles are overlapped by placing centres approximately 105 m from one another, normally using a triangular arrangement. A central area of 7.5 m around the machine receives a low application rate and represents 1.6 % of the full 60 m circle, or 2 % of the overlapped 52.5 m circle. In the overlapping pattern, small roughly triangular areas are not fully covered and therefore also receive a lower application rate. These account for 1.3 % of the area of the 60 m circle, and neither type of area with low-application areas is considered significant.

The average precipitation rate achieved by the pulse-jet irrigator is 0.3–1.0 mm per hour, while the maximum precipitation rate for slurry to avoid run-off is 5 mm per hour [624, IRPP TWG 2013].

Emissions are estimated to be similar to or less than those of any broadcast system (depending on weather and humidity). While the exposure may be greater at the time of discharge, applications well below the infiltration rate reduce emissions by allowing rapid absorption and

by reducing the residence time on the ground. Slurry infiltration is also improved by causing very little ground compaction. The energy use of the technique is also very low at 0.5–0.8 kWh/m³ [246, Basford 2010].

Technical considerations relevant to applicability

The irrigator should not be sited closer than 75 metres to any watercourse, to allow for an effective 15 m spreading distance. Grassland, cereals, root crops and brassicas are suitable for slurry spreading by this technique provided that the plants are sturdy enough to withstand the large droplet size. The pulse-jet irrigator can handle undiluted pig slurry at up to 5 % dry matter content. It can also be used to apply dirty water [246, Basford 2010]. Due to the risk of contamination, this technique is not appropriate for crops grown to be eaten raw.

Economics

The approximate total cost of an operating system is between EUR 12 750 and EUR 22 150, varying depending on the system's dimension and capacity. Irrigators cost EUR 4 700 or EUR 9 400, for a coverage of 0.5 hectare or 1.0 hectares, respectively. The cost of pumps with a capacity of 3 m³ to 10 m³ per hour vary from EUR 5 650 to EUR 10 350. Connecting pipework in medium-density polyethylene needs to be sized based on the slurry's dry matter content, the pumping capacity per hour, and the size of the pipe network. The cost of 1 000 m of pipe and fittings for 3 % DM slurry pumped at 6 m³/hour (that requires a 63 mm medium-density polyethylene main pipe) can cost around EUR 2 400 (values based on an exchange rate of EUR 1 = GBP 0.85).

Driving force for implementation

The low application rate and high degree of accuracy allow nitrogen to be supplied to crops when needed.

Example plants

Over 700 units have been sold in the UK by one producer over the past 20 years, with numbers varying between 15 and 100 units per year.

Reference literature

[246, Basford 2010] [624, IRPP TWG 2013]

4.13.4.2.3 Landspreading of diluted slurry using drip lines

Description

The liquid fraction of mechanically separated slurry can be distributed onto crops using drip lines, mixing it with irrigation water.

Achieved environmental benefits

Nitrogen utilisation by plants is improved, therefore related emissions are reduced. The low water consumption is implicit in this irrigation method.

Cross-media effects

Drip lines are foreseen to be replaced annually.

Environmental performance and operational data

In a trial carried out in Italy, the effects of the application of drip line technology to distribute the liquid fraction of digested pig slurry after mixing with irrigation water have been compared with those of the technique of band spreading of untreated pig slurry [241, Italy 2010]. The drip line system was fed by a pump supplying a mixture of about one part slurry to three parts water. Disc filtration was performed after mixing. The system was tested on maize placed in rows 0.7 m apart from one another, each drip line being positioned between alternate rows and thus 1.4 m from one another. The water-slurry mixture supply was always followed by 1 hour of irrigation of water alone in order to wash the drip lines. The mixture was distributed four times

on the crop at a rate of 2.5–3 l/m²/h, for a total of 12 hours over a period of 3 weeks. The water-slurry mixture after filtration that was distributed had the following average characteristics.

Table 4.204: Average chemical characteristics of the water-slurry mixture

Parameters	Unit	Average value
pH		8.2
Dry matter content	%	0.31 (0.26–0.35)
Total suspended solids	g/l	0.27
Volatile solids	g/kg	0.81
Total Kjeldahl nitrogen	mg/kg	627
Ammoniac nitrogen	mg/kg	540
<i>Source: [241, Italy 2010]</i>		

Comparison with the traditional band spreading technique revealed the same maize yields but significantly low emissions were measured, varying from 0.003 kg to 0.013 kg of ammonia per m³ of slurry applied.

Applicability

Drawbacks still remain in the operational implementation of this system, requiring the setting up of the slurry separation and distribution equipment, the maintenance of the pump and filter and rodent control.

Economics

The annual costs are estimated at EUR 840/ha including the annualised investment plus the annual operating costs.

Example farms

Five farms are reported to use the system in Italy.

Reference literature

[240, Italy 2010] [241, Italy 2010]

4.13.4.3 Band spreader (or trailing hoses) and trailing shoes

Description

Flexible (plastic or rubber) hoses or pipes are supported by a 12–28 m wide bar mounted onto the slurry trailer, at intervals of 25–50 cm. The bar is positioned at a height so that hoses either hang a short distance (< 150 mm) above the soil or are dragged along the soil surface. Slurry is discharged just above ground level, in a series of 5–10 cm wide parallel bands (see Figure 4.97). The working width can be as low as 6 m and as wide as 36 m [575, UBA Germany 2011].



Source: [223, Denmark 2010]

Figure 4.97: Example of trailing hoses mounted on a bar

A development of the band spreader is the trailing shoe application system. Trailing shoe spreaders can have a working width of 3 m to 18 m but typically it is limited to 6–8 m [508, TFRN 2014]. The individual trailing hoses are generally situated 16–35 cm apart. The difference with trailing hoses is that the outlet of each slurry application pipe is equipped with a special distributing unit, which is usually designed as a shoe-like reinforcement that slides (or floats) on the soil surface. The design of the distributor is such that the crops are pushed aside or the herbage is parted more effectively than by the hose during the distribution process, even if the hose is very close to the ground. In this way, slurry is deposited in bands below the crop canopy, onto the soil surface, with the minimum herbage or crop contamination (see Figure 4.98) [575, UBA Germany 2011].

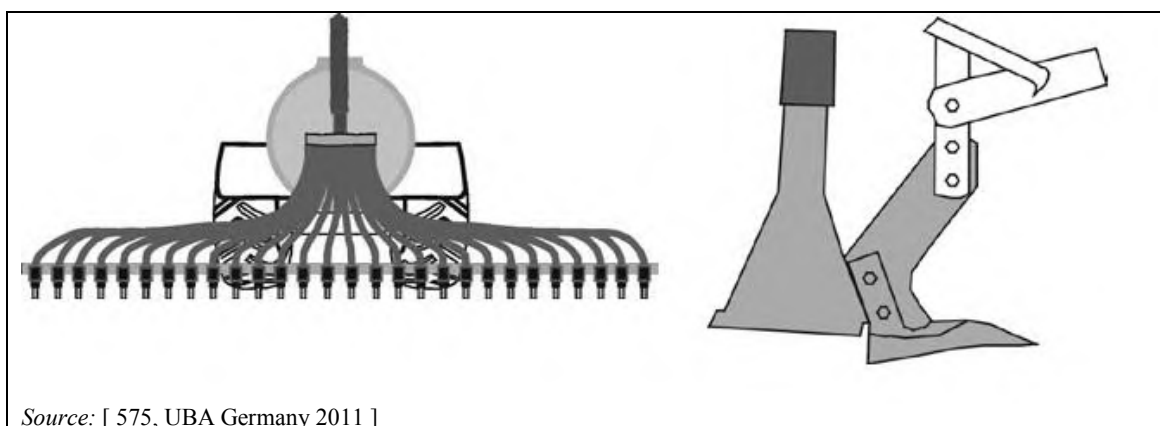

Source: [575, UBA Germany 2011]

Figure 4.98: Scheme of a trailing shoe spreader

With short herbage, the distinction between the two techniques can be less obvious, and therefore the ammonia emissions reduction efficiency of both machines is expected to be similar in shorter crops. By contrast, for taller canopies, a trailing shoe can be more effective at reducing ammonia emissions than a trailing hose, not only due to the more precise delivery of the slurry to the ground surface and the reduced degree of canopy contamination, but also because the slurry discharge below the canopy reduces the air movement and temperature in the emitting zone [601, ALTERRA-IIASA 2012] [440, Webb et al. 2010] [508, TFRN 2014].

Achieved environmental benefits

Because the slurry is placed directly on the ground in narrow bands, dispersion is avoided and, therefore, the total surface of the slurry in contact with air is significantly smaller than if the slurry was spread by a splash plate, and thereby the potential emission of ammonia and odour will be much smaller.

The efficiency of these machines can vary depending on the height of the crop. In particular, the ammonia emission abatement potential is higher when slurry is applied below well-developed grass or crop canopies, rather than on bare soil, as the canopy protects the applied slurry from wind and solar radiation. With the use of the trailing shoe spreader, ammonia emissions can be further reduced because slurry can be precisely placed below the grass canopy with the minimum canopy contamination. In fact, the trailing shoe allows the slurry to be incorporated into the upper soil layer (0–3 cm) [575, UBA Germany 2011]. Therefore, the emission reduction efficiency of band spreading is dependent on the crop canopy and on the application precision below the crop canopy with a minimal contamination of herbage. For the above reason, NH₃ emission reductions have typically been found to be larger from trailing shoes than from trailing hoses [508, TFRN 2014].

Slurry trailing hoses increases nitrogen utilisation, with a consequent reduced purchase of mineral fertiliser nitrogen, thus reducing the energy consumption and associated indirect emissions for manufacturing the fertiliser [602, Denmark 2010]. Odour emissions are also reduced compared to broadcast spread systems [233, Denmark 2010].

Cross-media effects

As for the broadcast spreader, there is a potential risk of emissions of nitrous oxide from the surface application of slurry with trailing hoses. In a reported study, it was found that emissions of nitrous oxide from grassland treated with slurry were 0.2 kg N₂O-N per hectare (which corresponds to an emission of approximately 0.25–0.50 % of the applied nitrogen) [602, Denmark 2010]. However, reduced-NH₃-emission application techniques do not always lead to greater emissions of N₂O [440, Webb et al. 2010].

Trailing hoses may result in wide bands; therefore, in the Netherlands, they are not allowed on grasslands [35, Netherlands 2010]. Band spreading also increases the hydraulic loading rate per unit area, which can on some occasions (usually for high dry matter content slurries) impede infiltration into the soil [648, DEFRA 2011].

Environmental performance and operational data

The system is commonly credited with 30–50 % ammonia emissions abatement in comparison with broadcast spreading [500, IRPP TWG 2011]. From Spain, a reduction efficiency of 25–58 % is reported [235, Spain 2010] for band spreaders, whilst from Denmark 42 % is reported [233, Denmark 2010].

With the use of trailing shoes, ammonia emissions are reduced by around 50 % [234, Spain 2010] [248, ADAS 2001], and up to 60 % [35, Netherlands 2010]. For applications to grasslands or to lands with a crop height over 10 cm, the advantages are increased.

From the UK, NH₃ reduction efficiencies for trailing hose and trailing shoe slurry spreading equipment are reported typically 30 % when the grass is short, and 60 % for trailing shoe equipment when the grass is long (> 10 cm) compared with broadcast application [648, DEFRA 2011].

Technical considerations relevant to applicability

Trailing hoses can be used for all types of slurry, e.g. untreated slurry, digested slurry from biogas plants, the liquid fraction from slurry separation, and acidified slurry.

The technique is applicable to grass and arable land, e.g. for applying slurry between rows of growing crops. The system with trailing hoses is less restrictive than that with shoes because it can be more widely used in standing crops without damage and is amenable to tramline systems. The system with trailing shoes is mainly applicable to grassland and arable crops at early stages or with widely spaced rows; it is not recommended for growing solid-seeded arable crops, where the action of the shoe can result in excessive plant disturbance [508, TFRN 2014].

Because of the width of the machine, the technique is not suitable for small, irregularly shaped fields or steeply sloping land due to the run-off potential. The hoses may also become clogged if the dry matter content of the slurry is high (> 10 %), or if the slurry contains large solid particles, e.g. if the straw content of the slurry is too high. However, the clogging of pipes is usually avoided by including a chopping system but this adds significantly to the cost of the system [508, TFRN 2014].

In cases where contractors are not used to carry out the slurry application, it is necessary for the farm operator to be able to handle the technology correctly, and have the necessary skills to navigate big equipment on the field, in order to achieve the potential environmental benefits of the technology [233, Denmark 2010]. The technology depends on an adequate slurry trailer with sufficient strength, and also on the equipment for mounting the trailing hose bar.

Economics

Ammonia emission reduction costs and spreading costs reported by Germany for different farm sizes are presented in Table 4.203. Compared with splash plates, band spreaders have a slower work rate and, therefore, higher tractor costs per unit of spread slurry. In comparison with splash plate machinery, repair costs are higher, due to the increased contact between the soil and the machine and the increased number of moving parts [254, Webb J.M. et al. 2009].

A trailing hose system with the same capacity as a broadcast spread system has an additional price of EUR 12 000–25 000. Annual operating costs are considered to be around EUR 1 per m³/year (from EUR 0.9 to EUR 1.1 per m³/year) [233, Denmark 2010].

From the UK, the approximate investment costs for trailing shoe machines, without the tractor, are reported (February 2009 prices, at the exchange rate of EUR 1 = GBP 0.88) as being between EUR 32 000 and EUR 46 500 for a tanker-mounted machine and EUR 15 500 for an umbilical-system-mounted machine [254, Webb J.M. et al. 2009]. Operating costs for the combined tractor and band spreader, in comparison with the use of a broadcast spreader (splash plate), are reported in Table 4.205. The reported cost data take into account machinery depreciation, the interest rate, insurance, fuel, maintenance and labour.

Table 4.205: Estimated operating costs for a band spreader system and a broadcast system for the application of slurry

	EUR/man-hour	EUR/m ³ of slurry
Band spreading		
Tractor	30.6	1.13
Band spreader	19.9	0.74
Total	50.5	1.87
Broadcast spreading		
Tractor	30.6	1.02
Splash plate	7.7	0.26
Total	38.3	1.28
NB: Cost data are based on the following assumptions:		
<ul style="list-style-type: none"> • Exchange rate of EUR 1 = GBP 0.88. • Assumed purchase prices: EUR 58 000 for a 150–180 HP tractor; EUR 13 600 for the splash plate tanker; EUR 32 000 for the band spreader. • 1 000 hours/year and 500 hours/year of operation respectively, for the tractor and the band spreader. • The spreading rate of the broadcast spreader is assumed to be 9 % higher (30 m³/h) than the band spreader (27 m³/h). 		
Source: [254, Webb J.M. et al. 2009]		

Extra costs calculated in Spain are shown in Table 4.206. Cost comparisons are made with a broadcast spreader (splash plate) without incorporation within 24 hours.

Table 4.206: Extra costs related to slurry application with band spreading techniques in comparison with a broadcast spreader, in Spain

Technique	Ammonia emissions reduction (%)	Extra costs		
		EUR/m ³ slurry	EUR/tonne pig produced	EUR/kg NH ₃ abated
Trailing hose	40–51	0.79–1.21	9.9–15.1	3.6 ⁽¹⁾ –5.5 ⁽²⁾
Trailing shoe	50	0.92–1.41	11.5–17.6	3.3 ⁽³⁾ –5.1
⁽¹⁾ Calculated value. NH ₃ reduction 40 %. ⁽²⁾ NH ₃ reduction 40 %. ⁽³⁾ Calculated value. Source: [234, Spain 2010] [235, Spain 2010] [338, Piñeiro et al. 2009] [379, Spain 2009]				

It is estimated that the fuel consumption for using trailing hoses is the same as for the splash plate technology.

Driving force for implementation

Nitrogen utilisation by plants is improved as emissions are reduced. Application of slurry with trailing hoses increases nitrogen utilisation compared to the splash plate technology. Therefore, there is an increased saving potential from a lower purchase of nitrogen mineral fertilisers [602, Denmark 2010] [440, Webb et al. 2010]. Both systems of slurry band spreading allow spreading closer to field margins with a low risk of contaminating adjacent areas [508, TFRN 2014].

In addition, the time available for spreading is increased. As contamination with slurry is avoided in grassland, the required period between slurry application and grazing or silage harvest is reduced, extending the window of opportunity for slurry application. For arable crops, this extends the window for slurry application later into the spring when the crop height would normally exclude conventional surface broadcast slurry application because of crop damage and contamination risks [648, DEFRA 2011].

Finally, the possible working width of trailing hoses is much larger than for the splash plate reference system (6–9 m) [508, TFRN 2014]. An added advantage for trailing shoes is the ability to apply slurry to relatively tall grass (e.g. to be cut for silage) with considerably reduced contamination of the crop or herbage by the slurry.

Example plants

As broadcast spreading (splash plate) has been banned in Denmark for approximately 10 years, all slurry surface applications are done using trailing hoses. Hence the practical experience is extensive and the durability of the system is very well tested.

Reference literature

[35, Netherlands 2010] [223, Denmark 2010] [233, Denmark 2010] [234, Spain 2010] [235, Spain 2010] [248, ADAS 2001] [254, Webb J.M. et al. 2009] [379, Spain 2009] [338, Piñeiro et al. 2009] [440, Webb et al. 2010] [500, IRPP TWG 2011] [508, TFRN 2014] [575, UBA Germany 2011] [601, ALTERRA-IIASA 2012] [602, Denmark 2010] [648, DEFRA 2011]

4.13.4.4 Shallow injector (open slot)

Description

Tines or disc harrows are used to cut slots in the soil, forming grooves into which slurry is deposited. The injected slurry is fully or partially placed below the soil surface at a depth of 3–8 cm (typically 4–6 cm), with grooves normally left open after slurry application. Open slot injectors have a working width of ≤ 6 m to 12 m and individual hoses are generally situated at a spacing of around 20–30 cm from each other (see Figure 4.99).

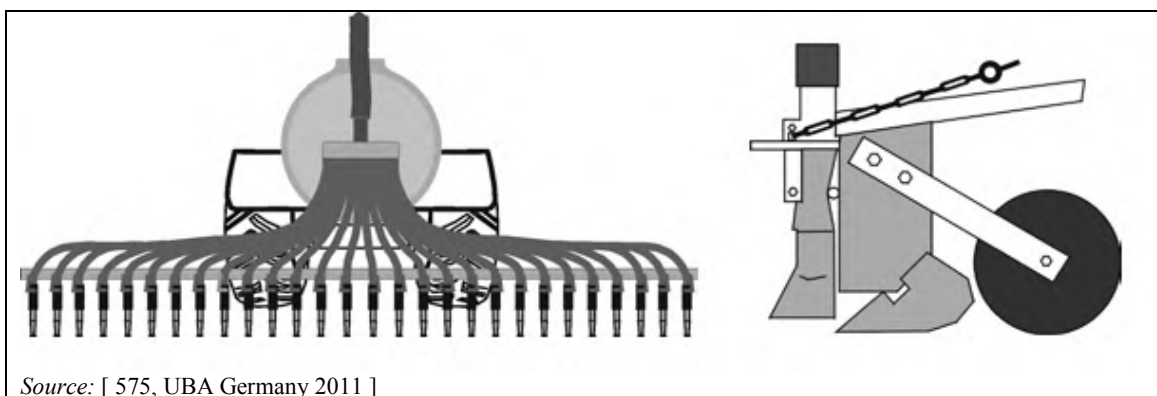

Source: [575, UBA Germany 2011]

Figure 4.99: Scheme of an open slot injector

The application rate is adjusted so that excessive amounts of slurry do not spill out of the open slots onto the surface.

Achieved environmental benefits

In open slot injection, only a limited part of the slurry is in contact with the open air, reducing the ammonia and odour emissions. The actual odour and ammonia emissions reduction depends on how large a proportion of the applied slurry can be accommodated in the grooves formed.

Experiments on grassland show that nitrogen utilisation is higher after shallow injection than after surface spreading [35, Netherlands 2010]. This means that the potential for nitrate leaching to the environment is decreased.

Slurry application with injection systems increases nitrogen utilisation, with a consequent reduced purchase of mineral fertilisers, thus reducing the energy consumption and associated indirect emissions for manufacturing the fertiliser [602, Denmark 2010].

Cross-media effects

Since the slurry is placed under the soil surface, N_2O emissions may be enhanced by the lack of oxygen, which facilitates denitrification. It has been reported that, in winter crops and for grassland, slurry injection increased the emissions of nitrous oxide by 25–100 %, which corresponds to an emission of approximately 0.5–1.0 % of the applied nitrogen [237, Denmark 2010] [238, Denmark 2010].

Slurry injection systems require greater tractor power (higher fuel consumption) than broadcast or band spreading equipment given that a tine or a disc is to be pulled through the soil. In comparison with a trailing hose system, the extra traction caused by injection with a narrow tine at a depth of approximately 10 cm is reported to be equivalent to 1.4–1.8 kW per tine (or per unit of injection aggregate) and it is estimated to be equivalent to 7.5 kW extra power per tonne of applied slurry. Generally, depending on the design of the injector tools, an extra force of 2–4 kW per metre of injector boom is needed.

Environmental performance and operational data

Most commercial systems available in Denmark are disc aggregates. The injection system is dependent on an adequate slurry trailer with sufficient strength and equipment for mounting the injection bar; it is expected to last 10 years.

Application by slot discs, through which the slurry is applied, avoids crop soiling; however, the turf is damaged. Other slot techniques aim to minimise this damage by means of a smaller slot depth [575, UBA Germany 2011] or minimum-till cropland prior to planting [601, ALTERRA-IIASA 2012].

Ammonia volatilisation after slurry application depends on various factors (e.g. high temperatures), among which the most important are the time elapsing until incorporation and the amount of manure that is left in contact with air. Therefore, the actual emissions reduction achieved depends on the extent to which slurry is incorporated into the soil, i.e. on how large a proportion of the applied slurry can be accommodated in the grooves formed. To be effective in both reducing ammonia emissions and increasing the availability of nitrogen to the crop, injection should reach a depth of ≥ 5 cm and the space between injector tines should be ≤ 30 cm. The effect of slurry injection depends on the soil type, soil dryness, and the technique used.

In France, the spreading of slurry using deep open slot injection (150 mm) allows a reduction of NH_3 volatilisation of 60 % [259, France 2010]. For shallow open slot injection in grassland or cropland, it is estimated that the odour reduction after slurry application is between 0 % and 50 %, compared with the trailing hose system [236, Denmark 2010] [387, Denmark 2010].

Ammonia emissions associated with slurry application with injectors and relative improvements compared to broadcast and band spreading (trailing hose) are presented in Table 4.207.

Table 4.207: Ammonia emissions reduction achieved by slurry injection in comparison with surface application techniques, in Denmark

Injection	Soil/Crop/Season	Emissions of $\text{NH}_3\text{-N}$ (% of total N)		Emissions reduction rates (%)		Source
		Trailing hoses	Injection	Compared with trailing hose	Compared with broadcast spreading ⁽¹⁾	
Open	Cropland with growing crops; spring	11.7	6.4	45	68	[603, Denmark 2009]
Open	Grassland; spring	13.5	10.1	25	56	[387, Denmark 2010]
Open	Grassland; summer	17.6	13.2	25	44	[387, Denmark 2010]
Closed	Bare soil (cropland without crops; ploughed land); spring	4	0.68	83	90	[604, Denmark 2009]

(¹) Data calculated on the basis of emissions of broadcast spreading technique a factor of 1.7 higher than compared to trailing hose, for Danish conditions.
Source: [442, Hansen et al. 2008]

Technical considerations relevant to applicability

The technique is applicable to many types of slurry, such as slurry from biogas production, mechanically separated slurry, acidified or untreated slurry. The technique is suitable for application on grassland and on growing crops. It is not applicable on stony soil or on shallow or compacted soils, where it is impossible to achieve a uniform penetration to the required working depth. The applicability may be limited where crops may be damaged by machinery. The method may not be applicable on very steeply sloping fields due to the risk of run-off along the injection slots.

Economics

Ammonia emission reduction costs and spreading costs reported by Germany for different farm sizes are presented in Table 4.203.

For the purchase of the injection equipment, an extra investment of EUR 33 000 is needed compared to the trailing hose. Operating costs are EUR 2.4–2.6 per tonne of slurry applied on growing winter crops and EUR 2.2–2.4 per tonne of slurry distributed on grassland. The additional costs compared to trailing hoses are presented in Table 4.207.

In a comparison with a broadcast spreader (splash plate) without incorporation within 24 hours after spreading, extra costs have been calculated under Spanish conditions (assuming at least a 50 % reduction in emissions), ranging between EUR 1.01 and EUR 1.41 per m³ of applied slurry, or, in other units, from EUR 12.6 to EUR 17.6 per tonne of pig produced [379, Spain 2009].

Table 4.208 reports additional fuel requirements, as well as extra costs associated with open (shallow) and closed (deep) slot injection, for different operating conditions applied in Denmark.

Table 4.208: Extra energy and costs associated with open (shallow) and closed (deep) slot injection for different operating conditions applied in Denmark

Injection type	Scope of application	Working depth	Extra fuel consumption		Extra annual operating costs ⁽¹⁾
		cm	Litres/ha	Litres/tonne of applied slurry ⁽²⁾	EUR/m ³ slurry applied annually
Open	Cropland with growing crops	3–8	2–5	0.1–0.2	0.9–1.1
Open	Grassland	3–8	2–5	0.1–0.2	0.7–1
Closed	Bare soil (cropland without crops; ploughed land)	10–15	4.9	0.2	0.66

⁽¹⁾ Costs are compared to the trailing hose system with a total cost of EUR 1.5/m³.
⁽²⁾ Slurry application at 25 tonnes per hectare.
Source: [236, Denmark 2010] [237, Denmark 2010] [238, Denmark 2010]

Driving force for implementation

The improved efficiency in nitrogen distribution results in improved ammonia utilisation by plants which ultimately results in economic savings from the reduced use of mineral fertilisation for the same quantity of crop.

Example plants

The technique with deep injection (150 mm) is largely applied in France [259, France 2010]. In Denmark, about 15 % of pig slurry and 53 % of cattle slurry were applied by injection in 2004. Injection of slurry to grassland and bare soil has been growing in Denmark; it is considered an available and proven technique.

Reference literature

[35, Netherlands 2010] [236, Denmark 2010] [237, Denmark 2010] [238, Denmark 2010] [259, France 2010] [379, Spain 2009] [387, Denmark 2010] [442, Hansen et al. 2008] [508, TFRN 2014] [575, UBA Germany 2011] [601, ALTERRA-IIASA 2012] [602, Denmark 2010] [603, Denmark 2009] [604, Denmark 2009]

4.13.4.5 Deep injector (closed slot)

Description

Cultivators with sharp S-shaped tines or disc harrows are used to cultivate the soil and deposit slurry into it, before soil closes the groove again, fully covering the slurry by means of press wheels or rollers fitted behind the injection tines or discs. Typically, the working depth of the closed slot deep injector ranges between 10 cm and 15 cm or, in some cases, deeper, up to 20 cm. The working width is generally 3–6 m, and the individual injectors are normally placed at intervals of 20–40 cm (see Figure 4.100).

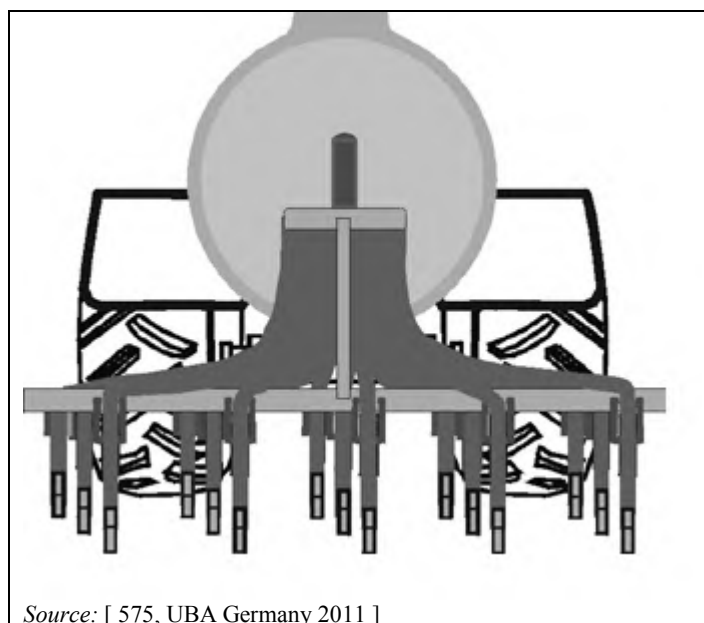

Figure 4.100: Scheme of a closed slot injector

Achieved environmental benefits

Since the exposed slurry surface area is eliminated by covering almost all slurry below the soil surface, odour and ammonia emissions are effectively reduced. Higher nitrogen utilisation may result in a decreased potential for nitrate leaching to the environment.

Cross-media effects

See Section 4.13.4.4. Deeper injection may not lead to higher N₂O emissions as the increased length of the diffusion path from the area of denitrification to the soil surface may lead to a greater proportion of denitrified nitrogen being emitted as N₂ [508, TFRN 2014].

Environmental performance and operational data

Most commercial systems available on the Danish market are tine aggregates. The system requires an adequate slurry trailer with sufficient strength and equipment for mounting the injection bar. The injection system is expected to last 10 years.

Compared with the surface distribution on bands (trailing hose), the reduction of ammonia emissions is about 85 %, which corresponds to an average reduction of around 90 %, compared to broadcast spreading [35, Netherlands 2010]. The effectiveness of ammonia abatement increases with working depth. An example of ammonia emission reduction for closed slot injection is reported in Table 4.207, in comparison with open slot injection. The ammonia volatilisation rate of the technique of deep injection on arable land is not influenced by weather conditions [232, Huijsmans et al. 2009]. For the deep injection of slurry into bare soil, odour emissions are reduced to a minimum, at least for a number of odoriferous substances [236, Denmark 2010].

An increased utilisation of the applied nitrogen (and therefore higher yields) has been proven with the use of the technique, resulting in a potential for decreased leaching of nitrates to the environment. The slurry is fully covered after injection, by closing the slots. Deeper injection is required when greater volumes of manure have to be injected, in order to avoid manure oozing/leaking to the surface [601, ALTERRA-IIASA 2012].

The working depth and ease of soil penetration increase with the soil's water content. Thus, an estimate of soil strength can be used as one parameter to determine the optimum timing for the slurry injection, in order to achieve sufficient working depths [440, Webb et al. 2010]. On the other hand, it has to be stressed that deep injection has to be performed within the capacity of

the soil to hold water to avoid drainage. In the UK, for example, soil moisture deficits should be no less than 20 mm for an application of 100 m³/ha [624, IRPP TWG 2013].

Technical considerations relevant to applicability

The technique is applicable to many types of slurry, such as slurry from biogas production, separated fractions and acidified or untreated slurry.

It is applicable on arable land without vegetation. It is not applicable during the vegetation of the crops. It is mainly restricted to the pre-sowing season and widely spaced row crops (e.g. maize). Mechanical damage (cutting of the roots during injection) may decrease yields in growing solid-seeded arable crops. Yield reductions may also derive from drying of the soil and anaerobic and toxic conditions from concentrating the manure in the injection slots. This effect may be greater with multiple applications over the season [440, Webb et al. 2010].

Other limitations include soil depth, soil wetness, clay and stone content, and slope. The soil type and conditions have to allow effective closure of the slot; otherwise, the added benefit of the full coverage of slurry is not attained [508, TFRN 2014]. Deep injection is limited to times when soils are dry enough; otherwise, there may be a high risk of run-through and leaching below the crop root zone [624, IRPP TWG 2013].

Considerable tractor power is required. An increased risk of leaching is reported in the case of tile-drained soils [601, ALTERRA-IIASA 2012]. Deep injection should be avoided until spring when the soil has dried out sufficiently. A lower application rate, in connection with the prevailing farm and soil conditions, can reduce the risk of nitrates loss [657, Bailey T. 2012]. Deep injection on grassland has been proven not to be practicable [35, Netherlands 2010]. The technique is applicable to grassland when changing to arable land or when reseeding.

Economics

For the purchase of the injecting equipment, an extra investment of EUR 33 000 is needed compared to the trailing hose. Systems would run for around EUR 2.2 per tonne of slurry applied on bare soil [236, Denmark 2010]. The additional costs of closed slot injection, in comparison with open slot injection, are presented in Table 4.207. Ammonia emission reduction costs and spreading costs reported by Germany for different farm sizes are presented in Table 4.203 [575, UBA Germany 2011].

Driving force for implementation

The driving force is increased utilisation of the applied nitrogen, with savings from the reduced use of mineral fertilisers.

Example plants

Injection of slurry to bare soil has been growing in Denmark and is considered a well-known, available and proven technology.

Reference literature

[35, Netherlands 2010] [232, Huijsmans et al. 2009] [236, Denmark 2010] [440, Webb et al. 2010] [508, TFRN 2014] [575, UBA Germany 2011] [601, ALTERRA-IIASA 2012] [624, IRPP TWG 2013] [657, Bailey T. 2012]

4.13.5 Incorporation of solid manure or slurry

Description

Incorporation of solid manure (or the solid fraction generated from the mechanical separation of slurry) or slurry (or the liquid fraction generated from the mechanical separation of slurry) spread on the soil surface, e.g. by trailing hoses, is carried out either by ploughing or other shallow cultivation equipment, such as tine or disc harrows depending on the soil type and conditions. The manure is completely mixed with the soil or buried underneath it as rapidly as possible after spreading on the surface.

Achieved environmental benefits

As ammonia losses take place quickly after spreading, ammonia emissions and odour are reduced by limiting the time of exposure of the manure to air.

The reduction of NH_3 volatilisation depends on the incorporation procedures, in particular the time lag between application and incorporation, as well as the weather conditions between application and incorporation, and the degree of burial in the soil [508, TFRN 2014]. High emission reductions can be achieved with immediate incorporation (as soon as possible after spreading); in contrast, a large part of the ammonia emission has already occurred when incorporation is carried out after 4, 6, 12 or 24 hours [35, Netherlands 2010].

Cross-media effects

Single-run equipment is heavy and can produce problems of soil compaction, while equipment for double-run incorporation is lighter but the tractor consumes more fuel.

Incorporation of solid manure into soil may increase direct emissions of N_2O . The nitrogen availability of solid manure for a growing crop is lower than that of liquid manure, due to the higher concentration of organic matter which enhances nitrogen immobilisation and denitrification. Whether solid manure leads to higher NH_3 and N_2O emissions than slurry or mineral fertilisers depends on several factors, including the manure C : N ratio and the organic matter degradability [517, Petersen et al. 2011]. On the other hand, the results of other studies remain ambiguous on the impact of incorporation of solid manure after application, with respect to N_2O emissions [441, Webb et al. 2012].

For untreated and treated slurry, contrasting results have been reported on N_2O emissions. The variability depends mainly on the soil properties and the organic matter content of the slurry [517, Petersen et al. 2011].

If no crops are present to take up the readily available nitrogen, manure incorporation increases the risk of nitrogen loss via leaching, with a possible shift of pollution from air to water, but it reduces the risk of surface run-off from subsequent rainfall events. For this reason, the timing of slurry and solid manure application needs to balance all these aspects [508, TFRN 2014].

Environmental performance and operational data

To achieve incorporation immediately after spreading, a second tractor is needed for the incorporation machinery, which must follow closely behind the manure spreader. Usually the incorporation is carried out by a second person working with the plough, or another tool, depending on the type and the conditions of the soil. However, it could also be done by one person, in which case the manure spread on the field (one tank load) is incorporated before reloading the tank.

Figure 4.101 shows incorporation equipment combined with a large tanker owned by a contractor, but this combination is also possible with a smaller tanker and a separate tractor. In this way, the incorporation can be done together with the manure spreading in only one handling [406, Netherlands 2002].



Source: [406, Netherlands 2002]

Figure 4.101: Incorporation equipment combined with a big tanker

For immediate incorporation on small fields (approximately 2 ha), if only one person is available to spread and incorporate the manure, there is a significant advantage in incorporating the manure as soon as each pass of the spreader is complete (except for very small fields). This causes an increase of 15 % in the time spent on the operation.

Using two people (simultaneous pass) does not reduce NH_3 emission, compared with one person operating both machines (spreading and then incorporating at the end of each pass), because the work rate of the incorporator is usually lower than that of the applicator. Using two operators does, however, save time, ranging from 36 % on a 2 ha field to 51 % on a 20 ha field. The absolute duration of the operation may be more important than the percentage of time saved. On a 2 ha field, a reduction in time spent from 3.5 h to just over 2 h may be of little importance in the overall farm management; however, on a 10 ha field, a reduction in time from approximately 20 h to 10 h would allow the job to be completed in 1 day [243, Webb J. et al 2006]. As a conclusion, the incorporation strategy needs to be properly designed, according to the size of the field, the work rates of incorporation equipment, and the available workforce.

Immediate incorporation, and thus a minimal time delay between manure application and incorporation, is not always achievable. Some time may pass between surface spreading and incorporation during which ammonia volatilisation takes place from the manure spread on the surface.

The degree of ammonia emissions reduction also depends on the method of incorporation. Direct incorporation of manure by a mouldboard plough results in a higher reduction efficiency than incorporation by a fixed tine cultivator or a disc harrow, due to the deeper working depth achieved by ploughing [35, Netherlands 2010] [243, Webb J. et al 2006] and the burial of 100 % of the slurry/manure. However, it is sometimes possible that tines or discs are more efficient than ploughing, because of the faster work rates achieved that let the slurry remain exposed on the surface for a shorter time before being well mixed with the soil by cultivation. Meanwhile, with mouldboard ploughing, there will be a longer overall time lag between spreading and incorporation [35, Netherlands 2010] [243, Webb J. et al 2006] [500, IRPP TWG, 2011].

A summary of experiment results concerning the ammonia emissions reduction achieved with the use of different types of application machinery is presented in Table 4.209.

Table 4.209: Summary of experiment results on ammonia emissions reduction with different manure incorporation equipment

Type of manure	Incorporation equipment	Reduction in NH ₃ emissions, compared with surface broadcast application	
		Average value ⁽¹⁾ (%)	Range ⁽²⁾ (%)
Slurry	Plough	92	78–99
	Disc	80	69–90
	Tine	66	NI
	Harrow	68	60–69
Solid	Plough	91	86–95
	Disc	63	NI
	Tine	57	NI
	Harrow	90	NI

⁽¹⁾ Data represent the average of the reported reduction efficiencies.
⁽²⁾ The range is obtained by calculating the average values of each publication considered.
 NB: NI = no information provided.
 Source: [440, Webb et al. 2010]

Other experiment results, presenting ammonia emissions expressed as kg/ha NH₃-N or as a percentage of the TAN applied, and the effect of different incorporation methods, are presented in Table 4.210. Ploughing results in greater emission reductions than other types of machinery for shallow cultivation.

Table 4.210: Average ammonia emissions and reduction efficiencies from the spreading of solid manures followed by immediate incorporation using different equipment

Manure type	No incorporation		Plough			Disc			Tine		
	NH ₃ -N	TAN	NH ₃ -N	TAN	Reduction	NH ₃ -N	TAN	Reduction	NH ₃ -N	TAN	Reduction
	kg/ha	%	kg/ha	%	%	kg/ha	%	%	kg/ha	%	%
Pig	63.1	68	3.2	4	95	25.4	26	60	26.2	26	58
Layer	71.5	67	2.6	3	96	22.3	21	69	33.7	31	53
Broiler	27.6	56	0.0	2	100	5.6	13	80	5.2	11	81

Source: [243, Webb J. et al 2006]

The effect of the machinery used for incorporation and the time delay after spreading solid manure until incorporation, in comparison with the ammonia emissions without incorporation, are presented in Table 4.211. Data are derived from a review of reports and peer-reviewed articles.

Table 4.211: Reduction of ammonia emissions achieved by the incorporation of solid manure after application

Animal category	Incorporation (time lag after application)			Equipment used for incorporation
	< 4 h	4 h	≥ 24 h	
	Ammonia emissions reduction as % of emissions measured without incorporation			
Fattening pigs	92 (4)	64 (9)	63 (8)	Plough
Broilers	NI	61 (5)	37 (5)	Disc
Broilers	NI	81 (2)	77 (2)	Plough
Broilers	NI	44–53 (3)	24 (2)	Disc - Harrow
Laying hens	97 (1)	NI	NI	Mouldboard plough
Laying hens	79–83 (3)	NI	NI	Harrow - Chisel plough - Rotary cultivator
	Average emission reduction as % of emissions measured without incorporation			
	< 4 h	4–24 h		
Pigs	92	56		
Poultry	85	50		

NB: The number of datasets used is indicated in brackets; NI = no information provided.
Source: [441, Webb et al. 2012]

From Denmark, calculated emissions for the application of solid pig manure followed by incorporation with different time lags and equipment are presented in Table 4.212.

Table 4.212: Calculated ammonia emissions from the application of solid pig manure followed by incorporation, with different equipment and time lags

Incorporation method	Season	Incorporation			
		No incorporation	6 hours	4 hours	1 hour
		NH ₃ -N emission as a % of TAN			
Ploughing	Spring	65	39	22	13
Ploughing	Summer	80	48	32	16
Ploughing	Autumn	55	33	12	11
Ploughing	Winter	45	27	7	9
Harrowing	Spring	65	41	36	27
Harrowing	Summer	80	54	48	35
Harrowing	Autumn	55	30	27	21
Harrowing	Winter	45	22	20	17

Source: [442, Hansen et al. 2008]

An extensive literature review [441, Webb et al. 2012], supported by a statistical analysis of measurement results, concluded that incorporation of solid pig and poultry manure after application results in increased N₂O emissions. However, a wide variability of data has been observed. Results are presented in Table 4.213.

Table 4.213: Emissions of N₂O after spreading and incorporation of solid manure

Parameter	Emissions of N ₂ O-N as % of TAN	
	Pig manure	Poultry manure
Average value after spreading	0.3	0.1
Median value after spreading	2.8	0.6
Average value after incorporation	3.5	8.9

Source: [441, Webb et al. 2012]

The influence of the contrasting effects of ammonia emissions reduction during manure storage, nitrogen loss during spreading and incorporation of broiler litter, and nitrate losses through leaching have been investigated; the results are presented in Table 4.214.

Table 4.214: Example of the effect of storage conditions and application conditions of broiler litter on subsequent emissions during application

Storage conditions	Application conditions	NH ₄ -N losses as % of total N ex-housing	NO ₃ -N losses as % of total N ex-housing
Conventionally stored	Surface spreading	24.6	5.9
Sheeted heap	Surface spreading and ploughing the soil within 4 hours	4	13.7

Source: [536, Sagoo et al. 2007]

Data from different geographical areas report that reductions in ammonia emissions of 70–80 % are achievable when solid manure is directly incorporated within 2 hours, and a reduction of 60–70 % if it is incorporated within 4 hours [35, Netherlands 2010] [259, France 2010]. The incorporation within 6–24 hours after application with a broadcast spreader reduces ammonia emissions by 16–42 %, under Spanish climatic conditions, compared to broadcast spreading without incorporation within 24 hours [239, Spain 2010]. In France, it is considered that, for a satisfactory ammonia reduction rate, incorporation has to be carried out less than 12 hours after spreading [500, IRPP TWG 2011].

Table 4.215 shows that the incorporation of broiler litter is always effective compared to non-burial, but also that emissions from landspreading depend on the readily available nitrogen that may be left in manure that has been covered during storage. The results in the table imply losses during storage of 13.2 % and 1.3 % for the conventionally uncovered stored manure and the sheet-covered manure, respectively [207, ADAS 2004]. This means that the readily available nitrogen that is not lost during storage may be largely lost at landspreading if incorporation is not quick enough or if it is not applied. In other words, rapid incorporation is necessary in order to realise the reductions in ammonia loss from sheeted storage. If the sheeted broiler litter is not rapidly incorporated into the soil following landspreading, the ammonia saved during storage is subsequently easily lost at landspreading.

Table 4.215: Comparison of ammonia losses from different procedures for landspreading of differently stored broiler litters

Type of application and incorporation	Losses upon spreading		System losses	
	Conventional	Sheeted	Conventional	Sheeted
Surface	11.4	25.8	24.6	27.1
Ploughed within 4 hours	2.4	2.8	15.6	4.1
Incorporation by discs within 4 hours	6.3	10.8	19.5	12.1
Ploughed within 24 hours	2.5	6.9	15.7	8.2
Incorporation by discs within 24 hours	8.0	21.9	21.2	23.2

Source: [207, ADAS 2004 Gleadthorpe]

Technical considerations relevant to applicability

The manure landspreading itself only takes a very short time (hours) and there is no organisational need to wait for the incorporation. Incorporation within 4 hours may be considered difficult to organise, because the farmers do not usually own all the machinery required and do not have enough personnel. The field size and the available machinery for incorporation might also affect the timely completion of manure incorporation, as the spreading

rate is usually higher than the ploughing rate. Furthermore, because field works often need to be completed on a task-by-task basis or a field-by-field basis, interruption of spreading (i.e. after 4 hours) in order for the operator to change task to ploughing, having to swap tractors or even attached implements, will cause a delay [624, IRPP TWG 2013]. The farmers therefore need to rely on contractors and therefore the timing of operations is not completely under their control. Additionally, weather conditions or poor light can stop working progress; for example, it would not be good practice to work on waterlogged land as it is harmful for soil management.

However, it is also reported that it is doubtful whether organising incorporation within a shorter time than 12 or 24 hours may cause a logistical problem [35, Netherlands 2010]. Where labour or machinery requirements limit the option for immediate incorporation, manure incorporation within 4 hours is reported to be feasible, even for small farms [508, TFRN 2014].

In the Netherlands, the technique of incorporating the manure within 4 hours is commonly applied. A good matching of logistics (tank spreading capacity and incorporation capacity) is a very important factor for achieving incorporation within 4 hours [406, Netherlands 2002].

The applicability of the technique is limited to arable land that can easily be cultivated after spreading solid manure or slurry. For grassland or conservation tillage, incorporation is not possible, or it is only possible when changing to arable land (e.g. in a rotation system) or when reseeding. It is not applicable to cultivated land with growing crops that can be damaged by the incorporation of solid manure or slurry. For slurry, the technique is not applicable after landspreading using shallow or deep injectors.

Economics

Extra costs reported by Spain for slurry incorporation after application by a splash plate (broadcast spreader) are presented in Table 4.216.

Table 4.216: Extra costs for the incorporation of slurry applied by a broadcast spreader with a splash plate, in comparison with no incorporation within 24 hours, in Spain

Method of incorporation	Ammonia emissions reduction (%)	Extra costs		
		EUR/m ³ slurry	EUR/tonne pig produced	EUR/kg NH ₃ abated
Mouldboard plough	16–40	0.53–0.61	6.6–7.6	3.2 ⁽¹⁾ –3.7 ⁽²⁾
Cultivator		0.23–0.26	2.9–3.3	NI
⁽¹⁾ Calculated value. NH ₃ reduction 30 %. ⁽²⁾ NH ₃ reduction 30 %. NB: NI = no information provided. Source: [338, Piñeiro et al. 2009] [379, Spain 2009]				

Costs for direct incorporation of solid manure are reported to be in the range of EUR 0.5 to EUR 2 per kg of NH₃-N saved [601, ALTERRA-IIASA 2012]. Ammonia emission reduction costs, spreading and incorporation costs, reported by Germany for different farm sizes, are presented in Table 4.203 [575, UBA Germany 2011].

Driving force for implementation

Regulations in many Member States are enforcing slurry/manure incorporation after spreading. For example, in Denmark, slurry applied on bare soil must be incorporated within 6 hours [236, Denmark 2010]. In Germany and the Netherlands, there is an obligation for immediate incorporation. In the UK, 24 hours is the maximum incorporation time interval after manure spreading [624, IRPP TWG 2013]. Fast incorporation of solid manure or slurry improves nitrogen availability (fertiliser value of manure) for crop production by preventing nitrogen losses [517, Petersen et al. 2011].

Some incorporation activities may be seen as a tillage operation that a farmer already planned to do (including when no manure was applied). In that case, incorporation is not an extra activity (labour, energy, costs) that should be counted as contributing to extra costs for the reduction of emissions [[35, Netherlands 2010](#)].

Example plants

Incorporation is widely applied.

Reference literature

[[35, Netherlands 2010](#)] [[207, ADAS 2004](#)] [[236, Denmark 2010](#)] [[239, Spain 2010](#)] [[243, Webb J. et al 2006](#)] [[259, France 2010](#)] [[338, Piñeiro et al. 2009](#)] [[379, Spain 2009](#)] [[406, Netherlands 2002](#)] [[440, Webb et al. 2010](#)] [[442, Hansen et al. 2008](#)] [[441, Webb et al. 2012](#)] [[500, IRPP TWG 2011](#)] [[536, Sagoo et al. 2007](#)] [[508, TFRN 2014](#)] [[517, Petersen et al. 2011](#)] [[575, UBA Germany 2011](#)] [[601, ALTERRA-IIASA 2012](#)] [[624, IRPP TWG 2013](#)]

4.14 Techniques to reduce noise emissions

Description

Noise is still not considered an issue of great environmental importance in the sector, but, with rural areas becoming increasingly populated, noise (as well as odour) emissions may become more relevant. In general, measures to prevent or reduce noise emissions are necessary when the farm is located close to an area that requires protection (e.g. residential area) and a noise problem occurs. At the same time, reduced on-farm noise levels are considered to be beneficial for animal production itself as it requires a quiet and peaceful environment.

In the case of new farms, a basic preventive measure is to select a location for the farm and/or the equipment with sufficient distance to existing or planned sensitive receptors, e.g. residential areas. In general, noise reduction can be achieved by:

- planning of activities on the farm premises;
- using natural barriers;
- applying low-noise equipment;
- applying technical measures to equipment (limited);
- applying additional noise abatement measures.

For ventilation systems, preference should be given, wherever possible, to high-efficiency fans. Noise radiation increases with impeller diameter and speed. For a given diameter, a low-speed fan is quieter than a high-speed fan.

In order to reduce noise emissions from machinery and implements, it is possible in certain cases to adopt passive noise abatement measures (encapsulation or sound screens, e.g. made from straw bales which absorb and deflect the radiated sound). Silencers/sound attenuation devices in waste airshafts have not proven successful, as they quickly become ineffective due to dust deposits. Potential techniques to control or reduce noise emissions from a number of on-farm activities are described below.

Achieved environmental benefits

Noise emissions are reduced.

Cross-media effects

Side-mounted fans are less effective in dispersing ammonia, odour and dust emissions than roof-mounted fans. Increasing the number of fans combined with a reduction of their size would increase the energy consumption and may compromise animal welfare [624, IRPP TWG 2013].

Environmental performance and operational data

Noise management plan

The first step to deal with noise emissions, when are identified as having a potential impact, is to produce a noise management plan, i.e. a noise prevention and reduction programme. It is designed to identify the source(s), to measure noise emissions, to measure/estimate noise exposure, to characterise the contributions of the sources and to implement elimination and/or reduction measures, according to their cost and ease of implementation [624, IRPP TWG 2013].

A noise management plan includes the following elements:

- a protocol containing appropriate actions and timelines;
- a protocol for conducting noise monitoring;
- a protocol for response to identified noise events;
- a noise reduction programme designed, for example, to identify the source(s), to monitor noise emissions, to characterise the contributions of the sources and to implement elimination and/or reduction measures;
- a review of historical noise incidents and remedies and the dissemination of noise incident knowledge.

Management measures

The impact of activities with potentially high noise levels can be reduced considerably by avoiding operating at nights and on weekends. Unnecessary disturbance of the animals during feeding and inter-house transfer should also be avoided, as this generally gives rise to increased noise levels. However, it is less stressful for birds to be handled in the dark and this is why bird catching and subsequent transport often take place at night or in the early morning [[40, NFU/NPA 2001](#)].

The noise of the highest intensity in pig farms is created during the blood testing of pigs and nose-ringing of sows (when it is permitted in accordance with Directive 2008/120/EC and national legislation) [[624, IRPP TWG 2013](#)].

Other operational measures include provisions for noise control during maintenance activities.

Prevention of continuous noise

i. Choice of ventilation system or equipment

One method of eliminating noise from fans is to employ natural ventilation systems, including ACNV, which also have energy-saving benefits. Fans can be selected to minimise noise. High-speed fans with two pole motors should be avoided because they tend to be very noisy. In addition, the smaller dimensions of these fans are also associated with smaller openings and cowls that have a higher resistance to airflow. Generally, the slower the fan, the less noise it will make. Particularly for poultry, cowls and air inlets can be designed with a sufficient area so as to avoid any unnecessary pressure drops.

In certain circumstances, fan noise can be reduced by inlet silencers. The nature of the exhaust air from livestock units makes this option suitable only for fan-pressurised ventilation systems, which are not commonly applied.

ii. Design of ventilation and building construction

The location of the fans is a significant factor. Employing low-level extraction fans on side walls will be more effective for reducing the propagation of noise from within buildings than roof-mounted units, as the noise can be better absorbed by the building structure or by the earth or vegetation. For poultry farms, low-level fans can also facilitate dust control, but they may be less effective at dispersing odour than high-level fans. In other cases, roof fans when operated properly generate similar noise levels as those installed on the sides of the walls [[624, IRPP TWG 2013](#)].

System resistance affects the fan and ventilation system performance. Fan installations should be designed with adequate inlet and outlet areas to ensure an optimum performance. An efficient design enables the minimum number of fans to be employed in ventilating the buildings. Fan outlet cowls and stacks should be rigidly constructed of timber or purpose-built prefabricated plastic or GRP. The use of unstiffened sheet metal, which can vibrate, should be avoided.

The characteristics of a building's structure affect the noise pattern. The build-up of noise in and around a building is determined by its absorption properties. Smooth reflective surfaces cause noise levels to build by multiple reflection. By contrast, rough surfaces, such as straw bales, absorb sound.

The application of high-efficiency fans, design measures to reduce airflow resistance, and operational measures (intermittent operation) can all reduce energy consumption. However, low-level wall-mounted fans are considered to be less efficient than roof-mounted fans so additional fan capacity would be required. In addition, it was reported that low-level wall-mounted fans create more odour around the unit than roof-mounted fans.

iii. Operational measures

For the minimum required ventilation of poultry housing, a small number of fans operating continuously is less noticeable than a large number of fans operating intermittently to achieve the same ventilation rate. An increase of 3 dB(A) as a result of twice as many fans running will be highly significant with night-time background noise levels below 30 dB.

Control of noise from discontinuous on-farm activities

Many on-farm activities are carried out in a discontinuous way. Measures to reduce noise emissions from these activities generally relate to proper timing and careful location of the activity on the farm. The measures apply to the following activities:

i. Feed preparation

On-farm milling and mixing of feed produce noise levels of 63 dB(A). Mills are often automated so that they can be used during the night to reduce operating costs by using lower cost 'off-peak' night rate electricity. If complaints are likely then this option should be reconsidered. Mills and other noisy equipment should be housed within an acoustically insulated enclosure or building. Mills which use mechanical rather than pneumatic meal transfer systems are likely to be both quieter and substantially more energy-efficient. The main noise-generating units, such as hammer mills and pneumatic conveyors, should be operated at times when background noise is known to be highest.

ii. Feed-conveying equipment

Noise from pneumatic conveyors can be reduced by minimising the length of the delivery pipe. Low-capacity systems, which operate for longer, are likely to generate less overall noise than large, high-output units. Conveyors, including augers, are quietest when full of material. Conveyors or augers should not run empty.

iii. Feed delivery

Many units do not prepare feed on farm. Feed delivered to a plant is usually pneumatically conveyed into holding bins. Noise from feed delivery vehicles comes from:

- vehicles moving around the farm;
- pneumatic conveying equipment.

The impact of these sources of noise can be minimised by:

- locating feed bins or feed storage silos as far away as practical from residential and other sensitive properties;
- organising feed bin locations to reduce delivery vehicle movements on farm;
- avoiding long conveyor distances, and minimising the number of bends on fixed pipes, so that the maximum unloading rates can be achieved (to minimise noise duration).

iv. Feeding operations in pig units

Noise levels of 97 dB(A) and higher have been measured from excited stock in anticipation of feeding. This excitement is often associated with manual feeding or noisy conveyor systems delivering feed at feeding time. These peaks of animal noise can be reduced by the use of appropriate mechanical feeding systems. If stocks are to be hand-fed then they should be in small batches (separate from other batches) or, if noise is inevitable, stock should be fed at times of higher background noise levels. Feeders can be used that have holding hoppers, which can be filled before feeding time so the pigs have no pre-feeding stimulus to create excitement and noise. Passive *ad libitum* feeders can be used for some classes of stock and they greatly reduce stress and minimise noise. For new feeding equipment installations, this should be considered the preferred option. Compact feeders are also reported as fit for the purpose [624, IRPP TWG 2013].

v. Building openings

Whenever possible, all doors and other major openings of the pig buildings should be closed during feeding time.

vi. Fuel delivery

Fuel storage tanks should be located as far away as possible from other property such as residential housing as far as this is convenient and practical. Locating fuel storage tanks in a position where the livestock buildings lie between the gas/oil storage and other property can reduce sound propagation.

vii. Manure and slurry handling on pig farms

Measures to reduce noise produced when pig manure is handled are listed below:

- Design and maintain opening gates along scraped passages in manure systems with scrapers so that the pigs are unable to rattle gates and their fittings.
- Keep to a minimum scraped areas outdoors to reduce noise from scraper tractors.
- Locate slurry and manure storage areas away from nearby dwellings. Pressure washers and compressors generate considerable noise and should normally be used inside buildings. Their use outside, e.g. to clean vehicles, should be avoided on sensitive sites. Wherever possible, machinery should be washed under cover and in locations away from residential housing and other sensitive properties.

viii. Manure and slurry handling on poultry farms

Measures to reduce noise produced when poultry manure is handled are listed below:

- When cleaning out poultry buildings, the movement and manoeuvring of loaders filling trailers outside the building is organised to minimise the amount of machinery movement. If there is sufficient headroom, trailers are loaded inside the building.
- Well-maintained exhaust systems and silencers of loaders and tractors.
- Teaching and training staff in the operation of loaders.
- Performing of manure and product handling at the ends of buildings furthest away from other property such as residential housing.
- In some egg production units, manure is conveyed directly to a separate storage building. This enables trailers to be loaded mainly within the building.

- Conveyors used for manure handling are a source of noise. They are located within the building structure as much as possible. Where they pass between buildings, the length of run is as short as possible and the provision of sound-absorbing barriers such as straw bales or more permanent panelling should be considered. Conveyors are not allowed to run empty. Use pressure washers and compressors inside buildings. Their use outside, to clean vehicles, is avoided on sensitive sites. Wherever possible, machinery is washed under cover and in locations away from residential housing and other sensitive properties.

ix. Application of noise barriers

Noise propagation can be reduced by inserting obstacles between emitters and receivers. Appropriate obstacles may include protection walls, embankments and fences. Barriers are most effective against high-frequency noise. Long-wavelength, low-frequency noise will pass around or over the barriers.

Earth banks can be used to combine the effect of barriers with the absorption of vegetation, and can be useful when constructed along the boundaries of pig units. Straw bales can be used to provide a tall, effective, temporary noise barrier because of their thickness and mass, and because of their absorbent surfaces. Straw bales should not be used in or near pig buildings where they may increase the risks of fire. Tall, solid, wooden fences reduce noise propagation. These can be sited on top of earth banks to increase the overall height of the obstacle.

Woodland and hedges limit the diffusion of noise from pig farm buildings. A deep belt of tree planting will both reduce noise and mask noise generated by the wind. Noise reduction is relatively low at about 2 dB for 30 m of plantation. Hedges also reduce the diffusion of odours and facilitate the integration of farms in the landscape.

Indicative effects of some applied measures are given in Table 4.217.

Table 4.217: Reducing effect of different noise measures

Category	Reduction measure	Reduction effect (dB(A))
Technical	Natural ventilation	Variable
	High-efficiency fans	NI
	Application of silencers	NI
Design and construction	Low-level side walls	NI
	Hedge/vegetation barrier	2
Operational	Small number of fans/continuous operation	3
NB: NI = no information provided.		

Technical considerations relevant to applicability

The implementation of a noise management plan is only applicable to cases where an odour nuisance at sensitive receptors is expected and/or has been substantiated. The choice of fans (and their diameter) is primarily based on the needs of the animals. In addition, the implementation of multiple fans and the relocation of farm equipment (e.g. feed bins) in existing houses is reported to be difficult and costly. *Ad libitum* feeders are not applicable when some animals require restricted feeding for health and productivity reasons, e.g. sows and gilts.

The noise-absorbent materials to be used have to be able to be cleaned easily, without having a negative effect on the hygiene of the herd [624, IRPP TWG 2013]. In the case of new farms, many of the siting measures can be applied as part of the farm planning. In that case, use should be made of any natural contours. For existing systems, the relocation of activities or equipment may be technically possible for only some activities due to restrictions in space or excessive

costs, but relocation of large constructions, such as animal housing, may be constrained as it requires relatively high investments.

Measures related to the operator's practice and timing can be applied at any time, for both new and existing farms. Vegetation obstacles, such as hedges, may not be generally applicable due to biosecurity reasons.

Economics

No information provided.

Driving force for implementation

New pig and poultry developments should take account at the design stage of the noise control benefits of low-level and side-mounted fans and of acoustic barriers. The applicability of natural ventilation systems should also be considered.

Example plants

In the UK, a noise management plan is required for permit holders where noise has been identified as an emission with a potential impact [624, IRPP TWG 2013].

Reference literature

[40, NFU/NPA 2001] [43, COM 2003] [393, ADAS 1999] [559, ADAS 1999] [624, IRPP TWG 2013]

4.15 Techniques for the treatment and disposal of residues other than manure and dead animals

4.15.1 Solid residues

Description

Solid residues to be handled on a farm and common treatment practices are listed in Section 2.11.

There are various ways to dispose of solid residues. The burning or landfilling of residues in the field is forbidden. For solid wastes to be incinerated, the incineration plant must hold a permit from the competent authority in accordance with the Industrial Emissions Directive (2010/75/EU), Chapter IV and Annex VI, where technical provisions relating to waste incineration plants and waste co-incineration plants are given. Measures to prevent or to reduce as far as possible negative effects on the environment (air, soil and water) caused by the incineration of waste are described in the WI BREF [705, COM 2017]. Waste incineration or co-incineration plants may be equipped with heat recovery systems.

Achieved environmental benefits

Achievable benefits are all related to the type of material and potential for saving energy.

Cross-media effects

None reported.

Environmental performance and operational data

The duty of care relates to everyone who handles waste, from the person producing the waste to the person who finally disposes of or recovers it. Waste must be kept secure so it does not leak, spill or blow away and can only be given to an authorised person (e.g. a registered waste carrier) and be transferred with the release of signed transfer notes [386, DEFRA 2009].

Treatment of solid residues

The treatment should follow the waste hierarchy framework (reduction, reuse, recovery, disposal) and apply principles of proximity (treatment of waste as close as possible) and of precaution (immediate application of cost-effective measures to prevent environmental degradation). Within this framework, the following on-farm options can be applied:

- reuse of residues;
- composting of residues;
- energy recovery.

Reuse focuses on reusable or refillable packaging. Possibilities for the on-farm composting of residues other than manure appear very limited, with secondary cardboard packaging having the most opportunities. Energy recovery includes the already applied oil burners, but other materials may be applied with the new developing energy recovery technologies. Techniques typically applied on intensive poultry and pig farms have not been reported.

Treatment of hazardous waste

Examples of farm wastes that are classified as hazardous include waste oil, asbestos, lead acid batteries and agro-chemicals containing dangerous substances. Hazardous wastes must not be mixed with them or with non-hazardous waste or other substances and materials. Hazardous wastes must be collected and disposed of separately, complying with local rules and must be transferred accompanied by 'consignment notes' [386, DEFRA 2009].

Technical considerations relevant to applicability

No technical restrictions are reported for the implementation of the techniques.

Economics

Some costs are associated with the treatment techniques applied. In particular, incineration and landfill of residues will have to observe increasing legislative requirements that will raise the costs of applying and operating these techniques.

Costs for other forms of disposal or recovery include:

- collection and transport costs;
- disposal and recovery costs;
- landfill tax (if disposed of by landfill).

Costs to the farmer will depend on a number of factors, including:

- farm location and distance to suitable facilities;
- quantity of the residues;
- nature and classification of the residues;
- final treatment method;
- market demand for secondary materials.

Driving force for implementation

It is expected that agricultural residues will increasingly be considered as industrial waste. Requirements laid down in various directives concerning waste, such as the EU Landfill Directive (1999/31/EC), the Industrial Emissions Directive (2010/75/EU), Chapter IV and Annex VI on waste incineration, and the Waste Framework Directive (2008/98/EC), are major forces to change the treatment of agricultural residues.

Other forces that drive the change in the treatment of residues are considered to be the demands from retailers and consumers, growing public concern about the environmental and human health impacts of products, increasing costs for disposal, and developing EU directives applying the ‘polluter pays’ principle.

Example plants

The measures described are commonly applied.

Reference literature

[43, COM 2003] [403, EA 2001] [386, DEFRA 2009]

4.15.2 Generation, segregation and treatment of liquid residues**4.15.2.1 Segregation, collection and prevention of waste water generation****Description**

Waste water originating from livestock facilities, also called dirty water, is comprised of the following:

- Wash-down water from livestock farming facilities. Cleaning water can contain residues of dung and urine, litter and feedstuffs, as well as cleaning agents and disinfectants.
- Rejected water from air cleaning systems.
- Contaminated rainwater run-off commonly interfering with manure. The quantity depends very much on the amount of rainfall and it can contain some or all of the following in various amounts ranging from gross contamination to traces: faecal matter, feed, bedding, feathers, veterinary medicines, etc.

It is in the best interest of the operator to effectively separate relatively dirty and uncontaminated run-off. The contamination of rainwater can be prevented by segregating it from waste water streams that require treatment. Poorly designed or badly maintained drains and gutters can allow clean rainwater from non-fouled yards and roofs, or that flowing from higher grounds to the farmyard, to mix with dirty water and therefore increase the waste water volume.

It is also good practice to keep yards, concrete surfaces and roofs as clean as possible, so that any rainfall coming into contact with these surfaces can be treated as 'lightly contaminated' or uncontaminated, depending on the local water protection regulations. Keeping the fouled yard area as small as possible minimises the volume of water required to wash it down and hence the volume of dirty water produced. Roofing such yards and covering storage heaps of solid manure would avoid additional inputs from rainwater.

Avoiding the excessive use of water in washing down fouled yards, buildings, etc. is another way to minimise the volume of waste water generated. The mixing of waste water with slurry followed by further treatment and/or landspreading is common practice. The techniques for the processing and landspreading of slurry are described in Sections 4.12 and 4.13.

When waste water is not drained to the slurry store, it is collected and settled in tanks or lagoons. The solid fraction can be landspread. Subsequently, the liquid fraction has to be treated in accordance with the local regulations resulting from the Water Framework Directive (2000/60/EC) and in relation to the level of contamination (see Section 4.15.2.2). Waste water may also be landspread, preceded by a sedimentation treatment, with a low-rate irrigation system (see Section 4.15.2.3).

Uncontaminated precipitation water from roofs and roadways can, as a rule, be allowed to soak away locally or be discharged into drainage ditches or main outfalls. Any possibilities for reuse (such as cleaning or storing in reservoirs for firefighting) involving collection and separate storage could be considered if they do not pose a biosecurity risk.

Precipitation water from uncovered exercise yards, outdoor feeding areas, and dung slabs should be collected and treated. When dimensioning the storage capacity for liquid manure and dung water, the volume of precipitation water to be taken into account has to match the average precipitation volumes and the size of the areas involved, less any evaporative loss.

Achieved environmental benefits

The interception and treatment of waste water before it enters any watercourse or is landspread prevents water pollution.

Cross-media effects

Storing of separately collected uncontaminated rainwater over a longer period may be problematic due to biological activity in the stored water and malodour. It may also involve risks to the health of livestock and farm staff.

Technical considerations relevant to applicability

The construction of a proper, separate collection or drainage system for the segregation of uncontaminated water may not be applicable to existing farms due to high costs. The reuse of uncontaminated rainwater for cleaning is applicable to new farms and as part of major upgrades. In some areas it is unnecessary to collect such water, and volumes collected may exceed the requirement. Collected water may also have to be stored inside heated buildings during winter. Collection of rainwater for cleaning within animal housing is not advised due to biosecurity risks. Only in the case of an adequate pretreatment can the risk of contamination be completely excluded.

Economics

The total annual costs (amortised over 20 years) for additional roofing over dirty concrete areas and the diversion of clean water are reported as EUR 1 820 for a pig farm and EUR 2 500 for a poultry farm (EUR 45/m² of roof and EUR 1 = GBP 0.88) [648, DEFRA 2011].

Driving force for implementation

Separate handling of dirty water from slurry offers more flexibility in slurry management, i.e. less storage volume is required, and less needs to be spread by slurry application techniques. Preventing unnecessary inputs of rainwater will be most beneficial in high rainfall areas.

Example plants

The measures described are commonly applied. A survey has identified a few management systems to collect rainwater for reuse for cleaning [264, Loyon et al. 2010].

Reference literature

[264, Loyon et al. 2010] [403, EA 2001] [500, IRPP TWG 2011] [624, IRPP TWG 2013] [648, DEFRA 2011]

4.15.2.2 Treatment of waste water**Description**

For the treatment of waste water, relevant information on the applied techniques can be found in Section 3.3 of the CWW BREF [507, COM 2016].

The pollutant loads of waste water resulting from livestock f can vary considerably. The level of contamination will rank run-off from clean rainwater as it depends on the local regulations. Authorisation permits may require operators to appropriately handle and treat contaminated run-off water (e.g. see [524, UK EA 2012]).

The treatment of lightly contaminated waters can reduce the contaminant load or potency, by allowing pathogens to die off before they reach the natural surface or groundwater, by trapping sediments containing nutrients and heavy metals, and by plant uptake of some of nutrients, thereby keeping them out of the natural ecosystem. Treatment methods that mimic some of the properties of natural wetland systems are simple and effective.

The process chain for treating lightly contaminated run-off water from a pig or poultry unit comprises collection, treatment and final discharge. Either one or a combination of the methods described below can be tailored to meet the specific requirements associated with run-off types, loading, farm characteristics (slope gradient, expected rainfall volume, soil infiltration rate and space availability), and discharge standards.

Swales are shallow grass-lined channels designed to collect run-off and move it gradually away downslope. They encourage infiltration along their route as the grass can filter off suspended sediments, as well as take up nutrients. Commonly, check dams are built along the swale length to increase the storage capacity and to slow the water flow.

Ponds are intended to allow suspended solids to settle out from run-off and/or to be used as buffers for storm events by providing temporary storage and to allow biological treatment. Ponds can help remove excessive sediment but do not offer the full treatment potential of a constructed wetland, so they are often used as a pretreatment in constructed wetlands. They can also be used after a swale or another water collection system.

Constructed wetlands are a constructed, semi-natural area of land typically comprising beds of specialised plant such as reeds (*Phragmites spp*) and gravel-filled channels. They mimic natural systems of ponds and marsh zones, where degrading depths appear in a sequence, giving room for a variety of habitats and vegetation types. They have potential for the treatment of dilute

farm effluents (e.g. removal of BOD and plant nutrients, sediment entrapment). A constructed wetland can provide excellent treatment potential but requires dedicated space.

Soakaways are used where soils are sufficiently permeable and the water table is low enough. Treated waters must have very low contaminant levels, since soakaways permit the seepage of run-off through the surrounding soil above the water table. The soil provides the medium in which bacterial treatment takes place, and cleaned water eventually reaches the water table.

One method for separating highly contaminated from lightly contaminated fractions of run-off water before further treatment is by means of a dedicated first flush system (e.g. when leakages can occur from silage stores). The first, highly concentrated, fraction of run-off water can be characterised by high organic pollutant loads (e.g. COD, BOD and suspended solids) and usually by small volumes. Besides this fraction, a bigger volume of lightly contaminated silage run-off water can occur. The two fractions can be physically separated (using a combination of gravity, flow rate and inflow rate) by a dedicated first flush system.

First flush systems consist of a brickwork pit, with a thin partition in the middle. The run-off water enters the system through an intake system with a bypass. The highly contaminated fraction settles quickly, under gravity, in the first compartment, in combination with a limited flow and a low inflow rate (see Figure 4.102). From there, this fraction is transported to a separate storage facility. The lightly contaminated fraction settles, under gravity, in the second compartment (goes further before settling down) in combination with a higher flow and a higher inflow rate. This fraction is removed by a second outlet from the second compartment to a biological treatment, such as one of those described before. There is no movement of fractions between the two compartments.

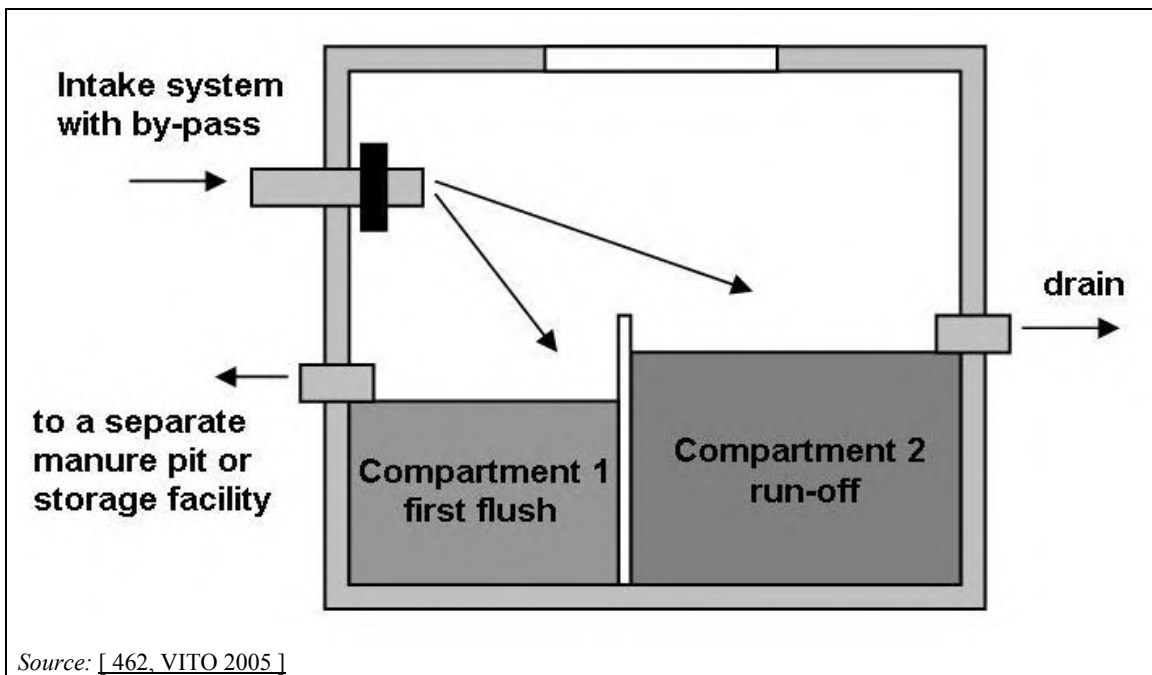

Figure 4.102:Scheme of a first flush system

Achieved environmental benefits

These systems are effective at improving water quality by combining biological and physical treatment, trapping sediments containing nutrients and heavy metals, and allowing for controlled plant uptake of some of the nutrients. In this way, nutrients are not released into the soil, groundwater, and/or surface water through leaching. Moreover, treatment of contaminated rainwater run-off can reduce the contaminant load or potency by allowing pathogens to die off before they reach natural surface water or groundwater.

Cross-media effects

Ponds need to be desludged from time to time. A constructed wetland can provide effluent that is suitable for use in crop and pastureland irrigation.

Environmental performance and operational data

A long swale (70 m or more in length) gives time for the entrapment or settlement of suspended solids. Optimal parameters are a 5° gradient, only gentle curves and not too steep sides (ratio 1:3). An established grass sward is beneficial to avoid standing water.

The volume of the swale is calculated by multiplying the area to be drained by 12. This latter parameter represents the treatment volume and is the amount of rain (i.e. 12 mm) that generally lifts any light contamination from the surface, so that further rain after that is likely to run clean. An increasing number of check dams are needed on the path for increasing slopes (one dam every 25 m for 2° of slope, 10 dams for 5° of slope). An example is given in Figure 4.103.

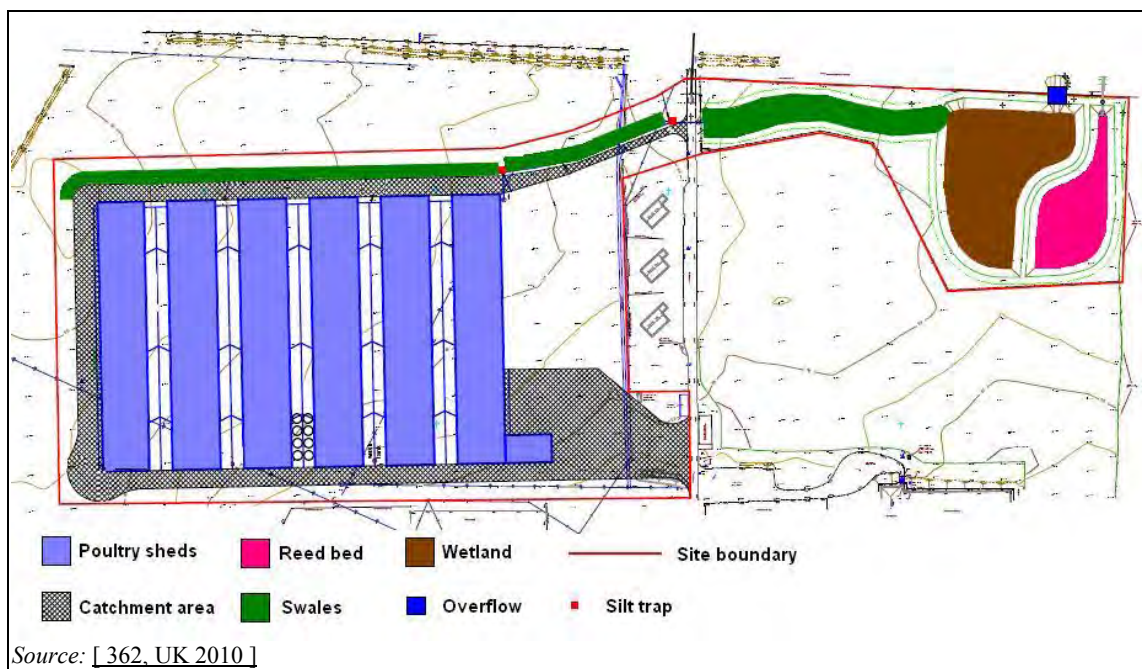

Figure 4.103: Location of a system of swales and wetland for a poultry farm

Ponds are relatively deep water bodies with shallow margins. Vegetation at the edges helps with sediment capture, habitat creation, and safety. Sediments (e.g. heavy metals) settle at the bottom.

Constructed wetlands are intentionally flooded areas designed to simulate natural wetlands, with a combination of deep and shallow water. They can have a deeper channel winding from inlet to outlet, or a wetland that gradually gets deeper, with the shallow water areas planted with aquatic and/or emergent vegetation (reedbeds). The deep pond always appears first and at the outlet marsh zone waters can be as shallow as 10 cm.

There are two basic designs of constructed reed beds: vertical flow and horizontal flow, though both types can be combined. Vertical flow reed beds are designed to add oxygen to the effluent and remove any pollutants by allowing water to flow down through the reeds and gravel before being discharged. Any particles become attached to the gravel and plants as the water percolates down, which forms a slime. The slime then helps break down remaining pollutants as it contains microorganisms, which are supplied oxygen by the reeds. The microorganisms also help reduce NH_3 levels. Horizontal flow reedbeds are designed to allow water to flow laterally through gravel and reeds and out the other side via overflow. This flooding effect creates an anaerobic

environment, enabling microorganisms to convert nitrates into nitrogen gas. The thriving and very active population of microorganisms in this environment can help reduce pathogen levels [203, ADAS 2005].

A nitrogen removal efficiency of 20–60 % is reported, which can reach 90 % with floating aquatic macrophytes. Denitrification is the most important nitrogen removal pathway while adsorption on solids is the main mechanism for phosphorus removal [594, Agro Business Park 2011].

A study was conducted in Lorca (Murcia, Spain) by GARSA (Sustainable Use, Management and Reclamation of Soil and Water Research Unit) from the Universidad Politécnica de Cartagena over 5 years where pig slurry was treated using a purification system based on constructed wetlands, according to Figure 4.104. The purification system tested in this study achieved noticeable decreases in pollutants from pig slurry: 89 % for TSS, 90 % for BOD₅, 91 % for COD, 97 % for total phosphorus, 96 % for Cu, 92 % for Zn, 89 % for total nitrogen, 87 % for NH₄⁺-N, and 100 % for *Salmonella*, *Shigella*, and *E. coli* [672, Faz A. 2015].

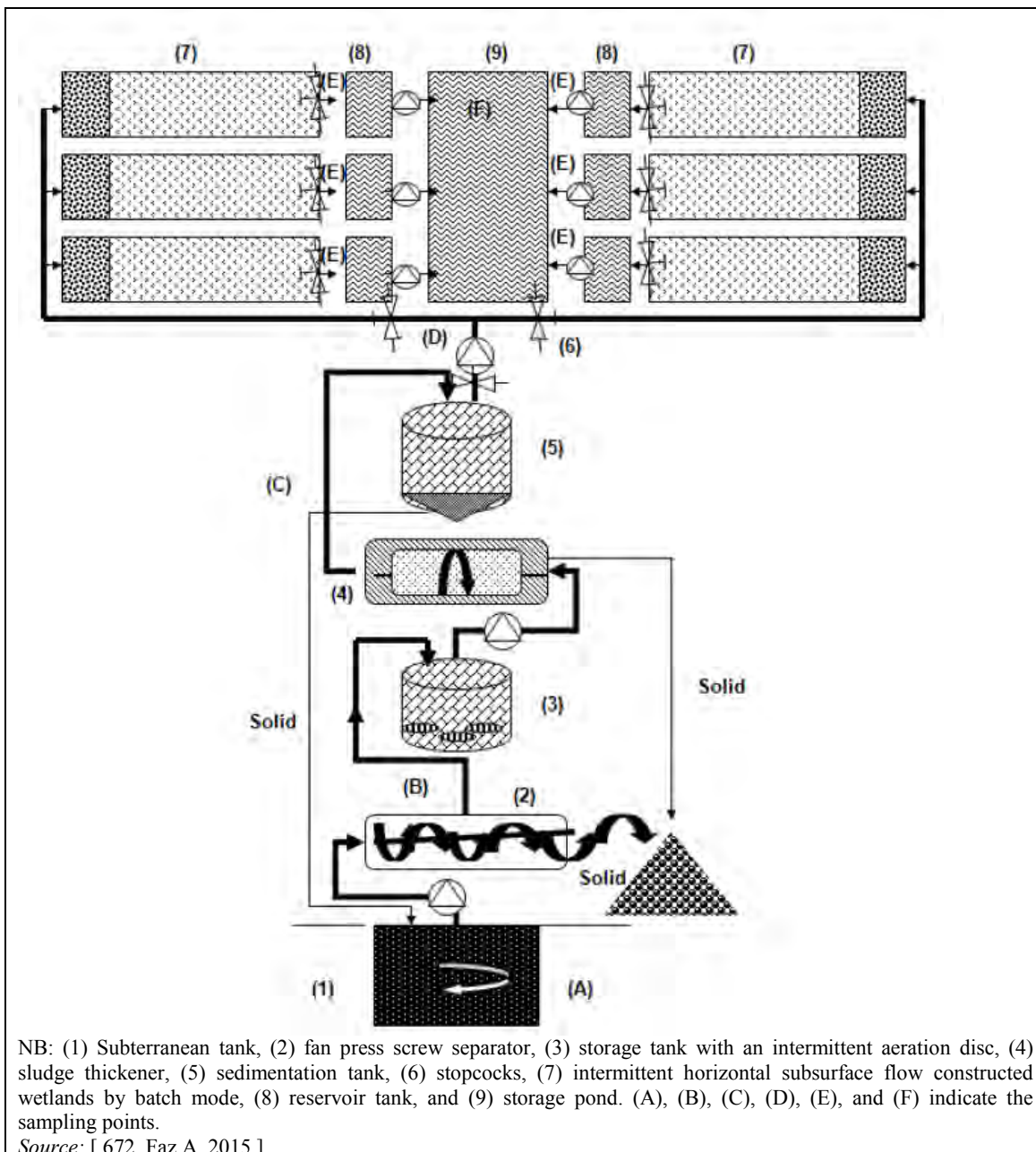

Figure 4.104: Layout of a system for purifying slurry based on constructed wetlands

Constructed wetlands for free-range poultry units should be shallow with no open water to attract wild birds, therefore reducing risks from avian influenza. An appropriate design might be a small four-cell constructed wetland fully planted with reeds. Soakaways only need to be dimensioned on maximum flows, at the lower level of the system and with the highest infiltration rate. The choice of system should be based on a number of variables including slope gradient, expected rainfall volume, soil infiltration rate and space availability.

Technical considerations relevant to applicability

No technical restrictions are reported for the implementation of the technique. The treatment options for waste water depends on farm-specific factors. Biosecurity should always be taken care of when waste water is stored separately before or after treatment.

For the systems treating waste water with a low pollutant load, land availability is necessary. They should not be located close to natural sites of ecological importance, so as not to disturb the existing biodiversity. These ponds are designed to hold water and are not normally lined. They should lie on a watertight deep area, preferably with a clay content of at least 20 %.

In general, these systems can withstand significant daily and seasonal fluctuations in load and this makes them suitable for a wide variety of settings and weather patterns. In cold climates, such as in northern Europe, the systems described may work for part of the year only, i.e. during the growing period. For this reason, a parallel treatment system (or a reservoir to collect and store waste water during winter) is needed [500, IRPP TWG 2011]. These systems are used more in poultry farms, as pig farms generally have the possibility to manage waste water in combination with slurry.

Economics

Costs vary significantly depending on farm-specific factors, but an indicative cost for a typical narrow swale is in the region of EUR 6.00 per metre. Wetlands constructed on suitable soil types will require excavation, fencing, gates, weirs, plants and professional fees for design. An indicative cost based on design parameters set out in the UK sustainable drainage systems manual (SUDS) is equivalent to EUR 0.9–1.1 per m² of impermeable area drained, the cost possibly falling for larger wetlands.

One example of an existing wetland system (Thornton Poultry Sheds, Glenrothes, Fife, in the UK) was designed to treat and attenuate an area of 22 005 m² and cost about EUR 70 000 to construct. (exchange rate: 1 GB pound = 1.17 EUR, November 2011).

The cost of a separation system can vary depending on the embodiment, dimensions, etc. The investment costs (excluding VAT, sumps and placement) are about EUR 750; the total investment and installation costs are in the range of EUR 1 500–2 500.

Driving force for implementation

The systems provide a natural way to treat lightly contaminated run-off waters originating from a wide variety of sources and with varying contamination problems. These features can fit in well with the landscape and offer shelter to wildlife. The recovered biomass can have a wide range of applications (e.g. substrate for biogas or bioethanol production). They are cheaper to construct than piped systems and offer a low-maintenance option that is easy to control.

Example plants

These solutions are increasingly common for new poultry units in the UK.

Constructed or natural wetlands are widely used worldwide to treat waste water, mainly receiving dilute effluents with a typical BOD₅ of 100–250 mg/l. The BOD₅ of waste water associated with livestock production can be considerably higher. In some Member States (e.g. Austria), only rainwater is expected to be treated, as described in this section.

Reference literature

[203, ADAS 2005] [362, UK 2010] [363, EHS 2006] [462, VITO 2005] [594, Agro Business Park 2011] [672, Faz A. 2015]

4.15.2.3 Landspreading of waste water by using an irrigation system

Description

Waste water encompasses all the water from a farm that contains residues from the cleaning of farm installations and farmyard run-off, and generally has a high BOD level (1 000–5 000 mg/l). Irrigation is applied as far as the available land is suitable. The same restrictions as for slurry landspreading apply.

This technique can use settlement tanks or lagoons to collect the waste water, before it is pumped onto land. Particles can settle to prevent the system from clogging, or solids removal can be carried out in the machine itself. This fraction will have to be landspread.

The waste water is pumped from the stores and brought into a pipeline that goes to a sprinkler or travelling irrigator for example, which sprays the water onto land. Irrigation can also be carried out using a pulse-jet irrigator (see Section 4.13.4.2.2), a tanker or an umbilical injector. A schematic representation of a sprinkler or travelling irrigation system for dirty/waste water is shown in Figure 4.105.

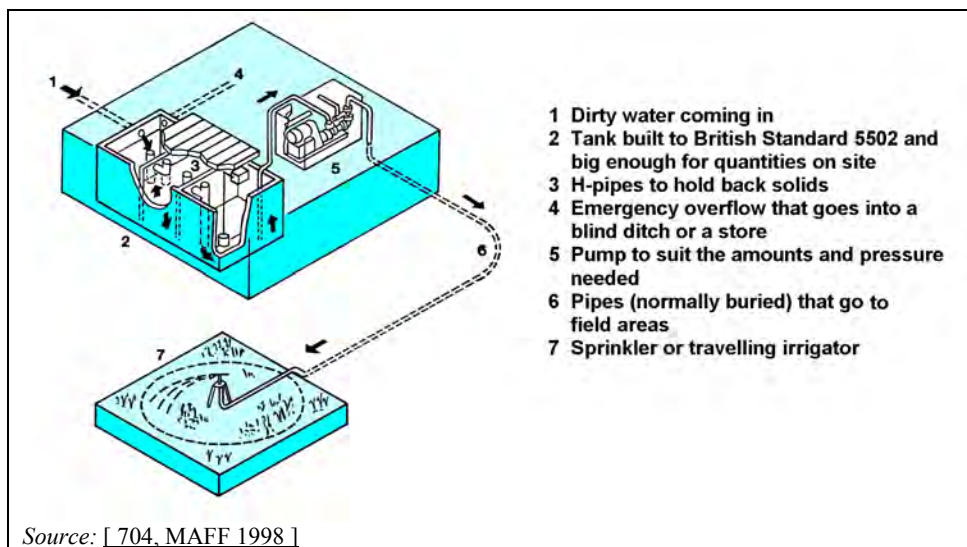

Figure 4.105: Example of a sprinkler or travelling irrigation system

Achieved environmental benefits

The technique is considered to have benefits in preventing waste water entering the sewer system or being discharged into nearby surface waters. However, irrigation should be carried out within the capacity limits of the receiving soil and should follow the general rules of good landspreading management (see Section 4.13.3).

Cross-media effects

Energy is required to operate the system. Sufficient land must be available for spreading. However, it may reduce the amount of land available for applying slurry. Odour can arise during spreading, and weather and soil conditions must be taken into account.

Environmental performance and operational data

Irrigation systems use suitable tanks or earth-banked stores to collect liquids and let them settle. They use an electric pump, small bore piping and sprinklers (up to 5 mm per hour) or a small travelling irrigator (up to 50 m³/ha or 5 mm per run) to spread liquids onto the land. The required storage period will depend on the risks of causing pollution from run-off when spreading the waste water.

The system requires an emergency overflow to store water in excess of its capacity (in case of heavy rainfall). The pump must be designed for the required pressure, depending on the distance to the sprinkling system. The capacity is variable and adapted to the average volume expected.

Technical considerations relevant to applicability

Sufficient land adjacent to the farm is preferred, as it avoids the use of long pipelines covering large distances. The sprinkler system will have to be moved regularly to prevent contamination of the soil. The system requires regular maintenance to avoid clogging of the pipes and to prevent odour from residues from collecting in the system. Only lightly contaminated waste water can be used for this system.

Economics

No information provided.

Driving force for implementation

Separate handling of waste water from slurry offers more flexibility in slurry management, i.e. less storage volume is required, and less needs to be spread by slurry application techniques.

Example plants

The technique is widely applied in the UK.

Reference literature

[242, CRPA 2009] [386, DEFRA 2009] [704, MAFF 1998]

4.16 Optimisation of the whole-farm environmental impact – Adoption of an integrated approach

Description

Ammonia emission reduction measures applied to a specific stage of the manure production and handling have an influence on the emissions potential of the next stage, due to the interdependency of the various phases of livestock manure management. In general, a reduction of ammonia emissions from the housing system results in a higher concentration of nitrogen in the stored manure. Meanwhile, a measure to reduce emissions from manure storage results in an increased amount of available nitrogen for landspreading, with a consequent higher risk of ammonia emissions during landspreading and higher potential for nitrate leaching to water. Moreover, controlling emissions from manure landspreading is particularly important, because these are generally a large component of the total emissions and because landspreading is the last stage of manure handling; without abatement at this stage, much of the benefit of abating during housing and storage, which is often more costly, may be lost. Likewise, controlling emissions from landspreading will have less benefit for total farm losses and nitrogen use efficiency if large losses occur in barns and storages. On the basis of these observations, strategies for ammonia emissions reduction which retain nitrogen during one process step are only beneficial if they do not subsequently exacerbate losses from the following step.

Combinations of measures/techniques applied at the different production stages do not simply add up in terms of the overall emission reduction efficiency; in addition, the abatement efficiency of a technique may depend on the measures/techniques applied in the previous production stages. Furthermore, techniques may have associated cross-media effects that result in significant indirect emissions related to the use of energy (fossil fuel, electricity), chemical products (fertilisers, additives) or materials whose extraction/production may cause damage to the environment.

Therefore, an integrated approach for a whole-farm emissions reduction should be promoted, based on a manure management strategy that avoids pollution swapping. In other words, the reduction efficiency in relation to the whole production chain (i.e. application of combined techniques) has to be assessed in parallel when making a decision on a choice of a technique.

Because of the above interrelation, involved parties (i.e. competent authorities, regulators, farmers, researchers), in order to optimise their abatement strategies and environmental outcomes can make use of models or available calculation tools with an integrated approach where the overall mass flow of ammonia nitrogen is assessed in relation to the induced environmental cross-media effects. A whole-farm environmental and/or economic assessment of the combination of techniques may be determined by calculations based on available data (e.g. emission factors, reduction rates, consumption of energy and other resources, costs) and estimations of cross-media effects. This approach allows distinguishing between techniques or combinations of techniques that lead to an overall environmental improvement and techniques which may result in a trade-off of pollutants.

Achieved environmental benefits

The benefit is an overall emissions reduction from the whole farm through optimised manure management and use of manure nutrients (particularly nitrogen). Pollution swapping from one production stage to another is avoided.

Cross-media effects

None reported.

Environmental performance and operational data

Tools have been developed for the environmental and economic assessment of the combination of techniques.

Different combinations of techniques, applicable to the main stages of the rearing process, have been assessed for the main animal categories (fattening pigs, laying hens and broilers) on the basis of a methodology developed by Denmark. The assessment has been carried out in comparison with reference techniques and combinations of techniques considered to be commonly used for the specific animal category and associated with a basic environmental performance. Some indicative examples of the selected combinations of techniques used for the assessment are indicated below. It should be noted that these combinations are not intended to define BAT for the specific animal category; the aim is to present examples of the environmental performance for the whole farm and, in general, to illustrate the usefulness of the approach. The specific assessment tool takes into account not only ammonia emissions but also nitrogen emissions to water and greenhouse gas emissions.

The environmental assessment is also combined with an economic analysis, which is used to assess economic constraints to the applicability of techniques and their possible combination, in particular with regards to the size of the farm. All assessments were based on information, i.e. ammonia emission reduction efficiency and information on costs, reported in the previous sections.

Some indicative examples of the combinations of techniques submitted to environmental and economic assessment are presented in Table 4.218, Table 4.219, Table 4.220 and Table 4.221.

Table 4.218: Examples of assessed combinations of techniques for fattening pigs

Nutrition	Housing system	Manure storage	Landspreading	Total NH ₃ reduction (%)	Additional production costs (EUR/ap) ⁽¹⁾			Cost efficiency (EUR/kg NH ₃) ⁽¹⁾		
					Animal places			Animal places		
					2 000	4 000	8 000	2 000	4 000	8 000
Low-protein feed [16 %]	FSF with vacuum system [10 %]	Floating cover (natural crust) [28 %]	Band spreader (trailing hose) [42 %]	35.8	0.5	0.5	0.5	0.3	0.3	0.3
Phase feeding with addition of amino acids [19 %]	FSF with vacuum system [10 %]	Tent cover [90 %]	Open slot shallow injection [68 %]	55.0	3.1	3.1	3.1	1.3	1.3	1.3
Two-phase feeding [8 %]	FSF with vacuum system [10 %] + air cleaning system [90 %]	Floating cover (straw)	Band spreader (trailing hose) [42 %]	69.3	15.9	15.3	15.1	5.1	4.9	4.9
Two-phase feeding [8 %]	FSF with vacuum system [10 %] + slurry acidification [75 %]	Slurry acidification + storage without cover [75 %]	Band spreader (trailing hose) [42 %]	81.4	10.3	7.1	5.2	2.8	1.9	1.4

⁽¹⁾ The fertilising value of N is excluded from calculations.

NB: Baseline: One-phase feeding, FSF with a deep pit, uncovered storage, broadcast spreading, no incorporation within 24 hours. The NH₃ emission reduction achieved by each technique in comparison to the baseline that was used in the calculations is cited in brackets. For nutrition, the reduction efficiency is associated with N excretion.

Source: [629, Denmark 2013] [661, Denmark 2013]

Table 4.219: Examples of assessed combinations of techniques for broiler production

Nutrition	Housing system	Manure storage	Landspreading	Total NH ₃ reduction (%)	Additional production costs (EUR/ap) ⁽¹⁾		Cost efficiency (EUR/kg NH ₃) ⁽¹⁾	
					Bird places			
					40 000	80 000	40 000	80 000
Phase feeding with amino acid [20 %]	Deep litter	Covered storage [28 %]	Incorporation within 4 hours [81 %]	44.9	0.01	0.01	0.2	0.2
Phase feeding with amino acid [10 %]	Deep litter + air cleaning (acid scrubber, 100 % air cleaning) [70 %]	Covered storage [28 %]	Incorporation within 4 hours [81 %]	66.6	1.47	1.29	14.4	12.6

⁽¹⁾ The fertilising value of N is excluded from calculations.
 NB: Baseline: Phase feeding, deep litter, uncovered storage, broadcast spreading, no incorporation within 24 hours. The NH₃ emission reduction achieved by each technique in comparison to the baseline that was used in the calculations is cited in brackets. For nutrition, the reduction efficiency is associated with N excretion.
 Source: [629, Denmark 2013] [661, Denmark 2013]

Table 4.220: Examples of assessed combinations of techniques for laying hens in enriched cages

Nutrition	Housing system	Manure storage	Landspreading	Total NH ₃ reduction (%)	Additional production costs (EUR/ap) ⁽¹⁾		Cost efficiency (EUR/kg NH ₃) ⁽¹⁾	
					Bird places			
					40 000	80 000	40 000	80 000
Phase feeding with amino acid [10 %]	Enriched cages, non-ventilated belt, manure removal 2 times a week [51 %]	No storage	Immediate incorporation [95 %]	58.9	0.1	0.1	1.0	1.0
Phase feeding with amino acid [10 %]	Enriched cages, ventilated belt with manure drying (weekly removal) [58 %]	Covered storage [25 %]	Incorporation within 4 hours [81 %]	56.4	2.8	2.8	21.4	21.4

⁽¹⁾ The fertilising value of N is excluded from calculations.
 NB: Baseline: Phase feeding, non-ventilated belt, uncovered storage, broadcast spreading, no incorporation within 24 hours. The NH₃ emission reduction achieved by each technique in comparison to the baseline that was used in the calculations is cited in brackets. For nutrition, the reduction efficiency is associated with N excretion.
 Source: [629, Denmark 2013] [661, Denmark 2013]

Table 4.221: Examples of assessed combinations of techniques for laying hens on litter

Nutrition	Housing system (with or without end-of-pipe technique)	Manure storage	Landspreading	Total NH ₃ reduction (%)	Additional production costs (EUR/ap) ⁽¹⁾		Cost efficiency (EUR/kg NH ₃) ⁽¹⁾	
					Bird places			
					40 000	80 000	80 000	40 000
Phase feeding with amino acid [10 %]	Aviaries, ventilated belt, removal 2 times per week [72 %]	Covered storage [25 %]	Immediate incorporation [95 %]	69.8	6.4	6.4	37.7	37.7
Phase feeding with amino acid [20 %]	Aviaries, ventilated belt, removal 2 times per week [72 %]	Covered storage [25 %]	Immediate incorporation [95 %]	73.2	6.4	6.4	36.2	36.2
Phase feeding with amino acid [10 %]	Deep litter, forced drying of manure in pit [88 %]	Covered storage [25 %]	Incorporation within 4 hours [81 %]	79.4	2.3	2.3	12.4	12.4

⁽¹⁾ The fertilising value of N is excluded from calculations

NB: Baseline: Phase feeding, deep litter, uncovered storage, broadcast spreading, no incorporation within 24 hours. The NH₃ emission reduction achieved by each technique in comparison to the baseline that was used in the calculations is cited in brackets. For nutrition, the reduction efficiency is associated with N excretion.

Source: [629, Denmark 2013] [661, Denmark 2013]

Technical considerations relevant to applicability

There are no restrictions to the applicability.

Economics

Estimated costs for implementing the combinations of techniques chosen as examples of the whole-farm approach are based on economic data provided for each technique and reported in the relevant sections of Chapter 4. In [661, Denmark 2013], the detailed cost data used for the assessment are presented, together with general economic assumptions. However, the results presented in the tables above should be interpreted with caution, due to the limited economic data reported [661, Denmark 2013].

The total costs have been calculated as increased production costs (EUR per animal place) and as costs of emission reduction (EUR per kg reduced NH₃ emission). Cost estimations have been determined for different capacity farms, in particular for:

- sows: 750, 1 500 and 3 000 animal places;
- fattening pigs: 2 000, 4 000 and 8000 animal places;
- laying hens: 40 000 and 80 000 bird places;
- broilers: 40 000 and 80 000 bird places.

The comparison of cost estimates for various combinations of techniques, with different overall emission reduction performances, provides the following indications:

- combinations of techniques that include end-of-pipe measures are significantly more expensive in terms of EUR/animal place;
- the economic impact on different size farms is evident in the pig sector, with higher costs for farms with a capacity between 750 and 1 500 places for sows and between 2 000 and 4 000 places for fattening pigs;
- in general, higher costs are associated with higher ammonia removal efficiencies; however, some combinations showing comparable environmental performances may be associated with significantly different costs.

The results of the economic assessment for combinations of techniques indicate the importance of using a whole-farm approach in order to determine the overall environmental efficiency generated from the combination of measures taken at all steps of the production process, from nutritional measures to manure management.

Driving force for implementation

Livestock manure is a valuable source of nutrients for soil and crops. The efficient use of manure nutrients on agricultural land can substantially reduce the need for mineral fertiliser. An effective use of manure nutrients, in particular nitrogen, requires consideration of the whole manure management system.

A whole-system approach can prevent or limit the environmental consequences further up or down the production chain and/or ensure adjoining systems are taken into account when making a decision on emission control techniques. Regulators are seeking to drive down emissions, and producers are trying to drive down costs of production, whilst improving resource efficiency and produce a product for which there is a market demand within the financial constraints of what the market will pay for that product. A whole-system approach enables the identification of the most cost-efficient techniques or combination of techniques that can achieve the same level of environmental protection.

Example plants

Decision support tools for the environmental and economic assessment of techniques or combinations of various techniques are available within the European Union.

Reference literature

[\[204, IMPEL 2009 \]](#) [\[500, IRPP TWG 2011 \]](#) [\[508, TFRN 2014 \]](#) [\[612, TWG comments 2012 \]](#) [\[629, Denmark 2013 \]](#) [\[661, Denmark 2013 \]](#)

4.17 Techniques for the reduction of dust emissions

4.17.1 Techniques to reduce dust generation inside livestock buildings

Description

Littering technique and litter management

The kind and quality of bedding material influence the emissions. Finely structured material (e.g. chopped straw) is expected to emit more particles than coarse material (e.g. long straw, wood shavings) or dedusted bedding materials. In addition, the frequency of littering and the quantity of bedding material influence the emissions. The dust load in the animal house air is particularly high during the littering process. Littering techniques which release little dust (e.g. manual littering, no distribution, deposition of bales in the pen, by rack) are more favourable than techniques which emit large quantities of dust (e.g. the use of a bale dissolver with a throw blower, bale dropping from a platform).

The dust content of the straw also has an effect, as does the way the initial crop is harvested, collected, sorted and distributed [624, IRPP TWG 2013].

Animal activity

The airflow, density and activity of the animals in the animal house (whirling up of dust particles which had already settled) are factors that influence the quantity of dust emissions from animal houses. Housing techniques which offer the animals only little freedom of movement (e.g. individual housing of sows in crates) emit less dust than those which provide more freedom of movement (e.g. large group housing, aviary housing, floor husbandry, outdoor free range).

Feeding regime (type of feedstuff and feeding practice)

Feed is one of the main dust sources [655, Takai et al. 1998]. In pig housing, the dust concentration over the course of the day is determined by the feeding technique. During the day, during feeding or when the animals are disturbed (e.g. during inspection rounds), generally higher concentrations are measured than at night and in resting phases. The feeding regime particularly influences animal activity and emissions. If feed is dispensed in rations, which means that feedstuff is offered at certain times of the day and is not constantly available to the animals, the concentration values during feeding time are significantly higher than usual. For this reason, *ad libitum* feeding is considered more favourable.

It is reported from Germany that the kind of feedstuff used and the way it is dispensed also influence the emissions. The formation of dust can be reduced by, for example:

- use of moist feed or pelleted dry feedstuff;
- use of floury feed mixtures in liquid feed dispensers;
- addition of oily raw materials or binders to dry feed.

Feed concentrate should be stored in a closed system (feed concentrate silo). Dry feed stores which are filled pneumatically have to be equipped with dust separators.

Ventilation design and operation

Ventilation air dilutes and removes indoor airborne contaminants at a rate dependent on the effective rate of ventilation and outdoor air pollutant concentrations. Designing and operating the ventilation system with a low air speed within the house is a way to reduce dust emissions from livestock buildings.

A high ventilation rate is not always desirable, because it would result in increased heating costs, high air velocities and cold draughts. A short period of high ventilation (purge) reduces the dust concentration, but the dust concentration increases rapidly after the purge. By timing

the purge, workers could be exposed to lower dust concentrations during tasks such as weighing and feeding pigs.

Regular cleaning

Generally, the equipment and all areas in the animal house should be as smooth and as easy to clean as possible. Dust deposits should be removed regularly (e.g. once a week), with a vacuum cleaner for example [655, Takai et al. 1997].

In systems operating with the all-in all-out management principle, careful cleaning of the animal house is necessary after all animals leave the house. During the cleaning of littered poultry houses, manure should only be agitated (e.g. turned with the aid of a rotary cutter) rarely or not at all because this increases not only gaseous emissions, but also particle emissions.

Achieved environmental benefits

Emitted particulate matter such as PM₁₀ and PM_{2,5} from livestock farms is reduced.

Cross-media effects

Regular cleaning is labour-intensive and may result in workers being exposed to greater dust concentrations. Lower ventilation rates reduce dust emission but can lead to increased dust concentrations in the building with negative effects on animals' and workers' health [655, Takai et al. 1998]. Other limitations associated with animal welfare may also exist, especially in summer.

Environmental performance and operational data

In Table 4.222 and Table 4.223, emission factors associated with the animal category and housing system are reported based on measurements carried out for the national dust measurement programme in the Netherlands [644, Netherlands 2014].

Table 4.222: Emission factors for dust (PM₁₀) reported for various pig categories and types of manure management

Pig categories and manure management	kg PM ₁₀ /animal place/year	
	NL	DE
Weaners (slurry systems)	0.056–0.074	0.08
Weaners (slurry systems) + air cleaning	0.015–0.048	NI
Farrowing sows (with piglets until weaning) (slurry systems)	0.16	NI
Farrowing sows (with piglets until weaning) + air cleaning system	0.032–0.104	NI
Mating - gestating sows (slurry system)	0.175	NI
Mating - gestating sows (slurry system) + air cleaning	0.035–0.113	NI
Sows including piglets up to 25 kg (slurry system) ⁽¹⁾	NI	0.16
Sows including piglets up to 25 kg (solid system) ⁽¹⁾	NI	0.8
Fattening pigs (slurry systems)	0.153	0.24
Fattening pigs (solid systems)	NI	0.32
Fattening pigs (slurry systems) + air cleaning	0.031–0.099	0.0096–0.072
⁽¹⁾ All rearing stages.		
NB: NI = no information provided.		
Source: [644, Netherlands 2014] [474, VDI 2011]		

Table 4.223: Emission factors for dust (PM₁₀) reported for various poultry categories and types of manure management

Poultry categories and manure management	kg PM ₁₀ /animal place/year		
	NL	DE	UK
Broilers	0.017–0.022	0.015–0.025	0.025
Broilers + air cleaning	0.005–0.014	NI	NI
Laying hens (deep litter)	0.084	0.12	0.02
Laying hens (deep litter) + air cleaning	0.017–0.054	NI	NI
Laying hens (aviary)	0.065	0.078	NI
Laying hens (enriched cages)	0.023	0.006	0.01
Pullets (aviaries)	0.023	0.078	NI
Pullets (deep litter)	0.03	0.059	NI
NB: NI = no information provided.			
<i>Source:</i> [644, Netherlands 2014] [474, VDI 2011] [500, IRPP TWG 2011]			

A reported conversion factor for PM₁₀ from total dust in pig production is 40 % and between 40–60 % for poultry production [474, VDI 2011]. A research programme in broiler houses carried out in the Netherlands did not find any effect on PM₁₀ emissions when different bedding materials were tested (sawdust versus cut straw) or with different lighting schedules (in compliance with welfare regulations) in order to achieve less animal activity [27, UR Wageningen 2012]. Adding oily raw materials minimised feed dust and reduced (35–70 %) the dust concentration in some pig buildings [655, Takai et al. 1998].

Technical considerations relevant to applicability

The applicability of designing and operating the ventilation system with low ventilation rates may be limited by animal welfare considerations. Long straw is not applicable in slurry-based systems. The rest of the techniques are generally applicable.

Driving force for implementation

Process-integrated measures for the reduction of dust emissions contribute to the prevention of epizootic diseases and the reduction of bioaerosol emissions. The performance and operating duration of equipment in animal housing are improved (e.g. electronic devices, fan motors, heat exchangers).

Reference literature

[27, UR Wageningen 2012] [474, VDI 2011] [500, IRPP TWG 2011] [624, IRPP TWG 2013] [644, Netherlands 2014] [655, Takai et al. 1998]

4.17.2 Techniques to reduce the dust concentration inside animal houses

It is possible to simultaneously reduce dust emissions and the dust concentration in animal housing by applying technical measures within the house. Ionisation, oil spraying or water fogging in the animal house are techniques to decrease dust dispersion by making dust particles adhesive (see Section 4.8.3). These techniques reduce personnel and animal exposure to dust, which is an important advantage in comparison with the use of air cleaning systems.

4.17.3 Air cleaning systems

Treatment of exhaust air by air cleaning techniques has been successfully employed in several countries. For instance, acid scrubbers and bioscrubbers can remove between 70 % and 95 % of NH₃; both also remove fine dust and odour (see Section 4.9). To deal with the high dust loads, multi-stage air scrubbers with pre-filtering of coarse particles have been developed [508, TFRN 2014].

4.18 Monitoring

Monitoring is an important aspect for all livestock farms, in order to assess their operational conditions and environmental performance. It is essential to understand the level of use of inputs (i.e. feed, energy, water) and the generation of solid or liquid manure in order to consider whether and how changes may be made to improve profitability and to benefit the environment. Regular monitoring of water usage, energy usage (gas, electricity, fuel), livestock performance (especially amounts of feed and efficiency) and landspreading of mineral fertiliser and manure will form the basis for the review and evaluation. Where possible, the monitoring, review and evaluation by comparison should be related to groups of livestock, seasons, buildings or specific operations, or done on a field-by-field basis, as appropriate, to give the best chance of identifying areas for improvement. Also, monitoring should help in identifying abnormal situations and enable the appropriate actions to be taken.

In general, a range of monitoring obligations is required on poultry and pig farms, which may include:

- recording of animal numbers;
- recording of inputs (e.g. feed, water, energy)
- manure management procedures;
- integrity of manure stores;
- emissions to air (e.g. ammonia, odour and dust);
- emissions to water (e.g. groundwater quality);
- keeping records of spreading activities (e.g. timing, amount, location, quality).

An assessment of the environmental performance of techniques applied at the different stages of the manure management chain is based on the monitoring of emissions. The complex interaction between the production stages is generally monitored by determining the nitrogen flow through them: starting from feed selection and nutritional management, then continuing with housing, and ending up with storage and manure application.

4.18.1 Excretion of nitrogen and phosphorus

4.18.1.1 Mass balance

Description

This technique consists of the calculation of the annual excretion of nitrogen (or phosphorus) by the animals (e.g. kg N/animal place/year), using a mass balance based on the feed intake, dietary content of crude protein (CP) and animal retention. The same procedure can be applied for the calculation of phosphorus excretion.

Achieved environmental benefits

Decreasing nitrogen and phosphorus excretion is considered one of the most cost-effective and strategic ways of reducing emissions from the whole farm. Monitoring of excretion helps to identify the efficiency of the nutritional measures carried out on the farm. It also helps to identify the effect of the housing conditions (e.g. temperature, ventilation, floor conditions) on the animal performance.

Cross-media effects

Some equipment, ancillary materials and energy can be required for carrying out monitoring (e.g. sampling of carcass).

Environmental performance and operational data

The mass balance is based on Equation 4.1:

$$\text{Equation 4.1: } N_{\text{excreted}} = N_{\text{diet}} - N_{\text{retention}} = \sum F_{\text{ING}_i} \cdot CP_i - N_{\text{retention}}$$

where:

N_{excreted} Annual N excreted, in kg N/animal place/year.

F_{ING_i} Annual amount of feed ingested during the i feeding phase, in kg feed/animal/year.

CP_i Crude protein content of the i feeding phase, in %. Indicative contents are given in Table 4.13 and Table 4.14. F_{INT_i} and CP_i can be calculated by:

- accompanying documentation in the case of external feed supply;
- sampling of feedstuff compounds from the silos or the feeding system for analysing the CP content, in the case of self-processing of feed.

$N_{\text{retention}}$ Annual N retention, in kg N/animal place/year. This can be estimated by one of the following methods:

- analysis of the N content of a representative sample of the carcass (or the eggs, in the case of laying hens);
- equations or models derived by statistics;
- standard retention factors for the N content of the carcass (or of the eggs, in the case of laying hens).

The values in Table 4.13 and Table 4.14 are indicative target levels of crude protein and may need to be adapted to local conditions.

Technical considerations relevant to applicability

This monitoring technique is applicable to all farms.

Economics

The costs associated with monitoring of excretion relate to personnel and equipment used for sampling and documentation.

Driving force for implementation

Monitoring of the nitrogen excreted is linked to the mass-balance technique for monitoring ammonia emissions from the housing system, manure storage and/or landspreading. This technique allows information to be collected on excretion taking into account the specific characteristics of individual farms.

Reference literature

[43, COM 2003]

4.18.1.2 Manure analysis**Description**

This technique consists of the calculation of the annual excretion of nitrogen (or phosphorus) by the animals (kg N/animal place/year), using an analysis of the nitrogen content of a representative manure sample of the bulk of the material from which it is taken.

The total nitrogen content of a representative composite sample of the manure is measured and the total nitrogen excreted is estimated on the basis of records for the volume (for slurry-based systems) or weight (for solid manure systems) of the manure. For solid manure systems, the nitrogen content of the litter should be considered. The same procedure can be applied for the calculation of phosphorus excretion.

Achieved environmental benefits

Decreasing nitrogen and phosphorus excretion is considered one of the most cost-effective and strategic ways of reducing emissions from the whole farm. Monitoring of excretion helps to identify the efficiency of the nutritional measures carried out on the farm. It also helps to identify the effect of the housing conditions (e.g. temperature, ventilation, floor conditions) on the animal performance.

Environmental performance and operational data

In order for the composite sample to be representative, samples should be taken from at least 10 different places and/or depths to make the composite sample. In the case of poultry litter, the bottom of the litter is sampled. If possible, the liquids should be agitated before collecting the sample.

Technical considerations relevant to applicability

This monitoring technique is applicable to all farms.

Economics

The costs associated with monitoring of excretion relate to personnel and equipment used for sampling and documentation.

Driving force for implementation

Monitoring of the nitrogen excreted is linked to the mass-balance technique for monitoring ammonia emissions from the housing system, manure storage and/or landspreading. This technique allows information to be collected on excretion taking into account the specific characteristics of individual farms. The analysis of nutrients (nitrogen and phosphorus) allows the determination of the fertiliser value of the manure to be landspread.

Reference literature

[627, EEA 2013]

4.18.2 Ammonia emissions

4.18.2.1 Mass balance

Description

The estimation of ammonia emissions based on a nitrogen mass balance is the most commonly applied monitoring method. This technique consists of starting with the farm-specific amount of nitrogen excreted by a defined livestock category and using the total nitrogen (or the TAN) flow and the efficiency factors (EF) over each manure management stage, i.e. the proportion of the annual flow of total N or TAN that is emitted to air.

Achieved environmental benefits

Monitoring of ammonia helps to identify the efficiency of the measures carried out in relation to the housing system, storage and/or landspreading.

Environmental performance and operational data

The ammonia losses between the moment of nitrogen excretion and the moment of removing the manure from the housing system and/or its landspreading are estimated. These losses depend on the housing system and manure storage techniques:

Equation 4.2: $N_{\text{manure}} = N_{\text{diet}} - N_{\text{retention}} - N_{\text{gaseous losses from buildings and manure storage}}$

where:

N_{diet} Amount of N contained in the diet consumed (kg N/animal/year) = $\sum F_{ING_i} \cdot CP_i$
 $N_{\text{retention}}$ Amount of N retained by the animal (live weight \times N content) and related products (i.e. piglets for sows, eggs for laying hens)

Equation 4.3: $N_{\text{excreted}} = N_{\text{diet}} - N_{\text{retention}}$

Nitrogen loss factors depend on the type of housing, animal and manure management, and, to some extent, on climatic conditions. The equations to be applied in each of the manure management stages are:

Equation 4.4: $E_{\text{housing}} = N_{\text{excreted}} \cdot VC_{\text{housing}}$

Equation 4.5: $E_{\text{storage}} = N_{\text{storage}} \cdot VC_{\text{storage}}$

Equation 4.6: $E_{\text{spreading}} = N_{\text{spreading}} \cdot VC_{\text{spreading}}$

where:

E_{housing}	Annual NH_3 emission from the animal house, e.g. in $\text{kg NH}_3/\text{animal place/year}$.
E_{storage}	Annual NH_3 emission from the manure storage system, e.g. in $\text{kg NH}_3/\text{animal place/year}$.
$E_{\text{spreading}}$	Annual NH_3 emission from manure landspreading, e.g. in $\text{kg NH}_3/\text{animal place/year}$.
N_{excreted}	Annual total nitrogen or TAN excreted, e.g. in $\text{kg N/animal place/year}$.
N_{storage}	Annual total nitrogen or TAN stored, e.g. in $\text{kg N/animal place/year}$.
$N_{\text{spreading}}$	Annual total nitrogen or TAN applied in manure landspreading, e.g. in $\text{kg N/animal place/year}$.
VC_{housing}	Volatilisation coefficient related to the housing system techniques (dimensionless), as a proportion of TAN or total nitrogen emitted to air.
VC_{storage}	Volatilisation coefficient related to the manure storage techniques (dimensionless), as a proportion of TAN or total nitrogen emitted to air. If appropriate, N additions (e.g. related to floor bedding, recycling of scrubbing liquids) and/or N losses (e.g. related to manure processing) can be considered.
$VC_{\text{spreading}}$	Volatilisation coefficient related to the manure landspreading techniques (dimensionless), as a proportion of TAN or total nitrogen emitted to air.

In order to have reliable monitoring, volatilisation coefficients (VC) are recommended to be derived from measurements designed and performed according to a national or an international protocol (e.g. VERA protocol) and validated for an identical type of technique and similar climatic conditions. Alternatively, information to derive VC can be taken from European or other internationally recognised guidance.

Technical considerations relevant to applicability

This monitoring technique is applicable to all farms. Data concerning the protein intake of animals, the conversion rate and the growth performance are well known and are commonly used to determine production costs.

Economics

The costs associated with monitoring of excretion relate to personnel and equipment used for documentation.

Driving force for implementation

This technique allows information to be collected on ammonia emissions taking into account the specific characteristics of individual farms.

Example plants

Models in use (e.g. NEMA in NL) in different MS in the framework of the national NH_3 emission inventory apply a mass balance approach [628, Velthof 2012]. Ammonia emission factors for different livestock categories and housing systems are generally available at Member State level. Loss factors for the type of housing and manure management have been developed

through several field studies carried out in different geographical areas throughout the European Union.

Reference literature

[628, Velthof 2012]

4.18.2.2 Ammonia emission measurements

Description

A protocol has been developed by environmental authorities and experts from Denmark, Germany and the Netherlands outlining a measurement strategy and the conditions for testing ammonia emissions from livestock housing and management systems [445, VERA 2011]. The purpose of the approach presented below, based on the VERA protocol, is to calculate the annual emissions (emission factors) of a single farm. The test is carried out over a one-year period to take on board annual variations in emission levels due to seasonal and production differences.

Achieved environmental benefits

Monitoring of ammonia helps to identify the efficiency of the measures carried out in relation to the housing system, storage and/or landspreading.

Environmental performance and operational data

Samples from the farm location are taken on at least 6 days distributed over 1 year. By this procedure, seasonal variations that influence NH_3 concentrations and ventilation rates throughout a year are equally distributed and well balanced in the sampling scheme.

The distribution of the 6 sampling days within the year depends on the emissions pattern of the animal category to be considered. For animal categories with a stable emissions pattern (e.g. laying hens), the sampling days should be randomly selected in every two-month period.

For animal categories with a linear increase in emissions during the production cycle (e.g. fattening pigs), it is prescribed as an additional requirement that measurements are equally divided over the growing period. In order to achieve this, half the measurements should be performed in the first half of the production cycle, and the remainder in the second half of the production cycle. Furthermore, the sampling days in the second half of the production cycle should be equally distributed within the year (same number of measurements per season).

For animal categories with an exponential emissions pattern (e.g. broilers), the following procedure should be applied to distribute the sampling days:

- The production cycle should be divided into three periods of equal length (same number of days).
- One measurement day should fall in the first period, two measurements in the second period, and three measurements in the third period. In addition, sampling days in the third period of the production cycle should be equally distributed within the year (same number of measurements per season).

In cases where regular management practices can be expected to affect emission levels, care should be taken that these practices are incorporated in the sampling scheme in such a way that samplings are well distributed over these management practices. Sampling six times at one farm location is considered sufficient to deal with the on-farm location variance and at the same time ensures that observations are sufficiently spread in time to be independent from each other.

All measurements will be based on 24-hour sampling periods. This implies that diurnal variation patterns do not contribute to the overall measurement variation. For ammonia emission

measurements to be representative of the emissions of the housing systems, normal management procedures and no exceptional situation within the animal house are necessary. When reporting ammonia emission results, detailed descriptions of the housing system and the management system in place should be given.

Many other parameters can be measured simultaneously that may influence the emissions. As indicative examples (apart from the required ventilation rate), they can be the indoor and outdoor temperature, number and weight of animals in a housing unit, floor space per animal, air volume per animal, or feed composition parameters.

The daily average NH_3 emission rate (g/h) is estimated from the product of the daily average NH_3 concentration (g/m^3) measured at the air outlet/inlet and the measured daily average ventilation rate (m^3/h), and expressed either per animal or per livestock unit (500 kg body weight). For the estimation of the ventilation rate, see Section 4.18.3.

The emission rate (E) in test compartment (i) on sampling day (j) during time interval (k) is calculated from the ventilation rate (V) and the difference between concentrations at the outlet and inlet (C_{out} , C_{in}):

$$\text{Equation 4.7: } E_{ijk} = V_{ijk} \times (C_{outijk} - C_{inijk})$$

For animal categories with a stable emissions pattern or with a linear increase in emissions, the daily average NH_3 emission can be calculated from the average over all sampling days, and the standard deviation.

For calculating the emission factor of animal categories with an exponential emission pattern, the production cycle must be divided into three periods of equal length (same number of days). Within each period, the average emissions are calculated from the available daily average values (periodic averages). The emission factors for each test compartment are then calculated as the average of the three periodic averages.

Finally, the yearly average emission of the housing system can be calculated by multiplying by 365 days and corrected for any non-occupation period. It can be expressed in the following units: $\text{kg NH}_3/\text{animal place}/\text{year}$ or $\text{kg NH}_3/\text{LU}/\text{year}$. Ammonia emissions may also be expressed relatively as a fraction of the total nitrogen or total ammoniacal nitrogen excreted. The proposed sampling scheme for the ammonia measurement protocol is summarised in Table 4.224.

Table 4.224: Sampling strategy and monitoring conditions for testing ammonia emissions in a livestock housing system

Parameter [Units]	<ul style="list-style-type: none"> • Ammonia • [$\text{mg} \cdot \text{m}^{-3}$]
Sampling strategy	<ul style="list-style-type: none"> • Minimum number of sampling days: 6 measurement days in 1 year (distributed according to the emission pattern)
Sampling conditions	<ul style="list-style-type: none"> • Cumulative sampling over 24 hours • Continuous measuring methods: based on hourly values (24 samples) • Sampling location: Air inlet and air outlet • Correction of background concentration is required (i.e. concentration of aerial pollutants in the incoming air)
Monitoring method	<ul style="list-style-type: none"> • Photo-acoustic monitor (NDIR) • FTIR spectrometer • NO_x chemoluminescence monitor • Impinger system • Open-path Tuneable Diode Laser
<i>Source:</i> [445, VERA 2011]	

Measurements of ammonia emissions require the employment of skilled technical operators, generally from independent and certified laboratories, able to perform the sampling and analysis of ammonia, together with the measurement of other additional parameters (i.e. airflow, temperature, humidity), necessary to determine the concentration of the pollutant, and to calculate the related emission factor.

Technical considerations relevant to applicability

This technique is only applicable to ammonia emissions from a housing system, in both natural and forced ventilated houses. The monitoring of ammonia emissions from manure storage or landspreading is described in Sections 4.18.1.1 and 4.18.2.3.

Due to the cost of measurements and technical implementation difficulties, this technique is only applicable to farms located close to sensitive receptors and/or in areas with a high concentration of farms.

Economics

The costs associated with monitoring of excretion relate to personnel and equipment used for sampling and documentation.

Driving force for implementation

This technique is linked to the mass-balance technique for monitoring ammonia emissions from the housing system, manure storage and/or landspreading.

Reference literature

[445, VERA 2011]

4.18.2.3 Emission factors

Given the complexity and costs associated with NH₃ measurements on livestock farms, the use of emission factors is a possible technique. This technique is mentioned as an example of quantification of diffuse emissions by the JRC reference report on Monitoring of IED-installations [576, COM 2017]. In order to have reliable monitoring, emission factors should be derived from measurements designed and performed according to a national or an international protocol (e.g. VERA protocol) for an identical type of technique (related to the housing system, manure storage and/or landspreading) and similar climatic conditions. This technique is also applicable to manure storage and landspreading.

An example of the assignment of emission factors to animal housing systems exists in the Netherlands [153, Netherlands 2010].

4.18.3 Ventilation rate

Determination of the ventilation rate is a requirement for the measurement of diffuse emissions. The assessment of airflow rates depends on the type of ventilation (forced or natural). Anemometers can be used in low-pressure, forced ventilated houses, to measure continuously in the ventilation shaft the airflow rate of extracted air. The specific ambient conditions inside an animal house (dust, high moisture, ammonia) can increase the calibration drift of the sensors (e.g. sensitivity of hot wire anemometers to dust). The fan wheel anemometer requirements of fluid mechanics must be respected. In housing units with partial air cleaning, the ventilation rate is also measured for the whole housing [424, VERA 2010].

Methods for determining ventilation rates may differ considerably between naturally and mechanically ventilated buildings. Normally, errors of measured ventilation rates tend to be higher in naturally ventilated buildings, which may lead to higher errors of measured emissions. In mechanically ventilated buildings, errors associated with measuring ventilation rate are

probably the most relevant error source of emission measurements. The main differences between emission measurements from naturally and mechanically ventilated buildings are the magnitude of random errors and the significance of bias. In mechanically ventilated buildings potential biases have been identified and can be avoided, whereas random error may be reduced to acceptable levels (i.e. 10–20%). However, in naturally ventilated buildings bias is difficult to identify and correct and random error is likely substantially greater than in mechanically ventilated buildings [33, Calvet et al. 2013].

In naturally ventilated buildings, ventilation rates cannot be measured by fans and must therefore be estimated using the tracer gas technique which is the only method for performing quantitative measurements of ventilation [670, Kiwan et al. 2012]. However, this approach cannot be applied when naturally ventilated buildings are too open to allow proper mixing of the tracer gas. The accuracy of this method relies on the perfect mixing of the tracer gas and the homogeneity of concentrations and ventilation inside the barn.

The ventilation rate of a building can be estimated using one of the following tracer gas methods: (1) constant tracer gas injection; (2) variable tracer gas injection; and (3) concentration decay [630, VDI 2011]. A certain amount of a tracer gas is released in the room (or barn) under study and its concentration is then recorded as a function of time and space by portable samplers or portable gas chromatographs which permit calculation of the air exchange rate. Subsequently, the ventilation rate can be calculated from the air exchange rate and the volume of the room (or barn).

The use of sulphur hexafluoride (SF₆) or any gas containing chlorofluorocarbons has a strong greenhouse effect potential [624, IRPP TWG 2013]. Ventilation rates can also be predicted using the CO₂ produced by the animals and the manure or the associated heat production. Nevertheless, most heat production knowledge concerns animal production in northern European countries. When the animal metabolism is different from those animals (growth rate, adult weight, heat or CO₂ production of manure, diurnal variations due to activity, etc.), the assumption relating to heat and CO₂ production will induce a bias in the ventilation estimates.

4.18.4 Odour emissions

Odour concentration, as measured by olfactometry, has been the primary method to quantify odours. Intensity, character and hedonic tone (offensiveness) are equally important criteria for public perception as well as the frequency and duration of the odour.

The relationship between odour concentration and odour intensity is important for establishing the effect of the odour on the public and in determining effective abatement strategies. Odours are controlled by reducing the amount of odorants in a given volume of air (concentration), but the reduction in the nuisance quality of the odour is related to the strength of the odour (intensity). There is a nonlinear relationship between odour concentration and odour intensity; the multiple compounds make it difficult to draw conclusions about the effect of the odour on the public. Because of the challenges and costs of sensory measurements, there have been some efforts to relate odour concentration to ammonia concentration or dust concentration but these have not been successful in all cases (e.g. for broilers) [438, Lacey et al. 2004].

Odour emissions can be measured by dynamic olfactometry in accordance with the European CEN standard (EN 13725:2003) in a sampling time of usually half an hour (additionally, the actual airflow is measured in the given time). The odour concentration c_{od} is given in European odour units per cubic metre of air (ou_E/m³). One odour unit (ou_E) is defined as equivalent to the response elicited by one European reference odour mass, most commonly 123 µg n-butanol evaporated into 1 m³ of neutral gas [428, GEC 2008]. Spot measurement figures are given as ou_E/m³ per second. Emission factors are set up for the animal mass that may be reared in the shed (animal place or LU) or alternatively linked to the source area (ou_E/m² per s).

Other alternative techniques based on selected and trained panel members (e.g. measurement of odour impact by determining odour intensity and hedonic tone in the field) or odour surveys (e.g. measurement/estimation of annoyance caused by odour exposure in the survey area, complaints registers) are also applied. A number of these methods are standardised at the national level (e.g. VDI 394 Part 3: 2010 on monitoring with panels) (see also the ROM REF [576, COM 2017]). Odour intensity observations by workers in an odorous environment are unreliable due to sensory adaptation [624, IRPP TWG 2013].

Two new EN standards are under development by the Technical Committee CEN/TC 264/WG 27 for the determination of odour exposure in ambient air using selected and trained panels in the field [576, COM 2017]. In German regulations, odour impacts are assessed as significant and legally not allowed, in order to avoid annoyances in the vicinity of farms, if a frequency of odour perception of 10 % (general residential areas) or 15 % (village areas) of the yearly hours for an odour concentration of $1 \text{ ou}_E / \text{m}^3$ is exceeded [590, Batfarm 2013].

4.18.5 Dust emissions

As for ammonia emissions, dust emissions can be measured or estimated using emission factors. Measurements of dust emissions are also covered by the VERA protocol, and the operational procedure is very similar to the one used for ammonia emissions (see Section 4.18.2.2). The main differences are related to the measuring methods, which are summarised in Table 4.225.

Table 4.225: Sampling strategy and monitoring conditions for testing dust emissions in a livestock housing system

Parameter [Units]	<ul style="list-style-type: none"> • Total dust, PM₁₀, PM_{2.5} • [mg·m⁻³]
Sampling strategy	<ul style="list-style-type: none"> • Minimum number and distribution of sampling days: 6 measurement days in 1 year
Sampling conditions	<ul style="list-style-type: none"> • Cumulative sampling over 24 hours • Continuous measuring methods: based on hourly values (24 samples) • Sampling time: 24 hours for PM₁₀ and PM_{2.5} • Sampling location: Air inlet and air outlet.
Measuring method	Gravimetric: EN 13284-1:2001 EN 13284-2:2004 EN 15259:2007 EN 14907:2005 EN 12341
<i>Source: [445, VERA 2011]</i>	

4.18.6 Air cleaning systems

Protocols have been developed (e.g. VERA protocol) in order to specify the procedure for testing the efficiency of air cleaning systems in animal housing, including definitions, requirements and conditions for parties involved in the testing, measurement and sampling methods, processing and interpretation of measurement results, and reporting.

Measurement of emissions from air cleaning system can be waived by verifying and continuously ensuring the efficiency of the emission control system. This can be done by an acceptance inspection (verification) and continuously monitoring process parameters.

4.18.6.1 Verification of air cleaning systems

After a period of at least 4 months from the start of operation of the air cleaning system but no more than 18 months, an acceptance inspection with measurement of ammonia, odour and dust in the raw and the clean gas and an evaluation of all additional parameters relevant for operation (e.g. airflow rate, pressure drop, temperature) has to be carried out by an independent body (e.g. certified laboratory).

Inspection testing has to be performed under summer conditions (a period of at least 8 weeks with a ventilation rate above 80 % of the maximum ventilation rate) and winter conditions (a period of at least 8 weeks with a ventilation rate below 30 % of the maximum ventilation rate), representative management and with the housing at full capacity and if a representative period of time (e.g. 4 weeks) has elapsed since the last change of wash water. Inspection testing also includes an analysis of the wash water used during the period of measurement.

The following sampling strategy is based on the VERA protocol:

- Ammonia: 24-hour continuous sampling once a week during each of the 2 eight-week periods.
- Odour: weekly during each of the 2 eight-week periods, two samples per day, minimum sampling period 30 minutes (one sample per day is enough if the sampling time is 120 minutes).
- Dust: Total dust: one 24-hour sample in each of the eight-week periods. Measurements of PM₁₀ and PM_{2.5} are optional.
- Recirculated liquid of the air cleaning system: on all days, with odour and ammonia measurements analysed for pH, conductivity, NH₄⁺, NO₂⁻ and NO₃⁻.

Establishing a N-balance, when relevant, in order to document possible secondary trace gases formation and secure long-term operational stability of the air cleaner, requires a period of at least 2 weeks within the eight-week periods with online gas (NH₃, NO_x, N₂O) and volumetric flow measurements (gas and liquid) and water analyses (fresh and blowdown water).

After the acceptance inspection, regular check-ups of the air cleaning system have to be conducted every year by a certified laboratory on an unannounced farm visit. These check-ups include inspection of the technical condition and function of the air cleaning system, odour measurement of the inlet and outlet air, ammonia measurement and a review of all additional parameters relevant for operation (e.g. condition and cleanliness of the filter material). Periodic (at least yearly) maintenance also has to be performed by the supplier or a qualified contractor. Protocols of the maintenance can be provided to the competent authority. The ammonia emission rate (kg NH₃/animal place/year) for a scrubber system is calculated by multiplication of an assigned reduction percentage (assigned as above) with the ammonia emission rate for a conventional housing system without a scrubber.

The verification review of the air cleaning system is considered unnecessary in the Netherlands when the design of the system is similar to already existing systems or when the targeted efficiency of the system is not greater than 70 % [153, Netherlands 2010].

4.18.6.2 Monitoring of process parameters of air cleaning systems

Description

In principle, an electronic logbook has to be installed and operated in order to record relevant information (measurement and environmental performance and operational data) in order to evaluate operational stability and document the proper operation of the exhaust air cleaning system. Continuous logging of key parameters can take place over a period of up to 5 years.

Among the parameters that may be recorded are: pressure drop, ventilation rate, pump running times, pH level, conductivity, water and acid consumption, acid and alkali consumption, conductivity. Parameters to be recorded depend on the type of air cleaning system and the requirements of the permit. It is advisable to use half-hourly averages for the first 7 days and daily average values after that [624, IRPP TWG 2013].

Additional general information is recorded manually such as number and type of animals kept, average live weight, special incidents (e.g. failure of pumps, measuring devices), invoices for chemicals, condition of filter material and spray pattern of nozzles, regular checks of the installation. Monitoring of the operating parameters is necessary, both for proper operation and for regulatory control. Some of the parameters listed in Table 4.226 may be stored in electronic operation logs, depending on the equipment used.

Table 4.226: Parameters to be recorded in the operations logbook

Parameter	Biofilter	Trickle bed reactor (bioscrubber)	Acid scrubbers and multi-stage scrubbers
Pressure loss in the exhaust air treatment system	x	x	x
Airflow rate	x	x	x
Pump running times (separate for the circulation pumps and the elutriation pumps)		x	x
Sprinkling intervals	x	x	x
Total water consumption of the exhaust air treatment system	x	x	x
Proof of acid consumption (with receipts)		m	m
Elutriated water quantity and its discharge		x	m
pH regulation		x	x
Water pressure	x	x	x
Raw gas temperature	x	x	x
Clean gas temperature		x	x
Calibration of the pH sensor		m	m
System control – sprinkling pattern	m	m	m
Maintenance and repair times (including the kind of work)	m	m	m
Change of filter material	m		
NB: x = electronic recording; m = manual recording.			
Source: [514, KTBL 2008]			

Continuous monitoring of electrical conductivity, pH, discharge volume, electricity consumption and pressure drop are considered to allow a sufficient estimation of the system functionality.

In the event that there is no electronic monitoring of process parameters, the operational stability of the system can also be verified by visits with an overall check-up and checking of the logbook and testing of discharge water and NH₃ measurement [424, VERA 2010].

Some key parameters for the evaluation are given below:

- Residence time at maximum airflow (i.e. the airflow at a high animal weight on hot summer days).
- Amount of water that is sprinkled over the packing sufficient for its complete wetting.
- In bioscrubbers, sufficient amount of water discharge in order to prevent inhibition of the bacteria.
- In acid scrubbers, sufficient amount of water discharge and pH in order to prevent precipitation of ammonium salts.
- Comparison with existing scrubber designs that have been tested in the field and/or have been evaluated before.

Economics

The costs of measurements of emissions to air are generally considered high and therefore not viable for the majority of farms. For this reason, the control of surrogate parameters is commonly used as an alternative to emission measurement.

Driving force for implementation

Continuous monitoring of pressure drops over the air cleaning systems, combined with alerts, provides farmers with a timely indication of when to clean packing material, thus saving energy and costs. In the case of other than normal operating conditions, the proper operation of the system can be documented.

Example plants

Monitoring of the proper operation of several hundred air cleaning systems has been carried out in Germany in recent years.

Reference literature

[153, Netherlands 2010] [424, VERA 2010] [514, KTBL 2008] [624, IRPP TWG 2013]

4.18.7 Emissions to water

Water contamination from livestock farms may arise from leakage of manure stores, poor management of run-off waters and inappropriate management of manure landspreading. Monitoring of local groundwater can be a means to detect leakages rapidly, in particular where earth-banked lagoons without a double geomembrane are used for slurry storage [204, IMPEL 2009]. The typical parameters to be measured are the following:

- nutrients: nitrogen compounds and phosphorus;
- pathogens, such as coliforms, *E. coli*;
- metals, such as Zn, Cu.

However, a straightforward correlation of a specific farm with groundwater quality cannot always be established, as the increase of pollutants such as NO_3^- in the groundwater can be a slow procedure and because of the diffuse character of water pollution from agricultural sources [624, IRPP TWG 2013]. The impact depends on many factors such as the geology of the area. Groundwater mapping and protection schemes are usually implemented at national or regional level due to the high costs.

4.18.8 Process parametersWater consumption

Suitable meters or invoices can be used for recording the water consumption. The main water-consuming processes in animal houses (cleaning, feeding, etc.) can be monitored separately depending on the configuration of the water supply network.

Electric energy consumption

Suitable meters or invoices can be used for recording the electric energy consumption. The electricity consumption of animal houses is monitored separately from other plants in the farm. The main energy-consuming processes in animal houses (heating, ventilation, lighting, etc.) can be monitored separately depending on the configuration of the energy supply network.

Fuel consumption

Suitable meters or invoices can be used for recording the fuel consumption.

Animal register and feed consumption

The number of incoming and outgoing animals, including births and deaths when relevant, can be recorded using invoices or existing registers. Feed consumption can be recorded using invoices or existing registers for example.

Manure generation

Manure generation can be recorded using existing registers for example.

5 BAT CONCLUSIONS

SCOPE

These BAT conclusions concern the following activities specified in Section 6.6 of Annex I to Directive 2010/75/EU, namely '6.6. Intensive rearing of poultry or pigs':

- (a) with more than 40 000 places for poultry
- (b) with more than 2 000 places for production pigs (over 30 kg), or
- (c) with more than 750 places for sows.

In particular, these BAT conclusions cover the following on-farm processes and activities:

- nutritional management of poultry and pigs;
- feed preparation (milling, mixing and storage);
- rearing (housing) of poultry and pigs;
- collection and storage of manure;
- processing of manure;
- manure landspreading;
- storage of dead animals.

These BAT conclusions do not address the following processes or activities:

- disposal of dead animals; this may be covered in the BAT conclusions on Slaughterhouses and Animal By-products Industries (SA).

Other BAT conclusions and reference documents which are of relevance for the activities covered by these BAT conclusions are the following:

Reference documents	Activity
Waste Incineration (WI)	Incineration of manure
Waste Treatment Industries (WT)	Composting and anaerobic digestion of manure
Monitoring of emissions from IED-installations (ROM)	Monitoring of emissions to air and water
Economics and Cross-media Effects (ECM)	Economics and cross-media effects of techniques
Emissions from Storage (EFS)	Storage and handling of materials
Energy Efficiency (ENE)	General aspects of energy efficiency
Food, Drink and Milk Industries (FDM)	Feed production

Where these BAT conclusions address manure storage and landspreading, this is without prejudice to the provisions of Council Directive 91/676/EEC ⁽¹⁾.

Where these BAT conclusions address the storage and disposal of dead animals and manure processing and landspreading this is without prejudice to the provisions of Regulation (EC) No 1069/2009 of the European Parliament and of the Council ⁽²⁾.

These BAT conclusions apply without prejudice to other relevant legislation, e.g. on animal welfare.

⁽¹⁾ Council Directive 91/676/EEC of 12 December 1991 concerning the protection of waters against pollution caused by nitrates from agricultural sources (OJ L 375/1, 31.12.1991, p.1)

⁽²⁾ Regulation (EC) No 1069/2009 of the European Parliament and of the Council of 21 October 2009 laying down health rules as regards animal by-products and derived products not intended for human consumption and repealing Regulation (EC) No 1774/2002 (Animal by-products Regulation) (OJ L 300/1, 14.11.2009, p.1)

DEFINITIONS

For the purposes of these BAT conclusions, the following definitions apply.

Term used	Definition
Ad libitum	The provision of free access to feed or water thereby allowing the animal to self-regulate intake according to its biological needs.
Animal place	Space provided per animal in a housing system taking into account the maximum capacity of the plant.
Conservation tillage	Any method of soil cultivation that leaves the previous year's crop residue (such as corn stalks or wheat stubble) on fields before and after planting the next crop, to reduce soil erosion and run-off.
Existing farm	A farm which is not a new farm.
Existing plant	A plant which is not a new plant.
Farm	An installation as defined in Article 3(3) of Directive 2010/75/EU where pigs or poultry are reared.
Manure	Slurry and/or solid manure.
New farm	A farm first permitted following the publication of these BAT conclusions or a complete replacement of a farm following the publication of these BAT conclusions.
New plant	A plant first permitted at the site of the farm following the publication of these BAT conclusions or a complete replacement of a plant on the existing foundations, following the publication of these BAT conclusions.
Plant	A part of the farm where one of the following processes or activities is carried out: animal housing, manure storage, manure processing. A plant consists of a single building (or facility) and/or the necessary equipment to carry out processes or activities.
Sensitive receptor	Area which need special protection from nuisance, such as: <ul style="list-style-type: none"> - Residential areas. - Areas where human activities are carried out (e.g. schools, day care centres, recreational areas, hospitals or nursing homes). - Sensitive ecosystems/habitats.
Slurry	Faeces and urine mixed or not with some litter material and some water to give a liquid manure with a dry matter content up to about 10 % that flows under gravity and can be pumped.
Solid manure	Faeces or droppings and urine mixed or not with litter material that do not flow under gravity and cannot be pumped.
Total ammoniacal nitrogen	Ammonium-N ($\text{NH}_4\text{-N}$) and its compounds, including uric acid, which are readily broken down to $\text{NH}_4\text{-N}$.
Total nitrogen	Total nitrogen, expressed as N, includes free ammonia and ammonium ($\text{NH}_4\text{-N}$), nitrites ($\text{NO}_2\text{-N}$), nitrates ($\text{NO}_3\text{-N}$) and organic nitrogen compounds.
Total nitrogen excreted	Total nitrogen eliminated from animal metabolic processes through urine and faeces.
Total phosphorus	Total phosphorus, expressed as P_2O_5 , includes all inorganic and organic phosphorus compounds, dissolved or bound to particles.
Total phosphorus excreted	Total phosphorus eliminated from animal metabolic processes through urine and faeces.
Waste water	Rainwater run-off commonly mixed with manure, water derived from the cleaning of surfaces (e.g. floors) and equipment, and water derived from the operation of air cleaning systems. This may also be referred to as soiled water.

Definitions for certain animal categories

Term used	Definition
Breeders	Parent stock (males and females) kept to lay eggs for hatching.
Broilers	Chickens reared for meat production.
Broiler breeders	Parent stock (males and females) kept to lay eggs for broilers production.
Farrowing sows	Sows between the perinatal period and the weaning of the piglets.
Fattening pigs	Production pigs typically reared from a live weight of 30 kg to slaughter or first service. This category includes growers, finishers and gilts that have not been serviced.
Gestating sows	Pregnant sows, including gilts.
Laying hens	Grown female chickens for egg production after 16 to 20 weeks of age.
Mating sows	Sows ready for service and before gestation.
Pig	An animal of the porcine species of any age, kept for breeding or fattening.
Piglets	Pigs from birth to weaning.
Poultry	Fowl (chickens), turkeys, guinea fowl, ducks, geese, quails, pigeons, pheasants and partridges reared or kept in captivity for breeding, the production of meat or eggs for consumption, or for restocking supplies of game.
Pullets	Young chickens below the age for laying eggs. When reared for egg production a pullet becomes a laying hen when it begins to lay eggs at 16 to 20 weeks of age. When reared for breeding, young female and male chickens are defined as pullets until 20 weeks of age.
Sows	Female pigs during the rearing periods of mating, gestating and farrowing.
Weaners	Young pigs reared from weaning until fattening, typically reared from a live weight of around 8 kg to 30 kg.

GENERAL CONSIDERATIONS

The techniques listed and described in these BAT conclusions are neither prescriptive nor exhaustive. Other techniques may be used that ensure at least an equivalent level of environmental protection.

Unless otherwise stated, the BAT conclusions are generally applicable.

Unless otherwise stated, emission levels associated with the best available techniques (BAT-AELs) for emissions to air given in these BAT conclusions refer to the mass of substances emitted per animal place, for all rearing cycles carried out during 1 year (i.e. kg substance/animal place/year).

All values for concentrations expressed as mass of emitted substance per volume in air refer to standard conditions (dry gas at a temperature of 273.15 K, and a pressure of 101.3 kPa).

5.1 General BAT conclusions

The sector-specific or process-specific BAT conclusions included in Sections 5.2 and 5.3 apply in addition to these general BAT conclusions.

5.1.1 Environmental management systems (EMS)

BAT 1. In order to improve the overall environmental performance of farms, BAT is to implement and adhere to an environmental management system (EMS) that incorporates all of the following features:

1. commitment of the management, including senior management;
2. definition, by the management, of an environmental policy that includes the continuous improvement of the environmental performance of the installation;
3. planning and establishing the necessary procedures, objectives and targets, in conjunction with financial planning and investment;
4. implementation of procedures paying particular attention to:
 - (a) structure and responsibility;
 - (b) training, awareness and competence;
 - (c) communication;
 - (d) employee involvement;
 - (e) documentation;
 - (f) effective process control;
 - (g) maintenance programmes;
 - (h) emergency preparedness and response;
 - (i) safeguarding compliance with environmental legislation.
5. checking performance and taking corrective action, paying particular attention to:
 - (a) monitoring and measurement (see also the JRC Reference Report on Monitoring of emissions from IED installations - ROM);
 - (b) corrective and preventive action;
 - (c) maintenance of records;
 - (d) independent (where practicable) internal or external auditing in order to determine whether or not the EMS conforms to planned arrangements and has been properly implemented and maintained;
6. review of the EMS and its continuing suitability, adequacy and effectiveness by senior management;
7. following the development of cleaner technologies;
8. consideration for the environmental impacts from the eventual decommissioning of the installation at the stage of designing a new plant, and throughout its operating life;
9. application of sectoral benchmarking (e.g. EMAS Sectoral Reference Document) on a regular basis.

Specifically for the intensive poultry or pig rearing sector, BAT is also to incorporate the following features in the EMS:

10. implementation of a noise management plan (see BAT 9);
11. implementation of an odour management plan (see BAT 12).

Technical considerations relevant to applicability

The scope (e.g. level of detail) and nature of the EMS (e.g. standardised or non-standardised) is related to the nature, scale and complexity of the farm, and the range of environmental impacts it may have.

5.1.2 Good housekeeping

BAT 2. In order to prevent or reduce the environmental impact and improve overall performance, BAT is to use all the techniques given below.

	Technique	Applicability
a	<p>Proper location of the plant/farm and spatial arrangements of the activities in order to:</p> <ul style="list-style-type: none"> • reduce transport of animals and materials (including manure); • ensure adequate distances from sensitive receptors requiring protection; • take into account prevailing climatic conditions (e.g. wind and precipitation); • consider the potential future development capacity of the farm; • prevent the contamination of water. 	May not be generally applicable to existing plants/farms.
b	<p>Educate and train staff, in particular for:</p> <ul style="list-style-type: none"> • relevant regulations, livestock farming, animal health and welfare, manure management, worker safety; • manure transport and landspreading; • planning of activities; • emergency planning and management; • repair and maintenance of equipment. 	Generally applicable.
c	<p>Prepare an emergency plan for dealing with unexpected emissions and incidents such as pollution of water bodies. This can include:</p> <ul style="list-style-type: none"> • a plan of the farm showing the drainage systems and water/effluent sources; • plans of action for responding to certain potential events (e.g. fires, leaking or collapsing of slurry stores, uncontrolled run-off from manure heaps, oil spillages); • available equipment for dealing with a pollution incident (e.g. equipment for plugging land drains, damming ditches, scum boards for oil spillages). 	Generally applicable.
d	<p>Regularly check, repair and maintain structures and equipment, such as:</p> <ul style="list-style-type: none"> • slurry stores for any sign of damage, degradation, leakage; • slurry pumps, mixers, separators, irrigators; • water and feed supply systems; • ventilation system and temperature sensors; • silos and transport equipment (e.g. valves, tubes); • air cleaning systems (e.g. by regular inspections). <p>This can include cleanliness of the farm and pest management.</p>	Generally applicable.
e	<p>Store dead animals in such a way as to prevent or reduce emissions.</p>	Generally applicable.

5.1.3 Nutritional management

BAT 3. In order to reduce total nitrogen excreted and consequently ammonia emissions while meeting the nutritional needs of the animals, BAT is to use a diet formulation and nutritional strategy which includes one or a combination of the techniques given below.

	Technique ⁽¹⁾	Applicability
a	Reduce the crude protein content by using a N-balanced diet based on the energy needs and digestible amino acids.	Generally applicable.
b	Multiphase feeding with a diet formulation adapted to the specific requirements of the production period.	Generally applicable.
c	Addition of controlled amounts of essential amino acids to a low crude protein diet.	Applicability may be restricted when low-protein feedstuffs are not economically available. Synthetic amino acids are not applicable to organic livestock production.
d	Use of authorised feed additives which reduce the total nitrogen excreted.	Generally applicable.
⁽¹⁾ A description of the techniques is given in Section 5.4.10.1. Information on the effectiveness of the techniques for ammonia emission reduction can be taken from recognised European or international guidance e.g. UNECE guidance document on 'Options for ammonia mitigation'.		

Table 5.1: BAT-associated total nitrogen excreted

Parameter	Animal category	BAT-associated total nitrogen excreted ⁽¹⁾ ⁽²⁾ (kg N excreted/animal place/year)
Total nitrogen excreted, expressed as N.	Weaners	1.5–4.0
	Fattening pigs	7.0–13.0
	Sows (including piglets)	17.0–30.0
	Laying hens	0.4–0.8
	Broilers	0.2–0.6
	Ducks	0.4–0.8
	Turkeys	1.0–2.3 ⁽³⁾
⁽¹⁾ The lower end of the range can be achieved by using a combination of techniques. ⁽²⁾ The BAT-associated total nitrogen excreted is not applicable to pullets or breeders, for all poultry species. ⁽³⁾ The upper end of the range is associated with the rearing of male turkeys.		

The associated monitoring is in BAT 24. The BAT-associated total nitrogen excreted levels may not be applicable to organic livestock production and to the rearing of poultry species not indicated above.

BAT 4. In order to reduce the total phosphorus excreted, while meeting the nutritional needs of the animals, BAT is to use a diet formulation and a nutritional strategy which includes one or a combination of the techniques given below.

	Technique ⁽¹⁾	Applicability
a	Multiphase feeding with a diet formulation adapted to the specific requirements of the production period.	Generally applicable.
b	Use of authorised feed additives which reduce the total phosphorus excreted (e.g. phytase).	Phytase may not be applicable in case of organic livestock production.
c	Use of highly digestible inorganic phosphates for the partial replacement of conventional sources of phosphorus in the feed.	Generally applicable within the constraints associated with the availability of highly digestible inorganic phosphates.

(¹) A description of the techniques is given in Section 5.4.10.2.

Table 5.2: BAT-associated total phosphorus excreted

Parameter	Animal category	BAT-associated total phosphorus excreted ⁽¹⁾ ⁽²⁾ (kg P ₂ O ₅ excreted/animal place/year)
Total phosphorus excreted, expressed as P ₂ O ₅ .	Weaners	1.2–2.2
	Fattening pigs	3.5–5.4
	Sows (including piglets)	9.0–15.0
	Laying hens	0.10–0.45
	Broilers	0.05–0.25
	Turkeys	0.15–1.0

(¹) The lower end of the range can be achieved by using a combination of techniques.
(²) The BAT-associated total phosphorus excreted is not applicable to pullets or breeders, for all poultry species.

The associated monitoring is in BAT 24. The BAT-associated total phosphorus excreted levels may not be applicable to organic livestock production and to the rearing of poultry species not indicated above.

5.1.4 Efficient use of water

BAT 5. In order to use water efficiently, BAT is to use a combination of the techniques given below.

	Technique	Applicability
a	Keep a record of water use.	Generally applicable.
b	Detect and repair water leakages.	Generally applicable.
c	Use high-pressure cleaners for cleaning animal housing and equipment.	Not applicable to poultry plants using dry cleaning systems.
d	Select and use suitable equipment (e.g. nipple drinkers, round drinkers, water troughs) for the specific animal category while ensuring water availability (<i>ad libitum</i>).	Generally applicable.
e	Verify and (if necessary) adjust on a regular basis the calibration of the drinking water equipment.	Generally applicable.
f	Reuse uncontaminated rainwater as cleaning water.	May not be applicable to existing farms, due to high costs. Applicability may be restricted by biosecurity risks.

5.1.5 Emissions from waste water

BAT 6. In order to reduce the generation of waste water, BAT is to use a combination of the techniques given below.

	Technique ⁽¹⁾	Applicability
a	Keep the fouled yard areas as small as possible.	Generally applicable.
b	Minimise use of water.	Generally applicable.
c	Segregate uncontaminated rainwater from waste water streams that require treatment.	May not be applicable to existing farms.
⁽¹⁾ A description of the technique is given in Section 5.4.1.		

BAT 7. In order to reduce emissions to water from waste water, BAT is to use one or a combination of the techniques given below.

	Technique ⁽¹⁾	Applicability
a	Drain waste water to a dedicated container or to a slurry store.	Generally applicable.
b	Treat waste water.	Generally applicable.
c	Landspreading of waste water e.g. by using an irrigation system such as sprinkler, travelling irrigator, tanker, umbilical injector.	Applicability may be restricted due to the limited availability of suitable land adjacent to the farm. Applicable only for waste water with a proven low level of contamination.
⁽¹⁾ A description of the techniques is given in Section 5.4.1.		

5.1.6 Efficient use of energy

BAT 8. In order to use energy efficiently in a farm, BAT is to use a combination of the techniques given below.

	Technique ⁽¹⁾	Applicability
a	High efficiency heating/cooling and ventilation systems.	May not be applicable to existing plants.
b	Optimisation of heating/cooling and ventilation systems and management, especially where air cleaning systems are used.	Generally applicable.
c	Insulation of the walls, floors and/or ceilings of animal housing.	May not be applicable to plants using natural ventilation. Insulation may not be applicable to existing plants due to structural restrictions.
d	Use of energy-efficient lighting.	Generally applicable.
e	Use of heat exchangers. One of the following systems may be used: 1. air-air; 2. air-water; 3. air-ground.	Air-ground heat exchangers are only applicable when there is available space due to the need for a large soil surface.
f	Use of heat pumps for heat recovery.	The applicability of heat pumps based on geothermal heat recovery is limited when using horizontal pipes due to the need for space availability.
g	Heat recovery with heated and cooled littered floor (combideck system).	Not applicable to pig plants. Applicability depends on the possibility to install closed underground storage for the circulating water.
h	Apply natural ventilation.	Not applicable to plants with a centralised ventilation system. In pig plants, this may not be applicable to: - housing systems with littered floors in warm climates; - housing systems without littered floors or without covered, insulated boxes (e.g. kennels) in cold climates. In poultry plants, this may not be applicable: - during the initial stage of rearing, apart from duck production; - due to extreme climate conditions.

⁽¹⁾ A description of the techniques is given in Section 5.4.2.

5.1.7 Noise emissions

BAT 9. In order to prevent or, where that is not practicable, to reduce noise emissions, BAT is to set up and implement a noise management plan, as part of the environmental management system (see BAT 1), that includes the following elements:

- i. a protocol containing appropriate actions and timelines;
- ii. a protocol for conducting noise monitoring;
- iii. a protocol for response to identified noise events;
- iv. a noise reduction programme designed to e.g. identify the source(s), to monitor noise emissions, to characterise the contributions of the sources and to implement elimination and/or reduction measures;
- v. a review of historical noise incidents and remedies and the dissemination of noise incident knowledge.

Applicability

BAT 9 is only applicable to cases where a noise nuisance at sensitive receptors is expected and/or has been substantiated.

BAT 10. In order to prevent, or where that is not practicable, to reduce noise emissions, BAT is to use one or a combination of the techniques given below.

	Technique	Description	Applicability
a	Ensure adequate distances between the plant/farm and the sensitive receptors.	At the planning stage of the plant/farm, adequate distances between the plant/farm and the sensitive receptors are ensured by applying minimum standard distances.	May not be generally applicable to existing plants/farms.
b	Equipment location.	Noise levels can be reduced by: <ul style="list-style-type: none"> i. increasing the distance between the emitter and the receiver (by locating equipment as far away as practicable from sensitive receptors); ii. minimising the length of feed delivery pipes; iii. Locating feed bins and feed silos so as to minimise the movement of vehicles on the farm. 	In the case of existing plants, the relocation of equipment may be restricted by the lack of space or excessive costs.
c	Operational measures.	These include measures, such as: <ul style="list-style-type: none"> i. closure of doors and major openings of the building, especially during feeding time, if possible; ii. equipment operation by experienced staff; iii. avoidance of noisy activities at night and during weekends, if possible; iv. provisions for noise control during maintenance activities; v. operate conveyers and augers full of feed, if possible; vi. keep outdoor scraped areas to a minimum in order to reduce noise from scraper tractors. 	Generally applicable.
d	Low-noise equipment.	This includes equipment, such as: <ul style="list-style-type: none"> i. high efficiency fans, when natural ventilation is not possible or sufficient; ii. pumps and compressors; iii. feeding system which reduces the pre-feeding stimulus (e.g. holding hoppers, passive ad libitum feeders, compact feeders). 	BAT 7.d.iii is only applicable to pig plants. Passive <i>ad libitum</i> feeders are only applicable when the equipment is new or replaced or when animals do not require a restricted feeding.
e	Noise-control equipment.	This includes: <ul style="list-style-type: none"> i. noise reducers; ii. vibration isolation; iii. enclosure of noisy equipment (e.g. mills, pneumatic conveyers); iv. soundproofing of buildings. 	Applicability may be restricted due to space requirements, and health and safety issues. Not applicable to noise-absorbent materials impeding the effective cleaning of the plant.
f	Noise abatement.	Noise propagation can be reduced by inserting obstacles between emitters and receivers.	May not be generally applicable due to biosecurity reasons.

5.1.8 Dust emissions

BAT 11. In order to reduce dust emissions from each animal house, BAT is to use one or a combination of the techniques given below.

	Technique ⁽¹⁾	Applicability
a	Reduce dust generation inside livestock buildings. For this purpose, a combination of the following techniques may be used:	
	1. Use coarser litter material (e.g. long straw or wood shavings rather than chopped straw);	Long straw is not applicable to slurry-based systems.
	2. Apply fresh litter using a low-dust littering technique (e.g. by hand);	Generally applicable.
	3. Apply <i>ad libitum</i> feeding;	Generally applicable.
	4. Use moist feed, pelleted feed or add oily raw materials or binders in dry feed systems;	Generally applicable.
	5. Equip dry feed stores which are filled pneumatically with dust separators;	Generally applicable.
	6. Design and operate the ventilation system with low air speed within the house.	Applicability may be limited by animal welfare considerations.
b	Reduce dust concentration inside housing by applying one of the following techniques:	
	1. Water fogging;	Applicability may be restricted by the animal sensation of thermal decrease during fogging, in particular at sensitive stages of the animal's life, and/or for cold and humid climates. Applicability may be also restricted for solid manure systems at the end of the rearing period due to high ammonia emissions.
	2. Oil spraying;	Only applicable to poultry plants with birds older than around 21 days. The applicability to plants for laying hens may be limited due to the risk of contamination of the equipment present in the shed.
	3. Ionisation.	May not be applicable to pig plants or to existing poultry plants due to technical and/or economic reasons.
c	Treatment of exhaust air by an air cleaning system, such as:	
	1. Water trap;	Only applicable to plants with a tunnel ventilation system.
	2. Dry filter;	Only applicable to poultry plants with a tunnel ventilation system.
	3. Water scrubber;	This technique may not be generally applicable due to the high implementation cost.
	4. Wet acid scrubber;	
	5. Bioscrubber (or biotrickling filter);	
	6. Two-stage or three-stage air cleaning system;	Applicable to existing plants only where a centralised ventilation system is used.
	7. Biofilter.	Only applicable to slurry-based plants. A sufficient area outside the animal house is needed to accommodate the filter packages. This technique may not be generally applicable due to the high implementation cost. Applicable to existing plants only where a centralised ventilation system is used.
⁽¹⁾ A description of the techniques is given in Sections 5.4.3 and 5.4.11.		

5.1.9 Odour emissions

BAT 12. In order to prevent, or where that is not practicable, to reduce odour emissions from a farm, BAT is to set up, implement and regularly review an odour management plan, as part of the environmental management system (see BAT 1), that includes the following elements:

- i. a protocol containing appropriate actions and timelines;
- ii. a protocol for conducting odour monitoring;
- iii. a protocol for response to identified odour nuisance;
- iv. an odour prevention and elimination programme designed to e.g. identify the source(s), to monitor odour emissions (see BAT 26), to characterise the contributions of the sources and to implement elimination and/or reduction measures;
- v. a review of historical odour incidents and remedies and the dissemination of odour incident knowledge.

The associated monitoring is in BAT 26.

Applicability

BAT 12 is only applicable to cases where an odour nuisance at sensitive receptors is expected and/or has been substantiated.

BAT 13. In order to prevent or, where that is not practicable, to reduce odour emissions and/or odour impact from a farm, BAT is to use a combination of the techniques given below.

	Technique (1)	Applicability
a	Ensure adequate distances between the farm/plant and the sensitive receptors.	May not be generally applicable to existing farms/plants.
b	Use a housing system which implements one or a combination of the following principles: <ul style="list-style-type: none"> - keeping the animals and the surfaces dry and clean (e.g. avoid feed spillages, avoid dung in lying areas of partly slatted floors); - reducing the emitting surface of manure (e.g. use metal or plastic slats, channels with a reduced exposed manure surface); - removing manure frequently to an external (covered) manure store; - reducing the temperature of the manure (e.g. by slurry cooling) and of the indoor environment; - decreasing the air flow and velocity over the manure surface; - keeping the litter dry and under aerobic conditions in litter-based systems. 	Decreasing the temperature of the indoor environment, the air flow and the velocity may not be applicable due to animal welfare considerations. Slurry removal by flushing is not applicable to pig farms located close to sensitive receptors due to odour peaks. See applicability for animal housing in BAT 30, BAT 31, BAT 32, BAT 33 and BAT 34.
c	Optimise the discharge conditions of exhaust air from the animal house by using one or a combination of the following techniques: <ul style="list-style-type: none"> - increasing the outlet height (e.g. exhaust air above roof level, stacks, divert air exhaust through the ridge instead of through the low part of the walls); - increasing the vertical outlet ventilation velocity; - effective placement of external barriers to create turbulence in the outgoing air flow (e.g. vegetation); - adding deflector covers in exhaust apertures located in low parts of walls in order to divert exhaust air towards the ground; 	Alignment of the ridge axis is not applicable to existing plants.

	Technique ⁽¹⁾	Applicability
	<ul style="list-style-type: none"> - dispersing the exhaust air at the housing side which faces away from the sensitive receptor; - aligning the ridge axis of a naturally ventilated building transversally to the prevailing wind direction. 	
d	Use an air cleaning system, such as: <ol style="list-style-type: none"> 1. Bioscrubber (or biotrickling filter); 2. Biofilter; 3. Two-stage or three-stage air cleaning system. 	This technique may not be generally applicable due to the high implementation cost. Applicable to existing plants only where a centralised ventilation system is used. A biofilter is only applicable to slurry-based plants. For a biofilter, a sufficient area outside the animal house is needed to accommodate the filter packages.
e	Use one or a combination of the following techniques for storage of manure:	
	1. Cover slurry or solid manure during storage;	See applicability of BAT 16.b for slurry. See applicability of BAT 14.b for solid manure.
	2. Locate the store taking into account the general wind direction and/or adopt measures to reduce wind speed around and above the store (e.g. trees, natural barriers);	Generally applicable.
	3. Minimise stirring of slurry.	Generally applicable.
f	Process manure with one of the following techniques in order to minimise odour emissions during (or prior to) landspreading:	
	1. Aerobic digestion (aeration) of slurry;	See applicability of BAT 19.d.
	2. Compost solid manure;	See applicability of BAT 19.f.
	3. Anaerobic digestion.	See applicability of BAT 19.b.
g	Use one or a combination of the following techniques for manure landspreading:	
	1. Band spreader, shallow injector or deep injector for slurry landspreading;	See applicability of BAT 21.b, BAT 21.c or BAT 21.d.
	2. Incorporate manure as soon as possible.	See applicability of BAT 22.
⁽¹⁾ A description of the techniques is given in Sections 5.4.4 and 5.4.11.		

5.1.10 Emissions from solid manure storage

BAT 14. In order to reduce ammonia emissions to air from the storage of solid manure, BAT is to use one or a combination of the techniques given below.

	Technique ⁽¹⁾	Applicability
a	Reduce the ratio between the emitting surface area and the volume of the solid manure heap.	Generally applicable.
b	Cover solid manure heaps.	Generally applicable when solid manure is dried or pre-dried in animal housing. May not be applicable to not dried solid manure in case of frequent addition to the heap.
c	Store dried solid manure in a barn.	Generally applicable.
⁽¹⁾ A description of the techniques is given in Section 5.4.5.		

BAT 15. In order to prevent, or where that is not practicable, to reduce emissions to soil and water from the storage of solid manure, BAT is to use a combination of the techniques given below in the following order of priority.

	Technique ⁽¹⁾	Applicability
a	Store dried solid manure in a barn.	Generally applicable
b	Use a concrete silo for storage of solid manure.	Generally applicable.
c	Store solid manure on solid impermeable floor equipped with a drainage system and a collection tank for the run-off.	Generally applicable.
d	Select a storage facility with a sufficient capacity to hold the solid manure during periods in which landspreading is not possible.	Generally applicable.
e	Store solid manure in field heaps placed away from surface and/or underground watercourses which liquid run-off might enter.	Only applicable to temporary field heaps which change location each year.
⁽¹⁾ A description of the techniques is given in Section 5.4.5.		

5.1.11 Emissions from slurry storage

BAT 16. In order to reduce ammonia emissions to air from a slurry store, BAT is to use a combination of the techniques given below.

	Technique ⁽¹⁾	Applicability
a	Appropriate design and management of the slurry store by using a combination of the following techniques:	
	1. Reduce the ratio between the emitting surface area and the volume of the slurry store;	May not be generally applicable to existing stores. Excessively high slurry stores may not be applicable due to increased costs and safety risks.
	2. Reduce wind velocity and air exchange on the slurry surface by operating the store at a lower level of fill;	May not be generally applicable to existing stores.
	3. Minimise stirring of slurry.	Generally applicable.
b	Cover the slurry store. For this purpose, one of the following techniques may be used:	
	1. Rigid cover;	May not be applicable to existing plants due to economic considerations and structural limitations to withstand the extra load.
	2. Flexible covers;	Flexible covers are not applicable to areas where prevailing weather conditions can compromise their structure.
	3. Floating covers such as: <ul style="list-style-type: none"> • plastic pellets; • light bulk materials; • floating flexible covers; • geometrical plastic tiles; • air-inflated cover; • natural crust; • straw. 	The use of plastic pellets, light bulk materials and geometrical plastic tiles is not applicable to naturally crusting slurries. Agitation of the slurry during stirring, filling and emptying may preclude the use of some floating materials which may cause sedimentation or blockages in the pumps. Natural crust formation may not be applicable to cold climates and/or to slurry with low dry matter content. Natural crust is not applicable to stores where stirring, filling and/or discharging of slurry renders the natural crust unstable.
c	Slurry acidification.	Generally applicable.
⁽¹⁾ A description of the techniques is given in Sections 5.4.6.1 and 5.4.12.3.		

BAT 17. In order to reduce ammonia emissions to air from an earth-banked slurry store (lagoon), BAT is to use a combination of the techniques given below.

	Technique ⁽¹⁾	Applicability
a	Minimise stirring of the slurry.	Generally applicable.
b	Cover the earth-banked slurry store (lagoon) with a flexible and/or floating cover such as: <ul style="list-style-type: none"> • flexible plastic sheets; • light bulk materials; • natural crust; • straw. 	Plastic sheets may not be applicable to large existing lagoons due to structural reasons. Straw and light bulk materials may not be applicable to large lagoons where wind drift does not permit the lagoon surface to be kept fully covered. The use of light bulk materials is not applicable to naturally crusting slurries. Agitation of the slurry during stirring, filling and emptying may preclude the use of some floating materials which may cause sedimentation or blockages in the pumps. Natural crust formation may not be applicable to cold climates and/or to slurry with low dry matter content. Natural crust is not applicable to lagoons where stirring, filling and/or discharging of slurry renders the natural crust unstable.
⁽¹⁾ A description of the techniques is given in Section 5.4.6.1.		

BAT 18. In order to prevent emissions to soil and water from slurry collection, piping, and from a store and/or an earth-banked storage (lagoon), BAT is to use a combination of the techniques given below.

	Technique ⁽¹⁾	Applicability
a	Use stores that are able to withstand mechanical, chemical and thermal influences.	Generally applicable.
b	Select a storage facility with a sufficient capacity to hold the slurry during periods in which landspreading is not possible.	Generally applicable.
c	Construct leak-proof facilities and equipment for collection and transfer of slurry (e.g. pits, channels, drains, pump stations).	Generally applicable.
d	Store slurry in earth-banked stores (lagoons) with an impermeable base and walls e.g. with clay or plastic lining (or double-lined).	Generally applicable to lagoons.
e	Install a leakage detection system, e.g. consisting of a geomembrane, a drainage layer and a drainage pipe system.	Only applicable to new plants.
f	Check structural integrity of stores at least once every year.	Generally applicable.
⁽¹⁾ A description of the techniques is given in Section 5.4.6.2.		

5.1.12 On farm processing of manure

BAT 19. If on-farm processing of manure is used, in order to reduce emissions of nitrogen, phosphorus, odour and microbial pathogens to air and water and facilitate manure storage and/or landspreading, BAT is to process the manure by applying one or a combination of the techniques given below.

	Technique ⁽¹⁾	Applicability
a	Mechanical separation of slurry. This includes e.g.: <ul style="list-style-type: none"> • Screw press separator; • Decanter-centrifuge separator; • Coagulation- Flocculation; • Separation by sieves; • Filter pressing. 	Only applicable when: <ul style="list-style-type: none"> - a reduction of nitrogen and phosphorus content is needed due to limited available land for manure application; - manure cannot be transported for landspreading at a reasonable cost. The use of polyacrylamide as a flocculant may not be applicable due to the risk of acrylamide formation.
b	Anaerobic digestion of manure in a biogas installation.	This technique may not be generally applicable due to the high implementation cost.
c	Use of an external tunnel for manure drying.	Only applicable to manure from plants for laying hens. Not applicable to existing plants without manure belts.
d	Aerobic digestion (aeration) of slurry.	Only applicable when pathogen and odour reduction is important prior to landspreading. In cold climates, it may be difficult to maintain the required level of aeration during winter.
e	Nitrification-denitrification of slurry.	Not applicable to new plants/farms. Only applicable to existing plants/farms when the removal of nitrogen is necessary due to limited available land for manure application.
f	Composting of solid manure.	Only applicable when: <ul style="list-style-type: none"> - manure cannot be transported for landspreading at a reasonable cost; - pathogen and odour reduction is important prior to landspreading; - there is enough space in the farm for windrows to be established.
⁽¹⁾ A description of the techniques is given in Section 5.4.7		

5.1.13 Manure landspreading

BAT 20. In order to prevent or, where that is not practicable, to reduce emissions of nitrogen, phosphorus and microbial pathogens to soil and water from manure landspreading, BAT is to use all the techniques given below.

	Technique
a	Assess the manure receiving land to identify risks of run-off, taking into account: <ul style="list-style-type: none"> • soil type, conditions and slope of the field; • climatic conditions; • field drainage and irrigation; • crop rotations; • water resources and water protected zones.
b	Keep sufficient distance between manure spreading fields (leaving an untreated strip of land) and: <ol style="list-style-type: none"> 1. areas where there is a risk of run-off to water such as watercourses, springs, boreholes, etc.; 2. neighbouring properties (including hedges).
c	Avoid manure spreading when the risk of run-off can be significant. In particular, manure is not applied when: <ol style="list-style-type: none"> 1. the field is flooded, frozen or snow-covered; 2. soil conditions (e.g. water saturation or compaction) in combination with the slope of the field and/or field drainage are such that the risk of run-off or drainage is high; 3. run-off can be anticipated according to expected rainfall events.
d	Adapt the manure landspreading rate taking into account the nitrogen and phosphorus content of the manure and taking into account the characteristics of the soil (e.g. nutrient content), the seasonal crop requirements and weather or field conditions that could cause run-off.
e	Synchronize manure landspreading with the nutrient demand of crops.
f	Check the spreading fields at regular intervals to identify any sign of run-off and properly respond when necessary.
g	Ensure adequate access to the manure store and that loading of manure can be done effectively without spillage.
h	Check that machinery for manure landspreading is in good working order and set at the proper application rate.

BAT 21. In order to reduce ammonia emissions to air from slurry landspreading, BAT is to use one or a combination of the techniques given below.

	Technique ⁽¹⁾	Applicability
a	Slurry dilution, followed by techniques such as low-pressure water irrigation system.	Not applicable to crops grown to be eaten raw due to the risk of contamination. Not applicable when the soil type does not allow rapid infiltration of dilute slurry into the soil. Not applicable when crops do not require irrigation. Applicable to fields easily connected to the farm by pipework.
b	Band spreader, by applying one of the following techniques: <ol style="list-style-type: none"> 1. Trailing hose; 2. Trailing shoe. 	Applicability may be limited when the straw content of the slurry is too high or when the dry matter content of the slurry is higher than 10 %. Trailing shoe is not applicable to growing solid-seeded arable crops.
c	Shallow injector (open slot).	Not applicable on stony, shallow or compacted soil where it is difficult to achieve a uniform penetration. Applicability may be limited where crops may be damaged by machinery.
d	Deep injector (closed slot).	Not applicable on stony, shallow or compacted soil where it is difficult to achieve a uniform penetration and an effective slit closure. Not applicable during the vegetation of the crops. Not applicable on grassland, unless changing to arable land or when reseeding.
e	Slurry acidification.	Generally applicable.

⁽¹⁾ A description of the techniques is given in Sections 5.4.8.1 and 5.4.12.3.

BAT 22. In order to reduce ammonia emissions to air from manure landspreading, BAT is to incorporate the manure into the soil as soon as possible.

Description

Incorporation of manure spread on the soil surface is done by either ploughing or using other cultivation equipment, such as tines or disc harrows, depending on the soil type and conditions. Manure is completely mixed with soil or buried.

Solid manure spreading is carried out by a suitable spreader (e.g. rota-spreader, rear discharge spreader, dual-purpose spreader). Slurry landspreading is carried out according to BAT 21.

Applicability

Not applicable to grassland and conservation tillage, unless changing to arable land or when reseeded. Not applicable to cultivated land with crops that can be damaged by the incorporation of manure. Incorporation of slurry is not applicable after landspreading using shallow or deep injectors.

Table 5.3: BAT-associated time delay between manure landspreading and incorporation into the soil

Parameter	BAT-associated time delay between manure landspreading and incorporation into the soil (hours)
Time	0 ⁽¹⁾ –4 ⁽²⁾
⁽¹⁾ The lower end of the range corresponds to immediate incorporation. ⁽²⁾ The upper end of the range can be up to 12 hours when conditions are not favourable for a faster incorporation, e.g. when human and machinery resources are not economically available.	

5.1.14 Emissions from the whole production process

BAT 23. In order to reduce ammonia emissions from the whole production process for the rearing of pigs (including sows) or poultry, BAT is to estimate or calculate the reduction of ammonia emissions from the whole production process using the BAT implemented on the farm.

5.1.15 Monitoring of emissions and process parameters

BAT 24. BAT is to monitor the total nitrogen and total phosphorus excreted in manure using one of the following techniques with at least the frequency given below.

	Technique ⁽¹⁾	Frequency	Applicability
a	Calculation by using a mass balance of nitrogen and phosphorus based on the feed intake, crude protein content of the diet, total phosphorus and animal performance.	Once every year for each animal category.	Generally applicable.
b	Estimation by using manure analysis for total nitrogen and total phosphorus content.		
⁽¹⁾ A description of the techniques is given in Section 5.4.9.1.			

BAT 25. BAT is to monitor ammonia emissions to air using one of the following techniques with at least the frequency given below.

	Technique ⁽¹⁾	Frequency	Applicability
a	Estimation by using a mass balance based on the excretion and the total (or total ammoniacal) nitrogen present at each manure management stage.	Once every year for each animal category.	Generally applicable.
b	Calculation by measuring the ammonia concentration and the ventilation rate using ISO, national or international standard methods or other methods ensuring data of an equivalent scientific quality.	Every time there are significant changes to at least one of the following parameters: (a) the type of livestock reared at the farm; (b) the housing system.	Only applicable to emissions from each animal house. Not applicable to plants with an air cleaning system installed. In this case, BAT 28 applies. Due to the cost of measurements, this technique may not be generally applicable.
c	Estimation by using emission factors.	Once every year for each animal category.	Generally applicable.

⁽¹⁾ A description of the techniques is given in Section 5.4.9.2.

BAT 26. BAT is to periodically monitor odour emissions to air.

Description

Odour emissions can be monitored by using:

- EN standards (e.g. by using dynamic olfactometry according to EN 13725 in order to determine odour concentration).
- When applying alternative methods for which no EN standards are available (e.g. measurement/estimation of odour exposure, estimation of odour impact), ISO, national or other international standards that ensure the provision of data of an equivalent scientific quality can be used.

Applicability

BAT 26 is only applicable to cases where an odour nuisance at sensitive receptors is expected and/or has been substantiated.

BAT 27. BAT is to monitor dust emissions from each animal house using one of the following techniques with at least the frequency given below.

	Technique ⁽¹⁾	Frequency	Applicability
a	Calculation by measuring the dust concentration and the ventilation rate using EN standard methods or other methods (ISO, national or international) ensuring data of an equivalent scientific quality.	Once every year.	Only applicable to dust emissions from each animal house. Not applicable to plants with an air cleaning system installed. In this case, BAT 28 applies. Due to the cost of measurements, this technique may not be generally applicable.
b	Estimation by using emission factors.	Once every year.	Due to the cost of establishing emissions factors, this technique may not be generally applicable.

⁽¹⁾ A description of the techniques is given in Section 5.4.9.2.

BAT 28. BAT is to monitor, ammonia, dust and/or odour emissions from each animal house equipped with an air cleaning system by using all of the following techniques with at least the frequency given below.

	Technique ⁽¹⁾	Frequency	Applicability
a	Verification of the air cleaning system performance by measuring ammonia, odour and/or dust under practical farm conditions and according to a prescribed measurement protocol and using EN standard methods or other methods (ISO, national or international) ensuring data of an equivalent scientific quality.	Once	Not applicable if the air cleaning system has been verified in combination with a similar housing system and operating conditions.
b	Control of the effective function of the air cleaning system (e.g. by continuously recording operational parameters or using alarm systems).	Daily	Generally applicable.

⁽¹⁾ A description of the techniques is given in Section 5.4.9.3.

BAT 29. BAT is to monitor the following process parameters at least once every year.

	Parameter	Description	Applicability
a	Water consumption.	Recording using e.g. suitable meters or invoices. The main water-consuming processes in animal houses (cleaning, feeding, etc.) can be monitored separately.	Monitoring the main water-consuming processes separately may not be applicable to existing farms, depending on the configuration of the water supply network.
b	Electric energy consumption.	Recording using e.g. suitable meters or invoices. Electricity consumption of animal houses is monitored separately from other plants in the farm. The main energy-consuming processes in animal houses (heating, ventilation, lighting, etc.) can be monitored separately.	Monitoring the main energy-consuming processes separately may not be applicable to existing farms, depending on the configuration of the energy supply network.
c	Fuel consumption.	Recording using e.g. suitable meters or invoices.	Generally applicable.
d	Number of incoming and outgoing animals, including births and deaths when relevant.	Recording using e.g. existing registers.	
e	Feed consumption.	Recording using e.g. invoices or existing registers.	
f	Manure generation.	Recording using e.g. existing registers.	

5.2 BAT conclusions for the intensive rearing of pigs

5.2.1 Ammonia emissions from pig houses

BAT 30. In order to reduce ammonia emissions to air from each pig house, BAT is to use one or a combination of the techniques given below.

	Technique ⁽¹⁾	Animal category	Applicability
a	One of the following techniques, which apply one or a combination of the following principles: i) reduce the ammonia emitting surface; ii) increase the frequency of slurry (manure) removal to external storage; iii) separate urine from faeces; iv) keep litter clean and dry.		
	0. A deep pit (in case of a fully or partly slatted floor) only if used in combination with an additional mitigation measure, e.g.: - a combination of nutritional management techniques; - air cleaning system; - pH reduction of the slurry; - slurry cooling.	All pigs	Not applicable to new plants, unless a deep pit is combined with an air cleaning system, slurry cooling and/or pH reduction of the slurry.
	1. A vacuum system for frequent slurry removal (in case of a fully or partly slatted floor).	All pigs	May not be generally applicable to existing plants due to technical and/or economic considerations.
	2. Slanted walls in the manure channel (in case of a fully or partly slatted floor).	All pigs	
	3. A scraper for frequent slurry removal (in case of a fully or partly slatted floor).	All pigs	
	4. Frequent slurry removal by flushing (in case of a fully or partly slatted floor).	All pigs	May not be generally applicable to existing plants due to technical and/or economic considerations. When the liquid fraction of the slurry is used for flushing, this technique may not be applicable to farms located close to sensitive receptors due to odour peaks during flushing.
	5. Reduced manure pit (in case of a partly slatted floor).	Mating and gestating sows	May not be generally applicable to existing plants due to technical and/or economic considerations.
		Fattening pigs	
	6. Full litter system (in case of a solid concrete floor).	Mating and gestating sows	Solid manure systems are not applicable to new plants unless it can be justified for animal welfare reasons. May not be applicable to naturally ventilated plants located in warm climates and to existing plants with forced ventilation for weaners and fattening pigs. BAT 30.a7 may require large space availability.
		Weaners	
		Fattening pigs	
	7. Kennel / hut housing (in case of a partly slatted floor).	Mating and gestating sows	
		Weaners	
		Fattening pigs	

	Technique ⁽¹⁾	Animal category	Applicability
	8. Straw flow system (in case of a solid concrete floor).	Weaners	
		Fattening pigs	
	9. Convex floor and separated manure and water channels (in case of partly slatted pens).	Weaners	May not be generally applicable to existing plants due to technical and/or economic considerations.
		Fattening pigs	
	10. Littered pens with combined manure generation (slurry and solid manure).	Farrowing sows	
	11. Feeding/lying boxes on solid floor (in case of litter-based pens).	Mating and gestating sows	Not applicable to existing plants without solid concrete floors.
	12. Manure pan (in case of a fully or partly slatted floor).	Farrowing sows	Generally applicable.
	13. Manure collection in water.	Weaners	May not be generally applicable to existing plants due to technical and/or economic considerations.
		Fattening pigs	
	14. V-shaped manure belts (in case of partly slatted floor).	Fattening pigs	
	15. A combination of water and manure channels (in case of a fully slatted floor).	Farrowing sows	
	16. Littered external alley (in case of a solid concrete floor).	Fattening pigs	Not applicable to cold climates. May not be generally applicable to existing plants due to technical and/or economic considerations.
b	Slurry cooling.	All pigs	Not applicable when: - heat reuse is not possible; - litter is used.
c	Use of an air cleaning system, such as: 1. Wet acid scrubber; 2. Two-stage or three-stage air cleaning system; 3. Bioscrubber (or biotrickling filter).	All pigs	May not be generally applicable due to the high implementation cost. Applicable to existing plants only where a centralised ventilation system is used.
d	Slurry acidification.	All pigs	Generally applicable.
e	Use of floating balls in the manure channel.	Fattening pigs	Not applicable to plants equipped with pits that have slanted walls and to plants that apply slurry removal by flushing.
⁽¹⁾ A description of the techniques is given in Sections 5.4.11 and 5.4.12.			

Table 5.4: BAT-AEL for ammonia emissions to air from each pig house

Parameter	Animal category	BAT-AEL ⁽¹⁾ (kg NH ₃ /animal place/year)
Ammonia expressed as NH ₃	Mating and gestating sows	0.2–2.7 ⁽²⁾ ⁽³⁾
	Farrowing sows (including piglets) in crates	0.4–5.6 ⁽⁴⁾
	Weaners	0.03–0.53 ⁽⁵⁾ ⁽⁶⁾
	Fattening pigs	0.1–2.6 ⁽⁷⁾ ⁽⁸⁾

⁽¹⁾ The lower end of the range is associated with the use of an air cleaning system.
⁽²⁾ For existing plants using a deep pit in combination with nutritional management techniques, the upper end of the BAT-AEL is 4.0 kg NH₃/animal place/year.
⁽³⁾ For plants using BAT 30.a6, 30.a7 or 30.a11, the upper end of the BAT-AEL is 5.2 kg NH₃/animal place/year.
⁽⁴⁾ For existing plants using BAT 30.a0 in combination with nutritional management techniques, the upper end of the BAT-AEL is 7.5 kg NH₃/animal place/year.
⁽⁵⁾ For existing plants using a deep pit in combination with nutritional management techniques, the upper end of the BAT-AEL is 0.7 kg NH₃/animal place/year.
⁽⁶⁾ For plants using BAT 30.a6, 30.a7 or 30.a8, the upper end of the BAT-AEL is 0.7 kg NH₃/animal place/year.
⁽⁷⁾ For existing plants using a deep pit in combination with nutritional management techniques, the upper end of the BAT-AEL is 3.6 kg NH₃/animal place/year.
⁽⁸⁾ For plants using BAT 30.a6, 30.a7, 30.a8 or 30.a16, the upper end of the BAT-AEL is 5.65 kg NH₃/animal place/year.

The BAT-AELs may not be applicable to organic livestock production. The associated monitoring is in BAT 25.

5.3 BAT conclusions for the intensive rearing of poultry

5.3.1 Ammonia emissions from poultry houses

5.3.1.1 Ammonia emissions from houses for laying hens, broiler breeders or pullets

BAT 31. In order to reduce ammonia emissions to air from each house for laying hens, broiler breeders or pullets, BAT is to use one or a combination of the techniques given below.

	Technique ⁽¹⁾	Applicability
a	Manure removal by belts (in case of enriched or unenriched cage systems) with at least: - one removal per week with air drying; or - two removals per week without air drying.	Enriched cage systems are not applicable to pullets and broiler breeders. Unenriched cage systems are not applicable to laying hens.
b	In case of non-cage systems:	
	0. Forced ventilation system and infrequent manure removal (in case of deep litter with a manure pit) only if used in combination with an additional mitigation measure, e.g.: - achieving a high dry matter content of the manure; - an air cleaning system.	Not applicable to new plants, unless combined with an air cleaning system.
	1. Manure belt or scraper (in case of deep litter with a manure pit).	Applicability to existing plants may be limited by the requirement for a complete revision of the housing system.
	2. Forced air drying of manure via tubes (in case of deep litter with a manure pit)	The technique can be applied only to plants with sufficient space underneath the slats.
	3. Forced air drying of manure using perforated floor (in case of deep litter with a manure pit).	Due to high implementation costs, applicability to existing plants may be limited.
	4. Manure belts (in case of aviary).	Applicability to existing plants depends on the width of the shed.
	5. Forced drying of litter using indoor air (in case of solid floor with deep litter).	Generally applicable.
c	Use of an air cleaning system, such as: 1. Wet acid scrubber; 2. Two-stage or three-stage air cleaning system; 3. Bioscrubber (or biotrickling filter).	May not be generally applicable due to the high implementation cost. Applicable to existing plants only where a centralised ventilation system is used.
⁽¹⁾ A description of the techniques is given in Sections 5.4.11 and 5.4.13.1.		

Table 5.5: BAT-AELs for ammonia emissions to air from each house for laying hens

Parameter	Type of housing	BAT-AEL (kg NH ₃ /animal place/year)
Ammonia expressed as NH ₃	Cage system	0.02–0.08
	Non-cage system	0.02–0.13 ⁽¹⁾
⁽¹⁾ For existing plants using a forced ventilation system and an infrequent manure removal (in case of deep litter with a manure pit), in combination with a measure achieving a high dry matter content of the manure, the upper end of the BAT-AEL is 0.25 kg NH ₃ /animal place/year.		

The associated monitoring is in BAT 25. The BAT-AEL may not be applicable to organic livestock production.

5.3.1.2 Ammonia emissions from houses for broilers

BAT 32. In order to reduce ammonia emissions to air from each house for broilers, BAT is to use one or a combination of the techniques given below.

	Technique ⁽¹⁾	Applicability
a	Forced ventilation and a non-leaking drinking system (in case of solid floor with deep litter).	Generally applicable.
b	Forced drying system of litter using indoor air (in case of solid floor with deep litter).	For existing plants, the applicability of forced air drying systems depends on the height of the ceiling. Forced air drying systems may not be applicable to warm climates, depending on the indoor temperature.
c	Natural ventilation, equipped with a non-leaking drinking system (in case of solid floor with deep litter).	Natural ventilation is not applicable to plants with a centralised ventilation system. Natural ventilation may not be applicable during the initial stage of rearing of broilers and due to extreme climate conditions.
d	Litter on manure belt and forced air drying (in case of tiered floor systems).	For existing plants, the applicability depends on the height of the side walls.
e	Heated and cooled littered floor (in case of combideck systems).	For existing plants, the applicability depends on the possibility to install closed underground storage for the circulating water.
f	Use of an air cleaning system, such as: <ol style="list-style-type: none"> 1. Wet acid scrubber; 2. Two-stage or three-stage air cleaning system; 3. Bioscrubber (or biotrickling filter). 	May not be generally applicable due to the high implementation cost. Applicable to existing plants only where a centralised ventilation system is used.
⁽¹⁾ A description of the techniques is given in Sections 5.4.11 and 5.4.13.2.		

Table 5.6: BAT-AEL for ammonia emissions to air from each house for broilers with a final weight of up to 2.5 kg

Parameter	BAT-AEL ⁽¹⁾ ⁽²⁾ (kg NH ₃ /animal place/year)
Ammonia expressed as NH ₃	0.01–0.08
⁽¹⁾ The BAT-AEL may not be applicable to the following types of farming: extensive indoor, free-range, traditional free-range and free-range–total freedom, as defined in Commission Regulation (EC) No 543/2008 of 16 June 2008 laying down detailed rules for the application of Council Regulation (EC) No 1234/2007 as regards the marketing standards for poultrymeat (OJ L 157, 17.6.2008, p. 46).	
⁽²⁾ The lower end of the range is associated with the use of an air cleaning system.	

The associated monitoring is in BAT 25. The BAT-AEL may not be applicable to organic livestock production.

5.3.1.3 Ammonia emissions from houses for ducks

BAT 33. In order to reduce ammonia emissions to air from each animal house for ducks, BAT is to use one or a combination of the techniques given below.

	Technique ⁽¹⁾	Applicability
a	One of the following techniques using natural or forced ventilation:	
	1. Frequent litter addition (in case of solid floor with deep litter or deep litter combined with slatted floor).	For existing plants with deep litter combined with slatted floor the applicability depends on the design of the existing structure.
	2. Frequent manure removal (in case of fully slatted floor).	Only applicable to the rearing of Barbary/Muscovy ducks (<i>Cairina Moschata</i>), for sanitary reasons.
b	Use of an air cleaning system, such as: 1. Wet acid scrubber; 2. Two-stage or three-stage air cleaning system; 3. Bioscrubber (or biotrickling filter).	May not be generally applicable due to the high implementation cost. Applicable to existing plants only where a centralised ventilation system is used.
⁽¹⁾ A description of the techniques is given in Sections 5.4.11 and 5.4.13.3.		

5.3.1.4 Ammonia emissions from houses for turkeys

BAT 34. In order to reduce ammonia emissions to air from each animal house for turkeys, BAT is to use one or a combination of the techniques given below.

	Technique ⁽¹⁾	Applicability
a	Natural or forced ventilation with a non-leaking drinking system (in case of solid floor with deep litter).	Natural ventilation is not applicable to plants with a centralised ventilation system. Natural ventilation may not be applicable during the initial stage of rearing or due to extreme climate conditions.
b	Use of an air cleaning system, such as: 1. Wet acid scrubber; 2. Two-stage or three-stage air cleaning system; 3. Bioscrubber (or biotrickling filter).	May not be generally applicable due to the high implementation cost. Applicable to existing plants only where a centralised ventilation system is used.
⁽¹⁾ A description of the techniques is given in Sections 5.4.11 and 5.4.13.4.		

5.4 DESCRIPTION OF TECHNIQUES

5.4.1 Techniques for reducing emissions from waste water

Technique	Description
Minimise use of water.	The volume of waste water can be reduced by using techniques such as pre-cleaning (e.g. mechanical dry cleaning) and high pressure cleaning.
Segregate rainwater from waste water streams that require treatment.	Segregation is carried out by implementing separate collection in the form of properly designed and maintained drainage systems.
Treat waste water.	Treatment can be performed by sedimentation and/or biological treatment. For waste water with a low pollutant load, treatment can be carried out by means of swales, ponds, constructed wetlands, soakaways, etc. A first flush system can be used for separation before biological treatment.
Landspreading of waste water e.g. by using an irrigation system such as sprinkler, travelling irrigator, tanker, umbilical injector.	Waste water streams can be settled, e.g. in tanks or lagoons, before landspreading. The resulting solid fraction can also be landspread. The water can be pumped from the stores and brought into a pipeline that goes to e.g. a sprinkler or travelling irrigator, which landspreads the water at a low application rate. Irrigation can also be carried out using equipment with controlled application to ensure a low trajectory (low spread pattern) and large droplets.

5.4.2 Techniques for efficient use of energy

Technique	Description
Optimisation of heating/cooling and ventilation systems and management, especially where air cleaning systems are used.	This takes into account animal welfare requirements (e.g. concentration of air pollutants, appropriate temperatures), and can be obtained through several measures: <ul style="list-style-type: none"> - automation and minimisation of the air flow, while maintaining thermal comfort zone for the animals; - fans with the lowest possible specific power consumption; - flow resistance is kept as low as possible; - frequency converters and electronically commutated motors; - energy-saving fans controlled according to the CO₂ concentration in the housing; - correct distribution of heating/cooling and ventilation equipment, temperature sensors and separate heated areas.
Insulation of walls, floors and/or ceilings of housing.	Insulation material can be naturally impermeable or provided with an impermeable coating. Permeable materials are provided with a vapour barrier installed, as humidity is a major cause of insulation material deterioration. A variant of insulation material for poultry farms can be heat-reflecting membranes, consisting of laminated plastic foils to seal off housing from air leakage and humidity.
Use of energy-efficient lighting.	More energy-efficient lighting can be attained by: <ol style="list-style-type: none"> i. Replacing conventional tungsten light bulbs or other low efficiency light bulbs with more energy-efficient lights such as fluorescent, sodium, and LED lights; ii. Using devices to adjust the frequency of micro flashes, dimmers to adjust artificial lighting, sensors or room entry switches to control the lighting; iii. Allowing more natural light to enter, e.g. by using vents or roof windows. Natural light has to be balanced with potential heat losses; iv. Applying lighting schemes, using a variable lighting

Technique	Description
	period.
Use of heat exchangers. One of the following systems may be used: - air-air; - air-water; - air-ground.	In an air-air heat exchanger, the incoming air absorbs heat from the exhaust air from the plant. It can be composed of plates of anodised aluminium or PVC tubes. In the air-water heat exchanger, water flows through aluminium fins located in the exhaust ducts and absorbs heat from the exhausted air. In the air-ground heat exchanger, fresh air is circulated through buried pipes (e.g. at a depth of about 2 metres) taking advantage of the low seasonal temperature variation of soil.
Use of heat pumps for heat recovery.	Heat is absorbed from various media (water, slurry, ground, air, etc.) and transferred to another location, via a fluid circulated in a sealed circuit using the reverse refrigeration cycle principle. The heat can be used to produce sanitised water or to feed a heating system or a cooling system. The technique can absorb heat from various circuits, such as slurry cooling systems, geothermal energy, scrubbing water, slurry biological treatment reactors, or biogas engine exhaust gases.
Heat recovery with heated and cooled littered floor (combideck system).	A closed water circuit is installed below the floor and another is built at a deeper level for storing the excess heat or to return it to the poultry house when needed. A heat pump connects the two water circuits. At the beginning of the rearing period, the floor is heated with the stored heat in order to keep the litter dry by avoiding moisture condensation; during the second rearing cycle, birds produce an excess of heat that is preserved in the storing circuit while cooling down the floor which reduces the breakdown of uric acid by reducing microbial activity.
Apply natural ventilation.	Free ventilation in the animal house is caused by thermal effects and/or wind flow. The animal houses can have openings in the ridge and, if necessary, also on the gable sides in addition to controllable openings in the side walls. The openings can be equipped with wind protection nets. Fan assistance can be used during hot weather.

5.4.3 Techniques for reducing dust emissions

Technique	Description
Water fogging	Water is sprayed by nozzles at high pressure to produce fine droplets that absorb heat and fall by gravity to the floor, moistening dust particles that become heavy enough to drop as well. Wet or moist litter needs to be avoided.
Ionisation	An electrostatic field is created in the house to produce negative ions. Circulating airborne dust particles are charged by free negative ions; particles are collected on the floor and room surfaces by gravitational force and electrostatic field attraction.
Oil spraying	Pure vegetable oil is sprayed by nozzles inside the house. A mixture of water and around 3 % vegetable oil can be also used for spraying. Circulating dust particles are bound to the oil drops and collected in the litter. A thin layer of vegetable oil is also applied on the litter to prevent dust emissions. Wet or moist litter needs to be avoided.

5.4.4 Techniques for reducing odour emissions

Technique	Description
Ensure adequate distances between the plant/farm and the sensitive receptors.	At the planning stage of the plant/farm, adequate distances between the plant/farm and the sensitive receptors are ensured by applying minimum standard distances or performing dispersion modelling to predict/simulate odour concentration in surrounding areas.
Cover slurry or solid manure during storage.	See description in Section 5.4.5 for solid manure. See description in Section 5.4.6 for slurry.
Minimise stirring of slurry.	See description in Section 5.4.6.1.
Aerobic digestion (aeration) of liquid manure/slurry.	See description in Section 5.4.7.
Compost solid manure.	
Anaerobic digestion.	
Band spreader, shallow injector or deep injector for slurry landspreading.	See descriptions in Section 5.4.8.1.
Incorporate manure as soon as possible.	See descriptions in BAT 22.

5.4.5 Techniques for reducing emissions from the storage of solid manure

Technique	Description
Store dried solid manure in a barn.	The barn is usually a simple construction with an impermeable floor and a roof, with sufficient ventilation to avoid anaerobic conditions and an access door for transport. Dried poultry manure (e.g. litter from broilers and laying hens, air-dried laying hen excreta collected on belts) is transported by belts or front-end loaders from the poultry house to the barn where it can be stored for a long period of time without the risk of remoistening.
Use a concrete silo for storage.	A foundation slab of water-impermeable concrete that can be combined with walls on three sides and with a cover e.g. roofing over the manure platform, UV-stabilised plastic, etc. The floor is sloped (e.g. 2 %) towards a front drain gutter. Liquid fractions and any run-off caused by rainfall are collected in a leak-tight concrete pit and handled afterwards.
Store solid manure on solid impermeable floor equipped with a drainage system and a collection tank for run-off.	The storage is equipped with a solid impermeable floor, a drainage system such as drains, and connected to a tank for collection of liquid fractions and any run-off caused by rainfall.
Select a storage facility with a sufficient capacity to hold the manure during periods in which landspreading is not possible.	The periods when manure landspreading is allowed depend on the local climatic conditions and legislation, etc.; thus, requiring a storage area with a suitable capacity. The available capacity also allows the landspreading time to be aligned to the nitrogen requirements of the crops.
Store solid manure in field heaps placed away from surface and/or underground watercourses which liquid run-off might enter.	Solid manure is stacked directly on the soil in the field prior to landspreading over a limited period of time (e.g. for a few days or several weeks). The storage location is changed at least every year and situated as far as possible from surface and groundwater.
Reduce the ratio between the emitting surface area and volume of the manure heap.	Manure can be compacted or a three-sided wall store can be used.
Cover solid manure heaps.	Materials such as UV-stabilised plastic covers, peat, sawdust, or wood chips can be used. Tight covers decrease air exchange and aerobic decomposition in the manure heap, resulting in a reduction of emissions to air.

5.4.6 Techniques for reducing emissions from slurry storage

5.4.6.1 Techniques for reducing ammonia emissions from slurry stores and earth-banked storage

Technique	Description
Reduce the ratio between the emitting surface area and the volume of the slurry store.	For rectangular slurry stores, the proportion of height and surface area is equivalent to 1:30–50. For circular stores, favourable container dimensions are obtained with a height–diameter ratio of 1:3 to 1:4. The side walls of the slurry store may be increased in height.
Reduce wind velocity and air exchange on the slurry surface by operating at a lower level of fill.	Increasing the freeboard (the length between the slurry surface and the upper rim of the slurry store) of the uncovered store provides a windshield effect.
Minimise stirring of slurry.	Keep the stirring of slurry to a minimum. This practice involves: <ul style="list-style-type: none"> - filling the store below surface level; - discharging as close as possible to the base of the store; - avoiding unnecessary homogenisation and circulation of slurry (before emptying the slurry store).
Rigid cover.	A roof or a lid which can be made of concrete, fibreglass panels or polyester sheets with a flat deck or conical shape, applied to concrete or steel tanks and silos. It is well-sealed and 'tight' to minimise air exchange and to prevent rain and snow from entering.
Flexible covers.	Tent Cover: A cover with a central supporting pole and spokes radiating from the tip. A fabric membrane is spread over the spokes and tied to a rim brace. Non-covered openings are kept to a minimum. Dome-shaped cover: A cover with a curved structural frame installed over round stores with the use of steel components and bolted joints. Flat cover: A cover consisting of a flexible and self-supporting composite material held by plugs on a metal structure.
Floating covers.	
Natural crust.	A crust layer can be formed on the surface of slurry that has a sufficient dry matter (DM) content (at least 2 %) depending on the nature of the slurry solids. In order to be effective, the crust must be thick, not be disturbed and cover the whole slurry surface. The store is filled from below the surface once the cover is formed to avoid breaking it up.
Straw.	Chopped straw is added to the slurry and a straw-induced crust is formed. This generally works well for DM higher than 4–5 %. A layer thickness of at least 10 cm is recommended. Air blowing can be reduced by adding straw at the time of slurry addition. Straw layers may need to be partially or completely renewed during the year. The store is filled from below the surface once the cover is formed to avoid breaking it up.
Plastic pellets.	Polystyrene balls of 20 cm in diameter and 100 g in weight are used to cover the slurry surface. A regular replacement of deteriorated elements and a refill for uncovered spots are necessary.
Light bulk materials.	Materials such as LECA (Light expanded clay aggregates), LECA based products, perlite or zeolite are added to the slurry surface to form a floating layer. A floating layer of 10–12 cm is recommended. A thinner layer can be effective for smaller LECA particles.

Technique	Description
Floating flexible covers.	Plastic floating covers (e.g. blankets, canvas, films) rest over the slurry surface. Floats and tubes are installed to keep the cover in place, while maintaining a void beneath the cover. This technique can be combined with stabilising elements and structures to allow vertical movements. Venting is needed as well as removal of rainwater that gathers on top.
Geometrical plastic tiles.	Floating hexagonal plastic bodies are automatically distributed on the slurry surface. About 95 % of the surface can be covered.
Air-inflated cover.	A cover made of PVC fabric supported by an inflatable pocket that floats over the slurry. The fabric is fixed by guy ropes to a peripheral metal structure.
Flexible plastic sheets.	Impermeable UV-stabilised plastic sheets (e.g. HDPE) are secured at the bank tops and supported on floats. This prevents the cover from turning during manure mixing and being lifted off by wind. The covers can also be fitted with collection piping for removal of gases, other maintenance openings (e.g. for the use of homogenisation equipment) and a system for rainwater collection and removal.

5.4.6.2 Techniques for reducing emissions to soil and water from slurry stores

Technique	Description
Use stores that are able to withstand mechanical, chemical and thermal influences.	Appropriate concrete mixtures and, in many cases, lining on concrete walls or impermeable layers on steel sheets can be applied.
Select a storage facility with a sufficient capacity to hold the manure during periods in which landspreading is not possible.	See Section 5.4.5.

5.4.7 Techniques for on farm manure processing

Technique	Description
Mechanical separation of slurry.	Separation of liquid and solid fractions with different dry matter content, using e.g. screw press separators, decanter-centrifuge separators, separation by sieves and filter pressing. Separation can be enhanced by coagulation-flocculation of solid particles.
Anaerobic digestion of manure in a biogas installation.	Anaerobic microorganisms decompose the organic matter of manure in a closed reactor in the absence of oxygen. Biogas is produced and collected to serve energy generation i.e. production of heat, combined heat and power, and/or transport fuel. Some of the heat produced is recycled in the process. The stabilised residue (digestate) can be used as fertiliser (with sufficiently solid digestate after composting). Solid manure can be co-digested with slurry and/or other co-substrates, while ensuring a dry matter content lower than 12 %.
Use of an external tunnel for manure drying.	Manure is collected from the laying hen houses and removed by belts that convey it outdoors to a dedicated closed structure, containing a series of perforated overlapping belts that form the tunnel. Warm air is blown through the belts, drying the manure in about two or three days. The tunnel is ventilated with air extracted from the laying hens' house.

Technique	Description
Aerobic digestion (aeration) of slurry.	The biological decomposition of organic matter under aerobic conditions. Stored slurry is aerated by means of submerged or floating aerators in a continuous or batch process. Operating variables are controlled to prevent nitrogen removal, such as keeping slurry agitation as low as possible. The residue can be used as fertiliser (composted or not) after concentration.
Nitrification-denitrification of slurry.	Part of the organic nitrogen is transformed into ammonium. Ammonium is oxidised by nitrifying bacteria into nitrite and nitrate. By applying anaerobic periods, the nitrate can be transformed into N ₂ in the presence of organic carbon. In a secondary basin, the sludge settles, with part of it being reused in the aeration basin. The residue can be used as fertiliser (composted or not) after concentration.
Composting of solid manure.	The controlled aerobic decomposition of solid manure by microorganisms producing a final product (compost) sufficiently stable for transport, storage and landspreading. Odour, microbial pathogens and water content of manure are reduced. The solid fraction of the slurry can also be composted. The supply of is achieved by mechanical reversal of the windrows or by forced aeration of the heaps. Drums and composting tanks can also be used. Biological inoculum, green residues or other organic wastes (e.g. digestate) can be co-composted with solid manure.

5.4.8 Techniques for manure landspreading

5.4.8.1 Techniques for slurry landspreading

Technique	Description
Slurry dilution	Dilution rate of water:slurry is from 1:1 up to 50:1. The dry matter content of diluted slurry is less than 2 %. The clarified liquid fraction from the mechanical separation of slurry and the digestate from anaerobic digestion can be used as well.
Low-pressure water irrigation system	Diluted slurry is injected into the irrigation water pipeline and is pumped under low pressure to the irrigation system (e.g. sprinkler or travelling irrigator).
Band spreader (trailing hose)	A series of flexible hoses hang from a wide bar mounted onto the slurry trailer. The hoses discharge slurry at ground level in wide parallel bands. Application between the rows of a growing arable crop is feasible.
Band spreader (trailing shoe)	Slurry is discharged through rigid pipes which terminate in metal 'shoes', designed to apply slurry directly in narrow bands to the soil surface and below the crop canopy. Some types of trailing shoes are designed to cut a shallow slit in the soil to aid infiltration.
Shallow injector (open slot)	Tines or disc harrows are used to cut vertical slots (typically 4–6 cm deep) in the soil, forming grooves into which slurry is deposited. The injected slurry is fully or partially placed below the soil surface and grooves will normally be open after slurry application.
Deep injector (closed slot)	Tines or disc harrows are used to cultivate the soil and deposit slurry into it, before covering the slurry fully by means of press wheels or rollers. The depth of the closed slot ranges between 10 cm and 20 cm.
Slurry acidification	See Section 5.4.12.3.

5.4.9 Techniques for monitoring

5.4.9.1 Techniques for monitoring N and P excretion

Technique	Description
<p>Calculation by using a mass balance of nitrogen and phosphorus based on feed intake, crude protein content of the diet, total phosphorus and animal performance.</p>	<p>The mass balance is calculated for each animal category reared on the farm, coinciding with the end of a rearing cycle, on the basis of the following equations:</p> $N_{\text{excreted}} = N_{\text{diet}} - N_{\text{retention}}$ $P_{\text{excreted}} = P_{\text{diet}} - P_{\text{retention}}$ <p>N_{diet} is based on the amount of feed ingested and on the crude protein content of the diet. P_{diet} is based on the amount of feed ingested and on the total phosphorus content of the diet. The crude protein and the total phosphorus contents can be obtained by one of the following methods:</p> <ul style="list-style-type: none"> • in the case of external feed supply: in the accompanying documentation; • in the case of self-processing of feed: by sampling of feedstuff compounds from the silos or the feeding system for analysing the total content of phosphorus and crude protein or, alternatively, in the accompanying documentation or using standard values of total content of phosphorus and crude protein of the feedstuff compounds. <p>$N_{\text{retention}}$ and $P_{\text{retention}}$ can be estimated by one of the following methods:</p> <ul style="list-style-type: none"> • statistically derived equations or models; • standard retention factors for the nitrogen and phosphorus contents of the animal (or of eggs, in the case of laying hens); • analysis for nitrogen and phosphorus contents of a representative sample of the animal (or of eggs, in the case of laying hens). <p>The mass balance considers especially any significant changes to the diet commonly applied (e.g. change of a compound feed).</p>
<p>Estimation by using manure analysis for total nitrogen and total phosphorus contents.</p>	<p>The total content of nitrogen and phosphorus of a representative composite sample of manure is measured — and the total excretion of nitrogen and phosphorus is estimated — based on records for the volume (for slurry) or weight (for solid manure) of manure. For solid manure systems, the nitrogen content of litter is also considered.</p> <p>In order for the composite sample to be representative, samples must be taken from at least 10 different places and/or depths to make the composite sample. In the case of poultry litter, the bottom of the litter is sampled.</p>

5.4.9.2 Techniques for ammonia and dust monitoring

Technique	Description
<p>Estimation by using a mass balance based on the excretion and the total (or ammoniacal) nitrogen present at each manure management stage.</p>	<p>Ammonia emissions are estimated based on the amount of nitrogen excreted by each animal category and using the total nitrogen (or the total ammoniacal nitrogen – TAN) flow and the volatilisation coefficients (VC) over each manure management stage (housing, storage, landspreading). The equations applied for each of the manure management stages are:</p> $E_{\text{housing}} = N_{\text{excreted}} \cdot VC_{\text{housing}}$ $E_{\text{storage}} = N_{\text{storage}} \cdot VC_{\text{storage}}$ $E_{\text{spreading}} = N_{\text{spreading}} \cdot VC_{\text{spreading}}$ <p>where:</p> <p>E is the annual NH₃ emission from the animal house, manure storage or landspreading (e.g. in kg NH₃/animal place/year). N is the annual total nitrogen or TAN excreted, stored or applied in landspreading (e.g. in kg N/animal place/year). If appropriate, nitrogen additions (e.g. related to litter, recycling of scrubbing liquids) and/or nitrogen losses (e.g. related to manure processing) can be considered. VC is the volatilisation coefficient (dimensionless, related to the housing system, manure storage or landspreading techniques) representing the proportion of TAN or total N emitted to air. VC are derived from measurements designed and performed according to a national or an international protocol (e.g. VERA protocol) and validated for a farm with an identical type of technique and similar climatic conditions. Alternatively, information to derive VC can be taken from European or other internationally recognised guidance. The mass balance considers especially any significant change to the type of livestock reared at the farm and/or to the techniques applied for housing, storage and landspreading.</p>
<p>Calculation by measuring the ammonia (or dust) concentration and the ventilation rate using ISO, national or international standard methods or other methods ensuring data of an equivalent scientific quality.</p>	<p>Ammonia (or dust) samples are taken on six days, as a minimum, distributed over one year. Sampling days are distributed as follows:</p> <ul style="list-style-type: none"> - For animal categories with a stable emissions pattern (e.g. laying hens), the sampling days are randomly selected in every two-month period. The daily average is calculated as a mean over all sampling days. - For animal categories with a linear increase in emissions during the rearing cycle (e.g. fattening pigs), the sampling days are equally distributed over the growing period. In order to achieve this, half the measurements are performed in the first half of the rearing cycle, and the remainder in the second half of the rearing cycle. The sampling days in the second half of the rearing cycle are equally distributed within the year (same number of measurements per season). The daily average is calculated as a mean over all sampling days. - For animal categories with an exponential increase in emissions (e.g. broilers), the rearing cycle is divided into three periods of equal length (same number of days). One measurement day falls in the first period, two measurements in the second period, and three measurements in the third period. In addition, sampling days in the third period of the rearing cycle are equally distributed within the year (same number of measurements per season). The daily average is calculated as the average of the three periodic means. <p>Sampling is based on 24-hour sampling periods and is performed at the air inlet/outlet. Ammonia (or dust) concentration at the air outlet is then measured, corrected for the concentration of the incoming</p>

Technique	Description
	<p>air, and daily ammonia (or dust) emissions are derived by measuring and multiplying the ventilation rate and the ammonia (or dust) concentration. From the daily average of ammonia (or dust) emissions, the yearly average ammonia (or dust) emissions from an animal house can be calculated, if multiplied by 365 and corrected for any non-occupation periods.</p> <p>The ventilation rate, necessary to determine the emission mass flow, is determined either by calculation (e.g. fan wheel anemometer, records of ventilation control system) in forced ventilated houses, or by means of tracer gases (excluding the use of SF₆ and any gas containing CFCs) in naturally ventilated houses which allow a proper mixing of air.</p> <p>For plants with multiple air inlets and outlets, only those sampling points considered representative (in terms of expected mass emissions) of the plant are monitored.</p>
<p>Estimation by using emission factors.</p>	<p>Ammonia (or dust) emissions are estimated on the basis of emission factors derived from measurements designed and performed according to a national or an international protocol (e.g. VERA protocol) in a farm with an identical type of technique (related to the housing system, manure storage and/or landspreading) and similar climatic conditions. Alternatively, emission factors can be taken from European or other internationally recognised guidance.</p> <p>The use of emission factors considers especially any significant change to the type of livestock reared at the farm and/or to the techniques applied for housing, storage, landspreading.</p>

5.4.9.3 Techniques for monitoring of air cleaning systems

Technique	Description
<p>Verification of the air cleaning system performance by measuring ammonia, odour and/or dust under practical farm conditions, according to a prescribed measurement protocol and using EN standard methods or other methods (ISO, national or international) ensuring data of an equivalent scientific quality.</p>	<p>The verification is done by measurement of ammonia, odour and/or dust in the inlet and outlet air and of all additional parameters relevant for operation (e.g. air flow rate, pressure drop, temperature, pH level, conductivity). Measurements are performed under summer climatic conditions (a period of at least eight weeks with a ventilation rate > 80 % of the maximum ventilation rate) and winter climatic conditions (a period of at least eight weeks with a ventilation rate < 30 % of the maximum ventilation rate), with representative management and full capacity of the housing and only if an adequate time period (e.g. four weeks) has elapsed after the last change of wash water. Different sampling strategies can be applied.</p>
<p>Control of the effective function of the air cleaning system (e.g. by continuously recording operational parameters or using alarm systems).</p>	<p>Operation of an electronic logbook in order to record all measuring and operational data over a period of 1–5 years. Recorded parameters depend on the type of air cleaning system and may include:</p> <ol style="list-style-type: none"> 1. pH and conductivity of scrubbing liquid; 2. air flow and pressure drop of the abatement system; 3. pump operating time; 4. water and acid consumption. <p>Other parameters can be recorded manually.</p>

5.4.10 Nutritional management

5.4.10.1 Techniques for reducing nitrogen excreted

Technique	Description
Reduce the crude protein content by using a N-balanced diet based on the energy needs and digestible amino acids.	Reduce excesses in the crude protein supply by ensuring that it does not exceed feeding recommendations. The diet is balanced to meet the animal requirements of energy and digestible amino acids.
Multiphase feeding with a diet formulation adapted to the specific requirements of the production period.	The feed mix matches the animal requirements more accurately in terms of energy, amino acids and minerals, depending on the animal weight and/or production stage.
Addition of controlled amounts of essential amino acids to a low crude protein diet.	A certain amount of protein-rich feedstuffs is substituted by low-protein feedstuffs, in order to further reduce the crude protein content. The diet is supplemented with synthetic amino acids (e.g. lysine, methionine, threonine, tryptophan, valine) so that there is no deficiency in the amino acid profile.
Use of authorised feed additives which reduce total nitrogen excreted.	Authorised (according to Regulation (EC) N° 1831/2003 of the European Parliament and of the Council ⁽¹⁾) substances, microorganisms or preparations such as enzymes (e.g. NSP enzymes, proteases) or probiotics are added to feed or water in order to favourably affect feed efficiency e.g. by improving the digestibility of feedstuffs or affecting the gastrointestinal flora.
⁽¹⁾ Regulation (EC) No 1831/2003 of the European Parliament and of the Council of 22 September 2003 on additives for use in animal nutrition (OJ L 268, 18.10.2003, p. 29).	

5.4.10.2 Techniques for reducing phosphorus excreted

Technique	Description
Multiphase feeding with a diet formulation adapted to the specific requirements of the production period.	The feed consists of a mix matching the phosphorus supply to the phosphorus animal requirements more accurately depending on the animal weight and/or production stage.
Use of authorised feed additives which reduce total phosphorus excreted (e.g. phytase).	Authorised (according to Regulation (EC) N° 1831/2003 of the European Parliament and of the Council) substances, microorganisms or preparations such as enzymes (e.g. phytase) are added to feed or water in order to favourably affect feed efficiency e.g. by improving the digestibility of phytic phosphorus in the feedstuffs or affecting the gastrointestinal flora.

5.4.11 Techniques to treat emissions to air from animal housing

Technique	Description
Biofilter	The exhaust air is led through a filter bed of organic material, such as root wood or wood chips, coarse bark, compost or peat. The filter material is always kept moist by intermittent sprinkling of the surface. Dust particles and odorous air compounds are absorbed by the wet film and are oxidised or degraded by microorganisms living on the moistened litter material.
Bioscrubber (or biotrickling filter)	A packed tower filter with inert packing material which is normally maintained continuously wet by sprinkling water. Air pollutants are absorbed in the liquid phase and subsequently degraded by microorganisms settling on the filter elements. An ammonia reduction of between 70 % and 95 % can be achieved.
Dry filter	The exhaust air is blown against a screen made of e.g. multi-layered plastic placed in front of the end wall ventilator. The passing air is subject to strong changes of direction causing the separation of particles by centrifugal force.
Two-stage or three-stage air cleaning system	In a two-stage system, the first stage (wet acid scrubber) is usually combined with a bioscrubber (second stage). In a three-stage system, a first stage consisting of a water scrubber is usually combined with a second stage (wet acid scrubber), followed by a biofilter (third stage). An ammonia reduction of between 70 % and 95 % can be achieved.
Water scrubber	The exhaust air is blown through a packed filter medium by transverse flow. Water is continuously sprayed on the packing material. Dust is removed and settles in the water tank, which is emptied before refilling.
Water trap	The exhaust air is directed by ventilation fans down onto a water bath where dust particles get soaked. The flow is then redirected 180 ° upward. The water level is topped up regularly to compensate for evaporation.
Wet acid scrubber	The exhaust air is forced through a filter (e.g. packed wall) where a circulating acid liquid (e.g. sulphuric acid) is sprayed. An ammonia reduction of between 70 % and 95 % can be achieved.

5.4.12 Techniques for pig houses

5.4.12.1 Description of floor types and techniques for reducing ammonia emissions in pig houses

Type of floor	Description
Fully slatted floor	A floor where the whole area is slatted using metal, concrete or plastic floor with openings that allows faeces and urine to drop into a channel or a pit beneath.
Partly slatted floor	A floor that is partly solid and partly slatted using metal, concrete or plastic floor with openings that allows faeces and urine to drop into a channel or a pit beneath. Fouling of the solid floor is prevented by proper management of the indoor climate parameters, especially under hot conditions, and/or by proper design of the housing systems.
Solid concrete floor	A floor where the entire area consists of solid concrete. The floor can be covered with litter (e.g. straw) to varying degrees. The floor is usually sloped to facilitate the drainage of urine.

The floor types listed above are used in the described housing systems, when appropriate:

Technique	Description
<p>A deep pit (in case of a fully or partly slatted floor) only if used in combination with an additional mitigation measure, e.g.:</p> <ul style="list-style-type: none"> - a combination of nutritional management techniques; - air cleaning system; - pH reduction of the slurry; - slurry cooling. 	<p>Pens are equipped with a deep pit below the slatted floor that allows for the storage of the slurry between infrequent removals. For fattening pigs, an overflow manure channel can be used. Removal of slurry for landspreading or to outdoor store takes place as frequent as possible (e.g. at least every two months) unless there are technical restrictions (e.g. storage capacity).</p>
<p>A vacuum system for frequent slurry removal (in case of a fully or partly slatted floor).</p>	<p>Outlets at the bottom of the pit or channel are connected to a discharge pipe underneath which transfers slurry to outdoor storage. Slurry is frequently discharged by opening a valve or a plug in the main slurry pipe, e.g. once or twice every week; a slight vacuum develops and allows the complete emptying of the pit or channel. A certain depth of slurry needs to be obtained before the system can operate properly to allow the vacuum to be effective.</p>
<p>Slanted walls in the manure channel (in case of a fully or partly slatted floor).</p>	<p>The manure channel creates a V section with the point of discharge at the bottom. The slope and the smoothness of the surface facilitate the slurry discharge. Manure removal is carried out at least twice every week.</p>
<p>A scraper for frequent slurry removal (in case of a fully or partly slatted floor).</p>	<p>There is a V-shaped channel with two inclined surfaces on each side of a central gutter, where urine can be drained to a collection pit through a drain in the bottom of the manure channel. From the pit, the solid fraction of the manure is extracted frequently (e.g. daily) by a scraper. The addition of a coating on the scraped floor is recommended in order to achieve a smooth(er) surface.</p>
<p>Convex floor and separated manure and water channels (in case of partly slatted pens).</p>	<p>Manure and water channels are built at opposite sides of the convex and smooth solid concrete floor. The water channel is installed underneath the side of the pen where the pigs tend to eat and drink. Water for cleaning the pens may be used to fill the water channels. The channel is partially filled with at least 10 cm of water. The manure channel can be built with flashed gutters or slanted walls which are normally flushed twice every day for example with water from the other channel or the liquid fraction of the slurry (dry matter content no higher than approximately 5 %).</p>
<p>V-shaped manure belts (in case of partly slatted floor).</p>	<p>V-shaped manure belts roll inside the manure channels covering the whole surface, so that all faeces and urine are dropped on them. Belts are run at least twice every day to separately carry urine and faeces to closed manure storage. Belts are made of plastic (polypropylene or polyethylene).</p>
<p>Reduced manure pit (in case of partly slatted floor).</p>	<p>The pen is equipped with a narrow pit with a width of about 0.6 m. The pit can be placed in an external alley.</p>
<p>Frequent slurry removal by flushing (in case of fully or partly slatted floor).</p>	<p>A very frequent removal (e.g. once or twice per day) of the slurry is performed by flushing the channels with the liquid fraction of the slurry (dry matter content no higher than approximately 5 %) or water. The liquid fraction of the slurry can also be aerated before flushing. This technique can be combined with individual variations of the bottoms of channels or pits, e.g. gutters, tubes or a permanent slurry layer.</p>
<p>Kennel / hut housing (in case of partly slatted floor).</p>	<p>Separate functional areas are organised in the pens of naturally ventilated houses. The lying area (about 50–60 % of the total area) consists of a levelled insulated concrete floor with covered, insulated huts or kennels, with a hinged roof that can be raised or lowered to control temperature and ventilation. The activity and feeding areas lie on a slatted floor with a manure pit underneath and frequent manure removal, e.g. by vacuum. Straw can be used on the solid concrete floor.</p>

Technique	Description
Full litter system (in case of solid concrete floor).	A fully concrete floor almost completely covered with a layer of straw or other lignocellulosic material. In the litter-floored system, solid manure is frequently removed (e.g. twice per week). Alternatively in the deep litter system, fresh straw is added on top and the accumulated manure is removed at the end of the rearing cycle. Separate functional areas can be organised into lying, feeding, walking and defecating areas.
Littered external alley (in case of solid concrete floor).	A small door allows the pig to go out to defecate in an external alley with a concrete littered floor. The manure falls into a channel from where it is scraped once every day.
Feeding/lying boxes on solid floor (in case of litter-based pens).	Sows are kept in a pen divided into two functional areas, the main one littered and a series of feeding/lying boxes over a solid floor. Manure is captured in the straw or other lignocellulosic material, which is regularly supplied and replaced.
Manure collection in water.	Manure is collected in the cleaning water that is kept in the manure channel and refilled up to a level of around 120–150 mm. Slanted channel walls are optional. After each rearing cycle, the manure channel is emptied.
A combination of water and manure channels (in case of fully slatted floor).	The sow is kept in a fixed place (by using a farrowing crate) with a specific defecating area. The manure pit is split up into a wide water channel at the front and a small manure channel at the back, with a reduced manure surface. The front channel is partly filled with water.
Manure pan (in case of fully or partly slatted floor).	A prefabricated pan (or pit) is placed under the slatted floor. The pan is deepest at one end with a slope of at least 3 ° towards a central manure channel; the manure discharges when its level reaches around 12 cm. If a water channel exists, the pan can be subdivided into a water section and a manure section.
Straw flow system (in case of solid concrete floor).	Pigs are reared in pens with solid floors, where a sloped lying area and an excretion area are defined. Straw is provided to the animals daily. Pig activity pushes and distributes the litter down the pen's slope (4–10 %) to the manure collection aisle. The solid fraction can be removed frequently (e.g. daily) with a scraper.
Littered pens with combined manure generation (slurry and solid manure).	Farrowing pens are equipped with separate functional areas: a bedded lying area, walking and dung areas with slatted or perforated floors, and a feeding area on a solid floor. Piglets are provided with a littered and covered nest. Slurry is frequently removed with a scraper. Solid manure is manually removed from the solid floor areas on a daily basis. Litter is regularly provided. A yard can be combined with the system.
Use of floating balls in the manure channel.	Balls half-filled with water and made of special plastic with non-sticky coating, float on the surface of the manure channels.

5.4.12.2 Techniques for cooling slurry

Technique	Description
Slurry cooling pipes	A reduction of slurry temperature (usually less than 12 °C) is achieved by installing a cooling system placed above the slurry, above the concrete floor or cast into the floor. The applied cooling intensity can be from 10 W/m ² to 50 W/m ² for gestating sows and fattening pigs housed on partly slatted floors. The system consists of pipes in which a refrigerant or water is circulated. The pipes are connected to a heat exchange device to recover energy that may be used for heating other parts of the farm. The pit or the channels need to be frequently emptied due to a relatively small exchanging surface of the pipes.

5.4.12.3 Techniques for reducing the pH of slurry

Technique	Description
Slurry acidification	Sulphuric acid is added to slurry in order to lower the pH to about 5.5 in the slurry pit. The addition can be carried out in a process tank, followed by aeration and homogenisation. Part of the treated slurry is pumped back to the storage pit under the housing floors. The treatment system is fully automated. Prior to (or after) landspreading on acid soils, lime addition may be required to neutralise the pH of the soil. Alternatively, acidification can be performed directly in the slurry store or continuously during landspreading.

5.4.13 Techniques for poultry housing

5.4.13.1 Techniques for reducing ammonia emissions from houses for laying hens, broiler breeders or pullets

Housing system	Description
Unenriched cage system	Broiler breeders are housed in unenriched cage systems fitted with perches, litter area and nest. Pullets should be given appropriate experience of management practices (e.g. particular feeding and watering systems) and environmental conditions (e.g. natural light, perches, litter) to enable them to adapt to the husbandry systems which they will encounter later in life. The cages are usually arranged on three or more tiers.
Enriched cage system	Enriched cages are built with sloping floors, are made of welded wire mesh or plastic slats and are equipped with fixtures and increased space for feeding, drinking, nesting, scratching, perching and egg collection. The capacity of the cages can vary from around 10 to 60 birds. The cages are usually arranged on three or more tiers.
Deep litter with manure pit	At least one-third of the total floor in the housing is covered with litter (e.g. sand, wood shavings, straw). The remaining floor area is slatted, with a manure pit underneath. Feeding and drinking fixtures are located over the slatted area. Additional structures can be present inside or outside the housing, such as verandas and free-range system.

Housing system	Description
Aviaries	Aviaries are divided into different functional areas for feeding, drinking, egg laying, scratching and resting. The usable area is increased by means of elevated slatted floors combined with tiers. The slatted area ranges between 30 % and 60 % of the total floor area. The remaining floor is typically littered. In plants for laying hens and broiler breeders, the system can be combined with verandas with or without free-range system.
Manure removal by belts (in case of enriched or unenriched cage systems) with at least: - one removal per week with air drying; or - two removals per week without air drying.	Belts are placed under the cages for manure removal. The frequency of removal can be once every week (with air drying) or more (without air drying). The collection belt may be ventilated for drying the manure. Whisk-forced air drying in the manure belt can be also used.
Manure belt or scraper (in case of deep litter with a manure pit).	Manure is removed by scrapers (periodically) or by belts (once every week for dried manure, twice every week without drying).
Forced ventilation system and infrequent manure removal (in case of deep litter with a manure pit) only if used in combination with an additional mitigation measure, e.g.: - achieving a high dry matter content of the manure; - an air cleaning system.	The deep litter system (see above for description) is combined with infrequent manure removal, e.g. at the end of the rearing cycle. A minimum dry matter content of manure of around 50–60 % is ensured. This is achieved by an appropriate forced ventilation system (e.g. fans and air extraction placed at floor level).
Forced air drying of manure via tubes (in case of deep litter with a manure pit).	The deep litter system (see above for description) is combined with manure drying by means of forced ventilation applied through tubes that blow air (e.g. at 17–20 °C and 1.2 m ³ /bird) over the manure stored under the slatted floor.
Forced air drying of manure using perforated floor (in case of deep litter with a manure pit).	The deep litter system (see above for description) is equipped with a perforated floor placed underneath the manure which allows for forced air blowing from below. The manure is removed at the end of the rearing cycle.
Manure belts (in case of aviary).	Manure is collected on belts under the slatted floor and removed at least once every week by ventilated or not ventilated belts. Littered and solid floors can be combined in aviaries for pullets.
Forced drying of litter using indoor air (in case of solid floor with deep litter).	In a deep litter system without a manure pit, indoor air recirculation systems can be used to dry the litter, while meeting the physiological needs of the birds. To this end, fans, heat exchangers and/or heaters can be used.

5.4.13.2 Techniques for reducing ammonia emissions from broiler houses

Technique	Description
Natural or forced ventilation with a non-leaking drinking system (in case of solid floor with deep litter).	The building is closed and well-insulated, equipped with natural or forced ventilation, and can be combined with a veranda and/or a free-range system. The solid floor is fully covered with litter which can be added to upon necessity. Floor insulation (e.g. concrete, clay, membrane) prevents water condensation in the litter. Solid manure is removed at the end of the rearing cycle. The design and operation of the drinking water system prevents leakage and spillage of water on the litter.
Forced drying system of litter using indoor air (in case of solid floor with deep litter).	Indoor air recirculation systems can be used to dry the litter, while meeting the physiological needs of the birds. To this end, fans, heat exchangers and/or heaters can be used.
Litter on manure belt and forced air drying (in case of tiered floor systems).	A multi-floor system on tiers equipped with manure belts covered with litter. Corridors for ventilation are left between the rows of tiers. Air enters through one corridor and is directed to the litter material on the manure belt. Litter is removed at the end of the rearing cycle. The system can be used in combination with a separate initial stage where broiler chicks are hatched and grown for a limited time on manure belts with litter on a multi-tiered system.
Heated and cooled littered floor (in case of combideck systems).	See Section 5.4.2.

5.4.13.3 Techniques for reducing ammonia emissions from duck houses

Technique	Description
Frequent litter addition (in case of solid floor with deep litter or deep litter combined with slatted floor).	Litter is maintained dry by frequent addition (e.g. daily) of fresh material upon necessity. Solid manure is removed at the end of the rearing cycle. The housing system can be equipped with natural or forced ventilation and combined with a free-range system. In case of deep litter combined with slatted floor, the floor is equipped with slats in the drinker area (about 25 % of the total floor area).
Frequent manure removal (in case of fully slatted floor).	Slats cover the pit where the manure is stored and evacuated to the external store. Frequent manure removal to an external store can be done: <ol style="list-style-type: none"> 1. by permanent gravity flow; 2. by scraping with variable frequencies. The housing system can be equipped with natural or forced ventilation and combined with a free-range system.

5.4.13.4 Techniques for reducing ammonia emissions from turkey houses

Technique	Description
Natural or forced ventilation with a non-leaking drinking system (in case of solid floor with deep litter).	The solid floor is fully covered with litter which can be added upon necessity. Floor insulation (by e.g. concrete, clay) prevents water condensation in the litter. Solid manure is removed at the end of the rearing cycle. The design and operation of the drinking water system prevents leakage and spillage of water on the litter. Natural ventilation can be combined with a free-range system.

6 EMERGING TECHNIQUES

6.1 Rearing of poultry

6.1.1 Low-litter flooring system for broilers

Description

Broilers are reared with significantly reduced bedding (e.g. up to one inch of wood shavings/sawdust litter material to help prevent footpad lesion) on a ventilated plenum floor that reduces ammonia generation.

The system consists of two layers of polymer flooring with an air plenum in between. The top layer is perforated and supported by specially designed conical structures attached to the lower layer, to allow the downward wicking of moisture from poultry faeces, which results in much dryer manure. The litter can be removed in accordance with usual practices.

Achieved environmental benefits

The system intends to drastically reduce ammonia emissions by the fast drying of manure combined with a forced ventilation system. The accelerated drying in combination with an inert polymer allows for the manure to maintain an acidic pH which leads to a drastic reduction (quasi-elimination) of ammonia and darkling beetle populations (a major disease vector).

Cross-media effects

The low-litter flooring system may not go down well with consumers.

Environmental performance and operational data

A series of experiments were undertaken at the University of Maryland (US) over a five-year period. Results indicated that as the technique and design were improved, better results for feed efficiency and growth rate were obtained. Although not measured, dust levels were significantly reduced.

Driving force for implementation

As a result of the improved indoor environment, animals can perform more efficiently.

Applicability - Economics - Example plants

No information on cost or availability has been reported. The technique may not be applicable in the EU-28 as it should be recalled that Council Directive 2007/43/EC laying down the minimum rules for the protection of chickens kept for meat production states in paragraph 3 of Annex I that all chickens shall have permanent access to litter which is dry and friable on the surface.

Reference literature

[369, Harter-Dennis 2010]

6.1.2 Sequential feeding in poultry

Description

Sequential feeding is a cyclic feeding programme of two feeds, one high protein-low energy and one high energy-low protein, during one or several days. The nutritional balance that is provided during the growth cycle is no different to standard feeding, so sequential feeding permits the use of a wide spectrum of feed materials, including those which are difficult to incorporate into traditional feed formulae [281, France 2010].

Achieved environmental benefits

Sequential feeding allows the separation of the calcium supply from that of phosphorus. Therefore it should be possible to reduce the phosphorus intake and its release. Additionally, the impact of the utilised raw materials can also be reduced.

Cross-media effects

No information provided.

Environmental performance and operational data

An experiment was carried out in France to investigate the energy (2 800 kcal/kg and 3 200 kcal/kg) and protein (230 g/kg and 150 g/kg) content effects on the daily feed intake of a 48-hour sequential feeding cycle, compared to a standard diet. Feed intake was similar with both sequential feeding and the standard diet but high-energy feed was overconsumed during the first hour of distribution, but this was compensated for over the rest of the day. Growth performance was not modified.

It was also found that there was a strong link between the feed composition and its characteristics (colour and energy content) and birds could learn to recognise the types of feed and therefore self-select for a preferential ingestion.

Applicability

The technique requires more research into the commercial application and potential impacts.

Economics

No information provided.

Driving force for implementation

The technique allows a great flexibility in the diet formulation in order to reduce the feed costs. The technique makes it possible to decrease the incidence of locomotive disorders by increasing the animals' activity. Animals would spend more time pecking less attractive feed.

Example plants

No information provided.

Reference literature

[281, France 2010] [446, Bouvarel et al. 2007]

6.2 Rearing of pigs

6.2.1 Air cleaning of underfloor exhaust airflow with fully slatted floors

Description

In addition to the room air extraction outlet, the pen is equipped with an underfloor pit exhaust above the slurry surface. Only the exhaust air extracted from the underfloor pit is treated by an air cleaning system (e.g. wet scrubber). The mass flow of the discharged air passing through the air treatment system is thus only a small fraction of the overall air renewal rate, which is determined by the fresh air requirements of the animals. In contrast, the partial flow directed to the air treatment unit contains a large fraction of the air-polluting substances (ammonia and odour). The exhaust air passing through the above-floor ventilation system is less polluted and is released without air cleaning. The openings area of the slats in the fully slatted flooring is reduced by 40 % in order to improve the underfloor extraction efficiency. Still, because of the width of the slatted floor and the pressure distribution, it is not possible to completely prevent air passing from the underfloor compartment into the above-floor compartment. A layout of the system is shown in Figure 6.1.

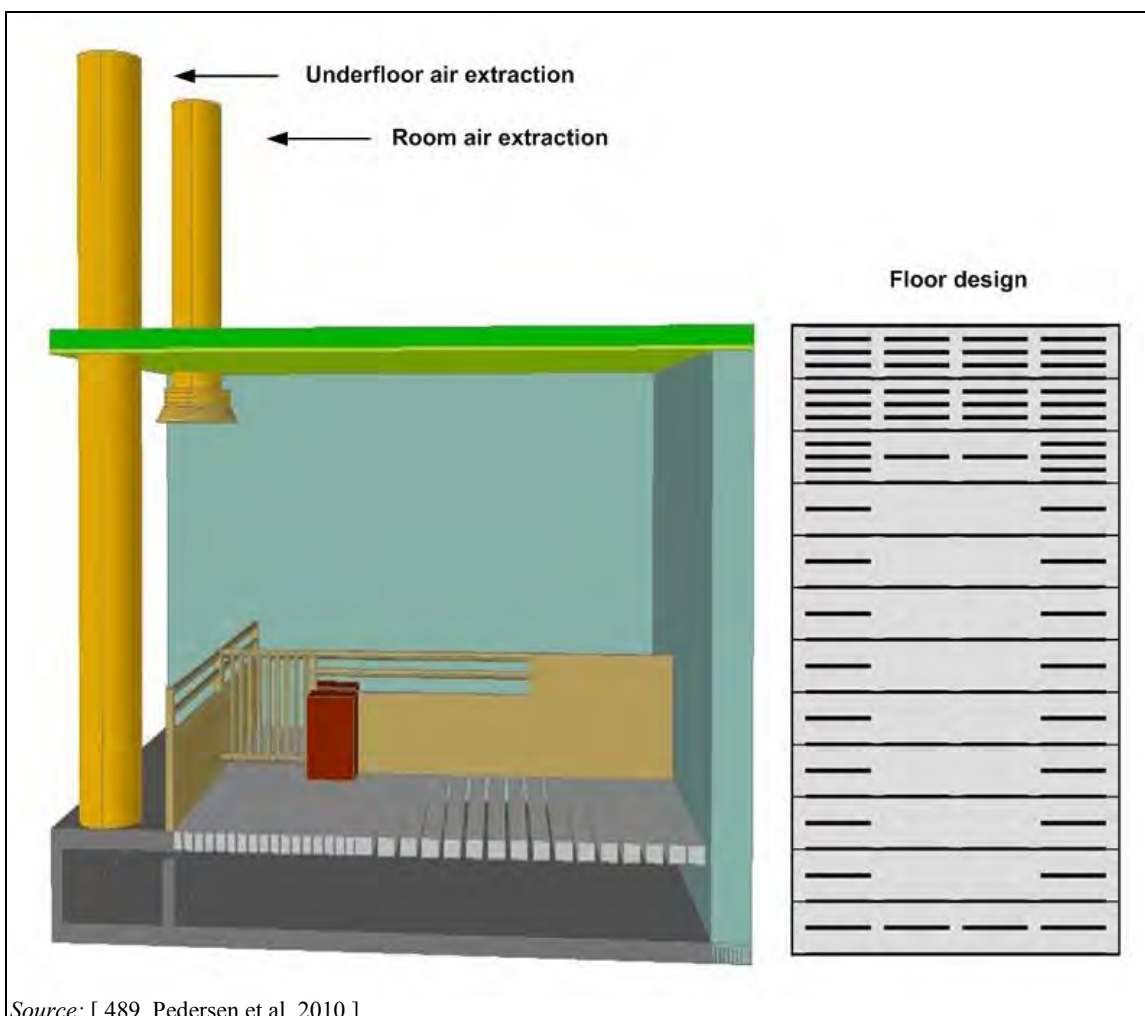

Source: [489, Pedersen et al. 2010]

Figure 6.1: Layout of the ventilation system (left) and the floor design (right) with reduced slat openings

In another configuration of the technique, exhaust air is sucked out via linear outlet channels located under the ceiling and via underfloor air extraction above the slurry surface with following air cleaning [620, Germany 2013] [671, Krause et al. 2009].

Achievable environmental benefits

The system reduces aerial pollutant emissions.

Cross-media effects

No information provided.

Environmental performance and operational data

An experimental study in Denmark comparing the technique with a conventional system with only room exhaust has shown that a pit ventilation rate of only 10 m³/hour per pig improves the indoor environment substantially and reduces the emissions from the room exhaust. In particular, at least 70 % of the ammonia emissions, 50 % of the odour emissions and 90 % of the hydrogen sulphide emissions are expected to be avoided in comparison with the system with only room extraction. Measured odour, hydrogen sulphide and ammonia concentrations and emissions are presented in Table 6.1 for different pit ventilation rates and suction point locations in comparison with a control room having only conventional room exhaust.

Table 6.1: Odour, hydrogen sulphide and ammonia concentrations and emissions

Measurement	Control room	Experiment 1		Experiment 2	
		Pit	Room	Pit	Room
Ventilation rate, m ³ /h/pig	53	20	43	19	39
Odour concentration, ou _E /m ³	360	820	140	910	170
Odour emission, ou _E /s per 1 000 kg	80	64	22	71	27
H ₂ S-concentration, ppb	197	505	70	475	30
H ₂ S-emission, mg H ₂ S/h per pig	4.3	3.8	1.1	4.0	0.4
Measurement	Control room	Experiment 1		Experiment 2	
		Pit	Room	Pit	Room
Ventilation rate, m ³ /h per pig	50	22	33	18	31
NH ₃ concentration, ppm	7.4	14	1.5	18	1.1
NH ₃ emission, g NH ₃ -N/h per pig	7.3	5.2	1.0	6.4	1.1
Measurement	Control room	Experiment 3		Experiment 4	
		Pit	Room	Pit	Room
Ventilation rate, m ³ /h/pig	52	10	49	10	48
Odour concentration, ou _E /m ³	480	890	170	1 230	200
Odour emission, ou _E /s per 1 000 kg	99	31	33	47	38
H ₂ S concentration, ppb	246	485	87	777	22
H ₂ S emission, mg H ₂ S/h per pig	4.8	2.0	1.4	3.0	0.3
Measurement	Control room	Experiment 3		Experiment 4	
		Pit	Room	Pit	Room
Ventilation rate, m ³ /h per pig	50	10	43	11	39
NH ₃ concentration, ppm	9.3	20	2.6	27	2.2
NH ₃ emission, g NH ₃ -N/h per pig	8.2	3.6	2.0	4.7	1.5
NB: Data measured at a pit exhaust rate of 10 m ³ /h and 20 m ³ /h per pig (32 pigs per pen). Experiment 1: Suction point underneath the dunging area, 20 m ³ /h per pig in the pit exhaust. Experiment 2: Suction point underneath the resting area, 20 m ³ /h per pig in the pit exhaust. Experiment 1: Suction point underneath the dunging area, 10 m ³ /h per pig in the pit exhaust. Experiment 2: Suction point underneath the resting area, 10 m ³ /h per pig in the pit exhaust.					
Source: [489, Pedersen et al. 2010]					

It is expected that, by cleaning around 20 % of the maximum ventilation capacity of a house with an air scrubber with 95 % ammonia reduction efficiency, more than 65 % of the total emitted ammonia can be abated by the air treatment system.

In Germany, ammonia concentrations in the animal house air above the slatted floor have been shown to reach maximum values of about 4 ppm when both underfloor and above-floor ventilation systems are running and of about 2 ppm during wintertime when only the underfloor ventilation system is running. The ammonia emissions are expected to be reduced by around 70 % in total. In addition, emissions of dust and odour are reduced. A homogeneous flow field with moderate flow velocities of the air throughout the whole animal house can be attained by optimising the location and dimension of the supply and the exhaust openings. Thus the transfer of ammonia from the slurry surface into the animal house air is minimised.

Applicability

The technique is applicable to pig housing systems with a slatted floor.

Economics

As only a fraction of the exhaust air has to be cleaned, the dimension of the air treatment unit and the operating costs for energy and water are reduced. The cost saving is expected to be about 50 % compared to standard air treatment systems.

Driving force for implementation

The optimised airflow reduces the concentration of ammonia and other pollutants in the indoor air which improves animal welfare and occupational safety.

Example plants

The technique is under development for a full-scale implementation. Attention is focused on the design of a central pit ventilation system to ensure uniform pit ventilation and the dimensioning of partial pit ventilation with an efficient air cleaning system to create a cost-efficient solution.

Reference literature

[489, Pedersen et al. 2010] [620, Germany 2013] [671, Krause et al. 2009]

6.2.2 Air cleaning of underfloor exhaust flow with partly slatted floors with a scraper and urine separation

Description

In this pig housing system ('Perstrup system'), the partial underfloor air extraction is combined with the in-house separation of faeces and urine. In particular, the technique features pens with a partly slatted floor and a sloped manure channel with a gutter for urine drainage from where manure is frequently removed using a scraper. Partial air extraction from the manure channel is done directly through a ventilation channel under the solid part of the pen floor (see Figure 6.2) while the remaining exhaust air is evacuated through a separate outlet in the room.

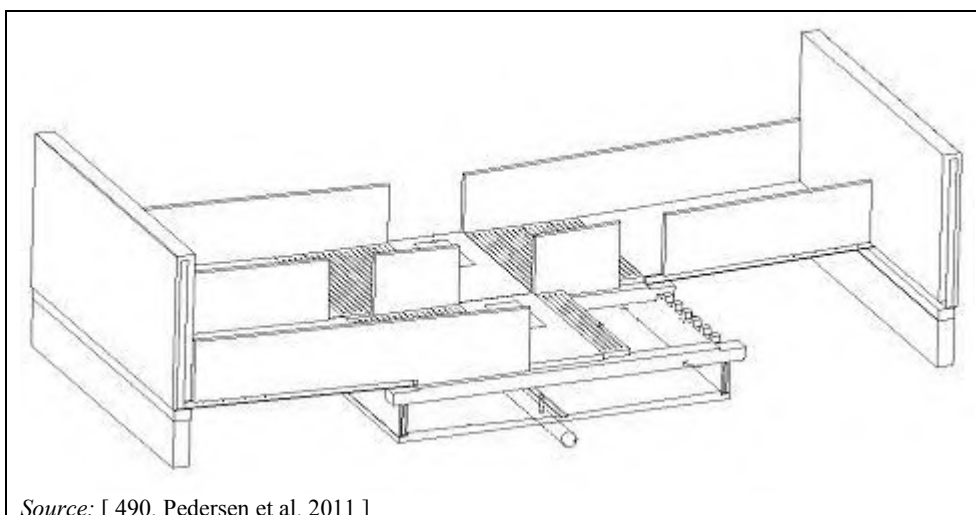

Source: [490, Pedersen et al. 2011]

Figure 6.2: Drawing of the partly slatted floored 'Perstrup' pens

Achieved environmental benefits

The underfloor air evacuation is very efficient at reducing the ammonia concentration in the room.

Cross-media effects

An increase in the odour emissions of the underfloor exhaust air is reported after the installation of the in-house urine separation system.

Environmental performance and operational data

In a study conducted in Denmark, the system was evaluated in a fattening pig farm against a system with only a manure channel (without separation) and partial underfloor evacuation, with respect to ammonia and odour concentrations and the pig manure emissions and separation efficiency. Results are shown in Table 6.2.

Table 6.2: Average concentrations and emissions of ammonia and odour measured in trials with underfloor ventilation

Parameter	Units	Housing system	
		Slurry channel without in-house separation	Slurry channel with in-house separation
Room ammonia concentration	ppm	0.3	0.3
Underfloor ammonia concentration	ppm	5.6	5.5
Ammonia emission per section	g NH ₃ -N/h	59	60
Room odour concentration	ou _F /m ³	483 (388–601)	474 (381–589)
Underfloor odour concentration	ou _F /m ³	737 (609–890)	913 (757–1 102)
Odour emission	ou _F /s per 1 000 kg	313 (266–368)	363 (309–426)
NB: The 95 % confidence interval is reported in brackets.			
Source: [490, Pedersen et al. 2011]			

The statistical analysis showed no differences in ammonia emissions between the control room and the room equipped with in-house separation. However, the ammonia concentrations in the room were very low compared with the exhaust air beneath the slats due to a very efficient underfloor evacuation. On average, the NH₃ concentration was below 0.5 ppm in the room and about 10 times lower than at the underfloor outlets. In conclusion, the slurry surface below the slats was the major source of ammonia emissions.

It was also shown that even at ventilation rates below 20 % of the maximum capacity, i.e. 20 m³/h per pig place, the underfloor air evacuation was very efficient. Former Danish studies have shown that an average air velocity of 0.1–0.2 m/s through the slats is crucial to obtain efficient underfloor air evacuation. At a ventilation rate of 20 m³/h per pig place, the air velocity can be calculated as 0.14 m/s in the Perstrup pig house.

With an efficient underfloor air evacuation, more than 90 % of the ammonia emission can be collected in just 20 % of the maximum ventilation capacity.

On the other hand, odour emissions were 16 % higher in the room with in-house separation due to the higher odour concentrations in the outlets from the underfloor air evacuation.

The in-house separation of urine showed high separation efficiencies; in particular, the collected solid manure contained on average 22 % DM or 93 % of the total amount of DM. However, the dry matter content in the solid fraction was too low and the amount of solid manure was too large (53 % of the total) to make the system economically viable. There is a further need for improvement in order to increase the dry matter content and reduce the amount of manure collected in the solid fraction to less than 25 % of the total amount.

Driving force for implementation

In areas where farmers are obliged to transport slurry over long distances, there is an incentive to reduce bulk slurry volumes. The natural separation of the manure inside the pig house will reduce the volume to be transported. If an air scrubber is installed for ammonia reduction, costs will be substantially lower.

Reference literature

[490, Pedersen et al. 2011]

6.2.3 Near-zero-emission stall housing system

Description

The near-zero-emission stall pig housing system (NZES) through which the formation and release of aerial pollutants can be reduced to close to zero. This is achieved by a combination of different measures concerning slurry management (slurry cooling with periodic removal by a scraping system), building design (single room in high-capacity housing with a large air volume) and ventilation (high-efficiency ventilation). An exhaust air treatment system is installed too. The system also combines design elements which offer advantages concerning animal welfare (e.g. fully automatic dosage of corn silage to be used as occupational material and offering more space per sow). Feeding crates for gestating sows are also provided to minimise stress and aggression in group housing.

The several existing measures that are now combined are as follows:

- Slurry below the slatted floor is cooled by water pipes, which are enclosed in the concrete of the channels (see Figure 6.3). Cooling slurry down to approximately 15 °C reduces the formation of air pollutants, in particular ammonia, very efficiently. Heat pumps allow the extracted heat to be recovered, e.g. for the piglets' nest. This in turn causes a significant energy saving.
- Manure channels are shallow. Approximately three times a week the slurry is removed by a manure scraping system. In this way, the amount of slurry inside the animal house, and therefore the emission of air pollutants, is reduced to a minimum.
- House construction (the building is shaped in such a way that the roof also makes up the ceiling and the various production areas are located in only one space) offers three times more air volume per animal than conventional pig housing systems (see Figure 6.4). This leads to a distinctly lower ventilation rate, and hence enables energy savings. In addition,

as heat rises, this housing system allows a continuous discharge of heat out of the animal area, which results in lower temperatures in the slurry area.

- A certified air cleaning system removes at least 70 % of the ammonia, odour and dust from the waste air. Due to the lower ventilation rates and concentration of harmful gases, it is possible to reduce the size of the exhaust treatment unit. This lessens the use of resources (energy, water, and auxiliary material), as well as lowering investment and operating costs.

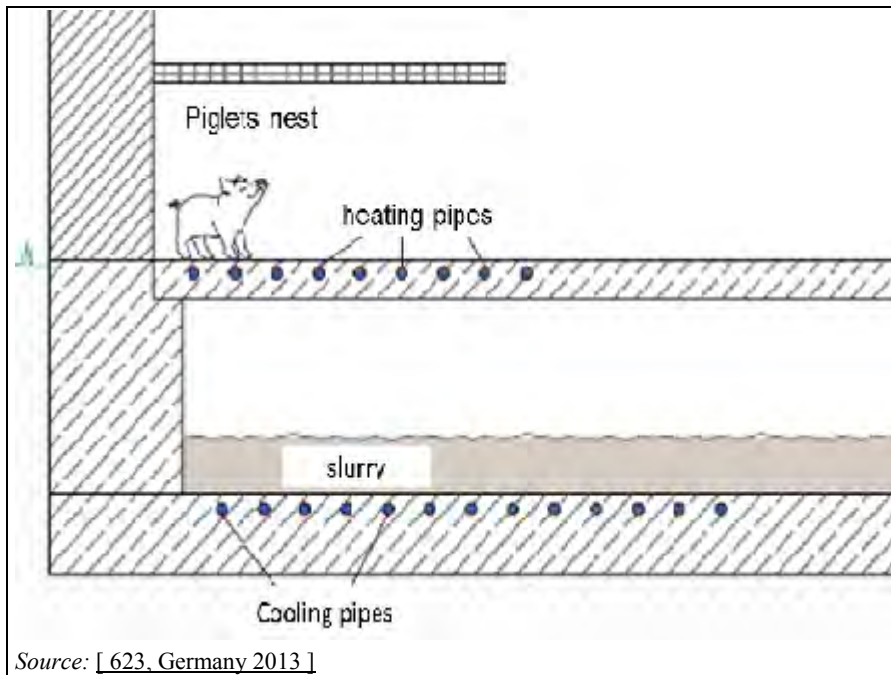

Figure 6.3: Scheme of slurry cooling in the shallow manure channels and heated piglet area



Figure 6.4: Gestating sow room of the near-zero-emission pig housing system showing the 'roof-ceiling' construction principle

Achieved environmental benefits

Ammonia, odour and dust emissions are reduced to a very low level.

The integrated ventilation and heat exchange concept enables significant energy savings. The use of resources for the operation of the exhaust air treatment (energy, water and auxiliary materials) is reduced.

The lower in-house temperature results in a better indoor air quality due to the lower concentration of harmful gases.

Economics

Compared to standard systems, the building costs per piglet are expected to be lower, based on the sophisticated construction of the roof, the one-room design, and the shallow manure channels.

Lower levels of pollutants in the housing air and a lower ventilation rate will result in less investment and lower operating costs for exhaust air treatment in comparison to conventional systems.

The complete system is designed to minimise labour costs.

Driving force for implementation

The system offers benefits in animal welfare and working conditions due to the improved indoor air quality and housing climate. Animals are supplied with considerably more space than legally required. The improvement of animal welfare in combination with the better housing climate is expected to lead to improved performances. Additionally, staff should suffer less respiratory tract infections, e.g. caused by ammonia.

The reduction of the total emissions to close to zero provides the possibility to locate bigger animal housing units close to residential areas and nature reserves.

Piglet mortality rates are expected to decrease, especially with the spacious farrowing pen, because the sow's cooled surroundings will force piglets to move quickly back to their nest.

By providing 'self-protecting feeding crates', stress and aggression among gestating sows are expected to be reduced. In addition, within the farrowing area, management will be improved considerably by having all farrowing pens in one room.

Example plants

The first housing project has started and is under construction (2013).

Reference literature

[623, Germany 2013]

6.2.4 Photocatalytic titanium dioxide coating paints

Description

Titanium dioxide (TiO₂) catalytic paint can be used for coating the walls of pig houses in order to reduce the indoor concentration of ammonia and its release to the outdoor environment.

Through photocatalytic oxidation, TiO₂ can degrade ammonia in water solutions and in the air leading to the production of N₂, N₂O or NO and water along one of the three following main paths:

- $2 \text{NH}_3 + 1.5 \text{O}_2 = \text{N}_2 + 3 \text{H}_2\text{O}$
- $2 \text{NH}_3 + 2 \text{O}_2 = \text{N}_2\text{O} + 3 \text{H}_2\text{O}$
- $2 \text{NH}_3 + 2.5 \text{O}_2 = 2 \text{NO} + 3 \text{H}_2\text{O}$.

Photocatalysis is an accelerated photoreaction in the presence of a catalyst consisting of the chemical transformation of a substrate, without it undergoing any transformation itself.

Cross-media effects

In the Safety Data Sheet available from producers, it is stated that paints have no negative effect on animal and operator health.

Achieved environmental benefits

Field experiments tested the difference in ammonia concentration between houses coated with conventional paint and others painted with TiO₂ paint. The average daily concentration of ammonia was lower for the TiO₂ paint treatment by 1.65 mg/m³. The ammonia reduction efficiency of the paint treatment was 30.50 %. GHG measurements were also lower in houses coated with TiO₂ paints.

Economics

The cost of treating a surface of 150 m² with TiO₂ paint at 70 g/m² is EUR 126. Hence the cost of abating 1 kg of ammonia is estimated to be EUR 3.1.

Reference literature

[286, Guarino et al. 2008]

6.2.5 Alternative farrowing pens

Description

A non-crate alternative farrowing pen for indoor accommodation has been developed in the UK under the PigSAFE project (Piglet and Sow Alternative Farrowing Environment). In this system, sows are not confined in their movement and there are embedded design features which provide adequate protection to piglets. Furthermore, no practical constraints exist on the types of enrichment which can be commercially used to allow expression of nest-building behaviour. The farrowing system comprises a nest area with straw and piglet protection features, a heated creep, a slatted dunging area and a lockable sow feeder (see Figure 6.5).

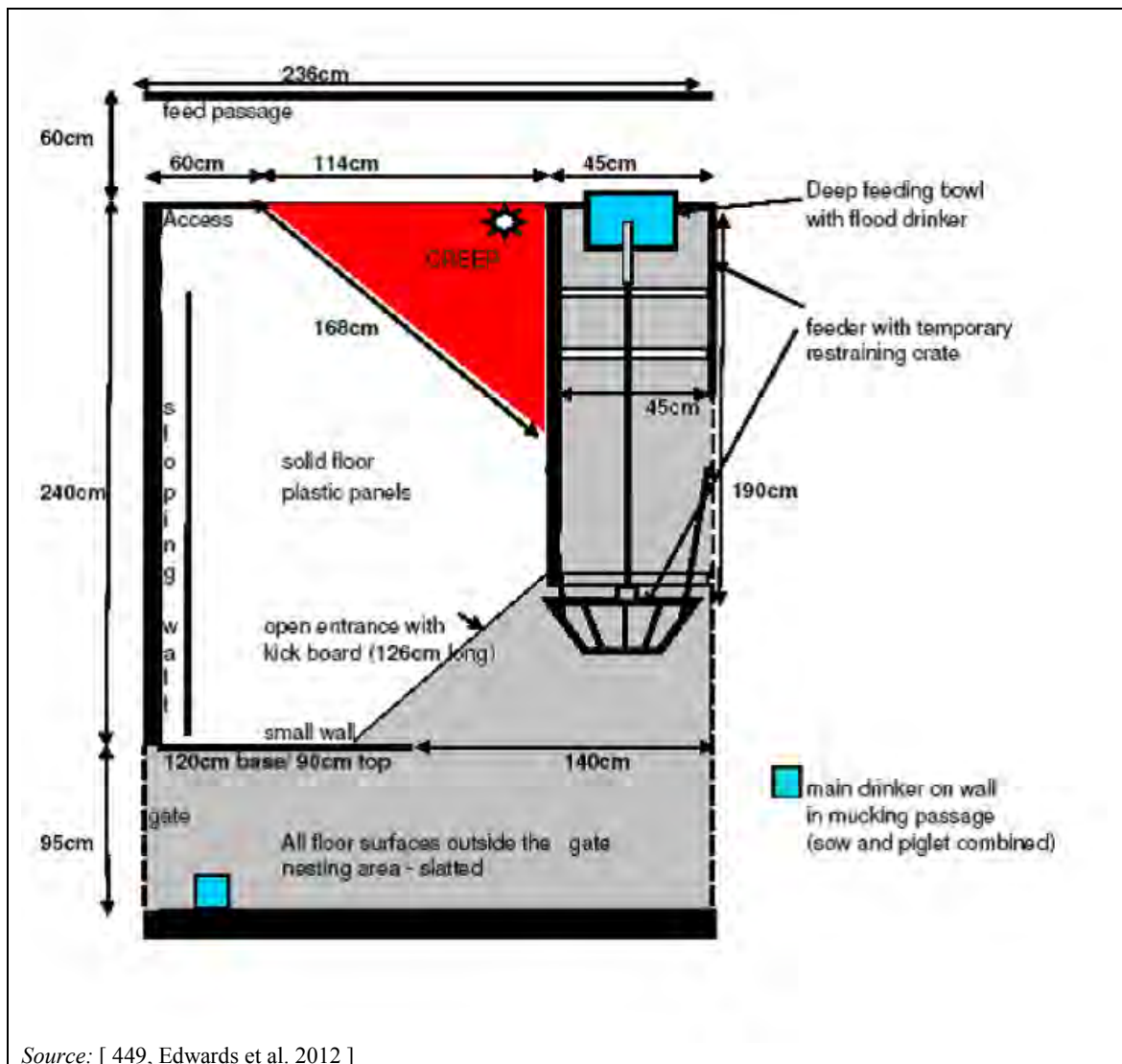

Figure 6.5: An illustration of a design for an alternative farrowing sow pen

Achieved environmental benefits

No information provided.

Environmental performance and operational data

The system has been initially evaluated at two farms against conventional farrowing crates under the same commercial management. At the first farm the system was implemented on a partly slatted floor with minimal straw addition and at the second on a straw-based solid floor with a slatted dunging passage. At both sites results were promising, with no significant performance differences between the alternative pens and the conventional farrowing crates (e.g. regarding mortality of live-born piglets until weaning, and sow and piglet performance), or even better results were achieved with the PigSAFE design, for example concerning the labour to perform daily husbandry routines.

Economics

Modelling of the production costs of different housing systems for farrowing sows indicated that the costs of pig production using the PigSAFE system would be approximately 3.5 % higher than using a standard farrowing crate, assuming equitable pig performance and taking account of both capital and operating costs (feed, labour, bedding, etc.). This arises because of the higher capital cost associated with the greater space requirements (almost double) and more complex pen construction in the PigSAFE design. Any improvement in pig performance (e.g. through reduced piglet mortality, improved weaning weight or sow re-breeding) would narrow

the cost difference. An indicative capital cost is reportedly around EUR 5 000/sow place and the total annual costs of the system around EUR 580/sow place/year in comparison with EUR 3600/sow place and EUR 420/sow place/year respectively for a conventional system with farrowing crates (values in EUR as per exchange EUR 1 = GBP 0.88).

Driving force for implementation

The system can offer a better welfare alternative for housing during farrowing and lactation, incorporating features to reconcile the behavioural needs of the animals with good piglet survival rates and farm practicality.

Example plants

The alternative pens are installed in two commercial farm production systems for their evaluation.

Reference literature

[[449, Edwards et al. 2012](#)]

6.3 Manure processing

6.3.1 Combined biological manure processing and ammonia stripping

Description

The manure processing system is based on a combination of mechanical separation and biological treatment followed by nitrogen separation by ammonia stripping.

In the first treatment stage, the slurry is separated into solid and liquid fractions using a series of mechanical and flocculation processes. Raw slurry is pumped from a temporary storage tank onto a filter belt press, which removes 1–2 % of the dry matter content. The liquid fraction is then treated with polymers to increase the flocculation and sedimentation of the remaining dry matter. The sediment from flocculation and the solids from the belt press are then further separated, using a screw press, into a solid fibre fraction that contains most of the phosphorus from the raw slurry (> 90 %). The liquid fraction leaving this treatment stage has a dry matter content of about 1 %.

The next stage is an aerobic biological treatment carried out in treatment tanks connected in series to separate nitrogen from the liquid fraction (see Section 4.12.3.1.1). Gases released during the aerobic biological activity are collected and led to a sulphuric acid air scrubber. Heat produced during the biological treatment can be recovered.

After biological treatment, NH_3 stripping is carried out by conducting a series of repeated stripping cycles. At first, the biologically treated liquid fraction is air-stripped without chemical use in order to take advantage of the pH rise achieved with biological treatment. The first stripping reduces the buffering capacity of the slurry due to ammonia and carbonate removal, and thus reduces the chemical additions needed.

Before the second stripping, the pH of the stripped effluent is raised by the addition of chemicals such as MgO , $\text{Ca}(\text{OH})_2$ or NaOH . Further stripping cycles can be carried out, increasing the pH by increments, until the desired ammonia level in the liquid fraction is obtained. Air from the stripping tower is led to an acid scrubber, which is independent of the scrubber used for the biological treatment described above.

After the stripping procedure, the treated effluent is devoid of nitrogen and phosphorus and can be directly landspread or further fractionated if organic matter is precipitated by the addition of a small amount of ferric sulphate. The end products of the whole process (including fractionation) are phosphorus fertiliser, NH_4SO_4 concentrate as liquid fertiliser and irrigation water.

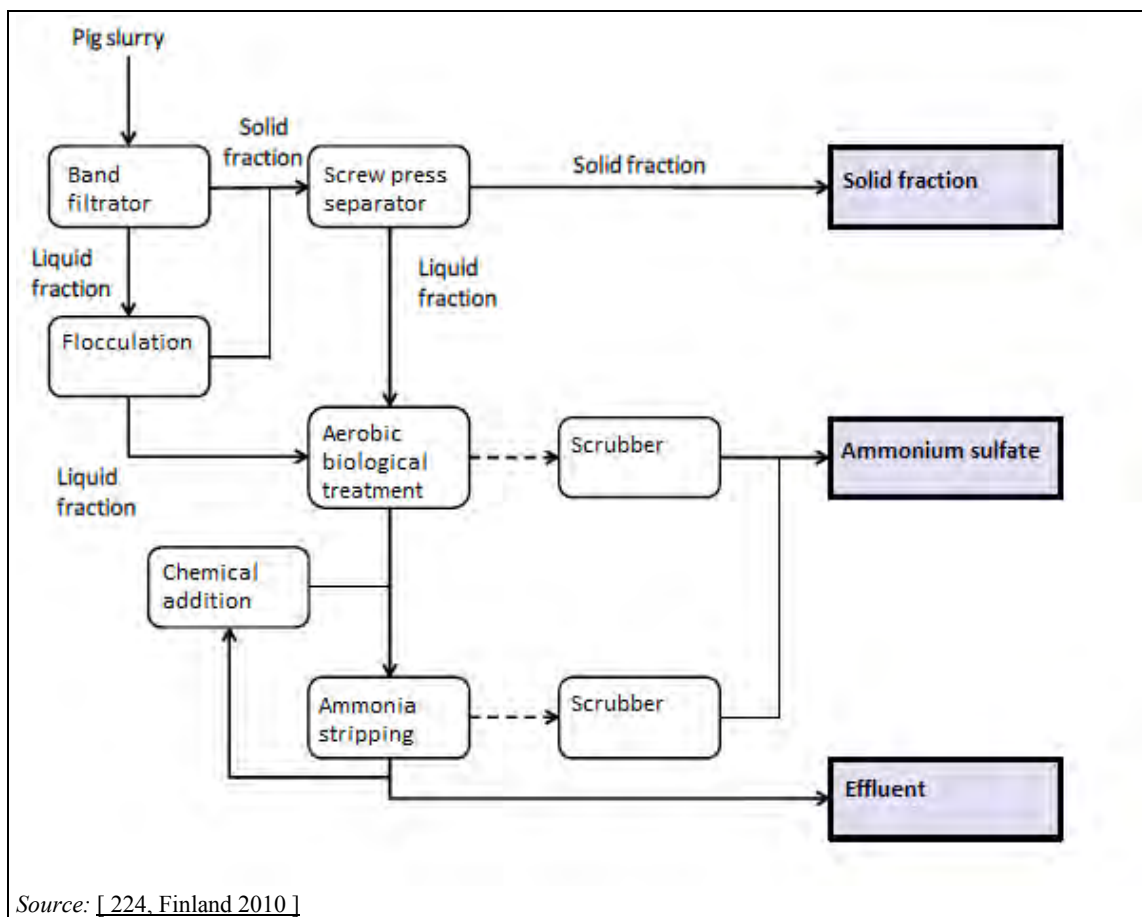

Source: [224, Finland 2010.]

Figure 6.6: Schematic representation of the combined treatment system including the solid separation step, biological treatment procedure and ammonia stripping stages

Achieved environmental benefits

The solid fraction from the separation process contains high levels of phosphorus (> 90 %), and is easily transportable over further distances. The final effluent after aeration treatment and ammonia stripping is completely odourless and free of pathogenic organisms.

The combination of various processes in a sequence (aerobic biological treatment, air stripping and chemical treatment) allows efficient ammonia removal with minimal chemical use.

Cross-media effects

Electrical energy is required to operate the system.

Environmental performance and operational data

Reported data on nitrogen reduction with the stripping sequence are summarised in Table 6.3.

Table 6.3: Nutrient content of the resulting fractions after the multi-step biological and chemical manure processing

Untreated slurry (¹)	Total P	Soluble P	Total N	NH ₄ -N	NO ₃ -N
	kg/m ³	kg/m ³	kg/m ³	kg/m ³	kg/m ³
	0.72	0.26	2.40	1.90	0.0
Separated P fraction	%	%	%	%	%
	2.0	0.51	0.64	0.09	0.01
NH ₄ SO ₄ solution	NA			%	NA
				14.00	
Separated water	mg/l	mg/l	mg/l	mg/l	%
	0–1	0	0–50	0–30	0
⁽¹⁾ Dry matter 3.14 %. NB: NA = not applicable. Source: [500, IRPP TWG 2011]					

Applicability

No restriction is reported for the application of either existing or new farms.

Economics

Depending on the size and the system, costs of installation may vary from EUR 150 000 to EUR 200 000. With an expected lifespan of 15 years and 5 % amortisation, the annualised investment costs would be around EUR 18 330.

Driving force for implementation

Separation reduces the costs of manure storage, transportation and application which are key factors in intensive livestock areas.

Reference literature

[224, Finland 2010] [500, IRPP TWG 2011] [622, Alitalo et al 2011] [401, Finland 2013]

6.3.2 Phosphorus separation by gypsum-based precipitate**Description**

Gypsum- and magnesium oxide-based precipitate is mixed with slurry (2–6 kg per tonne of slurry depending on the dry matter content of the slurry) or solid manure. After reaction, the dissolved phosphorus in the slurry is precipitated as cadmium and magnesium salts and settles with fibrous phosphorus at the bottom of the slurry store. The two fractions can be pumped out of the tank separately: the liquid fraction (rich in nitrogen and potassium) can be landspread where phosphorus fertilisation is not needed and the sediment fraction (rich in phosphorus) can be transported to fields where phosphorus is required.

Achieved environmental benefits

A more focused balance of phosphorus fertilisation is achieved. A more efficient phosphorus utilisation in agriculture will result in decreased phosphorus losses to water. According to the preliminary results, the precipitation also decreases ammonia volatilisation.

Cross-media effects

Gypsum addition to slurry or manure can enhance the potential of H₂S generation [624, IRPP TWG 2013].

Environmental performance and operational data

Depending on the slurry temperature, the fractionation and sedimentation of phosphorus will take between 3 days and 3 weeks.

Only conventional farm machinery is needed. The precipitate is handled in 600–700 kg bags and can be applied with a forklift and mixed with the propeller mixer (1 to 10 hours depending on the volume of the slurry store). Gypsum and MgO can be added from separate bags. Both fractions are pumped out of the tank with a transfer pump to be transported and spread with conventional spreading equipment.

Applicability

Applicability may be restricted due to the possibility of harmful H₂S emission; a risk assessment is necessary.

Economics

No particular investment is needed. Compared to conventional slurry management, additional costs include raw material and extra work due to the precipitate application. Process profitability depends on the price of the chemicals needed and the transport distance for the phosphoric deposit.

Driving force for implementation

Phosphorus from manure can be directed to those fields in which crops would benefit from phosphorus fertilisation. The low phosphoric liquid fraction is spread on phosphorus-rich fields which are usually located near the animal houses, while the fibrous fraction could be transported at a reasonable cost and spread on more distant fields with a lower soil phosphorus content. Additionally, when spread on the field, gypsum and MgO act as sources of cadmium, magnesium and sodium nutrients for the plants.

Reference literature

[225, Finland 2010]

6.3.3 Electro-oxidation/electro-coagulation

Description

The objective of the electro-oxidation technique is to oxidise components such as organic matter in the anode of an electrochemical reactor by means of an external electric current. The electro-coagulation technique consists of destabilising suspended, emulsified or dissolved particles within an aqueous media by applying an electric current. The electricity will favour aggregation of colloidal particles in the same way as chemical reagents do in a conventional coagulation-flocculation process.

The techniques are used separately or combined in the following way:

- Oxidation. Aluminium and iron are used as electrodes. By electrolysis of water, 'nascent' active oxygen is generated on anodes that oxidises material in suspension which leads to the degradation of different organic complexes. In this way, there is no need to add a large amount of chemicals to the liquid or to feed O₂ to the cathodes. A prior mechanical filtration of slurry is required in order to maintain the oxidation efficiency.
- Flotation. Electrolysis of water also generates hydrogen on the cathode which forms small bubbles rising to the surface while carrying previously suspended joined particles.
- Coagulation. The aluminium and iron electrodes that can be used in the anode are dissolved as 'sacrifice electrodes'. Fe⁺², as an example, is solubilised in the slurry and acts as a coagulant agent, resulting in the separation of organic matter from water and in the formation of little flakes. The injection of a flocculant in the reactor outlet line will produce an increase in the size of the flakes. Subsequently, these flakes may be removed from the liquid phase by using some separation device such as a band filter. The output of electro-coagulation can also be the input to electro-oxidation.

The presence of colloidal organic matter can interfere with the oxidation efficiency.

Achieved environmental benefits

A high COD removal and organic nitrogen conversion to N-NH₄ is reported for electro-oxidation. The technique also offers the possibility for recalcitrant matter degradation, such as phenols, without reagent addition or electrode sacrifice.

When separated slurry (1.1–1.3 % total solids) is treated with the electro-coagulation technique in combination with a band filter (e.g. a filter press), the proportion concentrated in the solid fraction is reported for TSS and total P to be > 99 %, for total N > 60 %, and for COD > 90 %. As is common for solid-liquid separation techniques, nutrients (nitrogen, phosphorus and potassium) are concentrated in the solid fraction, enhancing the capability of manure management.

With the combined use of the techniques, organic matter and nitrogen compounds are removed from the produced effluent.

Cross-media effects

During the electrochemical treatment of slurry, there is a potential risk of NH₃ and odour emissions. Sacrifice electrodes in electro-coagulation should be regularly replaced.

Environmental performance and operational data

Table 6.4 provides an overview of the characteristics of the matter deriving from pig slurry before and after the treatment.

Table 6.4: Example of concentration levels obtained before and after treatment of pig slurry by electro-coagulation

Parameter	Concentration in pig slurry (mg/l)	Concentration in the solid fraction (mg/kg)	Concentration in the effluent (mg/l)
COD	68 700	84 200	1 053
BOD	8 120	10 400	449
Total N	4 650	1 258	478
NH ₄ -N	3 630	981	538
Total P	4 970	2.52	0.85
Ca	NI	NI	16
Mg	NI	NI	43
K	NI	NI	734
Pb	0.41	5.6	< 0.02
Cd	0.17	6.5	< 0.01
Cr	0.09	12	< 0.05
Cu	48	98	< 0.02
Ni	0.49	< 2	0.10
Hg	< 0.001	< 0.1	< 0.001
Zn	67	154	< 0.02
NB: NI = no information provided.			
Source: [256, VITO 2006]			

Other experiment results from laboratory trials with slurry are presented below.

Table 6.5: Efficiency of a combination of electro-coagulation and electro-oxidation in laboratory trials

Parameter	Concentration in slurry (mg/l)	Concentration in the effluent (mg/l)	Efficiency (%)
COD	12 300	86	99.3
Total N	6 200	22	99.9
N-NH ₄	4 350	4	99.9
Source: [594, Agro Business Park 2011]			

Economics

The operational cost that has been reported for a mobile unit, including the separation and electro-coagulation/flotation, is reported to be EUR 12/m³ of slurry.

Example plants

A mobile system in Flanders operating at a capacity of 60 000 m³/year for 8 hours per day.

Reference literature

[256, VITO 2006] [594, Agro Business Park 2011]

6.3.4 Struvite precipitation

Description

The technique aims to recover nitrogen and phosphorus from slurry in the form of an amorphous magnesium-nitrogen-phosphate salt called struvite (MgNH₄PO₄·6H₂O). It is naturally found in the excreta of seabirds, which is a valuable and slow nitrogen-releasing fertiliser for field crops. It forms as a calcified substance in pipes at waste water treatment plants but can also be recovered from animal manures, via a crystallisation process, and reused separately.

Achieved environmental benefits

A nutrient concentration that can enhance the management of manure/slurry, especially in areas with a nutrient surplus.

Cross-media effects

Stirring needs a small amount of additional energy.

Environmental performance and operational data

To obtain struvite from animal manure, the magnesium content has to be increased by a factor of six (by introduction of the Mg⁺² ion, for instance in the form of Mg(OH)₂ or MgCl₂·6H₂O) and the phosphorus content by a factor of three or four by addition in a soluble form. The resultant crystallised sludge in the reactor is easily removed at the end of the process. pH adjustment will often be necessary to force the process (8.5–10).

Applicability

The precipitation of phosphates from pig slurry appears difficult because 90 % of the phosphates in pig slurry are not present in a soluble form. Therefore, a preceding biological or chemical treatment is always needed. Applicability is limited as it is not considered cost-effective in comparison with aerobic digestion and mechanical phase separation for a similar rate of nitrogen and phosphorus removal.

Economics

Investment costs from a pig slurry pilot plant are reported to range from EUR 4.85 to 7.25 per m³. In a facility capable of treating 10 m³ of pig manure daily, the operating cost of electric power can be estimated as EUR 500–1 000 per year. The total cost of chemicals needed for the precipitation of 1 m³ of pig slurry (with the assumption that the nitrogen concentration in manure is 8 kg per m³) is reported to be EUR 48 ([203, ADAS 2005]). The commercial value of the final product is unlikely to cover the investment and operating costs. A modified precipitation process has been considered where phosphorus is a serious local pollutant.

Driving force for implementation

Struvite can be used directly as a fertiliser with a slow release of nutrients. Dried struvite, depending on the nutrient concentration, can represent an income of EUR 200 per tonne. Struvite precipitates as crystals that can be removed as a dry product which can be transported as a stable fertiliser. This is favoured where phosphorus removal is important.

Example plants

The technique is reported to be in use in the Netherlands in cattle manure processing plants (in cattle manure half of the phosphates are in soluble form).

Reference literature

[203, ADAS 2005] [256, VITO 2006] [594, Agro Business Park 2011]

6.4 Manure landspreading

6.4.1 P Index

Description

The purpose of a P Index is to assess the risk of the release of phosphorus to surface waters and/or to measure the soil phosphorus content, thus avoiding excessive build-up of phosphorus in soils.

The index is an empirical model for weighing several risk parameters into a combined risk factor. It is calculated annually, using specific parameters for a given field. In addition to the crop requirements for phosphorus, the formula considers, for example, run-off components (based on soil tests, rate time and the method of manure application), as well as internal field drainage components (e.g. the presence of tiles, water flow to tile lines, surface water recharge to subsurface flow, soil tests). Furthermore, the P Index considers parameters such as sheet and rill erosion, phosphorus enrichment, total soil phosphorus, filter strip, sediment delivery, distance to a stream, the long-term biotic availability of particulate phosphorus in a surface water ecosystem, etc.

Achieved environmental benefits

The index is a tool to help conservation planners, landowners and land users to evaluate the risk of phosphorus reaching surface waters from a specific site, and to determine which factors present the highest risks and should therefore be considered.

Environmental performance and operational data

A nationally or regionally developed P Index methodology would be preferred, as the relevance of the parameters, as well as the associated phosphorus loss risk, varies between regions and countries. Practical examples are reported below.

Denmark: a P Index has been developed by researchers and tested in cooperation with the farm advisory service with positive results. The index tool is web-based, consisting of precalculated P Index maps covering all of Denmark as well as phosphorus mitigation planning tools. The major challenges to face before its implementation at farm level are the lack of data (mainly on soils' phosphorus status), and the need for additional validation of the model. The user interface requires some practice for prior knowledge.

Finland: researchers have sound experience and competence in assessing risks for phosphorus losses through modelling and research on erosion. Nevertheless, no P Index has been developed yet.

Germany: two tools were developed and introduced as official regulations in 2010: the 'risk maps associated with compulsory use of cultivation practices' and the 'P balance calculation'. These P measures are not similar to a P Index, but focus on the P balance, and they are considered more advanced than a mere P norm.

Norway: a P Index has been developed which is used on a voluntary basis by farmers and their advisers. It is simple and effective in its structure, has an introductory presentation via a web tool and has been proven in practical use. Farmers and their advisers can test the effects on the P Index calculation of different management practices.

Sweden: a P Index has been developed and tested in practice, but has not yet been implemented in agricultural practices. The large amount of baseline data and the individual software required discouraged the practical implementation of the system at farm level. On the other hand, the existing Swedish regulation of maximum animal density in combination with the flat-rate P norm is acknowledged within the research community as a very effective way to avoid high phosphorus surpluses.

UK: a P Index is used to express the phosphorus status of soils in relation to crop requirements when fertiliser planning [500, IRPP TWG 2011].

Reference literature

[619, Baltic Sea 2020 2011]

7 CONCLUDING REMARKS AND RECOMMENDATIONS FOR FUTURE WORK

Timing of the review process

The key milestones of the review process are summarised in Table 7.1.

Table 7.1: Key milestones of the review process of the BREF for the Intensive Rearing of Poultry or Pigs

Key milestone	Date
Reactivation of the TWG	13 March 2008
Call for wishes	8 May 2008
Kick-off meeting	29 June – 1 July 2008
Data collection	February 2010
First draft of revised IRPP BREF	14 March 2011
End of commenting period on first draft (2 000 comments received)	20 May 2011
Second draft of revised IRPP BREF	1 August 2013
End of commenting period on second draft (2 737 comments received)	21 October 2013
Final TWG meeting	17–21 November 2014

During the review process, more than 10 site visits in six EU Member States were carried out, comprising farms of various sizes, configurations and levels of complexity.

Sources of information and information gaps

During the review of the BREF for the Intensive Rearing of Poultry or Pigs (IRPP BREF), around 4 700 comments were made by the TWG. The data collection exercise provided a large basis for emissions data and techniques in use at the farm level. All these documents were assessed by the EIPPCB. As a result, more than 710 documents are referenced in the revised IRPP BREF (see Section 10).

Degree of consensus reached during the information exchange

A high degree of consensus was reached on the BAT conclusions. However, some dissenting views were raised, as described in the following table.

Table 7.2: Split views

BAT conclusion	TWG member	Expression of the split view
BAT 30	Germany and European Environmental Bureau	Germany and the European Environmental Bureau expressed a dissenting view that the applicability of air cleaning systems for new fattening pig plants should be set as 'generally applicable'.
BAT 30	Germany, Denmark, the Netherlands, Sweden, Finland, European Environmental Bureau	A dissenting view was expressed by Germany, Denmark, the Netherlands, Sweden, Finland and the European Environmental Bureau who consider that the upper end of the BAT-AEL range for ammonia emissions to air from an animal house for fattening pigs should be 2.2 kg NH ₃ /animal place/year.
BAT 15	Germany, the Netherlands	Germany and the Netherlands expressed a dissenting view that the applicability of the technique 'Store solid manure on field heaps placed away from surface and/or underground watercourses which liquid run-off might enter' should be changed to read 'Only applicable as a direct logistic preparation of landspreading activities for a restricted time span (e.g. four weeks without covering and three months with covering) and with a suitable substrate to reduce pollution risks. Field heap locations should be changed at least every year. Sufficient storage capacity on the farm according to BAT 13.d must always be provided'.
BAT 22	Germany, the Netherlands and European Environmental Bureau	Germany, the Netherlands and the European Environmental Bureau expressed a dissenting view by proposing to delete footnote ⁽²⁾ in Table 5.3 related to the BAT-associated time delay between landspreading of solid manure or slurry and incorporation into the soil.
BAT 30	European Environmental Bureau, Austria, Finland, Denmark, the Netherlands	The European Environmental Bureau, supported by Austria, Finland and Denmark, expressed a dissenting view that housing systems with fully slatted floors should not be applicable to new plants for fattening pigs and weaners. The split view is supported by the Netherlands only for fattening pigs.

Consultation of the Forum and subsequent formal adoption procedure of the BAT Conclusions

In accordance with Article 13(3) of the Directive, the Forum gave its opinion on the draft Best Available Techniques (BAT) reference document for the Intensive Rearing of Poultry or Pigs at its meeting of 19 October 2015:

1. The Forum welcomed the draft Best Available Techniques (BAT) reference document for the Intensive Rearing of Poultry or Pigs as presented by the Commission.
2. The Forum acknowledges the discussions held at its meeting of 19 October 2015 and agrees that the changes to the draft Best Available Techniques (BAT) reference document for the Intensive Rearing of Poultry or Pigs, as proposed in Annex A, should be included in the final document.
3. The forum reaffirms the comments in Annex B as representing the views of certain members of the forum but, on which, no consensus exists within the forum to include them in the final document.

Subsequently, the Commission took the opinion of the IED Article 13 Forum into account when preparing the draft Commission Implementing Decision establishing best available techniques (BAT) conclusions for the Intensive Rearing of Poultry or Pigs. The IED Article 75 Committee, at its meeting of 3 October 2016, gave a positive opinion on this draft Commission Implementing Decision.

Subsequently, the Commission Implementing Decision (EU) 2017/302 establishing best available techniques (BAT) conclusions for the Intensive Rearing of Poultry or Pigs was adopted on 15 February 2017 and published in the Official Journal of the European Union (OJ L 43, 21.2.2017, p. 231-279).

Recommendations for future work

The information exchange revealed a number of issues where further information should be collected during the next review of the IRPP BREF. These issues include the need to:

- Collect data on the effect of the sow productivity per year (i.e. number of suckling piglets produced per sow per year) on the total nitrogen excreted.
- Collect more contextual information (e.g. management of animals, nutritional measures) associated with ammonia emissions during the rearing of mating and gestating sows.
- Review the issue of fully slatted floors in pig housing especially in consideration of the future evolution on the legal EU framework and scientific evidence regarding animal welfare.
- Carry out further investigation on the effectiveness of benzoic acid to reduce NH₃ emissions.
- Collect data on the effects of slurry acidification on soil fertility, according to the soil type and climate.
- Collect data on ammonia emissions and the associated housing techniques applied to the rearing of ducks and turkeys (including the distinction between male and female turkeys).
- Collect ammonia emission data from organic livestock production covered by Regulation 834/2007 and on alternative rearing systems for poultry.
- Review the issue on the use of biological and chemical additives and gather further information (e.g. from EFSA).
- Collect information on monitoring of dust and on the determination of emission factors specific to the various housing systems.
- Collect dust and odour emission data with the relevant contextual information in order to assess the possibility of setting BAT-AELs for dust and/or odour emissions from animal houses during the next review of the IRPP BREF.
- Collect ammonia emission data from manure storage and landspreading.
- Urgently improve the quality and comparability of the emission data reported by using monitoring methods based on national or international protocols (e.g. VERA protocol). A very well designed and agreed questionnaire to gather emission data and contextual information will be a key issue for the next review of the IRPP BREF.
- Collect information on the effects of temporary field storage of solid manures on surface and underground water quality and soil nutrient status.
- Collect information and data on techniques associated with the rearing of game birds, laying hen breeders, quails and geese.
- Study information on the relationship between nutrition and odour emissions from pig housing.

- Collect more information on loose-housing systems for sows in the service area and for farrowing sows.
- Collect more information about the effectiveness of feed additives on nitrogen and phosphorus excretion.
- Study the environmental performance of the whole farm by collecting nitrogen and phosphorus surplus and nutrient recovery data.

Suggested topics for future R&D work

The Commission is launching and supporting, through its Research and Technological Development programmes, a series of projects dealing with clean technologies, emerging effluent treatment and recycling technologies and management strategies. Potentially, these projects could provide a useful contribution to future BREF reviews. Readers are therefore invited to inform the European IPPC Bureau of any research results which are relevant to the scope of this document (see also the fifth section of the Preface of this document).

8 GLOSSARY

This glossary is meant to facilitate the understanding of the information contained in this document. The definitions of terms in this glossary are not legal definitions (even if some of them may coincide with definitions given in European legislation), they are meant to help the reader understand some key terms in the context of their use in the specific sector covered by this document.

This glossary is divided up into the following sections:

- I. ISO country codes
- II. Monetary units
- III. Unit prefixes, number separators and notations
- IV. Units and measures
- V. Chemical elements
- VI. Chemical formulae commonly used in this document
- VII. Acronyms
- VIII. Technical definitions

I. ISO country codes

ISO code	Member State ⁽¹⁾
AT	Austria
BE	Belgium
CZ	Czech Republic
DE	Germany
DK	Denmark
ES	Spain
FI	Finland
FR	France
IE	Ireland
IT	Italy
NL	Netherlands
PL	Poland
PT	Portugal
SE	Sweden
UK	United Kingdom

⁽¹⁾ The protocol order of the Member States is based on the alphabetical order of their geographical names in the original language(s).

II. Monetary units

Code ⁽¹⁾	Country/territory	Currency
<i>Member State currencies</i>		
EUR	Euro area ⁽²⁾	euro (pl. euros)
DKK	Denmark	Danish krone (pl. kroner)
GBP	United Kingdom	pound sterling (inv.)

⁽¹⁾ ISO 4217 codes.
⁽²⁾ Includes Austria, Belgium, Cyprus, Estonia, Finland, France, Germany, Greece, Ireland, Italy, Luxembourg, Malta, the Netherlands, Portugal, Slovakia, Slovenia and Spain.

III. Unit prefixes, number separators and notations

Numbers in this document are written using the '.' character as the decimal separator and the space as the separator for thousands.

The symbol ~ (around; approximately) is the notation used to indicate approximation.

The following table contains the frequently used prefixes:

Symbol	Prefix	10 ⁿ	Word	Decimal Number
k	kilo	10 ³	Thousand	1 000
h	hecto	10 ²	Hundred	100
da	deca	10 ¹	Ten	10
-----	-----	1	One	1
d	deci	10 ⁻¹	Tenth	0.1
c	centi	10 ⁻²	Hundredth	0.01
m	milli	10 ⁻³	Thousandth	0.001

IV. Units and measures

Unit symbol	Unit name	Measure name (Measure symbol)	Conversion and comment
A	ampere	Electric current	
atm	normal atmosphere	Pressure (P)	1 atm = 101 325 N/m ²
bar	bar	Pressure (P)	1.013 bar = 100 kPa = 1 atm
°C	degree Celsius, centigrade	Temperature (T)	
°	degree	Slope	
cfu	colony-forming unit	Number of viable bacteria or fungal cells	
cm	centimetre	Length	
CV	French tax horsepower	Power	
d	day	Time	
db(A) or dbA	a-weighted decibels	Sound pressure	
g	gram	Weight	
h	hour	Time	
ha	hectare	Area	1 ha = 10 ⁴ m ²
HP	horsepower	Power	1 HP = 746 watts
J	joule	Energy	
K	kelvin	Temperature (T)	0 °C = 273.15 K
kcal	kilocalorie	Energy	1 kcal = 4.19 kj
kg	kilogram	Weight	1 kg = 1 000 g
kJ	kilojoule	Energy	1 kj = 0.24 kcal
kPa	kilopascal	Pressure	
kWh	kilowatt-hour	Energy	1 kWh = 3 600 kJ
l	litre	Volume	
L _{Aeq}	equivalent continuous a-weighted sound level	Sound exposure level	
lux	lux	Illuminance	1 lux = 1 lumen/m ²
m	metre	Length	
m ²	square metre	Area	

Unit symbol	Unit name	Measure name (Measure symbol)	Conversion and comment
m ³	cubic metre	Volume	
mbar	millibar	Pressure	
mg	milligram	Weight	1 mg = 10 ⁻³ g
min	minute	Time	
MJ	megajoule	Energy	1 MJ = 1 000 KJ
mm	millimetre	Length	1 mm = 10 ⁻³ m
MWh	megawatt hour	Energy	
Nm ³	normal cubic metre	Volume	at 101.325 kPa, 273.15 K
ou _E	European odour unit	Odour concentration	
Pa	pascal	Pressure	1 Pa = 1 N/m ²
ppm	parts per million	Composition of mixtures	1 ppm = 10 ⁻⁶
rpm	Revolutions per minute	Rotational speed, frequency	
s	second	Time	
t	metric tonne	Weight	1 t = 1 000 kg or 10 ⁶ g
t/yr	tonnes per year	Mass flow Materials consumption	
TEQ or I-TEQ	international toxicity equivalents (dioxins and furans)	Toxicity	
U	enzyme unit	Amount of enzyme	
V	Volt	Voltage (V) Electric potential	
vol- %	percentage by volume	Composition of mixtures	
W	watt	Power	1 W = 1 J/s
Wh	watt-hour	Energy	1 wh = 3 600 J
wt-%	percentage by weight	Composition of mixtures	
yr	year	Time	

V. Chemical elements

Symbol	Name
Ca	Calcium
Cl	Chlorine
Cu	Copper
F	Fluorine
Fe	Iron
I	Iodine
K	Potassium
N	Nitrogen
Na	Sodium
Mg	Magnesium
Mn	Manganese
P	Phosphorus
S	Sulphur
Se	Selenium
Zn	Zinc

VI. Chemical formulae commonly used in this document

Chemical formula	Name
CH ₄	Methane
Ca(OH) ₂	Calcium hydroxide
CO ₂	Carbon dioxide
CO	Carbon monoxide
H ₂ SO ₄	Sulphuric acid
H ₂ S	Hydrogen sulphide
HCl	Hydrogen chloride
K ₂ O	Potassium oxide
NaOH	Sodium hydroxide. Also called caustic soda
N ₂	Nitrogen gas
N ₂ O	Nitrous oxide
NH ₃	Ammonia
NH ₄	Ammonium
NH ₃ -N	Ammonia (expressed as N)
NH ₄ -N	Ammonium (expressed as N)
NO ₂ ⁻ -N	Nitrite (expressed as N)
NO ₃ ⁻	Nitrate
NO ₃ ⁻ -N	Nitrate (expressed as N)
NO _x	The sum of nitrogen oxide (NO) and nitrogen dioxide (NO ₂), expressed as NO ₂
O ₂	Oxygen gas
P ₂ O ₅	Phosphate
PCDD - PCFF	Polychlorinated dibenzodioxins - Polychlorinated dibenzofurans
SF ₆	Sulphur hexafluoride
SO _x	The sum of sulphur dioxide (SO ₂) and sulphur trioxide (SO ₃), expressed as SO ₂

VII. Acronyms

List of acronyms commonly used in this document.

Acronym	Definition
ACNV	Automatically controlled natural ventilation
ADEME	Agence de l'Environnement et de la Maîtrise l'Énergie
ap	Animal place. Also see 'bird place' in Glossary VIII
BAT	Best Available Techniques (as defined in Article 3(10) of the IED)
BAT-AEL	Emission levels associated with the BAT (as defined in Article 3 (13) of the IED)
BOD	Biochemical oxygen demand
BOD ₅	Biological oxygen demand measured using a 5-day test
BPC	British Poultry Council
BPEX	A division of the Agriculture and Horticulture Development Board (UK)
BREF	Best Available Techniques Reference Document (as defined in Article 3(11) of the IED)
CEN	Comité Européen de Normalisation (European Committee for standardisation)
CHP	Combined heat and power (unit) (cogeneration unit)
COD	Chemical oxygen demand
CP	Crude protein
DAFC	Danish Agriculture & Food Council
DEFRA	Department for Environment, Food and Rural Affairs (for England and Wales)
DIN	Deutsches Institut für Normung (the German national organisation for standardisation)
DG	Directorate-General (of the European Commission)
DM	Dry matter
EC	European Commission
ECM REF	Reference document on Economics and Cross-Media Effects
EFSA	European Food Security Agency
EIPPCB	European Integrated Pollution Prevention and Control Bureau
ELV	Emission limit value
EMS	Environmental management system
EMAS	European Eco-Management and Audit Scheme (Council Regulation (EC) No 1221/2009)
EN	European Norming or European Norming Standard adopted by CEN
EPA	Environmental Protection Agency (US)
EPER	European pollutant emission register defined in Council Decision 2000/479/EC, now replaced by PRTR
E-PRTR	European Pollutant Release and Transfer Register
ESF	Electronic sow feeder
EU	European Union
EU-15	Member States of the European Union before 1 May 2004
EU-25	Member States of the European Union from 1 May 2004 until 31 December 2006
EU-27	Member States of the European Union from 1 January 2007 until 30 June 2013
EU-28	Member States of the European Union from 1 July 2013
FAO	Food and Agricultural Organisation of the UN
FCR	Feed conversion ratio/rate
FEFANA	EU Association of Specialty Feed Ingredients and their Mixtures
FSF	Fully slatted floor
FYM	Farmyard manure
GHG	Greenhouse gases
GRP	Glass fibre-reinforced plastic
HDPE	High density polyethylene
IED	Directive 2010/75/EU of the European Parliament and the Council of 24 November 2010 on industrial emissions (integrated pollution prevention and control (Recast))
IFIP	Institut du porc Recherche et Expertise pour la filière porcine (The French Pork and Pig Institute)
ILF BREF	2003 Reference Document on Best Available Techniques for the Intensive Rearing of Poultry and Pigs

Acronym	Definition
IMPEL	European Union Network for the Implementation and Enforcement of Environmental Law
INFOMIL	The Dutch information centre for environmental licensing
IPCC	Intergovernmental Panel on Climate Change
IPPC	Integrated Pollution Prevention And Control
IPPC Directive	Directive 2008/1/EC of the European Parliament and of the Council of 15 January 2008 concerning integrated pollution prevention and control (IPPC Directive) that has been replaced by Directive 2010/75/EU on industrial emissions (IED)
IRPP	Intensive Rearing of Poultry or Pigs
IRPP BREF	BAT reference document for the Intensive Rearing of Poultry or Pigs
ISO	International Organisation for Standardization. Also international standard adopted by this organisation
ITAVI	Institut Technique de l'Aviculture (FR)
JRC	Joint Research Centre
KTBL	Kuratorium für Technik und Bauwesen in der Landwirtschaft (DE)
LECA	Light expanded clay aggregate
LU	Livestock unit
LW	Live weight
MAFF	Ministry of Agriculture, Fisheries and Food (UK)
MS	Member State of the European Union
NFU	National Farmers' Union (UK)
NPA	National Pig Association (UK)
NSP	Non-starch polysaccharides
NVZ	Nitrate Vulnerable Zone
PE	Polyethylene (polythene)
PSF	Partly slatted floor
ROM REF	Reference Report on Monitoring of emissions from IED installations
RH	Relative humidity
TAN	Total ammoniacal nitrogen
TGU	Thermostable endo-glycanase unit
TSS	Total suspended solids
TWG	Technical Working Group. Group of experts composed of representatives from Member States, the industries concerned, non-governmental organisations promoting environmental protection and the Commission for the drawing up and review of BREFs
TXU	Thermostable endo-xylanase unit
UBA	Umweltbundesamt (Federal Environment Agency), i.e. from Germany or Austria
UNECE	United Nations Economic Commission for Europe
UV	Ultraviolet
VDI	Verein Deutscher Ingenieure (the association of German engineers)
VERA	Verification of Environmental Technologies for Agricultural Production
VOC	Volatile organic compound
WID	Directive 2000/76/EC of the European Parliament and of the Council of 4 December 2000 on the incineration of waste (Waste Incineration Directive)

VIII. Technical terms

Terms are mostly in line with the 'RAMIRAN Glossary of terms on manure management 2011' [636, Ramiran 2011]. Other sources used are [445, VERA 2011] [494, EFSA 2007] [648, DEFRA 2011].

Term	Definition
A	
Acidification	The process by which soil or surface waters become increasingly acidic (lower pH), e.g. through deposition of ammonia, NO _x or sulphur dioxide.
Ad libitum	The provision of free access to feed or water thereby allowing the animal to self-regulate intake according to its biological needs.
Aerated slurry	Slurry that has undergone the process of aeration, i.e. supply of oxygen using special equipment, to stabilise or purify or to reduce odour or nitrogen content.
Aerobic processes	Biological treatment processes that occur in the presence of oxygen.
Aerosol	Airborne solid particles or liquid droplets.
Air-filled porosity	The proportion of a soil's volume that is filled with air; a low air-filled porosity indicates poor aeration and restricted drainage.
All in - all out system	Batch system.
Amino acid	The chemical units that link together to form proteins and are of fundamental importance to life.
Ammonia	A gas derived from urea excreted by livestock (and from uric acid excreted by poultry) and implicated in acidification, eutrophication and nitrogen enrichment of sensitive ecosystems.
Ammonium	Positively charged ionic form of mineral nitrogen, present in soils, fertilisers and manures. It is not readily leached from soils because it is attracted to soil particles, but can be lost in surface run-off and macro-pore flow where there is only limited contact between the flowing water and soil surfaces. Ammonium in soils is converted to nitrate by the process of nitrification.
Anaerobic processes	Biological treatment processes that occur in the absence of oxygen.
Animal category	The type of animal according to species (pigs, chickens, ducks, turkeys, etc.), sex, age and scope of production (breeding, growing and finishing for meat, or egg production).
Animal house	A general name for a building in which livestock are kept. Also termed livestock house or livestock building.
Animal place	Space provided per animal in a housing system taking into account the maximum capacity of the plant.
Application rate	Normally refers to the mass (tonnes) or volume (cubic metres) of manure applied per unit area (e.g. hectare) of land.
Arable land	Land that is cultivated and sown with temporary crops (cereals, vegetables, root or oil crops, etc.), temporary grass for cutting or grazing, or is temporarily fallow.
B	
Barn	A general name for a farm building used for housing livestock, storing machinery or crops, etc.
Batch storage	Storage method for manures in which, once a quantity of manure has been collected, it is stored without further additions of 'fresh' manure.
Batch system	A method of rearing livestock in which a group of animals, e.g. broilers or pigs, of similar live weight are put into a building or pen and all removed when they have grown to a specified live weight. The building or pen is then cleaned prior to introducing another batch.
Bedding	Material placed on the floor of livestock houses with solid floors or partly slatted floors to provide some comfort to the animals and to absorb moisture and urine. Commonly straw, chopped straw, sawdust, wood shavings, sand, or peat. Rubber or plastic mats may also be provided for animals to lie on.

Term	Definition
Bioaerosol	Aerosol containing biological organisms such as fungi, bacteria, viruses and mycotoxins.
Biochemical oxygen demand (BOD)	The quantity of dissolved oxygen required by microorganisms in order to decompose organic matter to carbon dioxide and water in a given liquid sample at a certain temperature over a specific time period. The unit of measurement is mg O ₂ /l. In Europe, BOD is usually measured after three (BOD ₃), five (BOD ₅) or seven (BOD ₇) days. It is a measure of the (water) pollution potential of organic materials.
Bird place	Synonym of 'animal place' in poultry rearing.
Boar	An uncastrated male pig after puberty, intended for breeding.
Breeders (poultry)	Parent stock (males and females) kept to lay eggs for hatching.
Breeding	The production of offspring from livestock. Breeding stock are animals kept to produce offspring rather than for slaughter.
Broadcast	Uniform scattering of manure over the whole surface of an area of land (as opposed to placement in rows).
Broilers	Chickens reared for meat production.
Broiler breeders	Parent stock (males and females) kept to lay eggs for broiler production.
Broiler litter	Bedding of absorbent material, e.g. sawdust, wood shavings or straw, mixed with droppings on the floor of buildings housing broiler chickens.
Broiler manure	Broiler litter
C	
C : N ratio	The amount of total carbon divided by the amount of total nitrogen contained in livestock manure. Manures with a high C : N ratio such as farmyard manure usually take longer to break down, or mineralise, in the soil than those such as slurry with a lower C : N ratio.
Carbohydrates	Complex organic compounds containing carbon, hydrogen and oxygen that are essential to all living organisms. The energy stored in carbohydrates is released to power living processes.
Carcass weight	Deadweight.
Channel	A long watertight compartment often constructed beneath a slatted or gridded floor in a building designed to collect faeces and urine as slurry or liquid manure prior to discharging under gravity to longer-term storage. A gate valve or sluice gate may be built into the channel to provide short-term storage. Commonly used in housing for fattening pigs.
Chemical oxygen demand (COD)	Amount of oxygen needed for the total oxidation of organic matter to carbon dioxide. COD is an indicator for the mass concentration of the chemically oxidisable organic matter (normally referring to analysis with dichromate oxidation) according to ISO 15705:2002.
Chick	A young bird about to be hatched or newly hatched.
Chicken	Most important poultry species including laying hens and broilers.
Combined heat and power (CHP) plant	An internal combustion engine coupled to an electricity generator. Modified to run on biogas, a CHP plants yields heat, through recovery from the engine cooling system, and electricity.
Compartment	Separate part of an animal house that can be individually ventilated.
Competent authority	The authority or authorities or bodies responsible under the legal provisions of the Member States for carrying out the obligations arising from the IED.
Composite sample	Sample prepared by an operator or by an automatic device and that has been obtained by mixing several spot samples.
Complete feed	Compound feed which, by reason of its composition, is sufficient for a daily ration.
Compound feed	A mixture of at least two feed materials, whether or not containing feed additives, for animal feeding in the form of complete or complementary feed.
Conservation tillage	Any method of soil cultivation that leaves the previous year's crop residue (such as corn stalks or wheat stubble) on fields before and after planting the next crop, to reduce soil erosion and run-off.
Crate	A small pen or container for livestock, allowing very restricted movement.
Crude protein	Total protein of feed, derived by multiplying the amount of nitrogen by a factor of 6.25 since the average nitrogen content of proteins is about 16 %.

Term	Definition
D	
Deadweight	The weight of the dressed or prepared carcass.
Decommissioning	The shutdown of an installation including decontamination and/or dismantling.
Deep litter	Faeces or droppings and urine mixed with large amounts of bedding (e.g. straw, sawdust or wood shavings) and accumulated over a certain amount of time on the floor of buildings.
Deep pit	An underground watertight compartment for collecting and storing liquid manures or slurry or poultry droppings.
Denitrification	The transformation, most commonly by bacteria, of nitrates to nitrous oxide and nitrogen gas. An anaerobic process that occurs in soils and in manure stores and in some treatment methods, after a nitrification period.
Diet	The food offered to livestock.
Digested slurry	Slurry that has undergone the process of anaerobic digestion using a special plant and equipment, to stabilise, purify, reduce odour and produce biogas.
Digestate	The semi-solid or liquid product of anaerobic digestion.
Digestible energy	Digestible energy (DE) is the gross energy of a feed, minus the energy content of the faeces attributable to it.
Dirty water	Waste water.
Disposal	Any operation which is not recovery even where the operation has as a secondary consequence the reclamation of substances or energy (as defined by the EC Waste Framework Directive).
Drake	Male duck.
Droppings	Waste voided by poultry.
Dry matter (DM)	The residue remaining following heating under standard conditions (usually around 105 °C to constant weight) to evaporate water. Often expressed as a percentage of the weight of original material.
Dry sow	Adult female pig between lactations (between weaning of the piglets and the perinatal period).
Duck	Usually denotes a female duck. The male is called a drake.
Duckling	A young duck, usually less than 8 weeks old.
Dunging	The deposition of faeces by livestock but often used to refer to deposition of faeces and urine (e.g. in an animal house or yard) by livestock.
Dust	Small, solid particles that may remain suspended in the air for some time but settle out under their own weight. Includes fine particulate matter which may be collected by filtration from indoor ambient air or air outlet(s) of an animal house. It can be expressed as total dust, PM ₁₀ or PM _{2.5} .
E	
Earth-banked lagoon	Lagoon
Effluent	Liquid stream discharged from a process or a farm.
Emission	The direct or indirect release of substances, vibrations, heat or noise from individual or diffuse sources in the installation into the air, water or land (Article 3(4) of the IED).
Emission factor	Emission level of a given pollutant (gases or particulates) from a given source (e.g. an animal house) to the atmosphere. It can be expressed as the integrated mass emitted per time interval and animal produced (e.g. kg/year/animal), animal place (e.g. kg/year/ap) or livestock unit (e.g. ou _E /s/LU). May also be expressed as a percentage, e.g. % total ammoniacal nitrogen or total nitrogen.
Emission limit value (ELV)	The mass, expressed in terms of certain specific parameters, concentration and/or level of an emission, which may not be exceeded during one or more periods of time.
End-of-pipe technique	A technique that reduces final emissions or consumption by some additional process but does not change the fundamental operation of the core process.
Enzyme	A type of protein present in living organisms that catalyses (speeds up) chemical changes without being changed itself.
Essential amino acids	Those amino acids that cannot be made by a plant or animal but must be obtained from the environment or food.

Term	Definition
Erosion (soil)	Wearing away and loss of soil, principally topsoil, by wind and running water.
Eutrophication	Process of nutrient enrichment in water or soil, resulting in oxygen depletion in aquatic ecosystems, loss of biodiversity, etc. Especially refers to the impact of ammonia and NO _x emissions on terrestrial ecosystems over large parts of Europe.
European odour unit (ou _E)	The unit of measurement for odour concentration. 1 ou _E corresponds to the amount of odorant(s) that, when diluted into one cubic metre of neutral gas at standard conditions, elicits a physiological response from a panel of people (detection threshold) equivalent to that elicited by one European Reference Odour Mass (EROM) evaporated in one cubic metre of neutral gas at standard conditions. One EROM is equivalent to 123 µg n-butanol.
Evaporation	Physical process by which a liquid is changed into a gas.
Excreta	Waste expelled from the body: faeces plus urine.
Exhaust air	Airstream discharged from an animal house contaminated with gaseous or particulate components, normally with low concentrations.
Existing farm	A farm which is not a new farm.
Existing plant	A plant which is not a new plant.
F	
Faecal Indicator Organism	Microorganisms excreted by and present in livestock excreta and manures. Their presence in water indicates contamination by excreta manure; <i>E. coli</i> is the most commonly used faecal indicator organism.
Faeces	Solid waste or undigested material voided by animals.
Fallen stock	Animals which have been killed by euthanasia with or without a definite diagnosis or which have died, including stillborn and unborn animals, on a farm or on any premises or during transport, but which have not been slaughtered for human consumption (from draft regulation on aids to farming).
Farm	An installation as defined in Article 3(3) of Directive 2010/75/EU where pigs or poultry are reared.
Farmyard manure	Faeces and urine mixed with large amounts of bedding (usually straw) on the floor of pig housing.
Farrowing sows	Sows between the perinatal period and weaning of the piglets.
Fattener	Farm that rears fattening pigs.
Fattening	Rearing of livestock for meat production.
Fattening pigs	Production pigs typically reared from a live weight of 30 kg to slaughter or first service. This category includes growers, finishers and gilts that have not been serviced.
Feed	Any substance or product, including additives, whether processed, partially processed or unprocessed, intended to be used for feeding animals.
Feed additives	Substances, microorganisms or preparations, other than feed material and premixtures, which are intentionally added to feed or water in order to perform, in particular, one or more of the functions mentioned in Article 5(3) of Regulation (EC) No 1831/2003.
Feed composition	Descriptions of the individual ingredients that constitute a feed formula and their nutritional value.
Feed conversion rate	Feed conversion ratio.
Feed conversion ratio	A measure of an animal's efficiency at converting feed mass into increases of the desired output, e.g. the amount of feed (kg) needed for 1 kg growth of live weight.
Feed material	Products of vegetable or animal origin, whose principal purpose is to meet animals' nutritional needs, in their natural state, fresh or preserved, and products derived from the industrial processing thereof, and organic or inorganic substances, whether or not containing feed additives, which are intended for use in animal feeding either directly as such, or after processing, or in the preparation of compound feed, or as a carrier of premixtures.

Term	Definition
Feedstuff	Feed.
Fertiliser	Any natural or manufactured material applied to the soil in order to supply one or more plant nutrients. The term is generally applied to inorganic materials that are commercially available.
Fertiliser requirement	The amounts of plant nutrients needed, in addition to those already contained in the soil, to obtain a desired, optimum crop yield.
Fertiliser value	The value or worth of manure (e.g. EUR/m ³) based on the cost of providing the same quantities of plant nutrients that it contains as mineral fertiliser. It should be stated whether this is based on plant available nutrients or plant available nutrient content.
Field drainage	The construction of drains in or under the field to remove surplus water from the land to a ditch.
Field heap	A heap or stack of solid manure stored in a field prior to spreading.
Finisher (pigs)	Growth stage of pigs, between about 50–60 kg and slaughter.
Finishing pig	Finisher.
Flue-gas	Mixture of combustion products and air generated by an incineration process.
Forced ventilation	Mechanical ventilation.
Fogging	Water spraying at high pressure to produce fine droplets that absorb heat and reduce indoor dust concentration.
Foraging	The behaviour of animals when they are moving around in such a way that they are likely to encounter and acquire food for themselves or their offspring.
Free-range	A system for keeping livestock in which the animals are allowed to run free over a field or an area of land. For poultry it means the birds have free access to an outside area during the daytime but are usually housed at night.
Fresh manure	Manure (solid manure or slurry) immediately after removal from the livestock housing.
Front-end loader	A large shovel or bucket mounted on loading arms at the front of a tractor used for handling solid manure. The bucket may have a few short spikes with a back plate or may consist of many long spikes with a back plate.
Fully slatted floor	A floor where the whole area is slatted.
Functional areas	Areas of living space that are dedicated to feeding, drinking and resting or exercising due to the presence of specific equipment.
G	
Gestating sows	Pregnant sows, including gilts.
Gilt	A young female pig before she has produced a litter.
Grassland	Land covered by herbaceous vegetation that is dominated by grass.
Greenhouse gases	Gases that contribute to the greenhouse effect and global warming. They include carbon dioxide, methane and nitrous oxide.
Goose	Large aquatic bird sometimes kept as a domestic animal for meat and for feathers.
Groundwater	Part of subsurface water in the zone of saturation. The upper surface of the saturated zone is called the water table.
Grower (pigs)	Pig from about 28–30 kg live weight fed a diet to achieve high growth rates to about 50–60 kg live weight.
Growers/Finishers	Fattening pigs.
Guinea fowl	A pheasant-like bird from Africa reared for ornamental qualities, meat, feathers for crafts and fly tying, or vermin control.
H	
Heavy metals	A group of metallic elements that include lead, cadmium, zinc, copper, mercury and nickel. Technical literature describes these as metals with a density greater than 4.5 g/ml. They can be found in considerable concentrations in sewage sludge and several other waste materials as well as in smaller concentrations in pig and poultry manure.

Term	Definition
Housing system	A unit with the primary function of providing housing for a specified animal category, and with a specific design, equipment and management that determines its environmental performance. It includes the way a certain animal category is kept (e.g. pen and floor design), the manure storage and management system, the ventilation system installed to control the indoor climate in the building and the type and regime used to provide feed and water to the animals.
Hygienisation	Sanitation.
I	
Insulation	The prevention of the passage of heat in or out of, for example, a livestock building by incorporating non-heat-conducting material into the walls and roof.
Intensive production	Farming characterised by high inputs of capital and resources, etc. that aims to make the best use of the genetic potential of crops and livestock to achieve high outputs.
Ionisation	An electrostatic field is created in the house to produce negative ions. Circulating airborne dust particles are charged by free negative ions; particles are collected on the floor and room surfaces by gravitational force and electrostatic field attraction.
K	
Kennel	A type of pig pen, usually for weaners. It includes a sleeping section with a hinged roof that can be raised or lowered to control temperature and ventilation.
L	
Lactating sow	A sow having recently given birth and producing milk.
Layer	Laying hen.
Layer breeder	Parent stock (males and females) kept to produce fertile eggs for commercial laying hen production.
Laying hens	Grown female chickens for egg production after 16 to 20 weeks of age.
Leachate	Solution obtained by leaching..
Leaching	The loss of soluble elements and compounds from a porous material (e.g. soil) in drainage water to the aqueous environment including groundwater. This applies especially to nitrate leaching.
Liquid fraction	Varying degrees of separation of solids and liquid may occur during the management of manures, giving rise to liquid and solid fractions. There are no specific terms to denote the different types of liquid fractions but their properties vary with the proportions of urine, faeces, bedding and water that they contain. They include: i) seepage or drainage from manure in livestock houses or on concrete surfaces used by livestock, ii) seepage or drainage from solid manure stores, iii) liquid from a strainer box in a slurry lagoon or from a weeping wall store, iv) liquid derived from the mechanical separation of slurry, v) clarified liquid (or supernatant) obtained from the upper layer following the settlement of slurry in a lagoon, and vi) thickened liquid remaining following the settlement of slurry in a lagoon and the removal of the upper layer of clarified liquid (supernatant).
Liquid manure	Slurry
Litter	All the piglets born at one birth.
Livestock	Domesticated animals such as cattle, pigs, poultry, sheep, horses and goats. Any creature kept for the production of food, wool, skin or fur or for the purpose of its use in the farming of the land or for amenity purposes.
Livestock unit (LU)	A unit used to compare or aggregate numbers of animals of different species or categories. 1 LU often equals 500 kg live weight of an animal. Other equivalences can be defined on the feed requirements (or sometimes nutrient excretion).
Live weight	The weight of a live animal (as opposed to the weight of the carcass or deadweight).
M	

Term	Definition
Manure	A general term to denote any organic material that supplies organic matter to soils together with plant nutrients, usually in lower concentrations compared to mineral fertilisers.
Manure belt	Movable belt, e.g. made of 'non-stick' polypropylene, below the cages on which droppings from laying hens are collected and are periodically transported outside the house to closed storage or direct application.
Manure management	The collection, storage, transport and landspreading. It may also include treatment.
Manure pit	An underground store with a watertight floor and walls and a solid or gridded lid commonly used for short-term storage of liquid manure, slurry, dirty water, etc. May be inside or outside a livestock building.
Manure processing	A controlled biological, chemical and/or physical process that changes the properties of the manure.
Manure system	The manure system includes the collection and removal of slurry or solids out of the housing system.
Mating sows	Sows ready for service and before gestation.
Meal	A feedstuff consisting of one or a mixture of finely ground ingredients such as cereals, oilseeds, etc.
Metabolisable energy	Metabolisable energy (ME) is the gross energy of the feed consumed minus the gross energy contained in the faeces, urine, and gaseous products of digestion. For poultry the gaseous products are usually negligible, so ME represents the gross energy of the feed minus the gross energy of the excreta. A correction for nitrogen retained in the body is usually applied to yield a nitrogen-corrected ME (me_n) value.
Methane	A greenhouse gas produced during anaerobic fermentation of organic matter, especially from enteric fermentation in ruminants and storage of liquid manure. A constituent of biogas.
Microorganisms	Living organisms of microscopic or submicroscopic size. They include bacteria, algae, fungi and viruses, although the latter are not considered living organisms.
Mineralisation	The transformation by microorganisms of organic compounds to inorganic compounds, e.g. of nitrogen/carbon in soils and stored manures.
Minerals	Inorganic substances, including trace elements, fed to livestock and that are required for the normal functioning, growth and health of the animal.
Mineral fertiliser	Fertiliser manufactured by a chemical process or mined, as opposed to an organic material (manure) that contains carbon.
Mucking out	A colloquial term for removing manure, usually solid manure such as farmyard manure from a building housing livestock.
N	
N-balance	Nitrogen mass balance.
Net energy	Net energy (NE) is metabolisable energy minus the energy lost as the heat increment. 'Heat increment' is the heat loss of a nourished animal in excess of that lost by a fasting animal. NE may include the energy used for maintenance only (ne_m) or for maintenance and production (ne_{m+p}).
New farm	A farm first permitted following the publication of the BAT conclusions as defined in Article 1(12) of Directive 2010/75/EU or a complete replacement of a farm following the publication of the BAT conclusions.
New plant	A plant first permitted at the site of the farm following the publication of the BAT conclusions as defined in Article 1(12) of Directive 2010/75/EU or a complete replacement of a plant on the existing foundations following the publication of the BAT conclusions.
Nitrate Vulnerable Zone	Land areas designated according to the Nitrates Directive (91/676/EEC), in which nitrate pollution (from agricultural sources) exceeds, or is likely to exceed, the legal limit of 50 mg NO ₃ /litre.
Nitrification	The transformation by bacteria of ammonium nitrogen to nitrite and then to nitrate. An aerobic process that may occur in soils and during aeration of liquid manures.
Nitrous oxide	A greenhouse gas derived mainly from the denitrification process.

Term	Definition
Nutrient balance	A comparison between plant nutrient input and nutrient output or uptake. The nutrient balance can be expressed as: <ul style="list-style-type: none"> • a supply/demand balance comparing the amount of nutrients entering crop and grassland production in the form of manure or fertilisers and nutrients removed in products (including products not leaving the farm) or the standard nutrient requirement of the crop; • an import/export balance comparing the nutrients imported on to and exported from the farm.
Nutrient surplus	The amount of plant nutrients exceeding the amount required or taken up by crops, thus resulting in a positive nutrient balance.
O	
Odorant	A chemical or gas that causes odour.
Odour	Organoleptic attribute perceptible by the olfactory organ on detecting certain volatile substances with very different chemical, physical and biological properties. It can be a pleasant or unpleasant smell.
Odour concentration	The concentration of an odorant mixture is conventionally defined as the dilution factor to be applied to an effluent in order to be no longer perceived as an odorant by 50 % of people in a sample of the population. The odour concentration at the limit of detection is by definition 1 ou _E /m ³ . It is expressed in European odour units per cubic metre of air (ou _E /m ³) and it is measured by olfactometric analyses in accordance with the European CEN standard (EN 13725).
Open climate house	An animal house with natural ventilation only.
Organic matter (OM)	Residues derived from plants, animals and microorganisms in various stages of decomposition.
Organic Waste	A general term for any wastes of organic rather than inorganic origin and so containing carbon (e.g. livestock manure, sewage sludge).
P	
Partly slatted floor	A floor that is partly solid and partly slatted. Commonly used in pens for housing pigs and designed so that the animals defecate and urinate on the slatted part.
Particulate matter (PM)	All airborne inorganic and organic solid or liquid (droplets and aerosols) matter that may be present in the exhaust air. This complex mixture varies greatly in size, composition and origin.
Passageway	Usually an area with a hard surface to provide livestock (and farm staff and machinery) access to different parts of the building or between buildings.
Pathogens	Microorganisms that can cause disease in humans, animals and plants. Pathogens include bacteria, viruses and parasites and, in agriculture, can be found in manure, sewage sludge, etc.
Pen	A small enclosure for livestock, within a house or outdoors.
Perforated floor	Like slatted floor, but with holes rather than slats. In poultry housing, it refers to a double floor where the perforations of the upper floor let dry air flow up through the floor in order to dry manure and litter.
Pesticide	Biological, physical or chemical agent used to kill pests. The term pesticide is often applied only to chemical agents. Various pesticides are known as insecticides, nematocides, fungicides, herbicides and rodenticides. According to the Stockholm Convention on Persistent Organic Pollutants, 10 of the 12 most dangerous and persistent organic chemicals are pesticides.
pH	Negative logarithm of proton (H ⁺) activity. A measure of the hydrogen ion concentration of a solution and an indication of its acidity or alkalinity. Expressed on a scale from 0 to 14, 7 is neutral, and the higher values alkaline, and the lower values more acidic.
Pheasants	A species of game bird that comes in many breeds and varieties. They are raised for meat, feathers, and ornamental value or to be released into the wild for shooting.
Phytase	Type of enzyme that releases inorganic phosphorus from organic forms of phosphorus (phytate) in grain and thereby makes the phosphorus more available to animals.

Term	Definition
Pig	An animal of the porcine species of any age, kept for breeding or fattening.
Piglets	Pigs from birth to weaning.
Plant	A part of the farm where one of the following processes or activities is carried out: animal housing, manure storage, manure processing. A plant consists of a single building (or facility) and/or the necessary equipment to carry out processes or activities.
Plant nutrients	Elements needed for normal plant growth. Usually divided into macronutrients (nitrogen, phosphorus, potassium, magnesium, calcium, sulphur) and micronutrients (e.g. copper, zinc, manganese).
Plume	Visible or measurable discharge of a contaminant from a given point of origin.
PM ₁₀	Airborne particles with an aerodynamic diameter of 10 micrometres or less corresponding to 50 % sampling efficiency.
PM _{2.5}	Airborne particles with an aerodynamic diameter of 2.5 micrometres or less corresponding to 50 % sampling efficiency.
Pollution	The direct or indirect introduction, as a result of human activity, of substances, vibrations, heat or noise into the air, water or land which may be harmful to human health or the quality of the environment, result in damage to material property, or impair or interfere with amenities and other legitimate uses of the environment. (Article 3(2) of the IED)
Post-weaning	The rearing phase after weaning and before growing/finishing.
Poultry	Fowl (chickens), turkeys, guinea fowl, ducks, geese, quails, pigeons, pheasants and partridges reared or kept in captivity for breeding, the production of meat or eggs for consumption, or for restocking supplies of game.
Premix	Feed ingredient covering the animals' basic needs for vitamins and trace elements and, possibly, some amino acids and nutritional additives. Incorporated into complete feed, e.g. for pigs.
Protein	Complex, organic compound made up of amino acids that contain carbon, oxygen, nitrogen, hydrogen and sometimes phosphorus and sulphur. With water, they form the basic constituents of living cells and of the structure of plants and animals.
Pullets	Young chickens below the age for laying eggs. When reared for egg production, a pullet becomes a laying hen when it begins to lay eggs at 16 to 20 weeks of age. When reared for breeding, young male and female chickens are defined as pullets until 20 weeks of age.
R	
Ration	The allowance of food given to an animal.
Readily available nitrogen	Mineral nitrogen: ammonium, nitrate and uric acid.
Rearing	The keeping of growing livestock.
Reception pit	A pit that is used for short-term storage of liquid manure, slurry, dirty water, etc. from a livestock house prior to transfer to a main store.
Residue	A material that is not deliberately produced in a production process and may or may not be waste.
Run-off	Part of the precipitation, snowmelt, irrigation water, liquid manure, etc. that does not infiltrate but moves as overland flow. Run-off can cause pollution by transporting pollutants and pathogens to surface waters.
S	
Sanitation	Action by which pathogenic microorganisms are killed by heating and/or addition of chemicals or irradiation.
Sensitive receptor	Area which need special protection, such as: - residential areas; - areas where human activities are carried out (e.g. schools, daycare centres, recreational areas, hospitals or nursing homes); - sensitive ecosystems/habitats.
Shed	Barn.
Slaughter weight	Weight of a live animal immediately prior to slaughter.

Term	Definition
Slurry	Faeces and urine mixed or not with some litter material and some water to give a liquid manure with a dry matter content up to about 10 % that flows under gravity and can be pumped.
Soil moisture deficit	The difference between the amount of water actually in the soil and the maximum amount of water that the soil can hold without resulting in drainage.
Soil texture	Soil classification based on the type and proportion of particles (sand, silt, clay) that it contains.
Solid floor	A continuous surface which allows full contact with and support to the lower surface of the animal foot.
Solid fraction	See liquid fraction above. Solids or fibrous material derived from the mechanical separation of slurry. The solid fraction is normally stackable.
Solid manure	Faeces or droppings and urine mixed or not with litter material that do not flow under gravity and cannot be pumped.
Sows	Female pigs during the rearing periods of mating, gestating and farrowing.
Space allowance	The number or body weight of animals per unit area in their accommodation.
Stag	A male turkey.
Stall	A division or compartment for an animal or animals, usually within a house.
Stocking density	The live weight of animals which are present in a house at the same time per square metre of useable area.
Straw	Dry stems of cereals after the grain has been removed.
Surface water	Water that flows in streams and rivers, natural lakes, wetlands and reservoirs constructed by humans.
Suspended solids (SS)	Suspended matter in liquid.
T	
Technique	Includes both the technology used and the way in which the installation is designed, built, maintained, operated and decommissioned.
Total ammoniacal nitrogen (TAN)	The total amount of ammonium-N ($\text{NH}_4\text{-N}$) and its compounds, including uric acid, which is readily broken down to $\text{NH}_4\text{-N}$. TAN is often used as a synonym for NH_4^+ (assuming that the amount of NH_3 is insignificant).
Total dust	All particles emitted from a source with an aerodynamic diameter of 500 micrometres or less.
Total Kjeldahl nitrogen	Total amount of organic and reduced nitrogen compounds, excluding nitrates ($\text{NO}_3\text{-N}$).
Total nitrogen (or total N)	Total nitrogen, expressed as N, includes free ammonia and ammonium ($\text{NH}_4\text{-N}$), nitrites ($\text{NO}_2\text{-N}$), nitrates ($\text{NO}_3\text{-N}$) and organic nitrogen compounds.
Total nitrogen excreted	Total nitrogen eliminated from animal metabolic processes through urine and faeces.
Total phosphorus	Total phosphorus, expressed as P_2O_5 , includes all inorganic and organic phosphorus compounds, dissolved or bound to particles.
Total phosphorus excreted	Total phosphorus eliminated from animal metabolic processes through urine and faeces.
Total solids (TS)	Dry matter.
Total suspended solids (TSS)	Mass concentration of all suspended solids, measured via filtration through glass fibre filters and gravimetry.
Trace element	A chemical element that is required in very small quantities by plants or animals for normal functioning, growth and health. Include iron, zinc, boron, copper, manganese, cobalt and molybdenum.
Tramline	Accurately spaced, narrow pathways left in a cereal crop for example to provide wheel guide marks for tractors and machinery used in subsequent operations, e.g. fertiliser application.
Triangular slats	Components of slatted floors, e.g. in pig pens, usually made of metal, plastic or concrete. They are triangular in cross section with the apex of the triangle facing down so that the slots between them are wider on the underside of the floor.
Turkey	Large poultry species kept for the production of meat.
U	

Term	Definition
Urea	The main end product of mammalian protein metabolism and the main nitrogen compound in the urine of mammals.
Uric acid	The main end product of the protein metabolism of birds (poultry).
Urine	Wastes removed from the bloodstream via the kidneys and voided as a liquid.
V	
Ventilation rate	This is usually expressed as the volume flow of air (m ³ /hour) through an animal house. It can be given for the whole building or per animal (place).
Veranda	Covered area with open side walls along the side of poultry houses that allows animals access to the outside climate for animal welfare reasons. It is sometimes equipped with a base plate covered with some type of litter (scratching area) or ground covering.
Viscosity	Resistance of a fluid to a change in shape or movement of neighbouring portions relative to one another. Viscosity denotes opposition to flow.
Vitamin	A class of organic substances required by animals in small amounts for normal functioning, growth and health. Farm animals can synthesise some, e.g. Vitamin C, in their bodies but most must be provided in their diet.
Volatile fatty acids (VFA)	Short-chain fatty acid containing two to five carbon atoms that are produced as end products of microbial fermentation in the digestive tract.
Volatile organic compound (VOC)	Any organic compound having at 293.15 K a vapour pressure of 0.01 kPa or more, or having a corresponding volatility under the particular conditions of use (Article 3(45) of the IED).
Volatile solids	The weight loss after a sample of total solids is ignited in a furnace (heated to dryness at 550 °C).
Volatilisation	The process by which ammonia gas is released from a solution. Refers to the loss of ammonia from urine and from manure during housing, storage and landspreading.
W	
Waiting sows	A sow waiting to be on heat before insemination.
Waste water	Rainwater run-off commonly mixed with manure, water derived from the cleaning of surfaces (e.g. floors) and equipment, and water derived from the operation of air cleaning systems. This may also be referred to as soiled water.
Water table	The level in soil below which the ground is completely saturated with water.
Weaners	Young pigs reared from weaning until fattening, typically reared from a live weight of around 8 kg to 30 kg.
Weaning	The time when the pigs are reared from a live weight of around 8 kg to 30 kg.
Welfare	The state of an individual as regards its attempts to cope with its environment.
Working width	The distance between the centres of two adjacent spreading widths, each one achieved by a single pass of the manure spreader.
Z	
Zeolites	Aluminosilicate mineral deposits that have a microporous structure.
Zootechnical additives	The following functional groups are included, as per Regulation (EC) No 1831/2003: (a) digestibility enhancers: substances which, when fed to animals, increase the digestibility of the diet, through action on target feed materials; (b) gut flora stabilisers: microorganisms or other chemically defined substances, which, when fed to animals, have a positive effect on the gut flora; (c) substances which favourably affect the environment; (d) other zootechnical additives.



9 ANNEXES

9.1 Animal species and livestock units (LU)

In the evaluation of the environmental impact of intensive livestock farms, the term 'place' may lead to confusion. A place can be considered equal to one animal, but there is a difference in the extent of environmental effects from keeping different kinds of animals belonging to the same species but of different kinds and at different stages of production. For example, hens, broilers, ducks and turkeys all belong to the species 'poultry', but the environmental effects of farms with these kinds of animals and the same number of places are considerably different. In addition, it makes a difference whether young animals are reared or older animals are fattened.

To overcome these problems, animal places can be expressed in terms of animal mass (livestock units - LU, e.g. 1 LU = 500 kg animal mass), as environmental effects depend strongly on the average animal mass during a production period. Animal masses correspond approximately to manure production and emissions. They may be defined as the time-integrated average animal mass over a production period or cycle on the basis of the animal-specific growth function, which is available for every kind of animal. This enables different types (breeding, fattening) and stages (weaning, growing-finishing) of production, housing periods and changing production processes to be taken into consideration.

Some examples of standard values for LU as reported by Member States are presented below (Table 9.1, Table 9.2, Table 9.3).

Table 9.1: Standard values for the calculation of live animal mass in LU, used in Germany

Animal category	Average live animal mass in LU/animal
Pigs	
Fattening pigs (25–110 kg)	0.13
Fattening pigs (25–115 kg)	0.14
Fattening pigs (25–120 kg)	0.15
Early-pregnant and non-pregnant sows, boars (150 kg)	0.30
Sows with piglets (up to 10 kg)	0.40
Sows with piglets (up to 14 kg)	0.45
Sows with piglets (up to 18 kg)	0.50
Weaners (up to 15 kg)	0.02
Weaners (up to 25 kg)	0.03
Weaners (up to 30 kg)	0.04
Young sows (up to 90 kg)	0.12
Poultry	
Laying hens	0.003 4
Young hens - rearing (until the 18th week)	0.001 4
Broilers (up to 35 days)	0.001 5
Broilers (up to 42 days)	0.002 0
Broilers (up to 49 days)	0.002 4
Ducks - rearing (Pekin ducks)	0.001 3
Ducks - fattening (Pekin ducks)	0.003 8
Flying ducks - rearing	0.001 2
Flying ducks - fattening	0.005 0
Turkeys - rearing	0.002 2
Turkeys - fattening (hens)	0.012 5
Turkeys - fattening (cocks)	0.022 2
Turkeys - fattening (mixed males and females)	0.016
NB: 1 LU corresponds to a standardised live animal mass of 500 kg	
Source: [474, VDI 2011]	

Table 9.2: Standard values for the calculation of live animal mass in LU, used in Spain

Animal category	Average live animal mass in LU/animal
Pigs	
Sows in a farrow-to-finish farm ⁽¹⁾	2
Sows with piglets until 6 kg	0.25
Sows with piglets until 20 kg	0.30
Weaners 6 to 20 kg	0.02
Fattening pigs (Growers) 20 to 50 kg	0.08
Fattening pigs (Finishers) 50 to 100 kg	0.10
Fattening pigs 20 to 100 kg	0.09
Poultry ⁽²⁾	
Broilers	0.007
Turkeys	0.021
Laying hens	0.014
Partridges, quails and pheasants	0.003 5
⁽¹⁾ Includes all offspring of the sow until the end of the fattening period.	
⁽²⁾ Values used in the region of Andalusia.	
NB: 1 LU corresponds to an adult cow.	
Source: [500, IRPP TWG 2011] [624, IRPP TWG 2013]	

Table 9.3: Standard values for the calculation of live animal mass in LU, used in the UK

Animal category	Average live animal mass in LU/animal
Pigs	
Sows	0.4
Farrowing sows	0.45
Boars	0.5
Fattening pigs > 110 kg	0.24
Fattening pigs 20–110 kg	0.13
Piglets < 20 kg	0.06
Poultry	
Laying hens	0.004 4
Broilers	0.001 8
Pullets	0.002
Breeding hens	0.004
NB: Calculated values. 1 LU corresponds to a standardised live animal mass of 500 kg.	
Source: [614, UK 2013]	

In order to compare or aggregate numbers of the various categories of livestock, equivalences based on the feed requirements of the animals can also be defined. In this case livestock units are defined on the basis of the feed requirements of the individual animal categories (Table 9.4).

Other equivalences can be defined based on nutrient excretion.

Table 9.4: Livestock unit coefficients used by Eurostat

Animal category	Average live animal mass in LU/animal
Bovine	
Under 1 year old	0.400
1–2 years old	0.700
Male, 2 years old and over	1.000
Heifers, 2 years old and over	0.800
Dairy cows	1.000
Other cows, 2 years old and over	0.800
Pigs	
Piglets with a live weight of under 20 kg	0.027
Breeding sows weighing 50 kg and over	0.5
Other pigs	0.3
Poultry	
Laying hens	0.014
Broilers	0.007
Ostriches	0.35
Other poultry	0.03
Other	
Sheep and goats	0.8
Equidae	0.1
Rabbits, breeding females	0.02
NB: 1 LU corresponds to the grazing equivalent of one 600 kg dairy cow producing 3 000 kg of milk annually, without additional concentrated foodstuffs.	
Source: [12, Eurostat 2015]	

9.2 Examples of phase feeding programmes

Applied feeding programmes are reported in the following sections.

9.2.1 Multiphase feeding for poultry

9.2.1.1 Pullets

Table 9.5: Multiphase feeding for pullets in the UK

Parameter	Phase 1	Phase 2	Phase 3
Period (weeks)	0–6	7–12	13–16
Crude protein (%)	20 (19–21)	18.5 (18–19)	16 (15–17)
Amino acids (%)	1 (0.9–1.1)	0.85 (0.8–0.95)	0.65–0.8
Total calcium (%)	1 (0.9–1.2)	0.9 (0.9–1.2)	0.9 (0.9–1.2)
Total phosphorus (%)	0.5 (0.5–0.6)	0.5 (0.5–0.6)	0.45 (0.4–0.55)
Total copper (mg/kg)	15 (10–25)	15 (10–25)	15 (10–25)
Total zinc (mg/kg)	60 (40–80)	60 (40–80)	60 (40–80)
Phytase (%)	0.018 (0–0.018)	0.018 (0–0.018)	0.018 (0–0.018)
NSP enzymes (%)	0.005 (0–0.01)	0.005 (0–0.01)	0.005 (0–0.01)

Source: [298, UK 2010]

Table 9.6: Multiphase feeding for pullets (free range) in the UK

Parameter	Phase 1	Phase 2	Phase 3
Period (weeks)	0–8	8–12	12–16
Crude protein (%)	19	16.5	15.5
Amino acids (%)	1	0.8	0.7
Total calcium (%)	0.95 (0.95–1)	0.95 (0.95–1)	0.95 (0.95–1)
Total phosphorus (%)	0.741	0.76	0.76
Total copper (mg/kg)	15	15	15
Total zinc (mg/kg)	70	70	70
Phytase (%)	0	0	0
NSP enzymes (U/kg)	500	500	500

Source: [294, UK 2010]

Table 9.7: Multiphase feeding for pullets in Germany

Parameter	Phase 1	Phase 2	Phase 3	Phase 4
Period (weeks) ⁽¹⁾	1–3	4–8	9–15/16	16/17
Metabolisable energy (MJ/kg)	12	11.4	11–11.4	11.2–11.4
Crude protein (%)	20–21	18–18.5	14.5–16	16–17.5
Amino acids (%) ⁽²⁾	0.4–0.48	0.37–0.42	0.31–0.39	0.34–0.37
Amino acid profile (Met : Lys : Val : Thr : Trp)	1 : 1.9 : 1.6 : 1.5 : 0.5			
Total calcium (%)	0.95–1.05	0.95–1	0.9–0.92	2–2.25
Total phosphorus (%)	0.75–0.75	0.7–0.7	0.58	0.65–0.65
Total copper (mg/kg)	6–6.2	6–6.2	6–6.2	6–6.2
Total zinc (mg/kg)	44–60	44–60	39–40	40–44
Phytase (FTU/kg)	500 (250–750)	500 (250–750)	500 (250–750)	500 (250–750)
NSP enzymes (%) ⁽³⁾	0.005–0.01	0	0	0

⁽¹⁾ The body weight, rather than simply the age, determines the right time to change the feed. Chicks and pullets are weighed once a week.

⁽²⁾ Data refer to methionine (first limiting amino acid).

⁽³⁾ The enzyme activity ranges from 280/125 to 560/250 TXU/TGU (xylanase/glucanase) per kg of feed.

NB: Unrestricted (ad libitum) dry feed/pelleted feed.

Source: [327, Germany 2010]

9.2.1.2 Laying hens

Table 9.8: Multiphase feeding for laying hens (in cages) in the UK

Parameter	Phase 1	Phase 2	Phase 3	Phase 4	Phase 5
Period (weeks)	16–28	29–40	41–55	56–70	>71
Crude protein (%)	17 (16–18)	16.5–19	16–18	15–17	13–16
Amino acids (%)	0.9 (0.7–1)	0.9 (0.85–1)	0.8 (0.7–0.9)	0.72 (0.7–0.8)	0.65 (0.6–0.75)
Total calcium (%)	2.5 (2–4)	3.6 (3.5–4)	3.8 (3.6–4.2)	4 (3.8–4.4)	4 (3.8–4.4)
Total phosphorus (%)	0.5 (0.4–0.55)	0.45 (0.4–0.5)	0.45 (0.4–0.5)	0.45 (0.4–0.5)	0.4 (0.38–0.5)
Total copper (mg/kg)	15 (10–20)	15 (10–25)	15 (10–20)	15 (10–20)	15 (10–20)
Total zinc (mg/kg)	60 (40–100)	60 (40–100)	60 (40–100)	60 (40–100)	60 (40–100)
Phytase (%)	0.018 (0–0.18)	0.018 (0–0.18)	0.018 (0–0.18)	0.018 (0–0.18)	0.018 (0–0.18)
NSP enzymes (%)	0.005 (0–0.01)	0.005 (0–0.01)	0.005 (0–0.01)	0.005 (0–0.01)	0.005 (0–0.01)

Source: [297, UK 2010]

Table 9.9: Multiphase feeding for laying hens (free range) in the UK

Parameter	Phase 1	Phase 2	Phase 3
Period (weeks)	16–25	25–50	50–72
Crude protein (%)	17.5	17	15.5
Amino acids (%)	0.88	0.84	0.76
Total calcium (%)	3.8 (3.8–4)	3.9 (3.9–4.1)	4.05 (4.05–4.3)
Total phosphorus (%)	0.475	0.451	0.403
Total copper (mg/kg)	15	15	15
Total zinc (mg/kg)	70	70	70
Phytase (FTU/kg)	120	120	120
NSP enzymes (U/kg)	500	500	500

Source: [293, UK 2010]

Table 9.10: Multiphase feeding for laying hens (in cages) in Germany

Parameter	Phase 1	Phase 2	Phase 3
Metabolisable energy (MJ/kg)	11.6–12.1	11.4	11–11.4
Crude protein (%)	18 (15.4–20)	17 (15.5–19)	16.5 (15–17)
Amino acids (%) ⁽¹⁾	0.4–0.42	0.35 (0.32–0.38)	0.35 (0.32–0.38)
Amino acid profile (Met : Lys : Val : Thr : Trp)	1 : 1.9 : 1.6 : 1.5 : 0.5		
Total calcium (%)	0.38	3.8 (3.7–4.4)	4.1 (4.0–4.5)
Total phosphorus (%)	0.45–0.55	0.42–0.45	0.36–0.45
Total copper (mg/kg)	0.000 5	0.000 5	0.000 5
Total zinc (mg/kg)	0.004 4	0.004 4	0.004 4
Phytase (FTU/kg)	300 (250–750)	300 (250–750)	300 (250–750)
NSP enzymes (%)	0.005–0.01	0.005–0.01	0.005–0.01

⁽¹⁾ Data refer to methionine (first limiting amino acid).
 NB: Unrestricted (ad libitum) dry feed/pelleted feed (middlings or another type of feed).
 Source: [327, Germany 2010]

9.2.1.3 Broilers

Table 9.11: Multiphase feeding for light broilers (40 days) in the UK

Parameter	Phase 1	Phase 2	Phase 3	Phase 4
Period (days)	0–10	11–20	21–33	34–40
Crude protein (%)	22 (22–23)	21 (20–22)	18–19.5	18–19.5
Amino acids (%)	1.45 (1.3–1.5)	1.35 (1.2–1.4)	1.25 (1.15–1.3)	1.15 (1–1.2)
Total calcium (%)	0.9–1	0.75–0.9	0.65–0.85	0.65–0.85
Total phosphorus (%)	0.55 (0.5–0.6)	0.45–0.55	0.4–0.48	0.4–0.48
Total copper (mg/kg)	20 (15–25)	20 (15–25)	20 (15–25)	20 (15–25)
Total zinc (mg/kg)	70 (60–90)	70 (60–90)	60 (50–80)	60 (50–80)
Phytase (%)	0.03	0.03	0.03 (0.015–0.03)	0.03
NSP enzymes (%)	0.015	0.015	0.015	0.015

NB: Final weight 2.35 (2, 25–2, 45) kg for 40 days
Source: [296, UK 2010]

Table 9.12: Multiphase feeding for heavy broilers (7 to 8.5 weeks) in the UK

Parameter	Phase 1	Phase 2	Phase 3	Phase 4	Phase 5
Period (days)	1–8	9–13	14–27/37	28–45/28–55	46–49/56–59
Crude protein (%)	23.3	20.7	19.7	17.8	17.7
Amino acids (%)	NI	NI	NI	NI	NI
Total calcium (%)	1	0.74	0.74	0.69	0.64
Total phosphorus (%)	0.78	0.58	0.58	0.52	0.46
Total copper (mg/kg)	25	25	25	25	25
Total zinc (mg/kg)	100	90	90	80	80
Phytase (%)		0.03	0.03	0.03	0.03
Inorganic phosphorus (%)	2.05	1.03	1.02	0.82	0.47
NSP enzymes (%)	0.03	0.03	0.03	0.03	0.03

NB: Final weight 3 kg for 8.5 weeks or 2.1 kg for 7 weeks. NI = no information provided.
Source: [295, UK 2010]

Table 9.13: Multiphase feeding for broilers in Germany

Parameter	Phase 1	Phase 2	Phase 3
Period (days)	1–10	11–27/32	28/33–35/42
Metabolisable energy (MJ/kg)	12.2–12.6	13.0–13.4	13.2–13.8
Crude protein (%)	22 (20–23)	21 (20–22)	19.5 (18–21)
Amino acids (%) ⁽¹⁾	0.55 (0.45–0.6)	0.55 (0.45–0.55)	0.5 (0.45–0.52)
Amino acid profile (Met : Met/Cys : Lys : Thr : Trp)	1 : 1.84 : 2.78 : 1.81 : 0.43	1 : 2.17 : 2.68 : 1.97 : 0.44	1 : 2.38 : 2.54 : 2.07 : 0.42
Total calcium (%)	1 (0.85–1.2)	0.9 (0.8–1.2)	0.8 (0.7–1.2)
Total phosphorus (%)	0.65 (0.65–0.7)	0.55 (0.55–0.7)	0.5 (0.5–0.7)
Total copper (mg/kg)	6.2 (4–8)	6.2 (4–8)	6.2 (4–8)
Total zinc (mg/kg)	40 (40–50)	40 (40–44)	40 (20–70)
Phytase (FTU/kg)	500 (250–1 000)	500 (250–750)	500 (250–750)
NSP enzymes (%) ⁽²⁾	0.005–0.01	0	0

⁽¹⁾ Data refer to methionine (first limiting amino acid).
⁽²⁾ The enzyme activity ranges from 280/125 to 560/250 TXU/TGU (xylanase/glucanase) per kg of feed.
NB:
- The information is a synthesis of a lot of data recommended by different public and private research institutions and researchers.
- Unrestricted (ad libitum) dry feed/pelleted feed. With regard to the structure of the pellet, it is recommended that during the first phase it is between crumbled and 2 mm. For the next phases it is 3 mm.
Source: [327, Germany 2010]

9.2.1.4 Turkeys

Table 9.14: Multiphase feeding for turkeys in the UK

Parameter	Phase 1	Phase 2	Phase 3	Phase 4
Period (weeks)	0–2	3–6	7–12	13–20
Crude protein (%)	26 (25–28)	24 (23–26)	20 (20–23)	18 (17–21)
Amino acids (%)	1.7 (1.6–1.8)	1.5 (1.4–1.7)	1.4 (1.3–1.5)	1.2 (1–1.3)
Total calcium (%)	1.25 (1.2–1.4)	1.1 (1–1.4)	0.9 (0.9–1.2)	0.8 (0.75–1)
Total phosphorus (%)	0.75 (0.7–0.9)	0.7 (0.65–0.85)	0.65 (0.6–0.7)	0.6 (0.55–0.65)
Total copper (mg/kg)	15 (15–25)	15 (15–25)	15 (15–25)	15 (15–25)
Total zinc (mg/kg)	70 (60–100)	70 (60–100)	70 (60–100)	70 (60–100)
Phytase (%)	0.03 (0–0.03)	0.03 (0–0.03)	0.03 (0–0.03)	0.03 (0–0.03)
NSP enzymes (%)	0.015 (0.015–0.03)	0.015 (0.015–0.03)	0.015 (0.015–0.03)	0.015 (0.015–0.03)

Source: [299, UK 2010]

Table 9.15: Multiphase feeding for turkeys (starter) in Germany

Parameter	Phase 1	Phase 2
Period (weeks)	1–2	3–5
Metabolisable energy (MJ/kg)	11.2–11.8	11.5–12.1
Crude protein (%)	27.5–29.5	26–27.5
Amino acids (%) ⁽¹⁾	0.17–0.171	0.152–0.162
Amino acid profile (Lys : Arg : Me/Cys : Thr : Met : Trp)	1 : 1.05 : 0.64 : 0.6 : 0.37 : 0.17	1 : 1.05 : 0.66 : 0.61 : 0.37 : 0.17
Total calcium (%)	1.3–1.4	1.1–1.5
Total phosphorus (%)	0.8–1	0.8–1
Total copper (mg/kg)	0.000 8–0.001	0.000 8–0.001
Total zinc (mg/kg)	0.005–0.006 5	0.004–0.005
Phytase (FTU/kg)	500 (250–1 000)	500 (250–1 000)
NSP enzymes (%) ⁽²⁾	0	0.01–0.015

⁽¹⁾ Data refer to lysine (first limiting amino acid).
⁽²⁾ The enzyme activity is 560/250 TXU/TGU (xylanase/glucanase) per kg of feed.

NB:
- Unrestricted (ad libitum) dry feed/pelleted feed.
- Regardless of sex, turkeys are raised together for the first and second phases of growth, which extend over the first 4–5 weeks until full feathering of the young turkey.

Source: [327, Germany 2010]

Table 9.16: Multiphase feeding for turkeys (male) in Germany

Parameter	Phase 1	Phase 2	Phase 3	Phase 4
Period (weeks)	5–8	9–12	13–16	> 17
Metabolisable energy (MJ/kg)	11.8–12.3	12.3–12.8	12.8–13.2	13.2–13.6
Crude protein (%)	24–24.5	20–21	18–18	14–16
Amino acids (%) ⁽¹⁾	1.35–1.45	1.25–1.28	1–1	0.8–0.85
Amino acid profile (Lys : Met/Cys : Thr : Met : Trp)	1 : 0.54 : 0.56 : 0.35 : 0.17	1 : 0.56 : 0.56 : 0.35 : 0.16	1 : 0.56 : 0.56 : 0.34 : 0.16	1 : 0.55 : 0.56 : 0.33 : 0.16
Total calcium (%)	0.8–1.4	0.75–1.2	0.7–1.1	0.65–1
Total phosphorus (%)	0.6–0.82	0.55–0.55	0.5–0.7	0.45–0.65
Total copper (mg/kg)	0.000 5–0.001	0.000 6–0.001	6–10	0.000 6–0.001
Total zinc (mg/kg)	0.004–0.006	0.003–0.004	30–40	0.003–0.004
Phytase (FTU/kg)	500 (250–1 000)	500 (250–1 000)	500 (250–1 000)	500 (250–1 000)
NSP enzymes (%) ⁽²⁾	0.01–0.015	0.01–0.015	0.01–0.015	0.01–0.015

⁽¹⁾ Data refer to lysine (first limiting amino acid).
⁽²⁾ The enzyme activity is 560/250 TXU/TGU (xylanase/glucanase) per kg of feed.

NB:
- Unrestricted (ad libitum) dry feed/pelleted feed.
- The feeding programme for male turkeys is a continuation of the programme for turkey starters.

Source: [327, Germany 2010]

Table 9.17: Multiphase feeding for turkeys (female) in Germany

Parameter	Phase 1	Phase 2	Phase 3
Period (weeks)	5–6/8–9	9–10/12–13	13–14/16–17
Metabolisable energy (MJ/kg)	12.3–13.8	12.8–13.2	13.2–13.6
Crude protein (%)	23–24.4	20–21	18–18.5
Amino acids (%) ⁽¹⁾	1.4–1.45	1.22–1.25	1–1.1
Amino acid profile (Lys : Arg : Met/Cys : Thr : Met : Trp)	1 : 1.05 : 0.66 : 0.61 : 0.37 : 0.17		
Total calcium (%)	0.8–1.2	0.75–1.2	0.7–1.1
Total phosphorus (%)	0.55–0.8	0.55–0.55	0.5–0.75
Total copper (mg/kg)	0.000 8–0.001	0.000 8–0.001	0.000 8–0.001
Total zinc (mg/kg)	0.005–0.006 5	0.004–0.005	0.004–0.005
Phytase (FTU/kg)	500 (250–1 000)	500 (250–1 000)	500 (250–1 000)
NSP enzymes (%) ⁽²⁾	0.01–0.015	0.01–0.015	0.01–0.015
⁽¹⁾ Data refer to lysine (first limiting amino acid). ⁽²⁾ The enzyme activity is 560/250 TXU/TGU (xylanase/glucanase) per kg of feed. NB: - Unrestricted (ad libitum) dry feed/pelleted feed. - The feeding programme for female turkeys is a continuation of the programme for turkey starters. Source: [327, Germany 2010]			

9.2.1.5 Ducks

Table 9.18: Multiphase feeding for ducks in Germany

Parameter	Phase 1	Phase 2
Period (weeks)	1–3	4–7
Metabolisable energy (MJ/kg)	11.40–12.34	12.20–12.97
Crude protein (%)	20–23.75	18–18
Amino acids (%) ⁽¹⁾	0.4–0.48	0.4–0.45
Amino acid profile (Met : Lys : Met/Cys : Thr : Trp)	1 : 2 : 1.70 : 1.5 : 1.46	1 : 2 : 1.75 : 1.5 : 0.4
Total calcium (%)	0.8–1.2	0.7–0.8
Total phosphorus (%)	0.65–0.85	0.6–0.7
Total copper (mg/kg)	4.5	4.5–6.2
Total zinc (mg/kg)	40–50	40–55
Phytase (FTU/kg)	500 (250–1 000)	500 (250–1 000)
NSP enzymes (%) ⁽²⁾	0.005–0.01	0.005–0.01
⁽¹⁾ Data refer to methionine (first limiting amino acid). ⁽²⁾ The enzyme activity ranges from 280/125 to 560/250 TXU/TGU (xylanase/glucanase) per kg of feed. NB: Unrestricted (ad libitum) dry feed/pelleted feed. During the first phase the feed could be crumbled. For the next phases it is between 3 mm and 4 mm. Source: [327, Germany 2010]		

9.2.2 Multiphase feeding for pigs

9.2.2.1 Gestating sows

Table 9.19: Multiphase feeding for gestating sows in the UK

Parameter	Phase 1 (lactation)	Phase 2 (gestation)
Crude protein (%)	15–20	12–15
Amino acids (%)	0.8–1.1	0.5–0.6
Total calcium (%)	0.55–0.75	0.75–0.9
Total phosphorus (%)	0.55–0.75	0.55–0.75
Total copper (mg/kg)	25	25
Total zinc (mg/kg)	100–150	100–150
Phytase (%)	0–0.1	0–0.1
Inorganic phosphorus (%)	0–0.7	0–0.7
NSP enzymes (%)	NI	NI

NB: NI = no information provided.
 Source: [309, UK 2010]

Table 9.20: Multiphase feeding for gestating sows in Germany

Parameter	Phase 1	Phase 2
Period (days of pregnancy)	1–84	85–115
Metabolisable energy (MJ/kg)	11, 8–12, 2	11, 8–12, 2
Crude protein (%)	13 (12–14)	14 (12–16)
Amino acids (%) ⁽¹⁾	0.6 (0.5–0.7)	0.7 (0.6–0.8)
Amino acid profile (Lys : Met/Cys : Thr : Trp)	1 : 0.6 : 0.65 : 0.19	
Total calcium (%)	0.55–0.65	0.56–0.75
Total phosphorus (%)	0.4–0.55	0.45–0.55
Total copper (mg/kg)	8–10	8–10
Total zinc (mg/kg)	50–80	50–80
Phytase (FTU/kg of feed)	500 (300–700)	500 (300–700)
Inorganic phosphorus (%)	0.15 (0.1–0.2)	0.15 (0.1–0.2)
NSP enzymes (%)	NI	NI

⁽¹⁾ Data refer to lysine (first limiting amino acid).
 NB: NI = no information provided.
 Source: [326, Germany 2010]

9.2.2.2 Farrowing sows

Table 9.21: Multiphase feeding for farrowing sows in Germany

Parameter	One phase
Days of lactation	25
Metabolisable energy (MJ/kg)	13 (12.8–13.4)
Crude protein (%)	17 (16–17.5)
Amino acids (%) ⁽¹⁾	0.95 (0.9–1)
Total calcium (%)	0.85 (0.75–0.95)
Total phosphorus (%)	0.6 (0.5–0.7)
Total copper (mg/kg)	1
Total zinc (mg/kg)	50
Phytase (FTU/kg)	500 (300–700)
Inorganic phosphorus (%)	0.15 (0.1–0.2)
NSP enzymes (%)	NI

NB: NI = no information provided.
 Source: [326, Germany 2010]

9.2.2.3 Weaners

Table 9.22: Multiphase feeding for weaners and growers in the UK

Parameter	Phase 1	Phase 2	Phase 3
Period (weight in kg)	7.5–20	20–25	25–50
Crude protein (%)	20–24	19–23	18–21
Amino acids (%)	1.6–1.7	1.4–1.6	1.2–1.4
Total calcium (%)	0.55–0.75	0.6–0.75	0.6–0.75
Total phosphorus (%)	0.55–0.75	0.55–0.75	0.55–0.75
Total copper (mg/kg)	170	170	17
Total zinc (mg/kg)	150	150	150
Phytase (%)	0–0.1	0–0.1	0–0.1
Inorganic phosphorus (%)	0–0.7	0–0.7	0–0.7
NSP enzymes (%)	0–0.1	0–0.1	0–0.1

Source: [308, UK 2010]

Table 9.23: Multiphase feeding for weaners in Germany

Parameter	Phase 1	Phase 2
Period (weight in kg)	8–20	21–30
Metabolisable energy (MJ/kg)	13.4	13.8–13.0
Crude protein (%)	18 (17–18.5)	17.5 (17–18)
Amino acids (%)	1.25 (1.2–1.4)	1.15 (1.1–1.2)
Total calcium (%)	0.75 (0.7–0.8)	0.7 (0.65–0.8)
Total phosphorus (%)	0.55 (0.46–0.6)	0.5 (0.42–0.55)
Total copper (mg/kg)	20(6–170)	20 (6–170)
Total zinc (mg/kg)	80 (35–100)	80 (70–100)
Phytase (FTU/kg)	500–1 500	500–1 500
Inorganic phosphorus (%)	0.15 (0.1–0.2)	0.15 (0.1–0.2)
Benzoic acid (%)	0.5	0.5
NSP enzymes (%) (¹)	0.01	0.01

(¹) The enzyme activity is 10 TXU (xylanase) per kg of feed.
Source: [326, Germany 2010]

9.2.2.4 Fattening pigs

Table 9.24: Multiphase feeding for finishers in the UK (two phases)

Parameter	Phase 1	Phase 2
Period (weight in kg)	50–70	70–100
Crude protein (%)	17–20	16–19
Amino acids (%)	1–1.2	0.9–1.2
Total calcium (%)	0.6–0.75	0.6–0.75
Total phosphorus (%)	0.55–0.75	0.55–0.75
Total copper (mg/kg)	25	25
Total zinc (mg/kg)	150	150
Phytase (%)	0–0.1	0–0.1
Inorganic phosphorus (%)	0–0.7	0–0.7
NSP enzymes (%)	0–0.1	0–0.1

Source: [311, UK 2010]

Table 9.25: Multiphase feeding for fattening pigs in Germany (two phases)

Parameter	Phase 1	Phase 2
Period (weight in kg)	25–60	60–110
Metabolisable energy (MJ/kg)	13.0–13.4 at the beginning and 12.8 at the end of the period	
Crude protein (%)	17	14
Amino acids (%) (¹)	1.05 (0.95–1.15)	0.95 (0.9–1.05)
Amino acid profile (Lys : Met/Cys : Thr : Trp)	1 : 0.55 : 0.65 : 0.18	
Total calcium (%)	0.7 (0.65–0.75)	0.65 (0.6–0.75)
Total phosphorus (%)	0.58 (0.42–0.6)	0.45 (0.4–0.45)
Total copper (mg/kg)	10 (5–15)	10 (5–15) (5)
Total zinc (mg/kg)	50	60
Phytase (FTU/kg of feed)	280–500	280–500
Inorganic phosphorus (%)	0.15 (0.1–0.2)	0.15 (0.1–0.2)
NSP enzymes (%)	NI	NI

(¹) Data refer to lysine (first limiting amino acid).
 NB: NI = no information provided.
 Source: [326, Germany 2010]

Table 9.26: Multiphase feeding for weaners and fattening pigs in the UK (5 phases)

Parameter	Phase 1	Phase 2	Phase 3	Phase 4	Phase 5
Period (weight in kg)	7.5–20	20–25	25–50	50–70	70–100
Crude protein (%)	22 (21–23)	21 (19–22)	19 (18–22)	18 (17–20)	17 (16–19)
Amino acids (%)	1.5 (1.4–1.7)	1.45 (1.3–1.5)	1.35 (1.2–1.45)	1.15 (1–1.25)	1 (0.8–1.1)
Total calcium (%)	0.7 (0.6–1)	0.7 (0.6–1)	0.75 (0.7–0.9)	0.7 (0.7–1)	0.65 (0.65–1)
Total phosphorus (%)	0.65 (0.6–0.8)	0.65 (0.6–0.75)	0.6 (0.6–0.7)	0.6 (0.6–0.7)	0.55 (0.55–0.65)
Total copper (mg/kg)	170	170	170	25	25
Total zinc (mg/kg)	150	150	150	150	150
Phytase (%)	NI	NI	0.01	0.01	NI
NSP enzymes (%)	NI	NI	NI	NI	NI

NB: NI = no information provided.
 Source: [310, UK 2010]

Table 9.27: Multiphase feeding for fattening pigs in Germany (5 phases)

Parameter	Phase 1	Phase 2	Phase 3	Phase 4	Phase 5
Period (weight in kg)	30–40	40–60	60–80	80–100	100–110
Metabolisable energy MJ/kg	13.0–13.4	NI	NI	NI	12.8
Crude protein (%)	16.5–18	16.5–17.5	15.5–17	14–16	12.9–15
Amino acids (%)	1.05 (0.95–1.15)	0.95 (0.9–1.05)	0.9 (0.85–1.05)	0.85 (< 1)	0.75 (< 0.85)
Total calcium (%)	0.65–0.75	0.6–0.75	0.7	0.6	0.6
Total phosphorus (%)	0.42–0.6	0.45–0.55	0.4–0.5	0.4–0.5	0.45
Total copper (mg/kg)	5–15	5–15	4–15	4–15	4–15
Total zinc (mg/kg)	60	60	60	60	60
Phytase (FTU/kg of feed)	280–500	280–500	280–500	280–500	280–500
Inorganic phosphorus (%)	0.1–0.2	0.15	0.1–0.2	0.1–0.2	0.1–0.2
NSP enzymes (%)	NI	NI	NI	NI	NI

NB: NI = no information provided.
 Source: [326, Germany 2010]

9.2.2.5 Multiphase feeding in France

Examples of feeding programmes recommended for pig nutrition in France are given in the table below.

Table 9.28: Multiphase feeding for pigs in France

		Crude protein level in feed (%)		Phosphorus (%)	
	Stage	Standard (One-phase)	Two-phase	Standard (One-phase)	Two-phase
Sows	Gestation	17	14	0.65	0.5
	Lactation	17.5	16.5	0.65	0.6
Weaners	1st age (Pre-starter)	21	20	0.75	0.68
	2nd age (Starter)	19	18	0.75	0.58
Fattening pigs ⁽¹⁾	Growing (30–65 kg)	17.5	16.5	0.58	0.48
	Finishing (65–112 kg)	17.5	15 ⁽²⁾	0.58	0.44

⁽¹⁾ Feed conversion = 2.86 kg/kg. For over 112 kg, +0.006 kg per extra kg.
⁽²⁾ The finishing feed represents at least 60 % of the whole quantity of feed.
Source: [329, CORPEN 2003]

9.3 Example of calculation of costs associated with the application of emission reduction techniques

The scope of this annex is to describe an approach that can be used for calculating the cost of individual techniques proposed under the framework of the IED. The approach described relates to the 'unit' cost of techniques; it has also been adopted by UNECE for part of the process of calculating the compliance costs of reducing ammonia emissions from livestock production [508, TFRN 2014].

This annex further implies that, for this approach to be adopted, all techniques to be considered in the determination of BAT should be presented with the required technical and financial data as listed in the tables.

This annex is largely based on work done by DEFRA, UK, in turn based on work by an expert group within the TWG on cost assessment and BAT [557, MAFF 2000]. Cost calculation examples have been also drawn up by an expert group in Spain within the TWG [338, Piñeiro et al. 2009].

9.3.1 Methodology

This section comprises the following topic areas:

- overview;
- type of measure;
- calculation of 'unit' costs.

Overview

The calculation of unit costs requires a clear understanding of:

- the proposed technique to be introduced to reduce emissions;
- the whole range of systems of production and management that are found on relevant farms;
- the impact that the introduction of the technique will have on farm production and management systems in both physical and financial terms as well as in terms of costs and benefits.

The calculation will result in an annual cost, which may comprise an allowance for capital expenditure amortised over the life of the investment. Once calculated, these costs can be used in:

- the calculation of the cost of individual, or a combination of, techniques per kilogram of pollutant abated;
- the determination of general BAT;
- the relationship between the costs of BAT implementation and the economic viability or profitability of the intensive poultry or pig rearing industry;
- the cost to the industry of compliance.

Categories of technique

Techniques applicable to the intensive poultry or pig rearing sector may be categorised as follows:

- feeding;
- housing;
- solid manure or slurry storage;
- treatment of manure, if applicable;
- application of solid manure or slurry to land.

A technique should be identified under one of the above categories and according to livestock category affected, for example, laying hens or breeding pigs. The categories are subsequently used to identify how 'unit' costs should be calculated.

Calculation of unit costs

Unit costs are the annual increase in costs that a typical farmer will bear as a result of introducing a technique. The general approach to the calculation of unit costs is as follows:

- define the physical and husbandry changes resulting from implementation of the abatement technique based on a thorough understanding of farming systems;
- for each technique, identify those areas where cost or performance changes will be associated with the introduction of that technique;
- in all cases, only those costs directly associated with the technique should be considered;
- additional costs associated with any technical enhancements should be ignored;
- as the assessment of costs is carried out at farm level, any grants that are available should be deducted from expenditure.

The category that techniques fall into will determine the physical units that are used to define the population or quantities of manure, and form the basis of subsequent calculations. The relationship can be seen in the following table.

Table 9.29: Units used for assessing costs

Category	Units/year	Details
Feeding and housing	per head per animal place per kg NH ₃ abated per kg produced	Building capacity
Manure storage, treatment and landspreading	per m ³ or tonne per kg NH ₃ abated per kg produced	Slurry (including dilution) and solid manure (including bedding)

Unit costs should be calculated according to the general approach described below:

- current costs should be used for all calculations;
- capital expenditure, after deducting any grants, should be annualised over the economic life of the investment;

- annual operating costs should be added to the annualised cost of capital;
- changes in performance have a cost and should be taken into account as part of the annual costs;
- this total sum is divided by the annual throughput to determine the 'unit cost'; annual cost is expressed by the 'units' shown in Table 9.31.

The approach is detailed in the following paragraphs.

Capital costs

Capital expenditure needs to be assessed under the headings shown in Table 9.30.

Table 9.30: Capital expenditure considerations

Primary consideration	Notes
Capital for fixed equipment ⁽¹⁾ or machinery ⁽²⁾	Use national costs. If these are unavailable, use international costs including delivery cost and convert the cost to national currency at the appropriate rate.
Labour cost of installation	Use contract charges if these are normal. If farm staff are normally used to install the conversion, employed staff should be rated at typical hourly rates. Farmers' input should be charged at the opportunity cost.
Grants	Subtract the value of capital grants available to farmers.
⁽¹⁾ Fixed equipment includes buildings, conversions of buildings, feed storage bins, or manure storage. ⁽²⁾ Machinery includes feed distribution augers, field equipment for manure application or equipment for manure processing.	

Capital expenditure should clearly indicate the investment costs in new-build situations, in contrast with rebuilding or renovation of buildings.

Annual costs

The annual cost associated with the introduction of a technique needs to be assessed in the following steps.

Table 9.31: Annual cost considerations

Step	Consideration	Notes
A	Annualised cost of capital should be calculated over the life of the investment	Use standard formula. The term will depend on the economic life. Conversions need to take account of the remaining life of the original facility. See Appendix 1 to this section.
B	Repairs associated with the investment should be calculated	A certain percentage of the capital costs. See Appendix 2 to this section.
C	Changes in labour costs	Additional hours multiplied by cost per hour.
D	Fuel and energy costs	Additional power requirements may need to be taken into account. See Appendix 2 to this section.
E	Changes in livestock performance	Changes in diets or housing can affect performance, with cost implications. See Appendix 3 to this section.
F	Cost savings and production benefits	In certain cases, the introduction of techniques will result in the saving of costs for the farmer. These should be quantified as far as possible. Care should be taken for the avoidance of fines for pollution.

9.3.2 Examples in the UK

Liquid manure application by soil injection

Basis for the costs:

1. The costs are based on the purchase of an injector attachment for fitting to either the slurry tanker or the tractor. The capital cost of such equipment is EUR 10 000.
2. Additional tractor power of about 35 kW is needed compared to surface application.
3. Work rates of about 14 m³ per hour may be achieved compared to 17 m³ (2.5 loads per hour of 7 m³) per hour using a tanker and splash plate system. This is based on a 6-minute discharge for a splash plate operation being extended to 12 minutes when injecting.
4. Annual throughput 2 000 m³.
5. Capital cost amortised over 5 years at 8.5 %.
6. Emission reduction, e.g. reduction of ammonia emission expressed in mg NH₃/Nm³.

Table 9.32: Additional costs incurred with liquid manure application by soil injection in the UK

Step	Consideration	Calculation	Total (EUR/yr)
A	Annual cost of capital	Use formula given in Appendix 1 and shown below. $C = (r(1+r)^n)/((1+r)^n - 1)$ C = EUR 10 000 r = 8.5 % inserted into formula as 0.085 n = 5 years $EUR\ 10\ 000 = (0.085(1+0.085)^5)/((1+0.085)^5 - 1)$	2 540
B	Repairs	At 5 % of capital cost of injector (EUR 10 000)	500
C	Changes in labour costs	Slower application rates (2 000m ³ ÷ 14 m ³ /hr less 2 000m ³ ÷ 17 m ³ /hr) = 25 hours times EUR 12 per hour	300
D	Fuel and energy costs	Additional tractor costs: 35 kW for 2 000m ³ ÷ 14 m ³ /hr = 143 hrs at 10 litres per hour at EUR 0.35 per litre	500
E	Changes in livestock performance	Not applicable	0
F	Cost savings and production benefits	Not included, although there may be better use of manure nitrogen	0
	Total extra annual costs		3 840
	Total extra cost per m ³ based on an annual throughput of 2 000 m ³		1.92

Solid manure incorporation by ploughing (example calculation without capital expenditure)

Basis for the costs:

1. Contractors will need to be used to incorporate solid manure in many situations, as employed labour and machinery will be fully utilised on other tasks.
2. The method of incorporation will normally be by ploughing.
3. There will be a marginal cost saving, as this operation (ploughing) will not need to be carried out by farm staff at a later time.
4. Manure spread up to the equivalent of 250 kg total N per hectare per year.

Table 9.33: Additional costs incurred with solid manure incorporation by ploughing in the UK

Step	Consideration	Calculation	Total (EUR/ha)
A	Annual cost of capital	Not applicable	0
B	Repairs	Not applicable	0
C	Changes in labour costs	Employment of a contractor to carry out ploughing	65
D	Fuel and energy costs	Not applicable (included in contractor charge)	0
E	Changes in livestock performance	Not applicable	0
F	Cost savings and production benefits	Savings in farmer's own marginal machinery costs	10
	Total extra annual costs		55
	Extra cost per tonne of manure:		EUR/tonne
	Pig manure applied at 36 tonnes/ha		1.53
	Laying hen litter applied at 16.5 tonnes/ha		3.33
	Broiler litter applied at 8.5 tonnes/ha		6.47

Calculations with changes to a building: 1. Air ducts in deep pit poultry housing

Basis for the costs:

1. Simple polythene pipe air ducts are installed in the pit under the manure and fan ventilated. The capital cost is EUR 0.32 per bird place.
2. Such systems have additional operating costs of EUR 0.16 per bird place per year (electricity and repairs).
3. The capital costs of the system are amortised over 10 years at 8.5 %.

Table 9.34: Additional costs incurred with air duct installation in the UK

Step	Consideration	Calculation	Total (EUR/bird place)
A	Annual cost of capital	Cost of pipes and fan	0.05
B	Repairs	Additional repair costs	0.08
C	Changes in labour costs	Not applicable	0
D	Fuel and energy costs	Additional electricity costs	0.08
E	Changes in livestock performance	Not applicable	0
F	Cost savings and production benefits	Not applicable	0
	Total extra annual costs per bird place		0.21

Calculations for changes to a building: 2. Metal grid replacement floors in pig buildings

Basis for the costs:

1. Capital cost of replacement slats: EUR 78 per m² (*Tri-bar*) plus EUR 16 of installation.
2. Installation is uncomplicated.
3. The cost of capital is amortised over 10 years at 8.5 %. This allows for fitting the slats in existing accommodation, which is partway through its life.
4. Cost per pig place is based on a total allowance of 0.63 m² per pig place, see below. Of this area, normally 25 % or 0.156 m² per pig place is slatted in partly slatted accommodation.
5. Repair costs are considered to be similar to other types of floor.

Table 9.35: Additional costs incurred with metal grid floor replacement in the UK

Step	Consideration	Calculation	Total (EUR/pig place)
A	Annual cost of capital	Capital cost of EUR 94/m ² for 0.156 m ² amortised over 10 years at 8.5 %	2.23
B	Repairs	No extra costs	0
C	Changes in labour costs	Not applicable	0
D	Fuel and energy costs	Not applicable	0
E	Changes in livestock performance	Not applicable	0
F	Cost savings and production benefits	Not applicable	0
	Total extra annual costs per pig place		2.23

NB: Data provided by Kircroft Engineering (UK).

9.3.3 Examples in Spain

Multiphase feeding of fattening pigs (excluding feed cost)

Basis for the costs:

1. Baseline: Growing and finishing pigs are housed together and fed one ration.
2. Costs are calculated for the fitting of an additional feed storage bin and distribution system to each house to allow pigs to be fed a ration containing a protein level more precisely matched to their requirements.
3. The building capacity is 720 places, the building occupation is 85 % and the cleaning and disinfection lasts 10 days. The feed storage bin capacity is 12 tonnes, the length of the distribution auger is 140 metres and the power requirements 1 kWh.
4. Multiphase feeding may provide cost and feed conversion ratio improvements.

Table 9.36: Additional costs incurred for the installation of multiphase feeding in fattening pig houses in Spain

Step	Consideration	Calculation	Total (EUR/animal place)
A	Annual cost of capital	Storage bin: Investment cost of EUR 1 554 amortised over 10 years at 5.0 %	0.25
		Auger: Investment cost of EUR 3 500 amortised over 5 years at 5.0 %	1.12
B	Repairs	2 % of investment cost	0.14
C	Changes in labour costs	Not applicable	
D	Fuel and energy costs	Additional power requirements at EUR 0.12/kWh and 3 hours per day operation of motor	0.23
E	Changes in livestock performance	Not available, although multiphase feeding may provide feed conversion ratio improvements	
F	Cost savings and production benefits	Price difference between feeds: EUR 2/tonne Phase duration 20–60 kg: 55 days Phase duration 60–100 kg: 45 days Feed consume 20–60 kg: 1.4 kg/pig and day Feed consume 60–100 kg: 2.2 kg/pig and day	-0.25
	Total extra annual costs per animal place		1.52

The total costs can also be expressed as EUR 0.005 2 per kg of pig produced under the assumption that one animal place for fattening pigs produces 294 kg of marketed pig per year.

Retrofitting an animal house for gestating sows with a partly slatted floor and reduced pit

Basis for the costs:

1. Baseline: Gestating sows are reared on a fully slatted floor with a deep pit (more than 60 cm).
2. Costs are calculated for reducing the existing pit width by 50 %.
3. The building capacity is 230 places, the building surface is 460 m², the floor is 50 % slatted with concrete slats and the pit has a rectangular section with an average depth of 60 cm.

Table 9.37: Additional costs to install a partly slatted floor with a reduced pit in gestating sow houses in Spain

Step	Consideration	Calculation	Total extra costs (EUR/animal place)
A	Annual cost of capital	Investment costs of EUR 9 976 are amortised over 10 years (disassembly and assembly facilities: EUR 3 770, pit reformation: EUR 1 386, concrete for the pits: EUR 4 820) at a 5 % interest rate	5.27
B	Repairs	2 % of investment cost	0.41
C-F		Not applicable	
	Total extra annual costs per animal place		5.68

The total costs can also be expressed as EUR 0.002 1 per kg of pig produced under the assumption that one animal place for gestating sows produces 26.6 pigs marketed per year or 2 660 kg of marketed pig per year (with the assumption that one pig marketed at 100 kg).

For existing buildings, it is advisable to consider an economic security margin of 20 % (the existing conditions can be less favourable than in the example).

Installing a manure pan in a new animal house for farrowing sows

Basis for the costs:

1. Baseline: Farrowing sows are reared on a fully slatted floor with a deep pit.
2. The building capacity is 120 places, the total building surface is 684 m² and the floor remains 100 % slatted.

Table 9.38: Additional costs to install a manure pan with a smooth surface under the slatted floor in a new house for farrowing sows in Spain

Step	Consideration	Calculation	Total extra costs (EUR/animal place)
A	Annual cost of capital	Extra investment costs of EUR 14 070 are amortised over 10 years at a 5 % interest rate (cost of concrete + PVC sheet for the pit: EUR 1 407 per 12 places)	15.18
B	Repairs	2 % of investment cost	2.34
C-F		Not applicable	
	Total extra annual costs per animal place		17.52

The total costs can also be expressed as EUR 0.002 2 per kg of pig produced under the assumption that one animal place for farrowing sows produces 80 pigs marketed per year or 8 000 kg of marketed pig per year (with the assumption that one pig is marketed at 100 kg).

Retrofitting an animal house for farrowing sows with a manure pan

Basis for the costs:

1. Baseline: Farrowing sows are reared on a fully slatted floor with a deep pit.
2. The building capacity is 120 places, the total building surface is 684 m² and the floor remains 100 % slatted.

Table 9.39: Additional costs to install a manure pan with a smooth surface under the slatted floor in an existing house for farrowing sows in Spain

Step	Consideration	Calculation	Total extra costs (EUR/animal place)
A	Annual cost of capital	Investment costs of EUR 24 869 are amortised over 10 years (disassembly and assembly facilities EUR 1 080 per 12 places, brick partition EUR 20/m ² , cost of concrete + PVC sheet for the pit: EUR 1 407 per 12 places) at a 5 % interest rate	26.84
B	Repairs	2 % of investment cost	4.14
C-F		Not applicable	
	Total extra annual costs per animal place		30.98

The total costs can also be expressed as EUR 0.004 6 per kg of pig produced under the assumption that one animal place for farrowing sows produces 80 pigs marketed per year or 8000 kg of marketed pig per year (with the assumption that one pig is marketed at 100 kg).

For existing buildings, it is advisable to consider an economic security margin of 20 % (the existing conditions can be less favourable than in the example).

Installing slanted walls to separate faeces and urine in a new animal house for weaners

Basis for the costs:

1. Baseline: Weaners are reared on a fully slatted floor with a deep pit.
2. The building capacity is 1 320 places, the total building surface is 500 m² and the floor remains 100 % slatted.

Table 9.40: Additional costs to install slanted walls in the manure pit of a new house for weaners in Spain

Step	Consideration	Calculation	Total extra costs (EUR/animal place)
A	Annual cost of capital	Extra investment costs of up to EUR 2 088 are amortised over 10 years at a 5 % interest rate (EUR 0 to +30 % in relation to a deep pit)	0–0.20
B	Repairs	2 % of investment cost	0–0.03
C-F		Not applicable	
	Total extra annual costs per animal place		0–0.23

The total costs can also be expressed as up to EUR 0.000 4 per kg of pig produced under the assumption that one animal place for weaners corresponds to 5.79 rotations per year or 579 kg of marketed pig per year (with the assumption that one pig marketed at 100 kg).

Retrofitting an animal house for fattening pigs with a partly slatted floor

Basis for the costs:

1. Baseline: Fattening pigs are reared on a fully slatted floor with a deep pit (more than 70 cm).
2. Costs are calculated for the installation of a partly slatted floor (one-third solid and two-thirds slatted). The building capacity is 1 440 animal places, the building surface is 1 450 m² and the average depth of the pit is 70 cm.

Table 9.41: Additional costs to install a partly slatted floor and reduced pit in an existing gestating pig house in Spain

Step	Consideration	Calculation	Total extra costs (EUR/animal place)
A	Annual cost of capital	Investment costs of EUR 34 820 are amortised over 10 years (disassembly and assembly facilities: EUR 2 540/room of 120 places, brick partition: EUR 20/m ² , solid concrete floor: EUR 15/m ²) at a 5 % interest rate	3.13
B	Repairs	2 % of investment cost	0.48
C-F		Not applicable	
	Total extra annual costs per animal place		3.61

The total costs can also be expressed as EUR 0.012 3 per kg of pig produced under the assumption that one animal place for fattening pigs produces 294 kg of marketed pig per year.

For existing buildings, it is advisable to consider an economic security margin of 20 % (the existing conditions can be less favourable than in the example).

Slurry application by trailing hose machines

Basis for the costs:

1. The costs are based on the purchase of a trailing hose attachment for fitting to the slurry tanker using a splash plate for application of slurry to land.
2. The tanker capacity is 15 000 litres, the working width 12 metres, and the required tractor power 150 CV with a working rate of 19 m³/h.
3. The quantity of slurry to be spread annually is 5 375 m³ and it is generated by a fattening pig house with 2 500 animal places.

Table 9.42: Additional costs incurred for the fitting of a mounted trailing hose system to an existing slurry tanker

Step	Consideration	Calculation	Total extra costs (EUR/animal place)
A	Annual cost of capital	Investment costs of EUR 18 000 are amortised over 6 years at a 5 % interest rate	0.66
B	Repairs	12.82 % of investment cost	0.42
C	Changes in labour costs	A same working rate is assumed	NA
D	Fuel and energy costs	No additional tractor power is needed	NA
E	Changes in livestock performance	Not applicable	NA
F	Cost savings and production benefits	Not included, although there may be better utilisation of nitrogen in manure	NA
	Total extra annual costs per animal place		1.08

NB: NA = not applicable.

The total costs can also be expressed as EUR 0.013 5 per kg of pig produced under the assumption that one produced pig produces 0.8 m³ of slurry and that a pig is marketed at 100 kg.

Useful reporting of cost data

A number of issues and presentational factors make assimilation of cost data easier for the reader and could support future assessment.

Any report on costs should contain sufficient information to enable the uninformed reader to follow the logic and calculations. A combination of explanatory narrative and tables allows the reader to follow the thought processes of the author(s).

In all cases, the sources of the data should be identified. Where professional judgement has been used to derive certain figures or assumptions, this should be acknowledged.

It is suggested that a report should contain the following sections and format:

- Introduction
- Summary: Text and tables showing the unit cost of techniques
- Cost of technique: Text and tabular presentation for each technique showing the basis and calculation of the unit cost, drawing on supplementary data contained in appendices

9.3.4 Appendices

Appendix 1: Calculation of annual charge for capital

Capital expenditure on abatement techniques should be converted to an annual charge. Capital may be for buildings, fixed equipment or machinery. It is important to include only the additional or marginal capital associated with the abatement techniques.

Amortisation should be used to calculate the annual cost of capital. When using this method, an additional allowance for depreciation of the asset should not be included in the calculation. Factors derived from appropriate tables can be applied to the capital invested or the standard formula, shown below, can be used.

Formula

The formula for calculating the annual cost of capital items is:

$$\text{Equation 9.1: } C = \left[\frac{r(1+r)^n}{(1+r)^n - 1} \right]$$

where: C = capital investment;

r = rate of interest expressed as a decimal of 1, e.g. an interest rate of 6 % is entered in the equation as 0.06;

n = write-off period in years.

Rate of interest

The rate of interest that is applied should reflect that commonly paid by farmers and will vary by country and by investment term. For guidance, 5 % is the rate of interest commonly incurred by farmers seeking medium-term loans in Spain.

Write-off period

The write-off period will depend on the type of investment and whether it is a new facility or a conversion.

In the case of new facilities, the following economic lives are given as a guide. In particular circumstances it may be necessary to vary these figures.

Table 9.43: Economic life of new facilities

Type of investment	Economic life in years
Buildings	20
Fixed equipment installed in buildings	10
Machinery (depending on type)	7 or 5

In the case of conversions, it is necessary to annualise the capital cost over the remaining life of the original facility.

These figures reflect the economic life over which the investment should be considered rather than the operational life. In many cases, the facility may have an operational life in excess of the economic life, though it is the economic life that must be used in these calculations.

Appendix 2: Repair and fuel costsRepairs

Repair costs associated with any investment will vary greatly. The type of investment, original build quality, operating conditions, age in relation to design life and amount of use all play their part in influencing costs.

The following figures can be used for guidance.

Table 9.44: Repair costs as a percentage of new costs

Type of investment	Annual repair cost as a percentage of new cost
Buildings	0.5–2
Fixed equipment	1–3
Tractors	5–8
Manure and slurry spreaders	3–6

Fuel

The following general formulae can be used to calculate fuel costs:

Electricity:

$$\text{Equation 9.2: Fuel cost} = \text{kWh} \times \text{Hours of use} \times \text{Fuel price}$$

Tractor fuel:

$$\text{Equation 9.3: Fuel cost} = \text{kWh} \times \text{Fuel consumption per kWh} \times \text{Hours of use} \times \text{Fuel price}$$

Appendix 3: Unit costs - Some detailed considerations

The following detailed factors should be considered in relation to each technique.

Feed

Changes to diets can be applied to many classes of livestock to reduce ammonia emissions. The following implications need consideration in each case.

Table 9.45: Annual costs to consider in capital costs of feeding systems

Capital costs	Annual costs to consider
Additional feeding systems	Annual charges, repairs and power inputs
	Changes to carcass value
	Relative costs of diets
	Changes to livestock performance and feed consumption
	Changes in excreta output
	Changes in labour requirements

Housing

For those techniques requiring capital expenditure by farmers, it is necessary to consider the elements in the following table.

Table 9.46: Annual costs to consider in capital costs of housing systems

Capital costs	Annual costs to consider
Changes to housing systems	Annual charges, repairs and power inputs
	Changes in house capacity
	Changes in labour requirements
	Changes in bedding requirements
	Changes to livestock performance and feed consumption
	Changes in excreta storage capacity in the building
NB: Capital costs may refer to either the modification of existing facilities or the additional costs of replacement facilities. The choice will depend on building condition and suitability for conversion, normally related to age and remaining economic life. Only the additional costs of providing those facilities that relate to the pollution abatement should be included.	

Manure storage

For those techniques requiring capital expenditure by farmers, it is necessary to consider the elements in the following table.

Table 9.47: Annual costs to consider in capital costs of manure storage systems

Capital costs	Annual costs to consider
Additional storage	Annual charge, repair costs
Permanent covers	Annual charge, repair costs
	Cost of temporary covers on an annual basis
All covers	Changes in labour requirements
	Reductions in rainwater dilution

Manure landspreading**Table 9.48: Annual costs to consider in capital costs of manure storage systems**

Capital costs	Annual costs to consider
Low emission spreaders (compared to splash plate spreaders)	Annual charge, repair costs
	Changes in tractor power requirements
	Changes in work rates
	Changes in labour requirements

9.4 Reference techniques

The reference (or 'baseline') situation, against which emission reduction percentages can be calculated, is in most cases the practice or design that is the most commonly applied technique presently found on commercial farms and is used to construct baseline inventories.

Housing

Animal category	Reference housing system
Laying hens in enriched cages	Non-aerated belts, two removals a week
Laying hens in non-cage housing	Deep litter (or deep pit) with a partially littered floor
Broilers	Fan-ventilated house with a solid, fully littered floor
Turkeys	Solid, fully littered floor in closed, thermally insulated buildings with forced ventilation or in naturally ventilated houses with open side walls
Ducks	Fan-ventilated house with a solid, fully littered floor
Farrowing sows	Crates with metal or plastic slatted floors and a deep manure pit underneath, forced ventilation
Mating and gestating sows	Fully slatted floor (concrete slats) with a deep pit, forced ventilation
Fattening pigs	Fully slatted floor with a deep manure pit underneath, forced ventilation
Weaners	Fully slatted floor (in pens or flatdecks) with metal or plastic slats and with a deep pit, forced ventilation

Nutrition

The baseline feeding strategy for each animal category is one-phase feeding without nutritional measures to reduce nutrient excretion.

Manure storage

The baseline for estimating the efficiency of an abatement measure is the emission from the same type of store, without any cover on the surface.

Manure application

The baseline for manure application is untreated slurry or solid manure spread over the whole soil surface ('broadcast') and not followed by incorporation, and not targeting application timing conditions that minimise NH₃ loss. For slurry, this would typically consist of a tanker equipped with a discharge nozzle and splash plate. For solid manures, the reference case would be to leave the manure on the soil surface without incorporation.

Reference literature

[43, COM 2003] [508, TFRN 2014]

9.5 Data compilation for excretion

9.5.1 Total nitrogen excreted from pig rearing

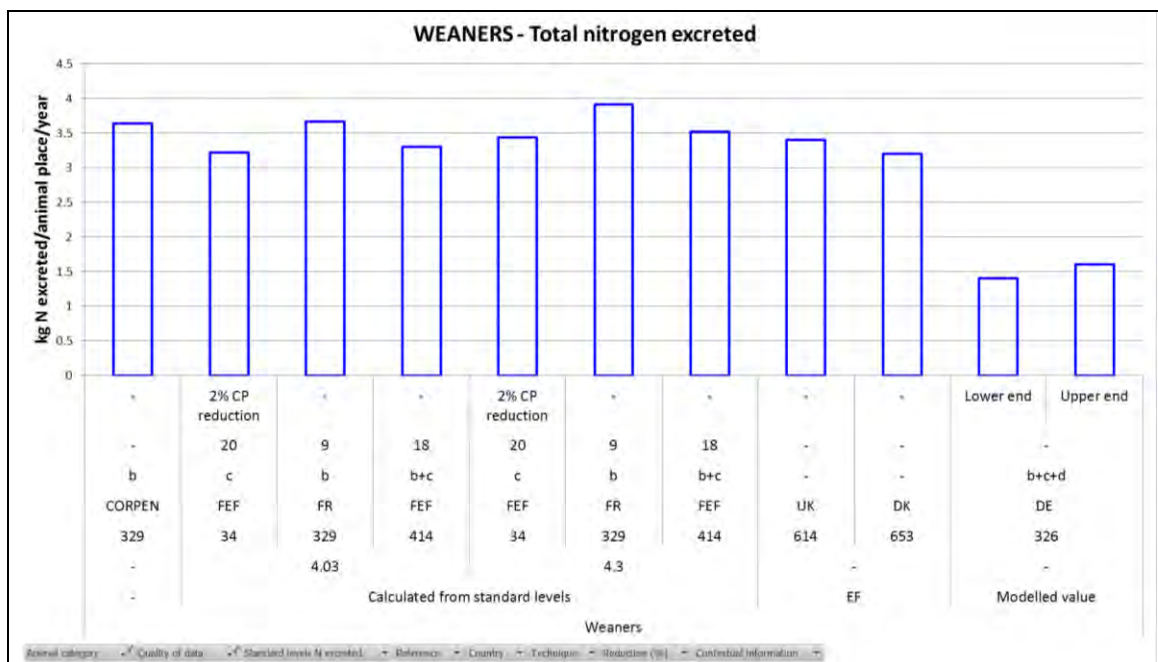

Figure 9.1: Total nitrogen excreted by weaners

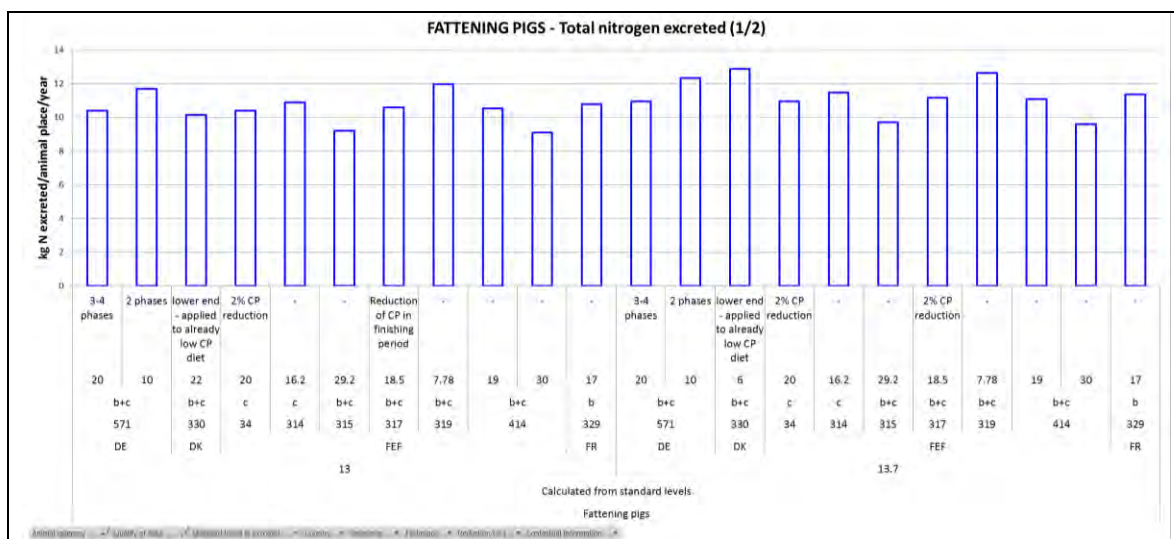

Figure 9.2: Total nitrogen excreted by fattening pigs (1 of 2)

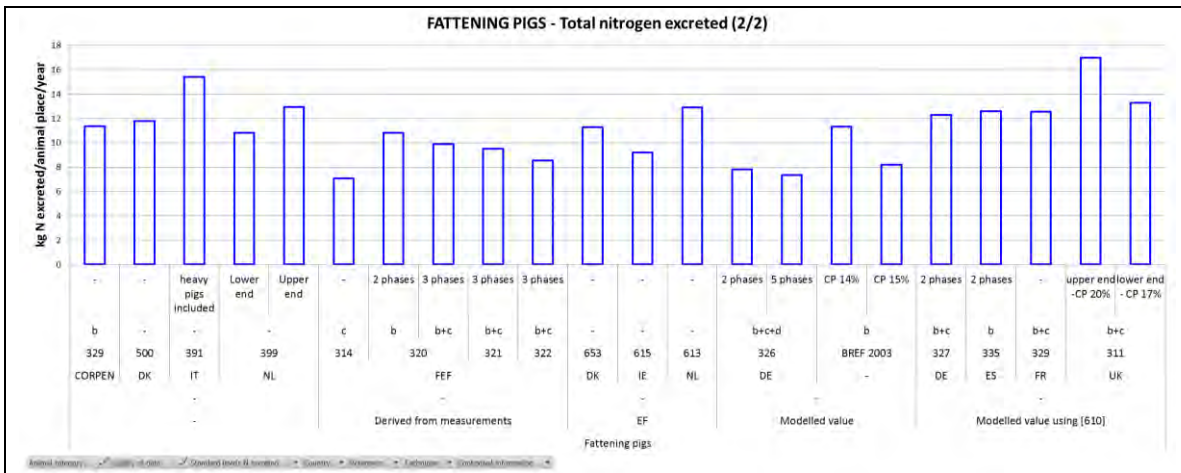

Figure 9.3: Total nitrogen excreted by fattening pigs (2 of 2)

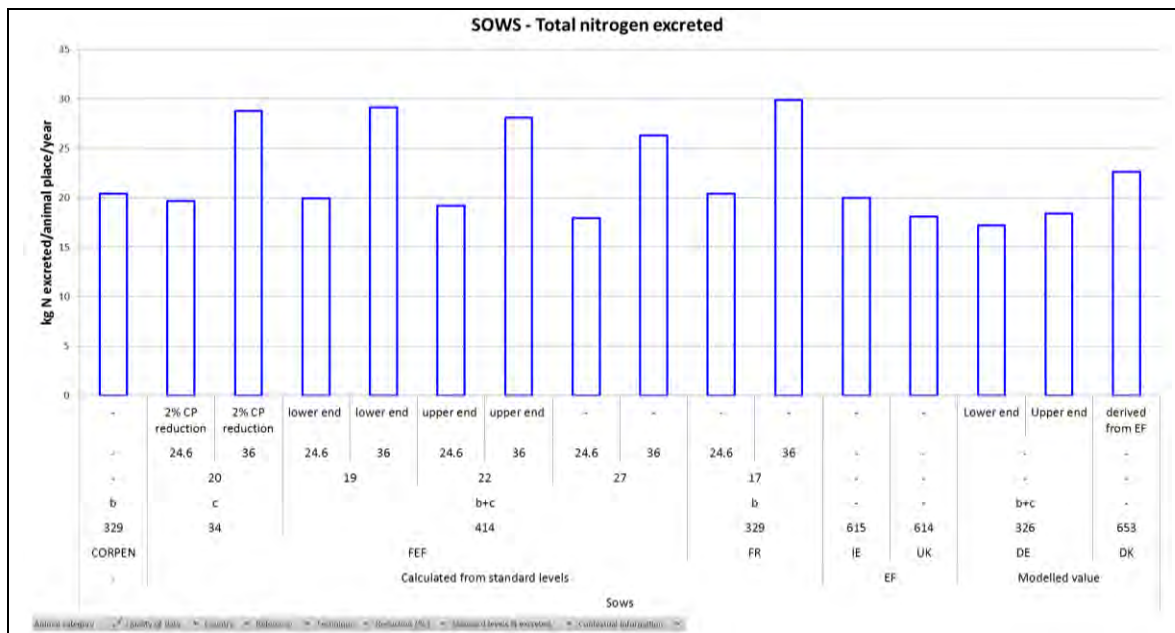

Figure 9.4: Total nitrogen excreted by sows

9.5.2 Total phosphorus excreted from pig rearing

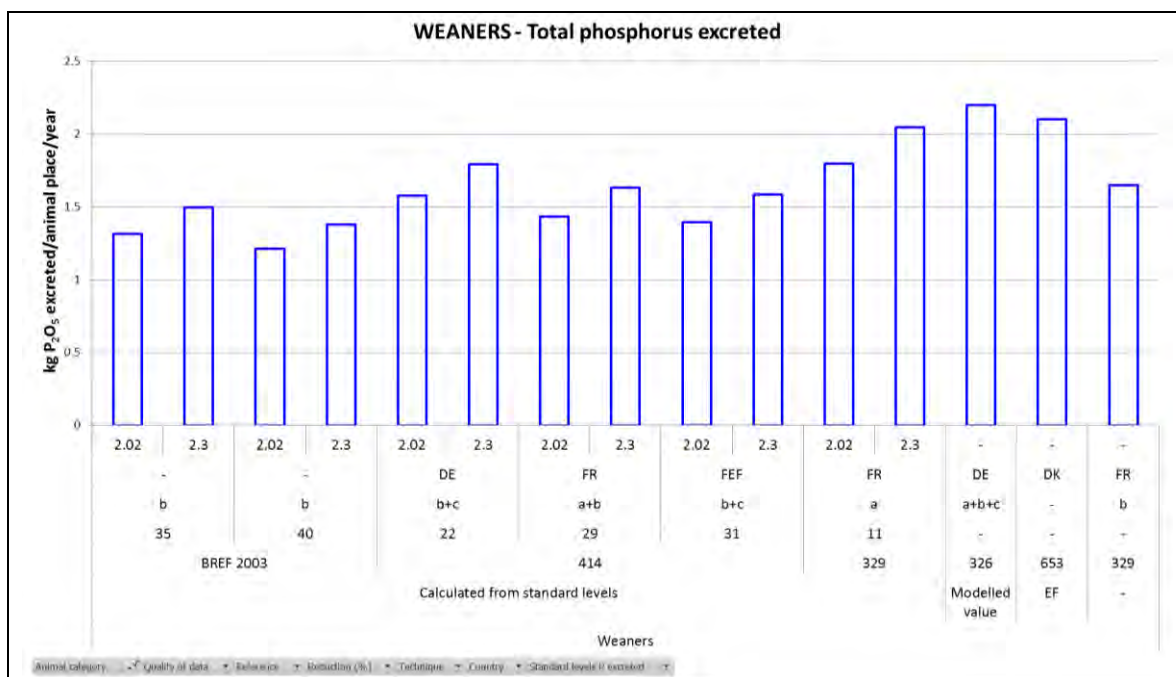

Figure 9.5: Total phosphorus excreted by weaners

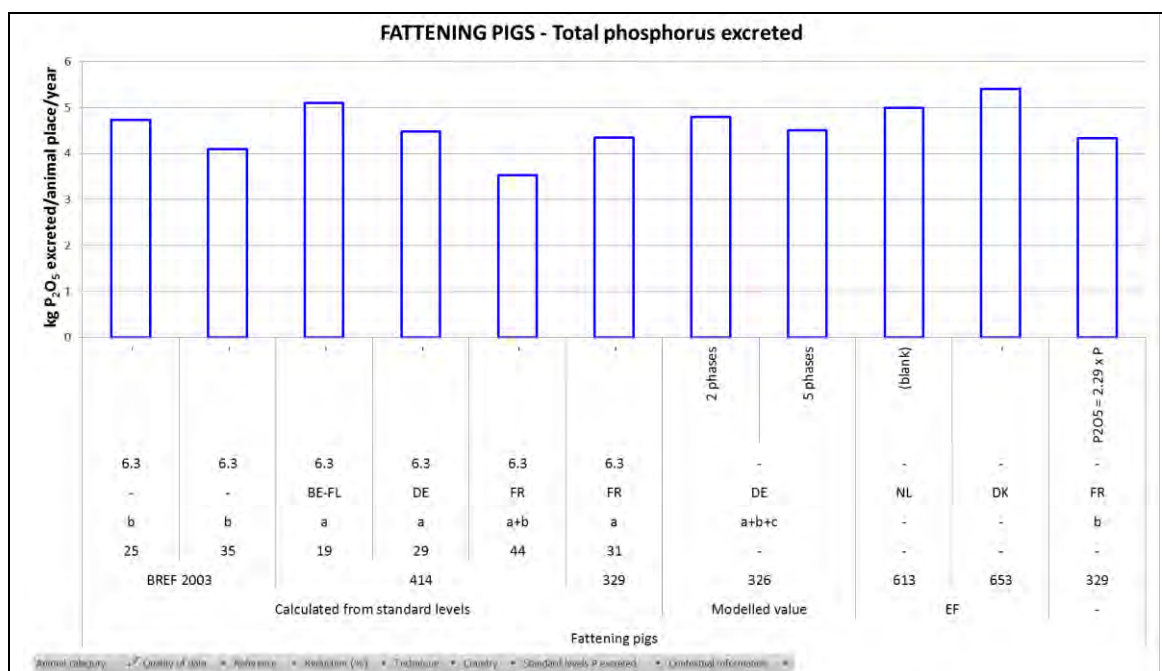

Figure 9.6: Total phosphorus excreted by fattening pigs

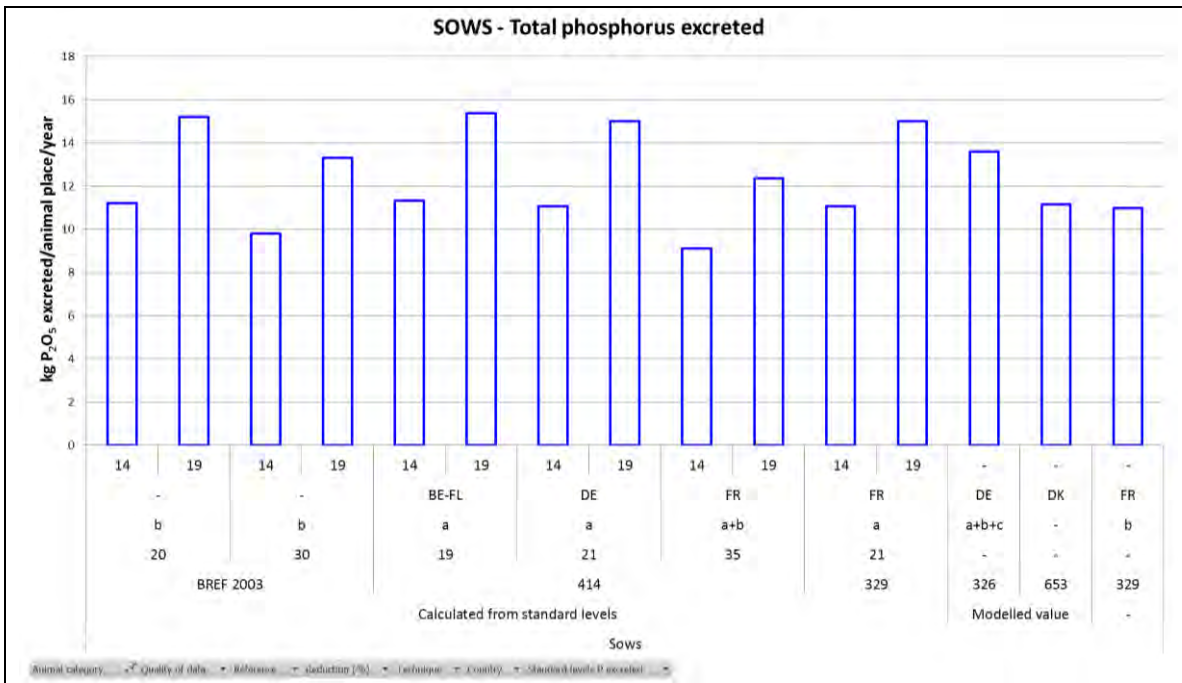

Figure 9.7: Total phosphorus excreted by sows

9.5.3 Total nitrogen excreted from poultry rearing

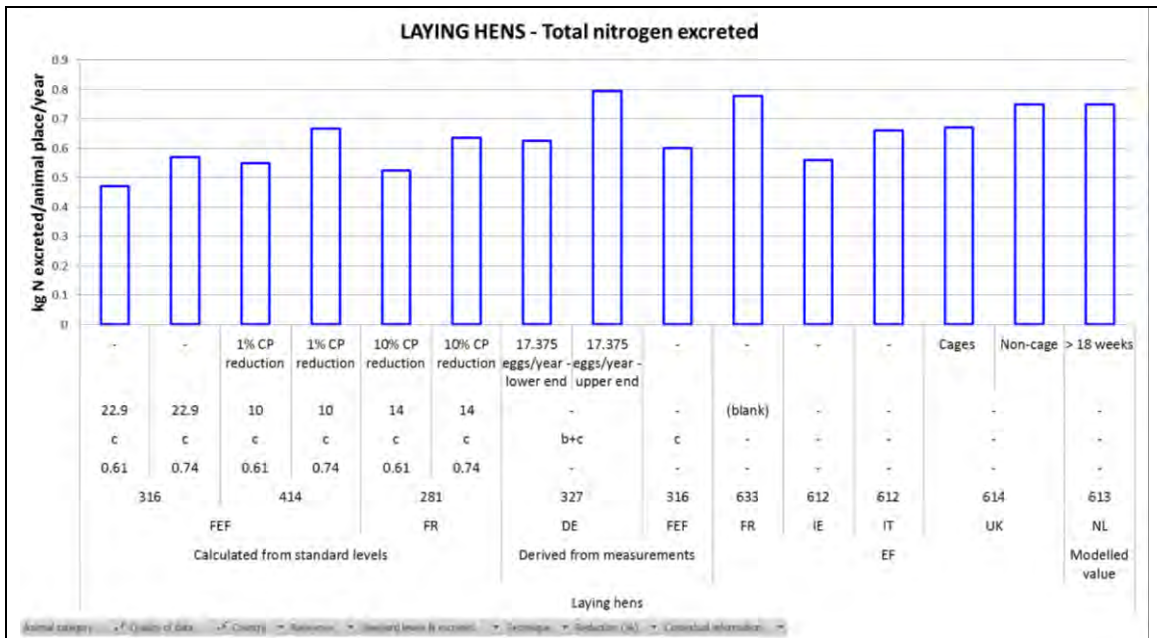

Figure 9.8: Total nitrogen excreted by laying hens

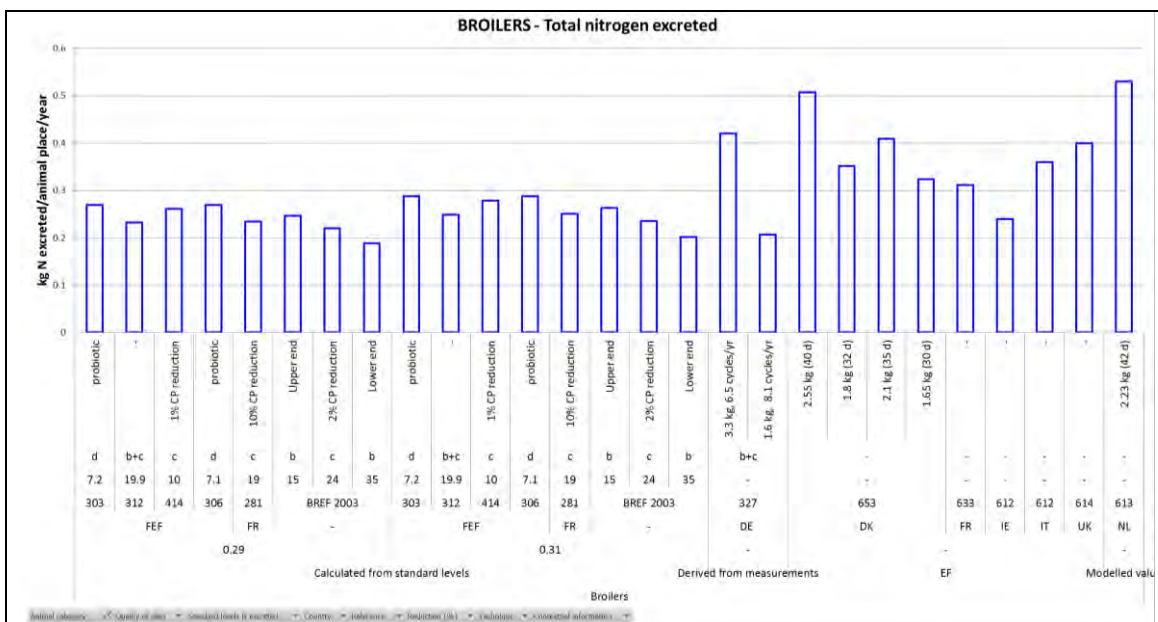

Figure 9.9: Total nitrogen excreted by broilers

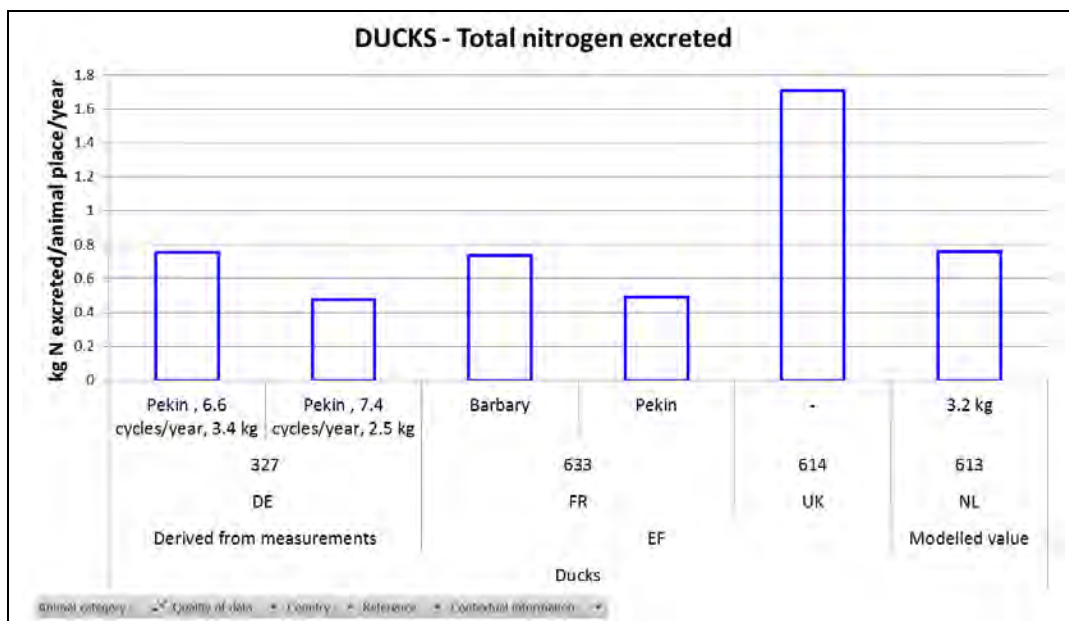

Figure 9.10: Total nitrogen excreted by ducks

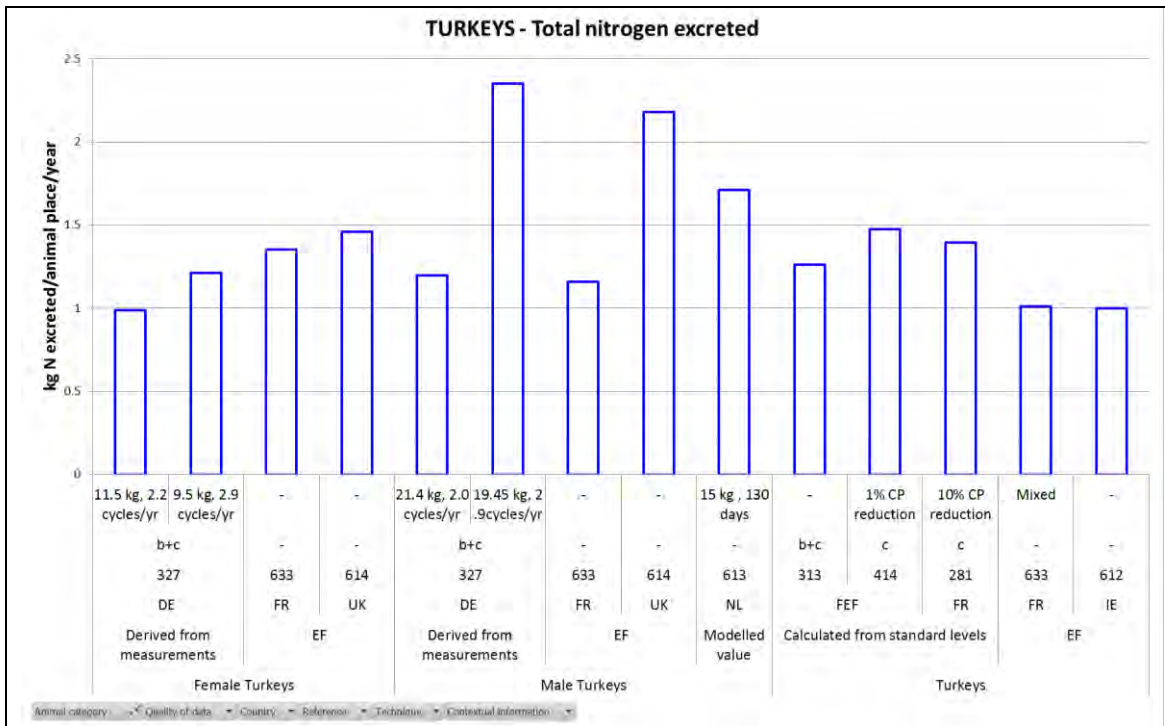

Figure 9.11: Total nitrogen excreted by turkeys

9.5.4 Total phosphorus excreted from poultry rearing

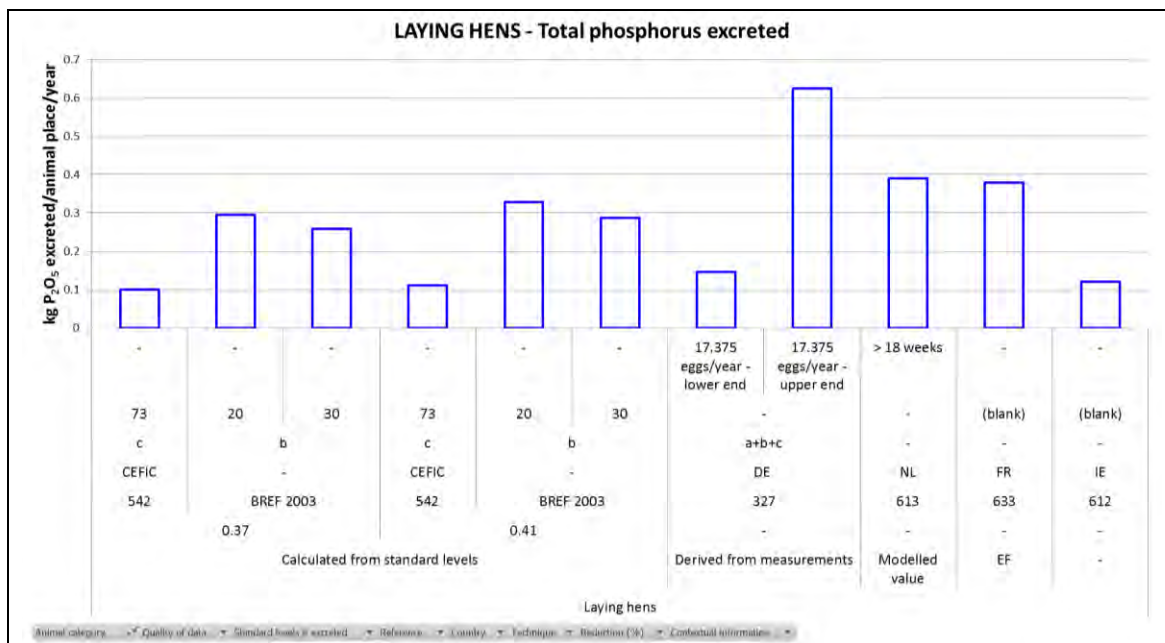

Figure 9.12: Total phosphorus excreted by laying hens

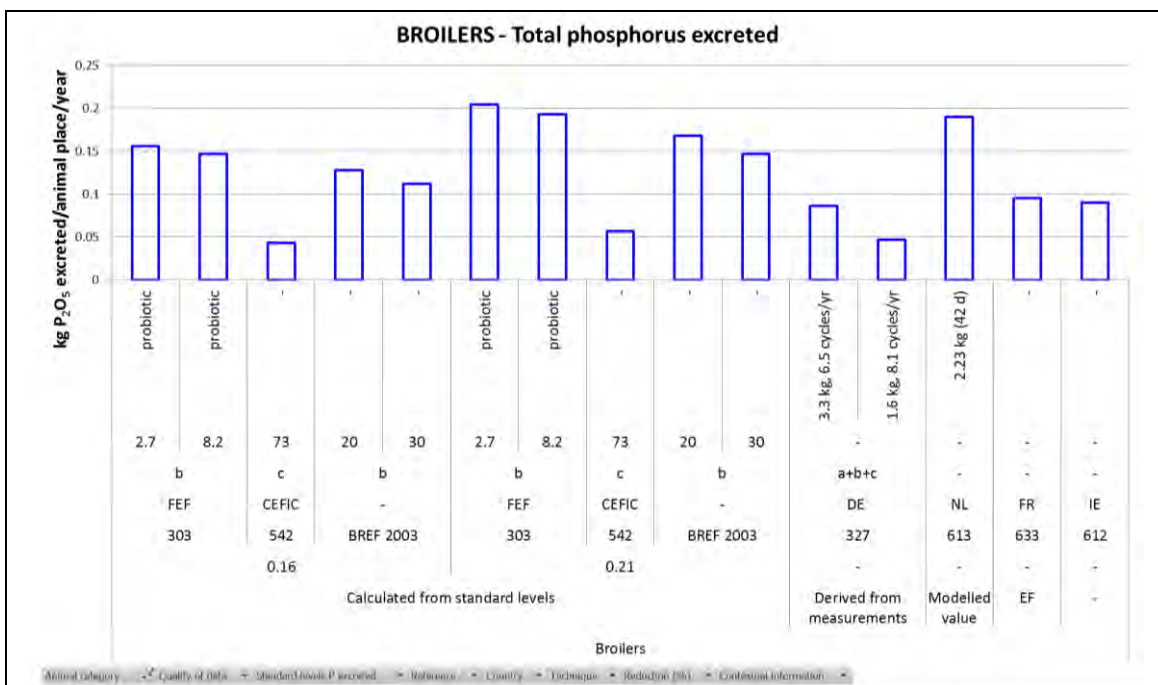

Figure 9.13: Total phosphorus excreted by broilers

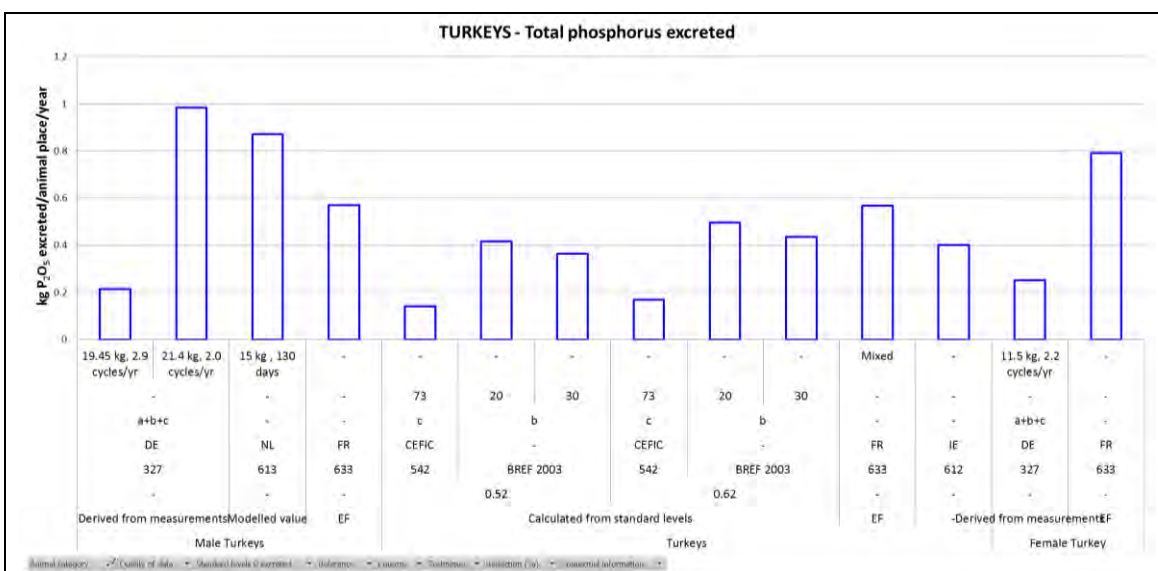

Figure 9.14: Total phosphorus excreted by turkeys

9.6 Data compilation for ammonia emissions

9.6.1 Ammonia emissions to air from an animal house for pigs

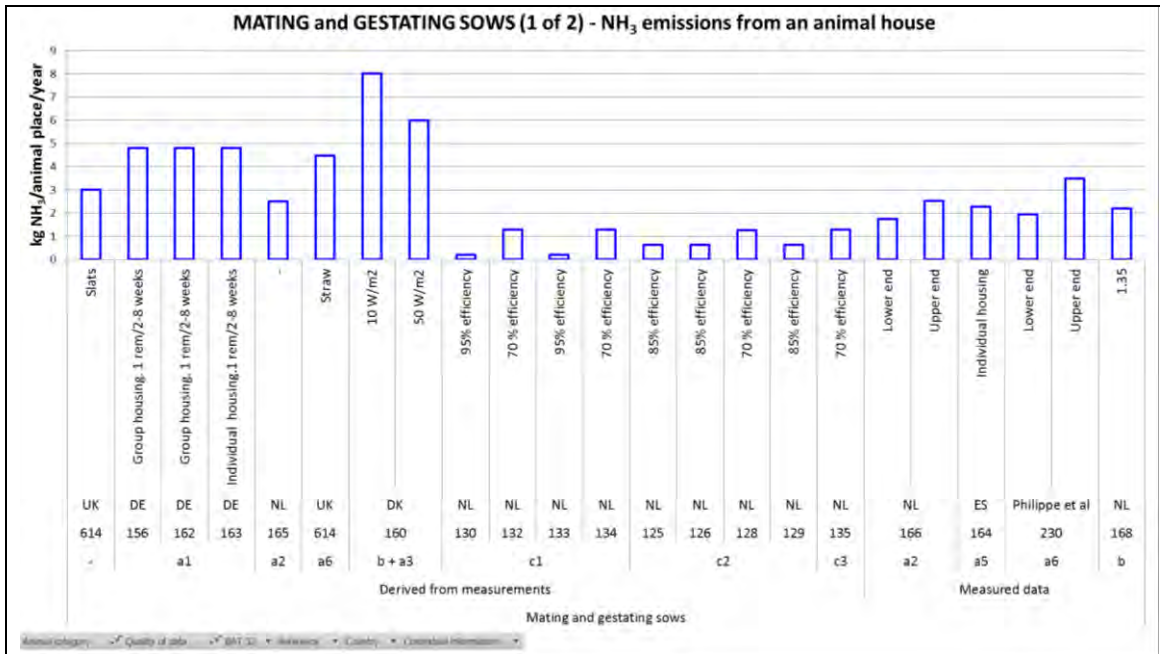

Figure 9.15: Ammonia emissions to air from an animal house for mating and gestating sows (1 of 2)

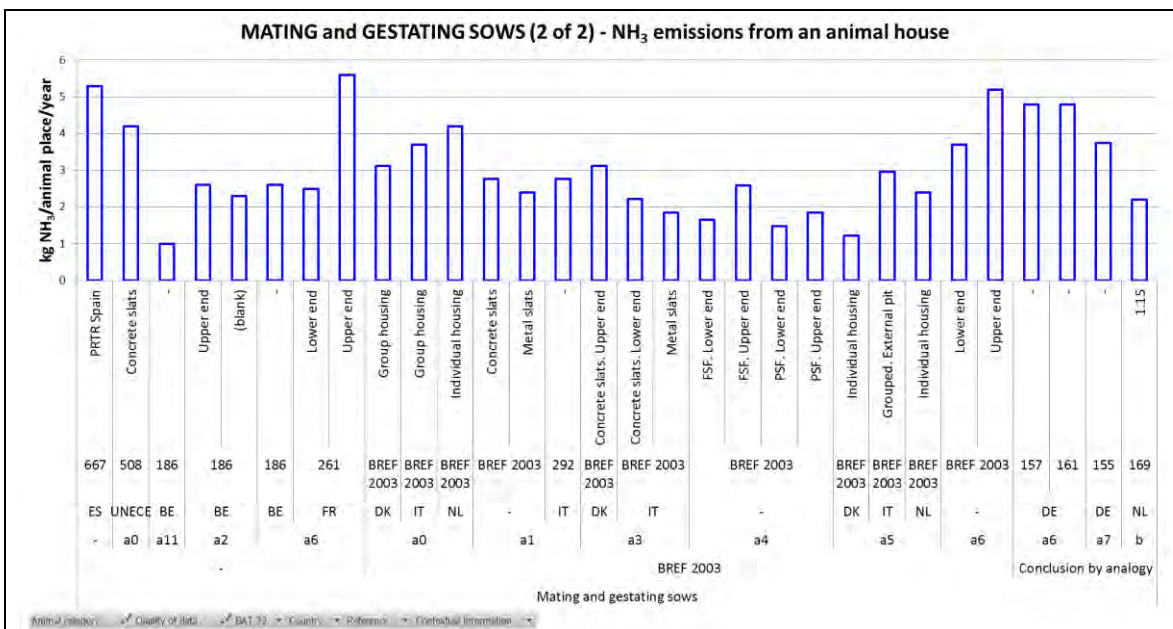

Figure 9.16: Ammonia emissions to air from an animal house for mating and gestating sows (2 of 2)

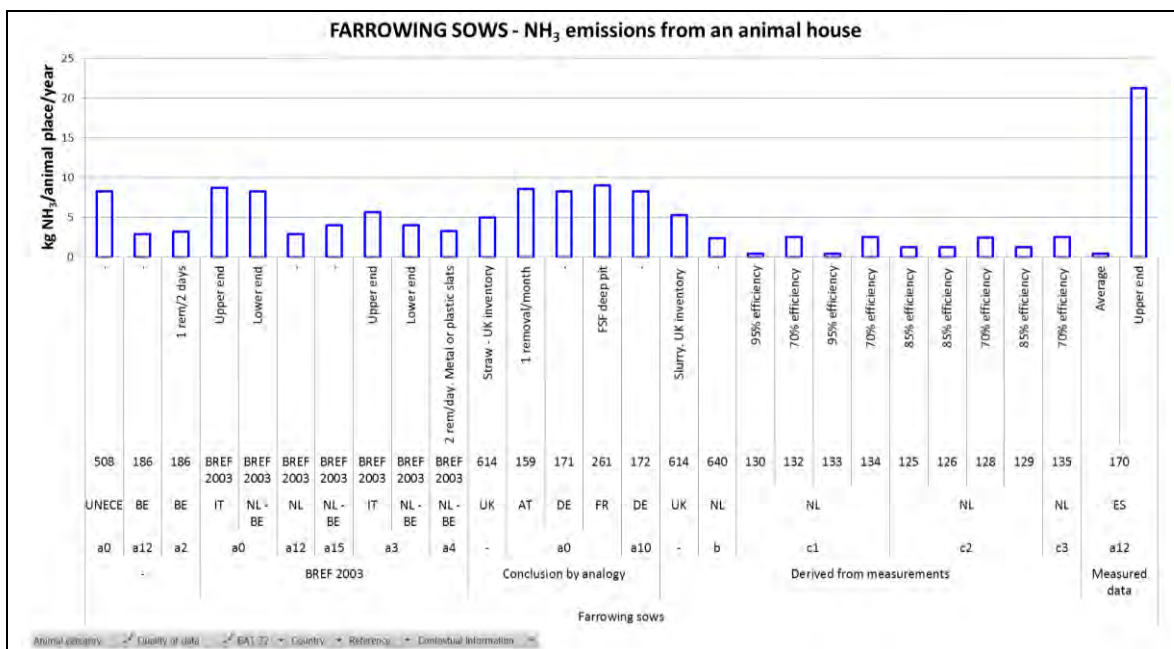

Figure 9.17: Ammonia emissions to air from an animal house for farrowing sows

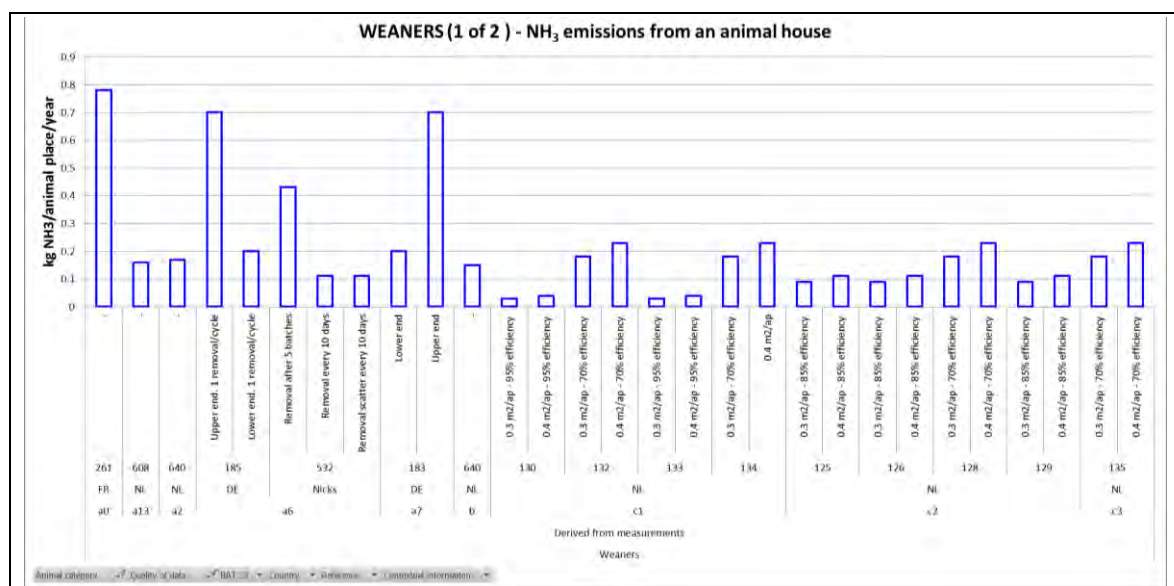

Figure 9.18: Ammonia emissions to air from an animal house for weaners (1 of 2)

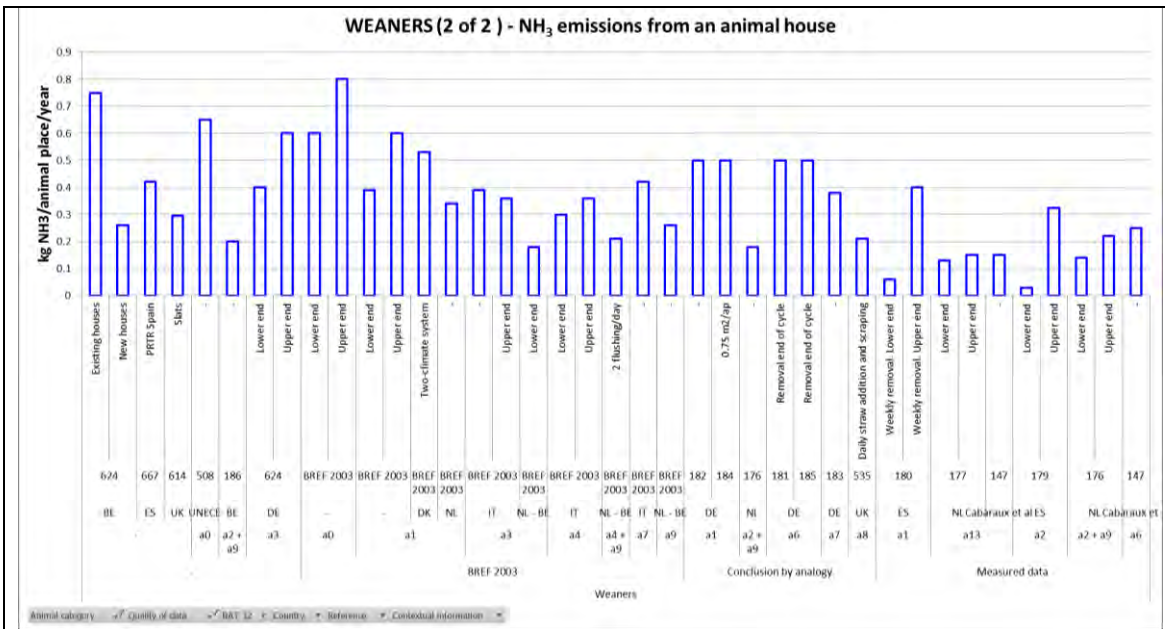

Figure 9.19: Ammonia emissions to air from an animal house for weaners (2 of 2)

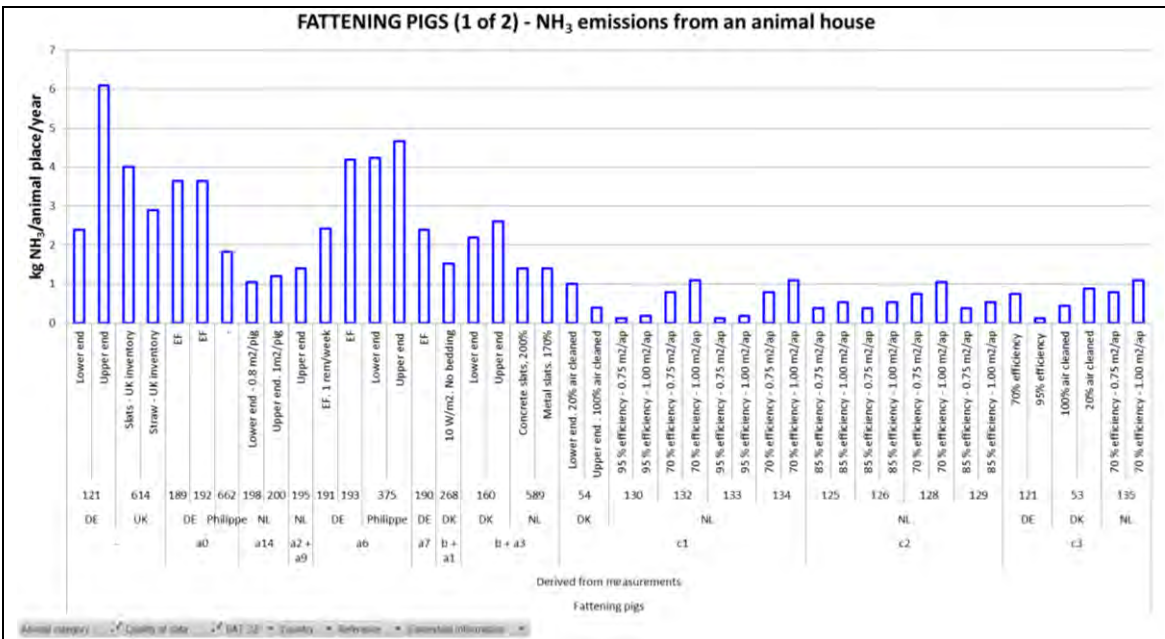

Figure 9.20: Ammonia emissions to air from an animal house for fattening pigs (1 of 2)

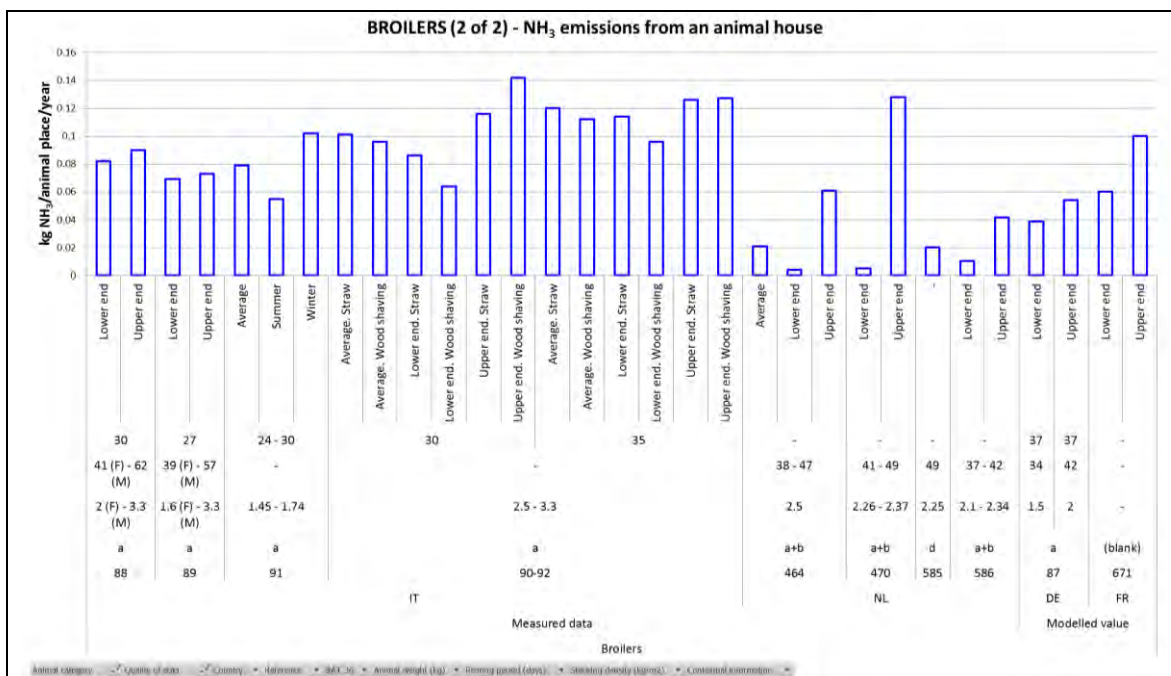

Figure 9.25: Ammonia emissions to air from an animal house for broilers (2 of 2)

10 REFERENCES

- [1] Eurostat, Food: from farm to fork statistics, Eurostat, 2011.
- [2] Eurostat, Agri-environmental indicator - livestock patterns. http://ec.europa.eu/eurostat/statistics-explained/index.php/Agri-environmental_indicator_-_livestock_patterns, 2017.
- [3] Eurostat, Pig population - annual data 2005-2013, 2014.
- [4] Eurostat, Pig farming sector - statistical portrait, 2014.
- [5] The Poultry Site, Upgrading Hen Housing: Latest Developments in Europe. <http://www.thepoultrysite.com/articles/1533/upgrading-hen-housing-latest-developments-in-europe>, 2017.
- [6] Eurostat, Livestock density index, 2017.
- [7] DG AGRI, Agriculture in the European Union. Statistical and Economic Information, 2013.
- [8] Portugal, Overview of intensive livestock farming in Portugal, 1999.
- [9] Italy, IT Annexes, 2013.
- [10] CIRCA, AGRI C4 Balance sheet for eggs, Balance sheet for poultrymeat, 2012.
- [11] ADAS, ILF 142 ADAS The practicability of fitting various types of emission control cover to above, 2000.
- [12] Eurostat, Livestock unit (LSU), 2015.
- [13] Melse, Air treatment techniques for abatement of emissions from intensive livestock production, Wageningen University, Wageningen, NL, 2009.
- [14] Spain, Pig CHAMP Pro Europa S.L. - PODZ, 2014.
- [15] Eurostat, Agriculture statistics at regional level, 2014.
- [16] Eurostat, Agricultural production - animals. http://ec.europa.eu/eurostat/statistics-explained/index.php/Agricultural_production_-_animals, 2017.
- [17] FAO, FOASTAT Livestock Primary, 2009.
- [18] FAO, Tackling climate change through livestock. A global assessment of emissions and mitigation opportunities, FAO, 2013.
- [19] Environment Agency (England and Wales), Additional guidance for H4 odour management - How to comply with your environmental permit, Environment Agency (England and Wales), 2011.
- [20] COM, Communication from the Commission to the European Parliament and the Council on the various systems of rearing laying hens in particular those covered by Directive 1999/74/EC, 2008.
- [21] EFSA, Welfare aspects of various systems for keeping laying hens, Scientific report, EFSA-Q-2003-92, 2005.
- [22] Bodemkundige Dienst, ILF 037 Bodemkundige Dienst, 1999.
- [23] EPA (UK), ILF 060 EPA Groundwater Protection schemes, 1999.
- [24] LNV, Handboek voor de pluimveehouderij, 1994.
- [25] BPEX, <http://www.bpex.org.uk>, 2015.
- [26] Finland, BAT report. Methods and techniques for reducing the environmental load due to intensive rearing of pigs and poultry, 2001.

References

- [27] UR Wageningen, NH₃ and dust emissions from broiler houses: Problems and solutions, 2012.
- [28] FORUM, Comments Forum to first draft, 2001.
- [29] Pahl, Environmental factors on pig production - Description of potential emissions, causes, abatement and legislation, 1999.
- [30] Spain, Comments on draft 2 ILF BREF, 2001.
- [31] MAFF, Making better use of livestock manure on grassland, 1999.
- [32] SCOPE, 'Agricultural phosphorus', SCOPE Newsletter, Vol. 21, 1997.
- [33] Calvet et al., 'Measuring gas emissions from livestock buildings: A review on uncertainty analysis and error sources', Biosystems engineering, 116(3), pp.221-231, 2013.
- [34] Ajinomoto, Prevention of nitrogen pollution from pig husbandry through feeding measures, 2000.
- [35] Netherlands, Text for discussion on IRPP BREF Landspreading, 2010.
- [36] R&R, ILF 113 R&R Kombideksysteem, 2000.
- [37] BOE España, Real Decreto 949/2009 de 5 de junio, por el que se establecen las bases reguladoras de las subvenciones estatales para fomentar la aplicación de los procesos técnicos del Plan de biodigestión de purines, 2009.
- [38] ASG Lelystad, LAYWEL, Welfare implications of changes in production systems for laying hens. Description of housing systems for laying hens (deliverable23), 2006.
- [39] Germany, Comments Germany to first draft (2003 ILF BREF formerly 124), 2001.
- [40] NFU/NPA, Comments on the 2nd draft of the ILF BREF (2003 ILF BREF formerly 183), 2001.
- [41] Netherlands, Comments Netherlands to first draft (2003 ILF BREF formerly 122), 2001.
- [42] Netherlands, Dutch notes on BAT for pig and poultry ILF (2003 ILF BREF formerly 10), 1999.
- [43] COM, Best Available Techniques (BAT) Reference Document for the Intensive Rearing of Poultry and Pigs (ILF BREF), 2003.
- [44] IKC, ILF 128 NL technical description of systems for housing poultry species, 2000.
- [45] E-PRTR, European Pollutant Release and Transfer Register (E-PRTR), 2017.
- [46] Netherlands, RAV_E1.5.5_BWL2009.10_illustration, 2010.
- [47] Netherlands, RAV_E2.12.1_BWL2004.11_illustration, 2010.
- [48] Netherlands, RAV_E1.7_BWL2001.06_A, 2010.
- [49] Germany, DE_housing_pullets_litter, 2010.
- [50] Austria, AT_pullet_Austria T rearing pullet, 2010.
- [51] BE Flanders, BelgiumFlanders_input e-o-p treatment techniques_scrubbers_concerns_annex9, 2010.
- [52] BE Flanders, BelgiumFlanders_e-o-p air treatment techniques_biobed_annex 10, 2010.
- [53] Denmark, DK_aircleaning_biofilter, 2010.
- [54] Denmark, DK_aircleaning_chemical, 2010.
- [55] Denmark, DK_aircleaner_chemical_appendix, 2010.
- [56] Denmark, DK_housing_poultry_manurebelt, 2010.
- [57] Denmark, DK_appendix_housing_Poultry_manurebelt, 2010.

- [58] Denmark, DK_housing_poultry_manuredry, 2010.
- [59] Denmark, DK_appendix_housing_Poultry_manuredry, 2010.
- [60] Germany, DE_housing_layers_aviaries, 2010.
- [61] Germany, DE_housing_layers_aviaries, veranda, 2010.
- [62] Germany, DE_housing_layers_aviaries,veranda,outdoor, 2010.
- [63] Germany, DE_housing_layers_enriched cages, 2010.
- [64] Germany, DE_housing_layers_litter, 2010.
- [65] Germany, DE_housing_layers_litter,veranda, 2010.
- [66] Germany, DE_housing_layers_litter,veranda,outdoor, 2010.
- [67] Netherlands, RAV_E2.5.6_BWL2009.10_A, 2010.
- [68] Spain, ES_poultry_laying_hen_1-1, 2010.
- [69] Spain, ES_poultry_laying_hen_1-2, 2010.
- [70] Netherlands, RAV_E2.12.1_BWL2004.11_A, 2010.
- [71] Netherlands, RAV_E2.11.3_BWL2005.04_A, 2010.
- [72] Netherlands, RAV_E2.11.4_BWL2005.05_A, 2010.
- [73] Netherlands, RAV_E2.11.2_BWL2004.10_A, 2010.
- [74] Netherlands, RAV_E1.8.2_BWL2005.03_A, 2010.
- [75] Netherlands, RAV_E1.8.3_BWL2006.10_A, 2010.
- [76] Netherlands, RAV_E1.8.4_BWL2006.11_A, 2010.
- [77] Netherlands, RAV_E1.8.5_BWL2006.12_A, 2010.
- [78] Netherlands, RAV_E1.8_BWL2005.0y_illustration, 2010.
- [79] Netherlands, RAV_E1.8.1_BWL2005.02-A, 2010.
- [80] Netherlands, RAV_E1.5.5_BWL2009.10_A, 2010.
- [81] Germany, DE_housing_pullets_aviaries, 2010.
- [82] Austria, AT_laying_hens_Austria D laying_hens in aviaries, 2010.
- [83] Italy, IT 02 Laying_hens-enriched cages, 2010.
- [84] UK, UK_housing Laying_hen enriched cages_4, 2010.
- [85] UK, UK_laying_hens_barn_1, 2010.
- [86] UK, UK_laying_hens_free range_2, 2010.
- [87] Germany, DE_housing_broiler_litter, 2010.
- [88] Italy, IT 03 Broiler cross V, 2010.
- [89] Italy, IT 04 Broiler tunnel V, 2010.
- [90] Italy, IT-broiler1, 2010.
- [91] Italy, IT-broiler2, 2010.
- [92] Italy, IT-broiler3, 2010.
- [93] Netherlands, RAV_E5.9.1.2V1, 2010.
- [94] Netherlands, RAV_E5.9.1.1V1, 2010.
- [95] UK, Energy efficiency for broilers, 2010.
- [96] UK, UK_broiler standard_1, 2010.

References

- [97] UK, UK_broiler_select_2, 2010.
- [98] UK, UK_broiler_cross_B2, 2010.
- [99] UK, UK_broiler_tunnel_B1, 2010.
- [100] UK, UK_broiler_side_B3, 2010.
- [101] UK, UK_broiler_ridge_B4, 2010.
- [102] UK, UK_housing_turkey_1, 2010.
- [103] UK, UK_housing_turkey_2, 2010.
- [104] UK, UK_ducks_natural_1, 2010.
- [105] UK, UK_ducks_forced_2, 2010.
- [106] UK, UK_ducks_shed_3, 2010.
- [107] UK, UK_ducks_FR_4, 2010.
- [108] BE Flanders, BelgiumFlanders_input_poultry_annex4_update 100302, 2010.
- [109] Netherlands, RAV_E4.4.2_BWL2004.14_A, 2010.
- [110] Netherlands, RAV_E4.8_BWL2007.10_A, 2010.
- [111] Netherlands, RAV_E4.5_BB98.10.066_A, 2010.
- [112] Netherlands, RAV_E4.4.1_BWL2004.13_A, 2010.
- [113] Netherlands, RAV_E4.2_BB97.01.050_A99.02.067_A, 2010.
- [114] Netherlands, RAV_E3.3_BWL2005.10.V2_A, 2010.
- [115] Netherlands, RAV_G2.1_poultry, 2010.
- [116] Germany, DE_housing_ducks_litter, 2010.
- [117] Germany, DE_housing_young_ducks_litter, 2010.
- [118] Germany, DE_housing_young_turkeys_litter, 2010.
- [119] Germany, DE_housing_turkeys_litter, 2010.
- [120] Germany, DE_biofilter, 2010.
- [121] Germany, DE_biotricklingfilter, 2010.
- [122] Germany, DE_2_stage_air_cleaner, 2010.
- [123] Germany, DE_3_stage_air_cleaner, 2010.
- [124] Netherlands, RAV_E7.3_BWL2009.19_A, 2010.
- [125] Netherlands, NL_Combined_Scrubber_85_Uniqfill_A, 2010.
- [126] Netherlands, NL_Combined_Scrubber_85_Inno+_A, 2010.
- [127] Netherlands, NL_Combined_Scrubber_85_Dorset_A, 2010.
- [128] Netherlands, NL_Combined_Scrubber_70_Big_Dutchman_A, 2010.
- [129] Netherlands, NL_Combined_Scrubber_85_Devrie_A, 2010.
- [130] Netherlands, NL_Chemical_Scrubber_95_Uniqfill_A, 2010.
- [131] Netherlands, NL_Chemical_Scrubber_90_Inno+_A, 2010.
- [132] Netherlands, NL_Chemical_Scrubber_70_Bovema_A, 2010.
- [133] Netherlands, NL_Chemical_Scrubber_95_Bovema_A, 2010.
- [134] Netherlands, NL_Chemical_Scrubber_70_Uniqfill_A, 2010.
- [135] Netherlands, NL_Biological_scrubber_70_Dorset_A, 2010.

- [136] UK, sid5: Poultry dust emissions, 2009.
- [137] Netherlands, RAV_E7.2_F6.2_BWL2009.18_A, 2010.
- [138] Netherlands, RAV_E7.1_F6.1_BWL2009.17_A, 2010.
- [139] Netherlands, NL_Combined_Scrubber_70_Big_Dutchman_A_Illustration, 2010.
- [140] Netherlands, RAV_E.7.1_BWL2009.17_illustration, 2010.
- [141] Italy, IT_Drying_tunnel_Ramiran08, 2010.
- [142] UK, Valeron: heat reflecting membranes/ radiant barriers 1 of 2, 2010.
- [144] Finland, FI Housing Broilers_1, 2010.
- [145] Finland, FI Housing Broilers_2, 2010.
- [146] DEFRA, Ammonia Fluxes Within Broiler Litter And Layer Manure Management Systems, 2002.
- [147] Cabaraux et al., 'Gaseous emissions from weaned pigs raised on different floor systems. Agric. Ecosyst. Environ., 2009,130, 86-92.', 2009.
- [148] BPC, Revision of Emission Factor for Broilers, 2009.
- [149] Robertson et al., 'Commercial-scale Studies of the Effect of Broiler-protein Intake on Aerial Pollutant Emissions', Biosystems Engineering, Vol. 82, 2002, pp. 217-225.
- [150] CRPA, 'Il tunnel di essiccazione esterno per pollina: benefici ambientali e costi energetici', Professione Avicunicoltore, Vol. 9, No 10, 2008, pp. 2-7.
- [151] Link CR, UK Poultry Industry IPPC Compliance, 2005.
- [152] Link CR, UK Poultry Industry IPPC Compliance. Emissions to air from Highfield farm Commercial Duck rearing Houses, 2006.
- [153] Netherlands, Background information on determination of emission levels, 2010.
- [154] Czech Republic, Ionisation in pig stables, 2010.
- [155] Germany, DE_housing waiting sow_kennel housing, 2010.
- [156] Germany, DE_housing waiting sow_slatted floor with drained area, 2010.
- [157] Germany, DE_housing waiting sow_plane floor and yard, 2010.
- [158] EC, 'Council Directive 2008/120/EC of 18 December 2008 laying down minimum standards for the protection of pigs ', Official Journal of the European Union, Vol. L 47, 18.2.2009, 2008, pp. 5-13.
- [159] Austria, AT_sows_Austria P farrowing sow_mating gestating sow_waiting sow, 2010.
- [160] Denmark, DK_housing manure_cooling_waiting_sow, 2010.
- [161] Germany, DE_housing mating_deep litter, 2010.
- [162] Germany, DE_housing waiting sow_fully slatted with lying pen, 2010.
- [163] Germany, DE_housing mating_group, 2010.
- [164] Spain, ES_housing_gestating_sows_1, 2010.
- [165] Netherlands, D1392 - BWL 2006.09_A, 2010.
- [166] Netherlands, D1391 - BB0006085_A, 2010.
- [167] Netherlands, Illustration D 1392 - BWL 2006.09, 2010.
- [168] Netherlands, D_1.3.8.1__115%_-A- -cooling fins, 2010.
- [169] Netherlands, D_1.3.8.2_135%_A - cooling fins, 2010.
- [170] Spain, ES_housing_farrowing_sows_1, 2007.

References

- [171] Germany, DE_housing farrowing_individual_1, 2010.
- [172] Germany, DE_housing farrowing_individual_2, 2010.
- [173] UK, UK_housing_fixed farrower_1, 2010.
- [174] UK, UK_housing_fixed farrower_2, 2010.
- [175] Ecodyn, Scottish pig industry - response to BREF, 2010.
- [176] Netherlands, D_1.1.12.3 ___BB_99.06.072-A, 2010.
- [177] Netherlands, D1131 - BWL 200606_A, 2010.
- [178] Netherlands, Illustration D 1131 - BWL 2006.06, 2010.
- [179] Spain, ES_housing_weaner_1, 2010.
- [180] Spain, ES_housing_weaner_2, 2010.
- [181] Germany, DE_housing weaner_deep litter, 2010.
- [182] Germany, DE_housing weaner_fully slatted, 2010.
- [183] Germany, DE_housing weaner_kennel housing, 2010.
- [184] Germany, DE_housing weaner_partly_slatted, 2010.
- [185] Germany, DE_housing weaner_plane floor and yard, 2010.
- [186] BE Flanders, BelgiumFlanders_input pigs_annex6_update 100302, 2010.
- [187] Spain, ES_housing_fattening_pigs_2, 2010.
- [188] Spain, ES_housing_fattening_pigs_3, 2010.
- [189] Germany, DE_housing fattening pig_fully slatted, 2010.
- [190] Germany, DE_housing fattening pig_kennel_housing_partly slatted, 2010.
- [191] Germany, DE_housing fattening pig_plane floor_yard, 2010.
- [192] Germany, DE_housing fattening pig_partly slatted, 2010.
- [193] Germany, DE_housing fattening pig_deep_litter, 2010.
- [194] Netherlands, D32711 - BWL 200403_A, 2010.
- [195] Netherlands, D32712 - BWL 200404_A, 2010.
- [196] Spain, ES_housing_fattening_pigs_1, 2010.
- [197] Denmark, DK_housing_manure_cooling_waiting_sow_appendix, 2010.
- [198] Netherlands, D32161 - BWL 200810_A, 2010.
- [199] Netherlands, Illustration D32161- BWL 2008.10, 2010.
- [200] Netherlands, D32162 - BWL 200811_A, 2010.
- [201] Mul M. et al, EU-Welfare legislation on pigs (Report 273), Wageningen UR, 2010.
- [202] EAAP, 'Pig Housing system in Europe: current trends', 1998.
- [203] ADAS, ES0138 Review of livestock manure management options in Europe, 2005.
- [204] IMPEL, Final report IMPEL IPPC Pig farms - main, 2009.
- [205] ADAS, Management techniques to minimise ammonia emissions during storage and land spreading of poultry manures, 2000.
- [206] Silsoe, Fugitive emissions of methane from anaerobic digestion, 2000.
- [207] ADAS, Management techniques to minimise ammonia emissions from solid manures, 2004.
- [208] Spain, ES_slurry_storage_1, 2010.

- [209] Denmark, DK_storage_natural floating layer, 2010.
- [210] Denmark, DK_storage_Tent covering, 2010.
- [211] Germany, DE_slurry storage_lagoon, 2010.
- [212] Germany, DE_solid manure storage, 2010.
- [213] Netherlands, Floating balls_A, 2010.
- [214] Germany, DE_slurry storage_above-ground silo-water protection area, 2010.
- [215] Germany, DE_slurry storage_below-ground silo, 2010.
- [216] Denmark, DK_storage_Floating bricks, 2010.
- [217] Denmark, DK_storage_Light tiles, 2010.
- [218] Baltic Sea 2020, Best Available Technologies for Manure Treatment, Baltic Sea 2020, 2010.
- [219] Netherlands, On farm manure treatment technology in the Netherlands, 2010.
- [220] Germany, DE_Manure separator, 2010.
- [221] Denmark, DK_treatment_slurry_seperation_screwpress, 2010.
- [222] Denmark, DK_treatment_slurry_seperation_decanter_centrifuge, 2010.
- [223] Denmark, DK_treatment_slurry_seperation_flocculation_appendix, 2010.
- [224] Finland, FI Pellon Manure Treatment.pdf, 2010.
- [225] Finland, Manure phosphorus fractionation by gypsum-based precipitate, 2010.
- [226] Germany, DE_Manure belt-dryer, 2010.
- [227] Denmark, DK_storage_fibre fraction covering, 2010.
- [228] Denmark, DK_treatment_manureacid, 2010.
- [229] Finland, FI Housing sows with anaerobic digester, 2010.
- [230] Philippe et al., 'Gaseous emissions from group-housed gestating sows offered a high-fibre diet ad libitum. Agric. Ecosyst. Environ., 2009, 132, 66-73.', 2009.
- [231] Italy, IT 06 Manure treatment dryer, 2010.
- [232] Huijsmans et al., 'Ammonia and nitrous oxide emissions following field-application of manure: state of the art measurements in the Netherlands', 2009.
- [233] Denmark, DK_application_trailing_hoses, 2010.
- [234] Spain, ES_trailing_shoe_1, 2010.
- [235] Spain, ES_bands_1 (trailing hose), 2010.
- [236] Denmark, DK_application_injection_bare soil, 2010.
- [237] Denmark, DK_application_injection_winter crop, 2010.
- [238] Denmark, DK_application_injection_grassland, 2010.
- [239] Spain, ES_incorporation_1, 2010.
- [240] Italy, IT 05 Manure application dripline, 2010.
- [241] Italy, IT-driplines-Ramiran116, 2010.
- [242] CRPA, IT_driplines, 2009.
- [243] Webb J. et al, 'Validating the MAVIS model for optimizing incorporation of litter-based manure to reduce ammonia emissions', ASABE Technical Library 49(6): 1905-1913, 2006.

References

- [244] ADAS, Optimising slurry application timings to minimise nitrogen losses, 2006.
- [245] ADAS, N₂O and denitrification measurements on nutrient demo farms, 2002.
- [246] Basford, NC Pulse Jet Irrigator. Evaluation of spread pattern and C of V % calculation, 2010.
- [247] IGER, Ammonia emissions from irrigation of dilute pig slurry, 2003.
- [248] ADAS, Optimising the performance of low trajectory slurry application techniques, 2001.
- [249] Webb et al., 'Manure applications to reduce nitrate and ammonia pollution: scenario analysis using the MANNER model', Soil Use and Management, 2001.
- [250] IGER, Field storage of manure and nitrous oxide emissions, 2004.
- [251] KTBL, Ventilation in pig housing, 2009.
- [252] IGER, Straw use in reducing NH₃ emissions, 2005.
- [253] ADAS, Environmental impacts of solid and liquid manure systems, 2002.
- [254] Webb J.M. et al., Review of the efficiency of methods to reduce emissions of ammonia following the application of manures to land, their costs, potential agronomic benefits and impacts on emissions of nitrous oxide, 2009.
- [255] BE Flanders, BelgiumFlanders Manure storage times in Flanders, 2010.
- [256] VITO, Beste Beschikbare Technieken voor mestverwerking, 2006.
- [257] France, French proposition concerning manure - chapter 2, 2010.
- [258] France, French proposition concerning manure - chapter 3, 2010.
- [259] France, French proposition concerning manure - chapter 4, 2010.
- [260] IGER, Predicting ammonia loss following the application of organic manures to land, 2001.
- [261] France, French proposition concerning pig housing - chapter 4, 2010.
- [262] France, French proposition concerning pig housing - chapter 2, 2010.
- [263] France, French proposition concerning pig housing- chapter 3, 2010.
- [264] Loyon et al., 'Intensive livestock farming systems across Europe – A review of the current impact from the IPPC directive based on data gathered by questionnaire', 14th Ramiran Conference, Lisboa 12-15 September 2010, 2010.
- [265] BE Flanders, Extra costs for new to build housing systems in BelgiumFlanders, 2005.
- [266] Austria, AT_fattening pigs_Austria U fattening pigs, 2010.
- [267] UK, UK_housing_pig_finisher_1, 2010.
- [268] Denmark, DK_housing_manure_cooling_fattening_pigs/gilts, 2010.
- [269] France, Template for fully slatted floor for fattening pigs, 2010.
- [270] France, Templates_FR_fullyslatted2, 2010.
- [271] France, Templates_FR_partiallyslatted1, 2010.
- [272] France, Templates_FR_partiallyslatted2, 2010.
- [273] BE Flanders, BelgiumFlanders_annex12_Kostrpijs verbouwingen, 2010.
- [274] BE Flanders, BelgiumFlanders_annex11_summary cost prices rebuilding pig housing systems, 2010.
- [275] DIN, DIN 18910-1:2004 Principles for planning and design for closed ventilated livestock buildings, 2004.
- [276] Finland, FI Housing FatteningPigs_1, 2010.

- [277] Ji-Qin et al., 'Ammonia emissions from a large mechanically-ventilated swine building during warm weather', *Journal of Environmental Quality*, Vol. 29, 2000.
- [278] Fefana, FEF-IPPC_Brumisation_10-04-06, 2010.
- [279] Fefana, FEF Brumisation Dossier technique élevage, 2010.
- [280] France, French proposition concerning feed- chapter 3, 2010.
- [281] France, French proposition concerning feed- chapter 4, 2010.
- [282] Netherlands, 1% Benzoic acid_A, 2010.
- [283] Guingand et al., Effects of adding 0.5% of benzoic acid (VevoVital®) to the feed of growing-finishing pigs on urinary pH, ammonia and performance (Trial Romillé), 2005.
- [284] Guingand et al., Effects of adding 0.5% and 1% of benzoic acid (VevoVital®) to the feed of growing-finishing pigs on urinary pH, ammonia and performance (Trial Villefranche de Rouergue), 2005.
- [285] Fefana, FEF-Nutrition-Benzoic_Acid-KU_Leuven-2004, 2004.
- [286] Guarino et al., Photocatalytic TiO₂ coating—to reduce ammonia and greenhouse gases concentration and emission from animal husbandries, 2008.
- [287] Jelínek et al., 'Research of the utilization of biotechnological agents for the reduction of ammonia and greenhouse gases emissions in livestock breeding in the Czech Republic', *Research in Agricultural Engineering*, Vol. 53, 2007, pp. 126-133.
- [288] Wageningen, FEF_Nutrition_Benzoic_Acid-Wageningen, 2008.
- [289] MLC, LS3601 Finishing Pigs - Systems Research, 2005.
- [290] Univ. of Newcastle, WA0321 A review and workshop to agree advice on reduced nutrient pig diets, 2002.
- [291] IRPP TWG, ILF 184 TWG ILF 2002, 2002.
- [292] Italy, ILF 185 Italy, comments, n. 2, 2001.
- [293] UK, UK_nutrition_layers free range_1, 2010.
- [294] UK, UK_nutrition_layers rearers_1, 2010.
- [295] UK, UK_nutrition_broilers_2, 2010.
- [296] UK, UK_nutrition_broilers_3, 2010.
- [297] UK, UK_nutrition_cage layers_1, 2010.
- [298] UK, UK_nutrition_replacement layers_1, 2010.
- [299] UK, UK_nutrition_turkeys_3, 2010.
- [300] BE Flanders, Belgium Flanders_input pigs_update 100302, 2010.
- [301] Fefana, FEF_Nutrition_Probiotics_Pigs_Davis, 2010.
- [302] Fefana, FEF_Nutrition_Probiotics_Pigs-Maaroufi, 2010.
- [303] Fefana, FEF_Nutrition_Probiotics_Broilers_Angel-Lactob-Exp1, 2010.
- [304] Fefana, FEF_Nutrition_Enzymes_Pigs_Nielsen, 2010.
- [305] Fefana, FEF_Nutrition_Enzymes_Pigs_Nielsen, 2010.
- [306] Fefana, FEF_Nutrition_Probiotics_Broilers_Tarun, 2010.
- [307] Fefana, FEF_Nutrition_Probiotics_Turkeys_Grimes, 2010.
- [308] UK, UK_nutrition_weaners_1, 2010.
- [309] UK, UK_nutrition_sows_1, 2010.

References

- [310] UK, UK_nutrition_pigs_1, 2010.
- [311] UK, UK_nutrition_pigs_2, 2010.
- [312] Fefana, FEF_Nutrition_AminoAcids_Reduction CP_Broiler_Ferguson, 2010.
- [313] Fefana, FEF_Nutrition_AminoAcids_ReductionCP_Turkey_Applegate, 2010.
- [314] Fefana, FEF_Nutrition_AminoAcids_ReductionCP_Pigs_FullySlattedFloor, 2010.
- [315] Fefana, FEF_Nutrition_AminoAcids_ReductionCP_Pigs_LatimierDourmad, 2010.
- [316] Fefana, FEF_Nutrition_AminoAcids_ReductionCP_Layers_Hsu, 2010.
- [317] Fefana, FEF_Nutrition_AminoAcids_BiphaseFeeding_Pigs_FullySlattedFloor, 2010.
- [318] Fefana, FEF_Nutrition_AminoAcids_BiphaseFeeding_Pigs_Straw, 2010.
- [319] Fefana, FEF_Nutrition_AminoAcids_BiphaseFeeding_Pigs_LatimierDourmad, 2010.
- [320] Fefana, FEF_Nutrition_AminoAcids_PhasesFeeding_Pigs_BEthesis1, 2010.
- [321] Fefana, FEF_Nutrition_AminoAcids_PhasesFeeding_Pigs_BEthesis2, 2010.
- [322] Fefana, FEF_Nutrition_AminoAcids_PhasesFeeding_Pigs_BEthesis3, 2010.
- [323] Finland, FI N and P excretion values per animal per yr, 2010.
- [324] Netherlands, Protein effect_A, 2010.
- [325] CRPA, N-low-feed-pigs, 2009.
- [326] Germany, 5 templates on nutrition pigs, 2010.
- [327] Germany, 7 templates on nutrition poultry, 2010.
- [328] CORPEN, Estimation des rejets d'azote, phosphore, potassium, calcium, cuivre et zinc par les élevages avicole, 2006, p. 55.
- [329] CORPEN, Estimation des rejets d'azote - phosphore - potassium - cuivre et zinc des porcs. Influence de la conduite alimentaire et du mode de logement des animaux sur la nature et la gestion des déjections produites, 2003.
- [330] Denmark, DK_nutrition_Pig_protein, 2010.
- [331] Raumberg, Effects of phytogenic feed additives used during pig fattening periods on the reduction of noxious and carrier gases (AT_feed additives_Endbericht Aromex_710303_English (2).), 2010.
- [332] Delacon, DELACON_nutrition_broiler_1, 2010.
- [333] Delacon, DELACON_nutrition_broiler_2, 2010.
- [334] Lipinsky K., Efficiency of Biostrong 510 in broiler chicken nutrition, 2008.
- [335] Spain, ES_nutrition_fatteningpigs_1, 2010.
- [336] UK, Tried & Tested Nutrient Management Plan, 2010.
- [337] Webb et al., 'Webb, menzi et al, Managing ammonia from livestock production', Environmental Pollution, Vol. 135 (2005) 399-406, 2005.
- [338] Piñeiro et al., Calculation of unit cost for techniques for the reduction of ammonia emissions from livestock production, Spanish Ministry of the Environment and Rural and Marine Affairs, 2009.
- [339] ITAVI, 'ITAVI_CNEVA_1997_Maitrise de l'ambiance dans le batiments avicoles', 1997.
- [340] ADEME, Utilisation rationnelle de l'énergie dans les batiments d'élevage, 2007.
- [341] Amand et al., 'Evaluation des consommations d'énergies en élevage de volailles de chair', 2007.
- [342] ADEME, Les consommations d'énergie dans les bâtiments avicoles, 2008.

- [343] ADEME, 'Les consommations énergétiques dans les bâtiments porcins', 2008.
- [344] ADEME, 'Consommations d'énergie des bâtiments porcins: comment les réduire ?', 2008.
- [345] France, French proposition concerning energy- chapter 2, 2010.
- [346] CA Bretagne, CA Bretagne 2009 Utilisation d'une chaudiere biomasse, 2009.
- [347] Bartolomeu, 'Echangeurs thermiques', 2007.
- [348] Bartolomeu, 'Pompes à chaleur', 2008.
- [349] ITAVI, 'La gestion technique des bâtiments avicoles', 1998.
- [350] France, French proposition concerning energy- chapter 4, 2010.
- [351] Marcon M., 'Maîtrise de l'énergie dans la ventilation et le chauffage des bâtiments porcins', TechniPorc, 2009.
- [352] Bartolomeu, 'Echangeur thermique air-sol', 2005.
- [353] CA Pays Loire, 'CRA Pays de la Loire_2009_Recupération de chaleur en aviculture ', 2009.
- [354] ITAVI, 'La prévention coup de chaleur en aviculture', 2004.
- [355] Warwick, Energy saving by the application of improved ventilation technology (Report AC0401), 2007.
- [356] Carbon Trust, Energy Use in Pig Farming (ECG089), 2005.
- [357] France, French proposition concerning water- chapter 2, 2010.
- [358] France, French proposition concerning water- chapter 3, 2010.
- [359] Massabie P, 'L'abreuvement des porcs ', 2001.
- [360] Boulestreau, 'Effet de la brumisation en engraissement en periode estivale', 2006.
- [361] France, French proposition concerning water- chapter 4, 2010.
- [362] UK, Thornton Poultry Sheds Glenrothes, site plan, 2010.
- [363] EHS, Guidance for Treating Lightly Contaminated Surface Run-off from Pig and Poultry Units, 2006.
- [364] Portugal, Discharge of treated slurry to watercourses, 2010.
- [365] France, French proposition concerning poultry housing - chapter 2, 2010.
- [366] Renault et al, 'Etude de la qualité de l'air en élevages avicoles', 1997.
- [367] Michel et al., 'Bien-etre de poules pondeuses logees en cage ou en voliere', 2005.
- [368] France, French proposition concerning poultry housing - chapter 4, 2010.
- [369] Harter-Dennis, Summary of Research UMES/AviHome Flooring System, University of Maryland Eastern Shore, 2010.
- [370] Franck et al., 'Evaluation d'un dispositif de deodorisation du lisier de canard. Incidence du mode de la alimentation de la cuve de traitement', 2003.
- [371] Penaud et al., 'Compostage sans retournement d'un melange litières de poulettes repro en presence de l'inoculum bacterien Bactivor', Septieme Journees de la Recherche Avicole, 2007.
- [372] Spain, Schematic representation of feed, water and heat distribution by a biomass burner in a broiler house, 2013.
- [373] UBA Austria, Cross-media environmental control in selected regions. Hirnsdorf, Umweltbundesamt, 2009.
- [374] Denmark, Appendix_DK_aircleaning_broilers_chemical, 2010.

References

- [375] Philippe et al., 'Emissions d'ammoniac lors de l'engraissement de porcs sur caillebotis, litière de paille accumulée et litière à pente paillée. Journées de la Recherche porcine en France, 2007, 6 – 8 février 2007, 39, 61-62.', 2007.
- [376] Ferreira et al., The importance of having an integrated vision of livestock housing and water management - new challenges for environmental management in the pig sector, 2010.
- [377] Netherlands, Internal side of poultry shed roof without and with use of ionisation, 2010.
- [378] Robin et al., 'Emissions d'ammoniac et de protoxyde d'azote des porcs engraisés sur litière de paille', Journées Recherche Porcine, 2004.
- [379] Spain, Implantación de la Directiva IPPC en España. Evaluación Técnica y Económica de MTDs en granjas, 2009.
- [380] Delacon, Cost calculation_Delacon, 2011.
- [381] Delacon, Report on BSG in EU 2010, 2011.
- [382] BPEX, 2014 Pig cost of production in selected countries, 2016.
- [383] France, French proposition on BREF Chapter 1, 2010.
- [384] Fefana, Brumisation, 2011.
- [386] DEFRA, Code of Good Agricultural Practice: Protecting our water, soil and air, 2009.
- [388] BPEX, Bedding options for the English pig industry, 2011.
- [389] ADAS, Managing Livestock Manures. Booklet 1. Making better use of livestock manures on arable land, 2001.
- [390] ADAS, Managing Livestock Manures. Booklet 3. Spreading systems for slurries and solid manures, 2001.
- [391] Italy, Italian contribution to 2003 IRPP BREF, 1999.
- [392] LEI Wageningen, Competitiveness of the EU egg industry.pdf, 2012, p. 47.
- [393] ADAS, ADAS guidance of control of noise in poultry units, 1999.
- [394] Smith et al., 'Nitrogen excretion by farm livestock with respect to land spreading requirements and controlling nitrogen losses to ground and surface waters. Part 2: pigs and poultry', Bioresource Technology, Vol. 71 (2000) 183±194, 2000.
- [395] ADAS, Guidance on energy control in pig units, 1999.
- [396] LEI, Managing nitrogen pollution from intensive livestock production in the EU, 1999.
- [397] Denmark, Danish BAT notes on pig farming for 2003 BREF, 2000.
- [398] Finland, Biological treatment in a series of continuously aerated tank reactor, 2013.
- [399] ID Lelystad, De forfataire excretie van stikstof door landbouwhuisdieren, 2000.
- [400] Silsoe Inst., 'Concentrations and emission rates of aerial ammonia, nitrous oxide, methane, carbon dioxide, dust and endotoxin in UK broiler and layer houses', British Poultry Science, Vol. 38(1):14-28, 1997.
- [401] Finland, Enhanced solid separation, efficient biological aeration treatment and ammonia stripping, 2013.
- [402] ADAS, Guidance on farm waste structures, 2000.
- [403] EA, Towards sustainable agricultural waste management, EA, 2001.
- [404] Tank manufacturer, Soluciones mundiales para depósitos, 2000.
- [405] Tengman C.L. et al., Odor solution initiative testing, 2001.
- [406] Netherlands, Dutch remarks on landspreading, 2002.

- [407] Netherlands, ILF 206 Netherlands Drinker systems, 2002.
- [408] UK, ILF 220 UK Slurry spreading, 2002.
- [409] VITO, Beste beschikbare technieken voor het be- en verwerken van dierlijke mest, 1997.
- [410] Greece, ILF 145 Comments Greece to first draft, 2001.
- [411] Ireland, ILF 137 Comments Ireland to first draft, 2001.
- [412] Italy, ILF 127 Comments Italy to first draft, 2001.
- [413] Portugal, ILF 130 Comments Portugal to first draft, 2001.
- [414] Fefana, ILF 108 FEFANA Amino Acid Working Party Input to the BREF Document (Comment to 1st Draft of BREF document), 2001.
- [415] BPEX, 2009 Pig cost of production in selected countries, BPEX, 2010.
- [416] COM, Evaluation of the livestock sector's contribution to the EU greenhouse gas emission (GGELS), 2010.
- [417] ITAVI, Document de synthese: Resultats 2011 des enquêtes poulettes et pondeuses, 2012.
- [418] ITAVI, Performances techniques et couts de production en volailles de chair, poulettes et poules pondeuses, ITAVI, 2010.
- [419] Red Tractor, Pig Standards, 2011.
- [420] Ramonet, 'L'élevage des porcs sur litière. Une diversité de systèmes en engraissement', Journées Recherche Porcine, Vol. 35, 2003, pp. 1-6.
- [421] Netherlands, Ventilation rates in pig housing (Klimaatplatform varkenshouderij), 2011.
- [422] Taylor N., Lighting for Pig Units, BPEX, 2010.
- [423] Gill P., Comparison of water use from different drinker types by weaned, growing and finishing pigs, 1989.
- [424] VERA, Test Protocol for Air Cleaning Technologies, VERA (Verification of Environmental Technologies for Agricultural Production), 2010.
- [425] DEFRA, Fertiliser Manual (RB209) 8th Edition, TSO, 2010.
- [427] COM, Report from the Commission to the Council and the European Parliament on implementation of Council Directive 91/676/EEC. Reports for the period 2004-2007 (COM(2010)47), European Commission, 2010.
- [428] GEC, Assessment on Peatlands, Biodiversity and Climate change, 2008.
- [429] Texier et al., 'Production et composition des fumiers de porcs engraisés sur sciure, copeaux ou écorce', TechniPorc, Vol. 27, 2004, pp. 29-37.
- [430] Paulicks et al., 'Studies on the tryptophan requirement of lactating sows. Part 1: Estimation of the tryptophan requirement by performance', Journal of Animal Physiology and Animal Nutrition, Vol. 90, 2006, pp. 474-481.
- [431] MARM, Guía de Mejores Técnicas Disponibles del sector porcino, 2010.
- [432] BPEX, Commercial Pig Unit Electricity Monitoring Project loc, 2010.
- [433] CORPEN, Les émissions d'ammoniac et de gaz azotés à effet de serre en agriculture, CORPEN, 2006.
- [434] ITAVI, 'Aviculture et respect de l'environnement', Sciences et Techniques Avicoles, hors série, 2001.
- [435] Van Gansbeke et al., Groepshuisvesting van zeugen, 2011.
- [436] Guingand N., 'Emission d'ammoniac liée au stockage de lisier de porcs: résultats de laboratoire et de terrain', Journées de la Recherche Porcine, Vol. 34, 2002, pp. 161-166.

References

- [437] Agrsci, Normtal baggrundstal, 2008.
- [438] Lacey et al., 'A Review of Literature Concerning Odors, Ammonia, and Dust from Broiler Production Facilities: 1. Odor Concentrations and Emissions', *The Journal of Applied Poultry Research*, Vol. 13, 2004, pp. 500-508.
- [439] Sommer et al., Algorithms Determining Ammonia Emission From Buildings Housing Cattle And Pigs And From Manure Stores, *Advances in Agronomy*, 2006, pp. 261-335.
- [440] Webb et al., The impacts of manure application methods on emissions of ammonia, nitrous oxide and on crop response—A review, *Agriculture, Ecosystems and Environment*, 2010, pp. 39-46.
- [441] Webb et al., Gaseous emissions during the management of solid manures. A review, in press, 2012.
- [442] Hansen et al., Emissionsfaktorer til beregning af ammoniakfordampning ved lagring og udbringning af husdyrgødning, AgroTech, Institut for Jordbrugs- og Fødevareinnovation, 2008.
- [443] Chadwick et al., 'Manure management: implications for greenhouse gas emissions', publication in progress, Vol. publication in progress, 2011.
- [444] Haeussermann et al., 'Influence of season, ventilation strategy, and slurry removal on methane emissions from pig houses', *Agriculture, Ecosystems and Environment*, Vol. 112, 2006, pp. 115-121.
- [445] VERA, Test Protocol for Livestock Housing and Management Systems - version 2-2011-29-08, 2011.
- [446] Bouvarel et al., 'Alimentation sequentielle et maitrise de l'ingestion chez le poulet de chair effets des teneurs energetiques et proteiques des aliments', Septièmes Journées de la Recherche Avicole, Tours, 28 et 29 mars 2007.
- [447] Finland, Mechanical separation enhanced by chemical flocculation, 2013.
- [448] Aarnink et al., 'Nutrition, key factor to reduce environmental load from pig production', *Livestock Science*, Vol. 109, 2007, pp. 194-203.
- [449] Edwards et al., PigSafe project UK, 2012.
- [450] IFIP, 'Note de conjoncture Aliment', Note de conjoncture Aliment, Mensuel d'information, 2011.
- [451] Portejoie et al., 'Effet de la réduction du taux protéique de l'aliment sur la volatilisation ammoniacale des effluents porcins', *Journées de la Recherche Porcine*, Vol. 34, 2002, pp. 167-174.
- [452] Fefana, FEFANA WP Enzymes proposal for the part Phytase (Chapter 4 of BREF document draft 2, on the intensive farming of poultry and pigs), 2002.
- [453] DEFRA, LK0973 project page, 2011.
- [454] Eriksen et al., 'Emissions of sulfur-containing odorants, ammonia, and methane from pig slurry: effects of dietary methionine and benzoic acid.', *Journal of Environmental Quality*, Vol. 39, 2010, pp. 97-107.
- [455] Männer, Efficacy of Fresta F and Fresta F Plus on performance in sows from day 90 of gestation to day 25 day postpartum, Institut of Animal Nutrition, Faculty of Veterinary Medicine, Free University Berlin, 2011.
- [456] Delacon, Cost calculation for Fresta® F Plus, 2011.
- [457] Delacon, Market report in selected markets 2010, 2011.
- [458] Veit et al., Effects of phytogenic feed additives containing *Quillaja saponaria* on ammonia in fattening pigs, Delacon, Agricultural Research and Education Centre Raumberg-Gumpenstein, 2011.

- [459] Overults et al., How much attic insulation?, 2008.
- [460] COM, Report from the Commission to the Council and the European Parliament on implementation of Council Directive 91/676/EEC. Reports for the period 2008-2011 (COM(2013) 683 final), 2013.
- [461] Glo, A new Energy Efficient Era for Global Farming, 2010.
- [462] VITO, Beste Beschikbare Technieken (BBT) voor de veeteeltsector, 2005.
- [463] Wageningen UR, Aanpakken bij de bron! Netwerk 'stof tot nadenken', 2010.
- [464] Netherlands, RAV E5.11 / BWL2010.13.V1. Heat exchanger with ventilators, 2010.
- [465] Netherlands, Picture E5.11 heat exchanger with ventilators, 2011.
- [466] Bonnouvrier et al., 'Alternative energy on poultry farms: study of a heat recovery system', EUROPEAN FORUM, Livestock housing for the future, Vol. 978-2-84148-772-1, 2009, Lille.
- [467] BE Flanders, Belgium Flanders_input poultry_update 100302, 2010.
- [468] CBS, Huisvesting van landbouwhuisdieren 2008, Centraal Bureau voor de Statistiek, 2011.
- [469] Netherlands, Stal met mixluchtventilatie, 2011.
- [470] Netherlands, RAV E5.10 / BWL 2009.14, 2011.
- [471] Netherlands, BWL 2009.14.V2, Stal met verwarmingssysteem met (indirect gestookte) warmteheaters en ventilatoren, 2011.
- [472] Fefana, 'Probiotic Market data', Personal Communication, 2011.
- [473] Infomil, Sample of the list of housing descriptions leaflet for category E 5, 2011.
- [474] VDI, VDI 3894 B1/Part 1 September 2011 Emissionen und Immissionen aus Tierhaltungsanlagen. Emissions and immissions from animal husbandries Housing systems and emissions: Pigs, cattle, poultry, horses, 2011.
- [475] Merlet et al., 'Evaluation de l'Impact Carbone en production de canards à rôtir: une approche de terrain des systèmes d'élevage sur caillebotis et sur litière', TeMA, Vol. 13, 2010, pp. 31-38.
- [476] AEAT, Atmospheric Emissions From Small Carcass Incinerators, 2002.
- [477] O'Dea et al., 'Investigating the Effects of Commercial Probiotics on Broiler Chick Quality and Production Efficiency', Poultry Science, Vol. 85, 2006, p. 1855:1863.
- [478] Sieo et al., 'Influence of β -Glucanase-Producing Lactobacillus Strains on Intestinal Characteristics and Feed Passage Rate of Broiler Chickens', Poultry Science, Vol. 84, 2005, p. 734:741.
- [479] Bedford et al., Enzyme in Farm Animal Nutrition, 2nd edition, CABI, 2011.
- [480] Yu et al., 'Effects of enzyme inclusion in a maize–soybean diet on broiler performance', Animal Feed Science and Technology, Vol. 134, 2007, p. 283–294.
- [481] Thacker, 'Fed Wheat or Corn Based Diets Supplemented With Xylanase or Protease Alone or in Combination', Journal of Animal and Veterinary Advances, Vol. 4, 2, 2005, pp. 276-281.
- [482] Cowieson et al., 'Carbohydrases, Protease, and Phytase Have an Additive Beneficial Effect in Nutritionally Marginal Diets for Broiler Chicks', Poultry Science, Vol. 84, 2005, p. 1860–1867.
- [483] Cowieson et al., Interactions between xylanase and glucanase in maize-soy-based diets for broilers, British Poultry Science, 2010, pp. 246-257.

References

- [484] Windisch et al., Use of phytogetic products as feed additives for swine and poultry, *Journal of Animal Science*, 2008, pp. E140-E148.
- [485] Gutierrez del Alamo et al., 'Effect of Wheat Cultivar and Enzyme Addition to Broiler Chicken Diets on Nutrient Digestibility, Performance, and Apparent Metabolizable Energy Content', *Poultry Science*, Vol. 87, 2008, pp. 759-767.
- [486] Pelletier et al., Gas and odor emissions from swine building materials, *Transactions of the ASABE*, 2005, pp. 721-728.
- [487] Aarnink et al., 'Effect of Type of Slatted Floor and Degree of Fouling of Solid Floor on Ammonia Emission Rates from Fattening Piggeries', *J. agric. Engng Res*, Vol. 66, 1997, p. 93 – 102.
- [488] Pedersen et al., Characteristics of Floors for Pig Pens: Friction, shock absorption, ammonia emission and heat conduction, *Agricultural Engineering International*, 2008.
- [489] Pedersen et al., 'A New Design For Highly Efficient Partial Pit Ventilation', XVIIth World Congress of the International Commission of Agricultural Engineering (CIGR), 2010, Québec City, Canada.
- [490] Pedersen et al., *Perstrup Pig House With Partial Under-Floor Air Evacuation And In-House Separation Of Faeces And Urine*, 2011.
- [491] Guingand N., 'Influence de la vidange des préfosse sur l'émission d'ammoniac et d'odeurs par les porcheries d'engraissement. Résultats préliminaires', *Journées Rech. Porcine en France*, Vol. 32, 2000, pp. 83-88.
- [492] COM, Report on animal by-products, European Commission Directorate General Health & Consumer Protection, 2005.
- [493] Guingand et al., 'Emissions comparées d'ammoniac et de gaz à effet de serre par des porcs charcutiers élevés au froid sur caillebotis partiel ou à la thermoneutralité sur caillebotis intégral', *Journées Recherche Porcine*, Vol. 42, 2010, pp. 277-283.
- [494] EFSA, Animal health and welfare aspects of different housing and husbandry systems for adult breeding boars, pregnant, farrowing sows and unweaned piglets, European Food Safety Authority (EFSA), 2007.
- [495] EFSA, The risks associated with tail biting in pigs and possible means to reduce the need for tail docking considering the different housing and husbandry systems, European Food Safety Authority, 2007.
- [496] Sharpe et al., 'Methane emissions from an anaerobic swine lagoon', *Atmospheric Environment*, Vol. 33, 1999, pp. 3627-3633.
- [497] BE Flanders, Flemish list of housing systems, 2010.
- [498] Černák, *Overflow Slurry Channels*, 1977.
- [499] AgroTech, Forarbejde til Teknologiuudvalget - Preliminary work for the Technology Committee. Miljøprojekt Nr. 1246 2008, 2008.
- [500] IRPP TWG, Comments to Draft 1 revised BREF, 2011.
- [501] Aubert et al., 'Utilisation d'un complexe de microorganismes pour reduire les emissions d'ammoniac en elevage de poulets', *Neuvièmes Journées de la Recherche Avicole*, 2011, Tours.
- [502] Guinebert et al., 'Interet d'un traitement biologique des litières de volailles par apport d'un additif microbien en presence des animaux', *Sixièmes journées de la Recherche Avicole*, 2005, Saint Malo.
- [503] Vermeij, Costs available measures to reduce fine dust (Informatiebijeenkomst fijn stof), 2011.
- [504] KTBL, Abluftreinigung in der Schweinehaltung - Verfahren, Einsatzbereiche, Leistungen und Kosten, 2010.

- [505] Hahne J., 'Development of exhaust air treatment in animal husbandry in Germany', *Landtechnik*, Vol. 66, 2011, pp. 289-292.
- [506] TWG ILF BREF, Complete Comments to 2003 ILF BREF Draft 2 (Excel spreadsheet with all comments on draft 2), 2001.
- [507] COM, Best Available Techniques (BAT) Reference Document for Common Waste Water and Waste Gas Treatment/Management Systems in the Chemical Sector (CWW BREF), European Commission - JRC IPTS EIPPCB, 2016.
- [508] TFRN, Options for Ammonia Mitigation - Guidance from the UNECE Task Force on Reactive Nitrogen, 2014.
- [509] Province Antwerpen, Invloed va klimaat op de groei van vleeskuikens. Studienamiddagen Pluimveehouderij, 1999.
- [510] EFSA, Animal health and welfare in fattening pigs in relation to housing and husbandry, 2007.
- [511] Le et al., 'Effects of dietary crude protein level on odour from pig manure', *Animal*, Vol. 2007, No 1, 2007, pp. 734-744.
- [512] Andree et al., 'The Effect of Protein Supply on Odour Emission from Fattening Pigs', *Landtechnik*, Vol. 58, 2003, pp. 38-39.
- [513] Mol and Ogink, Geuremissies uit de veehouderij II, Wageningen UR, 2002.
- [514] KTBL, Exhaust air treatment systems for animal housing facilities, KTBL, 2008, p. KTBL publication 464.
- [515] UR Wageningen, Maatregelen ter vermindering van fijnstofemissie uit de pluimveehouderij: indicatieve evaluatie van biofiltratie als potentiële fijnstofreductietechniek, Wageningen UR Livestock Research, 2010.
- [516] TÜV, Bericht Über Die Zertifizierung der Biofilteranlage der Firma Hartmann Biofilter für den Anwendungsfall der ma Hartmann Biofilter für Den Anwendungsfall der Schweinehaltung hinsichtlich der Abscheidewirkung ge- Schweinehaltung hinsichtlich der Abscheidewirkung gegenüber Staub, Geruch, Ammoniak und Keime gegenüber Staub, Geruch, Ammoniak und Keime, TÜV RHEINLAND, 2009.
- [517] Petersen et al., 'Ammonia and nitrous oxide interactions: Roles of manure organic matter management', *Animal Feed Science and Technology*, Vol. 166-167, 2011, pp. 503-513.
- [518] Sommer et al., 'Greenhouse Gas Emission from Stored Livestock Slurry', *Journal of Environmental Quality*, Vol. 29, 1999, pp. 744-751.
- [519] Amon et al., 'Amon Kryvorutchko fulltext', Vol. 112, 2007, pp. 199-207.
- [520] Fleming R., Liquid Manure Storage Covers, 2006.
- [521] Portejoie et al., 'Effect of covering pig slurry stores on the ammonia emission processes', Vol. 87, 2003, pp. 199-207.
- [522] Loyon et al., 'Réduction des émissions d'ammoniac au cours du stockage du lisier porcin: Evaluation grandeur réelle d'une couverture de balles en polystyrène', Vol. 39, 2007, pp. 49-54.
- [523] Leip et al., 'Impacts of European livestock production: nitrogen, sulphur, phosphorus and greenhouse gas emissions, land-use, water eutrophication and biodiversity', 2015.
- [524] UK EA, How to comply with your environmental permit for intensive farming. Appendix 9-Producing a proposal for covering slurry stores, 2012.
- [525] BPEX, Covering slurry stores. Benefits, Practicalities and Available Options, 2011.
- [526] Hansen et al., 'Observations of production and emission of greenhouse gases and ammonia during storage of solids separated from pig slurry: Effects of covering', Vol. 40, 2006, p. 4172-4181.

References

- [527] Hamelin et al., Life Cycle Assessment of Biogas from Separated slurry, 2010.
- [528] ITAVI, 'Sciences Et Techniques Avicoles, Hors série: Aviculture et respect de l'environnement', Vol. Hors série: Aviculture et respect de l'environnement, 2001, pp. 53-59.
- [529] Veneto Agricoltura, Nitrati da problema a risorsa. Stato dell'arte e opportunità dalle esperienze di progetto, 2012.
- [530] Nicks et al., 'Emissions d'ammoniac, de protoxyde d'azote, de méthane, de gaz carbonique et de vapeur d'eau lors de l'élevage de porcs charcutiers sur litière accumulées de paille et de sciure. Journées de la Recherche Porcine en France, 2003, 35, 4 – 6 février 2003, 7 – 14.', Vol. 35, 2003, pp. 7-14.
- [531] Ramonet et al., 'L'engraissement de porcs sur litière de particules de bois ou de sciure en couche fine', Vol. 34, 2002, pp. 143-148.
- [532] Nicks et al., 'Emissions d'ammoniac, de protoxyde d'azote, de méthane, de gaz carbonique et de vapeur d'eau lors de l'élevage de porcelets sevrés sur litière accumulée de paille et de sciure. Journées de la Recherche Porcine en France, 2002, 34, 5 – 7 février 2002, 149 – 154.', Vol. 34, 2002, pp. 149-154.
- [533] Baltic Sea 2020, Best Available Technologies for Pig Manure Biogas Plants in the Baltic Sea Region, 2011.
- [534] AFBI, AFBI Magowan PPDC-report-the-effect-of-drinker-design, 2007.
- [535] UK, Weaner on straw template, 2011.
- [536] Sagoo et al., 'Integrated management practices to minimise losses and maximise the crop nitrogen value of broiler litter', Vol. 97, 2007, pp. 512-519.
- [537] COM, ILF 191 EC. Storage vessels for manure storage (5), 1999.
- [538] Netherlands, ILF 138 Netherlands. Nitrogen and phosphorus consumption utilisation and losses in pig production, 1999.
- [539] MAFF, ILF 110 MAFF. Phase feeding pigs to reduce nutrient pollution - N in pig slurry., Scientific, 1999.
- [540] MAFF, "Phase feeding pigs to reduce nutrient pollution - ammonium-N emission from application", WA0317, 1999.
- [542] CEFIC, ILF 198. Highly digestible inorganic feed phosphates, 2002.
- [543] Fefana, ILF 199. Addition of specific feed additives. CEFIC, (2002). Highly digestible inorganic feed phosphates, 2002.
- [544] Netherlands, ILF 178. Additional information about Combideck system in broiler houses, 2002.
- [545] Netherlands, ILF 181. (additional) Comments on the 2nd draft ILF BREF, 2002.
- [546] TWG ILF, ILF 186 DK-NL. Manure surface cooling channel in combination with a closed heat exchanger, 2002.
- [547] IMAG-DLO, ILF 187. Nürtinger system, 2001.
- [548] TWG ILF, ILF 189 Italy-UK. Pens with straw bedded floor; natural ventilation, 2002.
- [549] IMAG-DLO, ILF 175. Environmental aspect of a group housing system for sows with feeding stations and straw, 1999.
- [550] IPCC, N₂O Emissions From Managed Soils, And CO₂ Emissions From Lime And Urea Application, 2006.
- [551] Oenema et al., 'Onema et al 2005, trends in global nitrous oxide emissions from animal production systems', Nutrient Cycling in Agroecosystems, Vol. 72, 2005, pp. 51-65.
- [552] IDELE, L'eclairage artificiel des batiments d' élevage de ruminants, 2012.

- [553] bhsl, Report to Board for Wimpstone Batch 4, 2011.
- [554] EPA (IE), ILF 001 and ILF 002 Batneec Guidance Note for the Pig Production Sector and for the Poultry production Sector, 1998.
- [555] MAFF, ILF 040 Guidelines for Farmers guide in NVZs, 1998.
- [556] ADAS, ILF 143 Silsoe, Low-cost covers to abate gaseous emissions from slurry stores, 2000.
- [557] MAFF, "Calculating the cost of best available techniques for the intensive rearing of poultry and pigs (draft)", 2000.
- [558] COM, ILF 195 Livestock manure Brochure, 1999.
- [559] ADAS, ILF 069 ADAS guidance of control of noise in pigs units, 1999.
- [560] IGER, ILF 202 IGER Treatment of livestock wastes through the use of additives, CSG 15 (rev. 1299), 2000.
- [561] Flotats et al., Guia de los tratamientos de las deyecciones ganaderas, Generalitat de Catalunya, 2004.
- [562] MARM, IMG_0974 band spreader, 2011.
- [563] MARM, IMG_0929.JPG, 2011.
- [564] bhsl, 12 07 10, Example Large UK Farm CL2E system (bhsl), 2012.
- [565] NFU, '12 07 13 to NFU fm bhsl re input for IPPC brief from BREF doc _5', Personal Communication, 2012.
- [566] EFSA, Scientific Opinion concerning a Multifactorial approach on the use of animal and non-animal-based measures to assess the welfare of pigs, 2014.
- [567] Nicks B., 'Caractéristiques techniques et aspects environnementaux de l'élevage de porcs charcutiers et de porcelets sevrés sur litières accumulées. Ann. Méd. Vét., 2004, 148, 31-38.', 2004.
- [568] Melse et al., 'Multi-pollutant scrubbers for removal of ammonia, odour and particulate matter from animal house exhaust air', 2010.
- [569] UR Wageningen, Report 215 Wageningen. Measures to reduce fine dust emission from poultry houses: reduction from broiler houses by ionization, 2009.
- [570] ALTERRA, Calculated losses of gaseous nitrogen compounds from livestock manure in stables and manure storage systems. Alterra Report 107, 2000.
- [571] Eurich-Menden et al., 'Ammonia emission factors within the agricultural emission inventory - Part 2: Poultry and fattening pigs', 2011.
- [572] Fefana, Questionnaire on Nutrition-Amino acids, 2010.
- [573] DSM et al., 'Economic and environmental benefits of Ronozyme ProAct', Personal Communication, 2012.
- [574] UBA Germany, Matrix parameters and storage conditions of manure, 2011.
- [575] UBA Germany, Systematic cost-benefit analysis of reduction measures for ammonia emissions in agriculture for national cost estimates, 2011.
- [576] COM, JRC Reference Report on Monitoring of Emissions to Air and Water from IED installations (ROM REF), European Commission, JRC IPTS EIPPCB, 2017.
- [577] IAF, International Accreditation Forum website, 2010.
- [578] DG Environment, What is Emas?, 2010.
- [579] EC, 'Regulation (EC) No 1221/2009 of the European Parliament and of the Council of 25 November 2009 on the voluntary participation by organisations in a Community eco-management and audit scheme (EMAS), repealing Regulation (EC) No 761/2001 and

References

- Commission Decisions 2001/681/EC and 2006/193/EC', Official Journal of the European Union, Vol. L 342, 22.12.2009, pp. 1-45.
- [580] CEN, EN ISO 14001:2015 Environmental management systems – Requirements with guidance for use, 2015.
- [581] COM, Best Available Techniques (BAT) Reference Document in the Slaughterhouses and Animal By-products Industries (SA BREF), 2005.
- [582] Wageningen NL, Measures to reduce fine dust emission from poultry: optimisation of an oil spraying system for broilers, 2009.
- [583] Netherlands, 'Illustration of floating balls', Personal Communication, 2010.
- [584] Netherlands, Floating balls and benzoic acid, 2010.
- [585] Netherlands, Broilers in multifloor system on tiers with manure belt, 2010.
- [586] Netherlands, Broilers housing with litter and forced ventilation, 2010.
- [587] Netherlands, Multifloor system on tiers for broilers, 2010.
- [588] LEI Wageningen, Competitiveness of the EU poultry meat sector, 2013.
- [589] Netherlands, Quantitative information on livestock in the Netherlands, 2010.
- [590] Batfarm, 'Reconciling livestock management to the environment -European workshop, proceeding and minutes of the meeting', 2013.
- [591] Denmark, DK Storage Natural Floating layer, 2009.
- [592] R.Burns, L.Moody, 'A review of permeable cover options for manure storage', 2007.
- [593] UBA Germany, 'Reduction of emissions from the storage of slurry', Personal Communication, 2013.
- [594] Agro Business Park, Manure processing technologies, 2011.
- [595] Agro Business Park, Inventory of manure processing activities in Europe, 2011.
- [596] Denmark, Separation of slurry with decanter centrifuge, 2009.
- [597] Loyon et al., 'Gaseous emissions (NH₃, N₂O, CH₄ and CO₂) from aerobic treatment of piggery slurry - Comparison with conventional storage system', 2007.
- [598] Denmark, Slurry acidification during field spreading, 2012.
- [599] Denmark, Slurry acidification in storage tank, 2012.
- [600] P.Kai et al., 'A whole farm assessment of the efficacy of slurry acidification in reducing ammonia emissions', 2008.
- [601] ALTERRA-IIASA, Emissions from agriculture and their control potentials, 2012.
- [602] Denmark, Application with trailing hoses, 2010.
- [603] Denmark, Application of slurry with injection system - winter crop, 2009.
- [604] Denmark, Application of slurry with injection system - bare soil, 2009.
- [605] E.Magowan, AFBI, Review of peer reviewed publications comparing ammonia emissions from deep and shallow pits under fully slatted floors in pig housing, 2010.
- [606] Z.Ye et al., 'Key factors driving ammonia emissions from a pig house', 2011.
- [607] COM, Assessment and Summary of the Member States' Implementation Reports for the IED, IPPC Directive, SED and WID, 2016.
- [608] Netherlands, Manure collection in water, 2010.
- [609] UR Wageningen, Kempfarm housing system for growing-finishing pigs: environmental emissions and investment costs, 2007.

- [610] Fefana, 'Calculator excretion ex animal', Personal Communication, 2012.
- [611] C.Rigolot et al., 'Modelling of manure production by pigs and NH₃, N₂O and CH₄ emissions. Part I: animal excretion and enteric CH₄, effect of feeding and performance', 2010.
- [612] TWG comments, Comment received by TWG members on the proposals for reference systems, 2012.
- [613] UR Wageningen, Standardised calculation methods for animal manure and nutrients, 2012.
- [614] UK, Inventory of ammonia emissions from UK Agriculture. 2012, 2013.
- [615] IE EPA, 'Emission factors used in national inventories', Personal Communication, 2012.
- [616] Spain, 'Comment on the proposal for reference systems', Personal Communication, 2012.
- [617] ITAVI, 'Calculation files for poultry', Personal Communication, 2012.
- [618] DAFC, DK, 'Reference emission factors', Personal Communication, 2013.
- [619] Baltic Sea 2020, Proposal for revision of Chapter 6 of the BREF, 2011.
- [620] Germany, Combined above floor_underfloor ventilation system with partial airflow treatment, 2013.
- [621] Alitalo et al, 'A new system exploiting soil microbes for aerobic biological treatment of swine manure: Theory and preliminary experiment', 2011.
- [622] Alitalo et al, 'Combined microbiological processing and ammonia stripping of liquid manure', 2011.
- [623] Germany, Near_Zero_Emission_Stall pig housing system, 2013.
- [624] IRPP TWG, Comments submitted for the Draft 2 of the revised Intensive Rearing of Poultry and Pigs (IRPP) Best Available Techniques (BAT) Reference Document (BREF), 2013.
- [625] BE Flanders, BelgiumFlanders_update regressions used in Flanders (Belgium) to calculate level of excretion, 2013.
- [626] Denmark, DK_aircleaner_biological_appendix, 2010.
- [627] EEA, EMEP/EEA air pollutant emission inventory guidebook 2013. Document 3.B Manure management, 2013.
- [628] Velthof, 'A model for inventory of ammonia emissions from agriculture in the Netherlands. Atmospheric Environment 46 (2012). - ISSN 1352-2310 - p. 248 - 255', 2012.
- [629] Denmark, Whole farm environmental assessment - Tool from Denmark, 2013.
- [630] VDI, VDI 4285 Part 2:2011 Determination of diffusive emissions by measurements - Industrial halls and livestock farming, 2011.
- [631] BE Flanders, Belgium Flanders_storage animal waste_Dutch version, 2013.
- [632] DAFC, Effect of Fresta® F Plus on ammonia emissions from finisher facilities, 2010.
- [633] ITAVI, Estimation des rejets d'azote - phosphore - potassium - calcium - cuivre - et zinc par les élevages avicoles. Mise à jour des références CORPEN-Volailles de 2006, 2013.
- [634] BE Flanders, Belgium Flanders_odour emissions pig housing systems, 2013.
- [635] Le Bouquin et al., 'Qualite de l'air et emissions gazeuses en fonction du type de logement des poules pondeuses', 2013.
- [636] Ramiran, Ramiran Glossary: Glossary of terms on livestock and manure management. Second edition, 2011.

References

- [637] BE Flanders, Ventilation rates (m³/h per animal) recommended in Belgium (Flanders), 2012.
- [638] BE Flanders, Updated Emission Factors from Belgium (Flanders), 2014.
- [639] IE EPA, Air pollutant emissions in Ireland 1990–2011 reported to the Secretariat of the UNECE Convention, 2014.
- [640] Netherlands, Dutch national emission factors for ammonia in pigs and poultry, 2013.
- [641] IRPP IWG, BREF Conclusions D2 Review January BE (Flanders), DE, ES, UK, NL and FR, 2014.
- [642] BE Flanders, Belgium Flanders_ emission levels housing fattening pigs, 2013.
- [643] Van Ransbeeck et al., 'Indoor concentrations and emission factors for pig fattening facilities', 2013.
- [644] Netherlands, Emission factors for PM₁₀ in the Netherlands, 2014.
- [645] Denmark, 'New Standards for Odour Emissions from Pig Facilities in Denmark', 2005.
- [646] COM, Mission report for the visit to different farms performing intensive rearing of poultry and pigs, European Commission, JRC IPTS EIPPCB, 2013.
- [647] Rousset et al., 'Seeding of selected complexes of microorganisms on litters during rearing to reduce ammonia emissions in broiler house', 2012.
- [648] DEFRA, An Inventory of Mitigation Methods and Guide to their Effects on Diffuse Water Pollution, Greenhouse Gas Emissions and Ammonia Emissions from Agriculture, 2011.
- [649] DAFC, Low-pressure oil ejecting system in a farrowing unit and a finisher unit, 1999.
- [650] Denmark, DK_nutrition_Pig_phos, 2010.
- [651] DAFC, Effect of benzoic acid addition in pig feed, 2010.
- [652] DAFC, Effect of benzoic acid addition in pig feed_2, 2012.
- [653] Denmark, Quantification of nitrogen and phosphorus in manure in the Danish normative system, 2014.
- [654] BPEX, Evaluation of phase feeding in two contrasting finishing systems (fully slatted versus straw based housing), 2004.
- [655] Takai et al., 'Concentrations and Emissions of Airborne Dust in Livestock Buildings in Northern Europe', 1998.
- [656] Ponchant et al., 'Estimation of levels of nitrogen volatilization in poultry barns from field measurements', 2012.
- [657] Bailey T., Deep injection paper UK, 2012.
- [658] Baltic Manure, Baltic Manure. Energy Potential of Manure in the Baltic Sea Region., 2013.
- [659] IPCC, 'IPCC Guidelines. Chapter 10: Emissions from Livestock and Manure Management', 2006.
- [660] France, French proposition concerning poultry housing- chapter 3, 2010.
- [661] Denmark, Economic assessment of techniques for the whole-farm - Tool from Denmark, 2013.
- [662] Philippe et al., 'Gaseous emissions during the fattening of pigs kept either on fully slatted floor or on straw flow. Animal, 2007, 1, 1515 - 1523', 2007.
- [663] Simongiovanni et al., 'Estimation of the tryptophan requirement in piglets by meta-analysis', 2012.

- [664] EFSA, Opinion of the Scientific Panel on Additives and Products or Substances used in Animal Feed on the safety and efficacy of VevoVital® (benzoic acid) as feed additive for pigs for fattening, 2007.
- [665] Riis, Test Farm Airclean. 3-filter bioscrubber tested with VERA protokol. Danish Pig Research Centre, 2012.
- [666] BE Flanders, Excretion levels from the Action programme nitrates directive 2011-2014 Flanders (region of Belgium), 2011.
- [667] Spain, Ammonia emission factors from Spanish PRTR, 2011.
- [668] IE EPA, Odour Impacts and Odour Emission Control Measures for Intensive Agriculture, 2001.
- [669] Italy, Proposal for modifying the Table 3.26 (Average annual consumption per type of pig farm and by type of energy source and operation), 2013.
- [670] Kiwan et al., 'Tracer gas technique, air velocity measurement and natural ventilation method for estimating ventilation rates through naturally ventilated barns', 2012.
- [671] Krause et al., 'How to describe animal welfare in stable design? In: Briese A, Clauß M, Hartung J, Springorum A C (eds) Proceedings of the 14th ISAH Congress; Vechta, Germany; Vol. 1. Brno: Tribun EU, pp 529-532', 2009.
- [672] Faz A., Pig slurry treatment using constructed wetlands, 2015.
- [673] DG AGRI, Agriculture in the European Union. Markets statistical information, 2014.
- [678] NSW DPI, 'Basic husbandry - the boar. Primefact 69, ISSN 1832-6668, Job number 6154', 2006.
- [697] EEA, European Union emission inventory report 1990–2014 under the UNECE Convention on Long-range Transboundary Air Pollution (LRTAP), 2016.
- [698] DG AGRI, EU Market Situation for Eggs, 2014.
- [699] Eurostat, Pig population - annual data, 2017.
- [700] EC, 'DIRECTIVE (EU) 2016/2284 OF THE EUROPEAN PARLIAMENT AND OF THE COUNCIL of 14 December 2016 on the reduction of national emissions of certain atmospheric pollutants, amending Directive 2003/35/EC and repealing Directive 2001/81/EC', 2016.
- [701] COM, A policy framework for climate and energy in the period from 2020 to 2030, 2014.
- [702] Whalen et al., 'Soil food web controls on nitrogen mineralization are influenced by agricultural practices in humid temperate climates', 2013.
- [703] COM, Best Available Techniques (BAT) Reference Document for Energy Efficiency (ENE BREF), European Commission, JRC IPTS EIPPCB, 2009.
- [704] MAFF, Code of Good Agricultural Practice for the Protection of Water, 1998.
- [705] COM, First Draft of Best Available Techniques (BAT) Reference Document for Waste Incineration (WI BREF), 2017.
- [706] EEA, Ammonia (NH₃) emissions. <http://www.eea.europa.eu/data-and-maps/indicators/eea-32-ammonia-nh3-emissions-1/assessment-4>, 2017.
- [707] Alterra, Integrated measures in agriculture to reduce ammonia emissions; final summary report, 2007.
- [708] EC, 'REGULATION (EU) 2016/429 OF THE EUROPEAN PARLIAMENT AND OF THE COUNCIL of 9 March 2016 on transmissible animal diseases and amending and repealing certain acts in the area of animal health ('Animal Health Law')', 2016.
- [709] The Poultry Site, Lighting for poultry housing. <http://www.thepoultrysite.com/articles/452/lighting-for-poultry-housing/>, 2017.

***Europe Direct is a service to help you find answers
to your questions about the European Union.***

Freephone number (*):

00 800 6 7 8 9 10 11

(*) The information given is free, as are most calls (though some operators, phone boxes or hotels may charge you).

More information on the European Union is available on the internet (<http://europa.eu>).

HOW TO OBTAIN EU PUBLICATIONS

Free publications:

- one copy:
via EU Bookshop (<http://bookshop.europa.eu>);
- more than one copy or posters/maps:
from the European Union's representations (http://ec.europa.eu/represent_en.htm);
from the delegations in non-EU countries (http://eeas.europa.eu/delegations/index_en.htm);
by contacting the Europe Direct service (http://europa.eu/europedirect/index_en.htm) or
calling 00 800 6 7 8 9 10 11 (freephone number from anywhere in the EU) (*).

(*) The information given is free, as are most calls (though some operators, phone boxes or hotels may charge you).

Priced publications:

- via EU Bookshop (<http://bookshop.europa.eu>).

JRC Mission

As the science and knowledge service of the European Commission, the Joint Research Centre's mission is to support EU policies with independent evidence throughout the whole policy cycle.



EU Science Hub
ec.europa.eu/jrc



@EU_ScienceHub



EU Science Hub - Joint Research Centre



Joint Research Centre



EU Science Hub

