



JRC REFERENCE REPORT

Best Available Techniques (BAT) Reference Document for Iron and Steel Production

Industrial Emissions Directive 2010/75/EU
(Integrated Pollution Prevention and Control)

Rainer Remus, Miguel A. Aguado Monsonet,
Serge Roudier, Luis Delgado Sancho

2013



Report EUR 25521 EN

European Commission
Joint Research Centre
Institute for prospective technological studies

Contact information

European IPPC Bureau
Address: Joint Research Centre, Edificio Expo c/ Inca Garcilaso, 3 E-41092 Seville, Spain
E-mail: JRC-IPTS-EIPPCB@ec.europa.eu
Tel.: +34 95 4488 284
Fax: +34 95 4488 426

<http://eippcb.jrc.ec.europa.eu>
<http://ipts.jrc.ec.europa.eu/>

This publication is a Reference Report by the Joint Research Centre of the European Commission.

Legal Notice

Under the Commission Decision of 12 December 2011 on the Re-use of Commission Documents ([2011/833/EU](#)), the present BREF document is subject to free re-use, except for parts covered by any third-party rights which may be present in the document (such as images, tables, data, written material, or similar, the rights to which need to be acquired separately from their respective rights-holders for further use). The European Commission is not liable for any consequence stemming from the re-use of this publication. Any re-use is subject to the acknowledgement of the source and non-distortion of the original meaning or message

Europe Direct is a service to help you find answers to your questions about the European Union
Freephone number (*): 00 800 6 7 8 9 10 11
(*): Certain mobile telephone operators do not allow access to 00 800 numbers or these calls may be billed.

A great deal of additional information on the European Union is available on the Internet.
It can be accessed through the Europa server <http://europa.eu/>.

JRC 69967

EUR 25521 EN

ISBN 978-92-79-26475-7 (pdf)
ISBN 978-92-79-26476-4 (print)

ISSN 1831-9424 (online)
ISSN 1018-5593 (print)

doi:10.2791/97469

Luxembourg: Publications Office of the European Union, 2013

© European Union, 2013

Reproduction is authorised provided the source is acknowledged.

Printed in Spain

Best Available Techniques (BAT)
Reference Document for
Iron and Steel Production
Industrial Emissions Directive 2010/75/EU
Integrated Pollution Prevention and Control

Authors:

Rainer Remus, Miguel A. Aguado Monsonet,
Serge Roudier, Luis Delgado Sancho

2013

EUR 25521 EN

Acknowledgements

This report was produced by the European Integrated Pollution Prevention and Control Bureau (EIPPCB) at the European Commission's Joint Research Centre – Institute for Prospective Technological Studies (IPTS) under the supervision of Serge Roudier (Head of the EIPPCB) and Luis Delgado (Head of the Sustainable Production and Consumption Unit).

The main EIPPCB authors of this BREF were Mr Rainer Remus. Mr Miguel Aguado-Monsonet started the work.

This project report was drawn up in the framework of the implementation of the Industrial Emissions Directive (2010/75/EU) and is the result of the exchange of information provided for in Article 13 of the Directive for Iron and Steel Production.

Major contributors in the information exchange were:

- the following EU Member States: Austria, Belgium, the Czech Republic, Denmark, Finland, France, Germany, Italy, Luxembourg, the Netherlands, Poland, Sweden, the United Kingdom
- Norway
- Eurofer, the industry association representing the majority of European steel manufacturers
- Ökopol, representing the environmental NGOs.

Furthermore, information was provided by some equipment suppliers from Germany, Italy and Switzerland.

The whole EIPPCB team provided contributions and peer-reviewing.

This document is one from the series of foreseen documents listed below (at the time of writing not all of the documents have been drafted):

Best Available Techniques Reference Document . . .	Code
Ceramic Manufacturing Industry	CER
Common Waste Water and Waste Gas Treatment/Management Systems in the Chemical Sector	CWW
Emissions from Storage	EFS
Energy Efficiency	ENE
Ferrous Metals Processing Industry	FMP
Food, Drink and Milk Industries	FDM
Industrial Cooling Systems	ICS
Intensive Rearing of Poultry and Pigs	IRPP
<i>Iron and Steel Production</i>	<i>IS</i>
Large Combustion Plants	LCP
Large Volume Inorganic Chemicals – Ammonia, Acids and Fertilisers Industries	LVIC-AAF
Large Volume Inorganic Chemicals – Solids and Others industry	LVIC-S
Large Volume Organic Chemical Industry	LVOC
Management of Tailings and Waste-rock in Mining Activities	MTWR
Manufacture of Glass	GLS
Manufacture of Organic Fine Chemicals	OFC
Non-ferrous Metals Industries	NFM
Production of Cement, Lime and Magnesium Oxide	CLM
Production of Chlor-alkali	CAK
Production of Polymers	POL
Production of Speciality Inorganic Chemicals	SIC
Pulp and Paper Industry	PP
Refining of Mineral Oil and Gas	REF
Slaughterhouses and Animals By-products Industries	SA
Smitheries and Foundries Industry	SF
Surface Treatment of Metals and Plastics	STM
Surface Treatment Using Organic Solvents	STS
Tanning of Hides and Skins	TAN
Textiles Industry	TXT
Waste Incineration	WI
Waste Treatments Industries	WT
Wood and Wood Products Preservation with Chemicals	WPC
Wood-based Panels Production	WBP
Reference Document . . .	
Economics and Cross-media Effects	ECM
General Principles of Monitoring	MON

Electronic versions of draft and finalised documents are publicly available and can be downloaded from <http://eippcb.jrc.ec.europa.eu/>.

PREFACE

1. Status of this document

Unless otherwise stated, references to ‘the Directive’ in this document refer to Directive 2010/75/EU of the European Parliament and the Council on industrial emissions (integrated pollution prevention and control) (Recast).

The original best available techniques (BAT) reference document (BREF) on Iron and Steel Production was adopted by the European Commission in 2001. The review commenced in November 2005.

This BAT reference document for the Iron and Steel Production forms part of a series presenting the results of an exchange of information between EU Member States, the industries concerned, non-governmental organisations promoting environmental protection and the Commission, to draw up, review, and where necessary, update BAT reference documents as required by Article 13(1) of the Directive. This document is published by the European Commission pursuant to Article 13(6) of the Directive.

As set out in Article 13(5) of the Directive, the Commission Implementing Decision (2012/135/EU) on the BAT conclusions contained in Chapter 9 was adopted on 28 February 2012 and published on 8 March 2012 ⁽¹⁾.

2. Participants in the information exchange

As required in Article 13(3) of the Directive, the Commission has established a forum to promote the exchange of information, which is composed of representatives from Member States, the industries concerned and non-governmental organisations promoting environmental protection (Commission Decision of 16 May 2011 establishing a forum for the exchange of information pursuant to Article 13 of the Directive 2010/75/EU on industrial emissions (2011/C 146/03), OJ C 146, 17.05.2011, p. 3).

Forum members have nominated technical experts constituting the technical working group (TWG) that was the main source of information for drafting this document. The work of the TWG was led by the European IPPC Bureau (of the Commission's Joint Research Centre).

3. Structure and contents of this document

This section describes the type of information that is provided in each chapter of the document.

Chapter 1 provides general information on the iron and steel sector.

Chapter 2 provides information and data on general industrial processes and techniques used within this sector. These are horizontal matters or specific activities that do not relate to one specific iron and steel activity.

Chapters 3 to 8 provide the following information given below on particular iron and steel processes (sinter plants, pelletisation, coke ovens, blast furnaces, basic oxygen steelmaking and casting, electric arc steelmaking and casting). X can be replaced by the corresponding chapter number 3 to 8.:

Section X.1 Information on applied processes and techniques

Section X.2 Provides data and information concerning the environmental performance of installations within the sector, and in operation at the time of writing, in terms of

⁽¹⁾ OJ L 70, 8.3.2012, p. 63

current emissions, consumption and nature of raw materials, water consumption, use of energy and the generation of waste.

Section X.3 Describes in more detail the techniques to prevent or, where this is not practicable, to reduce the environmental impact of operating installations in this sector that were considered in determining the BAT. This information includes, where relevant, the environmental performance levels (e.g. emission and consumption levels) which can be achieved by using the techniques, the associated monitoring, the costs and the cross-media issues associated with the techniques.

Chapter 9 presents the best available techniques (BAT) conclusions as defined in Article 3(12) of the Directive.

Chapter 10 provides information on alternative iron making techniques that are already being applied.

Chapter 11 presents information on 'emerging techniques' as defined in Article 3(14) of the Directive.

Concluding remarks and recommendations for future work are presented in Chapter 12.

4. Information sources and the derivation of BAT

This document is based on information collected from a number of sources, in particular, through the TWG that was established specifically for the exchange of information under Article 13 of the Directive. The information has been collated and assessed by the European IPPC Bureau (of the Commission's Joint Research Centre) who led the work on determining BAT, guided by the principles of technical expertise, transparency and neutrality. The work of the TWG and all other contributors is gratefully acknowledged.

The BAT conclusions have been established through an iterative process involving the following steps given below:

- identification of the key environmental issues for the sector following the two most important steelmaking process routes via the sinter/pellet plant/coke oven/blast furnace/basic oxygen converter and the electric arc furnace. The key environmental issues for action in response to environmental concerns are emissions to air and energy consumption;
- examination of the techniques most relevant to address these key issues.
- identification of the best environmental performance levels, on the basis of the available data in the European Union and worldwide;
- examination of the conditions under which these environmental performance levels were achieved, such as costs, cross-media effects, and the main driving forces involved in the implementation of the techniques;
- selection of the best available techniques (BAT), their associated emission levels (and other environmental performance levels) and the associated monitoring for this sector according to Article 3(10) of and Annex III to the Directive.

Expert judgement by the European IPPC Bureau and the TWG has played a key role in each of these steps and the way in which the information is presented here.

Where available, economic data have been given together with the descriptions of the techniques presented in Sections X.3. These data give a rough indication of the magnitude of the costs and benefits. However, the actual costs and benefits of applying a technique may depend strongly on the specific situation of the installation concerned, which cannot be evaluated fully in this document. In the absence of data concerning costs, conclusions on the economic viability of techniques are drawn from observations on existing installations.

5. Review of BAT reference documents (BREFs)

BAT is a dynamic concept and so the review of BREFs is a continuing process. For example, new measures and techniques may emerge, science and technologies are continuously developing and new or emerging processes are being successfully introduced into the industries. In order to reflect such changes and their consequences for the BAT, this document will be periodically reviewed and, if necessary, updated accordingly.

6. Contact information

All comments and suggestions should be made to the European IPPC Bureau at the Institute for Prospective Technological Studies at the following address:

European Commission
Institute for Prospective Technological Studies
European IPPC Bureau
Edificio Expo
c/ Inca Garcilaso, 3
E-41092 Seville, Spain
Telephone: +34 95 4488 284
Fax: +34 95 4488 426
E-mail: JRC-IPTS-EIPPCB@ec.europa.eu
Internet: <http://eippcb.jrc.ec.europa.eu>

Best Available Techniques (BAT) Reference Document for Iron and Steel Production

PREFACE	I
SCOPE	XXI
1 GENERAL INFORMATION	1
1.1 Steel production in Europe and worldwide.....	1
1.2 Geographical distribution of iron and steel production in the EU	3
1.3 Economics and employment in the EU iron and steel industry	8
1.4 Steelmaking process	9
1.5 Main environmental issues in the production of iron and steel	13
2 GENERAL PROCESSES AND TECHNIQUES	19
2.1 Energy management in the steelmaking industry	20
2.1.1 Energy flow and process gas utilisation in integrated steelworks	20
2.1.2 Steam and heat management in integrated steelworks	23
2.1.3 Energy flow in EAF steelmaking	26
2.2 Power plants in iron and steel works	27
2.2.1.1 Applied processes and techniques	27
2.2.1.2 Current emission and consumption level.....	31
2.2.1.2.1 Emissions to air.....	31
2.2.1.2.1.1 Abatement of dust emissions	31
2.2.1.2.1.2 Abatement of SO ₂ emissions.....	31
2.2.1.2.1.3 Abatement of carbon monoxide (CO) emissions	32
2.2.1.2.1.4 Abatement of NO _x emissions	32
2.3 Materials management.....	34
2.3.1 Storage and handling of input materials	35
2.3.2 Management of production residues.....	38
2.3.2.1 Internal use of integrated steelworks residues	40
2.3.2.2 External applications of integrated steelworks residues	41
2.3.2.3 Disposal of integrated steelworks residues	41
2.4 Water and waste water management.....	42
2.5 General techniques to consider in the determination of BAT	48
2.5.1 Environmental management systems	50
2.5.2 Energy management	53
2.5.2.1 Techniques to improve energy efficiency.....	53
2.5.2.2 Techniques to optimise process gas utilisation	54
2.5.2.3 Techniques to improve heat recovery	55
2.5.2.4 Frequency-controlled pumps and fans	57
2.5.3 Reduction of NO _x in process gas-fired power plants	59
2.5.3.1 Reduction of NO _x by primary measures.....	59
2.5.3.2 Reduction of NO _x by secondary measures	61
2.5.3.2.1 NO _x reduction by selective catalytic reduction (SCR)	61
2.5.3.2.2 NO _x reduction by selective non-catalytic reduction (SNCR)	63
2.5.4 Material management	63
2.5.4.1 Techniques to improve the use of scrap.....	63
2.5.4.2 Techniques to reduce diffuse emissions from materials storage, handling, transport and blending	65
2.5.4.3 Techniques to control releases to water from raw materials handling, blending and mixing.....	68
2.5.4.4 Specialised recycling facilities for iron-rich residues	69
2.5.4.4.1 OxyCup [®] shaft furnace	69
2.5.4.4.2 DK process.....	69
2.5.4.4.3 Smelting reduction processes.....	71
2.5.4.4.4 Cold bonded pellets/briquettes.....	74
2.5.5 Monitoring in iron and steel plants	76
2.5.5.1 Continuous parameter and air emissions monitoring.....	76
2.5.5.2 Examples of continuous monitoring of ducted air emissions	77
2.5.5.2.1 Continuous measurement of dust emissions from secondary dedusting systems in basic oxygen furnaces	77
2.5.5.2.2 Continuous monitoring of downstream bag filters in EAF plants.....	79

2.5.5.3	Monitoring of process gases.....	80
2.5.5.4	Discontinuous monitoring of ducted air emissions	81
2.5.5.5	Monitoring of PCDD/F	83
2.5.5.6	Monitoring of diffuse and fugitive emissions	84
2.5.5.6.1	Direct or quasi-direct measurement.....	85
2.5.5.6.2	Indirect measurements.....	85
2.5.5.6.3	Calculation of emissions with emissions factors	87
2.5.5.7	Monitoring the discharge of waste water	88
2.5.6	Reduction of noise	88
3	SINTER PLANTS.....	89
3.1	Applied processes and techniques	89
3.1.1	Purpose of the sinter process.....	89
3.1.2	Blending and mixing of raw materials	89
3.1.3	Sinter strand operation	91
3.1.4	Hot sinter screening and cooling.....	93
3.2	Current emission and consumption levels.....	94
3.2.1	Mass stream overview and input/output data.....	94
3.2.2	Environmental issues for sinter making process	98
3.2.2.1	Emissions to air	98
3.2.2.1.1	Dust emissions from the handling, crushing, screening and conveying of sinter feedstock and products	98
3.2.2.1.2	Off-gas emissions from the sinter strand.....	98
3.2.2.1.2.1	Dust	99
3.2.2.1.2.2	Heavy metals	100
3.2.2.1.2.3	Alkali chlorides	101
3.2.2.1.2.4	Sulphur oxides (SO _x)	102
3.2.2.1.2.5	Fluorides.....	105
3.2.2.1.2.6	Nitrogen oxides (NO _x).....	106
3.2.2.1.2.7	Other inorganic compounds	107
3.2.2.1.2.8	Hydrocarbons	107
3.2.2.1.2.9	Polychlorinated dibenzo-p-dioxins and furans (PCDD/F).....	108
3.2.2.1.2.10	Polychlorinated Biphenyls (PCB)	111
3.2.2.1.2.11	Further organohalogen compounds	112
3.2.2.1.2.12	Polycyclic aromatic hydrocarbons (PAH).....	112
3.2.2.1.2.13	Plumes	113
3.2.2.1.3	Dust emissions from sinter cooling	113
3.2.2.2	Waste water.....	113
3.2.2.3	Process residues such as waste and by-products	114
3.2.2.4	Energy consumption.....	114
3.2.2.5	Noise	115
3.3	Techniques to consider in the determination of BAT for sinter plants.....	116
3.3.1	Process optimisation	118
3.3.2	Abatement techniques for emissions into air from sinter plants	119
3.3.2.1	Advanced electrostatic precipitator (ESP).....	119
3.3.2.1.1	Reduction of PCDD/F by means of ESPs and additives	126
3.3.2.2	Bag filter – combined or integrated reduction of solid and gaseous pollutants....	127
3.3.2.3	Cyclones.....	140
3.3.2.4	Fine wet scrubbers.....	141
3.3.2.5	Reduction of VOC emissions	145
3.3.2.5.1	Lowering the content of volatile hydrocarbons in the sinter feed	145
3.3.2.5.2	Top layer sintering	146
3.3.2.6	Reduction of PCDD/F	147
3.3.2.6.1	Suppression of PCDD/F formation by addition of nitrogen compounds in the sinter mix.....	147
3.3.2.7	Reduction of SO ₂	149
3.3.2.7.1	Primary measures for reduced SO ₂ emissions from the sinter process.....	149
3.3.2.7.2	Wet desulphurisation.....	150
3.3.2.7.3	Regenerative activated carbon (RAC) process for desulphurisation and reduction of NO _x	154
3.3.2.8	Reduction of NO _x	158
3.3.2.8.1	Primary measures for reduced NO _x emissions.....	158
3.3.2.8.2	Selective catalytic reduction (SCR).....	158

3.3.3	Collection and abatement of dust emissions from secondary sources	161
3.3.4	Use of production residues such as waste and by-products in the sinter plant	162
3.3.5	Heat recovery in the sinter process	164
3.3.5.1	Heat recovery from sintering and sinter cooling	164
3.3.5.2	Partial recycling of waste gas	166
3.3.5.2.1	Partial recycling of waste gas from the whole strand	168
3.3.5.2.2	Recycling of waste gas from the end sinter strand combined with heat exchange	172
3.3.5.2.3	Recycling of waste gas from part of the end sinter strand and use of waste gas from the sinter cooler	174
3.3.5.2.4	Recycling of parts of waste gas to other parts of the sinter strand	177
4	PELLETISATION PLANTS.....	181
4.1	Applied processes and techniques	182
4.1.1	Grinding and drying/dewatering	182
4.1.2	Green ball preparation	184
4.1.3	Induration	184
4.1.3.1	The straight grate process	184
4.1.3.2	The grate kiln process	186
4.1.4	Screening and handling	186
4.2	Current emission and consumption levels	187
4.2.1	Mass stream overview and input/output data	187
4.2.2	Environmental issues for the pellet-making process	189
4.2.2.1	Emissions to air	189
4.2.2.2	Water flows	190
4.2.2.3	Process residues such as wastes and by-products	191
4.2.2.4	Energy consumption	191
4.2.2.5	Noise	192
4.3	Techniques to consider in the determination of BAT for pelletisation plants.....	193
4.3.1	Electrostatic precipitation at the grinding mills (dry grinding).....	194
4.3.2	Individual or combined reduction of solid and gaseous pollutants from the drying and induration zone	195
4.3.3	Gas suspension absorber (GSA)	196
4.3.4	Process-integrated NO _x abatement.....	197
4.3.5	Selective catalytic reduction (SCR).....	198
4.3.6	Pellet plant water treatment	199
4.3.7	Arsenic removal plant.....	201
4.3.8	Recovery of sensible heat from the induration strand	202
5	COKE OVEN PLANTS.....	205
5.1	Applied processes and techniques	206
5.1.1	Coal handling and preparation.....	209
5.1.2	Coke oven battery operations	209
5.1.2.1	Coal charging.....	210
5.1.2.2	Heating/firing of the chambers	211
5.1.2.3	Coking	212
5.1.2.4	Coke pushing	214
5.1.2.5	Coke quenching	214
5.1.3	Coke handling and preparation	214
5.1.4	Coke oven gas treatment.....	215
5.1.4.1	Collection and treatment of coke oven gas (COG) with the recovery of by-products	215
5.1.4.2	Gas cooling	218
5.1.4.3	Tar recovery from the coke oven gas.....	219
5.1.4.4	Desulphurisation of coke oven gas	219
5.1.4.5	Recovery of ammonia from the coke oven gas.....	219
5.1.4.6	Recovery of light oil from coke oven gas	220
5.1.5	Water flows from coke oven and by-product plants	220
5.2	Current emission and consumption levels	223
5.2.1	Mass stream overview and input and output data.....	223
5.2.2	Environmental issues for the coke-making process.....	225
5.2.2.1	Emissions to air	225
5.2.2.2	Water usage and waste water	230
5.2.2.3	Process residues from coke oven plants.....	233

5.2.2.4	Energy demand.....	234
5.2.2.5	Soil pollution.....	235
5.3	Techniques to consider in the determination of BAT.....	236
5.3.1	Coal preparation.....	238
5.3.2	Minimising oven charging emissions.....	238
5.3.3	Sealing of ascension pipes and charging holes.....	240
5.3.4	Smooth and undisturbed operation of the coke oven plant.....	242
5.3.5	Maintenance of coke ovens.....	244
5.3.6	Larger coke oven chambers.....	245
5.3.7	Improvement of oven door and frame seals.....	247
5.3.8	Cleaning of oven doors and frame seals.....	248
5.3.9	Maintaining free gas flow in the coke oven.....	249
5.3.10	Variable pressure regulation of ovens during the coking process.....	249
5.3.11	Heat recovery coking.....	252
5.3.12	Emissions reduction at coke oven firing.....	256
5.3.12.1	Minimising leakage between coke oven chambers and heating chambers.....	256
5.3.12.2	Reduction of NO _x by primary measures.....	257
5.3.12.3	Reduction of NO _x by secondary measures.....	258
5.3.12.4	Reduction of SO ₂ by coke oven gas desulphurisation.....	259
5.3.13	Emission reduction during coke pushing.....	266
5.3.14	Coke dry quenching.....	268
5.3.15	Coke wet quenching.....	271
5.3.15.1	Conventional wet quenching.....	271
5.3.15.2	Coke stabilisation quenching.....	273
5.3.16	Emissions reduction in coke handling.....	274
5.3.17	Closed belt conveyors.....	275
5.3.18	Gas-tight operation of the gas treatment plant.....	276
5.3.19	Removing tar (and PAH) from still effluent.....	277
5.3.20	Stripping of ammonia from the waste water.....	278
5.3.21	Waste water treatment.....	279
6	BLAST FURNACES.....	289
6.1	Applied processes.....	289
6.1.1	Burden preparation.....	291
6.1.2	Conveying and charging of raw materials.....	291
6.1.3	Blast furnace operation.....	292
6.1.3.1	Reducing agents application.....	293
6.1.4	Hot stoves operation.....	295
6.1.5	Casting.....	296
6.1.6	Slag cooling and processing.....	297
6.1.6.1	Slag granulation processing.....	299
6.1.6.2	Slag pelletising process.....	300
6.1.6.3	Slag pit process.....	300
6.2	Current emission and consumption levels.....	302
6.2.1	Mass stream overview and input/output data.....	302
6.2.2	Environmental issues for the blast furnace process.....	306
6.2.2.1	Emissions to Air.....	307
6.2.2.2	Waste water.....	311
6.2.2.3	Process residues such as wastes and by-products.....	313
6.2.2.4	Energy and reductant demand.....	315
6.2.2.5	Noise emissions.....	316
6.3	Techniques to consider in the determination of BAT.....	317
6.3.1	Cast house dedusting (tap holes, runners, skimmers, torpedo ladle charging points).....	319
6.3.2	Fume suppression during hot metal charging.....	322
6.3.3	Use of tar-free runner linings.....	325
6.3.4	Blast furnace gas treatment.....	326
6.3.5	Gas recovery system for top hopper release.....	328
6.3.6	Treatment and reuse of scrubbing water.....	331
6.3.7	Hydrocyclonage of blast furnace sludge.....	334
6.3.8	Condensation of fume from slag processing.....	335
6.3.9	Use of high quality ores.....	337
6.3.10	Increase of energy efficiency in blast furnaces.....	337
6.3.11	Recovery and use of blast furnace gas.....	339

6.3.12	Direct injection of reducing agents	339
6.3.12.1	Coal injection	341
6.3.12.2	Oxy-oil injection	343
6.3.12.3	Gas injection	344
6.3.12.4	Plastic injection	345
6.3.12.5	Direct injection of used oils, fats and emulsions as reducing agents and of solid iron residues	347
6.3.13	Energy recovery from top gas pressure	349
6.3.14	Energy savings at the hot stoves	350
7	BASIC OXYGEN STEELMAKING AND CASTING	353
7.1	Applied processes and techniques	354
7.1.1	Transport and storage of hot metal	354
7.1.2	Pretreatment of hot metal	355
7.1.3	Oxidation in the basic oxygen furnace	356
7.1.4	Secondary metallurgy	361
7.1.5	Casting	363
7.1.5.1	Continuous casting	363
7.1.5.2	Near net shape casting	365
7.1.5.3	Ingot casting	365
7.2	Current emission and consumption levels	367
7.2.1	Mass stream overview and input/output data	367
7.2.2	Environmental issues for basic oxygen steelmaking	370
7.2.2.1	Emissions to Air	370
7.2.2.1.1	Emissions from hot metal pretreatment	371
7.2.2.1.2	Emissions from BOF operations	371
7.2.2.1.3	Other emission sources in the BOF process including secondary metallurgy and continuous casting	375
7.2.2.1.4	Diffuse emissions from the BOF processes	375
7.2.2.2	Waste water	377
7.2.2.3	Process residues such as wastes and by-products	378
7.2.2.4	Energy consumption	383
7.3	Techniques to consider in the determination of BAT	384
7.3.1	Primary dedusting	386
7.3.2	Secondary dedusting	388
7.3.2.1	Collection and abatement of secondary emissions	388
7.3.2.2	Dust abatement from hot metal pretreatment	396
7.3.2.3	Dust abatement for ingot and continuous casting	398
7.3.2.4	General techniques to prevent or control diffuse and fugitive secondary emissions	399
7.3.3	Treatment of waste water from wet dedusting	401
7.3.4	Treatment of waste water from continuous casting	402
7.3.5	Dust hot briquetting and recycling with recovery of high zinc concentrated pellets for external reuse	404
7.3.6	Lowering the zinc content of scrap	407
7.3.7	Energy recovery from the BOF gas	408
7.3.8	Online sampling and steel analysis	411
7.3.9	Increased energy efficiency in the steel shop by automatisisation	412
7.3.10	Direct tapping from BOF	415
7.3.11	Near net shape strip casting	416
8	ELECTRIC ARC FURNACE STEELMAKING AND CASTING	419
8.1	Applied processes and techniques	419
8.1.1	Raw materials handling and storage	421
8.1.2	Scrap preheating	422
8.1.3	Charging	422
8.1.4	Electric arc furnace melting and refining	423
8.1.5	Steel and slag tapping	423
8.1.6	Secondary metallurgy	423
8.1.7	Slag handling and processing	426
8.1.8	Casting	427
8.2	Present consumption and emission levels	428
8.2.1	Mass stream overview and input/output data	428
8.2.2	Environmental issues for electric arc furnace steelmaking process	430

8.2.2.1	Emissions to air	430
8.2.2.1.1	Collection of primary emissions.....	430
8.2.2.1.2	Collection of secondary emissions	430
8.2.2.1.3	Primary and secondary emissions and treatment.....	432
8.2.2.1.4	Emissions from secondary metallurgy processes and continuous casting....	439
8.2.2.1.5	Emissions from scrap preheating.....	439
8.2.2.1.6	Emissions from slag processing	439
8.2.2.2	Waste water.....	440
8.2.2.3	Process residues such as wastes and by-products.....	441
8.2.2.3.1	Slags from production of carbon steel/low alloyed steel/high alloyed steel.	441
8.2.2.3.2	Dusts from off-gas treatment.....	443
8.2.2.3.3	Refractory bricks	444
8.2.2.4	Energy consumption.....	445
8.2.2.5	Noise emissions.....	445
8.2.2.6	Soil contamination	446
8.3	Techniques to consider in the determination of BAT.....	447
8.3.1	EAF process optimisation	449
8.3.2	Scrap preheating.....	451
8.3.3	Reducing of dust emissions from slag processing.....	457
8.3.4	Advanced emission collection systems	458
8.3.5	Abatement techniques for primary and secondary emissions to air from electric arc furnaces	460
8.3.5.1	Dust abatement by means of a bag filter and an electrostatic precipitator	460
8.3.5.2	Reduction of PCDD/F by means of post-combustion and quenching in combination with a bag filter	463
8.3.5.3	Reduction of PCDD/F by means of adsorbent materials in combination with bag filters	467
8.3.6	Treatment of waste water from continuous casting.....	471
8.3.7	Closed loop water cooling system.....	472
8.3.8	EAF dust processing for the recovery of heavy metals	473
8.3.9	EAF slag processing.....	474
8.3.10	Treatment of high alloyed and stainless steel EAF slags	476
8.3.11	Near net shape strip casting.....	478
8.3.12	Techniques to prevent noise emissions	478
9	BAT CONCLUSIONS FOR IRON AND STEEL PRODUCTION.....	481
9.1	General BAT Conclusions	483
9.1.1	Environmental management systems	483
9.1.2	Energy management.....	484
9.1.3	Material management.....	486
9.1.4	Management of process residues such as by-products and waste	487
9.1.5	Diffuse dust emissions from materials storage, handling and transport of raw materials and (intermediate) products.....	487
9.1.6	Water and waste water management.....	490
9.1.7	Monitoring	490
9.1.8	Decommissioning.....	492
9.1.9	Noise	492
9.2	BAT Conclusions For Sinter Plants	493
9.3	BAT Conclusions For Pelletisation Plants	500
9.4	BAT Conclusions For Coke Oven Plants	503
9.5	BAT Conclusions For Blast Furnaces	509
9.6	BAT Conclusions For Basic Oxygen Steelmaking And Casting	513
9.7	BAT Conclusions For Electric Arc Furnace Steelmaking And Casting.....	517
10	ALTERNATIVE IRONMAKING TECHNIQUES.....	521
10.1	Direct reduction (DR)	523
10.2	Smelting reduction (SR).....	526
10.2.1	Corex and Finex processes.....	526
10.2.2	Processes under development	529
10.3	Comparison of the conventional blast furnace route with the direct reduction and smelting reduction route	533
11	EMERGING TECHNIQUES.....	537
11.1	General emerging techniques	538

11.1.1	Carbon dioxide mitigation strategies (ULCOS project)	538
11.1.1.1	Top gas recycling blast furnace	538
11.1.1.2	Carbon-lean fuels and reducing agents	539
11.1.1.3	Biomass	540
11.1.2	CO ₂ capture and storage	541
11.1.3	Ceramic filters for the abatement of both particles and nitrogen oxides from gas streams	543
11.1.4	Burning and recycling of dry waste dust	543
11.2	Emerging techniques for sinter plants.....	546
11.2.1	Use of carbon impregnated plastics for PCDD/F adsorption.....	546
11.2.2	Suppression of PCDD/F formation by addition of nitrogen compounds to the flue-gas	546
11.2.3	Quenching	547
11.3	Emerging techniques for coke ovens	549
11.3.1	Super coke oven	549
11.3.2	Single oven pressure control technique	550
11.3.3	Alternatives in coke oven gas utilisation.....	553
11.4	Emerging techniques for blast furnaces.....	554
11.4.1	Reduction of CO emissions from hot stoves with an internal combustion chamber	554
11.4.2	Slag heat recovery	554
11.4.3	Injection of waste in blast furnaces	554
11.5	Emerging techniques for BOF and casting	555
11.5.1	Improvement of BOF slag stability for extended use	555
11.5.2	Improving clean gas dust content in wet scrubber-based BOF plants by upgrading to Hydro Hybrid Filters	555
11.5.3	Whirl hood for secondary dedusting.....	556
11.5.4	Recycling of BOF and EAF ladle slags as a flux agent in electric steelmaking.....	557
11.6	Emerging techniques for EAF	559
11.6.1	Contiarc furnace	559
11.6.2	Intermetallic bag filter to minimise emissions of dust, PCDD/F and heavy metals	560
11.6.3	Recovery of old tyres in EAF	560
11.6.4	Recycling of (BOF and EAF) slags as a flux agent in electric steelmaking	561
12	CONCLUDING REMARKS AND RECOMMENDATIONS FOR FUTURE WORK.....	563
	REFERENCES	569
	GLOSSARY	585
	<i>I. General considerations</i>	<i>585</i>
	<i>II. Monetary units</i>	<i>585</i>
	<i>III. ISO country codes.....</i>	<i>586</i>
	<i>IV. Unit prefixes</i>	<i>586</i>
	<i>V. Units</i>	<i>586</i>
	<i>VI. Chemical elements</i>	<i>587</i>
	<i>VII. Acronyms and definitions.....</i>	<i>588</i>
13	ANNEXES.....	591
13.1	Annex I. Determination of some environmentally sensitive elements in waste water.....	591
13.2	Annex II. Dioxin emissions	593
13.3	Annex III. WHO-12 PCB	594
13.4	Annex IV. Example of mass flow thresholds for continuous monitoring.....	596
13.5	Annex V. Example of template for compiling environmental data in the iron and steel sector	597

List of figures

Figure 1.1:	Crude steel production in Europe and worldwide since 1870.....	1
Figure 1.2:	Steel production by electric arc furnace and oxygen steel in the EU from 1996 – 2006	2
Figure 1.3:	Geographical distribution of integrated steelworks in the European Union	3
Figure 1.4:	Crude steel production methods	9
Figure 1.5:	Aerial view of an integrated steelworks located near the coast	10
Figure 1.6:	Overview of the process routes of an integrated steelworks.....	11
Figure 1.7:	Overview of the inputs and outputs for the manufacture of iron and steel in the EU-27 in 2006	13
Figure 2.1:	Flow sheet of typical gas utilisation in integrated sinter, coke and hot metal production....	20
Figure 2.2:	Example of the energy flow in an integrated steelworks	21
Figure 2.3:	Example of use of the coke oven gas in an integrated steelworks	22
Figure 2.4:	Example of BF and BOF gas flow in an integrated steelworks	23
Figure 2.5:	Example of steam production and the use of industrial waste heat in an integrated steel plant	25
Figure 2.6:	View of a power plant in an integrated steelworks	27
Figure 2.7:	A boiler/generator arrangement (40 MW _e).....	28
Figure 2.8:	Example of a boiler/generator arrangement with reheating (85 MW _e).....	29
Figure 2.9:	Example of a gas turbine (38 MW _e) and steam turbine (30 MW _e) in combined cycle in CHP mode	30
Figure 2.10:	Flow diagram of a typical material handling process in an integrated steelworks.....	36
Figure 2.11:	Example for the management of production residues such as by-products and wastes in an integrated steelworks	39
Figure 2.12:	Example of water management of an integrated steelworks at a location with a high surplus of fresh water availability	43
Figure 2.13:	Example for the water management of an integrated steelworks with separate circuits	45
Figure 2.14:	Example for the water management of an integrated steelworks using a cascade system...	46
Figure 2.15:	Continuous improvement in an EMS model.....	50
Figure 2.16:	Catalytic NO _x converter	61
Figure 2.17:	Dust quantities from secondary dedusting systems presented as weekly averages.....	78
Figure 3.1:	Photograph of a sinter strand with the charging facility (drums or chutes) and the ignition canopy at the starting end	89
Figure 3.2:	Schematic diagram of a sinter plant showing the main emission points.....	91
Figure 3.3:	Schematic diagram of temperature and reaction zones in a sintering process six minutes after ignition	93
Figure 3.4:	Mass stream overview of a sinter plant.....	94
Figure 3.5:	Typical emissions profiles of CO ₂ , CO, O ₂ and H ₂ O in the waste gas (single windboxes) along the sinter strand.....	98
Figure 3.6:	Grain size and weight distribution of dust from various sinter strands.....	99
Figure 3.7:	Distribution of temperature and concentration of gas compounds in the exhaust gas from the windboxes	102
Figure 3.8:	Typical emission profile of SO ₂ and NO _x in the waste gas (individual windboxes) and the temperature profile along the sinter strand	103
Figure 3.9:	Weighted average composition of sinter for plants participating in the European Blast Furnace Committee data exchange	104
Figure 3.10:	Influence of sinter basicity (CaO/SiO ₂) on specific dust resistivity.....	105
Figure 3.11:	Relationship between sinter feed basicity and fluoride emissions	106
Figure 3.12:	PCDD/F and temperature profile in the waste gas along the sinter strand.....	110
Figure 3.13:	Influence of the alkali input into the sinter process on dust emissions after the ESP at the sinter plant in Voestalpine Stahl GmbH, Donawitz, Austria	120
Figure 3.14:	Achieved clean gas dust concentrations with an ESP for sinter strand off-gas and the impact of reduced chloride input	121
Figure 3.15:	Basic flow sheet of a bag filter downstream of an existing ESP or cyclone.....	129
Figure 3.16:	Flow scheme of a sinter plant with a SIMETAL MEROS [®] system added	130
Figure 3.17:	Daily means for the dust emissions from one sinter strand equipped with a bag filter technique from January 2008 to October 2009.....	133
Figure 3.18:	Treatment of the waste gas from the sinter plant using the AIRFINE system.....	141
Figure 3.19:	Regenerative activated carbon (RAC) process	154
Figure 3.20:	Heat recovery from cooling air from the sinter cooler.....	164
Figure 3.21:	Covered sinter strand according to the EOS process	168

Figure 3.22:	Schematic diagram of the emission optimised sintering (EOS) process	169
Figure 3.23:	Low emission and energy optimised sintering process(LEEP) developed by Hüttenwerke Krupp Mannesmann	172
Figure 3.24:	Schematic diagram of the EPOSINT gas recycling technique installed at sinter strand No 5 of Voestalpine, Linz, Austria	174
Figure 3.25:	Schematic diagram of selective waste gas recirculation in sinter plant No 3 of Nippon Steel Corporation, Yawata Works, Tobata, Japan.....	178
Figure 4.1:	Balling drum as part of a pelletisation plant where the green pellets are formed.....	182
Figure 4.2:	Schematic of the pelletisation plant in the Netherlands.....	182
Figure 4.3:	Schematic of a pelletisation plant with wet grinding	183
Figure 4.4:	Schematic of the straight grate process	185
Figure 4.5:	Schematic of the grate kiln process.....	186
Figure 4.6:	Mass stream overview of a pelletisation plant	187
Figure 4.7:	Process flow diagram of an arsenic removal plant	201
Figure 5.1:	Photograph of the coke oven plant in Duisburg-Schwelgern, Germany	206
Figure 5.2:	Typical flow diagram of a coke oven plant showing emissions sources	208
Figure 5.3:	Schematic diagram of a coke oven battery showing the main emission sources.....	210
Figure 5.4:	Diagram of coal charging of a coke oven chamber using a charging car showing the emissions points	211
Figure 5.5:	Schematic diagram of a coke oven heating system showing the emissions points	212
Figure 5.6:	Schematic diagram of a coke oven chamber showing possible emissions points during coking (indicated by arrows).....	213
Figure 5.7:	Pushing of carbonised coke from the coke oven into a quenching car showing the emissions points	214
Figure 5.8:	Typical scheme of a COG treatment plant with the recovery of by-products	217
Figure 5.9:	Schematic diagram of example water flows in a coke oven plant.....	218
Figure 5.10:	Mass stream overview of a coke oven plant.....	223
Figure 5.11:	Example for the annual energy demand/balance of a coke oven plant in an integrated iron and steel works.....	234
Figure 5.12:	Ascension pipe of a coke oven chamber	241
Figure 5.13:	PROven [®] system scheme	251
Figure 5.14:	Jewell-Thompson oven and heat recovery coke plant.....	253
Figure 5.15:	Most essential features of the heat recovery technique in contrast to COG recovery	254
Figure 5.16:	Flow diagram of a COG desulphurisation plant with an ASK process installed in 1997...	262
Figure 5.17:	Example of a dedusting system for dust from coke pushing	267
Figure 5.18:	Scheme of a coke dry quenching plant.....	269
Figure 5.19:	Schematic diagram of a quenching tower with emissions reduction baffles	272
Figure 5.20:	Example of a pipe conveyor system.....	275
Figure 5.21:	Example of a typical biological waste water treatment with nitrification-denitrification steps	280
Figure 5.22:	Example of a biological treatment plant with predenitrification-nitrification-denitrification	281
Figure 5.23:	Floor plan of the biological treatment plan at Corus, IJmuiden, the Netherlands	283
Figure 5.24:	Aerial view of the biological waste water treatment plant at Corus, IJmuiden, the Netherlands	284
Figure 6.1:	General view of two blast furnaces with three hot stoves each and the stack for the waste gas from the hot stoves.....	289
Figure 6.2:	Simplified scheme of a blast furnace	290
Figure 6.3:	Average consumption of reducing agents of the blast furnaces in Germany	293
Figure 6.4:	Reducing agent consumption in blast furnaces in the world in 2006	294
Figure 6.5:	Cross-section of hot stoves ('cowpers') with an internal and external combustion chamber	296
Figure 6.6:	Summary of control methods and flow sheet for liquid BF slags	298
Figure 6.7:	Example of a granulation of slag from the blast furnace in the open circuit process	299
Figure 6.8:	Granulation of slag from the blast furnace in the INBA process.....	300
Figure 6.9:	Mass stream overview of a blast furnace	302
Figure 6.10:	General process layout of a blast furnace with indication of the individual operations and the input and output mass streams.....	303
Figure 6.11:	Schematic diagram of water management at a blast furnace.....	311
Figure 6.12:	Fate of dust and sludge from BF gas treatment in the EU	314
Figure 6.13:	Final use of blast furnace slag in the EU	315
Figure 6.14:	Daily average emission values of cast house dedusting systems at tap holes and runners of blast furnaces at Voestalpine, Linz, Austria.....	321

Figure 6.15:	Dust generation with and without nitrogen inertisation during hot metal charging (to the torpedo level) depending on the flow of hot metal	323
Figure 6.16:	Charging of hot metal into torpedo ladle with dust suppression with inert gas	324
Figure 6.17:	Comparison of investment, energy and maintenance costs for the fume suppression system at ArcelorMittal, Bremen Germany	325
Figure 6.18:	Diagram of a bell-less top with primary and secondary equalising and without a gas recovery system	328
Figure 6.19:	Diagram of a bell-less top with equalising, relief and a gas recovery system	329
Figure 6.20:	Example process for the cyanide treatment of scrubbing water at blast furnaces.....	332
Figure 6.21:	Granulation of blast furnace slag with fume condensation.....	336
Figure 6.22:	Coke rates and injection rates at 26 blast furnaces	340
Figure 6.23:	Example of the layout for COG injection	345
Figure 6.24:	Simplified diagram of the scheme for direct injection of liquid reverts to the blast furnace	348
Figure 7.1:	Basic oxygen furnace at the moment of charging hot metal	353
Figure 7.2:	The sequence of oxygen steelmaking indicating the individual emission sources	354
Figure 7.3:	Basic oxygen steelmaking converter	357
Figure 7.4:	Cutaway model of a OBM (Q-BOP) converter	357
Figure 7.5:	Schematic of a combined blowing converter system with top-blowing	358
Figure 7.6:	Treatments of BOF slag	360
Figure 7.7:	Overview of secondary metallurgy operations and cleaning during tapping	362
Figure 7.8:	Scheme of a continuous casting plant with a soaking furnace and a rolling mill with hot charging	364
Figure 7.9:	Mass stream overview of a basic oxygen steelmaking plant	367
Figure 7.10:	General process layout of basic oxygen steelmaking indicating the individual operations and the input and output mass streams	368
Figure 7.11:	BOF gas collection in the case of suppressed combustion	373
Figure 7.12:	Fate of slag from hot metal desulphurisation in the EU.....	379
Figure 7.13:	Use of steel slags in Europe in 2004.....	380
Figure 7.14:	Fate of dust from dry BOF gas treatment	382
Figure 7.15:	Use of dust/sludge and mill scale from oxygen steelmaking.....	383
Figure 7.16:	Collection of secondary emissions during the charging of hot metal and scrap to the BOF	390
Figure 7.17:	Specific energy consumption for different dedusting operations in integrated steelworks	392
Figure 7.18:	Example of a secondary dedusting system consisting of three separate blowers and filters handling the air extracted from a variety of extraction points	394
Figure 7.19:	Daily average emission values of the secondary dedusting Unit 2 at the basic oxygen furnace of Voestalpine Stahl GmbH, Linz, Austria	395
Figure 7.20:	Dust arrestment at a hot metal desulphurisation stand.....	396
Figure 7.21:	Daily average emission values of the secondary dedusting Unit 1 at the basic oxygen furnace of Voestalpine Stahl GmbH, Linz, Austria	397
Figure 7.22:	Facility for hot briquetting of dust from basic oxygen steelmaking plants.....	405
Figure 7.23:	Schematic overview of measures to optimise the recycling of dusts from the basic oxygen furnace	406
Figure 7.24:	Automatic ladle lid system	413
Figure 7.25:	Schematic of an automatic tapping system.....	413
Figure 7.26:	Possible classification scheme for the strip casting processes	417
Figure 7.27:	Relationship between primary energy consumption and CO ₂ emissions (comparison of industrial scale plants) for different casting techniques	418
Figure 8.1:	Electric arc furnace plant.....	419
Figure 8.2:	Electric arc furnace charging	420
Figure 8.3:	Overview of the processes related to electric arc furnace steelmaking.....	421
Figure 8.4:	Block diagram of possible secondary metallurgy/ladle treatments for different grades of steel (carbon, stainless or high alloyed).....	425
Figure 8.5:	Material flow of a stainless steel melt shop with an Argon oxygen decarburisation converter	426
Figure 8.6:	Mass stream overview of an electric arc furnace.....	428
Figure 8.7:	Collection systems at EAF.....	431
Figure 8.8:	Percentage of existing dust collection system in 51 EAF in the EU.....	432
Figure 8.9:	Distribution of PCDD/F homologues in the off-gas of a twin shell EAF with scrap preheating before and after abatement.....	436
Figure 8.10:	Correlation of PCDD/F emissions and temperature of the off-gas after abatement in a bag filter of an EAF	436

Figure 8.11: Correlation of residual dust content and PCDD/F concentrations after abatement in a bag filter in the off-gas of an EAF at temperatures below 85 °C	437
Figure 8.12: Correlation of water vapour and residual dust content after abatement in a bag filter in the off-gas of an EAF	437
Figure 8.13: PCDD/F emissions from EAF as I-TEQ and WHO-TEQ including dioxin-like PCB	438
Figure 8.14: Utilisation of EAF dust	444
Figure 8.15: Schematic of the CONSTEEL process	452
Figure 8.16: Number of preheating installations at EAF	457
Figure 8.17: Daily average dust emissions from an EAF plant over three years	461
Figure 8.18: Post-combustion of the primary off-gas from an EAF with subsequent rapid cooling	464
Figure 8.19: Average annual dioxin emission concentrations from two EAFs with post-combustion and rapid cooling (1997 – 2000)	465
Figure 8.20: Schematic of an adsorbent injection system	468
Figure 8.21: Processing scheme of a plant for slag preparation	475
Figure 10.1: Past, present and future routes for alternative ironmaking and steelmaking processes	522
Figure 11.1: Schematic of the top gas recycling blast furnace to minimise GHG emissions with capture and the optional storage of CO ₂	539
Figure 11.2: Process flow of a SCOPE 21 super coke oven	550
Figure 11.3: SOPRECO valve	551
Figure 11.4: SOPRECO system scheme	552
Figure 11.5: SOPRECO Model 2 valves on a stamped charged battery	553
Figure 13.1: IUPAC numbering system and positional nomenclature of PCB	594

List of tables

Table 1.1:	Number and production of sinter and pelletisation installations in the EU-27	4
Table 1.2:	Production of coke in the EU-27	4
Table 1.3:	Number and production of blast furnace installations in the EU-27	5
Table 1.4:	Number and production of basic oxygen furnace installations in different EU countries	5
Table 1.5:	Number and production of EAF steelmaking installations in the EU-27	6
Table 1.6:	Number and production of continuous casting installations in the EU-27	6
Table 1.7:	Development of employment in the iron and steel industry in the EU from 1996 to 2004 ...	8
Table 1.8:	First table showing potential release routes for prescribed substances and other substances that may cause environmental harm	16
Table 1.9:	Second table showing potential release routes for prescribed substances and other substances that may cause environmental harm	17
Table 1.10:	Third table showing potential emission releases from prescribed substances and other substances that may cause environmental harm	18
Table 2.1:	Efficiency of gas-fired boilers when using low calorific value gas	28
Table 2.2:	Efficiency of combined cycle gas turbine when using low calorific value gas from iron and steel works.	30
Table 2.3:	Achieved emission values for gas-fired boilers and turbines when using process gases from iron and steel works	31
Table 2.4:	SO ₂ emissions for five process gas-fired units in Austria	32
Table 2.5:	Typical composition of steelworks process gases	32
Table 2.6:	Typical NO _x emission values for burning COG in power plants	33
Table 2.7:	Use of steel slags in Europe	40
Table 2.8:	Comparison in water intake required for integrated steelworks with once-through systems versus extensive recirculation	44
Table 2.9:	Information for each technique described in this section	49
Table 2.10:	Example of a CHP plant to producing heat and electrical power for a community	57
Table 2.11:	NO _x reduction efficiency for primary measures	60
Table 2.12:	Performance data for five process gas-fired units using the SCR technique	62
Table 2.13:	Operational data for the Primus [®] plant at Differdange designed for a nominal throughput of 10 tonnes per hour	72
Table 2.14:	Achieved clean gas concentrations for the directed Primus [®] process off-gas (MHF and EAF)	72
Table 2.15:	Achieved clean gas concentrations for the doghouse Primus [®] process off-gas (MHF and EAF)	73
Table 2.16:	Examples for continuously measured air emissions at Voestalpine Stahl, Linz, Austria ...	77
Table 2.17:	Example of permit conditions for the monitoring of process gases at Voestalpine Stahl, Linz, Austria	80
Table 2.18:	Examples of measuring methods for discontinuous emission monitoring	82
Table 2.19:	Total cost for a PCDD/F measurement according to EN 1948	84
Table 2.20:	Monitoring frequency for PCDD/F in the metallurgical industry in various Member States	84
Table 3.1:	Examples of characteristics of coke breeze used in sinter plants	90
Table 3.2:	Input raw materials for sinter production in the EU-25 for 2004	94
Table 3.3:	Input data from 1999 from five sinter plants in four different EU Member States (Austria, Belgium, Germany and the Netherlands)	95
Table 3.4:	Averaged maximum and minimum emissions concentrations in the sinter strand waste gas after abatement for sinter production in the EU-25 in 2004	96
Table 3.5:	Ranges for point source air emissions for particulate emissions for the main individual operations of a sinter plant (excluding the main waste gas stack)	97
Table 3.6:	Dust emissions from secondary dedusting in three EU sinter plants	97
Table 3.7:	Ranges found in the elementary analysis of sinter dust	100
Table 3.8:	Soluble chloride contents in sinter feed materials	101
Table 3.9:	PCDD/F concentrations of raw materials, mixed materials and produced sinter	109
Table 3.10:	Total concentrations of PCDD and PCDF homologue groups in wind leg samples	111
Table 3.11:	PCB emissions from sinter plants	112
Table 3.12:	PCB congeners found in waste gases from sinter plants	112
Table 3.13:	Information breakdown for each technique described in this section	117
Table 3.14:	Performance of ESPs at two sinter plants at ArcelorMittal, Ghent, Belgium in 2008	121

Table 3.15:	Achieved emission concentration values for sinter strand dedusting with an ESP at three German sinter plants.....	122
Table 3.16:	Operational and economic data for MEEP and ESCS electrostatic precipitators operated at sinter plants to treat sinter plant waste gas	125
Table 3.17:	Performance of three sinter strand plants with bag filter systems	131
Table 3.18:	Achieved emission concentration values for sinter strand dedusting in five EU sinter plants	132
Table 3.19:	Characteristics of different adsorbent and absorption materials.....	134
Table 3.20:	Typical operational values when using sodium bicarbonate and slaked lime as additives.....	134
Table 3.21:	Examples of the cost of bag filters installed in sinter plants	136
Table 3.22:	Operational data and economics of bag filters at sinter plants	138
Table 3.23:	Achieved air emission parameters at Corus, IJmuiden, the Netherlands using the AIRFINE system.....	142
Table 3.24:	Achieved emissions concentrations and emissions factors of the treated waste water from waste gas scrubbing and ESP filter dust extraction at Corus, IJmuiden the Netherlands in 2004.....	143
Table 3.25:	Operational data for the Corus IJmuiden plant.....	144
Table 3.26:	Cost estimation of wet process together with an SCR system.....	152
Table 3.27:	Wet desulphurisation units at sinter plants	152
Table 3.28:	Operational data and economics of three sinter plant wet desulphurisation units	153
Table 3.29:	Concentration of waste gas components	155
Table 3.30:	Achievable performance of a sinter plant when applying activated char coal	155
Table 3.31:	Cost estimation of an activated coal system.....	157
Table 3.32:	Partial waste gas recirculation techniques included in this section	167
Table 3.33:	Comparison of characteristics and emission values of conventional sintering and emission optimised sintering at a sinter strand at Corus, IJmuiden, the Netherlands.....	170
Table 3.34:	Reported emission reduction (by mass) of emission optimised sintering (EOS) at Corus, IJmuiden, the Netherlands	170
Table 3.35:	Some environmental benefits achieved with LEEP compared to a conventional sintering process.....	173
Table 3.36:	Main environmental benefits of the application of the sectional waste gas recirculation technique	176
Table 3.37:	Operational data of the sinter plant before and after installation of sectional waste gas recirculation (2007, applying Airfine for waste gas abatement)	176
Table 3.38:	Characteristics of waste gas flows using sectional waste gas recirculation in sinter plant No 3 of Nippon Steel Corporation, Yawata Works, Tobata, Japan.....	179
Table 3.39:	Comparison of final waste gas composition before and after rebuild to sectional waste gas recirculation in sinter plant No 3 of Nippon Steel Corporation, Yawata Works, Tobata, Japan.....	179
Table 4.1:	Input/output data from three pellet plant sites in the EU-25	188
Table 4.2:	Operational data from the Malmberget and Kiruna (Sweden) water treatment.....	191
Table 4.3:	Information breakdown for each technique described in this section	193
Table 4.4:	Performance data of a gas suspension absorber (GSA).....	196
Table 4.5:	Operational data from the arsenic removal plant (2007)	201
Table 5.1:	Raw coke oven gas yield and composition.....	216
Table 5.2:	Input and output data from coke oven plants in different EU Member States from 2005 complemented by other references	224
Table 5.3:	2004 output data from a Polish coke oven	225
Table 5.4:	Factors for diffuse or fugitive emissions to air caused by battery operation of coke oven plants	227
Table 5.5:	Directed emissions concentrations from coke oven plants in Germany and the Czech Republic	228
Table 5.6:	Estimation of emissions from COG flaring.....	228
Table 5.7:	Emissions factors for directed emissions from coke quenching towers	229
Table 5.8:	Emissions factors for fugitive emissions from by-product plants	229
Table 5.9:	Influent and effluent concentrations and some aspects of waste water treatment systems with the predenitrification-nitrification system	232
Table 5.10:	Composition of waste water of two wet oxidative desulphurisation processes.....	233
Table 5.11:	Main waste/residues from coke oven plants.....	233
Table 5.12:	Information breakdown for each technique described in this section	237
Table 5.13:	Example plants with emission-minimised coke oven charging systems	240
Table 5.14:	Characteristics of several coke oven types	246
Table 5.15:	Measured PAH emissions with variable pressure control	251

Table 5.16:	Emissions from charging and pushing at non-recovery coking without emissions abatement	254
Table 5.17:	Coke oven gas desulphurisation processes and their characteristics.....	261
Table 5.18:	Typical operating and capital costs for the desulphurisation of 42 000 Nm ³ /h of coke oven gas containing 6 g/Nm ³ H ₂ S and 6 Nm ³ NH ₃ of the two main types of coke oven gas desulphurisation techniques used in Europe (ASK and Stretford).....	265
Table 5.19:	Table of example plants for coke oven gas desulphurisation processes	266
Table 5.20:	Dust emissions from a coke stabilisation quenching tower	274
Table 5.21:	Technical data for a pipe conveyor at a coke oven plant in Germany	276
Table 5.22:	Composition of the different waste water flows at Corus, IJmuiden, the Netherlands (2007)	282
Table 5.23:	Effluent concentrations and specific emissions from European coke oven plants using aerobically-activated sludge waste water treatment.....	284
Table 5.24:	Influent and effluent concentrations and some aspects of waste water treatment systems with the predenitrification-nitrification system at four plants.....	285
Table 5.25:	Discharge concentrations for the biological waste water treatment plant at Corus, IJmuiden, the Netherlands (2007) after combined treatment of waste water from the coke oven plant, the blast furnaces and from the sinter plant	286
Table 6.1:	Input data from blast furnaces in different EU member states.....	304
Table 6.2:	Blast furnace output data for 2004.....	305
Table 6.3:	Emissions from coal preparation for injection.....	305
Table 6.4:	Emissions from the charging zone.....	305
Table 6.5:	Emission to air from BF cast house (end-of-pipe).....	306
Table 6.6:	Emission to air for slag granulation in blast furnaces	306
Table 6.7:	Raw blast furnace gas composition (before treatment).....	308
Table 6.8:	Blast furnace gas composition (after two-stage treatment).....	308
Table 6.9:	Emission concentrations from hot stoves	309
Table 6.10:	Emission concentrations from the BF cast house and burden dedusting	310
Table 6.11:	Composition of waste water from BF gas scrubbing before treatment.....	312
Table 6.12:	Pollutant concentrations and emission factors for waste water from blast furnace slag granulation	313
Table 6.13:	Typical composition in (wt-%) of dry coarse dust from BF gas treatment.....	314
Table 6.14:	Typical composition in (wt-%) of sludge from BF gas treatment.....	314
Table 6.15:	Chemical composition in (wt-%) of blast furnace slag for basicity below and above 1.0 and other examples.....	315
Table 6.16:	Example of energy input/output of a blast furnace with high top pressure using coal injection and top gas pressure recovery in 1986.....	316
Table 6.17:	Information breakdown for each technique described in this section.....	318
Table 6.18:	Emission concentrations from the BF cast house and burden dedusting	320
Table 6.19:	Emissions from tar free runner linings.....	326
Table 6.20:	Conditions for Blast Furnace A at Voestalpine Stahl GmbH, Linz, Austria.....	329
Table 6.21:	Reduction in fugitive emissions with a gas recovery system for top hopper release at Voestalpine Stahl GmbH, Blast Furnace A, Linz, Austria	330
Table 6.22:	Operational data from seven German sludge contact plants for the treatment of scrubbing water	331
Table 6.23:	Discharge concentration for waste water from the BF gas scrubbing water circuit after treatment at ArcelorMittal, Bremen, Germany	333
Table 6.24:	Example for the zinc content of hydrocyclonaged blast furnace sludge	334
Table 6.25:	Comparison of residual coke consumption and total coal consumption at different levels of direct injection of pulverised coal.....	340
Table 6.26:	Applied reducing agents at different blast furnaces.....	341
Table 6.27:	Requirements for the composition of plastics used for injection into the blast furnace at Voestalpine Stahl GmbH, Linz, Austria	347
Table 6.28:	Injection rates and substitution factors for different materials injected into the tuyères....	349
Table 7.1:	Main chemical reactions taking place during the oxidation process.....	356
Table 7.2:	Types, number and rated capacities of basic oxygen furnaces (oxygen converters) in operation in the EU	358
Table 7.3:	Input/output-data from 21 existing basic oxygen steelmaking plants in different EU Member States	369
Table 7.4:	Other air pollutants	370
Table 7.5:	Composition and characteristics of BOF gas.....	373
Table 7.6:	Specific emission values to air from a basic oxygen furnace with suppressed combustion after abatement, if there is no other indication.....	374

Table 7.7:	Measurements of roof dust emissions from basic oxygen steelmaking.....	376
Table 7.8:	Kind and specific quantity of solid residues resulting from oxygen steelmaking	378
Table 7.9:	Production of BOF and secondary steel slags	378
Table 7.10:	Chemical composition of slag from hot metal desulphurisation	378
Table 7.11:	Examples of chemical composition of BOF slags.....	379
Table 7.12:	Three examples of the range of mineral constituents of converter slags.....	380
Table 7.13:	Major mineral constituents of secondary metallurgical slags.....	381
Table 7.14:	Range for the chemical composition of secondary steelmaking slags.....	381
Table 7.15:	Composition of coarse and fine dust and sludge	381
Table 7.16:	Composition of mill scale	382
Table 7.17:	Information breakdown for each technique described in this section	385
Table 7.18:	Achieved emission concentrations when using wet air abatement techniques.....	387
Table 7.19:	Data from applied secondary dedusting systems and characteristics for the charging and tapping of emissions.....	390
Table 7.20:	Achievable degree of dust collection from secondary off-gases in basic oxygen steelmaking plants	391
Table 7.21:	Achieved emission levels with secondary dedusting in basic oxygen steelmaking plants.....	391
Table 7.22:	Technical key figures of a secondary dedusting system for Units 1 and 2 at the basic oxygen furnace of Voestalpine Stahl GmbH, Linz, Austria	395
Table 7.23:	Achieved emission levels for two casting installations with bag filter application.....	399
Table 7.24:	Examples for the specific emissions to water from wet dedusting facilities at oxygen steelmaking plants.....	401
Table 7.25:	Overview of specific emissions to water from direct cooling systems at continuous casting	403
Table 7.26:	Example of the concentration of pollutants in waste water from continuous casting after treatment at the basic oxygen furnace at ArcelorMittal, Bremen, Germany	403
Table 7.27:	Advantages and disadvantages of suppressed combustion with particular consideration for BOF gas utilisation.....	410
Table 7.28:	Steam generation at basic oxygen steelmaking plants of Thyssen Stahl AG	410
Table 8.1:	Input/output data for electric arc furnaces within the EU.....	429
Table 8.2:	Systems for the collection of emissions from EAF plants.....	431
Table 8.3:	Air emissions concentrations from the EAF process after abatement	433
Table 8.4:	Specific and annual emissions of PCDD/F and PCB to air from Swedish EAF steel plants	439
Table 8.5:	Emissions from different parts of the secondary metallurgy after abatement	439
Table 8.6:	Kind and specific quantity of solid wastes/by-products from electric arc furnace steelmaking	441
Table 8.7:	Chemical composition of EAF slag from the production of carbon/low alloy steel and stainless/high alloy steel.....	442
Table 8.8:	Fate of EAF slags in the EU	442
Table 8.9:	Concentrations and annual mass flows of PCDD/F and PCB in slag from steel plants using scrap as a raw material	443
Table 8.10:	Chemical composition of EAF dusts from the production of carbon steel/low alloyed steel and high alloyed steel/stainless steel	443
Table 8.11:	Concentrations and annual mass flows of PCDD/F and PCB in dust from four steel plants using scrap as a raw material.....	444
Table 8.12:	Example of annual amount of spent refractory material in one installation	445
Table 8.13:	Information breakdown for each technique described in this section	448
Table 8.14:	Pollution measurements from one installation for an eight year operating period.....	453
Table 8.15:	Process data from selected scrap preheating systems applied to EAF furnaces	455
Table 8.16:	Comparison of dust emissions from the steelwork stacks before and after retrofitting (one steel work in Germany)	459
Table 8.17:	Daily average dust emissions from three EAF installations (2004 – 2006)	461
Table 8.18:	Residual dust and heavy metals concentrations from nine EAF installations after abatement	462
Table 8.19:	Example plants using dust abatement techniques.....	463
Table 8.20:	Dust, PAH and PCDD/F emissions concentrations after abatement	465
Table 8.21:	Performance of post-combustion and rapid cooling at four German EAF	466
Table 8.22:	PCDD/F reduction as a result of pulverised activated lignite coke injection	469
Table 8.23:	Progress in PCDD/F abatement after installation of a second carbon injection system	469
Table 8.24:	Characteristics of different adsorbent and absorption materials.....	470
Table 8.25:	Composition of the waste water flows from direct cooling at BSW, Kehl, Germany after waste water treatment (2008)	472

Table 10.1:	World production of DRI.....	523
Table 10.2:	Characteristics of commercially available direct reduction processes.....	524
Table 10.3:	Relevant performance data of the Corex plant at Iscor's Pretoria Works, South Africa (shutdown and dismantled in 1998).....	527
Table 10.4:	Overview of Corex and Finex sites.....	528
Table 10.5:	Characteristics of the smelting reduction processes under development.....	529
Table 10.6:	Comparison of the conventional blast furnace route with the direct reduction and smelting routes for ironmaking	534
Table 12.1:	Split views	565
Table 13.1:	Detection limits for some environmentally sensitive elements in waste water.....	591
Table 13.2:	Monitoring modes of PCDD/F	594
Table 13.3:	Table of toxic equivalency factors for WHO-12 PCB congeners.....	595
Table 13.4:	Example of template for compiling environmental data in the IS sector.....	597

SCOPE

This BREF for the iron and steel production industry covers the following specified in Annex I to Directive 2010/75/EU, namely:

- activity 1.3: Coke production
- activity 2.1: Metal ore (including sulphide ore) roasting and sintering; and
- activity 2.2: Production of pig iron or steel (primary or secondary fusion) including continuous casting, with a capacity exceeding 2.5 tonnes per hour.

In particular, this BREF covers the following processes:

- the loading, unloading and handling of bulk raw materials
- the blending and mixing of raw materials
- the sintering and pelletisation of iron ore
- the production of coke from coking coal
- the production of hot metal by the blast furnace route, including slag processing
- the production and refining of steel using the basic oxygen process, including upstream ladle desulphurisation, downstream ladle metallurgy and slag processing
- the production of steel by electric arc furnaces, including downstream ladle metallurgy and slag processing
- continuous casting (thin slab/thin strip and direct sheet casting (near-shape))

This BREF does not address the following activities:

- production of lime in kilns, covered by the Cement, Lime and Magnesium Oxide Manufacturing Industries BREF (CLM)
- the treatment of dusts to recover non-ferrous metals (e.g. electric arc furnace dust) and the production of ferroalloys, covered by the Non Ferrous Metals Industries BREF (NFM)
- sulphuric acid plants in coke ovens, covered by the Large Volume Inorganic Chemicals-Ammonia, Acids and Fertilisers Industries (LVIC-AAF BREF). However, a useful description of the main types of coke oven gas desulphurisation processes are provided in this document.

Other reference documents which are of relevance for the activities covered by this BREF are the following:

Reference document s	Activity
Large Combustion Plants BREF (LCP)	Combustion plants with a rated thermal input of 50 MW or more
Ferrous Metals Processing Industry BREF (FMP)	Downstream processes like rolling, pickling, coating, etc.
	Continuous casting to the thin slab/thin strip and direct sheet casting (near-shape)
Emissions from Storage BREF (EFS)	Storage and handling
Industrial Cooling Systems BREF (ICS)	Cooling systems
General Principles of Monitoring (MON)	Emissions and consumptions monitoring
Energy Efficiency BREF (ENE)	General energy efficiency
Economic and Cross-Media Effects (ECM)	Economic and cross-media effects of techniques

This BREF includes new sections for process gas-fired power plants in iron and steel works. However, the information submitted concerning the air emissions of these plants was not considered sufficient to conclude on BAT-AELs for dust, SO₂ NO_x and CO. This issue should be dealt with in a specific chapter of the revised Large Combustion Plants BREF (LCP) [282, EC 2006].

The scope of the BREF does **not** include matters that only concern safety in the workplace or the safety of products because these matters are not covered by the Directive. They are discussed only where they affect matters within the scope of the Directive.

1 GENERAL INFORMATION

1.1 Steel production in Europe and worldwide

[92, Lüngen 1995], [131, Stat Stahl 1997], [250, EC 2006], www.worldsteel.org.

Iron and steel have both played an important role in the development of human civilisation over several millennia and have found uses in agriculture, construction, the generation and distribution of power, the manufacturing of machinery and equipment, in the household and in medicine.

Together with coal and cotton, iron and steel were the principal materials upon which the industrial revolution was based. Technical developments from the early eighteenth century onwards allowed dramatic increases in output, for example by replacing relatively scarce charcoal with hard coal/lignite and coke and by the development of the puddling process for converting hot metal into steel.

The world steel production has increased considerably since 2000 and exceeded 1000 million tonnes for the first time in 2004. In 2006 world steel production rose to a world total of more than 1200 million tonnes (see Figure 1.1). The main reason is that the steel production in China increased from 127 million tonnes to 421 million tonnes in 2006.

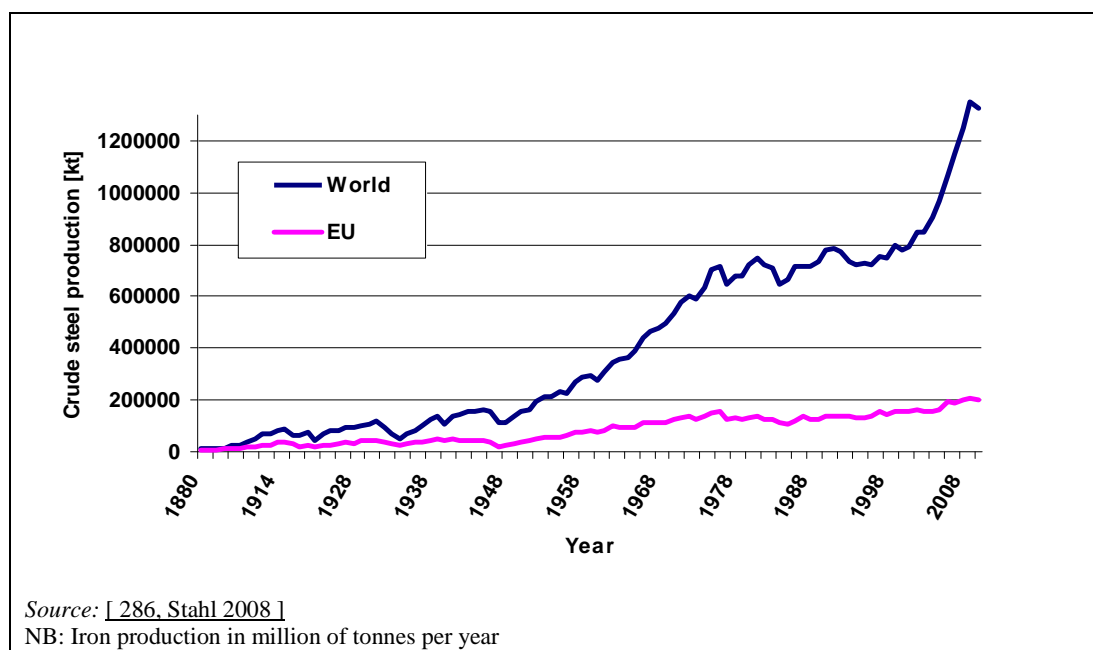

Figure 1.1: Crude steel production in Europe and worldwide since 1870

EU production of crude steel grew at a rate of 1.2 % per year between 1985 and 1994 in terms of volume. Growth was more rapid in the three years from 1986 – 1989 (3.7 % per year). Subsequently, production in the EU-12 declined from 140 million tonnes in 1992 and 1993, before recovering to reach 139 million tonnes in 1994 and 143 million tonnes in 1995. The entry of Austria, Finland and Sweden into the EU brought EU production of crude steel up to 156 million tonnes in 1995. Since the year 2000, the crude steel production has increased worldwide. In 2006, the production of crude steel in the EU was 198 million tonnes, compared with Russia at 120 million tonnes and Japan, the US and China at 116, 99 and 421 million tonnes, respectively.

Figure 1.1 also shows how the European share of the world steel production has steadily declined, falling to a level of 21 % in 1970. Since the oil crisis of 1974 – 75, production was

virtually stagnant worldwide until the middle of the 1990s, with Europe being particularly affected. With 198 million tonnes in 2008, the production of crude steel in the EU was 15 % of the world production [286, Stahl 2008].

Figure 1.2 shows how the production of oxygen steel remained fairly steady, whereas electric arc furnace steel production gradually increased. The share of total steel production of the latter reached 41.8 % in 2006. Nevertheless, the blast furnace/basic oxygen furnace route is predicted to remain the dominant means of steel production, at least in the medium term.

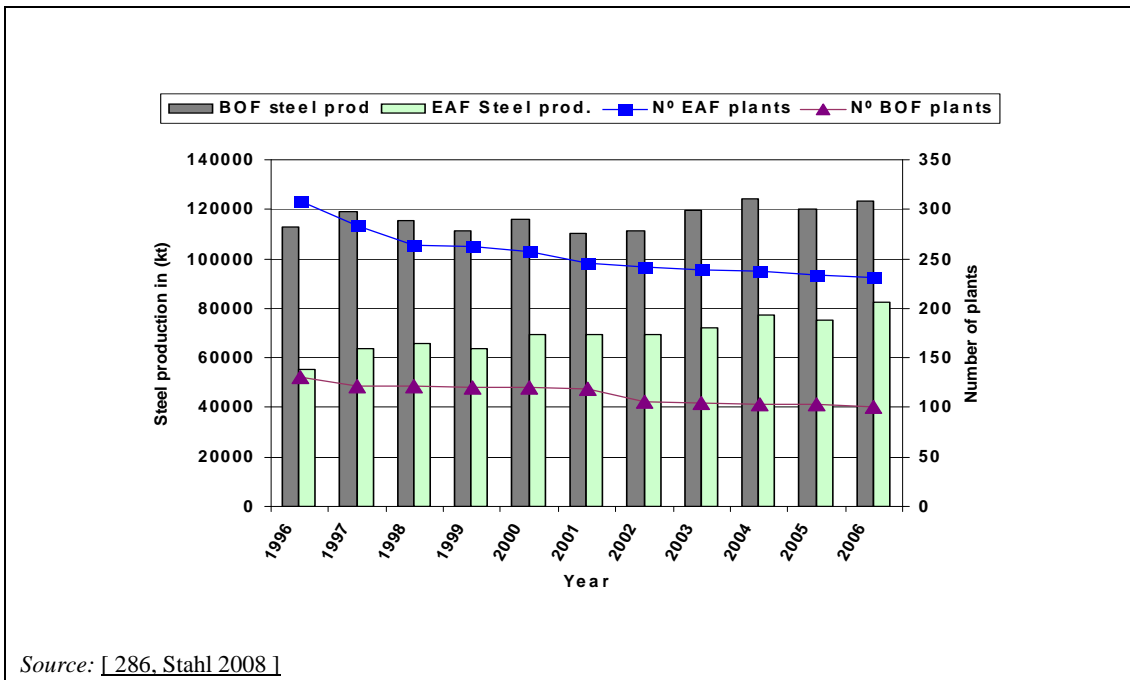

Figure 1.2: Steel production by electric arc furnace and oxygen steel in the EU from 1996 – 2006

1.2 Geographical distribution of iron and steel production in the EU

[200, Commission 2001] [205, Cleary et al. 2005] [207, Ameling et al. 2004] [208, Lindfors et al. 2006] [209, EC 2005] [240, UKEA 2004] [288, IA 2006] [318, Eurofer 2007] [366, Dornseiffer et al. 2007] [403, Poland 2007]

The locations of integrated steelworks in the EU-27 are shown in Figure 1.3, in which the concentration of steelworks along the coal belt in Central Europe is clearly visible. Nevertheless, there are integrated steelworks located in most of the Member States. Electric arc furnaces are not included in Figure 1.3.



Figure 1.3: Geographical distribution of integrated steelworks in the European Union

Table 1.1 to Table 1.6 show the distribution of plants by capacities and other characteristics in the EU-27. In order to give a comprehensive overview, countries without a relevant production are not listed.

Table 1.1: Number and production of sinter and pelletisation installations in the EU-27

EU-27 sinter and pelletisation plants						
EU Member State	Number of iron ore sintering plants	Number of iron ore sinter strands	Strand surface (m ²)	Production (kt/yr)	Number of pelletisation plants	Production (kt/yr)
Austria	2	2	342	3500		
Belgium	4	5	1405	15 300		
Czech Republic ⁽¹⁾	2	9	735	6 500		
Germany	8	12	2 282	29 400		
Spain	1	2	481	5 400		
Finland	1	3	225	2 700		
France ⁽²⁾	5	6	2 013	23 765		
Hungary	2	2	100	900		
Italy	2	7	962	11 500		
Netherlands	1	3	354	4 400	1	4 900 (1)
Poland	2	4	1 161	9 000		
Slovakia ⁽¹⁾	1	4	440	4 100		
Sweden	0				5	22 150 (2)
United Kingdom	3	4	1 328	13 700		
Total	34	63	11 828	130 165	6	27 050
NB: — Data for 2005 — ⁽¹⁾ Data for 2007 — ⁽²⁾ Data for 2008						
Source: [140, Eurofer 2009] [208, Lindfors et al. 2006] [209, EC 2005] [234, Poland 2007] [240, UKEA 2004] [318, Eurofer 2007].						

Table 1.2: Production of coke in the EU-27

EU-27 coke ovens	
EU Member States	Production (kt/yr)
Austria	1 360
Belgium	2 714
Bulgaria	615
Czech Republic	3 231
Germany	8 250
Spain	2 747
Finland	870
France	4 290
Hungary	913
Italy	4 580
Netherlands	2 160
Poland	9 599
Romania	1 804
Sweden	1 182
Slovakia	1 749
United Kingdom	4 276
Total	50 340
NB: Data from 2006.	
Source: [156, Coke oven manager association 2008] [286, Stahl 2008].	

Table 1.3: Number and production of blast furnace installations in the EU-27

EU-27 blast furnaces		
EU Member State	Number of blast furnace installations	Production (kt/yr)
Austria	6	5 547
Belgium	4	7 516
Bulgaria	3	1 147
Czech Republic	6	6 185 ⁽¹⁾
Germany	18	30 360
Spain	2	3 432
Finland	3	3 158
France	10	13 013
Hungary	2	1 336
Italy	6	11 492
Netherlands	2	5 417
Poland	7	5 333
Romania	4	3 975
Sweden	3	3 577
Slovakia	3	4 100 ⁽¹⁾
United Kingdom	7	10 696
Total	86	116 284
NB: Data from 2006. Source: [286, Stahl 2008]; except ⁽¹⁾ [372, Czech TWG member 2008].		

Table 1.4: Number and production of basic oxygen furnace installations in different EU countries

EU-27 basic oxygen furnaces		
EU Member State	Number of basic oxygen installations	Production (kt/yr)
Austria	5	6 487
Belgium	8	8 172
Bulgaria	3	1 155
Czech Republic	4	6 283
Germany	21	32 550
Spain	5	3 601
Finland	8	3 454
France	7	12 242
Hungary	2	1 650
Italy	9	11 823
Netherlands	3	6 223
Poland	6	5 766
Romania	5	4 374
Sweden	3	3 585
Slovakia	4	4 715
United Kingdom	8	11 203
Total	101	123 283
NB: Data from 2006. Source: [286, Stahl 2008].		

Table 1.5: Number and production of EAF steelmaking installations in the EU-27

EU-27 electric arc furnace steelmaking		
EU Member State	Number of EAF installations	Production (kt/yr)
Austria	3	643
Belgium	7	3458
Bulgaria	6	696
Czech Republic	16	578
Germany	42	14674
Greece	7	2416
Spain	28	14790
Finland	3	1600
France	25	7610
Hungary	2	439
Italy	44	19794
Luxembourg	3	2802
Latvia	–	3
Netherlands	2	150
Poland	12	4241
Portugal	2	1400
Romania	7	1889
Sweden	8	1881
Slovenia	3	628
Slovakia	1	378
United Kingdom	10	2666
Total	231	82736
NB: Data from 2006. Source: [286, Stahl 2008].		

Table 1.6: Number and production of continuous casting installations in the EU-27

EU-27 continuous casting	
EU Member State	Production (kt/yr)
Austria	6836
Belgium	11631
Bulgaria	1227
Czech Republic	6145
Germany	45497
Estonia	0
Greece	2416
Spain	18278
Finland	5029
France	18984
Hungary	2085
Italy	30170
Luxembourg	2802
Latvia	548
Netherlands	6213
Poland	8248
Portugal	1380
Romania	5450
Sweden	4779
Slovenia	520
Slovakia	5081
United Kingdom	13652
Total	196971
NB: Data from 2006. Source: [286, Stahl 2008].	

The 1990s were not marked by a mass introduction of radical new technologies in the EU. Rather, the classical methods of production had been refined at various stages (blast furnaces, steelworks, etc.) and were rendered much more efficient through improvements all along the production chain. These improvements allowed significant reductions in energy use and pollution, whilst increasing product quality.

1.3 Economics and employment in the EU iron and steel industry

[27, EC Panorama 1997] [28, ECSC 1951] [200, Commission 2001] [250, EC 2006] [286, Stahl 2008] [291, EC 2006] [292, DGENTR 2007] [293, DGENTR 2007]

The globalisation of the world economy has had a profound effect on the steel industry and continues to do so. The industry is undergoing intensive structural changes. This was characterised during the 1990s and 2000s by the development of new concepts in steel working (e.g. mini-electric steel mills, new concepts for electric arc furnaces, new casting techniques and direct or smelting reduction techniques). Highly competitive market conditions may accelerate this structural change and encourage consolidation in the steel industry. This is evident from the growing number of alliances, cooperative ventures and takeovers. The development of continuous casting had an extremely positive effect on the economics of the steel industry in the 1970s and 1980s.

Steel is a key sector for Europe's economy and competitiveness. With a production of 198 million tonnes, the EU-27 accounted for 15 % of the world steel production in 2008. The annual turnover in the EU steel sector is approximately EUR 150 000 million and the sector employs approximately 440 000 people [184, European Union 2009]. Table 1.7 shows the evolution in employment in the EU-15 during 1996 and 2004.

Table 1.7: Development of employment in the iron and steel industry in the EU from 1996 to 2004

Iron and steel industry in the EU-development of employment from 1996 to 2004 in EU-15		
EU Member State	Number of workers and employees in 1996	Number of workers and employees in 2004
Austria	12 651	11 000
Belgium	22 638	17 700
Germany	114 305	92 660
Denmark	1 170	400
Greece	2 006	2 000
Spain	22 955	21 600
Finland	7 210	8 400
France	38 106	37 000
Ireland	375	NA
Italy	36 226	39 150
Luxembourg	5 196	4 100
Netherlands	12 211	10 400
Portugal	2 231	1 100
Sweden	13 648	18 800
United Kingdom	36 527	20 950
Total	327 455	285 260
NB: NA = Data not available Source: [286, Stahl 2008].		

1.4 Steelmaking process

[60, Hille et al. 1997] [200, Commission 2001]

Four routes are currently used worldwide for the production of steel: the classic blast furnace/basic oxygen furnace route, the direct melting of scrap (electric arc furnace), smelting reduction and direct reduction (see Figure 1.4).

In 2006, the steel production in the EU-27 was based on the blast furnace/basic oxygen route (approximately 59.8 %) and the electric arc furnace (EAF) route (approximately 40.2 %) (see Table 1.4 and Table 1.5). The percentage of world crude steel production via direct reduction (DR) was about 6.8 % in 2006 which corresponds to 59.8 million tonnes direct reduced iron (DRI). Taking into consideration scheduled DRI production sites, the world DRI production will increase to 80 million tonnes by 2010. In Europe, the production of DRI was limited to 704.000 tonnes in 2006 (58.0000 tonnes in Germany and 12.4000 tonnes Sweden), which represented approximately 1.5 % of world output. Consumption of DRI in EAF steelmaking was reported to be 1.523 million tonnes per year in the EU-27 in 2006.

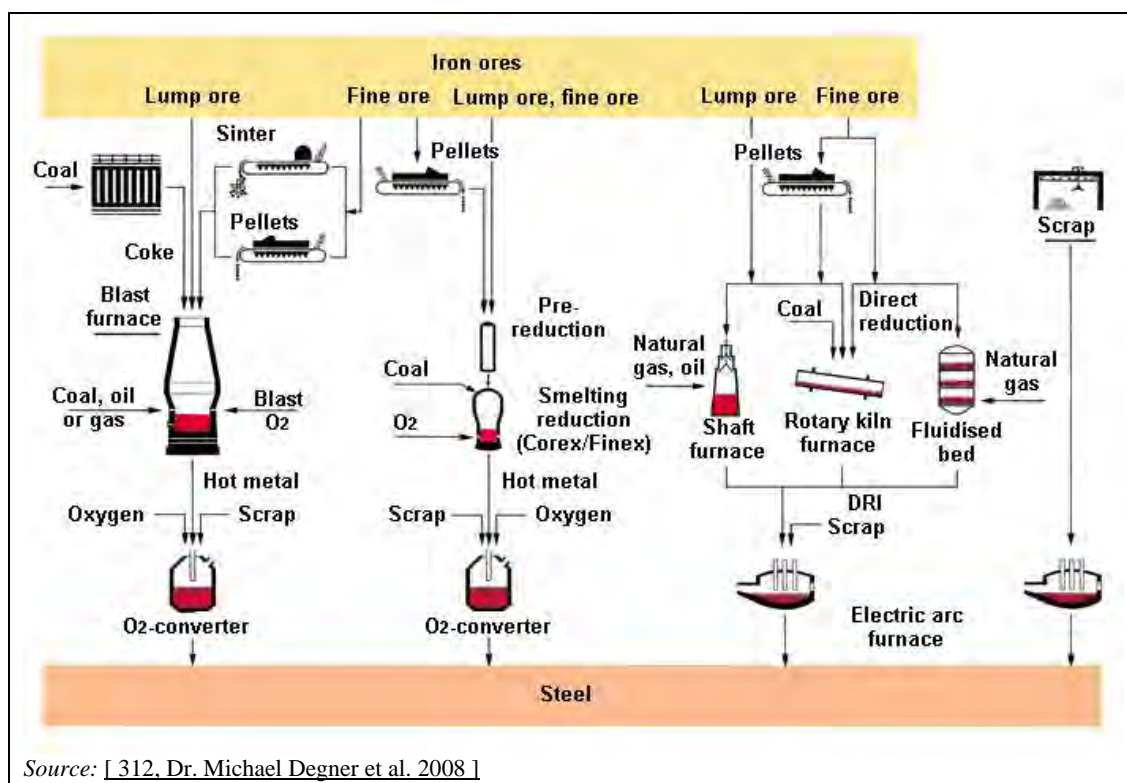

Figure 1.4: Crude steel production methods

By the end of 2007, a total of six smelting reduction plants were in operation, representing an annual aggregate capacity of 7.45 million tonnes hot metal. In the EU-27, there are no smelting reduction units on a commercial scale. These routes are therefore not described here, but will be mentioned in Chapter 10: 'Alternative iron making techniques'.

Integrated steelworks

Of the four steelmaking routes described above, the classic blast furnace/basic oxygen furnace route is by far the most complex, taking place in large industrial complexes known as integrated steelworks, covering areas up to several square kilometres (see Figure 1.5). Integrated steelworks are characterised by networks of interdependent material and energy flows between the various production units, most of which are covered in this document (sinter plants, pelletisation plants, coke oven plants, blast furnaces and basic oxygen steelmaking plants with

subsequent casting). Before describing these individual types of plants in detail, an overview of the interdependencies mentioned will be given.



Source: [200, Commission 2001]

Figure 1.5: Aerial view of an integrated steelworks located near the coast

Process overview

The process routes of an integrated steelworks considered in this BREF are shown in Figure 1.6. This figure gives a schematic view of the main material inputs and outputs of process-related emissions and residues for each stage of the process route.

In an integrated steelworks, the blast furnace is the main operational unit where the primary reduction of oxide ores takes place leading to liquid iron, also called ‘hot metal’. Modern high-performance blast furnaces require physical and metallurgical preparation of the burden. The two types of iron ore preparation plants are the sinter plants and the pellet plants. Pellets are nearly always made from one well-defined iron ore or concentrate at the mine and are transported in this form. In Europe, there is only one integrated steelworks also operating a pelletisation plant. Sinter is generally produced at the ironworks from pre-designed mixtures of fine ores, residues and additives.

The main reducing agents in a blast furnace are coke and pulverised coal forming carbon monoxide and hydrogen which reduce the iron oxides. Coke and coal also partly act as a fuel.

Coke is produced from coal by means of dry distillation in a coke oven and has better physical and chemical characteristics than coal. In many cases, additional reducing agents/fuels are supplied by the injection of oil, natural gas and (in a few cases) plastics. A hot blast provides the necessary oxygen to form the carbon monoxide (CO), which is the basic reducing agent for the iron oxides.

The blast furnace is charged from the top with a burden. This consists of alternate layers of coke and a mixture of sinter and/or pellets, lump ore and fluxes. In the furnace, the iron ore is increasingly reduced and liquid iron and slag are collected at the bottom of the furnace, where they are tapped from.

The slag from the blast furnace is granulated, pelletised, or tapped into slag pits. The slag granules or pellets are usually sold to cement manufacturing companies. Slag from pits can also be used in road construction.

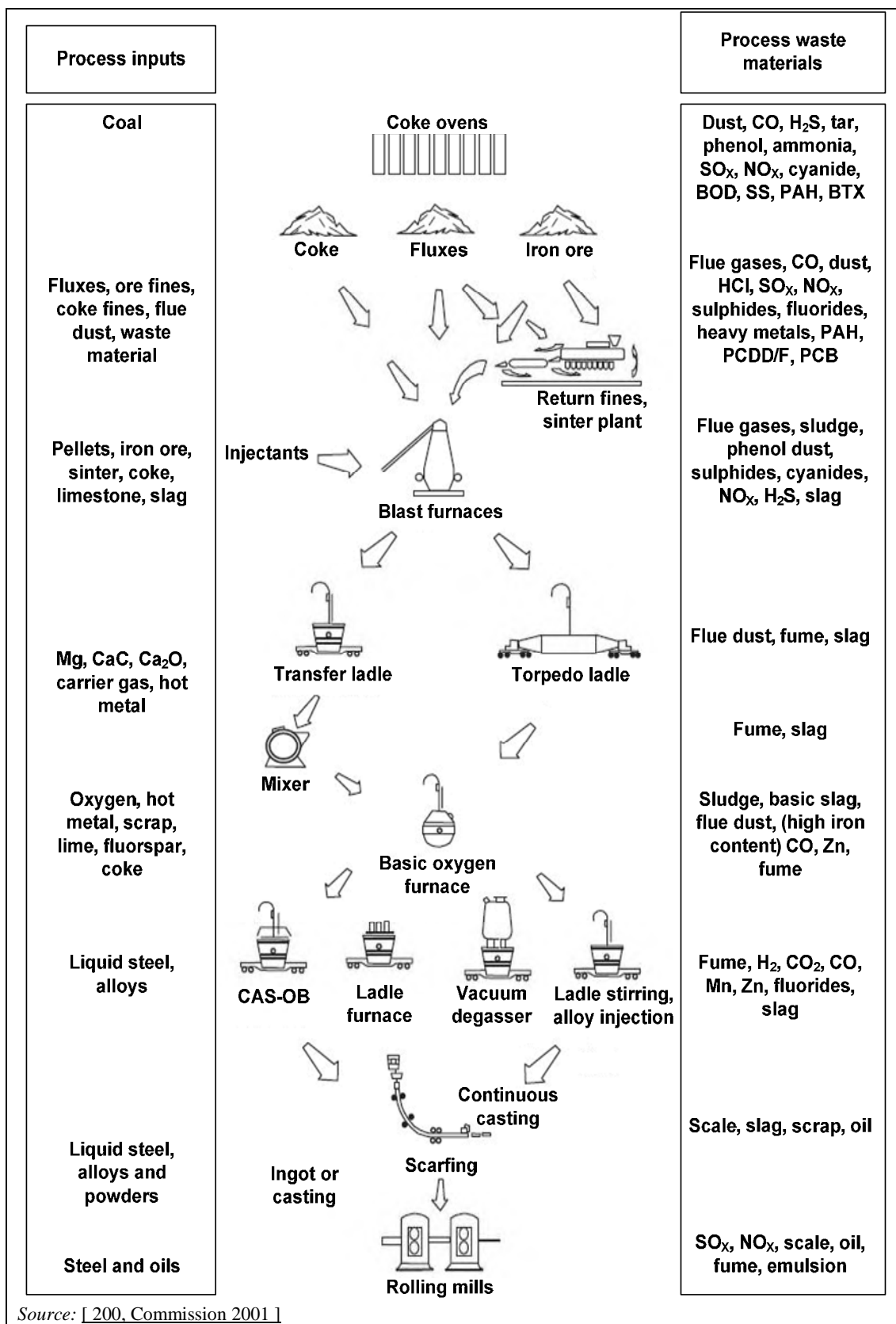

Figure 1.6: Overview of the process routes of an integrated steelworks

The liquid iron from the blast furnace (hot metal) is transported to a basic oxygen furnace, where the carbon content (approximately 4 %) is lowered to less than 1 %, thereby resulting in steel. Upstream ladle desulphurisation of the hot metal and downstream ladle metallurgy of the steel is generally applied in order to produce steel with the required quality. On leaving the

basic oxygen furnace, the liquid steel is cast either into ingots or by means of continuous casting. In some cases vacuum degassing is applied in order to further improve the quality of the steel.

Casting products, whether ingots, slabs, billets or blooms, are subsequently processed in rolling mills and product finishing lines in order to prepare them for the market.

1.5 Main environmental issues in the production of iron and steel

[200, Commission 2001] [240, UKEA 2004] [246, EC 2005] [289, EC 2007] [389, Briggs et al. 2004]

The iron and steel industry is highly intensive in both materials and energy. Figure 1.7 presents a simplified input/output scheme illustrating and numbering the most important mass streams together with the quantity of crude steel produced in the EU-27 in 2006. The overview does not include raw material mining, water and gaseous inputs other than fuels and recycling activities. The figure illustrates that almost half of the input ends up as off-gases, process gases and solid production residues.

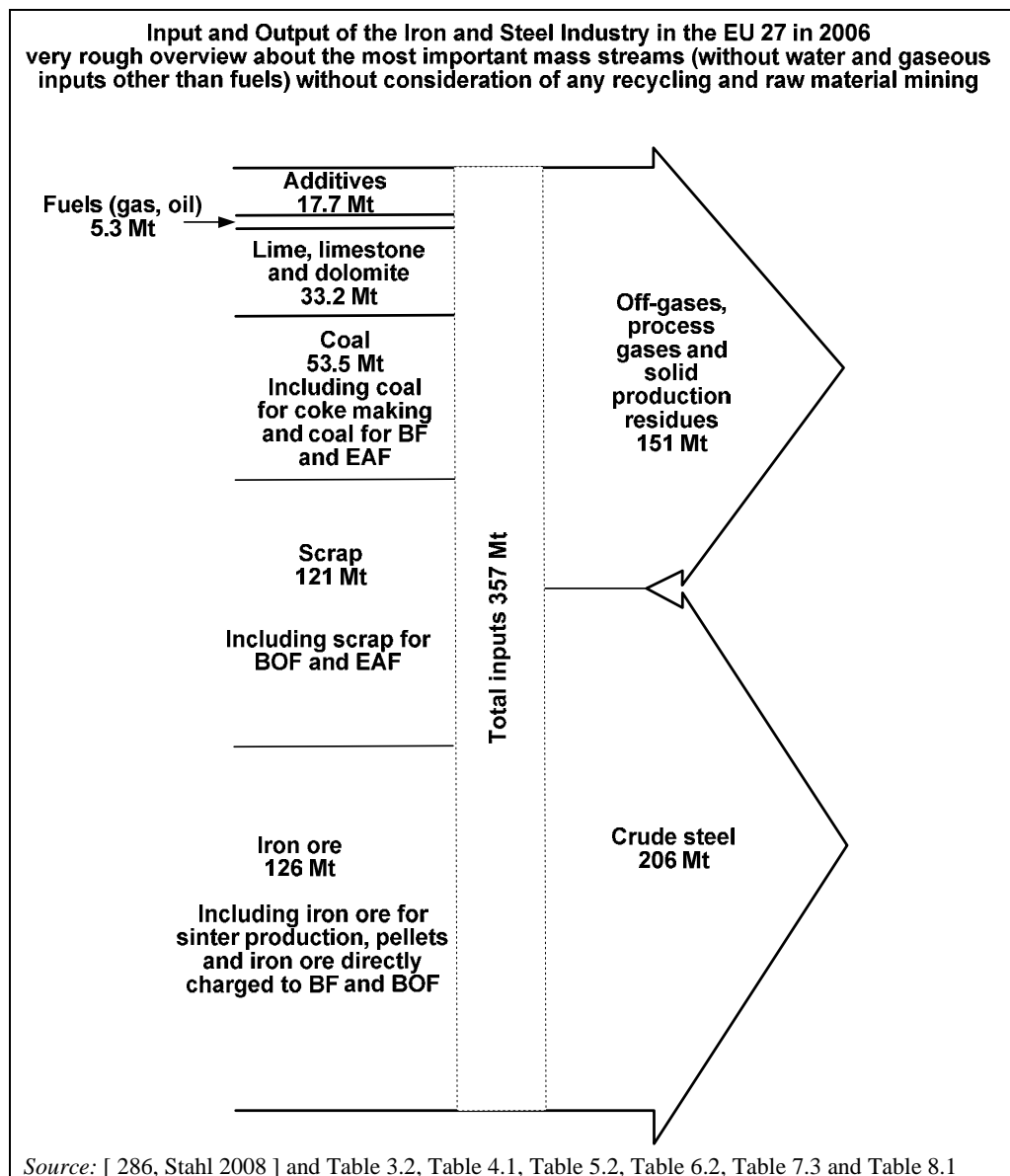

Figure 1.7: Overview of the inputs and outputs for the manufacture of iron and steel in the EU-27 in 2006

Following the two most important steelmaking process routes via the sinter/pellet plant/coke oven/blast furnace/basic oxygen converter and the electric arc furnace, the key environmental issues for action in response to environmental concerns can be summarised below:

- Sinter plants

Sinter, as a product of an agglomeration process of materials which contain iron, represents a major part of the burden of blast furnaces. The main stack emissions of sinter plants account for up to 50 % of the total dust emissions from an integrated steelworks. Other relevant pollutants in the off-gas emissions from the sinter strand and the cooler are heavy metals, SO₂, HCl, HF, PAH and persistent organic pollutants (such as PCB and PCDD/F). Furthermore, the recovery of sensible heat and the utilisation of solid wastes are severe issues. Environmental benefits are linked to this process with the recycling of iron-rich solid by-products of downstream processes and the potential for heat recovery.

- Pelletisation plants

Pelletisation is another process used to agglomerate materials which contain iron where emissions to air dominate the environmental issues. Other main issues in pellet plants are the use of sensible heat, the treatment of waste water and the internal utilisation of process residues.

- Coke oven plants

A coke plant consists of one or more coke oven batteries with a coke oven firing system (under firing) and the process gas treatment unit where emissions to air are the most significant. The main point source for emissions to air is the waste gas from under firing. Additionally, many of the emissions are diffuse emissions from various sources such as the unloading, storage, handling, crushing and blending (preparation) of coal, the leakages from lids and adherences onto frames, oven and leveller doors, the ascension pipes and charging holes of coal into and the pushing of coke out of the chambers, and finally, coke quenching and coke grading (crushing and screening), transport, handling and storage. Diffuse/fugitive VOC emissions to air can occur from coke oven batteries and diffuse/fugitive ammonia and BTX emissions from by-products plants which all have the potential to create odour nuisances. Dust and SO₂ emissions at coke oven plants and other plants where coke oven gas is used as a fuel is a concern. Thus the desulphurisation of coke oven gas is a measure of high priority for minimising these emissions. Waste water disposal is another major issue for coke oven plants. Optimised management of coke oven gas and its use in other processes of integrated plants allow energy savings and minimise air emissions.

- Blast furnace plants

Significant emissions to all media occur where the blast furnace process for producing hot metals from materials which contain iron are used. Because of the high input of reducing agents (mainly coke and coal), this process consumes most of the overall energy input of an integrated steelworks. Relevant emissions to all media occur and these are described in detail. The main environmental issues are dust, waste water from blast furnace gas scrubbing, emissions from slag treatment such as SO₂ and H₂S which can lead to odour nuisances, dusts and sludge, and finally, the minimisation of energy consumption.

- Basic oxygen furnace plants

Emissions to air from various sources such as primary and secondary dedusting, hot metal pre-treatment and secondary steelmaking and various solid process residues are the main environmental issues in oxygen steelmaking. In addition, waste water arises from wet dedusting (when applied) and from continuous casting. Particular attention should be paid to diffuse dust emissions which occur when secondary emission collecting systems are insufficient.

- Electric arc furnace plants

The direct smelting of materials which contain iron (mainly scrap) is usually performed in electric arc furnaces which need considerable amounts of electrical energy and causes substantial emissions to air and solid process residues such as wastes and by-products (mainly filter dust and slag). The emissions to air from the furnace consist of a wide range of inorganic compounds (iron oxide dust and heavy metals) and organic compounds such as persistent organic pollutants (e.g. PCB and PCDD/F).

Energy consumption

Energy consumption in iron and steel making is considerable. CO₂ as a greenhouse gas is generated when energy is consumed. There are many emissions points of CO₂ in the iron and steel processes and they are related to three main factors: a) providing the sufficient temperature in order to carry out the chemical reactions and physical treatment needed, b) providing a reductant (mainly CO) to the system in order to reduce the iron oxide, and c) providing the power and steam necessary to run the steelworks.

The specific energy consumption for steel production in electric arc furnaces in Europe is on average about 1.8 GJ/t liquid steel. Considering the efficiency of energy supply, primary energy consumption will be considerably higher. Additionally there is a fossil fuel input of about 0.5 GJ/t liquid steel on average (according to Table 8.1).

Specifically, because the CO₂ which is generated when energy is consumed is a greenhouse gas (GHG), energy savings have undergone a major change in purpose, and are now considered part of the solution to the problem of global warming which is a global-scale environmental issue.

As mentioned in the IPCC Climate Change Synthesis Report 2007, there is no unique option for climate change mitigating policies. The solution is rather a sequence of mitigating options for the stabilisation of atmospheric greenhouse gas concentrations [40, IPCC 2007].

Regarding iron and steel making, the CO₂ emissions depend very much on the types and amounts of reducing agents (e.g. coke, coal, and oil) used in the blast furnace (see Sections 6.1.3.1 and 6.2.2.4). For this reason, the steel industry has actively implemented a variety of measures to reduce the energy consumption in general and emissions of GHG such as CO₂ in particular. Extensive efforts have been made to reduce the reducing agent demand close to the stoichiometric minimum demand (see Section 6.3). Since 1980 the specific energy demand has been reduced from 23 GJ/t of liquid steel to approximately 18 GJ/t liquid steel in 2004 for modern integrated steelworks [35, Dr. Luengen, H.B. 2005].

The energy consumption has been constantly reduced by introducing energy-saving equipment in steel manufacturing processes and improving the efficiency of energy conversion facilities such as power plants. Energy-saving equipment includes waste energy recovery equipment. Another measure is the optimisation of energy consumption and costs by the implementation of a total energy management system. All of these measures are covered in this document.

To a certain extent, direct reduction (DR) can be an option to reduce CO₂ emissions (see Section 10.1).

Additionally, beyond energy savings and efficiency improvements, carbon dioxide mitigation projects are being developed to capture and store CO₂ which are also covered in this document (see Sections 11.1.1 and 11.1.2)

Other issues

Other relevant issues covered in this document are nuisance by odour and noise emissions which can be quite considerable for certain processes.

Matters of concern for the iron and steel industry not covered by this document are local soil pollution and groundwater pollution.

Table 1.8 to Table 1.10 provide a detailed overview of the releases in the different parts of the iron and steel making processes.

Table 1.8: First table showing potential release routes for prescribed substances and other substances that may cause environmental harm

SOURCES → RELEASES ↓	Raw material handling	Sinter plant: flue-gas cleaning	Sinter plant: secondary emissions	Pellet plants	Coal pulverisation	Hot blast stoves	Stockhouse	Blast furnace primary gas cleaning	Cast-house	Desulphurisation	BOF: blowing (primary emissions)	BOF: charging/tapping (secondary emissions)	EAF: charging	EAF: melting and refining	EAF: steel and slag tapping
	Oxides of sulphur		A		A		A			A	A	A		A	A
Oxides of nitrogen		A		A		A							A	A	
Carbon dioxide		A		A		A		A		A	A	A	A	A	
Carbon monoxide		A		A		A		A		A	A		A	A	
Hydrogen chloride		A		A								A	A		
Hydrogen fluoride		A		A										A	
Hydrogen sulphide								A							
Ammonia								w							
Oxides of iron	Aw	A	A	A			A	A	A	A	A	A	A	A	A
Alkali metals		A	A	A				A	A	AL	A	A			
Alkaline earth metals		A	A	A			A	A	A	AL	A	A			
Metal oxide particulates	Aw	A	A	A			A	A	A	A	A	A			
Non-metallic particulates	Aw	A	A	A	A		A	A	A	A	A	A			
Metallic iron												A			
Inorganic fluorides			A	A				A			A	A			
Hydrogen cyanide								w							
Cadmium and cadmium oxide	W	A		A				A			A	A	A	A	
Zinc, lead and their oxides	w	A		A				A			A	A	A	A	
Other metals and their oxides	Aw		A	A									A	A	A
Phosphorus compounds								wl			Awl				
Sulphur										l	A				
Carbon								A				A			
Other inorganic chemicals	A W												A	A	
Oils and greases	w														
Slag								Ll			Ll			Ll	Ll
Sludges								wLl		Ll	wLl				
Refractory waste	Aw														
PCDD/F		A		a								A	A	A	
PAH		A												A	
PCB		A												A	
Volatile organic compounds		A		a				A				A		A	

NB: — Main polluting substances: A = Release to air
W = Release to water
L = Release to land

— Other substances: a = Release to air
w = Release to water
l = Release to land

— Substances include their compounds except where a separate reference to the compound is made. Releases to air may also be released to land or water, depending upon the abatement technique employed, e.g. via collected dusts, sludges or liquors.

Table 1.9: Second table showing potential release routes for prescribed substances and other substances that may cause environmental harm

SOURCES → RELEASES ↓	EAF: furnace and ladle lining repairs	Alloying	Ladle treatment	Reladling and recarburisation	Degassing	Decarburisation	Electroslag remelting	Vacuum induction melting	Induction melting	Ferrous alloy powders	Continuous casting	Ingot casting	Scarfing	Slag processing	Skull burning
	Oxides of sulphur		A	A						A					A
Oxides of nitrogen			A						A						
Carbon dioxide			A	A		A			A				A		
Carbon monoxide			A	A		A			A						
Hydrogen chloride															
Hydrogen fluoride			A				A								
Hydrogen sulphide														A	
Ammonia															
Oxides of iron	Al	A	A	A		A	l		A		Awl	Al	Awl	wl	Al
Alkali metals														wL	AL
Alkaline earth metals														wL	AL
Metal oxide particulates											Awl	Al	Awl	wl	Al
Non-metallic particulates														wl	
Metallic iron	Al									A				wl	
Inorganic fluorides	Al	A													
Hydrogen cyanide	AlI	A													
Cadmium and Cadmium oxide					Wl	A	l								
Zinc, lead and their oxides					wl	A	l				Awl	Al	Awl		Al
Other metals and their oxides			A	A	wLl	A	Ll			A	Awl		Awl		AlI
Phosphorus compounds			A												
Sulphur														wl	
Carbon															
Other inorganic chemicals	Al	AlI	A												
Oils and greases											w				
Slag waste	Al		Ll	AlI	l	Ll		Ll	Ll		Ll	Ll		Ll	Ll
Sludges													wl		
Refractory waste	AlI				l	Ll	Ll	Ll	Ll		Ll	Ll		Ll	
PCDD/F															
Volatile organic compounds															

NB: — Main polluting substances: A = Release to air
W = Release to water
L = Release to land
— Other substances:
a = Release to air
w = Release to water
l = Release to land
— Substances include their compounds except where a separate reference to the compound is made. Releases to air may also be released to land or water, depending upon the abatement technique employed, e.g. via collected dusts, sludges or liquors.

Table 1.10: Third table showing potential emission releases from prescribed substances and other substances that may cause environmental harm

SOURCES → RELEASES ↓	Charging emissions	Tops leakage	Door leakage	Pushing emissions	Coke oven flue-gas (battery stack)	Emergency venting	Emergency flaring	Ammonia incinerator tail gas	Effluent treatment discharge	Effluent treatment sludge	Sulphur and scrubber liquor removal and desulphurisation	Decanters and storage tank vents
	Particulates	A	A	A	A	A	A	A	A			
Sulphur dioxide				A	A		A	A				
Hydrogen sulphide		A	A	A		A						A
Oxides of nitrogen				A	A		A	A				
BTX		A	A	A		A					A	A
PAH	a	a	A	A		A						a
VOC	A	A	A	A	a						A	A
Phenols		A	A	A		A					A	A
Methane	A	A	A	A		A						A
Carbon monoxide	A	A	A	A	A	A						
Tar fume		A	A	A		A	A	A				
Hydrogen cyanide		A	A	A		A						A
Suspended solids									w			
Ammonia	A	A	A	A		A			w			
Cyanide									w			
SCN									w			
Metals									W	l	l	
Sulphur											l	

NB: — Main polluting substances: A = Release to air
W = Release to water
L = Release to land

— Other substances:
a = Release to air
w = Release to water
l = Release to land

— Substances include their compounds except where a separate reference to the compound is made. Releases to air may also be released to land or water, depending upon the abatement technique employed, e.g. via collected dusts, sludges or liquors.

Source: [240, UKEA 2004] Additions: [110, Brouhon 2008] [318, Eurofer 2007].

Table 13.4 in Section 13.5 Annex V is an example of a template for compiling relevant environmental data in the iron and steel sector.

2 GENERAL PROCESSES AND TECHNIQUES

The process overview in Figure 1.6 shows the various production units of an integrated steelworks. The individual units are connected both in terms of product flows and internal flows of residues (mill scale, filter dusts, sludges from scrubbing BF gas or BOF gas, etc.), water (common treatment of various waste water streams, cascade usage of cooling water, etc.) and energy (COG, BF gas, BOF gas, steam from BF top pressure turbines or BOF process, etc.). These interdependencies have been installed in order to both minimise emissions and to optimise productivity and reduce costs.

These interdependency issues from the different production processes/units in terms of energy, by-products/residues, air and water are covered in this chapter.

2.1 Energy management in the steelmaking industry

[241, Poland 2007] [277, Wiesenberger 2007] [281, Eurofer 2007] [375, IISI 1998]

Specific energy issues have been covered in each process-specific chapter (i.e. Chapters 3 – 8). However, this section serves to show the energy interdependencies between the different processes in an integrated steelworks.

2.1.1 Energy flow and process gas utilisation in integrated steelworks

Energy interdependency in an integrated steelworks can be complex. Figure 2.2 illustrates an example of the input and output flows of different types of energy and reducing agents together with the internal energy flow of an integrated steelworks.

The dominant inputs are coal, heavy oil and, if bought from an external supply, coke. These inputs are mainly used for the production of coke in the coke oven plant and as reducing agents in the blast furnace. It is common to use alternative reducing agents in the blast furnace, such as coal, coal tar or oil that are injected to the blast furnace at the tuyère level. Used oils, fats, various gases (e.g. coke oven gas) and other hydrocarbons, such as waste plastics, may also be injected (see Section 6.3.12).

The quality (calorific value and cleanliness) and volume of the different gases vary significantly and these factors have an impact on where the fuels can be usefully used. To optimise energy efficiency, it is necessary that each fuel gas is consumed at the most appropriate plant.

The primary task of energy management in the steel industry is the efficient distribution and use of the process gases and purchased fuels. A good plant layout can further facilitate this task. Coke oven gas (COG), blast furnace gas (BF gas) and basic oxygen furnace gas (BOF gas) constitute the basis of the energy system in an integrated steelworks. Most of the energy demand is satisfied by these gases; the remaining part must be balanced with purchased energy, normally electrical power and natural gas. These aspects are illustrated in Figure 2.1 and Figure 2.2.

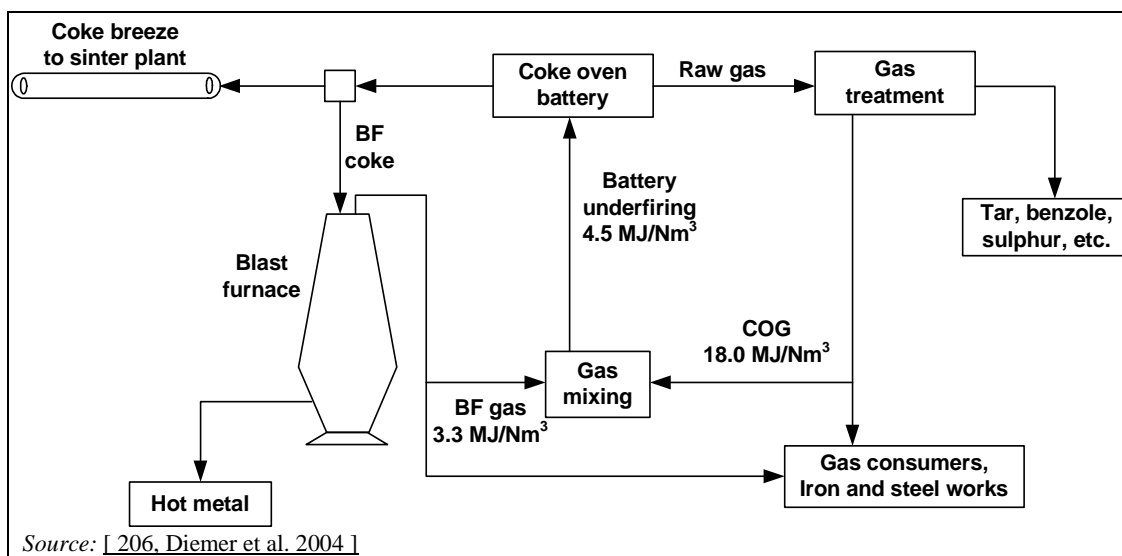

Figure 2.1: Flow sheet of typical gas utilisation in integrated sinter, coke and hot metal production

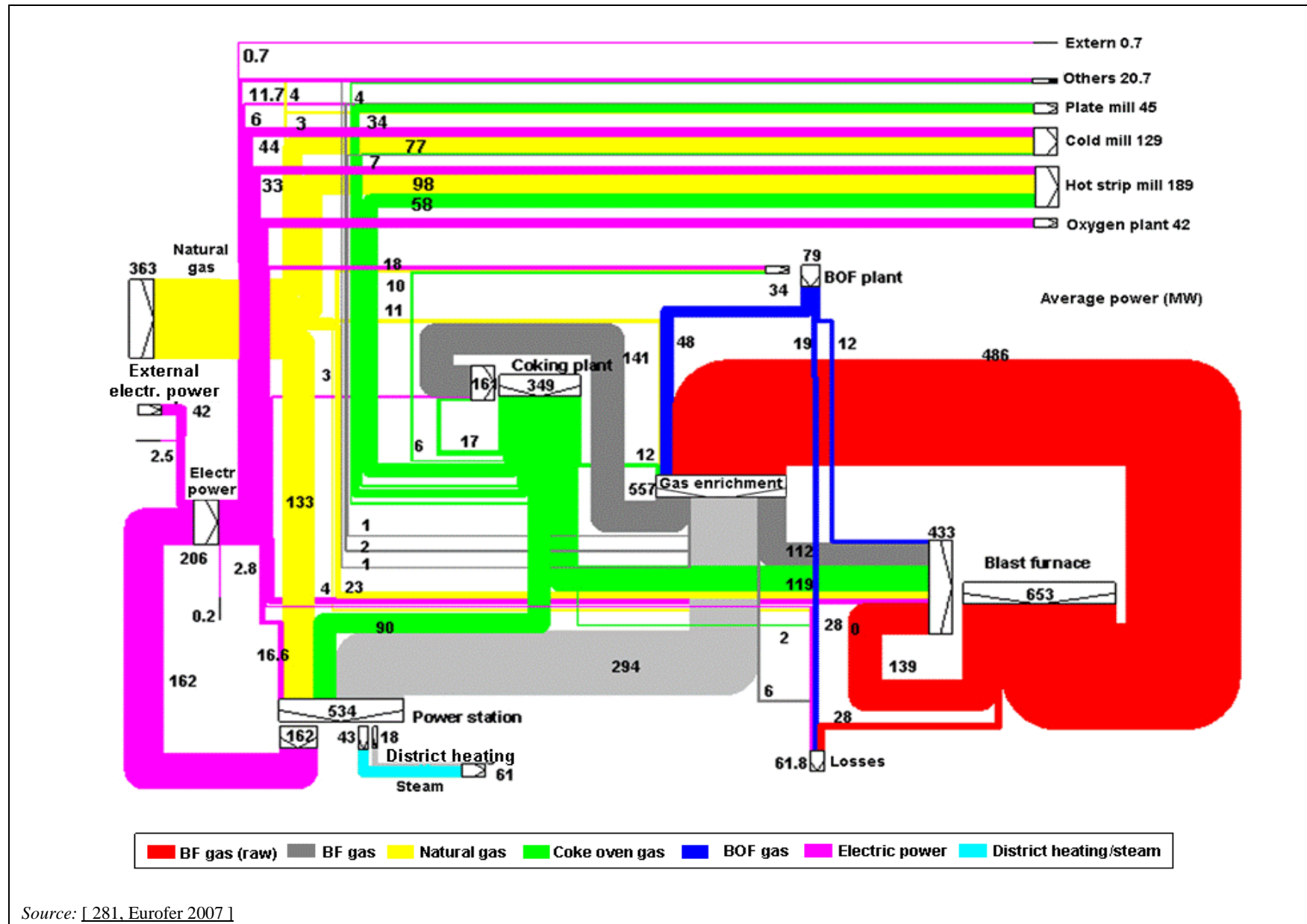

Figure 2.2: Example of the energy flow in an integrated steelworks

Fuels in integrated steelworks

Coke oven gas (COG)

COG generated during carburisation (coking) is usually cleaned before using it as a fuel gas. Cleaning includes the removal of tar, naphthalene, light oil, compounds which contain sulphur and the removal or cracking (to hydrogen) of ammonia. As Figure 2.3 indicates, in integrated steelworks, there are several options for using COG. Since it has the highest calorific value of all process gases, it is usually used to enrich the calorific value of the other process gases for use in blast furnace stoves and at the reheating furnaces of the hot strip mills and other high-temperature processes or for the under firing of the coke ovens. The surplus COG may be utilised at the blast furnace as an alternative reducing agent (see Section 6.3.12.3) and also used in power plants. Examples of the uses of COG in an integrated steelworks is shown in Figure 2.3.

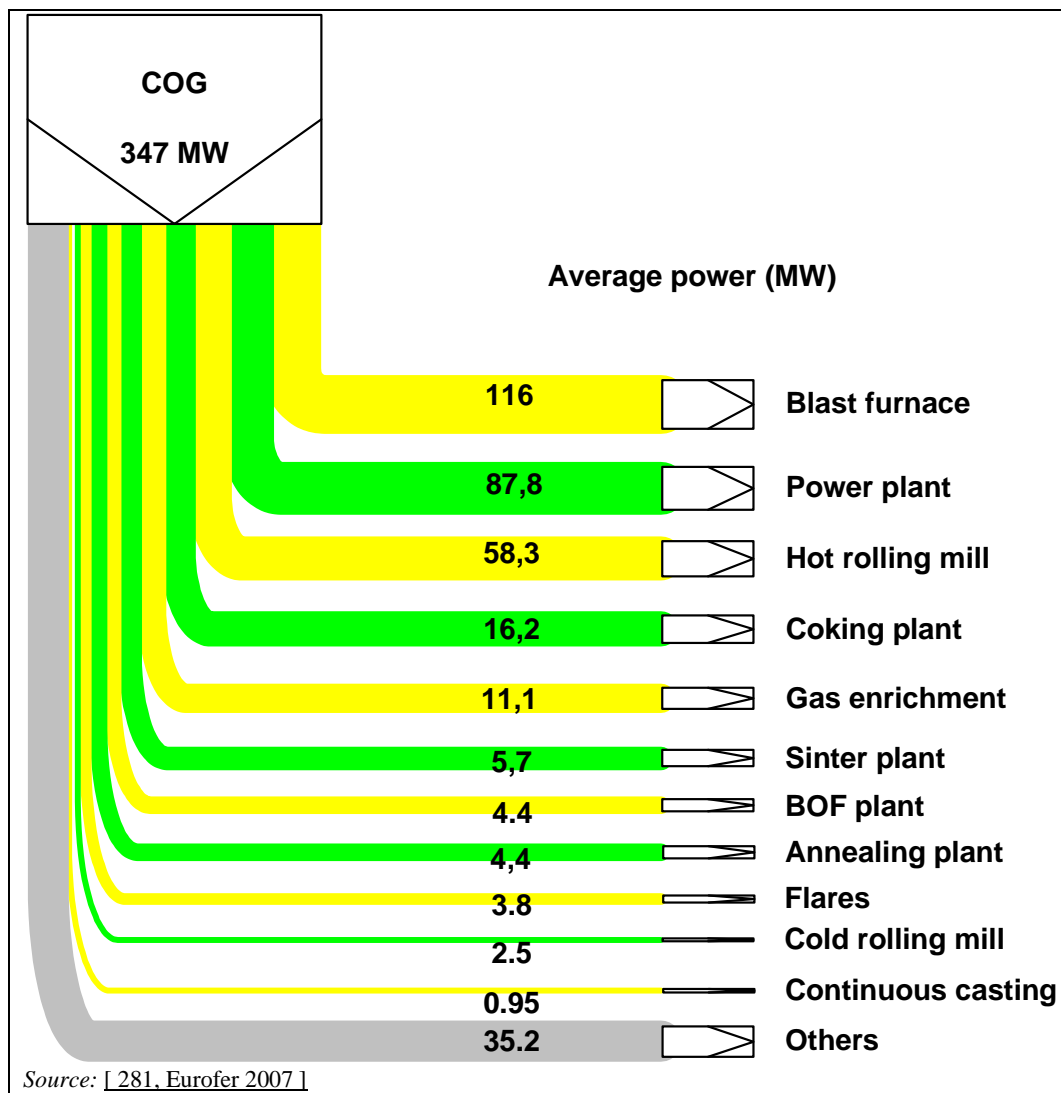

Figure 2.3: Example of use of the coke oven gas in an integrated steelworks

Blast furnace and basic oxygen furnace gases (BF gas and BOF gas)

Blast furnace gas is the gas with the lowest calorific value and flame temperature. As a consequence, it is most appropriately used in low-temperature processes such as the blast furnace itself (hot blast stoves) and the coke oven plant (under firing). The stoves of the blast furnace can be heated exclusively on BF gas. Any remaining BF gas can be used in the power plant to produce electrical power and process steam. BOF gas can be used as an enrichment gas

in order to improve the calorific value of the BF gas. An example of the flows of both BF and BOF gases is presented in Figure 2.4.

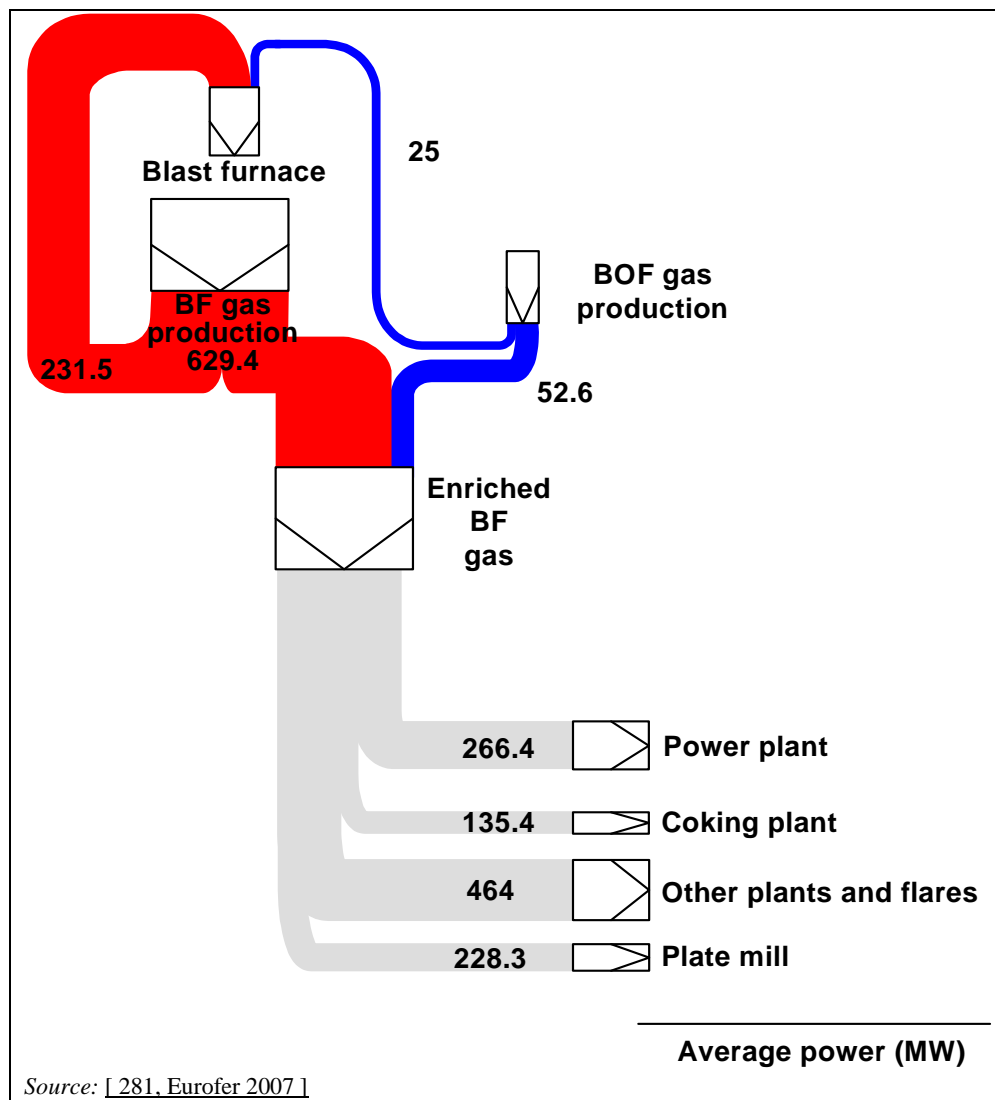

Figure 2.4: Example of BF and BOF gas flow in an integrated steelworks

Gas generated during the BOF process consists mainly of carbon monoxide. The gas is cleaned or scrubbed in the cleaning plant. After the gas is cleaned, it is fed to the BOF gas recovery installation. The installation consists of a cooling station, surge tank and gas pumping station. After BOF gas is mixed with BF gas, it is burnt in the rolling mill or combined heat and power (CHP) plants.

2.1.2 Steam and heat management in integrated steelworks

In an integrated steelworks, there is a need for steam, on the one hand, for heating purposes. On the other hand, steam is needed for specific processes. The most important process steam consumers are blast furnace operations, the coking plant (steam turbine for gas exhausting, for example) and for vacuum treatment in the steel plant. Other activities, not covered in this document, such as for cleaning processes at the galvanising and annealing plants and pre-treatment in the pickling plants also consume steam.

Where appropriate and feasible, it should be possible to produce most of the steam demand by heat recovery. There are many sources such as gas treatment in the coking plant (e.g. sulphuric acid plant) and suppressed combustion systems in combination with waste heat boilers at the BOF plant. Other activities such as hot rolling (e.g. evaporative skid cooling in walking beam furnaces, boilers in pusher-type furnaces) and the use of reheating furnaces (e.g. continuous annealing line, continuous galvanising), are not covered in this document, but are also places where steam may be generated. The heat should ideally be recovered as steam at as high a temperature and pressure as possible. The amount of waste heat recovered is basically dependent on the continuous demand for steam. In some cases, the delivery of waste heat to district heating networks has a positive influence on the amount of waste heat recovered.

In order to achieve a suitable steam supply, it is necessary to have a backup system for steam production in order to supply the steam demand when the plants are off for maintenance, for example. The power plant can often be used to fulfil this role and additionally to control the pressure in the steam grid.

Heating for offices and occupied areas of the plant can be provided by the steam grid obviating the need for a separate heating system. An example of steam production and the use of industrial waste heat in an integrated steel plant is shown in Figure 2.5.

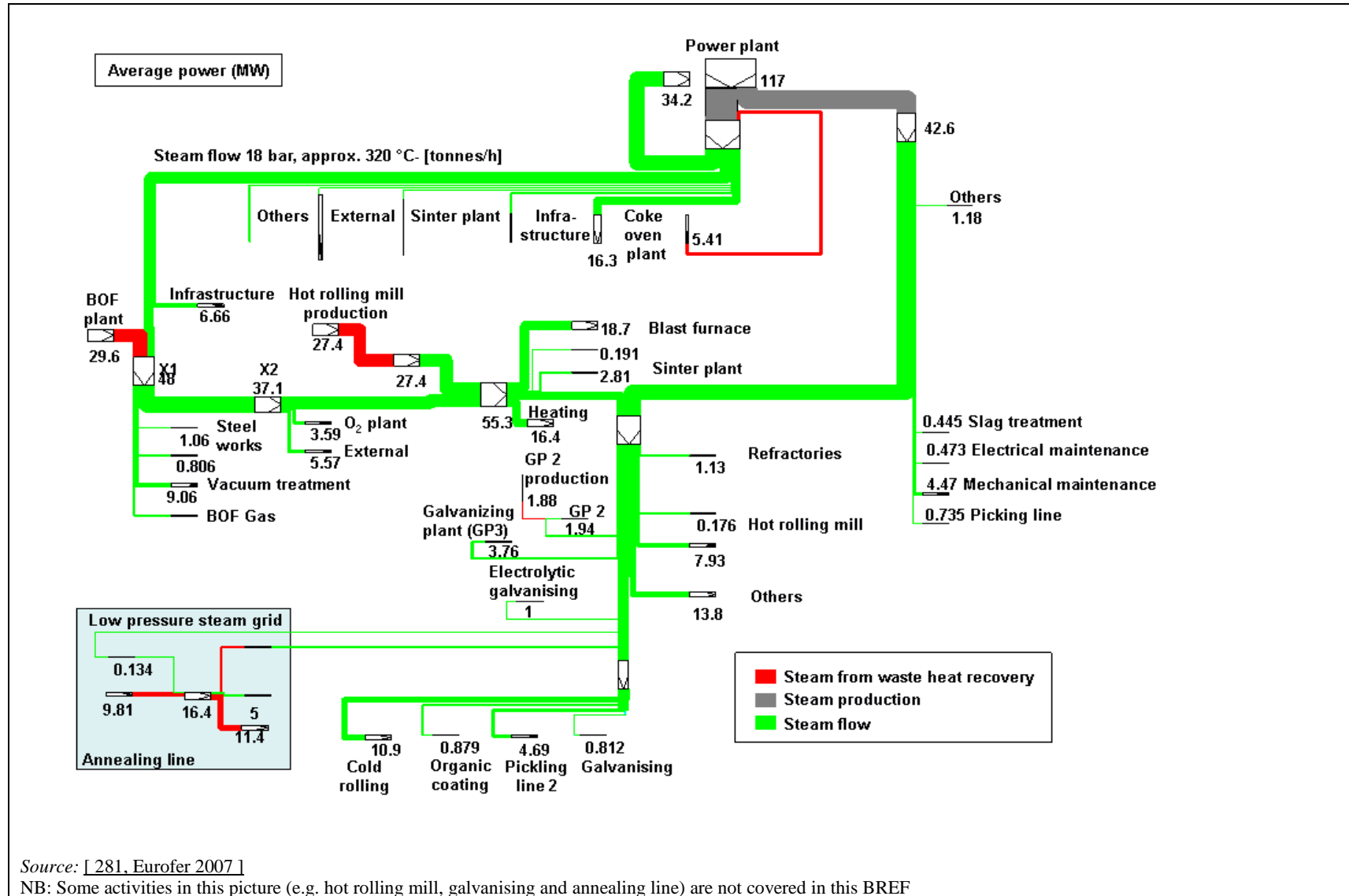

Figure 2.5: Example of steam production and the use of industrial waste heat in an integrated steel plant

2.1.3 Energy flow in EAF steelmaking

In EAF steelmaking plants, heat recovery can be applied in a similar way to cooling systems. Depending on the suitability of existing systems and demand, this energy can be used either for internal or local external heating purposes. More information can be found in the Industrial Cooling Systems BREF (ICS) [[41, European Commission 2001](#)].

2.2 Power plants in iron and steel works

Reference should be made to the BREF on Large Combustion Plants (LCP) [282, EC 2006]. The LCP BREF contains extensive information related to applied techniques and abatement measures for large combustion plants when using commercial fuels such as natural gas.

Power plants (Figure 2.6 shows a typical power plant of an integrated steelworks) play an important role in an integrated steelworks as they consume the excess process gases and provide the necessary steam and power to all the key processes. These fuels (BF gas, COG and BOF gas) are, of course, also used in other areas of the integrated works and, in order to supplement these fuels, most integrated steelworks also utilise purchased fuels (oil and natural gas, for example) in the power plant.

The power plant can utilise both low calorific and high calorific gases. Dependent on the energy situation of a plant, the power plant can be set up to produce electrical power, steam and/or district heat. Where appropriate and feasible, additional electrical power can be generated at the blast furnace plant with a top gas recovery turbine (see Section 6.3.13).



Source: [281, Eurofer 2007]

Figure 2.6: View of a power plant in an integrated steelworks

2.2.1.1 Applied processes and techniques

Within the constraints identified above, the efficient use of process gases from iron and steel works in a power plant in an integrated steelworks is usually realised in gas-fired boilers or gas turbines (in combined cycle gas turbines).

Gas-fired boiler

Figure 2.7 shows a typical gas-fired boiler/generator arrangement with a steam turbine in a steelworks.

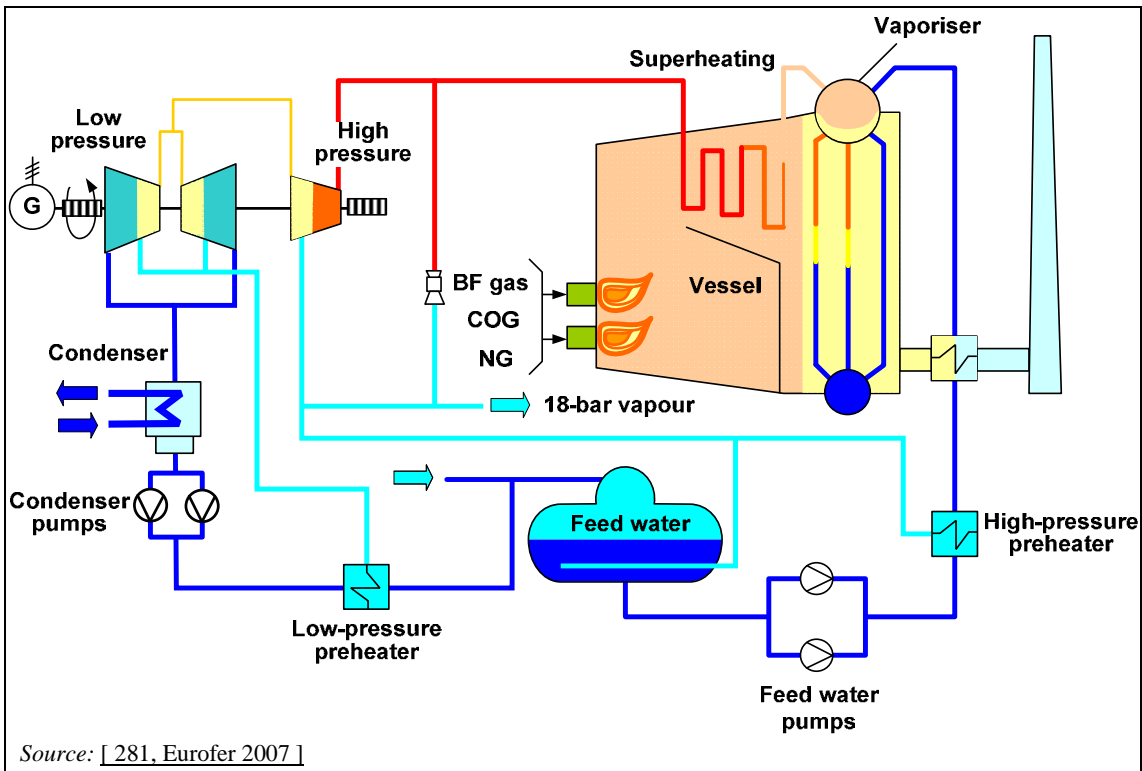

Figure 2.7: A boiler/generator arrangement (40 MW_e)

This relatively simple arrangement can achieve a high level of availability and is designed to use process gases with a low calorific value (CV) (mainly BF gas). For the same thermal input, a higher volume of this low CV gas has to be used compared, for example, to natural gas and consequently the volume of waste gas will be correspondingly higher. Additionally, the use of COG results in a higher waste gas temperature. The energy efficiency of such a combination is about 15 – 20 % lower compared with a commercial power station. Table 2.1 and Table 2.2 show examples of efficiency values when using low CV gas.

Table 2.1: Efficiency of gas-fired boilers when using low calorific value gas

Plant type	Electrical efficiency (%)		Fuel utilisation (%)
	Existing plant	New plant	New and existing plants
Gas-fired boiler	24 – 41	34 – 44 ⁽¹⁾ 34 – 42 ⁽²⁾	54 – 56 ⁽²⁾

⁽¹⁾ Higher values of electrical efficiency are observed in the case of natural gas-fired plants predominantly and electricity production only.
⁽²⁾ With additional heat production (40 MW), the upper value for electrical efficiency is reduced to about 42 %. In this case, the fuel utilisation is about 54 – 56 %.

Source: [281, Eurofer 2007].

Most power stations using process gases are operated in a combined heat and power (CHP) mode, also called ‘cogeneration’. This reflects the use of a heat engine or a power station to simultaneously generate both electricity and useful heat. The overall fuel efficiency can be optimised by generating electricity and decoupling heat for industrial processes and/or district heating. Since most integrated steelworks sites have a surplus of heat, there is often no internal demand. If there are no private or commercial consumers available to use decoupled heat, power plants are operated to combust the surplus gases aiming to maximise the amount of electrical

energy. Figure 2.8 shows an example of a larger boiler with the reheating and decoupling of heat for district heating.

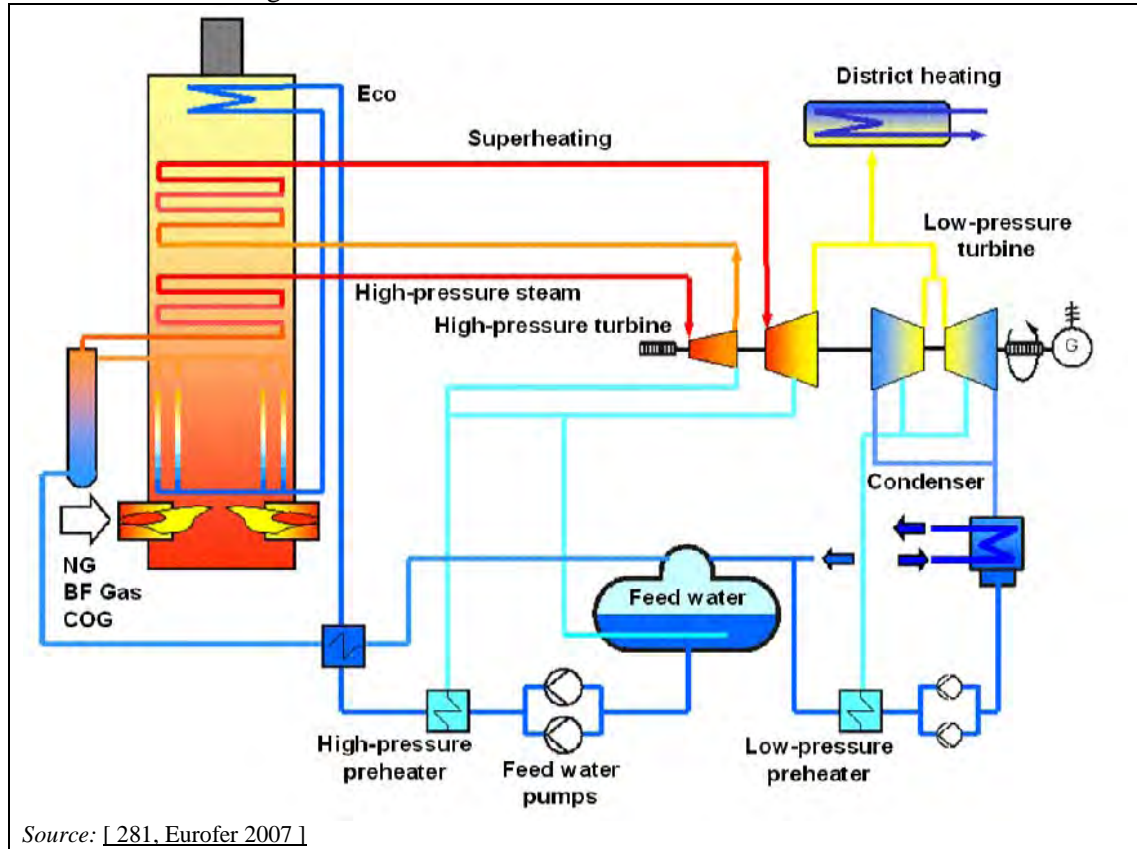

Figure 2.8: Example of a boiler/generator arrangement with reheating (85 MW_e)

Gas turbines

Gas turbines fired with process gases are usually not used in Europe because of the low calorific value of the gases. In addition, there are various problems with cleaning and operation as a consequence of using such feed gases.

More information on this issue is available in the Large Combustion Plants BREF (LCP) [282, EC 2006].

Process gases are normally not applied for single gas turbines. Natural gas is the fuel of choice for gas turbines. In order to improve the efficiency, these turbines are coupled with a heat recovery boiler with additional firing using process gases. The heat is used to make steam to generate additional electricity via a steam turbine. Such an arrangement is called combined cycle power plant (CCPP) or combined cycle gas turbines (CCGT). It can be operated in different modes for the generation of electricity only, and in CHP mode. In a CCPP or CCGT plant, a gas turbine generator generates electricity and this last step enhances the efficiency of electricity generation.

Table 2.2: Efficiency of combined cycle gas turbine when using low calorific value gas from iron and steel works.

Plant type	Electrical efficiency (%)		Fuel utilisation (%)
	Existing plant	New plant	New and existing plants
CCGT			
Combined cycle for electricity only	No data provided	No data provided	No data provided
Combined cycle in CHP mode	46 ⁽¹⁾	No data provided	45 – 55 60 ⁽²⁾

⁽¹⁾ If the maximum range of electricity is produced.
⁽²⁾ If the maximum range of steam is produced.
 Source: [281, Eurofer 2007].

Figure 2.9 shows a gas turbine with a heat recovery boiler and supplementary firing, which is operated in combined cycle in CHP mode. In this configuration, an electrical efficiency of 46 % can be obtained.

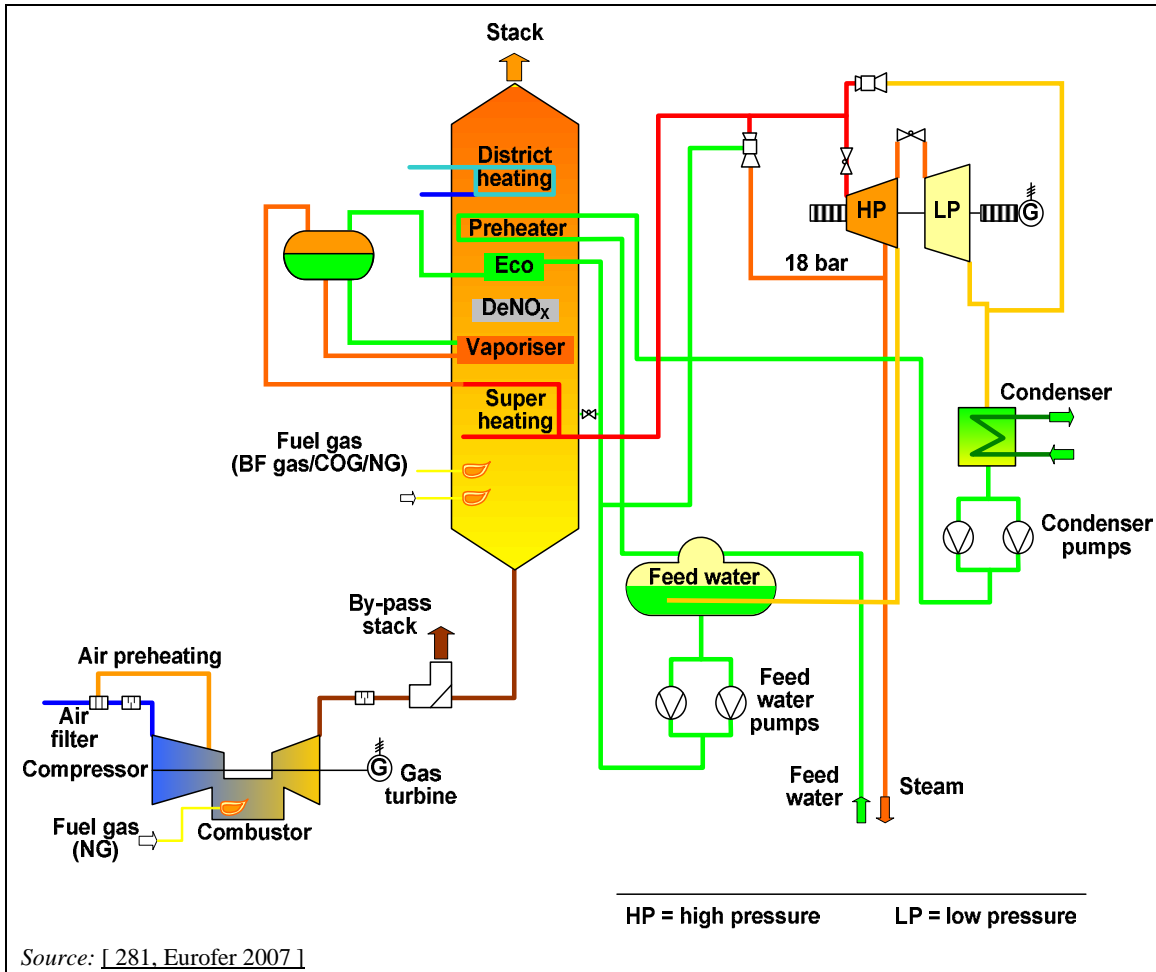

Figure 2.9: Example of a gas turbine (38 MW_e) and steam turbine (30 MW_e) in combined cycle in CHP mode

2.2.1.2 Current emission and consumption level

The overall generation efficiency of an integrated steelworks power plant is lower compared to a commercial power station and the emission characteristics, e.g. in relation to SO_x, NO_x and particulates, are substantially different. The operation of power plants in integrated steelworks, which are fired with BF/BOF gas and/or COG is dependent on the production of the whole plant. When comparing these with commercial large combustion plant installations, which are optimised with regard to the energy output, variations in amounts and compositions of the fuels input should be considered.

2.2.1.2.1 Emissions to air

Table 2.3 provides achieved emission levels for more than 20 power plants operated in European integrated steelworks.

Table 2.3: Achieved emission values for gas-fired boilers and turbines when using process gases from iron and steel works

mg/Nm ³	Annual Averages			
	NO _x	SO ₂	CO	Dust
Mean	87.9	97.7	7.7	6.4
Max.	190	305	33	31
Min.	14	1.1	0.8	0.8
<i>Source: [220, Eurofer 2008].</i>				

2.2.1.2.1.1 Abatement of dust emissions

Fuel gases such as BF gas and BOF gas are usually dedusted before they are applied. COG is treated in a by-product plant and its content of dust is also reduced. Precursors for dust such as sulphur are reduced. The residual dust content in the exhaust gas after combustion is comparatively low. Without any further abatement techniques emission concentrations of 0.8 – 31 mg/Nm³ are achieved at 3 % O₂ for boilers and 15 % for turbines. On average, the annual mean is reported to be 6.4 mg/Nm³ (see Table 2.3).

2.2.1.2.1.2 Abatement of SO₂ emissions

Usually COG contains relevant amounts of sulphur, mostly as H₂S. For this reason, COG should be desulphurised before it is used as a fuel. With wet oxidative desulphurisation, the residual sulphur content can be reduced very efficiently (see Section 5.3.12.4). After combustion, no further abatement of the exhaust gas takes place.

Compared to the combustion of NG, higher emission values occur with respect to SO₂. Emissions values in Austrian process gas-fired power plants are in the range of 66 – 84 mg/Nm³ (annual averages), 120 – 140 mg/Nm³ (half-hourly averages, 93rd percentile) or 120 – 160 mg/Nm³ (half-hourly average, 97th percentile). All data are based on an O₂ content of 3 % for boilers and 15 % for turbines. The values include all operating conditions including start-up and shutdown operations [77, Austrian TWG member 2008].

For more than 20 power stations/boiler plants operated on European integrated steelworks, the annual average emission values range from 1 to approximately 300 mg/Nm³ (see Table 2.3).

Table 2.4 shows some SO₂ emissions concentration values in the exhaust gas of five Austrian process gas-fired power generating units.

Table 2.4: SO₂ emissions for five process gas-fired units in Austria

Device	SO ₂ (mg/Nm ³)		
	2005	2006	2007
Generating Unit 3 ⁽¹⁾	81	89	103
Generating Unit 4 ⁽¹⁾	91	112	114
Generating Unit 5 ⁽¹⁾	89	95	98
Generating Unit 6 ⁽¹⁾	92	94	78
Busbar ⁽¹⁾	89	77	85
Gas und steam turbine ⁽²⁾	13	10	21
⁽¹⁾ O ₂ reference content 3 %. ⁽²⁾ O ₂ reference content 15 %. NB: Annual averages. <i>Source: [32, Voestalpine Linz 2008].</i>			

2.2.1.2.1.3 Abatement of carbon monoxide (CO) emissions

CO gets burned almost completely in the power plant and very low emission values can be achieved in the exhaust gas without any further measure (see Table 2.3).

2.2.1.2.1.4 Abatement of NO_x emissions

The NO_x value strongly depends on the efficiency of the plant, on the nitrogen content of the fuel, and on the related oxygen content in the waste gas. Table 2.5 shows a typical composition of steelworks process gases.

Table 2.5: Typical composition of steelworks process gases

Parameter	Units	BF gas		COG		BOF gas
		Min.	Max.	Min.	Max.	Mean
CO	vol-%	19	27	3.4	5.8	60.9
H ₂	vol-%	1	8	36.1	61.7	4.3
CO ₂	vol-%	16	26	1	5.4	17.2
N ₂	vol-%	44	58	1.5	6	15.5
CH ₄	vol-%			15.7	27	0.1
C _x H _y	vol-%			1.4	2.4	
Lower calorific value	kJ/Nm ³	2600	4000	9000	19000	8184
Dust content	mg/Nm ³	0	10			
Sulphur total	mg/Nm ³		170	100	800	

Building mechanism (general)

Nitrogen oxide (NO_x) occurs during high-temperature combustion processes by oxidation of nitrogen, which is part of the combustion air and also through oxidation of the contained nitrogen of the fuel gas. Nitrogen monoxide (NO) is generated most often, while nitrogen dioxide (NO₂) occurs after the combustion and only with enough oxygen in the waste gas and the atmosphere. Because all of NO will finally be converted to NO₂, the total NO_x emissions are measured in NO₂ (mg/Nm³).

In principle, the formation of both thermal and fuel-related NO_x can be distinguished depending on temperature and concentration, dwell time and type of fuel. The formation of thermal NO_x starts at 1300 °C and rises greatly with an increasing temperature.

- **BF gas**

Because of the comparably low temperature of the flame burning BF gas, there is usually no significant formation of thermal NO_x . The amount of fuel NO_x burning the BF gas depends on the nitrogenous components. Fuel NO_x leads to emissions of 40 – 90 mg/Nm³ (referred to 3 % O_2) at a daily average in the flue-gas without any reduction measurements.

- **COG**

Fuel- NO_x results from the oxidation of the ammonia and organic nitrogen as contained in, e.g. the COG. Because of considerable amounts of ammonia and organic nitrogen in COG, fuel NO_x is generated. By burning higher calorific COG (and natural gas), the formation of thermal NO_x is also considerable due to higher temperatures.

Table 2.6 shows the interconnection between COG nitrogen components in the fuel gas and NO_x emission concentration in the power plant exhaust gas without any primary measures.

Table 2.6: Typical NO_x emission values for burning COG in power plants

Parameter	Min.	Max.	Units
N content of the COG	200	800	mg/Nm ³
Fuel NO_x	90	320	mg/Nm ³
Thermal NO_x	150	120	mg/Nm ³
Total NO_x	240	440	mg/Nm ³
NB: Daily averages.			
Source: [140, Eurofer 2009].			

In integrated steelworks, COG is often mixed with BF gas and BOF gas which will lead to lower emission values for the aforementioned reasons. COG can be used in any range between 0 – 100 % mixed with BF gas and BOF gas.

2.3 Materials management

[200, Commission 2001] [271, Luo 2007] [241, Poland 2007] [243, Eurofer 2007] [260, Germany 2007] [273, Eurofer 2007] [274, Eurofer et al. 1999] [363, Eurofer 2007] [365, Eurofer 2007]

Integrated steelworks installations are large complex sites highly intensive in materials. A works producing 3 million – 5 million tonnes per year of steel will handle 8 million – 12 million tonnes of raw materials such as ores, pellets, scrap, coal, lime, limestone (in some cases also heavy oil and plastics) and additives, auxiliaries and process residues such as by-products and wastes.

These materials are usually transferred to the site by bulk carriers via road, rail or water transport. These materials and the intermediate products, such as coke and sinter, are stored in stockyards or silos and transported to the individual processing plants, usually by a conveyor belt. Figure 2.10 shows a flow diagram of a typical material handling process in an integrated steelworks.

Integrated steelworks are characterised by high levels of resource efficiency achieved by applying a range of advanced techniques for the well-organised and sophisticated management of materials.

From an environmental point of view, the storage and handling of large quantities of solid materials can give rise to significant releases of dust. Part of the dust release will be in the form of fine dust (PM₁₀). Compared to the releases from point sources where the share of PM₁₀ in the clean gas after abatement is between 90 and 99 %, the share of PM₁₀ in dust emissions from bulk material storage and handling is usually much lower [3, Remus, R. 1998] [83, Ehrlich, C. et al 2007].

There are and have been problems in achieving the EU ambient air quality standard for PM₁₀ in the neighbourhoods surrounding major steelworks across the EU (e.g. in Germany, the Netherlands, Belgium and the UK). A review of sources of PM₁₀ at a large integrated iron and steel works site in the UK has identified that in terms of contributions to local air quality levels, releases from tall stacks are not significant contributors. In contrast, contributions from low level diffuse sources have been identified as significant, next to an integrated plant of Flanders in Belgium. The study used multiple air quality monitoring sites, collocated, with wind direction and strength monitoring together with triangulation and pollution roses [198, Mensink, C. et al 2007] [199, Mark et al. 2006].

The main focus of the IS BREF is on the key process activities operated in iron and steel making. However, it is clear that ancillary operations at such sites are environmentally significant sources of dust and PM₁₀ and therefore operators must use BAT to minimise releases from these generally fugitive and diffuse sources. The BREF on Emissions from Storage [283, EC 2006] covers many of these areas in detail and it is strongly recommended that the reader refer to this document for those details.

In this section, general techniques for reducing the dust emissions from materials storage, handling and transfer are given. The main fugitive and diffuse and generally low-level release sources of dust and PM₁₀ at integrated steelworks may include:

For input materials

- ship, barge, train or truck unloading
- conveyors
- stockpiles
- blending and burden preparation
- transport

- roads and tracks across the site
- ground which is uncovered.

For output materials

- processing and conveying of process residues
- storage of process residues
- loading procedures for process residues such as by-products and waste.

Information on fugitive and diffuse low-level sources other than material storage, handling and transfer, e.g. on-site processing of residues, emissions released from insufficient extraction during crushing, screening, charging, melting, tapping, usually referred to as secondary off-gases, can be found in the specific sections.

2.3.1 Storage and handling of input materials

Airborne dust from the stockyards and conveyor belts, including transfer points, can be a significant source of emissions. When material including leachable compounds and materials such as hydrocarbons from mill scale or scrap is stored in unpaved stockyards, attention also should be paid to soil and groundwater pollution and to runoff water. In some countries, material with leachable components should be stored on grounds with adequate soil protection. Figure 2.10 shows a flow diagram of a typical material handling process in an integrated steelworks.

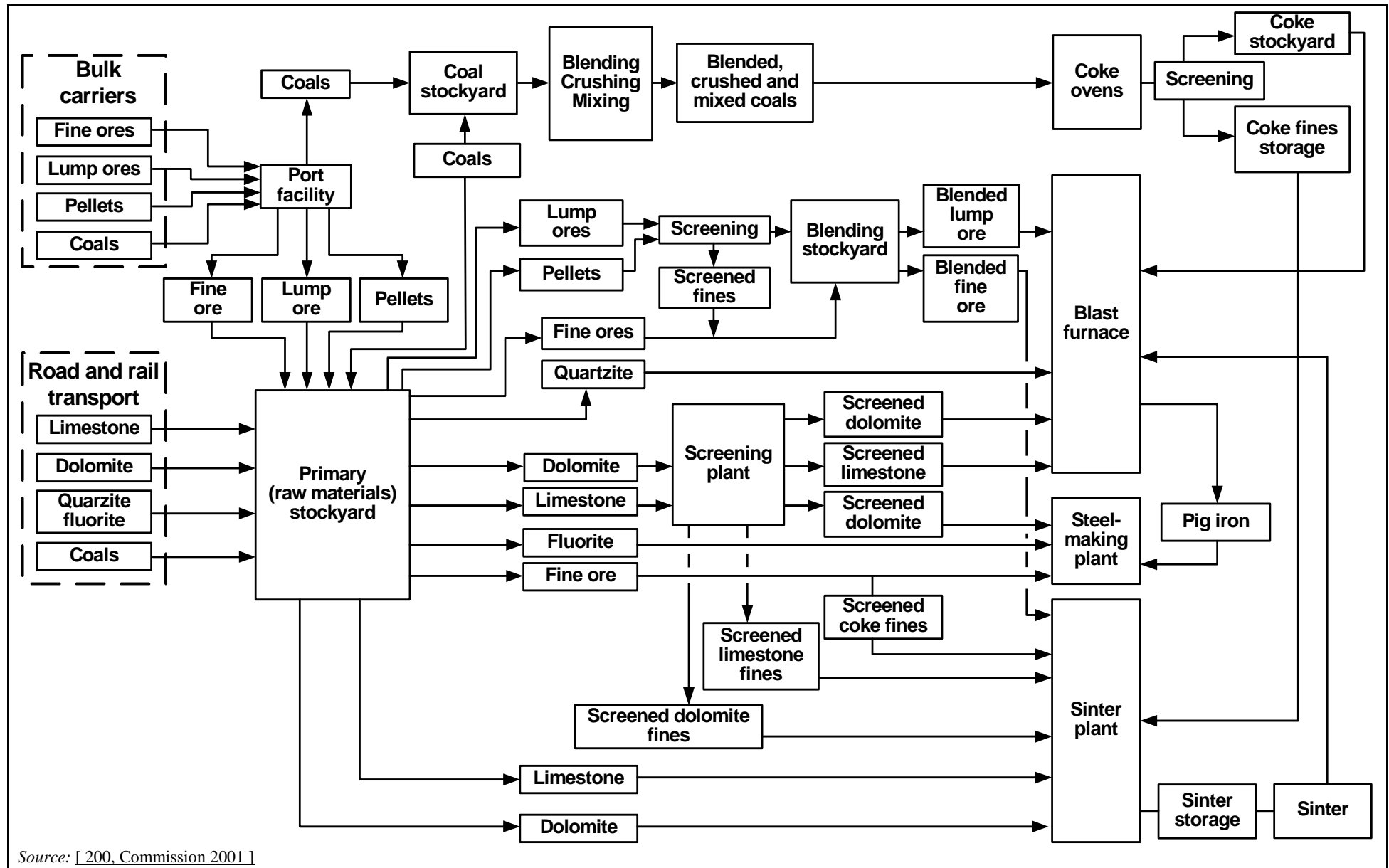

Source: [200, Commission 2001]

Figure 2.10: Flow diagram of a typical material handling process in an integrated steelworks

Iron ores management

European integrated steelworks generally use iron ores from a variety of sources and a significant tonnage of these ores is imported to the EU by bulk carrier. For coastal steelworks the unloading can be directly to the primary stockyards while for other steelworks, there will be a discharge to intermediate stockyards for transfer to the steelworks via barge, rail or road transport. Some steelworks receive ores directly from the mines, again using barge, rail or road transport. Care is taken to minimise cross contamination of the various ores in the primary stockyard and to avoid the inadvertent mixing of ores with fluxes and especially coals where contamination with iron oxides could have a deleterious effect on the coke oven refractory. Care is taken to avoid the generation of diffuse dust emissions during these handling stages through an appropriate combination of techniques.

Iron ore fines are then either blended together with other materials such as fluxes, coke breeze and arisings in a secondary stockyard or sent to blending bins for belt blending ahead of the sinter plant or pellet plant. Blending is carried out to maintain a consistent quality of feedstock to the processing plant and ultimately to the blast furnaces. The blended ore stockpiles are formed and reclaimed using specially designed plants and conveyors.

Imported direct charge ferrous materials for the blast furnace (i.e. rubble ores and pellets) are recovered from the primary stockyard piles and are generally screened, with the oversized ores being conveyed to the blast furnace bunkers while the undersized ores are routed for use at the sinter plant. [240, UKEA 2004]

Scrap yards and handling

The European steel scrap specifications have been agreed upon by most commercial firms in the EU-27 that are involved in the recycling and processing of ferrous scrap. The specifications classify scrap into six categories: old scrap, new uncoated scrap with low residuals, shredded scrap, steel turnings, high residual scrap and fragmented scrap from incineration. These specifications also contain environmental, health and safety related considerations such as the content of dangerous, flammable and explosive substances, Cu, Sn, Cr, Ni, Mo, S and P and radioactive materials [53, BDSV 2009]. The definitions of the items in this list of specifications apply only to non-alloy carbon steel scrap as raw material for the steel industry.

Scrap metal is normally stored outside on large, uncovered and often unpaved ground. The ferrous scrap is loaded into baskets by magnets or by grabs. The handling minimises any rogue, non-magnetic material like stones, wood or non-ferrous metals from entering the process.

Some types and quality of scrap may lead to the deposition of residual materials on the ground, as well as to the deposition of heavy metals and hydrocarbons during metal storage and handling operations.

Depending upon the types and qualities of the scrap being processed, handling operations (i.e. charging, discharging) may also lead to inorganic (dust) and organic emissions (e.g. oily splinters), under certain weather conditions.

In addition, some types of scrap handling may also give rise to noise emissions.

Fluxes management

Fluxes are crushed, e.g. by a hammer crusher and screened to a fraction of 0 – 4 mm for usage in sinter plants or the desired fraction can be purchased directly.

Management of materials/wastes from external sources in the integrated steelworks

Integrated steelworks can receive wastes from other sectors such as used oils and greases, lime, oil/water emulsions, waste plastics, etc. Carbon and iron from these materials can be recovered in processes such as coke ovens and blast furnaces. For example, it is possible to directly inject some reducing agents at the tuyère level of the blast furnace.

Radioactivity in scrap

[51, UN ECE 2006] [215, BSS 2007] [260, Germany 2007] [373, Eurofer 2007]

Control of radioactivity of input scrap is an important issue, which is followed in detail by an expert group from the United Nations Economic Commission for Europe (UNECE). The UNECE Group of Experts developed in 2006 provide a framework of recommendations and examples of good practice which is based, as much as possible, on existing national, regional and international instruments and standards and on national experience. Their works include:

- recommendations on monitoring and response procedures for radioactive scrap metal
- international training and capacity building strategy for monitoring and response procedures (2007)
- Report on the Improvement of the Management of Radiation Protection Aspects in the Recycling of Metal Scrap, ISBN 92-1-116 789-2 (2002). These guidelines represent the industrial reference for handling this issue, which is not exclusive to the steel companies but to all the stakeholders involved, from the administration departments to recovery and recycling in metal industries (www.unece.org/trans/radiation/radiation.html).

2.3.2 Management of production residues

The integrated steelmaking process produces a wide range of materials, including steel as a main product. Other material outputs from the steelmaking processes are blast furnace slag and various steel slags, ammonium sulphate, sulphur or sulphuric acid from the COG desulphurisation plant, coke tar, coke pitch and (crude) benzene from the coke oven gas by-product plant and other materials such as iron scrap.

Some of these materials are often used as raw materials in other sectors. Through process optimisation, including maximising the internal recirculation of carbon and iron-bearing dusts, residues that are surplus to the requirements of the integrated steelworks production processes are minimised. A range of uses, including a variety of recovery processes, has been developed for such materials, resulting in a relatively small proportion of total residues requiring disposal. In addition to the management of materials arising within the processes, integrated steelworks receive residues, including wastes, from other installations and sectors.

Figure 2.11 shows a typical example of the management of production residues such as by-products and wastes in an integrated steelwork.

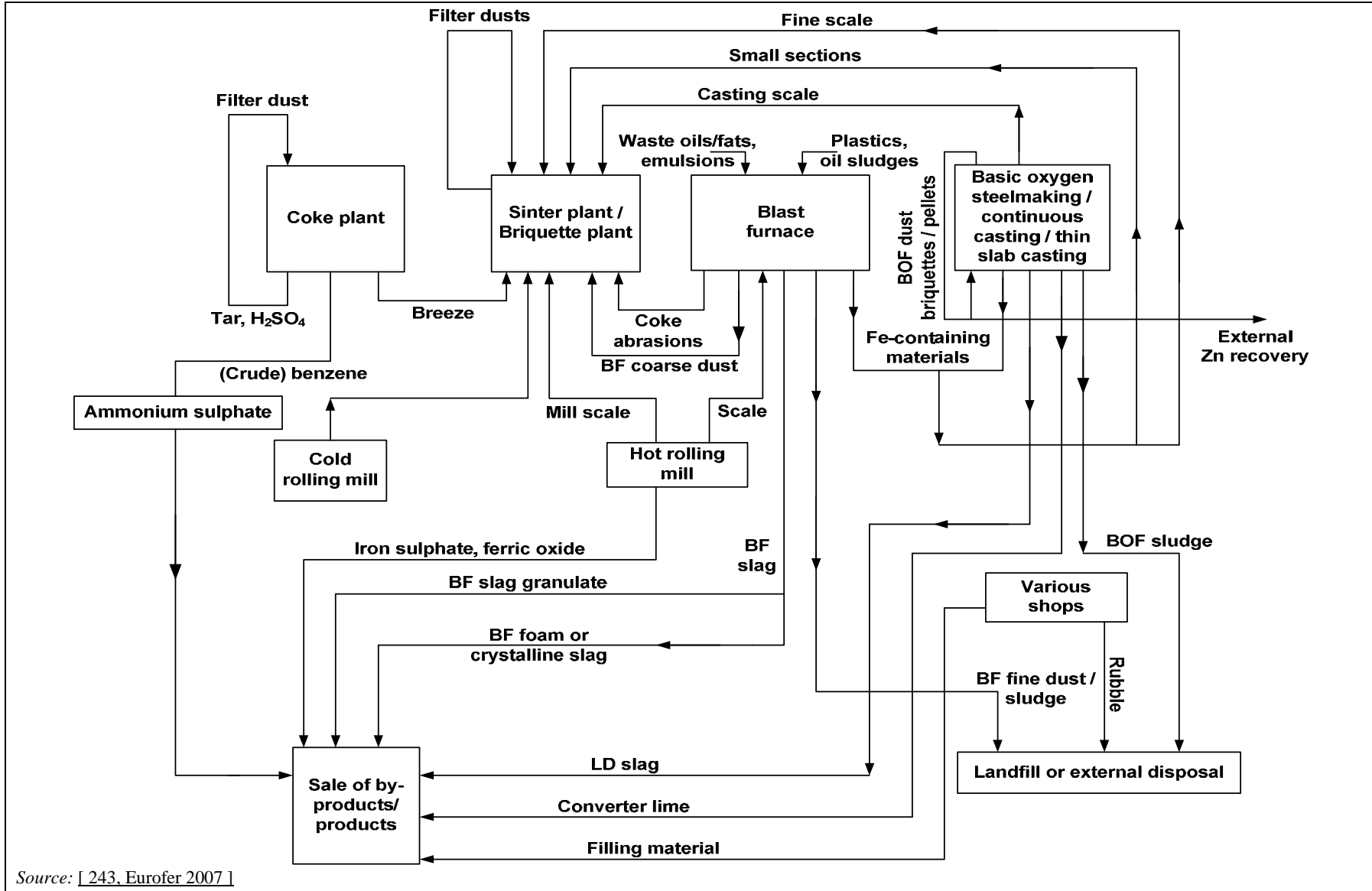

Figure 2.11: Example for the management of production residues such as by-products and wastes in an integrated steelworks

2.3.2.1 Internal use of integrated steelworks residues

Most of the residues arising within an integrated steelworks have a high content of iron, carbon, calcium and other useful components and can replace primary raw materials such as iron ores, coal, slag formers, heavy oil and cokes. Indeed, the management of residues in an integrated steelworks is characterised by the application of advanced integrated processing techniques designed to retain, as much as possible, all of the useful components contained in residues within the steelmaking process.

The identification and separate collection by material categories (e.g. by chemical composition, particle size, or oil content) are necessary preliminary conditions to ensure proper use inside the steelworks without negative effects in terms of production efficiency, product quality and environmental protection.

The iron-bearing fraction of the various types of crude slag, iron- and carbon-bearing dusts and sludges from gas cleaning systems, used oil, new scrap and scale can be recirculated back through sinter plants, pellet plants, coke ovens, blast furnaces, and BOF plants. The fine materials tend to be recirculated through the sinter plant, whereas coarser materials are more often returned to the blast furnace or BOF plant. In order to return certain fractions to the blast furnace and BOF plant, briquetting plants are often employed, where all sorts of fine graded residues are combined into cold bonded bricks/briquettes that are easier to handle and can be used elsewhere within the process. In particular, the dusts or sludges from the steelmaking plant can be briquetted or pelletised and afterwards used in the steelmaking plant when the non-ferrous content is not too high.

In Section 2.5.4.4 specialised recycling facilities for iron-rich residues are described. Some of these facilities make the direct recovery of liquid iron possible; others serve as a pre-treatment stage to reuse the residues in the blast furnace or the electric arc furnace. The presence of high concentrations of unwanted compounds such as alkalis, heavy metals and mineral oil sets limits on the recycling of iron-rich residues.

Table 2.7 shows a compilation of different uses for steel slags in Europe.

Table 2.7: Use of steel slags in Europe

Use of steel slags ⁽¹⁾	%	Amount
Cement production	1	152
Road construction	45	6840
Hydraulic engineering	3	456
Fertiliser	3	456
Internal recycling	14	2128
Interim storage	17	2584
Final deposit	11	1672
Other	6	912
Total	100	15200
⁽¹⁾ 'Steel slags' refers to slags from BOF, secondary metallurgy and EAF. NB: Figures are from 2004 and correspond to 12 EU member states (AT, BE, DE, DK, ES, FR, FI, LU, NL, UK, SE, SK). Source: [174, Euroslag 2006].		

2.3.2.2 External applications of integrated steelworks residues

Zinc-rich sludges and dusts are generated during BOF gas cleaning and BF gas cleaning. Nevertheless, the zinc content is not high enough to make reuse economical. Only some of these sludges and dusts can be used, so almost all iron and steel plants have a large deposit of zinc-rich sludges and wastes.

If the non-ferrous metal content of the dusts or sludges arising in the integrated steelworks is sufficiently high to ensure its technical and economic feasibility, some non-ferrous metals can be recovered in external metal production and recycling plants. For example, steelmaking dusts with enriched zinc concentrations can be used as a raw material within the zinc sector instead of zinc ores.

2.3.2.3 Disposal of integrated steelworks residues

Small parts of the overall quantity of residues from an integrated steelworks have no economic use (either internally, within the installation, or externally) and some disposal is inevitable. Materials usually requiring disposal include:

- fine dust/sludge from BF gas cleaning
- runner refractory rubble from the BF
- fine dust from BOF gas scrubbing (if a wet cleaning process is used)
- in some cases, the dust which contains high amounts of alkali chlorides and heavy metal chlorides from the last field of electrostatic precipitators, bag filters or scrubbers used to treat the off-gas from sinter strands.

Many integrated steelworks have their own internal, certified landfill facilities whilst other companies rely on external landfill sites. In all cases, landfill sites must be authorised to receive the particular wastes.

2.4 Water and waste water management

[200, Commission 2001] [279, IISI 2002] [316, Eurofer 2009]

In an integrated steelworks, water is used, e.g. for direct and indirect cooling, gas cleaning, scale breaking and washing operations including waste gas cleaning with scrubbers.

There can be various water systems in operation: completely closed, semi-closed or open circuits. There are only a few completely closed loops. Closed circuits can be used, e.g., for cooling circuits operated with demineralised or softened water at specific installations, i.e. for continuous casting moulds or at boilers in power plants, which are generally cooled through an exchanger water/water. Here the second circuit of water is used as a semi-closed circuit with a cooling tower.

Below are three examples where semi-closed systems are used:

- in cooling towers for decreasing the water temperature. There is a need to bleed off a small discharge flow to limit the salt concentration in the water preventing the deposition of these salts and consequently corrosion and further possible leakages
- for the recycling of waste water after treatment for further uses not requiring such high quality water as for the first use. Since some undesirable substances can build up, a small amount of water has to be bleed off and lead to a waste water treatment plant before final discharge. This amount needs to be replenished with fresh water
- for process water which can be led in a close cycle. Since some undesirable substances can build up, a small amount of water is led to a waste water treatment plant before discharging. This amount needs to be replenished with fresh water.

The water management in an integrated steelworks primarily depends on local conditions, above all on the availability and quality of fresh water and on legal requirements.

Figure 2.12 gives an example of water management with an indication of the water treatment of an integrated steelworks with almost unlimited fresh water availability, thus explaining the presence of once-through cooling systems, resulting in a specific water intake of more than 100 – 200 m³/t of steel. This is valid for plants close to large bodies of water, e.g. big rivers.

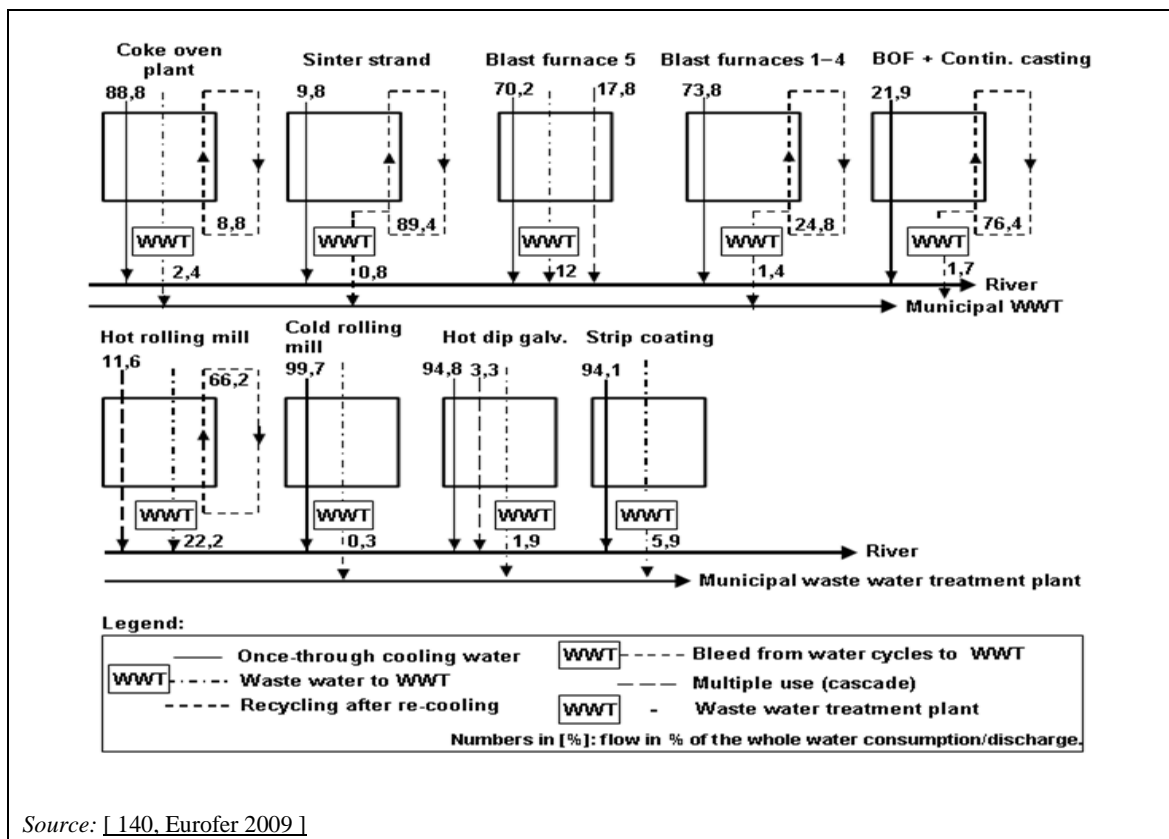

Source: [140, Eurofer 2009]

Figure 2.12: Example of water management of an integrated steelworks at a location with a high surplus of fresh water availability

A driving factor for steadily improving the intake and outlet of water are the costs. The costs for waste water treatment and releasing costs based on legal tax on discharging water into the municipal system can be considerable. Another cost-related factor is that the water taken from the aforementioned bodies depending on the water quality for many applications should undergo a conditioning step before it can be used. Furthermore, the pumping of such heavy water flows requires much electric energy.

For these reasons, water consumption has been constantly reduced since 1980.

In particular, at sites with very low fresh water availability, where the water demand should be covered by groundwater or spring water, there may be a need to reduce water consumption intensely. In such cases, the specific water consumption can be lower than $5 \text{ m}^3/\text{t}$ of steel and the interdependencies can be much more intensive.

Table 2.8 illustrates a comparison between the intake water requirements of a once-through system and a system involving extensive recirculation in a typical integrated steelworks. The extensive recirculation in indirect and direct cooling systems reduces the total water intake to 2.4 % of the requirement of the once-through system.

Table 2.8: Comparison in water intake required for integrated steelworks with once-through systems versus extensive recirculation

Water Use	Quality	Water intake			
		Once-through system		Extensive recirculation	
		(m ³ /min)	(% of total)	(m ³ /min)	(% of total)
Indirect cooling	General	675	70.7	7.4	32
Direct cooling	General	265	27.8	6.2	26.8
Process water	Low grade	7.7	0.8	5.1	22.1
Potable water	High grade	1.5	0.2	1.5	6.5
Evaporation losses		4.8	0.5	2.9	12.6
Total		954	100	23.1	100
NB: It is not known if this data also includes the water used in downstream operations (not included in this document, e.g. rolling).					
Source: [279, IISI 2002].					

The following two figures present other examples of two different global systems from two integrated steelworks with separate circuits due to the local design of the plant (see Figure 2.13) and with a counterflow cascade system with steel production steps (from a cold rolling mill to the blast furnace) (see Figure 2.14).

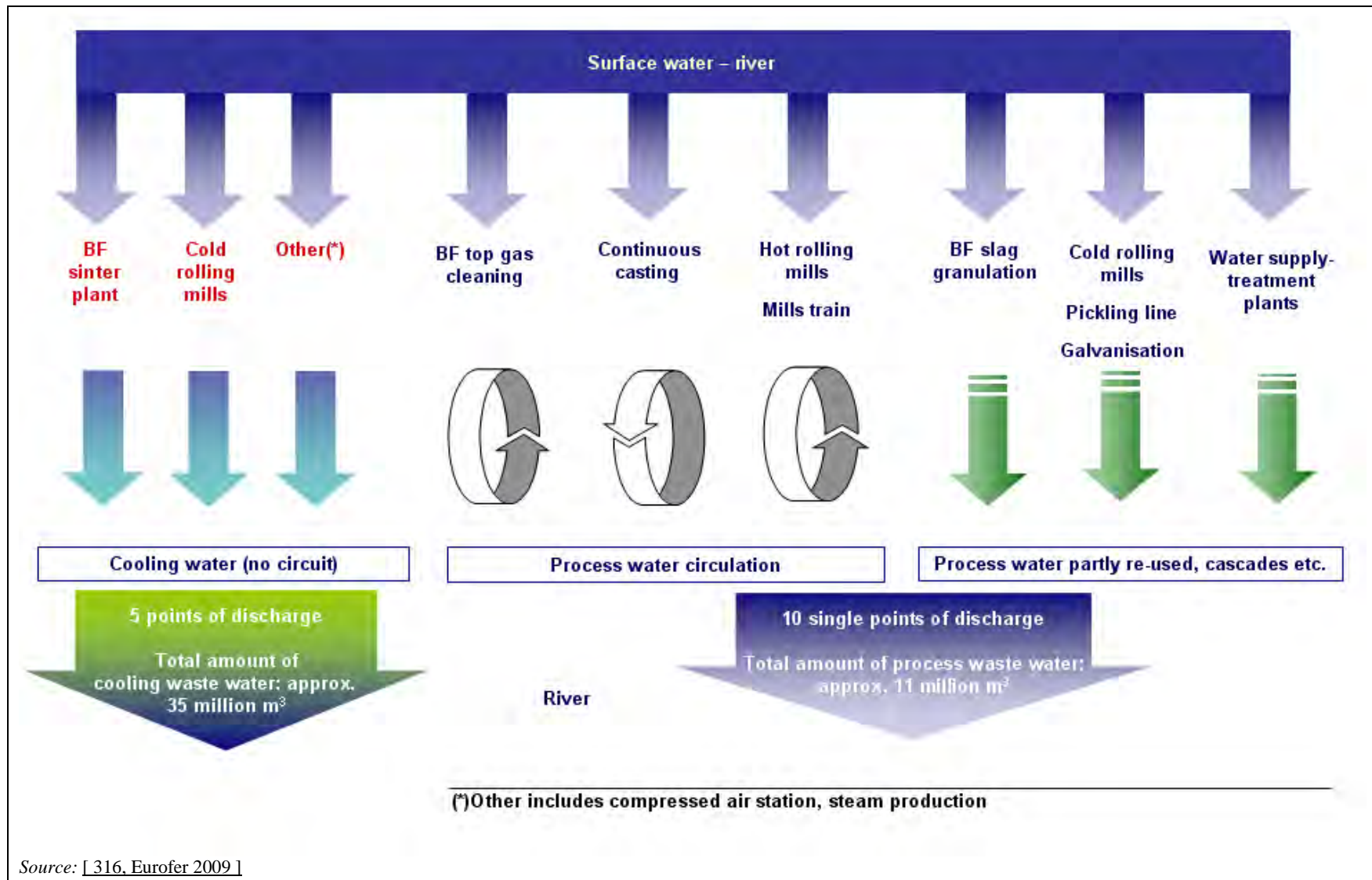

Figure 2.13: Example for the water management of an integrated steelworks with separate circuits

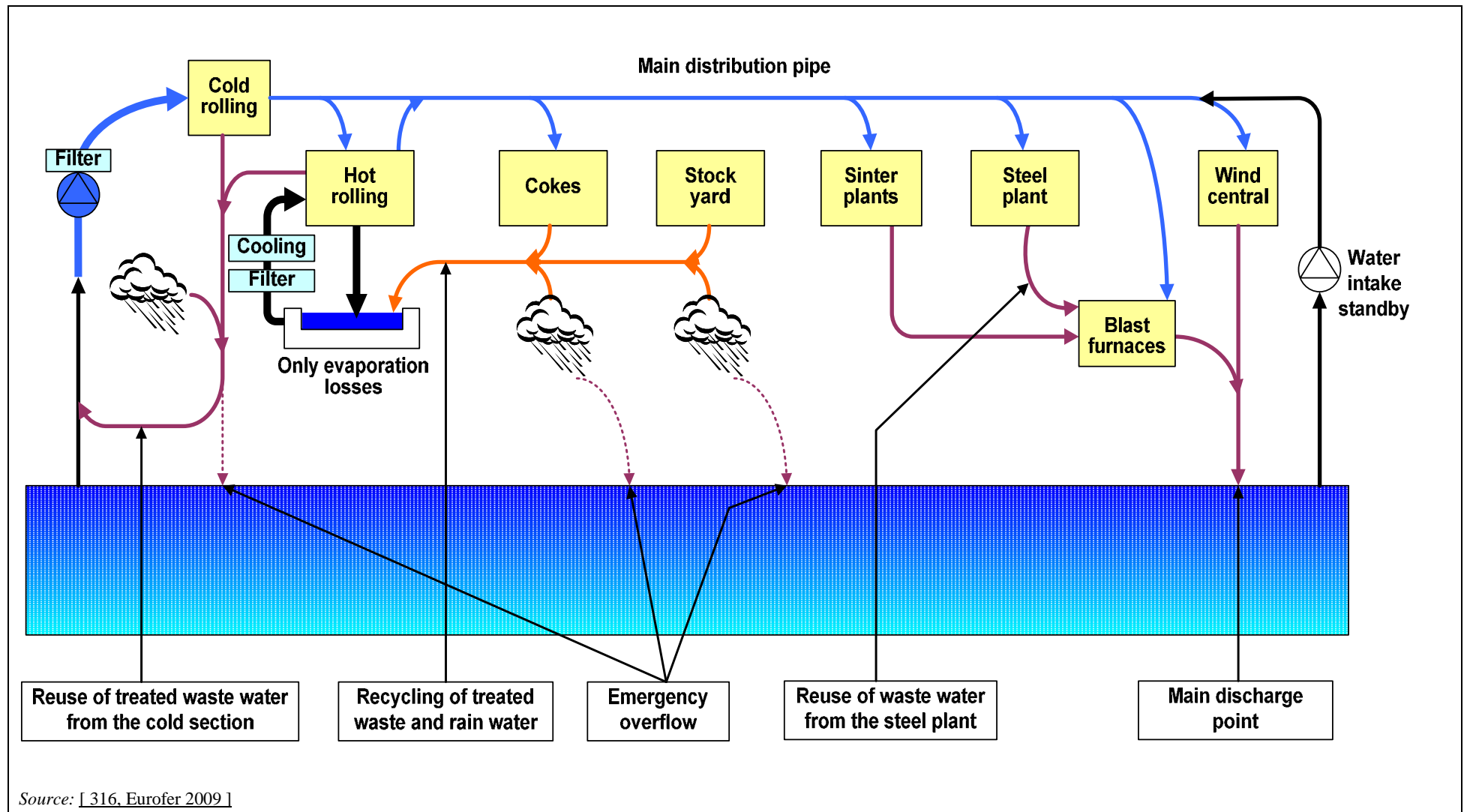

Figure 2.14: Example for the water management of an integrated steelworks using a cascade system

In the example plant depicted in Figure 2.13, the overall quantity of water in 2005 was nearly 1.2 billion m³/yr. The recirculation rate in this case was 97.2 % and only 2.8 % needed to be replenished with fresh water. The discharge as waste water was only 1.2 % and the rest were losses of about 1.6 %.

As a result, the water intake was about 3.16 m³/t crude steel.

Techniques which led to a reduced water intake and a minimised amount of discharged waste water in the aforementioned case include:

- avoiding the use of potable water for production lines
- increasing the number and/or capacity of water circulating systems when building new plants or modernising/revamping existing plants
- centralising the distribution of incoming fresh water
- using the water in cascades until single parameters reach their legal or technical limits
- using the water in other plants if only single parameters of the water are affected and further usage is possible
- keeping treated and untreated waste water separated. By this measure it is possible to dispose of waste water in different ways at a reasonable cost
- using rainwater whenever possible.

2.5 General techniques to consider in the determination of BAT

This section describes techniques (or combinations thereof), and associated monitoring, considered to have the potential for achieving a high level of environmental protection in the activities within the scope of this document.

It covers environmental management systems, process-integrated techniques and end-of-pipe measures. Waste prevention and management, including waste minimisation and recycling procedures are also considered. Furthermore, techniques for reducing the consumption of raw materials, water and energy are covered.

Annex III to the Directive lists a number of criteria for determining BAT, and the information within this chapter will address these considerations. As far as possible, a standard structure as shown in Table 2.9 is used to outline the information gathered concerning each technique, to enable a comparison of techniques and the assessment against the definition of BAT given in the Directive.

This section does not necessarily provide an exhaustive list of techniques which could be applied in the sector and other techniques may exist or may be developed, which could be considered for the determination of BAT for an individual installation.

Table 2.9: Information for each technique described in this section

Type of information considered	Type of information included
Description	Brief technical description using, as appropriate, pictures, diagrams and flow sheets.
Achieved environmental benefits	Main potential environmental benefits to be gained through implementing the technique (including energy, water, raw material savings, as well as production yield increases, energy efficiency, etc.).
Cross-media effects	<p>Potential environmental side effects and disadvantages to other media due to implementing the technique, including details of the environmental effects of the technique in comparison with others (advantages and disadvantages supported by data if available) in order to assess the impact of the technique on the environment as a whole. This may include issues such as:</p> <ul style="list-style-type: none"> • consumption of raw materials and water • energy consumption and contribution to climate change • stratospheric ozone depletion potential • photochemical ozone creation potential • acidification resulting from emissions to air • particulate matter in ambient air (including micro particles and metals) • eutrophication of land and waters resulting from emissions to air or water • oxygen depletion potential in water • persistent/toxic/bioaccumulable components in water or to land (including metals) • creation or reduction of (waste) residues • ability to reuse or recycle (waste) residues • noise and/or odour • risk of accidents.
Operational data	Actual performance data (including reference conditions, monitoring periods and monitoring methods) on emission levels, consumption levels (raw materials, water, energy) and amounts of waste generated. Any other useful information on how to operate, maintain and control the technique.
Applicability	Indication of the type of plants or processes in which the technique may or cannot be applied as well as constraints to implementation in certain cases, considering, e.g. plant age (new or existing), factors involved in retrofitting (e.g. space availability), plant size (large or small), techniques already installed and type or quality of product.
Economics	Information on costs (investment and operating) and any possible savings (e.g. reduced raw material or energy consumption, waste charges) or revenues including details on how these have been calculated/estimated. Economic information relevant to new build and retrofit to existing installations will be included. This should allow for identifying, where possible, the overall economic impact of the technique.
Driving force for implementation	Specific local conditions, requirements (e.g. legislation, safety measures) or non-environmental triggers (e.g. increased yield, improved product quality) which have driven or stimulated the implementation of the technique to date.
Example plants	Reference to the plant(s) where the technique has been implemented and from which information has been collected and used in writing the section. Indication of the degree to which the technique is in use in Europe or worldwide.
Reference literature	Literature or other reference material (e.g. books, reports, studies, websites) that was used in writing the section and that contains more detailed information on the technique.

2.5.1 Environmental management systems

Description

The Directive defines ‘techniques’ (under the definition of 'best available techniques') as ‘both the technology used and the way in which the installation is designed, built, maintained, operated and decommissioned’.

In this respect, an environmental management system (EMS) is a technique allowing operators of installations to address environmental issues in a systematic and demonstrable way. EMSs are most effective and efficient where they form an inherent part of the overall management and operation of an installation.

An EMS focuses the attention of the operator on the environmental performance of the installation; in particular through the application of clear operating procedures for both normal and other than normal operating conditions, and by setting out the associated lines of responsibility.

All effective EMSs incorporate the concept of continuous improvement, meaning that environmental management is an ongoing process, not a project which eventually comes to an end. There are various process designs, but most EMSs are based on the plan-do-check-act cycle (which is widely used in other company management contexts). The cycle is a reiterative dynamic model, where the completion of one cycle flows into the beginning of the next (see Figure 2.15).

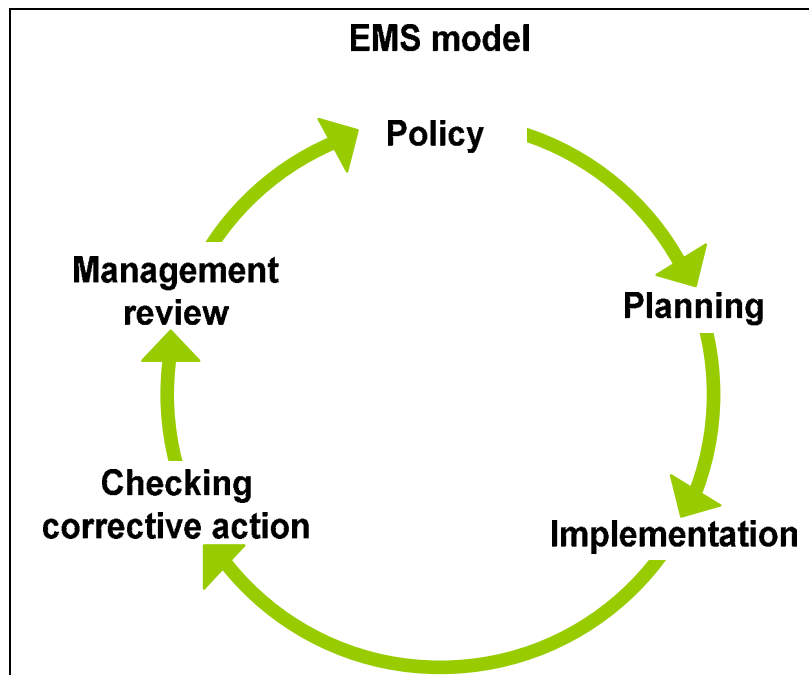

Figure 2.15: Continuous improvement in an EMS model

An EMS can take the form of a standardised or non-standardised (‘customised’) system. Implementation and adherence to an internationally accepted standardised system such as EN ISO 14001: 2004 can give higher credibility to the EMS, especially when subjected to a properly performed external verification. EMAS provides additional credibility due to the interaction with the public through the environmental statement and the mechanism to ensure compliance with the applicable environmental legislation. However, non-standardised systems can, in principle, be equally effective provided that they are properly designed and implemented.

While both standardized systems (EN ISO 14001:2004 or EMAS) and non-standardized systems apply in principle to **organizations**, this document takes a narrower approach, not including all activities of an organization e.g. with regard to their products and services, due to the fact that the Directive only regulates **installations/plants**.

An EMS can contain the following components:

1. commitment of management, including senior management;
2. definition of an environmental policy that includes the continuous improvement of the installation by the management;
3. planning and establishing the necessary procedures, objectives and targets, in conjunction with financial planning and investment;
4. implementation of procedures paying particular attention to:
 - (a) structure and responsibility
 - (b) training, awareness and competence
 - (c) communication
 - (d) employee involvement
 - (e) documentation
 - (f) efficient process control
 - (g) maintenance programmes
 - (h) emergency preparedness and response
 - (i) safeguarding compliance with environmental legislation;
5. checking and corrective action paying particular attention to:
 - (a) monitoring and measurement (see also the Reference Document on the General Principles of Monitoring) [42, EC 2003]
 - (b) corrective and preventive action
 - (c) maintenance of records
 - (d) independent (where practicable) internal and external auditing in order to determine whether or not the EMS conforms to planned arrangements and has been properly implemented and maintained;
6. review of the EMS and its continuing suitability, adequacy and effectiveness by senior management;
7. preparation of a regular environmental statement;
8. validation by a certification body or an external EMS verifier;
9. following the development of cleaner technologies;
10. consideration for the environmental impacts from the eventual decommissioning of the installation at the stage of designing a new plant, and throughout its operating life;
11. application of sectoral benchmarking on a regular basis.

Achieved environmental benefits

An EMS promotes and supports the continuous improvement of the environmental performance of the installation. If the installation already has a good overall environmental performance, an EMS helps the operator to maintain the high performance level.

Cross-media effects

None reported. The systematic analysis of the initial environmental impacts and scope for improvements in the context of the EMS sets the basis for assessing the best solutions for all environmental media.

Operational data

All significant consumptions (including energy) and emissions are managed in a coordinated manner by the operator for the short, medium and long term, in conjunction with financial planning and investment cycles. This means that, e.g. adapting short-term end-of-pipe solutions to emissions may tie the operator to higher energy consumption in the long term, and postpone

investment in potentially more environmentally beneficial solutions overall. This requires some consideration of the cross-media issues, and guidance on these and the costing and cost-benefits issues is given in the Reference Document on Economics and Cross-Media Effects (ECM) [185, European Commission 2006] and in the Reference Document on Energy Efficiency (ENE) [48, EC 2008].

Applicability

The components described above can typically be applied to all installations within the scope of this document. The scope (e.g. level of detail) and nature of the EMS (e.g. standardised or non-standardised) will be related to the nature, scale and complexity of the installation, and the range of environmental impacts it may have.

Economics

It is difficult to determine accurately the costs and economic benefits of introducing and maintaining a good EMS. There are also economic benefits that are the result of using an EMS and these vary widely from sector to sector.

External costs relating to verification of the system can be estimated from guidance issued by the International Accreditation Forum [Author: the website is already lodged in BATIS with ID number 10152; please associate it with the BREF and then insert the reference here].

External costs relating to verification of the system can be estimated from guidance issued by the International Accreditation Forum (<http://www.iaf.nu>).

Driving forces for implementation

The driving forces for the implementation of an EMS include:

- improved environmental performance
- improved insight into the environmental aspects of the company which can be used to fulfil the environmental requirements of customers, regulatory authorities, banks, insurance companies or other stakeholders (e.g. people living or working in the vicinity of the installation)
- improved basis for decision-making
- improved motivation of personnel (e.g. managers can have confidence that environmental impacts are controlled and employees can feel that they are working for an environmentally responsible company)
- additional opportunities for operational cost reduction and product quality improvement
- improved company image
- reduced liability, insurance and non-compliance costs.

Example plants

EMSs are applied in a number of installations throughout the EU.

Most European steelmaking plants have certified EMSs whereas ISO 14001 is more often applied than EMAS. Some examples are:

- Buderus Edelstahl GmbH, Wetzlar, Germany
- Uddeholm Tooling AB, Hagfors, Sweden
- Villares Metals SA, São Paulo, Brazil
- Böhler Edelstahl GmbH, Kapfenberg, Austria
- Voestalpine Stahl GmbH, Linz, Austria
- Voestalpine Stahl GmbH, Donawitz, Austria
- Rivagroup Taranto, Italy
- ArcelorMittal Dunkirk, Florange, Fos sur Mer, France

Reference literature

EMAS Regulation (EC) No 1221/2009. [396, Reg. 1221/2009]

DG Environment EMAS website. [397, DG Environment 2010]

EN ISO 14001: 2004

ISO 14000 family of standards website. [398, ISO 2004]

ISO 14000 technical committee. [398, ISO 2004]

2.5.2 Energy management

2.5.2.1 Techniques to improve energy efficiency

Description

There are some special and important items, which should be mentioned in connection with an integrated steelworks in order to improve the overall energy efficiency including:

- optimising energy consumption. Typically, a change in the energy supply of one process in the steel plant influences several other processes (e.g. the use of coke oven gas in the blast furnace can result in a higher calorific value in the BF top gas). Optimising tools that consider the whole integrated site may be preferable to ones that consider each process as a standalone unit
- online monitoring. This is often used for the most important energy flows and combustion processes at the site. The data are stored for a long time so that typical situations may be analysed. Very important is the online monitoring for all gas flares. It is the main technique used to avoid energy losses in the flares and combustion processes. Continuous monitoring systems for all energy-related process parameters can be used to optimise process control and enable instant maintenance, thus achieving an undisrupted production
- reporting and analysing tools. Reporting tools are often used to check the average energy consumption of each process. In connection with cost controlling, controlling energy is the basis for optimising energy consumption and cost savings. An energy controlling system offers the possibility of comparing actual data with historical data (e.g. charts)
- specific energy consumption levels. For each process, specific energy consumption levels may be defined. Typically, the reported energy levels can be used, although these values must be checked critically. The values are compared on a long-term basis
- energy audits. These audits are defined in the Energy Efficiency BREF as a crucial tool in energy management. These audits may also identify cost-effective energy savings opportunities.

Achieved environmental benefits

The aim of energy management should be to maximise the productive use of gases arising from the processes, thereby minimising the necessity of importing supplementary energy sources into the system and optimising the specific energy consumption within the inherent constraints of the system. In order to achieve the goal, there must be an adequate system dealing with the technical possibilities and costs on the one hand, and on the organisation on the other hand. There are many attempts to explain energy management (e.g. Energy Efficiency BREF), therefore the general details are not discussed in this document.

Cross-media effects

No data submitted.

Operational data

No data submitted.

Applicability

No data submitted.

Economics

No data submitted.

Driving force for implementation

No data submitted.

Example plants

No data submitted.

Reference literature

[281, Eurofer 2007]

2.5.2.2 Techniques to optimise process gas utilisation

Description

Some potential process-integrated techniques used to improve energy efficiency in an integrated steelworks by optimising process gas utilisation include:

- the use of gas holders for all by-product gases or other adequate systems for short-term storage and pressure holding facilities for maximising the recovery of process gases
- increasing pressure in the gas grid if there are energy losses in the flares – in order to utilise more process gases with the resulting increase in the utilisation rate
- gas enrichment with process gases and different calorific values for different consumers – processes require gases with different calorific values for acceptable levels of fuel efficiency. The higher the required process temperature, the higher the amount of high calorific gases needed
- reheating fire furnaces with process gas in order to maximise the use of process gases and reduce the need to purchase natural gas or electrical power
- use of a computer-controlled calorific value control system
- recording and using coke and flue-gas temperatures
- adequate dimensioning of the capacity of the energy recovery installations for the process gases, in particular with regard to the variability of process gases.

Achieved environmental benefits

By the application of the aforementioned techniques, the specific energy demand for steel production in an integrated steelworks can be reduced.

The energy efficiency can be improved through good combustion control and can eventually decrease air emissions.

Cross-media effects

No data submitted.

Operational data

No data submitted.

Applicability

The specific energy consumption depends on the scope of the process, the product quality and the type of installation (e.g. the amount of vacuum treatment at the BOF, the annealing temperature, thickness of products, etc.). Each integrated steelworks and component therein has a different spectrum of products, process configurations, raw material strategies, etc. and therefore has its own specific energy demands. Climatic circumstances should also be taken into account when considering specific energy usage.

Economics

No data submitted.

Driving force for implementation

No data submitted.

Example plants

No data submitted.

Reference literature

[242, Caughlin 2007] [281, Eurofer 2007]

2.5.2.3 Techniques to improve heat recovery**Description**

Some potential process-integrated measures used to improve energy efficiency in steel manufacturing by improved heat recovery include:

- the recovery of waste heat by heat exchangers and distribution either to other parts of the steelworks or to a district heating network (if there are consumers in the vicinity)
- the installation of steam boilers or adequate systems in large reheating furnaces (furnaces can cover a part of the steam demand)
- preheating of the combustion air in furnaces and other burning systems to save fuel, taking into consideration adverse effects, i.e. an increase of NO_x in the off-gas
- the insulation of steam pipes and hot water pipes
- recovery of heat from products, e.g. sinter
- where steel needs to be cooled, the use of both heat pumps and solar panels
- the use of flue-gas boilers in furnaces with high temperatures
- the oxygen evaporation and compressor cooling to exchange energy across standard heat exchangers
- the use of top recovery turbines to convert the kinetic energy of the gas produced in the blast furnace into electric power.

Achieved environmental benefits

District heating is a safe, economically feasible heating method which requires little maintenance for the customer.

By application of the aforementioned techniques, the specific energy demand for steel production in an integrated steelworks can be reduced. CO₂ emissions and emissions of other pollutants may be avoided by replacing fossil fuel with district heating energy production.

A significant advantage of the district heating system is the cleanliness and high temperature difference of the circulating water. In this way, it is possible to connect the production of the heat and the specific process cooling solutions.

Cross-media effects

No data submitted.

Operational data

In the municipal district heating system, thermal energy is delivered with the help of the closed piping for the heating of the buildings and of other premises and for the production of warm service water. The consumer always receives the heat with the help of heat exchangers. Each of the buildings has similar connections, for example, for the electrical net, for the gas net, for the clean water and the waste water nets.

The district heating systems are utilised quite generally within the city areas of the Nordic countries and Russia and more and more also in central Europe. The heat is produced in larger cities in large power plants with combined electricity and heat production (CHP). In some communities, the heat is produced with separate boiler plants burning fixed fuels, heavy oil, natural gas or biomass.

The temperature of the district heating water is adjusted in the range of 75 – 120 °C. The temperature of returning water is in the range 40 – 45 °C.

One specific feature in the industrial district heating system is related to optimisation and to control. When about 90 % of annual heat demand is produced with the waste heat of many different processes, it is quite complicated to continuously divide the optimal heat loads and to control temperatures and pressures in the other production points. In case of providing a major part of the heat to the district heating system, a back-up system might be necessary.

Applicability

The method is used primarily in all steelworks that use a similar cooling technique.

Combined heat and power generation is applicable for all iron and steel plants close to urban areas with a suitable heat demand. The same appears for many other process industries.

The specific energy consumption depends on the scope of the process, the product quality and the type of installation (e.g. the amount of vacuum treatment at the BOF, annealing temperature, thickness of products, etc.). Each integrated steelworks and component therein has a different spectrum of products, process configurations, raw material strategies, etc. and therefore has its own specific energy demands. Climatic circumstances also should be taken into account when considering specific energy usage.

Economics

Selling waste heat can be a remunerative business.

The construction of the district heating system is quite advantageous when utilising the technology that has been generally applied. For this reason, the system has been an extremely profitable technique to Raahe Steel Works, Raahe, Finland, and moreover, there are extremely advantageous district heating tariffs in the town of Raahe for the end user. New industry which uses district heating has been developed in the area.

Driving force for implementation

The driving forces for the implementation of heat recovery are the savings in primary fuels, thus a reduction of CO₂ emissions and other environmental impacts. The driving forces for the implementation of combined heat and power production are the environmental benefits, the improved BF operation and the avoidance of high investment costs.

Example plants

At the reference plant Marienhütte in Graz, Austria, about 40 GWh per year are recovered from the EAF (35 tonnes/charge) and fed to the district heating network (status in 2005). District heating is also practiced in Ovako Hofors, SSAB in Luleå, Sweden and at the Ruukki sinter plant in Finland.

From a combined heat and power plant district, heat is produced at SSAB Lulekraft in Luleå, Sweden. From the start to the end of 2003, 12995 GWh of hot water were delivered to local district heating. Approximately 4.5 Mt of CO₂ would have been produced if the same amount of heat had been generated using heavy fuel oil (assuming a recovery of 90 % and a specific CO₂ value of 0.0879 tonnes CO₂/GJ). Using the same conditions, the amount of NO_x and SO_x avoided could be calculated to approximately 1800 and 600 tonnes, respectively. The electrical power covers the need of a Swedish steel sheet manufacturer SSAB Tunnpåt AB, and also gives some surplus electricity which can be used elsewhere. The production of heat covers the total need of district heating in Luleå (which has 22000 homes). Also, a local biomass plant uses surplus energy from the system.

The total energy delivery from a system for 2004 is given in Table 2.10.

Table 2.10: Example of a CHP plant to producing heat and electrical power for a community

Fuel input (GWh)		Energy output (GWh)	
Gas	2075	Total energy export	1472
Oil	82	Hot water to district heating	751
		Electric power export	613
		Steam export	27
		Drying gas export	81
<i>Source:</i> [208, Lindfors et al. 2006].			

Hofors Energi AB in Sweden delivers a total of around 130 GWh per year to Ovako Hofors and the Hofors community. A third of this is in the form of steam, whereas the rest is in the form of hot water. Making use of waste heat means a savings of up to an additional 4000 m³ per year. In total this means a reduction in CO₂ emissions of 23000 tonnes per year for Ovako Hofors.

As a result of the collaboration between Ovako Hofors and Hofors Energi AB, the community of Hofors is supplied with district heating, which reduces oil consumption in buildings by an additional 4000 m³ of oil per year. This means a reduction in CO₂ emissions of approximately 11000 t/year.

The municipal district heating delivered to Raahen Energia, Finland is 160000 MWh/yr from which the use of heavy fuel oil is replaced by about 18000 t/yr. A similar amount of energy is replaced with Raahe Steel Works' internal fuels, vapour and electricity which would be used for the production of the heat without the district heating system and without waste heat utilisation. Moreover, energy consumption in the steelworks is reduced where it has been possible to sell waste heat to Raahen Energia.

Another example of district heating takes place at Voestalpine Stahl GmbH, Linz, Austria with 139 GWh/yr.

Reference literature

[208, Lindfors et al. 2006] [277, Wiesenberger 2007] [281, Eurofer 2007]

2.5.2.4 Frequency-controlled pumps and fans

Description

An analysis of the pumps used to supply district heating to the industrial area often shows that the pumps are all running continuously at high power, although the pumping power required is often very low.

Most modern pumps and fans can be frequency controlled and may therefore be set to any given rotation speed (rpm value) to obtain the desired set point value for the flow rate. The use of frequency-controlled pumps and fans and variable speed drives enables a better and faster adjustment of water flow rates and off-gas flow rates according to the demands of different process conditions. The optimisation measures of additional systems include:

- a complete separation of the pumps from the main supply when they are switched off
- a replacement of existing pumps with smaller, highly efficient pumps
- the installation of high-efficiency motors.

The highest energy savings are achieved if energy-using systems are optimised as a whole rather than considering the components of individual systems in isolation. The campaign therefore focuses on a systems analysis; the components in a pump system include, for instance, a variable speed drive, an electric motor, a gear box, a pump and pipes and instrument and control

equipment. Measures to optimise the energy used must be developed individually for each pump system and be evaluated from an economic point of view. It is important to analyse the needs parameters (pressure, flow rate, temperature level, etc.), existing operating parameters and systems components of each system individually. The fine tuning of all components and their interaction also belongs in an optimisation plan. This ensures a step-by-step determination of the best possible overall efficiency of a system and the most efficient use of energy.

Achieved environmental benefits

The changes result in considerable savings in electrical energy as well as fewer maintenance costs and fewer production disturbances.

The efficiency measures also play a considerable role in the mitigation of climate change. In SSAB Oxelösund AB, Sweden, savings in electrical energy on a yearly basis is 3.2 GWh. In CO₂ reduction, this means about 250 t/yr.

Cross-media effects

No data submitted.

Operational data

No data submitted.

Applicability

The technique can be applied to the off-gas cleaning water, the cooling water of the hood and the lance, and the off-gas suction fans and similar equipment, for example, at the LD process. In case of applications where the reliability of the pumps is of essential importance for the safety of the process, frequency controlled pumps cannot be used. As pump system technology is an interdisciplinary technology widely used in industry and production, many different kinds of companies can profit from these experiences.

Economics

A systems optimisation can often reduce the energy consumption of an electromotive system by 30 % or more. The reduction in energy costs generally means that the investments pay for themselves within two to three years, with a return on investment of between 30 % and 50 %.

The lifespan of a pump system with an energy consumption that has been optimised is also greater, and plant availability increases. A lower mechanical load also reduces the cost of maintenance.

The energy savings and efficiency parameters for the district heating at Ulm GmbH, Ulm, Germany include:

- electricity savings: 64 % or 325 000 kWh/yr
- cost savings: EUR 32 500/yr
- investment: EUR 67 000
- payback period: 2.1 years
- return on investment: 48 %.

In SSAB Oxelösund, Sweden the total savings potential for the necessary changes exceeds EUR 55 000 per year in energy savings only (at a price of EUR 0.033 kWh). In this case, savings can be achieved without investments. More energy savings may be obtained but, in this case, only after investment.

Driving force for implementation

The driving force is mainly regarding economics.

Example plants

The technique is applied at SSAB Oxelösund AB, Sweden.

District heating Ulm GmbH, Ulm, Germany runs a waste fired heating plant and a peak load heating plant in Ulm Danube Valley and supplies the residential area of Wiblingen, Germany.

Reference literature

[34, dena 2007] [208, Lindfors et al. 2006]

2.5.3 Reduction of NO_x in process gas-fired power plants

In principle, to reduce NO_x emissions, primary as well as secondary measures can be used. The secondary measures have an influence on both thermal as well as fuel NO_x.

2.5.3.1 Reduction of NO_x by primary measures

Description

Primary measures can only reduce thermal NO_x. The following primary measures can be applied individually or in combination:

- deployment of low-NO_x burners
- flue-gas recirculation
- upper air injection for the residual combustion with substoichiometric burners
- injection of reduction fuel
- air staging
- fuel staging.

All of these measures reduce the combustion temperature and the oxygen partial pressure. The result is significantly lowered NO_x emissions. The combustion temperature depends on the calorific value of the input gas. By mixing more flue-gas (without burnable components) to the process gas, the temperature decreases.

Assignment of low-NO_x burners and flue-gas recirculation

This is one of the most effective reduction measures, which should also be used with carefully harmonised combustion techniques.

Using low-NO_x burners and additionally external flue-gas recirculation, a value of 80 – 90 mg/Nm³ thermal NO_x can be attained on a daily average. With the combustion of COG in combination with natural gas (without BF gas), values of about 90 mg/Nm³ are reachable on a daily average.

By installing both low-NO_x burners and flue-gas recirculation, a reduction rate of about 40 % is possible, although employing only low-NO_x burners, 30 % NO_x can be attained and employing only flue-gas recirculation, 15 % NO_x reduction can be attained.

Because of the addition of thermal NO_x and fuel NO_x, NO_x emissions of about 210 mg/Nm³ as a daily average will be reached by using this primary measure and typical COG compositions.

There are also more complex influences on NO_x emissions by other process parameters like:

- furnace area load (part load/full load)
- additional combustion of BF gas at the same time (lower combustion temperature)
- upper air injection.

Upper air injection as an additional measure

Upper air injection is used additionally in the combustion of the residual fuel to the assignment of low-NO_x burners with flue-gas recirculation, but in an existing plant it is less efficient.

Upper air injection as an alternative measure

One option would be a combination of a low-NO_x burner and flue-gas recirculation. Another possibility to burn the residual flue-gas is to fire one burner substoichiometrically and to provide the air needed for complete combustion afterwards. Compared to the first option, the NO_x reduction is only a third. Furthermore, technical problems may occur when injecting air steadily into the furnace to burn out the flue-gas completely by increasing CO near the walls which leads to corrosion.

Injection of reduction fuel

Another possibility of NO_x reduction is the injection of reduction fuel – for instance a mixture of recycled exhaust gas and natural gas – between the last burner level and the upper air. But this is not efficient with the usage of low-NO_x burners at the same time.

Air staging

Around the flame there are some combustion zones with a different amount of oxygen. Because of this, the combustion area is larger and the dwell time in the flame takes longer. The staging could be done directly in the burner or in the furnace area.

Fuel staging

Like in air staging, the fuel is introduced into the furnace area usually in two stages. The results of NO_x reduction are similar.

Achieved environmental benefits

With these measures, the NO_x reduction efficiencies given in Table 2.11 can be achieved.

Table 2.11: NO_x reduction efficiency for primary measures

Applied primary measure	NO _x reduction efficiency (%)
Low-NO _x burner	28
Flue-gas recirculation	13
Upper air injection for residual combustion with substoichiometric burners	23
Injection of reduction fuel	13
Low-NO _x burner plus flue-gas recirculation	38

Cross-media effects

No data submitted.

Operational data

No data submitted.

Applicability

Primary or process-integrated measures such as the installation of low-NO_x burner systems can be applied in new and fully revamped large combustion plants in the iron and steel industry.

Economics

No data submitted.

Driving force for implementation

No data submitted.

Example plants

Reference power plants: Voestalpine Stahl GmbH, Linz, Austria
TKS, Huckingen-Duisburg, Germany

Reference literature

[140, Eurofer 2009] [281, Eurofer 2007] More information about the reduction of NO_x by primary measures can be found in the Large Combustion Plants BREF (LCP) [282, EC 2006].

2.5.3.2 Reduction of NO_x by secondary measures**2.5.3.2.1 NO_x reduction by selective catalytic reduction (SCR)****Description**

Ammonia is injected into the flue-gas and it converts NO_x to molecular nitrogen (N_2) and water (H_2O). A temperature of more than 320°C is necessary to prevent ammonia salts from arising, which blocks the catalytic converter. Figure 2.16 shows the typical configuration of a catalytic NO_x converter.

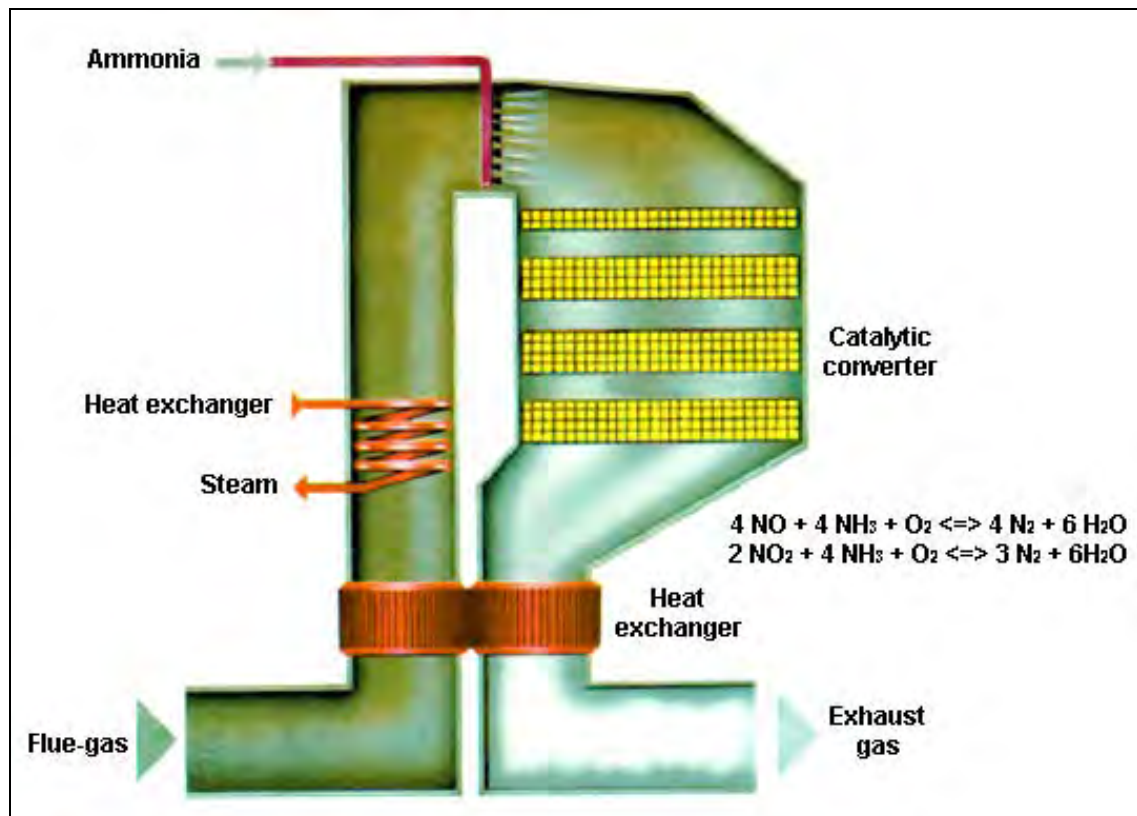

Figure 2.16: Catalytic NO_x converter

Depending on the position of the catalytic converter in the plant, there are three options:

- high dust technique
- low dust technique
- tail end technique.

In a high dust plant, the catalytic converter is built in between the economiser and the air preheater. The necessary catalytic reaction temperature is in the range of $300 - 400^\circ\text{C}$. Because of the wide variety of operating and gas inputs, a stable temperature is not given in a power plant of an integrated steelworks.

The high dust plant requires a lot of space because all of the exhaust gas must be treated at nearly 350°C . The exhaust gas is run through the catalytic converter outside the furnace area and has to be led back. Normally the concentration of NO_x (about 100 mg/Nm^3) is low and it is

therefore difficult to mix the NH₃ with the exhaust gas without a stationary mixer. Furthermore, in cold parts of the air preheater, the condensing sulphur will be converted to sulphur trioxide (SO₃), which can block the outlet of the preheater. Another disadvantage is the high content of dust.

In low dust plants as well as in tail end plants, the exhaust gas leaves the process behind the dust filter (e.g. ESP) with a temperature of only 50 – 130 °C. The flue-gas is nearly clean of dust, but it needs to be heated before it can enter the catalytic converter. This could be done by heating systems, additional burners or steam and the result is a loss of efficiency.

Achieved environmental benefits

As shown in Table 2.12, with the SCR technique, the NO_x emissions in the exhaust gas can be reduced to concentrations below 80 mg/Nm³ as an annual average.

Table 2.12: Performance data for five process gas-fired units using the SCR technique

Installation	NO _x (mg/Nm ³)		
	2005	2006	2007
Generating unit 3	28	21	18
Generating unit 4	36	24	25
Generating unit 5	29	17	23
Generating unit 6	71	76	66
Busbar	69	66	46
Gas und steam turbine ⁽¹⁾	15	16	17
⁽¹⁾ O ₂ reference content: 15 %. NB: — Annual averages. — O ₂ reference content: 3 %. Source: [32, Voestalpine Linz 2008].			

Cross-media effects

No data submitted.

Operational data

No data submitted.

Applicability

SCR is applicable at new and existing plants. In order to avoid negative cross-media effects (energy and chemicals consumption, additional investment costs), the SCR technique should be combined with primary measures.

Secondary measures to reduce NO_x might be difficult to retrofit into existing plants. In particular, the implementation for an SCR facility requires adequate space.

Economics

No data submitted.

Driving force for implementation

No data submitted.

Example plants

Voestalpine Stahl GmbH, Linz, Austria
 TKS, Duisburg-Hamborn, Germany

Reference literature

[32, Voestalpine Linz 2008] [140, Eurofer 2009] [277, Wiesenberger 2007]

More information about SCR can be found in the Large Combustion Plants BREF (LCP) [282, EC 2006], the Waste Incineration (WI) BREF [285, EC 2006] and the Cement, Lime and Magnesium Manufacturing Industries (CLM) BREF [212, EC CLM BREF 2009].

2.5.3.2.2 NO_x reduction by selective non-catalytic reduction (SNCR)

Description

Another technique to reduce NO_x emissions is selective non-catalytic reduction (SNCR). It does not require a catalyst, but a higher temperature level of about 900 to 1000 °C. The investment demand for SNCR is usually lower than for SCR (especially when the waste gas temperature is sufficiently high), but the consumption of reducing agents (e.g. NH₃ in water) is higher, due to thermal NO_x generation in this temperature range. The injection of the reducing agents should be done in different stages, just where the optimum temperature of a load range is. This might be difficult to control and it should be carefully tailored to the process.

Achieved environmental benefits

No data submitted.

Cross-media effects

No data submitted.

Operational data

No data submitted.

Applicability

No information on the application of SNCR in process gas-fired power plants has been submitted.

Economics

No data submitted.

Driving force for implementation

No data submitted.

Example plants

No data submitted.

Reference literature

[140, Eurofer 2009]. Information about SNCR can be found in the Large Combustion Plants BREF (LCP) [282, EC 2006], the Waste Incineration (WI) BREF [285, EC 2006] and the Cement, Lime and Magnesium Manufacturing Industries (CLM) BREF [212, EC CLM BREF 2009].

2.5.4 Material management

2.5.4.1 Techniques to improve the use of scrap

Description

EAF and BOF processes require different kinds of ferrous scrap according to different recipes and steel qualities. For this reason, the purchased or internally produced and recycled scrap should be stored separately. Scraps are qualified on the basis of their weight, size and chemical analysis. In the scrap terminal, there are separate bunkers for every different kind of scrap.

There are several techniques which can help the operators to refuse scraps which are not suitable for processing because of their content of heavy metals or other unwanted or hazardous

substances. Some of these techniques can help the operator in characterising the scrap that is used. The rigour with which this characterisation is carried out is essential to the subsequent operations (e.g. EAF, BOF). Failure to adequately screen and respect the acceptance procedures may cause unexpected emissions profiles.

Some techniques for improving the use of scrap include:

- specification of acceptance criteria suited to the production profile in purchase orders of scrap
- having a good knowledge of scrap composition by closely monitoring the origin of the scrap; in exceptional cases, a melt test might help characterise the composition of the scrap
- having adequate reception facilities and check deliveries
- having procedures to exclude scrap that is not suitable for use in the installation
- storing the scrap according to different criteria (e.g. size, alloys, degree of cleanliness); storing of scrap with potential release of contaminants to the soil on impermeable surfaces with drainage and collection system; applying a roof which can reduce the need for such a system
- putting together the scrap load for the different melts taking into account the knowledge of composition in order to use the most suitable scrap for the steel grade to be produced (this is essential in some cases to avoid the presence of undesired elements and in other cases to take advantage of alloy elements which are present in the scrap and needed for the steel grade to be produced)
- prompt return of all internally-generated scrap to the scrapyards for recycling
- having an operation and management plan
- scrap sorting to minimise the risk of including hazardous or non-ferrous contaminants, particularly PCB and oil or grease. This is normally done by the scrap supplier but the operator inspects all scrap loads in sealed containers for safety reasons. Therefore, at the same time, it is possible to check, as far as practicable, for contaminants. Evaluation of the small quantities of plastic (e.g. as plastic coated components) may be required
- radioactivity control (see Section 2.3.1)
- removal of components which contain mercury is a requirement of the End-of-Life Vehicles Directive (2000/53/EC) and Waste Electrical and Electronic Equipment (WEEE) Directive (2002/96/EC). This is an obligation for the scrap processors. The following two measures may help to increase the implementation:
 - fixing the absence of mercury in scrap purchase contracts
 - refusal of scrap which contains visible electronic components and assemblies.

Achieved environmental benefits

The knowledge of the quality of scrap increases the possibility of anticipating unexpected emissions. The exclusion of mercury will reduce mercury emissions.

With some of these techniques, the maximum amount of scrap used in the BOF was increased from 200 kg/t steel to 250 kg/t steel. A higher degree of scrap in the BOF converter results in an overall improved environmental and energy efficiency.

Cross-media effects

No data submitted

Operational data

No data submitted

Applicability

The practice is, in principle, applicable to all BOF and EAF plants which have to classify scrap qualities on the basis of weight and chemical analyses.

Economics

The full recycling of all internally-produced scrap and an increase in the overall scrap input can lead to cost savings. Increased steel production means a reduced amount of purchased slabs and better profitability.

Driving force for implementation

Some of the techniques mentioned here can help to increase steel production, to save costs and to reduce environmental impacts, which represent the driving forces for implementation.

Example plants

Ruukki Production, Raahe Works, Finland.

Most of the described techniques are common practice in all European countries for EAF and BOF plants.

Reference literature

[208, Lindfors et al. 2006] [240, UKEA 2004] [278, J-P.Birat et al. 2002] [260, Germany 2007] [273, Eurofer 2007] [280, Aguado-Monsonet 2007] [394, Colletta et al. 2002]

2.5.4.2 Techniques to reduce diffuse emissions from materials storage, handling, transport and blending

Description

The BREF on Emissions from Storage (EFS) [283, EC 2006] covers many of these areas in detail and it is strongly recommended that the reader refer to this document for details.

In integrated steelworks and electric arc furnace plants, diffuse primary emissions may arise from the unloading, storage, handling and transport systems. Secondary dust emissions arise from, e.g. the resuspension of dusty materials from storage areas or disposal points, suspension of dust from roadways due to traffic movements and the contamination of vehicle wheels and chassis.

Diffuse emissions, can also be emitted from the production processes themselves. Information on diffuse low-level sources other than material storage, handling and transport, e.g. on-site processing of residues, emissions released from insufficient extraction during crushing, screening, charging, melting, tapping, can be found in the specific sectors. These diffuse emissions are usually referred to as secondary off-gases.

Key techniques for minimising diffuse dust emissions for iron and steel works arising from the sources listed above are given below.

General techniques should include:

- the operation of steelworks under an environmental management system (EMS). Within the EMS of the steelworks, an associated diffuse dust action plan should be set up
- consideration of temporary cessation of certain operations where they are identified as a PM₁₀ source causing a high ambient reading. In order to do this, it will be necessary to have sufficient PM₁₀ monitors, with associated wind direction and strength monitoring, to be able to triangulate and identify key sources of fine dust.

Techniques for the prevention of dust releases during the handling and transport of bulk raw materials include:

- orientation of long stockpiles in the direction of the prevailing wind
- installing wind barriers or using natural terrain to provide shelter
- controlling the moisture content of the material delivered

- careful attention to procedures to avoid the unnecessary handling of materials and long unenclosed drops
- adequate containment on conveyors and in hoppers, etc.
- the use of dust-suppressing water sprays, with additives such as latex, where appropriate
- rigorous maintenance standards for equipment
- high standards of housekeeping, in particular the cleaning and damping of roads
- the use of mobile and stationary vacuum cleaning equipment
- dust suppression or dust extraction and the use of a bag filter cleaning plant to abate sources of significant dust generation
- the application of emissions-reduced sweeping cars for carrying out the routine cleaning of hard surfaced roads.

Techniques for materials delivery, storage and reclamation activities include:

- total enclosure of unloading hoppers in a building equipped with filtered air extraction for dusty materials or the hoppers should be fitted with dust baffles and the unloading grids coupled to a dust extraction and cleaning system
- limiting the drop heights if possible to a maximum of 0.5 m
- the use of water sprays (preferably using recycled water) for dust suppression
- where necessary, the fitting of storage bins with filter units to control dust
- the use of totally enclosed devices for reclamation from bins
- where necessary, the storage of scrap in covered, and hard surfaced areas to reduce the risk of ground contamination (using just in time delivery to minimise the size of the yard and hence emissions)
- minimisation of the disturbance of stockpiles
- restriction of the height and a controlling of the general shape of stockpiles
- the use of in-building or in-vessel storage, rather than external stockpiles, if the scale of storage is appropriate
- the creation of windbreaks by natural terrain, banks of earth or the planting of long grass and evergreen trees in open areas. This not only has aesthetic benefits, but such vegetation is able to capture and absorb dust without suffering long-term harm
- hydro-seeding of waste tips and slag heaps
- implementation of a greening of the site by covering unused areas with top soil and planting grass, shrubs and other ground covering vegetation which will minimise dust lift-off from these areas
- the moistening of the surface using durable dust-binding substances
- the covering of the surface with tarpaulins or coating (e.g. latex) stockpiles to minimise dust lift-off
- the application of storage with retaining walls to reduce the exposed surface
- when necessary, a measure could be to include impermeable surfaces with concrete and drainage.

Where fuel and raw materials are delivered by sea and dust releases could be significant, some techniques include:

- use by operators of self-discharge vessels or enclosed continuous unloaders. Otherwise, dust generated by grab-type ship unloaders should be minimised through a combination of ensuring adequate moisture content of the material is delivered, by minimising drop heights and by using water sprays or fine water fogs at the mouth of the ship unloader hopper
- avoiding seawater in spraying ores or fluxes as this results in a fouling of sinter plant electrostatic precipitators with sodium chloride. Additional chlorine input in the raw materials may also lead to rising emissions (e.g. of PCDD/F) and hamper filter dust recirculation

- storage of powdered carbon, lime and calcium carbide in sealed silos and conveying them pneumatically or storing and transferring them in sealed bags since they are highly drift sensitive and need to be kept dry.

Train or truck unloading techniques include:

- if necessary (dust emission), use of dedicated unloading equipment with a generally enclosed design

For highly drift-sensitive materials which may lead to significant dust release, some techniques include:

- use of transfer points, vibrating screens, crushers, hoppers and the like, which may be totally enclosed and extracted to a bag filter plant
- use of central or local vacuum cleaning systems rather than washing down for the removal of spillage, since the effects are restricted to one medium and the recycling of spilt material is simplified.

Techniques for the handling and processing of slags include:

- keeping stockpiles of slag granulate damp for slag handling and processing since dried blast furnace slag and steel slags can give rise to dust
- use of enclosed slag-crushing equipment fitted with efficient extraction of dust emissions and bag filters.

Techniques for handling scrap include:

- providing scrap storage under cover and/or on concrete floors to minimise dust lift-off caused by vehicle movements

Techniques to consider during material transport include:

- the minimisation of points of access from public highways
- the employment of wheel-cleaning equipment to prevent the carryover of mud and dust onto public roads
- the application of hard surfaces to the transport roads by concrete or asphalt to minimise the generation of dust clouds during materials transport and the cleaning of roads
- the restriction of vehicles to designated routes by fences, ditches or banks of recycled slag
- the damping of dusty routes by water sprays, e.g. at slag-handling operations
- ensuring that transport vehicles are not overfull, so as to prevent any spillage
- ensuring that transport vehicles are sheeted to cover the material carried
- the minimisation of numbers of transfers
- use of closed or enclosed conveyors
- use of tubular conveyors, where possible, to minimise material losses by changes of direction across sites usually provided by the discharge of materials from one belt onto another
- good practice techniques for molten metal transfer and ladle handling
- dedusting of conveyor transfer points.

Achieved environmental benefits

The environmental benefit of the use of techniques for reducing diffuse dust emissions from materials storage, handling, transfer and blending is the prevention of dust emissions.

Cross-media effects

No data submitted.

Operational data

No data submitted.

Applicability

No data submitted.

Economics

No data submitted.

Driving force for implementation

No data submitted.

Example plants

All UK iron and steel plants.

Reference literature

[31, Caughlin, R. 2009] [165, VDI/DIN 1999] [240, UKEA 2004] [283, EC 2006]

2.5.4.3 Techniques to control releases to water from raw materials handling, blending and mixing

Description

Rainwater runoff from all open areas, but in particular from ores, coal and raw material stocking areas, will contain suspended solids. This rainwater runoff should be intercepted and the suspended solids removed by settlement or other techniques. Arrangements should be made for monitoring the quality of the water discharged from the storage and blending areas where such discharges are in the vicinity of potentially vulnerable receptors.

Areas for the handling and storage of purchased scrap are potential sources of contaminated effluent due to the leaching of oil and chemicals by rainwater. The scrap should be stored on hard surfaced areas with an impermeable surface and an appropriate drainage system, including an interceptor trap prior to discharge, unless the environmental risk can be shown to be negligible (e.g. storing clean scrap).

Achieved environmental benefits

A reduction of emissions to water is an environmental benefit of this technique.

Cross-media effects

No data submitted.

Operational data

No data submitted.

Applicability

No data submitted.

Economics

No data submitted.

Driving force for implementation

No data submitted.

Example plants

All UK iron and steel plants.

Reference literature

[240, UKEA 2004]

2.5.4.4 Specialised recycling facilities for iron-rich residues**2.5.4.4.1 OxyCup® shaft furnace****Description**

The integrated OxyCup® plant comprises three modular operating parts: brick production, burdening facilities as well as the OxyCup® shaft furnace. The process starts with brick making and ends with hot metal supply to the steel plant. For brick production, sludge and dust from dedusting facilities which contain carbon, iron and iron oxide should be agglomerated together with other lumpy iron-bearing materials and coke. The briquetting is a cold process in which a binder and water as well as coke breeze is added to the fines, they are pressed to briquettes, dried and hardened. The cold bonded, self-reducing bricks are burdened at the top of the shaft furnace and reduced and melted to liquid iron. Hot metal and slag are tapped from the furnace as end-products.

Achieved environmental benefits

The external treatment or landfilling will be mostly replaced by integrated recycling in an OxyCup® shaft furnace. Another advantage of this method is the similarity to the original production facilities allowing process gases and slag to be integrated into the infrastructure of an integrated plant.

Cross-media effects

No data submitted.

Operational data

The OxyCup® shaft furnace in Duisburg-Hamborn in Germany produces 170 000 tonnes of hot metal per year.

Applicability

OxyCup® shaft furnaces are especially suited to integrated iron and steel works. This new process is qualified for the processing of all materials, like lumpy skull, but also for fine-grained dusts and sludge with sufficient recyclable potential in terms of their carbon and iron content.

Economics

The OxyCup® plant optimally combines environmental protection and cost effectiveness and makes a valuable contribution to sustainable development in order to improve resource efficiency.

Driving force for implementation

Higher ecological and economic efficiency due to sharp increases in prices for raw materials, external treatment as well as waste disposal are the driving forces for implementation.

Example plants

Thyssen Krupp Stahl, Duisburg-Hamborn, Germany

Reference literature

[6, Volkhausen, W. 2008] [10, Kessler, K. 2005] [12, VDEh 2006]

2.5.4.4.2 DK process**Description**

The DK process consists of a sinter plant and a blast furnace. The process differs from typical iron-making processes in the quality of the raw materials, so they require a different pre-treatment. More than 80 % of the raw materials used in the DK process consist of dusts and

sludges from the blast furnaces and BOF as well as mill scale. In addition, many other iron-rich residues can be and are used.

The first step in the preparation of the raw materials is to sinter them. In this process, dusts, sludges and mill scale are agglomerated as preparation for the burden to the blast furnace. In this agglomeration, the fine material is mixed with lime and coke breeze and a layer is put on a rotating pallet strand. A gas burner in an ignition furnace ignites the coke breeze in the upper layer. Following ignition, the combustion front (with a temperature of over 1300 °C) is drawn downwards through the layer by a suction pressure below the strand. The agglomeration process is finished when the combustion front has reached the bottom of the layer at the end of the strand. Then the agglomerates are removed and sent to a cooler.

After that, the sinter together with the coke as a reductant is processed into special foundry pig iron in the blast furnace. The liquid iron is cast on a pig caster and sold to foundries worldwide. Due to the high zinc content in the raw materials used in the DK process (2 – 3 % on average), the sludge cleaned from the blast furnace gas is recovered as a pure zinc concentrate which is used in the zinc industry.

Achieved environmental benefits

The DK process has been used since the beginning of the nineteen eighties when the facilities were adapted to the processing of steelwork residues. Since then, more than 5 million tonnes of waste materials have been processed, making a considerable contribution to environmental protection and to resource efficiency. Proof of the high value of the process is the fact that less than 4 % of the waste materials utilised end up as waste that needs to be landfilled.

Cross-media effects

The metallurgical conditions of the agglomeration step can result in PCDD/F emissions in the waste gas. Therefore, the waste gas is treated in several steps.

Zinc, alkalis and lead have an adverse effect on blast furnace operations and therefore special attention should be paid to them. They lead to a higher coke consumption, the formation of accretions and increased wear of the refractory material.

Operational data

- waste residue processing: 500 000 tonnes/yr
- pig iron production: 300 000 tonnes/yr
- blast furnace slag production: 120 000 tonnes/yr
- zinc concentrate production: 20 000 tonnes/yr.

Applicability

The DK process can be used for processing dusts and sludges from the BOF and blast furnaces. Furthermore, mill scale and other iron-rich residues can be utilised. The zinc content can be up to 10 % (2 – 3 % on average).

Economics

The use of pig iron in the foundry industry as well as the zinc concentrate in the zinc industry guarantees a qualitatively high value and long-lasting usage of the products that are created. Landfilling is replaced by recycling in the DK process.

Driving force for implementation

Avoiding the depositing of waste materials and the promotion of the recycling of iron and zinc residues are the driving forces for implementation.

Example plants

DK Recycling und Roheisen GmbH, Duisburg, Germany

Reference literature

[8, Endemann, G. 2008] [12, VDEh 2006] [17, Hillman, C. and Sassen, K.-J. 2006]

2.5.4.4.3 Smelting reduction processes

Description

In general, the pyrometallurgical smelting reduction of metals from oxidic residues requires a reduction of the relevant oxides (normally using carbon as a reductant) and a subsequent melting to separate the metals from the other slag-forming components.

There are two different types of processes (the Primus[®] technique and the Redsmelt[®] process) which are described below.

The Primus[®] technique using a two-step process, consists of the combination of a multiple hearth furnace (MHF) (the Primus[®] Pre-Reduction Unit) aiming to dry, heat up and initiate reduction followed by an electric arc furnace (EAF) (the Primus[®] Melting Unit) leading to complete iron reduction and providing hot metal, slag formation and the finalisation of zinc reduction. This technique permits the treatment of all typical iron and steelmaking residues which cannot normally be recycled within the existing plant, such as EAF dust, BF sludge, steelworks sludge and oily mill scale sludge.

In the MHF, the mix of residues (pre-pelletised if very fine), and coal are charged from the top. Rotating arms stir and transport the charge, which is dropped from one hearth to the next while being dried, preheated and pre-reduced by a countercurrent flowing stream of gas.

The carbon for reduction and the energy for the process are entirely supplied by the volatile coal.

The subsequent melting unit (a specially-designed EAF) is continuously hot-charged through a chute between the electrodes. Complete reduction, iron and slag melting and full de-zincing are achieved in this electric smelter. Zinc and lead are transferred to the off-gas system and recovered as a marketable zinc oxide concentrate. The iron content of the feed material is recovered as liquid pig iron or tapped in a pig-caster. The resulting slag, similar to blast furnace slag, can be used for road construction.

In the Redsmelt[®] process, the residues are pelletised together with the carbon reductant (anthracite or low-volatile coal), pre-reduced in a single rotary hearth furnace (RHF) and then hot-charged in an electric furnace for melting.

The pellets are uniformly spread onto the rotary hearth in a thin layer and are processed in a single furnace revolution, using gas burners for energy supply. This pre-reduction furnace is also followed by an electric smelter.

Achieved environmental benefits

The process achieves total recovery of iron, zinc and lead and a slag which can be used for road construction thus avoiding the landfilling of these process residues.

Cross-media effects

No data submitted.

Operational data

The two types of pre-reduction furnaces (MHF and RHF) have different abilities.

MHF can handle wet and oily materials as well as materials with a high content of zinc and needs simpler material preparation and consumes less fuel. During transfer through the MHF, the intense mixing of the input materials promotes their rapid heating and hence maximises process productivity. Metal oxides undergo pre-reduction by CO and H₂. The energy requirement for the pre-reduction process is basically supplied by the combustion of coal volatiles and the post-combustion of CO evolved during pre-reduction. Table 2.13 gives some operational data for the Primus[®] plant in Differdange, Luxembourg.

Table 2.13: Operational data for the Primus[®] plant at Differdange designed for a nominal throughput of 10 tonnes per hour

	Data	Unit
Multiple hearth furnace (Pre-reduction unit)		
Hearth internal diameter	7.7	m
Number of hearths	8	–
Operating temperature range	800 – 1000	°C
Coal consumption	300	kg/t
Electric arc furnace (Melting unit)		
Vessel internal diameter	3.5	m
Electrical power	10	MW _e
Operating temperature	1500	°C
Electricity consumption	800 – 900	kWh/t
Source: [140, Eurofer 2009].		

The Primus[®] plant at Primorec S.A, Differdange, Luxembourg consists of an eight-hearth MHF and three-phase AC arc melting furnace, equipped with a full off-gas treatment for zinc recovery. The off-gases from the MHF and the EAF are merged and dedusted by a bag filter. Volatile metals are extracted from the melting and pre-reduction units and recovered in the bag filter. After the injection of lime and activated carbon, a second cleaning step takes place before the emissions are released via the stack. Table 2.14 shows the achieved clean gas concentrations for the main directed off-gas flow.

Table 2.14: Achieved clean gas concentrations for the directed Primus[®] process off-gas (MHF and EAF)

Parameter	Unit ⁽¹⁾	Average ⁽²⁾
Flow	m ³ /h	113000
HCl	mg/m ³	1.30
HF	mg/m ³	0.09
CO	mg/m ³	295
NO _x as NO ₂	mg/m ³	85
SO ₂	mg/m ³	10
TOC	mg/m ³	6
Dust	mg/m ³	0.3
As	mg/m ³	<0.0027
Pb	mg/m ³	<0.0064
Cd	mg/m ³	<0.0008
Cr	mg/m ³	<0.0047
Co	mg/m ³	<0.0017
Cu	mg/m ³	<0.0108
Mn	mg/m ³	<0.0035
Ni	mg/m ³	<0.0019
Hg	mg/m ³	0.0621
V	mg/m ³	<0.0021
Zn	mg/m ³	<0.0567
Sum of heavy metals	mg/m ³	0.1534
PCDD/F (I-TEQ)	ng/m ³	0.0001
PAH (EPA)	µg/m ³	0.829
Sum PCB ⁽³⁾	µg/m ³	0.07
⁽¹⁾ Related to the volume of waste gas under standard conditions (273 K, 1013 mbar). ⁽²⁾ Average of three half-hourly mean values. ⁽³⁾ Sum of PCB28, PCB52, PCB101, PCB118, PCB153, PCB138, PCB180. NB: Measurements from November 2007. Source: [139, GfA Münster-Roxel 2008].		

Table 2.15 shows the achieved clean gas emission concentrations for the extracted MHF and EAF doghouse off-gas emissions after cleaning by a bag filter. The cleaned off-gas is released via the stack together with the cleaned directed off-gas.

Table 2.15: Achieved clean gas concentrations for the doghouse Primus[®] process off-gas (MHF and EAF)

Parameter	Unit ⁽¹⁾	Average ⁽²⁾
Flow	m ³ /h	50000
HCl	mg/m ³	1.06
HF	mg/m ³	0.02
CO	mg/m ³	37
NO _x as NO ₂	mg/m ³	<4
SO ₂	mg/m ³	9
TOC	mg/m ³	6
Dust	mg/m ³	<0.1
As	mg/m ³	<0.0060
Pb	mg/m ³	<0.0074
Cd	mg/m ³	<0.0007
Cr	mg/m ³	<0.0040
Co	mg/m ³	<0.0018
Cu	mg/m ³	<0.0111
Mn	mg/m ³	<0.24
Ni	mg/m ³	<0.0028
Hg	mg/m ³	0.0005
V	mg/m ³	<0.0028
Zn	mg/m ³	<0.044
Sum of heavy metals	mg/m ³	0.32
PCDD/F (I-TEQ)	ng/m ³	<0.00013
PAH (EPA)	µg/m ³	43.8
Sum PCB ⁽³⁾	µg/m ³	<0.07

(¹) Related to the volume of waste gas under standard conditions (273 K, 1013 mbar).
(²) Average of three half-hourly mean values.
(³) Sum of PCB28, PCB52, PCB101, PCB118, PCB153, PCB138, PCB180.
NB: Measurements from November 2007.
Source: [139, GfA Münster-Roxel 2008].

An RHF can work at a higher temperature (as material sticking is not as problematic with unstirred materials), therefore a higher metallisation degree can be achieved with it. Moreover, as it can be built up to a very large diameter, the capacity for a single unit can be much greater.

Applicability

The Primus[®] Process permits the treatment of all typical iron and steel making residues and additionally non-ferrous metals residues. It can be applied by a mini-mill and by integrated steelworks operators who want to reduce waste disposal costs and efficiently recycle residues.

Economics

No data submitted.

Driving force for implementation

Avoiding the depositing of waste materials and the promotion of the recycling of iron and zinc residues are the driving forces for the implementation of this technique.

Example plants

- Primus[®] plant at Primorec S.A, Differdange, Luxembourg which processes 60 000 tonnes EAF dust and 15 000 tonnes of rolling mill sludge per year
- Dragon Steel Corporation Taiwan decided on the implementation of a 100 000 tonnes per year Primus[®] plant aiming to treat EAF dust, blast furnace sludge as well as mill scales. The plant started in April 2009
- several RHF installations are in operation in Japan
- the first European plant is being operated at the Lucchini steelworks in Piombino, Italy, processing 60 000 tonnes per year of integrated steelmaking sludge. The installation will be started in summer 2009. In this case, the melting step will be done in the blast furnace of the Lucchini plant.

[139, GfA Münster-Roxel 2008] [140, Eurofer 2009]

Reference literature

[12, VDEh 2006] [15, Both, I. et al 2008] [139, GfA Münster-Roxel 2008] [140, Eurofer 2009]

2.5.4.4.4 Cold bonded pellets/briquettes

Description

In some integrated steelworks in Europe, the blast furnace burden consists mostly of pellets supplied from outside of the works and no sinter is used. Under these circumstances, ore fines can be generated from handling and screening operations that, if agglomerated, could be returned to the iron making process. One means of returning these ore fines to the iron making operation together with other materials which contain Fe and/or carbon arising in the works is to agglomerate them using cold bonding techniques.

Usually a cold pelletising/briquetting plant consists of the following units:

- input material handling, storage in silos and bins and protective screening
- pre-drying of filter cakes
- mixing and dosing of binders
- a press or block-making machine for pelletising/briquetting
- screening of fines
- a curing chamber and storage of briquettes for internal use.

The various residues as received from the iron and steel works should be stored separately so that a controlled mix for the briquette can be obtained.

Depending on the types of cold bonded agglomerates made, different residues are used. In one case, the cold bonded agglomerates are made from materials which contain carbon such as BF off-gas dust and coke breeze. Other briquette types are made with materials which contain predominantly iron such as pellet fines, fine scrap, mill scale and other residues such as BOF sludge, BOF/BF dusts and BOF slag fines.

The residues are mixed, alloying elements can be added and cement, hydrated lime and molasses can be used as a binder. The homogenised mixture is fed to the briquette press or a block-making machine and the briquettes produced are screened using a vibrating screen. Subsequently the briquettes are transferred to the curing chamber. After 24 hours of curing, the hardening of the briquettes is completed. The briquettes have to be stored for over three weeks in a sheltered area under cover (roof) for curing to achieve high-strength briquettes.

The production and use of cement bonded briquettes started around 1975 and since 1993 these briquettes have become an important constituent of the BF burden (about 40 – 50 kg/t of hot

metal in Sweden in 2004). The amount of briquettes used is largely dependent on the availability of on-site materials but there have been cases with amounts above 100 kg/t of hot metal in the burden. The block-making machine technique started operation in 1993 at SSAB Tunnpåt and in 1996 at SSAB Oxelösund [208, Lindfors et al. 2006].

Achieved environmental benefits

Iron-bearing materials are recycled thus reducing the material amount to landfill which saves primary raw material and avoids costs for dumping or waste processing. Cold bonded pellets/briquettes cannot completely replace sinter or pellet agglomerates.

Cold bonding techniques do not emit SO_x or NO_x.

Cross-media effects

The return of on-site fines decreases the potential requirement for deposit to landfill and the use of virgin material. Dust separated during briquetting is recycled into the briquetting plant.

Operational data

In the case of ILVA Steelworks, Rivagroup, Taranto, Italy the emissions from briquetting are dedusted with a bag filter. A dust concentration of 10 – 20 mg/Nm³ in the waste gas after abatement is achievable.

Applicability

Cold briquetting can be applied both at new and existing plants. These techniques could be applied at any integrated plant but are most suited for works without sinter plants. The production of briquettes is a conventional technique and their use in the BF burden or in the BOF is reliable and well established.

Economics

The recovery of valuable iron units and the avoidance of costs associated with disposal are strong economic drivers.

The total investment for the cold briquetting plant at ILVA Steelworks, Rivagroup, Taranto, Italy for the BOF with a capacity of 150000 t/yr is about EUR 7 million – 8 million.

Driving force for implementation

The driving forces for implementation are environmental benefits and the savings of space and costs for landfill as well as the cost of a sinter plant.

Example plants

At presents, the following three works operate cold bonded briquettes schemes to return materials to the blast furnace or in the case of ILVA Steelworks, Rivagroup, Taranto, Italy to the BOF:

- SSAB Tunnpåt AB, Luleå, Sweden
- SSAB Oxelösund AB, Sweden
- ILVA Steelworks, Rivagroup, Taranto, Italy.

Reference literature

[29, EC Sinter/BF 1995] [208, Lindfors et al. 2006] [276, Italy 2007] [319, Eurofer 2007] [363, Eurofer 2007]

2.5.5 Monitoring in iron and steel plants

[277, Wiesenberger 2007]

2.5.5.1 Continuous parameter and air emissions monitoring

Description

In modern steelworks, most processes are monitored and controlled from control rooms by means of modern, computer-based systems. In order to optimise the processes, to increase energy efficiency and maximise the yield, relevant parameters should be determined and adjusted continuously online.

Additional continuous monitoring of emissions from relevant sources allows for accurate quantification of the emissions and, in the case of poor performance of abatement systems, for taking prompt action.

Important parameters which should be measured continuously from relevant sources of the iron and steel manufacturing processes include:

- pressure
- temperature
- O₂ content
- CO
- input material flows
- output material flows.

Additional information on the description of continuous monitoring systems can be found in the Reference Document on General Principles of Monitoring (MON) [42, EC 2003].

Achieved environmental benefits

In the case of poor performances of the abatement systems, prompt action can be taken. Overall emission can be reduced. Continuous measurements allow for accurate quantification of the emissions from relevant sources.

Cross-media effects

Continuous measuring allows for optimising the production processes, to minimise the energy demand and to maximise the yield.

Operational data

No data submitted.

Applicability

For relevant emission sources at iron and steel plants, the main pollutants are usually monitored continuously. To determine what could be meant by a relevant emission source, an example of mass flow thresholds is given in Annex IV in Section 13.4.

Economics

No data submitted.

Driving force for implementation

No data submitted.

Example plants

Examples for continuously measured air emissions for Voestalpine Stahl GmbH, Linz, Austria are presented in Table 2.16. In this case the data are transferred online to the local authorities [26, Oberösterreichische Landesregierung 2004]. Also in Germany in iron and steel plants, all relevant emission parameters are monitored continuously, and usually the measurement results (daily or half-hourly averages as required in the permit) are transferred online to the competent local authorities [175, Eurofer 2009].

Table 2.16: Examples for continuously measured air emissions at Voestalpine Stahl, Linz, Austria

Plant	Potential emissions source	Relevant pollutants						Reference O ₂
		Dust	NO _x	SO ₂	CO	H ₂ S	HF	
		mg/Nm ³						
Coke oven	H ₂ S in coke oven gas					X ⁽¹⁾		
	Sulphuric acid plant			X				
Sinter plant ⁽²⁾	Sinter strand	X	X	X			X	
	Dedusting of building	X						
Blast furnaces	Cast house dedusting BF 5 & 6	X						
	Cast house dedusting BF A	X						
BOF plant	Dedusting unit 1	X		X ⁽³⁾				
	Secondary dedusting 2.1	X						
	Secondary dedusting 2.2	X						
Power plant	Unit 3		X	X	X		3 %	
	Unit 4		X	X	X		3 %	
	Unit 5		X	X	X		3 %	
	Gas and steam turbine		X	X	X		15 %	
	Unit 6		X	X			3 %	

(¹) Hourly average value.
(²) According to the permit, Hg has to be monitored continuously at the reference plant due to local considerations (high content of Hg in the ore). Trials are still ongoing.
(³) As of 06/2007, the current emission limit value was under revision. Continuous measurements should be performed for SO₂ emissions.
NB: — Status 06/2007. Emissions which are measured discontinuously are not included in the table. Permit conditions might change in the course of the actual environmental impact assessment 'Voestalpine L6'.
— Where limit values have been set up, they are marked with an X (based on half-hourly average values).

In the UK, the coke ovens for dust emissions from under firing are monitored continuously by obscuration meters and in sinter plants the dust emissions are monitored continuously. In blast furnaces, the monitoring of the cooling water flow is of relevance. SO_x, NO_x, dust and CO are monitored on hot stove releases. Releases of dust from cast houses are monitored.

Reference literature

[26, Oberösterreichische Landesregierung 2004] [242, Caughlin 2007] [277, Wiesenberger 2007]

2.5.5.2 Examples of continuous monitoring of ducted air emissions

2.5.5.2.1 Continuous measurement of dust emissions from secondary dedusting systems in basic oxygen furnaces

Description

The monitoring system at SSAB Oxelösund AB, Sweden allows for a continuous control of the bag filter performance. The measurement results are reported daily, weekly and monthly. The BOF operations (charging, blowing, tapping) are very closely controlled.

A continuous dust measurement system is installed in the exhaust gas system after the secondary dedusting filter. There are two instruments for measuring dust emissions in the channels following the secondary dedusting filter and another two in the roof openings. The measuring principle is gravimetric (mg/Nm³). The equipment is calibrated once per year by an

external company. The collected data are saved in SSAB’s own database. The control of the bag filter function is done by SSAB’s own operators. Revision is made once per year. The fluorescence method is used to detect leakage.

Dust emissions from the LD furnace (BOF) (excluding primary off-gas) are also closely monitored. The emissions are reported during three separate process phases: charging, blowing and at other times.

Achieved environmental benefits

In the case of poor performances of the secondary dedusting system, prompt action can be taken. Overall emissions can be reduced. Figure 2.17 shows the weekly averages which have been achieved with the aforementioned monitoring system over a period of one year.

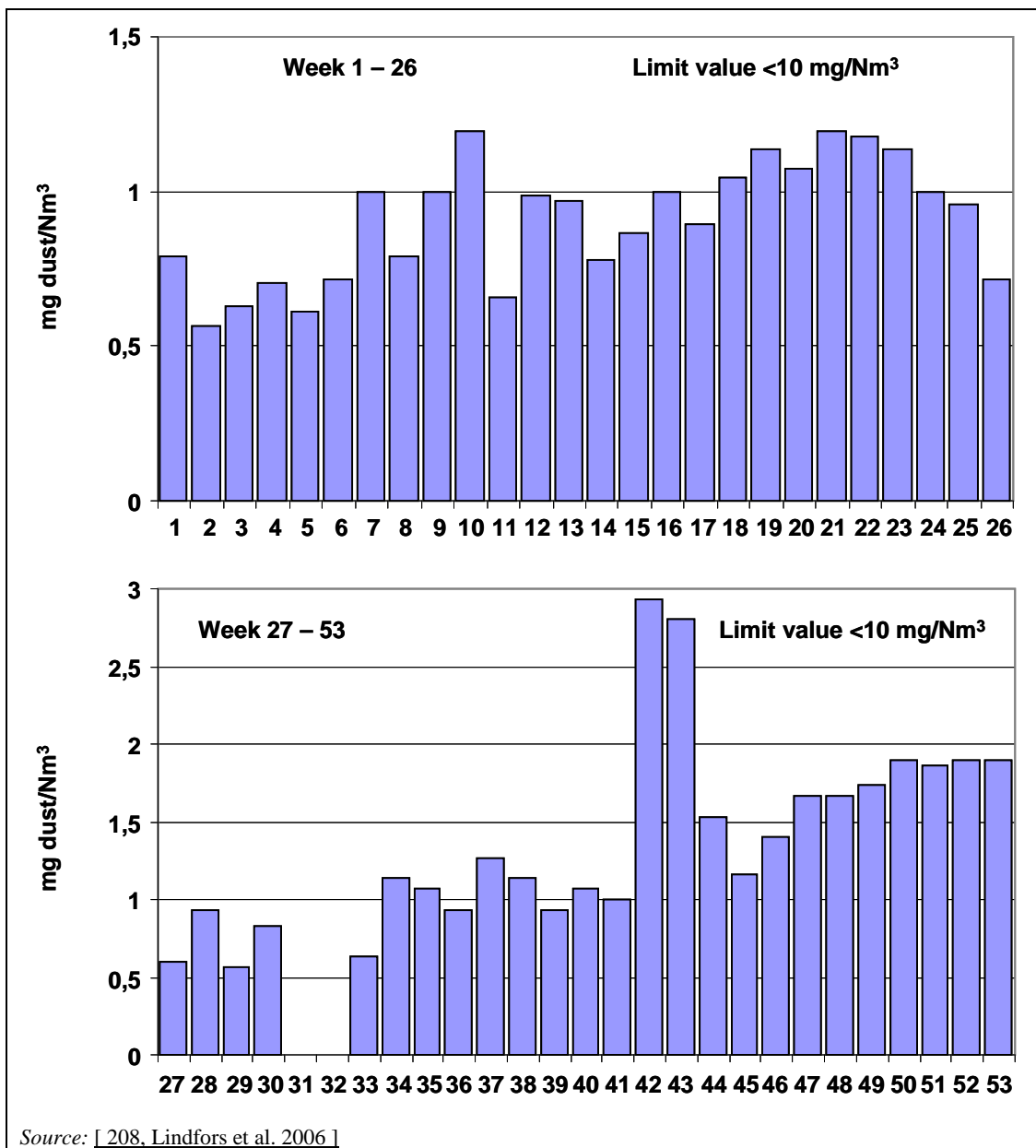

Figure 2.17: Dust quantities from secondary dedusting systems presented as weekly averages

Cross-media effects

No data submitted.

Operational data

The system calibration according to the measured values happens once a year. The calibration period takes two days.

Applicability

The technique is applicable for both new and existing steel plants.

Economics

No data submitted.

Driving force for implementation

No data submitted.

Example plants

SSAB Oxelösund AB, Sweden.

Reference literature

[208, Lindfors et al. 2006]

2.5.5.2.2 Continuous monitoring of downstream bag filters in EAF plants

[208, Lindfors et al. 2006]

Description

The EAF steelworks at Ovako Imatra, Finland consists of a whole building evacuation and a separate dust suction from the EAF itself. The filter plant installation is equipped with efficient spark arresting and cyclones, from which the dust (>5 micron, 30 % of the total amount) is charged back to the EAF together with the scrap. The main fans (average 620000 Nm³/h) have a rotation speed control. The bag house has a conservative (large) dimensioning (9400 m²) and the filter bags are a normal needle felt type with PTFE coating. The filter bags are cleaned with a pulse-jet system.

Continuous monitoring and a careful service of the bag house works in the ways given below:

- it monitors dust emissions, without any real calibration. It is important to detect any change of emissions level (leakage in one bag can immediately be detected)
- it continuously monitors via two separate instruments:
 - a tribometric measuring system – SINTROL[®]
 - an optical measuring system – SICK[®] [360, Sick-Maihak 2006]
- it visually checks all bags for spark holes and intensity: every second week, one worker for three hours. The clean side of the bags should be kept totally clean. Holes of 1 mm diameter can be detected without difficulty so no fluorescence method is needed.

Achieved environmental benefits

In the case of poor performances of the bag filter system, prompt action can be taken. Overall emissions can be reduced.

Cross-media effects

This measure also provides clean surroundings inside and outside the steel plant.

Operational data

No data submitted.

Applicability

The monitoring system is well applicable to both new and existing plants and should be applied to large EAF plants. To determine the definition of ‘large EAF’ as a relevant emission source, an example for mass flow thresholds is given in Annex IV.

Economics

No data submitted.

Driving force for implementation

The driving forces for implementation are the environmental benefits associated with the technique.

Example plants

Ovako Imatra, Finland.

Reference literature

[208, Lindfors et al. 2006] [242, Caughlin 2007]

2.5.5.3 Monitoring of process gases

Description

At Voestalpine Stahl GmbH, Linz, Austria, the monitoring of process gases is required according to the permit of the environmental impact assessment. Table 2.17 presents the conditions of the permit. Data are regularly transferred to the local authorities.

Table 2.17: Example of permit conditions for the monitoring of process gases at Voestalpine Stahl, Linz, Austria

Measurement	Blast furnace gas ⁽¹⁾		Coke oven gas ⁽¹⁾		BOF gas ⁽¹⁾	
	Continuous ⁽²⁾	Discont.	Continuous ⁽²⁾	Discont.	Continuous ⁽²⁾	Discont.
H ₂	x		x		x	
CO	x		x		x	
CO ₂	x		x		x	
Hydrocarbons			x ⁽³⁾			
N (chem. bond)			x ⁽³⁾			
Cl (total)	x ⁽³⁾					
S (total)	x ⁽³⁾		x ⁽³⁾		x ⁽³⁾	
Hg		x ⁽⁴⁾		x ⁽⁴⁾		
Pb		x ⁽⁴⁾		x ⁽⁴⁾		x ⁽⁴⁾
Cr		x ⁽⁴⁾		x ⁽⁴⁾		x ⁽⁴⁾
Cd		x ⁽⁴⁾		x ⁽⁴⁾		x ⁽⁴⁾
Ni		x ⁽⁴⁾		x ⁽⁴⁾		x ⁽⁴⁾
F (total)		x ⁽⁴⁾				
Dust (total)		x ^{(1) (5)}		x ⁽⁴⁾		x ⁽⁴⁾

⁽¹⁾ No limit values are set (status 06/2007).
⁽²⁾ Continuous measurements should be performed under the condition that approved instruments are available on the market (status 06/2007) [26, Oberösterreichische Landesregierung 2004].
⁽³⁾ As of 06/2007, no instruments for continuous measurements were available for Cl (total) and N (chem. bond). As regards hydrocarbons, CH₄ and higher hydrocarbons were measured discontinuously. Methods for the continuous measurements of S (total) are still under evaluation. For discontinuous measurements, intervals are set depending on the parameter, typically monthly; Voestalpine Stahl GmbH, Linz, Austria [26, Oberösterreichische Landesregierung 2004]
⁽⁴⁾ Contents of heavy metals (Hg, Pb, Cr, Cd, Ni), dust and fluorides have to be measured discontinuously, typically four times per year (status 06/2007).
⁽⁵⁾ In the case of plastic injection which is performed at one BF, dust has to be measured continuously. Trials on this are still ongoing.

Source: [26, Oberösterreichische Landesregierung 2004] [277, Wiesenberger 2007].

Achieved environmental benefits

The monitoring of process gases provides information about the composition of process gases and about indirect emissions from the combustion of process gases, such as emissions of dust, heavy metals and SO₂.

Cross-media effects

No data submitted.

Operational data

The quality (calorific value and cleanliness) and volume of the different process gases varies significantly and these factors have an impact on where the fuels can be usefully applied. To optimise energy efficiency, each type of fuel gas must be consumed at the most appropriate plant. For this reason, gases should be analysed continuously.

Applicability

This technique is considered to be generally applicable.

Economics

No data submitted.

Driving force for implementation

No data submitted.

Example plants

Voestalpine Stahl GmbH, Linz, Austria.

Reference literature

[277, Wiesenberger 2007]

2.5.5.4 Discontinuous monitoring of ducted air emissions**Description**

Regular, periodic discontinuous measurements at relevant, channelled sources are carried out for the following pollutants (some of them as a total and their relevant chemical oxidation states):

- Dust
- SO₂
- NO_x
- CO
- Heavy metals such as Hg, Tl, Cd, As, Co, Ni, Se, Te, Pb, Cr, Cu, Mn, V, Sn
- TOC
- VOC
- NMVOC
- BTX
- H₂S
- HCl
- HF
- CN
- NH₃
- PCDD/F
- PAH (e.g. EPA 16, Borneff 6)
- PCB (e.g. Ballschmitter PCB, WHO-TEF, total PCB).

However, it is also possible to measure and monitor TOC, NH₃, HCL, and HF continuously and to sample PCDD/F and PCB continuously for analysis from 1 to 30 days.

The measuring frequency varies strongly across the Member States. The resulting emission value should be regarded as an average over the sampling period which is normally at least half an hour. For PCDD/F, the sampling period is usually between 6 and 8 hours.

Table 2.18 gives some examples of important measuring methods for discontinuous emission monitoring.

Table 2.18: Examples of measuring methods for discontinuous emission monitoring

Component in the flue-gas	Measuring method
Dust	EN 13284-1 (<50 mg/m ³) or ISO 9096 (>20 mg/m ³) VDI 2066 part 1 for low and high concentrations Ö-NORM M 5861 NF X 44-052
SO ₂	EN 14791 identical to VDI 2462 part 3 VDI 2462 part 1
NO _x as NO ₂	EN 14972 VDI 2456, manual method
CO	EN 15058 VDI 2459, manual method
Metals (As, Cd, Co, Cr, Cu, Hg, Mn, Ni, Pb, Sb, Se, Tl, V, Zn)	EN 14385 identical to VDI 3868 part 1
TOC	EN 12619 for low concentrations, EN 13526 for high concentrations, VDI 3481 part 1, manual method
Hg	EN 13211
H ₂ S	VDI 3486 US EPA Method 11
HCl	EN 1911
HF	VDI 2470 part 1 ISO 15713
NH ₃	VDI 3496, based on EN 14791
PCDD/F and PCB	EN 1948 VDI 3499, additional for higher concentrations
PAH	VDI 3873 part 1 ISO 11338
<i>Source: [200, Commission 2001] [277, Wiesenberger 2007].</i>	

Achieved environmental benefits

No data submitted.

Cross-media effects

No data submitted.

Operational data

No data submitted.

Applicability

Discontinuous measuring and the corresponding measuring methods are considered to be generally applicable.

Economics

No data submitted.

Driving force for implementation

No data submitted.

Example plants

Applied at many plants, e.g., at Voestalpine Stahl GmbH, Linz, Austria and German iron and steel plants.

In the UK in sinter plants, NO_x and SO_x are monitored quarterly. Dioxin monitoring is carried out between two and four times per year.

Reference literature

[242, Caughlin 2007] [277, Wiesenberger 2007]

2.5.5.5 Monitoring of PCDD/F

Description

[209, EC 2005]

For the determination of dioxin and dioxin-like PCB loads in flue-gas, different methods exist. The sampling conditions and the analysis method to be used depend on the existing process and the flue-gas parameters. Substantial parameters are:

- the dioxin concentration range
- dust load of the flue-gas
- temperature range
- the amount of carbon particles in the flue-gas
- changing process conditions, e.g. continuous or batch process, unsteady operation
- the potential for memory effects.

For manual sampling, EN 1948 is the European standard guideline. The guideline describes the determination of the mass concentration of dioxins and dioxin-like PCB from stationary sources. This guideline is developed and validated for waste incineration plants to check the compliance to the emission limit value of $0.1 \text{ ng I-TEQ/Nm}^3$. In many European countries, EN 1948 is the basis for national standard guidelines for the determination of dioxin emissions (e.g. CSN EN 1948; DIN EN 1948 and VDI of 3499, etc.). VDI 3499 parts 1 – 3 is the German standard guideline for the determination of dioxin emissions from stationary sources. The guideline describes two measurement procedures:

- Part A is an example for the application of DIN EN 1948 for PCDD/F emissions at levels of about $0.1 \text{ ng I-TEQ/Nm}^3$
- In Part B, the measurement method is modified for PCDD/F concentrations in excess of $0.1 \text{ ng I-TEQ/Nm}^3$. Only the determination of the PCDD/F content of flue-gases is validated. The determination of other organic pollutants (e.g. PCB) is possible as well, but is not yet validated.

Besides EN 1948, there are further standardised sampling methods which are used in the EU. For example, EPA 23 A which is a manual sampling method valid in the US, has been developed for the determination of the dioxin emissions from stationary sources of waste incineration plants.

Achieved environmental benefits

In case of rising emissions or even in excess of the specified ELV, prompt action can be taken to identify the reasons and thus reduce the emission level.

Cross-media-effects

No data submitted.

Operational data

For PCDD/F, the sampling period is usually between 6 and 8 hours.

Applicability

In practice, the manual (discontinuous) standardised and validated measurement methods (e.g. EN 1948) are used. These measurement methods, developed for waste incineration plants, are transferable to the metallurgical industry and are already in use there.

Regular, periodic discontinuous measurements at relevant sources are generally applicable.

Economics

Table 2.19 gives the costs for sampling and analysing PCDD/F and dioxin-like PCB.

Table 2.19: Total cost for a PCDD/F measurement according to EN 1948

Method	Cost range (EUR)
Manual sampling according to EN 1948 – one sample (one day) inclusive PCDD/F analysis without travel cost	1800 – 3500
Manual sampling according to EN 1948 – three samples (three days) inclusive PCDD/F analysis without travel costs	4000 – 6500
PCDD/F – analysis (EN 1948)	450 – 800
Dioxin-like PCB – WHO PCB (EN 1948)	110 – 600

Driving force for implementation

Driving forces for implementation are to reduce the uncertainty on current dioxin emission data, in the iron and steel making industry and to ensure an appropriate awareness and monitoring of dioxin emissions by competent authorities at the national, regional and local level.

Example plants

Table 2.20 presents requirements for dioxin monitoring in various Member States [209, EC 2005].

Table 2.20: Monitoring frequency for PCDD/F in the metallurgical industry in various Member States

MS	Monitoring frequency
Austria	Once every three years for iron and steel plants, for new sinter plants once every three years (once every six years if very low); existing sinter plants case by case
Belgium	Three times per year according to law, once every month for sinter plants, six times a year for EAF
France	Once a year at least
Germany	Once a year to once every three years
Luxembourg	Once to twice a year and one or two additional measurements
Netherlands	No information; criterion: raw gas >2 g I-TEQ/yr
Slovenia	Once a year
United Kingdom	Dioxin monitoring is carried out between two and four times per year
<i>Source: [209, EC 2005] [242, Caughlin 2007] [277, Wiesenberger 2007].</i>	

Reference literature

[209, EC 2005] [242, Caughlin 2007] [277, Wiesenberger 2007]

2.5.5.6 Monitoring of diffuse and fugitive emissions

[252, France 2007]

Diffuse emissions can be estimated by [56, Dr. Gaertner, A. 2004] the ways listed below:

- direct measurement methods where the emissions are measured at the source itself. In this case, concentration and mass streams can be measured or determined
- indirect measurement methods where the emission determination takes place at a certain distance from the source. A direct measurement of mass stream and concentration is not possible
- calculation with emission factors.

2.5.5.6.1 Direct or quasi-direct measurement

Examples for direct measurements are measurements in wind tunnels, with hoods or other methods like the quasi-emissions measurement, i.e. on the roof of an industrial installation. In this case, the wind velocity and the area of the roofline vent are measured and a flow rate is calculated. The cross-section of the measurement plane of the roofline vent is subdivided into sectors of identical surface area (grid measurement). The sampling equipment employed must be designed for an infinitely variable suction control. By selecting different sampling probe diameters, the sample flow rate can be adapted to the prevailing off-gas flow velocity. The dust in the gas streams is collected on a filter medium and determined by gravimetric methods. Together with the off-gas evaluation, a dust concentration and a dust mass stream can be derived [56, Dr. Gaertner, A. 2004]. If a cascade impactor is used, different size fractions can be determined. If feasible, direct measurements are preferable to indirect ones.

Four specific methods were applied to measure diffuse emissions both along the bag house and the building evacuation in two electric arc furnace plants and include.

- the DEKATI[®] cascade impactor, based on inertial classification
- the DSI[®] spectrometer, based on diffusive and inertial classification
- a laser diffractometer, based on an optical classification
- the ELPI[®] (electrical low pressure impactor), based on electric and inertial classification.

Any of these methods gives the size distribution and concentration of dust (PM_{0.1}, PM₁, PM_{2.5}, and PM₁₀) which also indicates their relevance for the air quality. Implementing one of these methods indirectly allows a better control over diffuse emissions [252, France 2007].

In [56, Dr. Gaertner, A. 2004], measurements have been carried out on a stainless steel manufacturing plant before and after the emission collection system at a converter which:

- was newly designed
- was optimised by enlarged hoods and an increased exhaust gas volume
- had a venturi scrubber replaced by a bag filter.

The dust measurements were carried out according to the VDI 2463 Part 1 'Particulate matter measurement – gravimetric determination of mass concentration of suspended particulate matter in ambient air – general principles'. The results showed that the diffuse dust emissions have been reduced by 50 %. The PM₁₀ portion on the total dust is approximately 70 %. Cr and Ni have been mitigated accordingly. Metal fumes are much better collected than before.

2.5.5.6.2 Indirect measurements

Examples of indirect measurements include the use of tracer gases, the reverse dispersion modelling (RDM) methods and the mass balance method.

Methods using tracer gases include:

- the release of a known amount of a gas which is not emitted by the source to be examined
- concentration measurements downwind of the spring

- a good representation of the geometry of the source.

The reverse dispersion modelling (RDM) method includes:

- integral or selective concentration measurements
- realisation of a propagation calculation with a fictive source strength
- measurement of meteorological parameters necessary at the time of the measurement
- realisation of back calculation
- validation of the RDM with the help of gas release emission tests.

For both the tracer gas method and the RDM method, SF₆ is often used as a tracer gas. The concentration measurement can be carried out, e.g. by remote atmospheric measurements near ground with Fourier transform infrared (FTIR) spectroscopy.

In [56, Dr. Gaertner, A. 2004] two examples using the RDM method are given to evaluate benzo(a)pyrene (BaP) emissions from a coke plant. In one case, the evaluation is based on BaP concentration measurements at 750 m distance. The RDM is based on a Gauss-Lagrange model without consideration of the influence of buildings and the plant geometry on the dispersion modelling. In the other case, the evaluation is based on BaP concentration measurements at 200 m distance. The RDM is based on an Euler model with consideration of the influence of buildings and the plant geometry on the dispersion modelling. In both cases, the average daily value for the emission rate was estimated to be in the range of 5 – 35 mg BaP/t of coke. With the use of standard emission factors, the emission rate can be calculated to be in the range of 10 – 25 mg BaP/t of coke (see Section 5.2.2.1).

The mass balance method includes:

- determining a reference area and measuring area on the upwind and downwind side of the plant to be measured
- measurement of the concentrations in several layers within these areas
- calculation and/or measurement of the wind velocities and wind directions at the places of the measurement
- calculation of the local mass flows by multiplication of concentration values and the velocity contributions perpendicular to the planes of measurement
- integration of the mass flows over the reference area and the measuring area
- calculation of the emission rate by computing the difference of the integrated mass flows.

Light detection and ranging (LIDAR) is an optical remote sensing technology that measures properties of scattered light to find the range and/or other information of a distant target.

Short laser pulses are sent into the atmosphere and the scattered back radiation is registered and evaluated. Measurements in horizontal and vertical directions allow for determining both the expansion of a pollutant cloud and the concentration distribution of substances in the cloud. Remote measuring with LIDAR is often used for the concentration measurements in the different layers (see second bullet).

The source strengths of gaseous emissions from an area source and from smaller 3D sources can be determined using optical remote measuring procedures with an error of approximately 30 %. The tracer gas method and reverse dispersion modelling method show comparable results. Diffuse emissions from large 3D sources can be quantified with the help of remote measuring with LIDAR and the mass balance method.

Reference literature

[20, VDI/DIN 1999] [25, VDI/DIN 2005] [56, Dr. Gaertner, A. 2004] [96, VDI/DIN 2000]

2.5.5.6.3 Calculation of emissions with emissions factors

Estimation methods for diffuse dust emissions from bulk material storage, handling and transshipment

VDI 3790 part 1 describes the ‘Emissions of gases, odours and dusts from diffuse sources – fundamentals’. This standard is based on calculations using emissions factors. It includes the characterisation of diffuse emission sources, the formation of diffuse emission, the definition of source strengths and usual emissions factors, the technical measurement and the determination of diffuse dust emissions from the storage and transshipment of bulk materials [18, VDI/DIN 2005].

VDI 3790 Part 3 Environmental meteorology – ‘Emission of gases, odours and dusts from diffuse sources – storage, transshipment and transportation of bulk materials’ [165, VDI/DIN 1999] includes the characterisation of diffuse sources, definition of terms like emission rate and emission factor. The main part of this guideline describes how dust emission factors can be evaluated for the storage and handling of bulk materials and for the suspension of dust from roadways due to traffic movements taking into account site-specific characteristics like loading and unloading devices, wind speed, drift sensitiveness of the handled materials, etc. The guideline also gives general emission factors for storage and handling.

Another method used for integrated steelworks is a method proposed by the US EPA [176, EPA 2009]. This method is based on emission factors and is able to properly take into account the wind exposure by using a surface velocity, representative of the wind friction velocity. The method has been adapted by France and allows a good quantification of diffuse dust emissions from open air sources. It especially takes into account the effects of weather, humidity and the wind exposure of the piles [175, Eurofer 2009] [393, Turpin et al. 2009] [395, Badr et al. 2007].

Additional information can be found in the Reference Document on BAT on Emissions from Storage (EFS) [283, EC 2006] and it is strongly recommended that the reader consider this document.

Estimation method for diffuse emissions from coke ovens

Fugitive emissions occur from the ascension pipe and charging hole sealings and from the oven doors and frame seals during coking. Different methods for estimating these fugitive emissions from coke ovens are in use and all of these methods have one thing in common: experienced or certified observers visually determine the emissions.

From these results, achieved emission levels are expressed as a frequency of the leaking percentage of the total number of ascension pipes and charging holes showing visible leaks or mass/time depending on the monitoring method. For example, the EPA (<http://www.epa.gov/ttn/emc/methods/method303.html>) method enables the results from the observation procedure to be expressed in percentages of leakage.

However, the DMT (Deutsche Montan Technologie GmbH) methodology, which is, to a large extent consistent with the EPA method, allows for emissions per day based on basic measurements to be calculated, assigning four different degrees of strength to the emissions and taking the duration of the visible emissions during the observation into consideration. Another method was developed by BCRA (British Carbonisation Research Association). In contrast to the DMT method, the visible emissions are assigned five different degrees of strength. Another method which is used at Corus IJmuiden in the Netherlands is described in Section 5.3.3.

One method for describing procedures for the measurement of fugitive emissions of volatile organic compounds is the EPA method 21. A complete methodology for a comprehensive inventory of the leaks and the further management of fugitive emissions is described in [216, sniffers et al. 2006].

2.5.5.7 Monitoring the discharge of waste water

Monitoring the discharge of waste water includes taking representative samples of waste water and analysing them. A great variety of standardised procedures exist for sampling and analysing water and waste water.

Taking samples can be carried out by:

- a random sample which refers to a single sample taken from a waste water flow
- a composite sample, which refers to a sample taken continuously over a given period, or a sample consisting of several samples taken either continuously or discontinuously over a given period and blended
- a qualified random sample shall refer to a composite sample of at least five random samples taken over a maximum period of two hours at intervals of no less than two minutes, and blended.

The emission concentration in the waste water which has been reported for relevant processes in this document refers either to qualified random samples or to 24-hour composite samples. The associated BAT-AELs therefore also refer to random samples or to 24-hour composite samples.

2.5.6 Reduction of noise

Many processes in the iron and steel production generate significant noise emissions. General constructional and operational techniques in order to prevent or minimise noise emissions in the neighbouring area of plants include the following:

- implementation of a noise-reduction strategy
- enclosure of the noisy operations/units
- vibration insulation of operations/units
- internal and external lining made of impact-absorbent material
- soundproofing buildings to shelter any noisy operations involving material transformation equipment
- building noise protection walls, e.g. the construction of buildings or natural barriers, such as growing trees and bushes between the protected area and the noisy activity
- outlet silencers to exhaust stacks
- lagging ducts and final blowers which are situated in soundproof buildings
- closing doors and windows of covered areas.

3 SINTER PLANTS

3.1 Applied processes and techniques

3.1.1 Purpose of the sinter process

Modern, high-performance blast furnaces achieve improved performance by prior physical and metallurgical preparation of the burden which improves permeability and reducibility. This preparation entails agglomerating the furnace charge either by sintering or pelletisation (see Chapter 4). The charge of a sinter process consists of a mixture of fine ores, additives (e.g. lime, olivine) and recycled iron-bearing materials from downstream operations (including, but not limited to coarse dust and sludge from BF gas cleaning, mill scale) to which coke breeze is added to enable the ignition of the total charge. In Europe, down draft sintering on continuous travelling grates is used exclusively (see Figure 3.1 and Figure 3.2).



Figure 3.1: Photograph of a sinter strand with the charging facility (drums or chutes) and the ignition canopy at the starting end

3.1.2 Blending and mixing of raw materials

[267, Kawaguchi et al. 2002] [300, Eurofer 2007]

Raw materials require blending prior to the sintering operation. This generally involves layering the materials on prepared areas in the precise quantities required by the sintering operation. Some flux material may also be added at this stage, as can recycled materials from the downstream operations mentioned above. The ore beds are usually finished by covering them with a layer of coarse material to prevent wind whipping. At the start of the sintering operation, the ore blend is transferred from the beds to the storage bunkers at the start of the sinter plant.

As mentioned above, other additives such as lime, olivine, collected dust and mill scale, dusts (and to a much lower extent sludges) from gas cleaning in blast furnaces and recycled sinter (particles in the <5 mm range) from sinter screening (see Figure 3.2), may be added to the ore blend at the mixing stage. Additives, fluxes and residues other than those listed may also be blended into the sinter mix.

Coke breeze (small-grade coke with particle sizes of <5 mm) is the most commonly used fuel for the sintering process. It is usually obtained from an on-site coke oven plant directly as breeze or by crushing coke delivered from elsewhere. Integrated steelworks with insufficient coke capacities purchase suitable fuel supplies from external suppliers to meet the needs of their sinter plants. In this situation, anthracite can be an economic alternative to coke breeze and can be used successfully provided due care is exercised in selecting material with a low volatile matter content in order to prevent increasing emissions of hydrocarbons. Table 3.1 shows some characteristics of the coke breeze used in some sinter plants.

Table 3.1: Examples of characteristics of coke breeze used in sinter plants

Parameter		wt-%
<0.25 mm particle		0.1 – 7.2
Fixed carbon		81.3 – 86.6
Volatile matter		0.8 – 2.4
Elemental analysis	C	82.0 – 88.1
	H	0.55 – 1.03
	S	0.42 – 1
	N	1.06 – 1.23
	Cl	0.0050 – 0.0235
	Ash	10 – 15
Ash composition	SiO ₂	44.3 – 55.5
	Al ₂ O ₃	22.1 – 27.7
	Fe ₂ O ₃	4.0 – 17.4
	CaO	1.28 – 3.27
	TiO ₂	0.93 – 1.31
	P ₂ O ₅	0.87 – 1.51
	K	0.56 – 1.12
	Na	0.27 – 0.52
	S	0.05 – 0.09
	Cu	0.008 – 0.020
<i>Source: [220, Eurofer 2008] [267, Kawaguchi et al. 2002].</i>		

The ore blend and the coke breeze are weighed on conveyer belts and loaded into a mixing drum. Here, they are blended completely and the mixture is dampened to enhance the formation of micro-pellets, which improve the permeability of the sinter bed (see Figure 3.2).

Where bunker blending and mixing are employed, the emissions are abated by the evacuation of dust and subsequent purification of the collected gas.

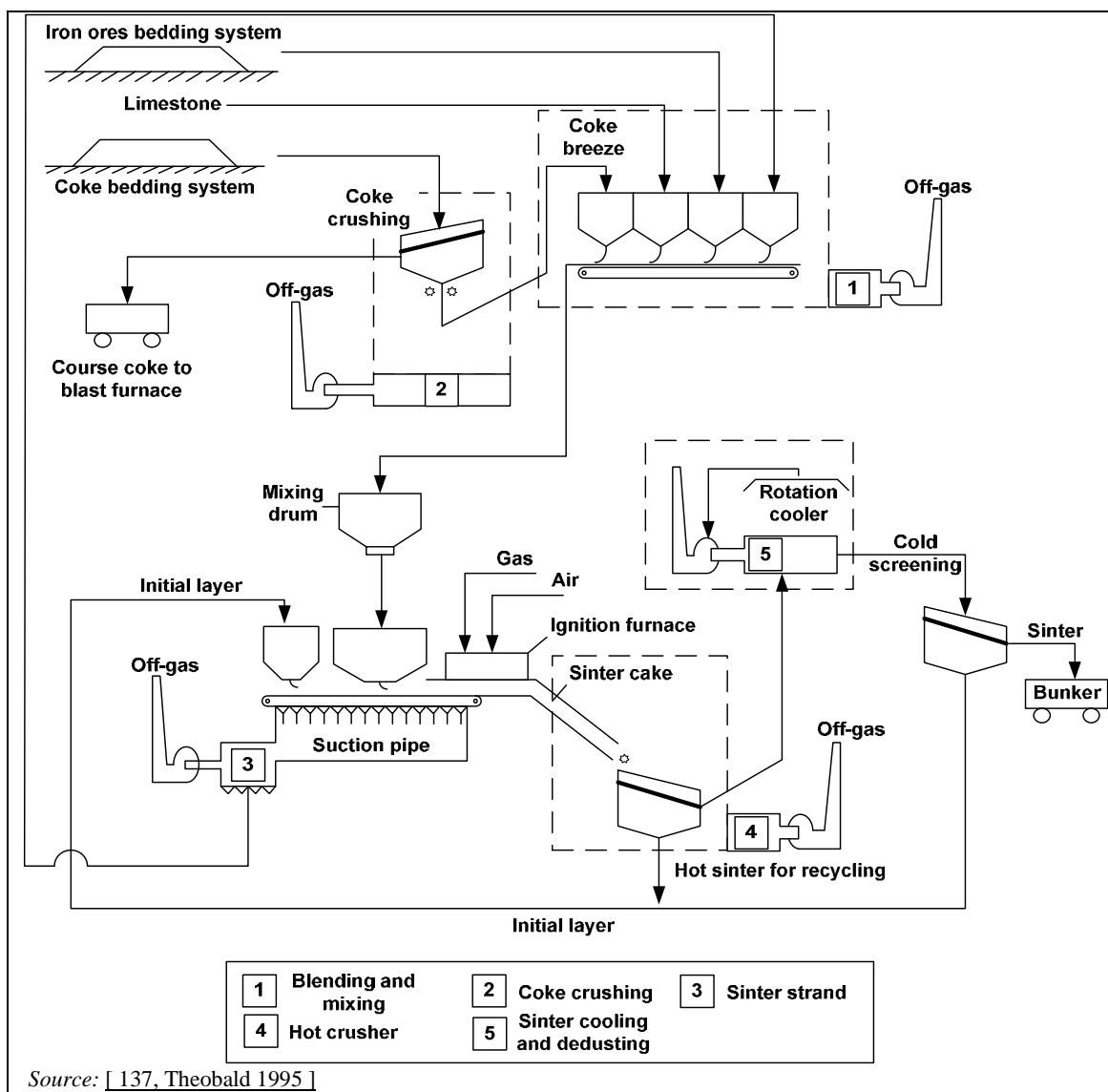

Figure 3.2: Schematic diagram of a sinter plant showing the main emission points

Other designs are also used; the plant shown in Figure 3.2 uses coke crushing and bunker blending; the stacks in the figure indicate emission sources; in reality there would be fewer stacks as more than one off-gas stream may be combined in each stack.

3.1.3 Sinter strand operation

[7, Bothe 1993] [29, EC Sinter/BF 1995] [93, Matzke 1987] [145, UBA Comments 1997]

The sinter plant essentially consists of a large travelling grate of heat-resistant cast iron (see Figure 3.1). The material to be sintered is placed on top of a 30 – 50 mm deep layer of recycled sinter. This bottom layer prevents the mixture from passing through the slots of the grate and protects the grate from direct heat of the burning mixture.

In modern sinter plants, the layer of materials to be sintered is approximately 400 – 600 mm deep but shallower beds are common in older plants. At the start of the grate, a canopy of gas burners ignites the coke breeze in the mixture. In the down-draft process, a powerful fan draws process air through the entire length of the sinter bed into distribution chambers located underneath the grate known as windboxes. The waste gas flow from a sinter plant varies from 333 000 to 1 600 000 Nm³/hour, depending on the plant size and operating conditions. Typically

the specific waste gas flow is between 1500 and 2500 Nm³/t graded sinter. Most sinter plants with large suction areas (more than 250 m² and/or grate width of more than 3 m) have two off-gas collecting mains with separate fans and dedusting devices, which could be suitable for advanced emissions reduction measures.

As the sinter mixture proceeds along the grate, the combustion front is drawn downwards through the mixture. This creates sufficient heat (1300 – 1480 °C) to sinter the fine particles together into porous clinker referred to as sinter.

A number of chemical and metallurgical reactions take place during the sintering process. These produce both the sinter itself, and also dust and gaseous emissions. The reactions overlap and influence each other, occurring as solid-state and heterogeneous reactions between the melt, solids and gaseous phases which are present in the sintering zone. The following processes and reactions take place:

- the evaporation of moisture
- the prewarming and calcination of basic compounds, ignition of the coke breeze and reactions between carbon, pyrite, chloride and fluoride compounds, and airborne oxygen
- the decomposition of hydrates and the cleavage of carbonates
- a reaction between calcium oxide and hematite
- a reaction between the silicate phase and calcium oxide and iron oxide phases to produce a silicate melt and increase the proportion of the molten phases
- the formation of calcium-sulphur compounds and compounds which contain fluoride together with alkali chlorides and metal chlorides
- the reduction of iron oxides to metallic iron in the high temperature zone
- cavity and channel forming effects by coke combustion and moisture evaporation
- reoxidation and recrystallisation processes with shrinking, gearing and hardening effects during sinter cooling
- a formation of cracks due to thermal strain during sinter cooling and defects in the sinter microstructure.

Figure 3.3 shows the temperature and reaction zones of a sinter layer six minutes after ignition.

The off-gas from sinter strands contains particulates such as heavy metals, mainly iron compounds but also other ones especially lead compounds, alkali chlorides, sulphur oxides, nitrogen oxides, hydrogen chloride, hydrogen fluoride, hydrocarbons, carbon monoxide and also significant trace amounts of PAH and aromatic organohalogen compounds such as PCDD/F and PCB. Emission profiles of various parameters (H₂O, O₂) are shown in Figure 3.5 and pollutants (CO₂, CO, SO₂, NO_x and PCDD/F) are shown in Figure 3.5 and Figure 3.7. The gaseous emissions from the sinter plant make a significant contribution to the overall emissions from an integrated steelworks. Detailed information about formation pathways, emission quantities and sinter strand profiles for individual pollutants are given in Section 3.2.

The coke breeze is fully combusted before reaching the end of the grate and the last one or two windboxes are used to begin the cooling process. The cooler can be integrated within the sinter strand, but a separate cooler (e.g. a rotation cooler) is more common. At the end of the strand, the sinter cake falls on a crash deck, where it is broken by use of a crusher. In many plants, the sinter then goes through a hot screening process, in which fines measuring less than around 5 mm are separated and recycled to the feed mixture (see Figure 3.2).

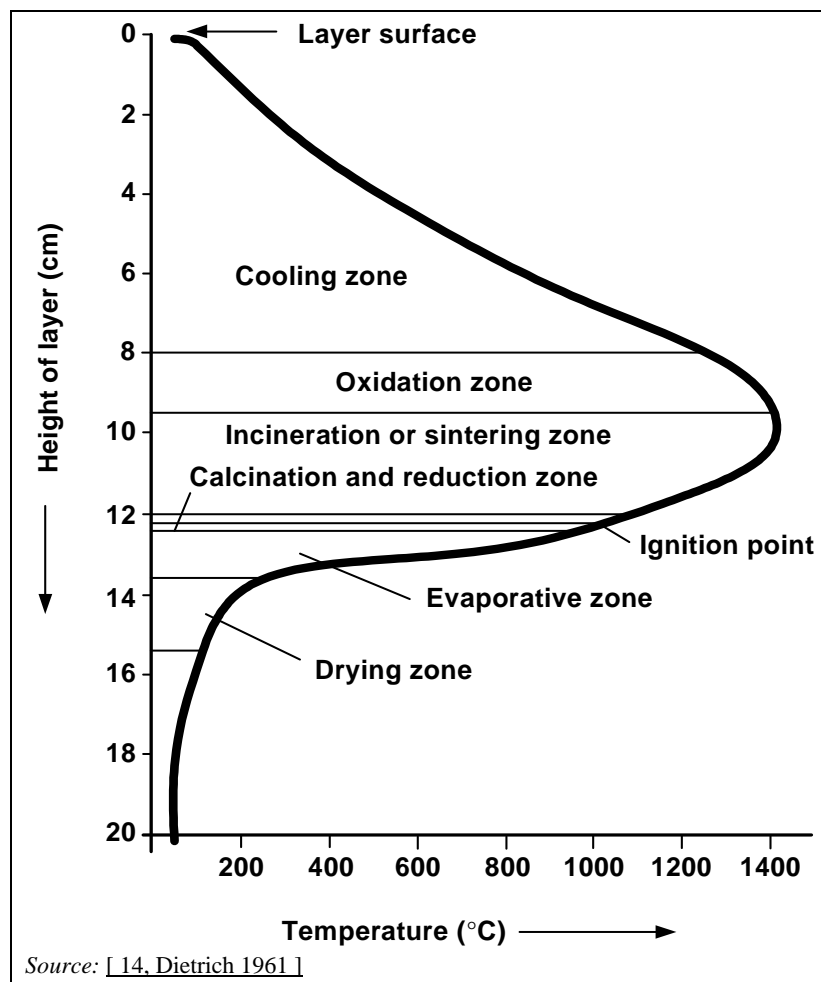

Figure 3.3: Schematic diagram of temperature and reaction zones in a sintering process six minutes after ignition

3.1.4 Hot sinter screening and cooling

[29, EC Sinter/BF 1995]

In most cases (i.e. where cooling is not integrated within the sinter strand), after sinter discharge, crushing and hot screening, the sintered material proceeds to a cooler. The cooler is typically a rotating structure some 20 – 30 m in diameter in which the sinter is placed in a layer more than 1 m thick. The sinter is cooled by air, which is forced upwards or downwards through the layer. Sinter cooling gas flow is high and depends on the kind and age of the system used. The typical specific flow is between 1000 and 1500 Nm³/t sinter. The sensible heat in the sinter cooling waste gas (that can have a temperature of up to 300 °C) can be used in a waste heat boiler by recirculating the hot gases for preheating combustion air in the sinter grate ignition hoods, and by preheating the sinter raw mix or for the sinter process. Other designs of cooler are also known to exist.

Cooled sinter is transferred to screens that separate the pieces to be used in the blast furnace (4 – 50 mm) from the pieces to be returned to the sinter process (0 – 5 mm as ‘return fines’, part of the fraction, 10 – 20 mm as ‘hearth layer’).

3.2 Current emission and consumption levels

3.2.1 Mass stream overview and input/output data

[30, Roederer et al. 1996] [300, Eurofer 2007]

Figure 3.4 shows an overview of the input and output mass streams of a sinter plant. This overview may be used for the collection of data from sinter plants.

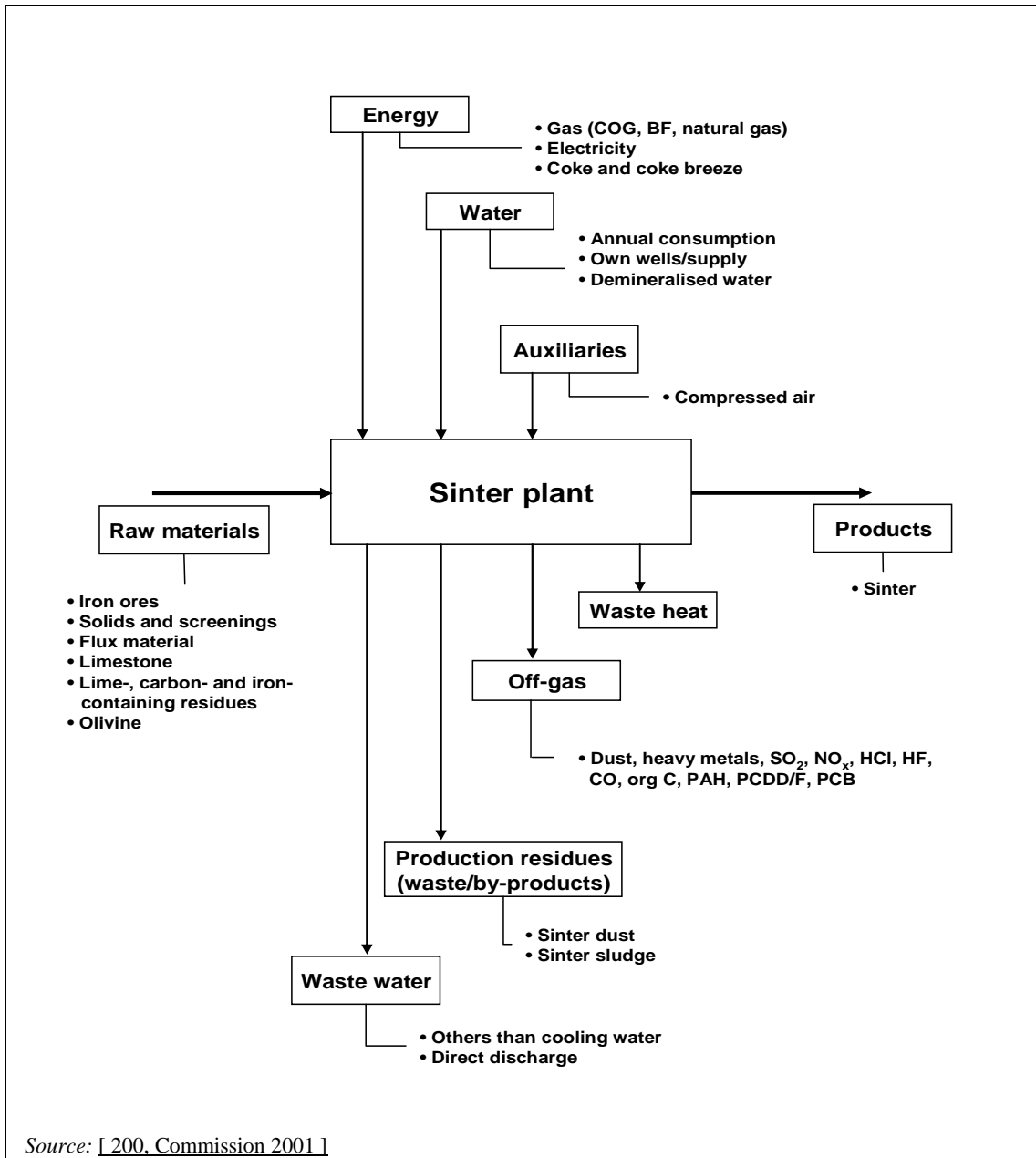

Figure 3.4: Mass stream overview of a sinter plant

Specific input factors and specific emissions factors have been determined for sinter plants. Table 3.2 shows these data for a significant number of sinter plants in Europe representing 91.13 million tonnes of sinter production in 2004.

Table 3.2: Input raw materials for sinter production in the EU–25 for 2004

Graded sinter production		Units	Average input		
Raw materials					
Iron ore		kg/t sinter	813.1		
Internal return fines ⁽¹⁾			250.7		
Limestone/dolomite			131.1		
BF return fines ⁽²⁾			63.0		
Returned materials ⁽³⁾			51.8		
Other ⁽⁴⁾			31.4		
Additives			26.4		
BF gas dust ⁽⁵⁾			12.7		
Lime			10.2		
Total raw mix			1390.4		
Energy					
		Units	Maximum	Minimum	Average input
Fuels:	Solid fuel ⁽⁶⁾	MJ/t sinter	1834	1254	1276.6
	COG/BF gas/natural gas		185	35	67.0
Electricity:	For fans		91	30	39.4
	Total electricity		155	92	- ⁽⁷⁾
<p>⁽¹⁾ Undersized sinter product collected within the sinter process. ⁽²⁾ Undersized sinter screened out prior to charging to the blast furnace. ⁽³⁾ Materials from different IS production activities including recovered fluxes. ⁽⁴⁾ Includes pellets and direct charge lump ore screenings, undersized sinter from other strands, etc. ⁽⁵⁾ Coarse dust from the blast furnace gas treatment. ⁽⁶⁾ E.g. coke breeze, anthracite, excluding the energy contribution by BF gas dust. ⁽⁷⁾ A plausible average input for electricity has not been provided.</p> <p>NB: Total tonnage on which figures are based = 91.13 million tonnes, which equates to between an estimated 79 and 82 % of all sinter production in the EU-25 for 2004. The data are all presented on a specific, annual average basis (e.g. g/t sinter).</p> <p>Source: Eurofer technical exchange on blast furnaces and sinter plants 2004 plus data from additional plants where possible. [177, Eurofer 2009] [299, Eurofer 2007].</p>					

Table 3.3 shows other input data for five sinter plants in Europe representing 52.6 million tonnes of sinter production in 1999.

Table 3.3: Input data from 1999 from five sinter plants in four different EU Member States (Austria, Belgium, Germany and the Netherlands)

Graded sinter production	Units	Maximum	Minimum
Other inputs			
Water	m ³ /t sinter	0.35	0.01
Compressed air	Nm ³ /t sinter	3	1.2
Source: [200, Commission 2001].			

Table 3.4 shows the emissions from the sinter strand at the main waste gas stack (Emission point 3 in Figure 3.2). These data are expressed on a specific annual basis (e.g. g/t graded sinter).

Table 3.4: Averaged maximum and minimum emissions concentrations in the sinter strand waste gas after abatement for sinter production in the EU-25 in 2004

Parameter	Units	Max. value	Min. value	Number of values	Sinter production covered by data (kt)	
Air emissions						
Gas flow ⁽¹⁾	Nm ³ /t sinter	2500	1500			
Dusts ⁽²⁾	g/t sinter	559.4	40.7	21	94 321	
PM ₁₀ ⁽²⁾		177.13	66.30 ⁽³⁾	13	60 385	
As	mg/t sinter	15.0	0.6	15	66 358	
Cd		276.7	0.2	18	77 731	
Cr		125.1	3.6	16	69 140	
Cu		600.5	1.9	16	69 140	
Hg		207.0	0.1	17	72 693	
Mn		539.4	3.4	13	56 612	
Ni		175.6	1.3	17	65 492	
Pb		5661.2	26.1	16	69 140	
Se		120.5	21.8	8	40 598	
Tl		86.6	0.5	12	56 612	
V		158.5	0.6	12	47 156	
Zn		1931.3	2.1	17	75 197	
HCl		g/t sinter	847.6	1.4	18	63 579
HF			8.2	0.4	17	59 129
NO _x ⁽⁴⁾	1031.2		302.1	21	94 321	
SO ₂	973.3		219.9	21	94 321	
CO	37 000		8 783	19	81 284	
CO ₂ ⁽⁵⁾	368 000		161 533	15	81 326	
Methane	412.5		35.5	12	48 835	
NMVOC	260.9		1.5	15	56 901	
Total PAH ⁽⁶⁾	mg/t sinter		591.7	0.2	10	40 441
BaP	mg/t sinter		41.5	0.1	11	41 243
PCDD/F ⁽⁷⁾	µg I-TEQ/t sinter	16	0.15	18	74 249	
PCB ⁽⁸⁾	ng TEQ/t sinter	178.0	24.5	5	13 008	
PCB ⁽⁹⁾	mg/t LS	13	1	2	–	
Production residues (waste/by-products)						
Dusts	g/t sinter	3 641.29	171.05	5	23 021	
Sludge	g/t sinter	4 492.18	472.73	3	11 341	
Waste water	m ³ /t sinter	0.06	0.03	2	7 028	
<p>⁽¹⁾ The gas flow average is 2100 Nm³/t sinter.</p> <p>⁽²⁾ Values correspond to main stack emissions (Emission point number 3 of Figure 3.2). Other dust emissions from sinter plants are presented in Table 3.5.</p> <p>⁽³⁾ Having a PM₁₀ minimum value higher than minimum dust value appears to be anomalous. This arises from the fact that some plants provided an incomplete data set (and therefore, the plant with the lowest PM value did not provide PM₁₀ data.</p> <p>⁽⁴⁾ Nitrogen oxides expressed as NO₂.</p> <p>⁽⁵⁾ Where carbonate iron ores are used, the concentration of CO₂ in the waste gas is increased so that the application of EOS may strongly inhibit the sinter process. The CO₂ emissions in plants which do not use carbonate ores average from 161 to 368 kg/t sinter whereas in plants which do use carbonate ores the average can be up to twice as high.</p> <p>⁽⁶⁾ Total PAH (Borneff 6).</p> <p>⁽⁷⁾ PCDD expressed as I-TEQ.</p> <p>⁽⁸⁾ PCB expressed as WHO (12) TEQ (PCB 105, 114, 118, 123, 156, 157, 167, 189, 77, 81, 126, 169). See more information in Annex III, in Section 13.3.</p> <p>⁽⁹⁾ Sum of all PCB, calculated from (∑PCB 28+52+101+153+138+180) × 5 (factor of 5 according to [155, UN-ECE Pops 1997]) and with 2100 m³ off-gas/t sinter.</p> <p>NB: The data are all presented on a specific, annual average basis (e.g. g/t sinter).</p> <p>Source: [209, EC 2005] [244, Plickert 2007] [262, Pütz et al. 1996] [299, Eurofer 2007] [300, Eurofer 2007] [372, Czech TWG member 2008].</p>						

Table 3.6 complements Table 3.4 by showing ranges of particulate emissions to the atmosphere from operations that can generate secondary emissions which can contribute to diffuse emissions if not efficiently captured and dedusted by a 'secondary or room dedusting system'. Non-captured diffuse emissions are excluded.

Secondary dedusting systems usually consist of an efficient collecting and separate dedusting unit additional to the main dedusting system. This can include the hearth laying, the strand discharge zone with sinter crushing and sieving and transfer points of the sinter conveyor. The validation of the available data showed that the allocation of the different secondary sources is not always done unambiguously, e.g. the dedusting of the cooler is sometimes regarded separately and sometimes included in the secondary emissions.

Electrostatic precipitators or bag filters are used here, with the dust being returned to the raw sinter mix.

Table 3.5: Ranges for point source air emissions for particulate emissions for the main individual operations of a sinter plant (excluding the main waste gas stack)

Emission point ⁽¹⁾	Sinter activity	Dust	PM ₁₀	Dust	PM ₁₀
		g/t sinter		mg/Nm ³	
1	Blending & mixing	0.5 – 37.7	5.6 – 18.9	NA	NA
4	Secondary dedusting: <ul style="list-style-type: none"> • Strand discharge zone • Hot crushing/screening • Conveyor transfer points 	14.5 – 40 ⁽²⁾	7.7 – 25.1 ⁽²⁾	7 – 50 ⁽²⁾	4 – 43 ⁽²⁾
5	Sinter cooling	14 – 212	1.3 – 42.8	0.6 – 85 ⁽³⁾	0.6 – 36

⁽¹⁾ Number of the emission points in Figure 3.2.
⁽²⁾ These data may also include sinter cooler emissions.
⁽³⁾ Excluding a value of 390 mg/Nm³ from a single plant.
NB: NA = Not available or too few data. Data correspond to the year 2004.
Source: [300, Eurofer 2007].

The cooling of sinter (see emission point number 5 in Figure 3.2) is processed with a very large amount of cooling air. Since the coolers are usually not fully covered, diffuse emissions occur.

Table 3.6 includes data for dust emissions from secondary dedusting in three EU sinter plants.

Table 3.6: Dust emissions from secondary dedusting in three EU sinter plants

Pollutant	Emissions level ⁽¹⁾	Percentile		Unit	Reference time period
		5 %	95 %		
Sinter room dedusting (emission point 4) ⁽²⁾					
Dust	3 – 21	5	25	mg/Nm ³	HHAV (c) ⁽³⁾
Sinter discharge zone, hot crusher and conveyor transfer points dedusting (emission point 4) ⁽²⁾					
Dust	19	9.5	32	mg/Nm ³	DAV ⁽⁴⁾
Sinter cooler dedusting (emission point 5) ⁽²⁾					
Dust	17.6	7	24.5	mg/Nm ³	HHAV (c) ⁽³⁾

⁽¹⁾ Annual average.
⁽²⁾ Number of the emission points in Figure 3.2.
⁽³⁾ HHAV (c) = half-hourly average value measured continuously.
⁽⁴⁾ DAV = daily average value.
NB: Table corresponds to only three EU sinter plants.
Source: [244, Plickert 2007].

3.2.2 Environmental issues for sinter making process

As already indicated, the emissions to air from sinter plants, especially from the strand, are of high environmental significance. Another important issue is related to energy. Sections 3.2.2.1 to 3.2.2.5 below describe the most relevant environmental issues for sinter plants.

3.2.2.1 Emissions to air

3.2.2.1.1 Dust emissions from the handling, crushing, screening and conveying of sinter feedstock and products

When raw materials or sinter are handled, crushed, screened or conveyed, dust emissions (secondary emissions) occur. These dust emissions can be reduced by means of proper suppression, or extraction and abatement.

3.2.2.1.2 Off-gas emissions from the sinter strand

[101, Neuschütz et al. 1996] [215, BSS 2007]

As mentioned in Section 3.1.3 and in Table 3.4, the specific flow of waste gas is relatively high (1500 – 2500 Nm³/t sinter). Figure 3.5 shows information concerning mixed waste gas from the strand as a whole. Although the composition of the waste gas extracted from individual windboxes varies considerably, it shows certain characteristic features. Figure 3.5 shows typical emissions profiles of CO₂, CO, O₂ and H₂O in the waste gas along the sinter strand. These parameters also interfere with various reaction equilibria. Characteristic curves are also available for the temperature, HCl, SO₂, NO_x and PCDD/F content (see Figure 3.7 and Section 3.1.4) and also may exist for further pollutants. Some parameters such as CO, CO₂, H₂O, O₂, NO_x and SO₂ can be calculated with appropriate models.

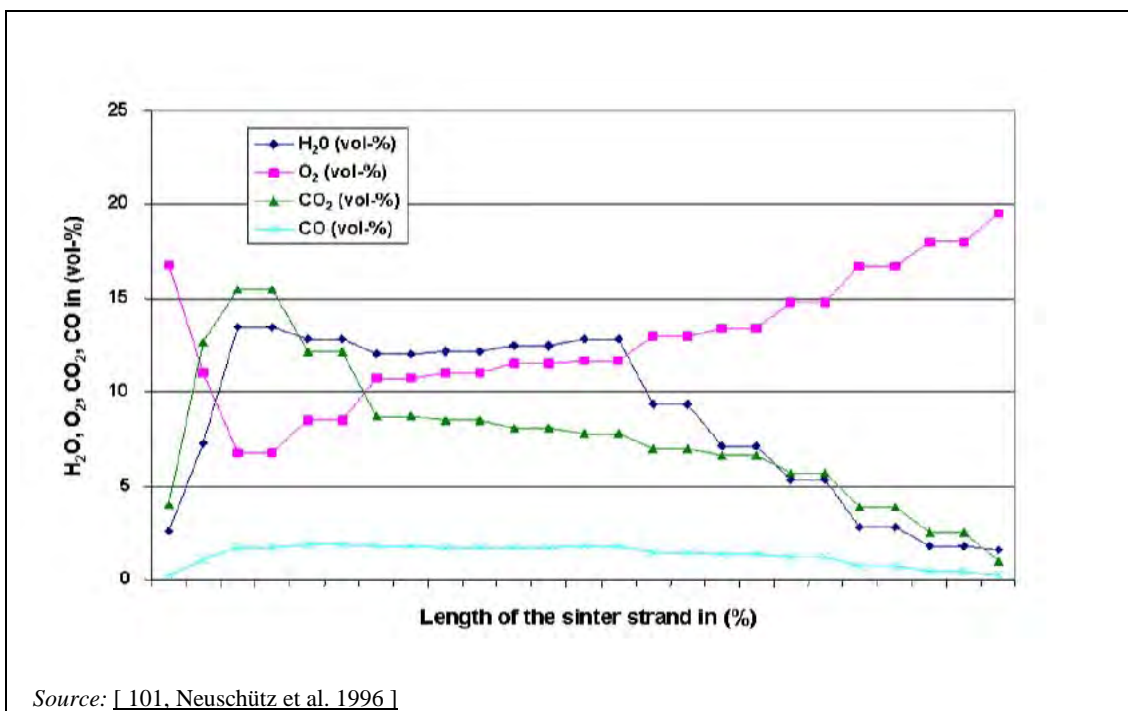

Figure 3.5: Typical emissions profiles of CO₂, CO, O₂ and H₂O in the waste gas (single windboxes) along the sinter strand

3.2.2.1.2.1 Dust
 [7, Bothe 1993] [45, Gebert 1995] [300, Eurofer 2007]

Quantitative analysis of grain size distribution of the dust from a sinter strand before abatement shows two maxima: one for coarse dust (with a grain size of about 100 μm) and one for PM_{10} (0.1 – 1 μm) (see Figure 3.6). This characteristic ‘two component dust mixture’ can be explained by the existence of two dust-forming processes.

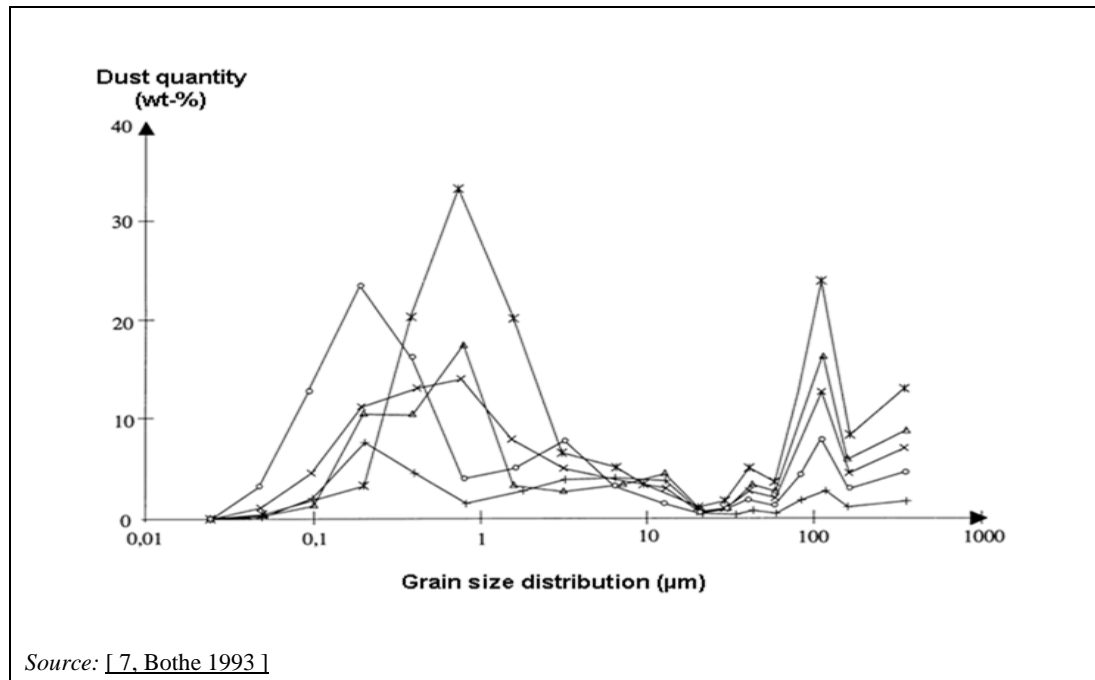

Figure 3.6: Grain size and weight distribution of dust from various sinter strands

The coarse dust results from the beginning of the strand and originates in the sinter feed and the lower layer, whereas the fine dust is formed in the sintering zone after complete water evaporation from the mixture. The composition of the coarse dust is related to that of the sinter feed and can be separated in electrostatic precipitators (ESPs) with a high efficiency. The fine dust, however, consists of alkali and lead chlorides formed during the sintering process itself (see Section 3.1.3). The alkali chlorides have high specific dust resistivity (between 10^{12} and 10^{13} Ω cm) and thus form an insulating layer on the electrodes. This layer causes severe problems for dust removal as it reduces the efficiency of the precipitators. According to [7, Bothe 1993], alkali chlorides can only be removed with an average efficiency of about 60 %. The presence of these fine particulates in the dust means that well designed and operated conventional ESPs cannot normally achieve emitted dust concentrations of below 100 – 150 mg/Nm^3 . The presence of these fine particulates in the dust makes it necessary to use bag filters or well maintained ESPs with pulse discrimination or similar advanced control techniques with which dust concentrations of 50 mg/Nm^3 can be achieved. With Moving Electrodes Electrostatic Precipitators (MEEP), daily average values of <50 mg/Nm^3 have been achieved. Provided that dust from the blast furnace gas cleaning and the separated chloride-rich dusts from the third and fourth field of the ESP were not recycled back to the sinter strand, daily average values of <30 mg/Nm^3 can be achieved [326, Buchwalder, J. et al 2008].

Lead chlorides behave similarly to alkali chlorides; hence, the relatively high lead emissions from a sinter plant's main waste gas stacks may make the abatement of dust more difficult. Table 3.7 shows ranges found in the elementary analysis of sinter dust.

Table 3.7: Ranges found in the elementary analysis of sinter dust

Parameter	wt-%
Fe (total)	43.7 – 49.9
Cl	2.9 – 25.8
S	0.22 – 4.07
Si	2.73 – 3.62
C	2.9 – 6.12
P	0.01 – 0.24
K	3 – 9.07
Ca	7.55 – 7.83
Al	0.43 – 2.17
Mg	1.01 – 1.04
Zn	0.03 – 0.34
Mn	0.10 – 0.31
Cu	0.005 – 0.17
Cr	0.04 – 0.15
Pb	0.09 – 5.98
Na ₂ O	0.58 – 31.6
Ni	0.003
Cd	0.0009
TiO ₂	0.099
NB: Dust used from an ESP of a sinter plant, working at 120 – 130 °C and containing three fields. Data are from the dust from the third field. Analysis by X-fluorescence and TOC. Source: [224, Xhrouet 2002] [231, Xhrouet et al. 2002] [234, Poland 2007] [387, Fisher et al. 2005].	

3.2.2.1.2.2 Heavy metals

[7, Bothe 1993] [9, Fisher et al. 1998] [87, Medinger et al. 1996] [93, Matzke 1987] [143, UA-OÖ 1998] [299, Eurofer 2007] [300, Eurofer 2007]

Heavy metal emissions from sinter plants can be of high significance, especially for lead.

Lead

During the sintering process, lead reacts to PbO-PbCl₂, PbCl₂ and probably also to PbCl₄. These lead compounds are relatively volatile and enter the gas phase. Their properties (volatility, no further increase of its grain size, the very fine PbCl₂ crystals) give rise to annual average emission rates of up to 10 g/t sinter in the raw waste gas (which equates to an average emissions concentration in the waste gas of approximately 3 mg Pb/Nm³, based on a waste gas flow rate of 2100 Nm³/t sinter). Because of the specific characteristics of sinter dust (high alkali chloride content), the removal efficiency also of a well-designed conventional ESP is not high for the very fine particles. From the analysis of leaf deposits, it is known that ambient air concentrations in the impact area of sinter plants can be significantly higher compared to the overall level.

The most important factor in lead chloride formation is not the lead concentration in the sinter feed (normally 40 – 100 g Pb/t sinter feed) but the chloride concentration (normally 200 – 700 g Cl/t sinter feed). For the chloride content, numbers ten times lower are also reported which may correlate with lower lead emissions.

The emissions profile of lead compounds along the sinter strand shows that the volatilisation of lead occurs in the first two thirds of the strand.

Many of the sinter plants in Europe are operated using closed-filter dust cycles. This means that all precipitated filter dust from the ESP is recycled to the strand. Compared to partly open-filter dust cycles (the dust from the last field of the ESP, which mainly consists of alkali and metal chlorides, is put to landfill), closed cycle plants have higher alkali and metal chloride emissions. In this context see also the measurement results in Section 3.2.2.1.2.1 – drawn from [326, Buchwalder, J. et al 2008] – with and without dust recycling. Depending on the fluoride content of the sinter feed, lead fluorides may also be formed. These are even more volatile and also contribute to overall lead emissions.

Mercury

Mercury enters the gas phase directly during the sintering process. Emission levels depend on the mercury content of the sinter feed, but are normally very low. For certain types of iron ore, (e.g. FeCO_3) the relevant amounts of mercury emissions might be considerable. In such a case, emissions of about 15 – 82 $\mu\text{g Hg/Nm}^3$ or 0.1 – 207 mg Hg/t sinter are reported when well-designed and operated ESPs plus fine wet scrubbing systems are applied as abatement techniques. Such releases can lead to significantly higher environmental concentrations (e.g. determined from deposits on tree leaves) in the impact area of a sinter plant [299, Eurofer 2007].

Zinc

The zinc content in the feed is normally in the range of 70 – 200 g Zn/t sinter feed. At high temperatures in the incineration/calcination/oxidation zone (see Figure 3.3), zinc evaporates but subsequently reacts to form zinc ferrite, which either remains in the sinter or may be removed using a well designed and operated ESP with high efficiency. The temperature during the sintering process, which is mainly influenced by the coke content of the mixture, may have a significant influence on zinc volatilisation.

In the raw gas, zinc can be present at levels of up to 50 mg Zn/ Nm^3 or 100 g Zn/t sinter. Treated waste gas contains between 2 and 1930 mg Zn/t sinter which equates to an average emissions concentration of between 0.001 and 0.92 mg/ m^3 .

3.2.2.1.2.3 Alkali chlorides

[93, Matzke 1987]

The alkali content of the sinter feed normally varies from 600 – 1000 g K_2O /t sinter feed and 250 – 500 g Na_2O /t sinter feed. In some cases, depending on the ore quality, up to 3000 g K_2O /t sinter feed have been reported. The formation of alkali chlorides during the sintering process and their adverse impact on ESP removal efficiency has already been explained above (see Section 3.2.2.1.2.1). Table 3.8 shows some information about the soluble chloride contents in some sinter feed materials.

Table 3.8: Soluble chloride contents in sinter feed materials

Material	Soluble chloride content (mg/kg)
Iron ores	27 – 159
Fluxes	51 – 125
Revert materials	22 – 3800
ESP dust	2500 – 34074
Fuels	78 – 629
<i>Source: [387, Fisher et al. 2005].</i>	

3.2.2.1.2.4 Sulphur oxides (SO_x)

[4, Beer et al. 1991] [7, Bothe 1993] [65, InfoMil 1997] [200, Commission 2001] [256, Kasai et al. 2001] [263, Kasai et al. 2001] [300, Eurofer 2007]

Sulphur oxides (mainly SO₂) in the waste gas originate from the combustion of sulphur compounds in the sinter feed. These sulphur compounds are primarily introduced through the coke breeze. The contribution from iron ore is normally about ten times smaller. Total sulphur input varies between 0.28 and 0.81 kg/t sinter. The emissions concentrations for SO₂ are normally between 200 and 1000 g SO₂/t sinter (which equates to average waste gas emissions concentrations of 95 to 480 mg/Nm³ based on a waste gas flow of 2100 Nm³/t sinter). The emissions profile along the sinter strand clearly varies, with considerable differences in SO₂ concentrations in the individual windboxes (see Figure 3.7 and Figure 3.8). Similar behaviour of emissions has been found in more recent studies [200, Commission 2001] [256, Kasai et al. 2001] [263, Kasai et al. 2001].

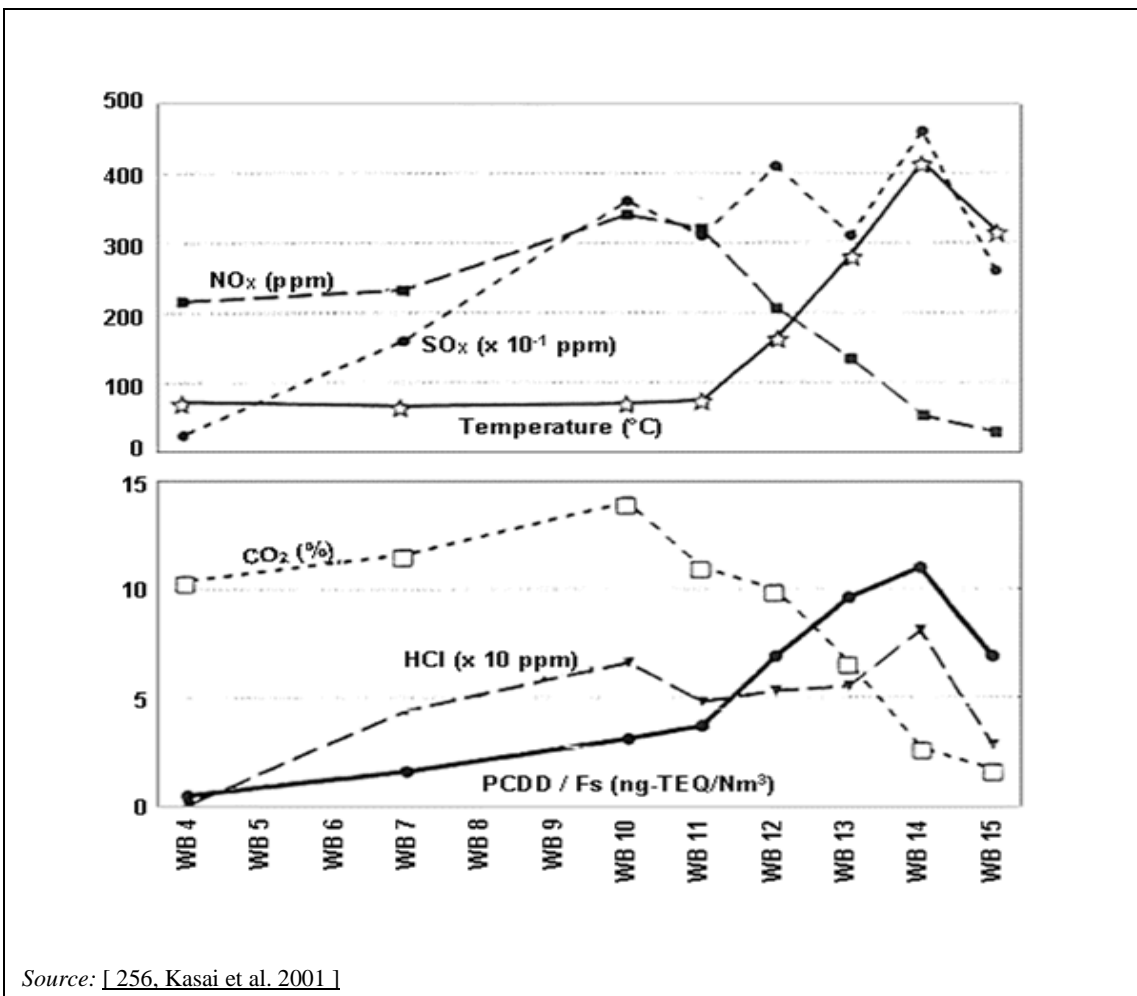

Figure 3.7: Distribution of temperature and concentration of gas compounds in the exhaust gas from the windboxes

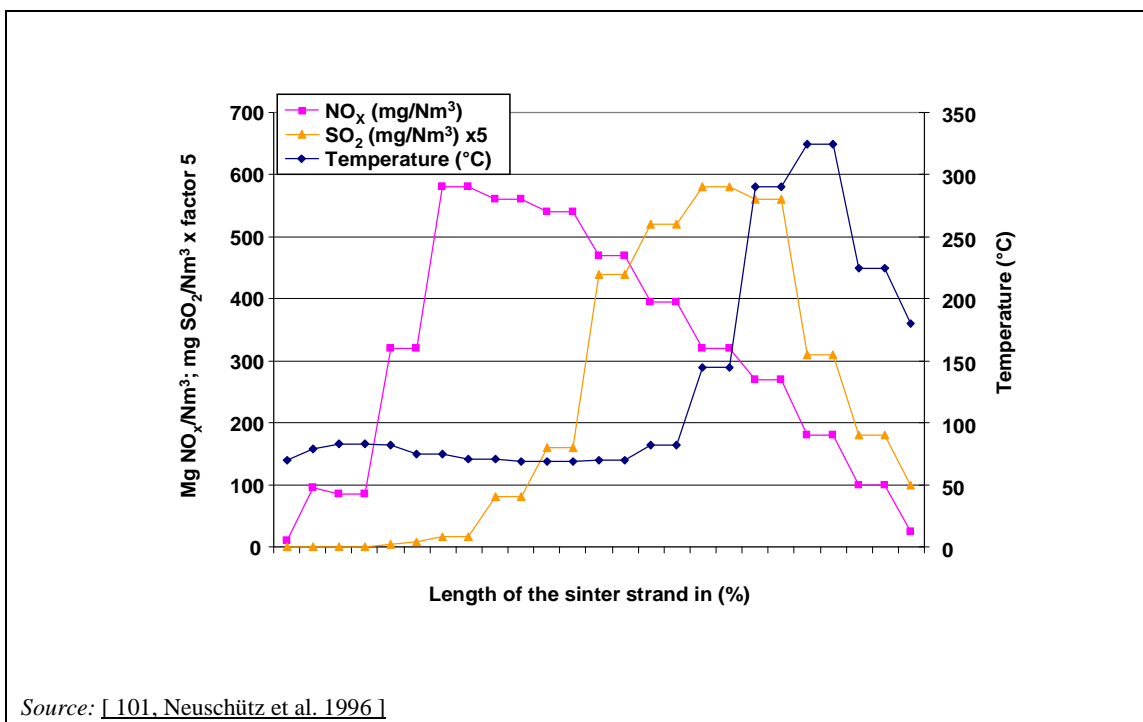
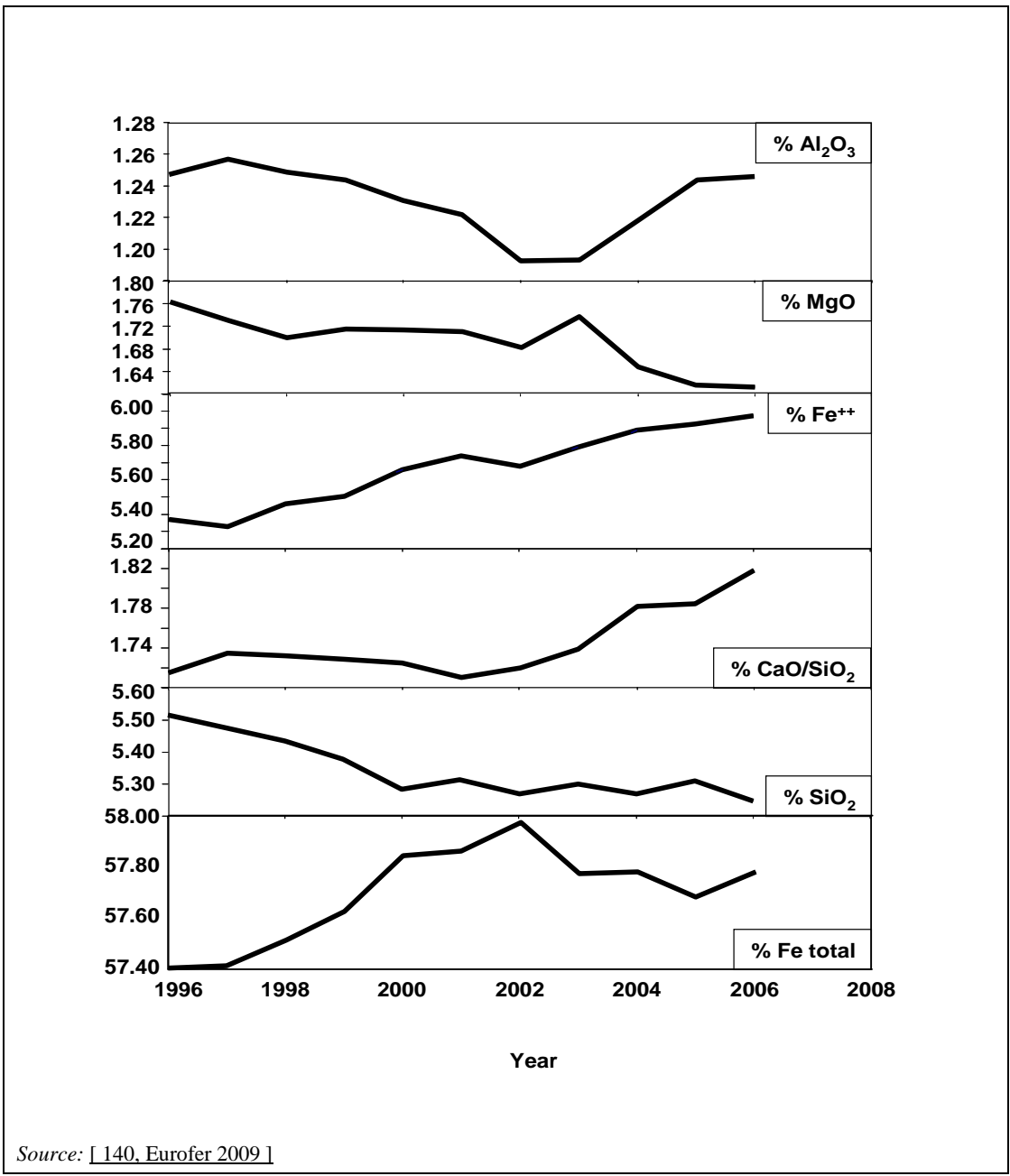

Figure 3.8: Typical emission profile of SO₂ and NO_x in the waste gas (individual windboxes) and the temperature profile along the sinter strand

At the start of the strand, the SO₂ content is low. Only when higher temperatures in the lower layers of the sinter bed are reached do the emissions increase markedly. The highest concentrations occur at the end of the strand just prior to the burn-through point. This emissions profile may offer the possibility, if required, of treating only part of the waste gas (see, for example, the integrated technique referred to as partial waste gas recycling in Section 3.3.5.2).

The above-mentioned SO₂ emissions are achieved by using raw materials with a low sulphur content and by the improvements that have been made to reduce the consumption of coke breeze as a fuel for sinter strands. Whereas in the early eighties a coke breeze input of about 80 kg/t sinter was common, in 2009 the consumption is 39 – 64 kg/t sinter (see Table 3.3). Apart from the sulphur input with the raw materials, there are other factors which influence the quantity of SO₂ emitted. One of these is the degree of sulphur uptake in the sinter. This depends on the basicity of the sinter feed. At basicities of up to 1, more than 90 % of the sulphur volatilises. This percentage decreases at basicities of above 1.5. At a basicity of 2, 80 – 90 % of the sulphur is released. Figure 3.9 shows the weighted average composition of sinter for plants participating in the European Blast Furnace Committee data exchange representing about 100 million tonnes of sinter per year. The basicity of sinter has been increased to an average of 1.8 since the year 2000 in order to achieve a self-fluxing burden and this is representative for Europe as a whole. This has contributed to the decrease of SO₂ emissions, but only slightly. Moreover, the uptake of sulphur by high-basicity sinter is only possible when CaCO₃ is used as the alkali and not with MgCO₃.



Source: [140, Eurofer 2009]

Figure 3.9: Weighted average composition of sinter for plants participating in the European Blast Furnace Committee data exchange

The slightly positive effect of CaCO_3 on SO_2 emissions is counteracted by its adverse effect resulting from the increased specific dust resistivity caused by higher basicity, leading to decreased dust-removal efficiency in the ESP (see Figure 3.10).

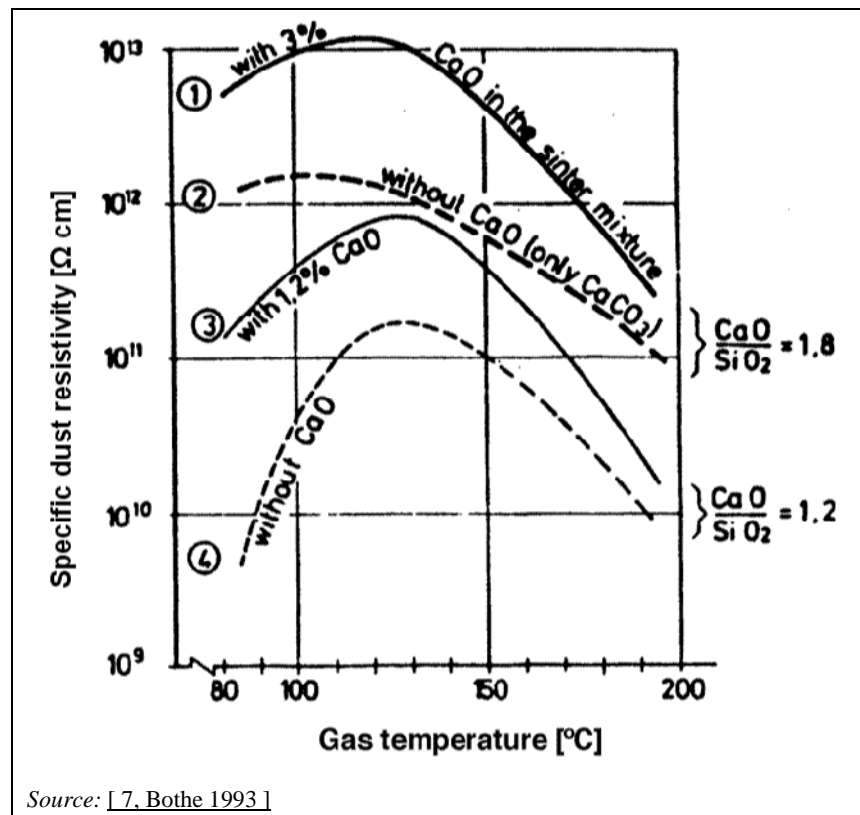

Figure 3.10: Influence of sinter basicity (CaO/SiO_2) on specific dust resistivity

The grain size distribution of the coke breeze has a significant influence on SO_2 emissions. The use of coarser coke breeze (5 – 6 mm) instead of normal grain sizes (<3mm) can reduce SO_2 emissions considerably. On the other hand the use of coarser coke breeze may deteriorate the productivity and thereby increase the fuel consumption which eliminates the positive effect on the SO_2 emissions. An example has been reported in which SO_2 emissions of about $800 \text{ mg SO}_2/\text{Nm}^3$ using fine grain breeze (1 mm) were reduced to $500 \text{ mg SO}_2/\text{Nm}^3$ after switching to a coarser coke breeze (6 mm).

3.2.2.1.2.5 Fluorides [300, Eurofer 2007]

Fluoride emissions primarily depend on the fluoride content of the ore and on the basicity of the sinter feed. Ores rich in phosphorus contain significant amounts of fluoride (1900 – 2400 ppm). In Europe, such types of ore are especially explored and exported from Sweden. As it can be seen in Figure 3.11 the fluoride emissions strongly depend on the basicity of the sinter feed. The increase in basicity of sinter feed has led to significantly lower fluoride emissions. As mentioned above, a disadvantage of sinter feed with higher basicity is the generation of dust with higher specific dust resistivity (see Figure 3.11). According to Table 3.4, the hydrogen fluoride emissions are in the range of $0.4 - 8.2 \text{ g F/t sinter}$ on an annual average basis or $0.2 - 4.3 \text{ mg F/Nm}^3$ with $2100 \text{ Nm}^3/\text{t sinter}$ on an annual average basis.

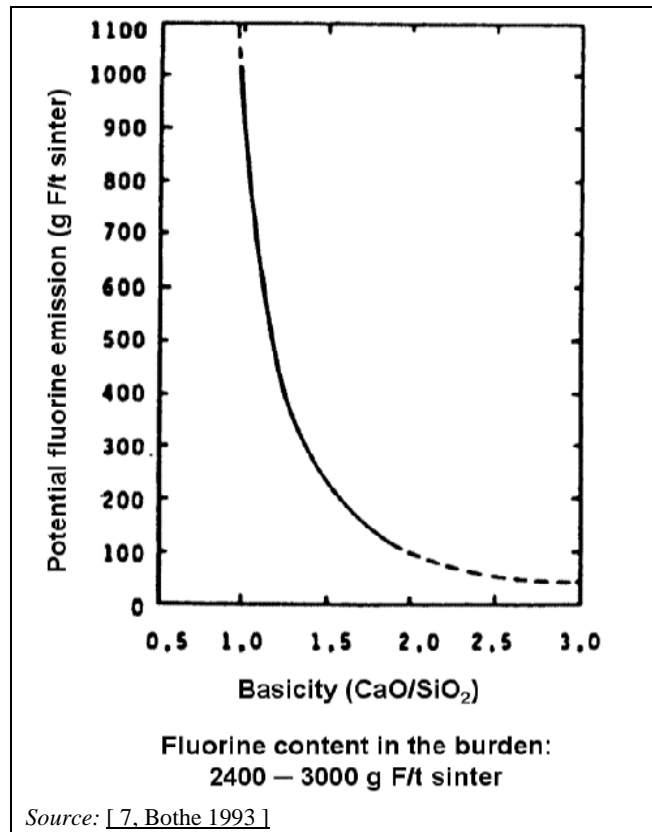

Figure 3.11: Relationship between sinter feed basicity and fluoride emissions

3.2.2.1.2.6 Nitrogen oxides (NO_x)
[7, Bothe 1993] [65, InfoMil 1997] [387, Fisher et al. 2005]

The temperatures at the flame front in the sinter bed inherently cause NO_x formation. This NO_x can be formed in three ways: combustion of organic nitrogen compounds in the sinter feed ('fuel NO_x'); the reaction of decomposing components with molecular nitrogen (N₂) in the combustion zone ('prompt NO_x'); and the reaction of molecular oxygen (O₂) with molecular nitrogen (N₂) in the combustion air ('thermal NO_x'). Fuel NO_x can be the most important, representing about 80 % of the total, but also thermal NO_x can dominate by 60 – 70 %. In Table 3.4 emission factors are reported in the range of 302 – 1031 g NO_x/t sinter, which means concentrations of 143 – 491 mg NO_x/Nm³ with 2100 Nm³/t sinter. Emissions concentrations of up to 700 mg NO_x/Nm³ are reported, which relate primarily to the nitrogen content in the fuels.

When the NO_x concentrations are determined at individual windboxes, it can be seen that the NO_x emissions are not evenly distributed along the sinter strand. However, compared to SO₂ the differences are not that significant (see Figure 3.7).

From sinter strand experiments, it has been shown that the nitrogen oxides in the waste gas consist mainly of NO. In addition, it was found that in situations where the permeability of the sinter bed decreased, the increase in the contact time between the air and the bed facilitated the formation of NO_x.

3.2.2.1.2.7 Other inorganic compounds [229, Green 2004]

It has been reported that the emissions of HCN for sinter plants may be quite high. In one Belgium sinter plant where anthracite is used as a fuel, HCN emissions of about 1646 kg/yr were observed. In an Australian iron and steel plant producing 5 Mt/yr of raw steel, HCN emissions from the sinter plant were reported as 1500 kg/yr in 2004 – 2005 and 2375 kg/yr in 2006 – 2007. These provide specific emissions of about 0.4 g/t sinter. The measured corresponding mass concentrations are 0.17 and 0.2 mg/Nm³. It is worth mentioning that both plants either use anthracite mainly as a fuel or to reduce NO_x emissions, even if the possible impact on the generation of HCN is not clear.

On the other hand, two measurements taken at an Austrian and a German sinter plant showed quite the opposite results. The mass concentration was, in all cases, <0.02 mg/Nm³, which means under the detection limit. It has also been reported that HCN mass concentrations at a Dutch plant and at a Belgium sinter plant using significant quantities of anthracite, the mass concentrations of HCN were always below the detection limit.

These results seem to be contradictory. As it remains unclear as to how HCN can be formed during sintering under prevailing oxidative conditions, exploratory analysis and research is recommended [128, Sporenberg 2006] [380, Voestalpine Linz 2008].

3.2.2.1.2.8 Hydrocarbons [7, Bothe 1993] [45, Gebert 1995] [112, Pütz 1997] [300, Eurofer 2007]

Hydrocarbon emissions mainly consist of products formed from pyrolysis and incomplete combustion of carbon-bearing raw materials. Residues which contain oil are the major source of hydrocarbon emissions from sinter strands. For example, in exceptional circumstances, mill scale can contain up to 10 % oil [45, Gebert 1995]. Thus, prior to recycling back into the sinter operation, a pretreatment is necessary to comply with internal standards. Most integrated steelworks have introduced internal standards for the oil content of residues recycled to the sinter strand (some are <0.1 %, some <0.5 % and some <1 % in order to avoid operational problems with the ESP (scaling, glow fire) and also to minimise emissions. By doing this, the resulting oil content in the raw mix for the sinter strand should be <0.1 %.

Hydrocarbon emissions as a result of evaporation before the oxidation/incineration zone, reach the lower sinter bed layers (see Figure 3.3). These emissions include methane, aliphatic compounds, phenols, olefins and aromatics. From the data summarised in Table 3.4, it can be seen that the non-methane volatile organic compounds (NMVOC) emissions range is between 1.5 and 260 g C/t sinter, expressed as an annual average (which equates to an emissions concentration in the waste gas of approximately 0.7 – 120 mg/Nm³, based on a waste gas flow rate of 2100 Nm³/t sinter). The methane emissions range is from 35 to 420 g/t sinter, expressed as an annual average (which equates to an average emissions concentration in the waste gas of approximately 17 – 200 mg/Nm³, based on a waste gas flow rate of 2100 Nm³/t sinter).

In one Belgian sinter plant with a production of 3.186 Mt sinter/yr, benzene emissions of about 28176 kg/yr were measured. This provides specific emissions of about 8.84 g/t sinter and a corresponding mass concentration of 2.91 mg/Nm³. In this plant, anthracite is used as a fuel. In an Australian plant where anthracite is used to reduce NO_x emissions, benzene emissions of 3600 kg/yr were detected from 2004 – 2005 which equates to concentrations of 0.35 mg/Nm³ for an iron and steel installation producing 5 Mt/yr of raw steel. The factors influencing benzene emissions are not clear but they are likely to be associated with high volatile materials in the raw mix. Further research may be necessary.

3.2.2.1.2.9 Polychlorinated dibenzo-p-dioxins and furans (PCDD/F)
[224, Xhrouet 2002] [230, Brouhon et al. 2001] [258, Kuzuhara et al. 2003] [259, Kasama et al. 2006] [300, Eurofer 2007]

Table 3.4 shows a range of PCDD/F emissions from sinter plants (of 0.15 – 14.64 µg I-TEQ/t sinter), expressed on an annual average basis, with most plants being in the range of 0.2 to 6.0 µg I-TEQ/t sinter. These emissions rates equate to typical emissions concentrations in the waste gas of 0.07 – 2.86 ng I-TEQ/Nm³ (based on a waste gas flow rate of 2100 Nm³/t sinter).

This gives clear evidence that sintering is the major source for PCDD/F emissions in integrated steelworks. Thus, sintering has been the subject of several investigations carried out to evaluate where in the process and under which conditions PCDD/F emissions are generated. The objective of the research was to get a better understanding of how the formation of PCDD/F emissions can be prevented and/or what kind of eventual reduction techniques should be used and where the most effective stage for applying the technique is. Another question was to evaluate which PCDD/F emissions congeners occur together with PCDD/F emissions.

The overall mechanism of PCDD/F formation in the sinter process is complex and probably involves contributions from a variety of formation processes occurring at different positions within the bed owing to the vertical and longitudinal temperature distributions that exist there.

These formation processes are likely to involve the condensation of precursor molecules and de novo synthesis. The intervention of precursor molecules is easy to envisage with potential precursors for PCDD being chlorophenols or chlorodiphenyl ethers, and with PCB as precursors for PCDF.

‘De novo’ synthesis occurs on macro-structural carbon under an oxidation atmosphere at relatively low temperatures. The properties of a small quantity of residual carbon particulates, or ‘soot’ which is suspended on the exhaust gas and metallic chlorides, seem to have a great effect on the formation of PCDD/F.

PCDD/F formation requires different ingredients. In [224, Xhrouet 2002], [255, Kasai et al. 2001], [263, Kasai et al. 2001], [266, Kawaguchi et al. 2002], [300, Eurofer 2007] and [387, Fisher et al. 2005] further information is given on how different compounds contribute to the building of PCDD/F functioning as precursors. In order to explain the formation processes and requirements of precursors and subsequently appropriate abatement techniques, many investigations have been carried out from which the key results are included in the following list:

- (hydro)carbon: ores generally contain small amounts of organic materials. The main source of organic material are the reverts, e.g. mill scales, which might contain oil [257, Kawaguchi et al. 2002]. As has been reported and concluded, the nature of coke has little influence on the amount of global amounts of PCDD/F there are. It only seems to have an influence on the isomer distributions. Overall, it should be stated that the direct correlation of the amount of organics is linked to the appearance of VOC and this again has a strong correlation with the PCDD/F concentration
- chlorine: volatile Cl content (e.g. NaCl, KCl, CaCl₂) and organic content are effective factors of PCDD/F occurrences [257, Kawaguchi et al. 2002]. Sources of chlorines are ores which contain chloride and organic chlorides, e.g. in plastics. The total chloride content in iron ores is given as 12 – 720 ppm [266, Kawaguchi et al. 2002]. The chloride content of limestone and other fluxes is in the same range. The reverts exhibited the largest variations in chloride content with flue dusts having 1000 to 5000 ppm. Coke breezes generally have relatively low chloride contents. Correlations are described in [255, Kasai et al. 2001], [263, Kasai et al. 2001], [387, Fisher et al. 2005]
- metallic catalysts: metallic catalysts, such as Cu or Fe, can be contained in minerals and coke. A range of compositions of iron ores is given in [266, Kawaguchi et al. 2002].

Thus the range from ten different iron ores for copper is between 10 and 70 ppm and for iron between 57.2 and 67.9 wt-%

- chlorophenols and PCB: these are essentially precursors for the formation of PCDD/F and these compounds tend to predominate in sinter plant emissions (and in the emissions from other combustion sources). They are relatively volatile and may be driven off ahead of the combustion zone as the sinter bed is heated by the gaseous combustion products. Some studies have indicated that the concentrations of total PCB in coke breeze and iron ores are around 1 to 1.6 mg/kg and calculations for one sinter plant indicated a potential PCB input of 0.85 mg/kg sinter product, which therefore potentially represents a significant source of precursor molecules from what may be considered natural sources
- soot: this can be suspended in the waste gas, can have an imperfect crystalline structure and can contain both chlorides and catalytic elements
- PCDD/F in the reverts can also contribute to PCDD/F formation of the waste gas. The PCDD/F contents of some raw materials, mixed materials and produced sinter are shown in Table 3.9. Even as they are destroyed in the sinter strand while decomposing, the resulting compounds can contribute as precursors to the de novo synthesis.

Table 3.9: PCDD/F concentrations of raw materials, mixed materials and produced sinter

Material	PCDD		PCDF		PCDD/F	
	(ng/g)	(ng-TEQ/g)	(ng/g)	(ng-TEQ/g)	(ng/g)	(ng-TEQ/g)
Dry ESP dust	4.0 – 45.1 ⁽¹⁾	1.90	24 – 87.2 ⁽¹⁾	14.4	28 – 52	16.3 ⁽¹⁾
BF dust	0.2		0.18		0.37	
Mill scale	0.064		0.084		0.15	
Coke	0.04		0.07		0.11	
Returned ore	0.027		0.016		0.043	
Mixture	0.033		0.12		0.15	
Produced sinter	0.004		0.0008		0.005	
Granulated mixture ⁽²⁾	0.053		0.082		0.13	

⁽¹⁾ Dust from an ESP of a sinter plant, working at 120 – 130 °C with three fields.
⁽²⁾ Sinter plant characteristics: dry sinter production of 10 000 t/day; effective sintering area of 330 m²; bed thickness of 670 mm; windboxes: 21. Wet raw materials (t/day): iron ores 7660; limestone 1090; burnt lime: 170; coke: 410; returned sinter: 1770; dust: 390; mill scale: 470; serpentine: 310; other: 1300.
 NB: Sinter plant characteristics: dry sinter production of 9600 t/d, wet blended ore (containing dusts 4 %, LD slag 4 %, mill scale 2 %, other 4 %): 10200 t/d, wet limestone: 560 t/day, wet burnt lime: 120 t/day, wet coke: 310 t/day, dry return sinter: 620 t/day, Ni slag: 70 t sinter/day, mixing water: 230 m³/day). Effective sintering area: 210 m², bed thickness: 660 mm, number of windboxes: 15.
 Source: [224, Xhrouet 2002] [256, Kasai et al. 2001] [263, Kasai et al. 2001].

Temperatures in the suction pipes are ideal for the de novo synthesis. Certain sections of the suction pipes have adequate temperatures (250 and 450 °C have been measured; see Figure 3.12). ‘De novo’ reactions may appear on the particulates or in the particulates, immobilised in the inner part of the suction pipes or the sinter air pipes of the cleaning system.

The basic criteria that are required for the de novo synthesis of PCDD/F include the following: a solid carbon structure with an imperfect or degenerate graphitic structure, inorganic chlorine, copper or iron metal ions, an oxidising atmosphere and a temperature in the range of 250 to 450 °C. Most of these criteria can be met within the sinter bed and the windboxes. Therefore, a significant proportion of the PCDD/F are produced in the sintering process via the de novo synthesis route. Certainly, the studies carried out up to 2009 suggest that the formation of PCDD/F occurs principally within the sinter bed itself rather than downstream in the waste gas system as is generally found in municipal waste incinerators.

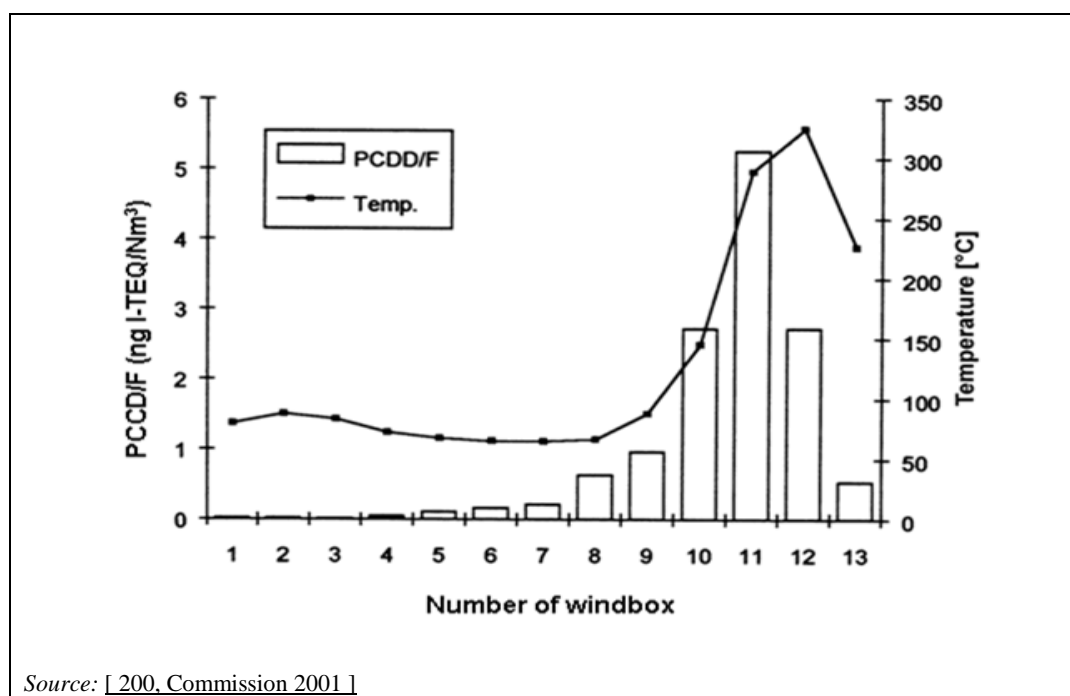

Figure 3.12: PCDD/F and temperature profile in the waste gas along the sinter strand

Supporting evidence for the formation of PCDD/F in the sinter bed is as follows: beneath the sinter strand are the windboxes which are connected to the wind main by the wind legs. The windboxes and wind legs' mass emissions profile tends to peak at or around the burn-through point on the strand (Figure 3.7).

This could be attributed to the fact that waste gas temperatures also follow a similar trend and that the potential for de novo synthesis to occur in the windboxes and wind legs is at a maximum at this position in the strand. However, PCDD/F are present in the earlier windboxes and wind legs where temperatures are below the optimum range for de novo synthesis to occur. Thus, the commonly accepted explanation of the windboxes and wind legs profile is that PCDD/F are formed in the bed and subsequently trapped by condensation on the cooler burden at lower points in the bed. As the flame front moves downwards, the trapped PCDD/F are revolatilised and swept downwards through the bed as a tight zone until a point is reached where there is no cold burden left for trapping to occur. The latter mechanism is also supported by interrupted sinter pot experiments carried out in France, where it was demonstrated that PCDD/F were concentrated in cooler parts of the sinter bed.

In the sintering process, since the PCDD/F are formed principally within the sinter bed, little can be done to change the temperature profile of the bed without affecting the process as a whole. Attempts to prevent or minimise the formation of PCDD/F need therefore to be directed towards modifying the conditions in the bed in order to prevent the de novo formation of PCDD/F and any potential precursors.

Nevertheless, measurements carried out at two locations along a windbox at about 300 °C (closest point from the grate that could be practically reached and at about 3 m downstream) showed that the PCDD/F concentrations were multiplied by a factor of 10 between the two sampling points [230, Brouhon et al. 2001]. Furthermore, abatement trials using countercurrent inhibitors injected into the windboxes towards the grate showed reductions of PCDD/F concentrations which is only possible if PCDD/F are formed at least to some extent in the windboxes at this temperature.

Judging from the distribution of the PCDD/F released in the second stage, the mechanism of their formation is considered different from that of the PCDD/F formed in the first stage. In the

second stage, the PCDD/F might have been produced in the windboxes, with organic substances and chlorine supplied from incomplete sinter areas or with grease and dust in the windboxes.

The concentration profiles of the 17 targeted PCDD/F homologue groups can be substantially the same for all Corus sinter plants in the UK despite differences in feedstock composition. From the PCDD/F formation studies carried out on sinter plants throughout Europe, it has been found that the congener profiles of sinter plant waste gas emissions are almost the same for all sinter plants regardless of the actual concentration of PCDD/F in the waste gas. These observations suggest that the congener profile is a characteristic of the process and appears not to be directly related to the I-TEQ value. These findings also suggest that the formation of PCDD/F is subject to thermodynamic control and that a common formation mechanism applies in most, if not all, sinter plants. Table 3.11 indicates that the not fully chlorinated dibenzodioxin and dibenzo-furan congeners dominate the emissions of polychlorinated pollutants.

Table 3.10: Total concentrations of PCDD and PCDF homologue groups in wind leg samples

Congener	Wind leg number					
	4	6	8	10	12	14
	(ng/Nm ³)	(ng/Nm ³)	(ng/Nm ³)	(ng/Nm ³)	(ng/Nm ³)	(ng/Nm ³)
TetraCDD	0.14	1.49	0.91	2.45	0.59	0.85
PentaCDD	0.42	2.50	1.61	3.15	2.03	1.74
HexaCDD	0.63	2.53	1.31	2.40	2.49	2.68
HeptaCDD	0.51	1.37	0.79	1.20	1.51	1.39
OctaCDD	0.90	1.40	0.88	0.94	0.93	0.70
TetraCDF	22.86	132.48	73.16	169.17	184.50	109.87
PentaCDF	18.45	89.75	52.65	90.53	95.16	62.76
HexaCDF	13.72	51.09	25.92	41.06	42.35	31.05
HeptaCDF	4.20	13.87	6.36	9.29	8.65	8.18
OctaCDF	1.14	3.06	1.42	2.11	2.01	1.55
<i>Source: [157, Thompson, P. et al 2003].</i>						

3.2.2.1.2.10 Polychlorinated Biphenyls (PCB)

[9, Fisher et al. 1998] [122, Scholz et al. 1997] [300, Eurofer 2007] [387, Fisher et al. 2005]

PCB can be formed under the same conditions as those described above for PCDD/F. However, during the formation pathway, no scrambling of the phenyl rings takes place. In a further reaction, the PCB produced may undergo a ring closure to yield PCDF, but not PCDD. Thus, as is the case for PCDF, no aromatic precursors are necessary for it to be formed.

PCB may also be present in the raw materials. PCB concentrations in coke breeze and iron ores are reported to be around 1 – 1.6 mg/t and limited calculations for one sinter plant indicated a potential input of 850 µg/t graded sinter. Clearly there is a possibility that PCB could be destroyed in the incineration zone (see Figure 3.3) but it should be remembered that the combustion process is not as intense as in waste incinerators, for example, and it is thought unlikely that all the PCB in the process air can be destroyed in the combustion zone.

Moreover, PCB are relatively volatile and may be driven off as the burden is heated by the gaseous combustion products ahead of the combustion zone.

Table 3.11 shows some limited data concerning PCB emissions from sinter plants.

Table 3.11: PCB emissions from sinter plants

Pollutant	Range	Units
PCB ⁽¹⁾	1 – 13	mg Σ PCB/t sinter
PCB ⁽²⁾	24.5 – 178	ng/t sinter
PCB ⁽²⁾	0.01 – 0.09 ⁽³⁾	ng/Nm ³

⁽¹⁾ Sum of all PCB, calculated from (Σ PCB 28+52+101+153+138+180) \times 5 (factor of 5 according to [155, UN-ECE Pops 1997]). Data from two sinter plants.

⁽²⁾ WHO-12 PCB (dioxin-like congeners, expressed in terms of I-TEQ values), (see Section 13.3).

⁽³⁾ Range of annual average emissions concentrations using the average specific gas flow of 2100 Nm³/t sinter.

Source: [300, Eurofer 2007].

Table 3.12 shows the PCB congeners which were found during the analysis of sinter waste gas.

Table 3.12: PCB congeners found in waste gases from sinter plants

PCB congeners (IUPAC number)	Chemical name
77	3,3',4,4' – TCB
118	2,3',4,4',5 – PCB
105	2,3,3',4,4' – PCB
126 ⁽¹⁾	3,3',4,4',5 – PCB

⁽¹⁾ For toxicity, however, the contribution of this congener is remarkably large.

NB: Coplanar polychlorinated biphenyls (co-PCB) amount to 5 – 10 % of the total toxicity of PCDD/F.

A strong correlation exists between the concentrations of PCDD/F and WHO-12 PCB (expressed in terms of I-TEQ values), such that the contribution of WHO-12 PCB to the overall I-TEQ concentration is typically 9 – 10 % of PCDD/F. The close relationship found between PCDD/F and PCB concentrations suggests that there is a common link between the formation of these compounds (see Section 13.3).

3.2.2.1.2.11 Further organohalogen compounds [133, Stieglitz et al. 1997] [300, Eurofer 2007]

The presence of PCDD/F and PCB can be considered indicators for the formation of organohalogen compounds such as chlorobenzenes, chlorophenols, chloronaphthalenes, etc. Thus, these compounds could be expected in the waste gas of sinter plants although no investigations are known about this to date.

3.2.2.1.2.12 Polycyclic aromatic hydrocarbons (PAH) [300, Eurofer 2007] [387, Fisher et al. 2005]

As mentioned in Section 3.1.3, the reactions in the sinter bed are complex. The combustion process is not homogenous and is incomplete, resulting in significant quantities of polycyclic aromatic hydrocarbons (PAH) being produced. The data presented in Table 3.4 show that annual average emission factors are in the range of 0.2 – 592 mg Borneff 6/t sinter (which equates to a range of annual emissions concentrations in the range of 0.1 – 282 μ g Borneff 6/Nm³).

No correlation was found between the concentrations of PCDD/F and PAH. No data are available, regarding what the most relevant PAH compounds in the emissions of sinter plants are.

3.2.2.1.2.13 Plumes

[261, Kasama et al. 2006]

Visible smoke of exhaust gas from iron ore sintering plants sometimes occurs. The following causes have been suggested:

- the dust that passes through the ESP is fine dust, at least 40 % of which are 10 μm or smaller in particulate size and mostly comprise sinter mix particulate and submicron KCl particulate
- a very small amount of SO_3 at a concentration of about 0.1 ppm is present in the exhaust gases from the sintering plant, and the occurrence of an acid dew owing possibly to the condensation of H_2SO_4 may induce the formation of mist and visible smoke when the gases are cooled. The phenomenon of a long horizontal trail of smoke, which is characteristic of exhaust gases from sintering plants, may be due to the effect of evaporation restraint by sulphuric acid in the mist
- the removal of dust alone by an ESP is typically not sufficient for preventing the formation of visible smoke of exhaust gases from sintering plants; desulphurisation treatment equipment also seems to be necessary
- during unusual operations (e.g. when a SO_x processing plant is not working properly), the concentration of SO_x in exhaust gas increases.

3.2.2.1.3 Dust emissions from sinter cooling

[300, Eurofer 2007]

After falling off at the end of the sinter grate – an area known as the discharge zone – product sinter is crushed, screened, conveyed and cooled. These operations have the potential for relevant dust emissions.

The cooling of sinter is processed with a huge amount of cooling air. Since the coolers are usually not fully covered, diffuse emissions occur. From the covered parts, the emissions can be collected and further treated. Abatement is carried out by collecting, filtering (using bag filters or ESPs) and recycling the main waste gases to the sinter strand. When the hot gases from sinter cooling and from the sinter screening are returned to the process in order to use the sensible heat, they can be returned to the process with or without predestuffing. Often the waste gas from the cooler is treated together with waste gas extracted from the discharge zone. The limited data provided in Table 3.5 and Table 3.6 indicate a range of annual average emissions concentrations of 1 – 85 mg/Nm^3 at the sinter cooling stage (a range that corresponds to 14 – 212 g/t sinter).

The composition of the dust at the discharge zone and from cooling (secondary emissions) is different from dust emitted from the sinter strand (primary emissions). In particular, no or very low emissions of alkali chlorides and organic micro-pollutants occur and usually the dust can be recycled to the sinter process.

3.2.2.2 Waste water

[24, EC Haskoning 1993] [65, InfoMil 1997]

Rinsing water

The type of processes in an iron and steel plant inherently cause dust deposition on the plant premises. In order to prevent runoff to surface water, this should be removed, preferably by dry techniques. A few plants, however, do use rinsing water cleaning techniques. The resulting

waste water contains suspended solids (including heavy metals) and is usually treated before discharge. For example, in a sinter plant with a production of approximately 11 000 tonnes of sinter per day, the rinsing water flow is about 460 m³/day. This waste water is treated by means of sedimentation in the recirculation circuit and enhanced settling prior to discharge. No data from other plants are available.

Cooling water

In the sinter plant, cooling water can be used for the cooling of the ignition hoods and the fans as well as for the sinter machines. In an integrated steelworks producing 4 Mt steel per year, the sinter plant cooling would require a water flow of approximately 600 m³ per hour. The cooling water is normally completely recycled. Legal constraints of the local authorities in some countries demand for the prevention of plumes or the formation of industrial snow and ice during the winter period from re-cooling towers, which might prevent further cooling water recycling.

Waste water from waste gas treatment

Waste water from waste gas treatment will only be generated if a wet abatement system is applied. The water flow contains suspended solids (including heavy metals), persistent organic pollutant compounds such as PCDD/F and PCB, PAH, sulphur compounds, fluorides and chlorides. It is usually treated before discharge. The quantity and quality of such waste water is described in Section 3.3.2.4.

3.2.2.3 Process residues such as waste and by-products

[7, Bothe 1993]

Normally all solid process residues such as waste and by-products originating from the sinter plant (dusts from dedusting devices and sieving fractions) are recycled to the strand. However, there can be four exceptions:

- the first concerns sludge from wet waste gas treatment systems, which may be put to landfill or sometimes returned to the sinter plant. There is only one plant in Europe operating such a system, which might be shut down in the medium term
- the second exception is filter dust from the last field of electrostatic precipitators (ESP). As mentioned in Section 3.2.2.1.2.2, most European sinter plants are operated with fully closed dust cycles [7, Bothe 1993]. However, some plants exclude fine dust from the last field of the ESP. This dust mainly consists of alkali and metal chlorides. This 'partly open filter dust cycle' is carried out in order to improve the operation of the ESP or (in one case) of the bag filter, or to reduce alkali and metal chloride emissions
- the third exception concerns dusts with high alkali, chlorides and sulphur contents which can deteriorate the abatement efficiency of ESPs (see Section 3.3.2.1)
- the fourth concerns constraints due to stringent national legal criteria for recycling.

3.2.2.4 Energy consumption

The European Blast Furnace Committee Survey of the operational data for sinter plants (2004) reveals that sinter plants use 1290 – 1910 MJ/t sinter of thermal energy (solid fuels including flue dust and ignition fuel), with an average consumption of 1344 MJ/t sinter. These are 39 – 64 kg coke breeze equivalents/t sinter, with an average of 50 kg. Total electrical consumption is in the range of 92 to 155 MJ/t sinter [299, Eurofer 2007]. The consumption of heat for ignition is between 70 and 85 MJ/t sinter [241, Poland 2007]. There is only a slight difference in fuel consumption between low basicity sinter (<1.7 CaO/SiO₂) and higher basicity sinter (≥1.7 CaO/SiO₂) [200, Commission 2001].

Table 3.2 shows data for 20 European sinter plants. Coke is the dominant sinter plant energy input (about 88 %), with electricity and gas (COG and/or BF gas and/or natural gas) making up

the remainder. The main energy outputs are via waste gas, water evaporation, the reaction energy required and the sinter itself. Sinter cooling is often combined with the recovery of sensible heat [300, Eurofer 2007].

3.2.2.5 Noise

[242, Caughlin 2007]

The following noise sources dominate in sintering plants:

- sinter waste gas fans
- sinter cooling fans
- sinter crushing.

Noise can be an important issue in some installations. The properties of the noise are high-energy noise of low frequency. This noise is caused by fan-tip frequency (speed) and by the throttling of flows through the sinter beds.

3.3 Techniques to consider in the determination of BAT for sinter plants

This section describes techniques (or combinations thereof), and associated monitoring, considered to have the potential for achieving a high level of environmental protection in the activities within the scope of this document.

It covers process-integrated techniques and end-of-pipe measures. Waste prevention and management, including waste minimisation and recycling procedures are also considered. Furthermore, techniques for reducing the consumption of raw materials, water and energy are covered.

Annex III to the Directive lists a number of criteria for determining BAT, and the information within this chapter will address these considerations. As far as possible, a standard structure as shown in Table 3.13 is used to outline the information gathered concerning each technique, to enable a comparison of techniques and the assessment against the definition of BAT given in the Directive.

This section does not necessarily provide an exhaustive list of techniques which could be applied in the sector and other techniques may exist or may be developed, which could be considered for the determination of BAT for an individual installation.

Table 3.13: Information breakdown for each technique described in this section

Type of information considered	Type of information included
Description	Brief technical description using, as appropriate, pictures, diagrams and flow sheets.
Achieved environmental benefits	Main potential environmental benefits to be gained through implementing the technique (including energy, water, raw material savings, as well as production yield increases, energy efficiency, etc.).
Cross-media effects	<p>Potential environmental side effects and disadvantages to other media due to implementing the technique, including details of the environmental effects of the technique in comparison with others (advantages and disadvantages supported by data if available) in order to assess the impact of the technique on the environment as a whole. This may include issues such as:</p> <ul style="list-style-type: none"> • consumption of raw materials and water • energy consumption and contribution to climate change • stratospheric ozone depletion potential • photochemical ozone creation potential • acidification resulting from emissions to air • particulate matter in ambient air (including microparticles and metals) • eutrophication of land and waters resulting from emissions to air or water • oxygen depletion potential in water • persistent/toxic/bioaccumulable components in water or to land (including metals) • creation or reduction of (waste) residues • ability to reuse or recycle (waste) residues • noise and/or odour • risk of accidents.
Operational data	Actual performance data (including reference conditions, monitoring periods and monitoring methods) on emission levels, consumption levels (raw materials, water, energy) and amounts of waste generated. Any other useful information on how to operate, maintain and control the technique.
Applicability	Indication of the type of plants or processes in which the technique may or cannot be applied as well as constraints to implementation in certain cases, considering, e.g. plant age (new or existing), factors involved in retrofitting (e.g. space availability), plant size (large or small), techniques already installed and type or quality of product.
Economics	Information on costs (investment and operating) and any possible savings (e.g. reduced raw material or energy consumption, waste charges) or revenues including details on how these have been calculated/estimated. Economic information relevant to new build and retrofit to existing installations will be included. This should allow for identifying, where possible, the overall economic impact of the technique.
Driving force for implementation	Specific local conditions, requirements (e.g. legislation, safety measures) or non-environmental triggers (e.g. increased yield, improved product quality) which have driven or stimulated the implementation of the technique to date.
Example plants	Reference to the plant(s) where the technique has been implemented and from which information has been collected and used in writing the section. Indication of the degree to which the technique is in use in Europe or worldwide.
Reference literature	Literature or other reference material (e.g. books, reports, studies, websites) that was used in writing the section and that contains more detailed information on the technique.

3.3.1 Process optimisation

Description

A planned and carefully implemented maintenance practice can ensure that the sinter plant can be operated continuously and without significant disruption to the production of sinter. This is one of the most important of the process-integrated measures to reduce the emissions from sinter plants. Disruption to the smooth progress of the flame front through the sinter bed will result from unplanned stoppages of the strand. This has an adverse effect on the generation of dusts and some organic species.

Research into the formation of PCDD/F emissions in the sintering process [9, Fisher et al. 1998] has shown that PCDD/F are formed within the sinter bed itself, probably just ahead of the flame front as the hot gases are drawn through the bed and to some extent into the windboxes and wind legs (see Section 3.2.2.1.2.9). It has also been shown that disruptions to flame front propagation, i.e. non-steady state operations, result in higher PCDD/F emissions. The solution therefore has been to operate the sintering process in as consistent a manner as possible in terms of strand speed and, in addition, to reduce variations in the bed composition (particularly consistent blending of revert materials and the minimisation of chloride input) and in bed height. Furthermore, maintaining a stable rate of additions such as burnt lime, controlling mill scale oil content to a consistent level of <0.5 % which might result in a raw mix oil concentration of <0.1 % and keeping the strand, ductwork and dedusting devices air-tight to minimise, as much as possible, the amount of air ingress into the operation, can have beneficial effects on the emissions from the sinter strand.

Achieved environmental benefits

Higher than normal levels of particulate emissions can occur during the start up of a sinter strand after a short stop as a consequence of the bed drying out and the head front becoming dissipated. After longer stops it may be necessary to initiate operation without some of the end-of-pipe abatement equipment in operation, e.g. an ESP and/or bag filter may have to be bypassed to protect the equipment from high moisture levels. Thus minimising stops and short-term fluctuations to the smooth operation of the strand will result in a reduction in the peak emissions of particulates and reduce the visual impact of the plant operations. Other emissions to air are also reduced through consistent operations.

No single technique can be identified that enables relatively low PCDD/F formation, rather, it seems to be a combination of a number of the techniques mentioned above but especially a continuous strand operation.

Cross-media effects

Energy usage is minimised by consistency of operations. There are no negative cross-media effects. According to the application of the aforementioned techniques, there are added advantages in terms of operational performance reflected in increased productivity, reduced energy demand and consistent sinter quality.

Operational data

No data submitted.

Applicability

The described techniques can be applied at new and existing plants.

Economics

There are no installation costs. The operational costs for maintenance and labour are balanced by the benefits of higher productivity and consistent sinter quality. Furthermore, a well maintained and smoothly run plant results in reduced fuel and energy consumption.

Driving force for implementation

No data submitted.

Example plants

The aforementioned techniques are usually applied in European plants. All operators endeavour to operate their sinter plants as smoothly as possible, minimising stoppages by ensuring that high maintenance standards are upheld.

Reference literature

[9, Fisher et al. 1998] [301, Eurofer 2007]

3.3.2 Abatement techniques for emissions into air from sinter plants**3.3.2.1 Advanced electrostatic precipitator (ESP)****Description**

The most commonly used abatement devices for treating the large volumes of waste gases in sinter plants in the EU are dry electrostatic precipitators with three or four fields arranged in series. These work by generating an electrostatic field across the path of the dust in the air stream. The particles become negatively charged and migrate towards positively charged collection plates. In dry electrostatic precipitators, the collected material is removed by 'rappers' which periodically strike or vibrate the collection plates, dislodging the material and allowing it to fall into collection hoppers.

In wet electrostatic precipitators, the collected material is removed by a constant flow of water, which is collected and subsequently treated.

In order to obtain adequate separation, the specific resistivity of the particulates should be in the range of $10^4 - 10^9 \Omega\text{m}$. Usually, most particulates in the waste gas from the sintering process are within this range but compounds with significantly higher specific resistivity, such as alkali chlorides, heavy metal chlorides and calcium oxides (see Figure 3.10) also occur and are difficult to remove with high efficiency.

Other factors that influence the efficiency are: waste gas flow rate; strength of the electric field; particulate loading rate; SO_3 concentration; moisture content; and, the shape and area of the electrodes.

Performance improvements have been made to ESPs by the use of higher or variably pulsed voltages and rapid reaction voltage and current controls. Operations have been further enhanced through the introduction of systems to improve the rapping forces to a gravitational constant of 200, high energy pulse superimposition and refurbishment with increased plate spacing. Conditioning with SO_3 and/or water vapour may also increase dedusting efficiency. As a disadvantage, HCl emissions can increase.

Figure 3.13 presents the influence of the alkali input (e.g. Na, K) into the sinter process on dust emissions after the ESP at the sinter plant in Voestalpine Stahl GmbH, Donawitz, Austria before the installation of a bag filter. The diagram shows that dust emissions of below 50 mg/Nm^3 were achievable only with alkali inputs of below 2.5 kg per tonne sinter.

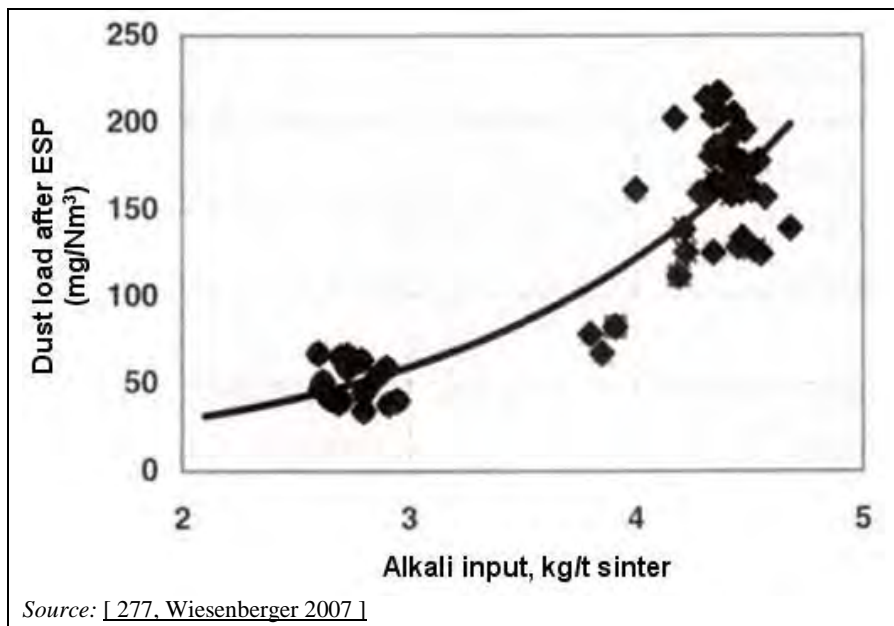

Figure 3.13: Influence of the alkali input into the sinter process on dust emissions after the ESP at the sinter plant in Voestalpine Stahl GmbH, Donawitz, Austria

Three types of ESPs with a good performance reported are highlighted below:

1. Use of energy pulse superimposition: the pulse system provides a voltage consisting of negative narrow pulses superimposed on a filtered voltage of negative polarity. These high voltage pulses have a width of 140 μs and can be repeated at a frequency of up to 200 pulses per second. The peak voltage is higher with pulse energisation, providing a better particle charging and current distribution in the precipitator. One of the most important characteristics of pulse energisation is its capability to cope with high resistivity dust (see Section 3.2.2.1.2.1).
2. Moving Electrode Electrostatic Precipitator (MEEP): in the MEEP, several groups of electrode plates move on caterpillar tracks. Rotating brushes continuously clean these plates. Thus, the strongly-adhesive dust is easily removed from the plates and the insulating effect of the dust layer is avoided.
3. Electrostatic Space Cleaner Super (ESCS). The ESCS is operated with a higher voltage (70 – 200 kV). Enlarging the distance between the electrode plates allows for higher voltages.

Other techniques to improve the performance of the ESP are controlled by programmable logic and use of up to five fields.

Achieved environmental benefits

ESPs reduce dust emissions with an efficiency of >95 %. In some cases, an efficiency of over 99 % is achievable. On an annual average basis, ESPs with MEEP fields can achieve dust concentrations in the range of 20 to 50 mg/Nm^3 only taking into account normal operating periods and excluding start-ups and shutdowns. For the measurement results of one plant in 2005 it can be seen that with MEEP, daily mean values of below 30 mg/m^3 can be achieved [326, Buchwalder, J. et al 2008] (see Figure 3.14). For the same plant, the daily average dust concentrations between 2005 and 2007 were between 24.6 and 29.4 mg/Nm^3 .

For two German sinter plants equipped with an ESP, a dust emissions level of 36 mg/Nm^3 has been reported (annual averages, based on continuously measured half-hourly average values; at one plant the 5th and 95th percentiles were 25 and 65 mg/Nm^3 respectively) [244, Plickert 2007]. ESPs with energy pulse superimposition can achieve 43 to 77 mg/Nm^3 on an annual average basis, although in some plants using unique ores, this range can extend to an upper level

of 140 mg/Nm³. Although not operated within the EU, it is reported that the ESCS can achieve emissions of <40 mg/Nm³ although the basis of this level is not clear.

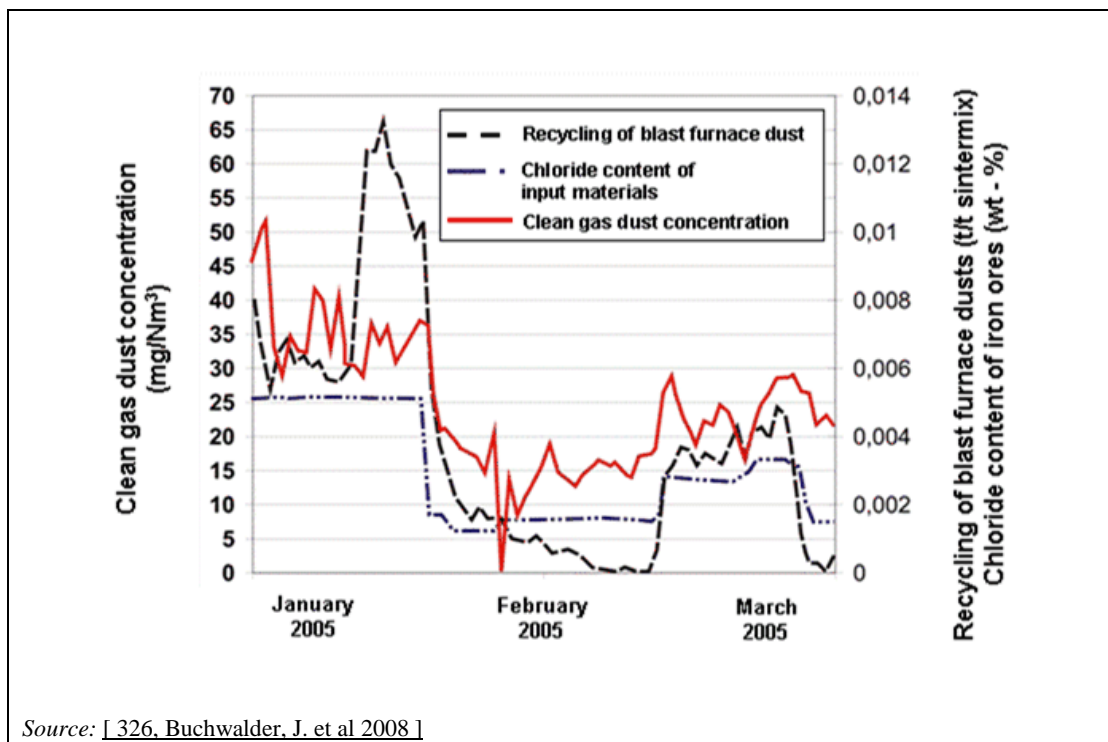

Source: [326, Buchwalder, J. et al 2008.]

Figure 3.14: Achieved clean gas dust concentrations with an ESP for sinter strand off-gas and the impact of reduced chloride input

Dust emissions of 36 mg/Nm³ (annual average values) have been achieved at sinter plants in Germany, where the injection of zeolite and lignite coke in the ESP have been carried out. In one of the plants, partial waste gas recirculation has also been applied.

Dust emissions between 20–42.7 mg/Nm³ have been achieved at two sinter plants at ArcelorMittal, Ghent, Belgium in 2008. These ESPs are equipped with micropulse discrimination. It has to be taken into account that these figures are annual average values. Table 3.14 gives the achieved dust emission performance of ESPs at two sinter plants at ArcelorMittal, Ghent, Belgium in 2008.

Table 3.14: Performance of ESPs at two sinter plants at ArcelorMittal, Ghent, Belgium in 2008

Parameter	Sinter plant 1	Sinter plant 2	Units
	Dust	Dust	mg/Nm ³
Annual average	20.01	42.72	mg/Nm ³
Stand deviation	9.64	9.72	mg/Nm ³
Minimum	6	25.6	mg/Nm ³
Maximum	67.3	100.6	mg/Nm ³
Median	17.1	40.5	mg/Nm ³
95 % percentile	37.6	61	mg/Nm ³

Source: [177, Eurofer 2009].

Table 3.15 shows the achieved emission concentration values for sinter strand dedusting with an ESP at three German sinter plants including statistical information and the corresponding reference time periods.

Table 3.15: Achieved emission concentration values for sinter strand dedusting with an ESP at three German sinter plants

Parameter	Emission level	Percentile		Unit	Reference time period
		5 %	95 %		
Dust	36			mg/Nm ³	AAV
	36	25	65		HHAV (c)
	29.4	15	40		HHAV (c)
NO _x	384			mg/Nm ³	AAV
	400	320	520		HHAV (c)
	272	200	350		HHAV (c)
SO _x	250	200	550	mg/Nm ³	HHAV (c)
	311				AAV
	425	300	550		HHAV (c)
HF	0.6			mg/Nm ³	AAV
	0.7				AAV
	1.4				HHAV
HCl	0.72	NA	3	mg/Nm ³	AAV
	17.4				HHAV
	20.4				HHAV
Cd, Tl	0.0067			mg/Nm ³	AAV
Cd	0.04			mg/Nm ³	HHAV
Hg	0.025				HHAV
As, Co, Ni, Se, Te	0.02			mg/Nm ³	AAV
	0.018				
Pb, Cr, Cu, Mn, V	0.87			mg/Nm ³	AAV
Cu, Mn, V	0.47			mg/Nm ³	HHAV
Pb	1.98			mg/Nm ³	AAV
	0.64				
Cr	0.008			mg/Nm ³	HHAV
BaP	0.001			mg/Nm ³	HHAV
Benzene	0.38			mg/Nm ³	HHAV
TOC	58.2			mg/Nm ³	HHAV
PCDD/F	0.4 ⁽¹⁾			ng/Nm ³	AAV
	0.166 ⁽²⁾⁽³⁾				8HAV
	0.152 ⁽²⁾⁽³⁾				8HAV
	0.22 ⁽²⁾⁽³⁾				8HAV
	0.129 ⁽⁴⁾				8HAV
	0.25 ⁽⁵⁾				8HAV

(¹) Gas recirculation, zeolite/lignite coke injection.
(²) Zeolite/lignite coke injection.
(³) Average value from 8 measurements.
(⁴) Average value from 4 spot measurements January 2006 excluding measurement uncertainty.
(⁵) Average value from 3 spot measurements April 2006 excluding measurement uncertainty.
NB: — NA = Not available.
— HHAV = Half-hourly average value.
— AAV = Annual average value.
— 8HAV = Average value every eight hours.

Source: [128, Sporenberg 2006] [187, TÜV SÜD 2007] [244, Plickert 2007].

Cross-media effects

A solid waste flow is generated. In some cases, this waste flow can be recycled into the sintering process. Whenever the concentration of heavy metals and/or alkali compounds is too high, recycling may be hampered.

For a sinter plant with a waste gas flow of approximately 1 million Nm³/h, the energy consumption is 300 to 400 kW. At a sinter production rate of 4 Mt/yr, this amounts to 2 to 3 MJ/t sinter (or 0.1 to 0.15 % of the total sinter energy consumption).

Operational data

The ESP is the most common dust abatement device for cleaning sinter plant waste gas and ESPs can usually be applied without problems. Attention needs to be paid to the amount of hydrocarbons in the waste gas in order to avoid the risk of fire. Operators control the mill scale input to avoid hydrocarbons in the waste gas.

Besides the modification and application of advanced ESP techniques, the following techniques are often applied in order to achieve the maximum dedusting efficiency of the ESP:

- careful choice of uncritical recycling materials
- limitation of critical recycling materials, such as oil-contaminated mill scale, which contain chloride and alkali dusts and sludges
- preblending and homogenisation of the recycling materials
- deposit of the dust from the last chamber of the ESP, where most of the alkali and chloride can be found
- adaptation of the sinter operation such as variation in sinter productivity, bed height and stoppages for the cleaning of the ESP.

Table 3.16 gives some operational and economic data concerning electrostatic precipitators in use at sinter plants. The data given are emission levels reported and it is not clear in any case what time periods are used (e.g. daily average, instant value).

Applicability

Electrostatic precipitators can be installed at both new and existing plants. The MEEP can be installed as a last field of an existing electrostatic precipitator, or as a separate unit in its own housing, but the arrangement and possibility of either type of installation will be site-specific.

Economics

The decisive cost factor is the waste gas flow. Investment for revamping two existing ESPs to last generation electrostatic precipitators was estimated in 2002 at EUR 10 – 15 million for a sinter plant with a 1.4 million Nm³/h gas flow (example plants: ArcelorMittal, Fos sur Mer, France).

The following costs for an ESP were reported for 1996:

- investment: EUR 5 to 7.5/Nm³/h
- operational: EUR 0.05 to 0.08/1000 Nm³ treated off-gas
- a sinter plant with a capacity of 4 Mt/yr, a waste gas flow of 1 million Nm³/h and 8640 operational hours per year, would correspond to the following costs:
 - investment: EUR 5 to 7.5 million
 - operational: EUR 0.11 to 0.16/t sinter.

For all examples the currency was converted into ECU in 1996 and for the review into EUR.

For a single MEEP filter added to the existing ESP to treat 500 000 Nm³/h, a cost of about EUR 1.1 million was quoted in 1997.

Driving Force for implementation

The main driving force for the implementation of the techniques described has been stringent emissions standards or other legal requirements.

Example plants

Energy pulse superimposition has been installed at many sinter plants, for example on four strands at Gwangyang Works, Posco, South Korea, on two strands at Thyssen Krupp Stahl, Duisburg, Germany, on two strands at ArcelorMittal, Dunkirk and Fos sur Mer, France and on two strands at ArcelorMittal Ghent, Belgium. Some Corus UK plants have peak modulation and pulsing type systems.

A MEEP has been installed at two sinter plants in Japan, on two strands at Riva, Taranto, Italy and at one sinter plant in ArcelorMittal, Eisenhüttenstadt, Germany.

An ESCS has been installed at the sinter plant of Nippon Steel Corporation, Yawata Works in Japan.

Reference literature

[7, Bothe 1993] [45, Gebert 1995] [61, Hodges 1995] [65, InfoMil 1997] [71, Kim et al. 1998] [145, UBA Comments 1997] [209, EC 2005] [241, Poland 2007] [242, Caughlin 2007] [244, Plickert 2007] [247, Netherlands 2007] [252, France 2007] [254, Eurofer 2007] [276, Italy 2007] [277, Wiesenberger 2007] [295, Hartig et al. 2006] [308, Eurofer 2007] [326, Buchwalder, J. et al 2008]

Table 3.16: Operational and economic data for MEEP and ESCS electrostatic precipitators operated at sinter plants to treat sinter plant waste gas

		Unit	Nippon Steel Corp. Wakamatsu/Yawata works Japan	ArcelorMittal Eisenhüttenstadt Germany	Kobe Steel Ltd. Kakogawa works Japan	Sumitomo Metal Ind., Ltd. Wakayama Japan
Sinter production:	design	t/h	1000	NA	560	NA
	actual		600	350	375	185
Total waste gas flow:	design	10 ⁶ Nm ³ /h	2	0.53	1	NA
	actual		1	0.52	0.7	0.4
Sinter basicity:		CaO/SiO ₂	1.92	1.97	1.8	2.2
ESP:	type		ESCS ⁽¹⁾	MEEP ⁽²⁾	NA	Dry ESP
	number		Two parallel	One	Three parallel	One
	flow per ESP	10 ⁶ Nm ³ /h	0.5	0.53	0.25 – 0.33	0.4
Dust inlet concentration:	design	mg/Nm ³	1000	Max. 1000	1000	NA
	actual	mg/Nm ³	NA		1000	1100
Dust outlet concentration:	design	mg/Nm ³	50	35	50	NA
	actual	mg/Nm ³	20 – 37	25 – 30	30 – 50	40
ESP efficiency:	design	%	95	NA	95	NA
	actual	%	NA		95 – 97	96
Conditioning ESP and/or pretreatment sinter feed:			ESP non-conditioned; Oil content in the raw materials is regulated (no de-oiling)	ESP non-conditioned, lime and lignite coke injection, no special measures to prevent fire hazard	ESP non-conditioned; Max. HC ⁽⁴⁾ in ESP precipitate: 1 %; achieved by max. input mill scale of 3 % of feed	Non-conditioned
By-product (dust):	amount	kg/t sinter	1 – 2		1 – 2	2
	processing		Recycled to sinter process	Exclude filter dust from field three and four	NA	NA
Energy demand:		GJ/t sinter	0.00036		NA	NA
Investment ⁽³⁾ :		EUR x10 ⁶	NA		NA	4.2 in 1975
Operational costs ⁽³⁾ :		EUR/t sinter	0.0018 – 0.0024 in 1986 (only maintenance)		NA	0.11 in 1986 (maintenance and depreciation excluded)
Oxygen content:				13.6 %		
⁽¹⁾ ESCS: Electrostatic Space Cleaner Super. ⁽²⁾ MEEP: Moving Electrode Electrostatic Precipitator. ⁽³⁾ For all examples the currency was converted into ECU in 1996 and for the review into EUR. ⁽⁴⁾ Hydrocarbons. NB: NA = Not available. Source: [65, InfoMil 1997] [326, Buchwalder, J. et al 2008].						

3.3.2.1.1 Reduction of PCDD/F by means of ESPs and additives**Description**

This technique involves the injection of an activated carbon ahead of the ESP in order to particularly capture PCDD/F. At ArcelorMittal, Ghent in Belgium, this technique has been in industrial use since 2000 on sinter plants 1 and 2. Activated coal is used as the carbon source and limestone is used as an inert material.

Different carbon sources have been tested in the past for the purpose of absorbing various species in the waste gases of sinter plants. These range between activated coals, selected cokes, charcoals and specially-prepared carbon absorbents. A future development of the system might come from improvements to the adsorbent. To minimise the risk of glow fires in the electrostatic precipitators and limit the carbon content of the captured dusts, some inert material (e.g. fine crushed limestone, hydrated lime, etc.) can also be injected. (In the case of ArcelorMittal Ghent, Belgium, the carbon content of the ESP dusts should be less than 25 %, but they aim at <20 %.)

The carbon and inert material are dosed separately in one pipe leading to the waste gas ducts, with each duct having its own dosing system. Since the waste gas duct is under suction, the carbon and inert material are sucked into the turbulent gas stream created by a static mixer (an inclined plate) in the duct and the injected materials become rapidly dispersed in the waste gas. In the ducts, the carbon adsorbs a proportion of the PCDD/F (and other species). In the ESPs, the carbon, inert material and dusts are collected and recycled to the sinter strand where the PCDD/F are cracked in the sintering zone.

Other techniques to improve the performance of the ESP are controlled by programmable logic and use of up to five fields.

Achieved environmental benefits

Experience at ArcelorMittal Ghent, Belgium of injecting activated carbon ahead of the ESP shows that a yearly average concentration of PCDD/F of 0.5 ng I-TEQ/Nm³ can be achieved under rigorously controlled conditions that ensure that strictly limited levels of grease, oil and chloride are added to the raw mix in revert materials and ESPs in optimal condition. To achieve these results, the typical dosing rate of activated coal is 80 mg/Nm³ and 200 mg/Nm³ of limestone. The necessity to add limestone and the dosing level required is dependent upon the ESP inlet gas dust loading.

Other examples for the injection of absorption additives are ArcelorMittal, Eisenhüttenstadt and Thyssen Krupp, Duisburg-Schwegern, both in Germany. At ArcelorMittal, Eisenhüttenstadt 80 mg pulverised lignite coke is injected per m³ waste gas (in total: 32 kg/h) [326, Buchwalder, J. et al 2008]. The corresponding PCDD/F concentrations were between 0.115 and 0.255 ng I-TEQ/Nm³ in 2006 taking into account the measurement uncertainty (four spot measurements under steady state conditions) [128, Sporenberg 2006]. At Thyssen Krupp, Duisburg-Schwegern, Germany zeolite and lignite coke is injected. Between January and March 2007 eight spot measurements were carried out at each of the three strands. The average PCDD/F concentration for the three strands were 0.152, 0.166 and 0.22 ng I-TEQ/Nm³.

Cross-media effects

There are few cross-media effects resulting from the injection of carbon into the waste gas main ahead of an ESP. There are no additional residues because the additional dust arising in the system can be recycled in sinter plants where coal and limestone are used during the sintering process; PCDD/F are cracked in the sintering zone. There may be additional dust to treat if fine dusts are removed from the sinter mix to improve the bed permeability, thereby reducing the possibility for PCDD/F to be produced. In plants where not all the dusts collected in the ESP are recirculated, there may be additional dust requiring treatment. There is no significant increase in energy consumption because there is no additional pressure variation in the off-gas system.

Operational data

When using carbon injection, the off-gas temperature has to be ≤ 180 °C in order to minimise the risk of fires. The residence time between the injection point and the gas cleaning device is a sensitive parameter. At ArcelorMittal, Ghent, Belgium at least three seconds residence time are required at 150 – 180 °C. The carbon content of the collected dust must be limited to avoid self-ignition as outlined in the description above. The presence of carbon in the waste gas can give rise to a positive change in the resistivity of the dust particles, enhancing the efficiency of the ESP dust collection system resulting in a lowering of the particulate emissions. However, this technique is not applicable at plant start-ups or shutdowns due to temperature considerations.

Applicability

Carbon injection ahead of an ESP is an end-of-pipe technique applicable to existing sinter plants. However a good, well-maintained gas cleaning system is required to ensure low particulate emissions (large ESPs with pulse systems).

Economics

At ArcelorMittal, Ghent, Belgium, the investment for two sinter plants with a total of 1 600 000 Nm³/h was ~EUR 2 500 000 in 2000 (steel structure, bins, dosing equipment, pneumatic transport and static mixer). The variable cost was EUR ~0.15/t sinter for activated coal, limestone and additional energy consumption in 2005.

Driving force for implementation

The main driving force for the implementation of the technique described has been stringent emission standards or other legal requirements.

Example plants

Injection of carbon into the waste gas main ahead of an ESP has been in use at ArcelorMittal, Ghent, Belgium since 2000, at Thyssen Krupp Stahl in Duisburg, Germany since 2003, at ArcelorMittal, Eisenhüttenstadt, Germany since February 2006 and at Hüttenwerke Krupp Mannesmann, Duisburg, Germany in combination with the ‘low emission and energy optimised sintering process system’ (LEEP) since December 2001.

Reference literature

[7, Bothe 1993] [45, Gebert 1995] [61, Hodges 1995] [65, InfoMil 1997] [71, Kim et al. 1998] [128, Sporenberg 2006] [145, UBA Comments 1997] [187, TÜV SÜD 2007] [209, EC 2005] [241, Poland 2007] [242, Caughlin 2007] [244, Plickert 2007] [247, Netherlands 2007] [252, France 2007] [254, Eurofer 2007] [276, Italy 2007] [277, Wiesenberger 2007] [295, Hartig et al. 2006] [308, Eurofer 2007] [326, Buchwalder, J. et al 2008]

3.3.2.2 Bag filter – combined or integrated reduction of solid and gaseous pollutants**Description**

Bag filters used in sinter plants are usually applied downstream of an existing ESP or cyclone but can also be operated as a standalone device. Usually, the removal of dust is combined with the removal of acidic waste gas compounds such as HCl, HF and SO_x by injection of slaked lime or sodium bicarbonate solutions and the removal of persistent organic pollutants such as PCDD/F, PCB, HCB or PAH by injection of adsorbents (mainly powdered lignite coke or activated carbon, and/or sometimes zeolites) (see Figure 3.15). All the dust, the carbon/coke and unreacted desulphurisation reagents as well as the reaction products (gypsum and sodium sulphate) are filtered off by means of the bag filter. A significant proportion of the removed dust is recirculated to the waste gas in order to increase the adsorption efficiency and thus reduce the costs for consumables. The rest is discharged out of the system for disposal. In some cases, the discharged dust and additives are returned to the sinter strand where the PCDD/F are cracked in the flame front. When combined desulphurisation is applied, the solid residues from the bag filter are usually not recycled to the sinter strand due to the release of the SO₂.

The several steps of this combination of techniques are as follows:

- injection of adsorbents (powdered lignite coke or active carbon and/or zeolites) upstream of the bag filter in the flue-gas duct to reduce the emissions of hazardous compounds
- injection of sodium bicarbonate or slaked lime into the flue-gas duct to reduce acidic emissions (e.g. SO_x, HCl, HF) combined with an adequate conditioning of the waste gas by moisturisation and temperature adjustment (90 – 100 °C)
- dust capture in a chemical-resistant bag filter with an automatic dust removal system (e.g. pulse-jet type)
- recycling of dust back to the flue-gas upstream of the bag filter. In some cases, a large amount of particulates is recirculated
- extraction of flue-gases from the system with a fan.

The injection of alkaline compounds, usually lime, also help to prevent the blinding of the filter material by fine particulates or organic compounds and to avoid corrosion. The lime builds up a layer on the surface of the bag (precoating the bag) preventing the formation of an impermeable layer and consequently blinding the filter material.

In the following paragraphs, more details on the techniques are provided.

For the treatment of the acidic compounds in the waste gas from sinter strands, usually a ‘semi-dry sorption process’ is used. This means that additional water is applied in order to cool the off-gas temperature to 90 – 100 °C for an efficient desulphurisation and also to avoid potential damage to the downstream fabric filter bags. The water can be sprayed directly into the waste gas flow.

In bag filter systems with dust recirculation (see Figure 3.15) there is generally a mixer for the recirculated dusts and any fresh additives (slaked lime and/or carbon). To facilitate desulphurisation of the waste gas, moisture is added to the dust in the mixer. The amount of water added is dependent upon the waste gas temperature and this can affect the degree of desulphurisation achieved. The desulphurisation rate is determined by the amount of lime added, by the rate of recirculation of the collected dusts, and by the moisture content of the recirculated dust. Desulphurisation also depends on the quality of hydrated lime.

Usually the filter is divided into several filter lines of similar design, each of which is further subdivided into several chambers. The predusted waste gas stream is distributed uniformly to the top of each of the filter lines and is sucked to the bottom of each chamber. Within the chamber, the waste gas enters from the outside of the filter tube and dust is collected on the fabric as the gas passes through the bag. The bags are supported by cages and can be mounted vertically (longer bags) or horizontally (shorter bags). During waste gas cleaning, a filter cake builds up on the exterior surface of the bag resulting in an increase in the pressure drop across the bag. Once the pressure drop reaches a set point (usual differential pressure between the filter and the clean gas chamber of 10 to 20 mbar) the chamber is taken off-line for cleaning by a reverse pulse of compressed air. The dust removed is collected in conical bins below the filter chambers and discharged by screw conveyors. About 98 % of this dust may be recycled back to the waste gas stream as an additive; the rest is discharged out of the system for disposal or optionally sent back to the sinter strand.

An example of the combined reduction of solid and gaseous pollutants by bag filter is the MEROS[®] process (Maximised Emission Reduction of Sintering). The full size installation has been in operation on a sinter machine of 222 m² at Voestalpine Stahl GmbH, Linz, Austria since August 2007 and replaced the AIRFINE system.

Other examples for the combined reduction of solid and gaseous pollutants by bag filter are the TFA process (Treatment des Fumes d’Agglomération) at ArcelorMittal, Fos sur Mer, France or the EFA sintering technology which is applied at Rogesa, Dillingen, Germany. Whereas the

TFA process at Fos sur Mer has been in operation since 2006, the EFA process at the sinter plant No 2 in Dillingen is in the trial operation phase.

Figure 3.15 shows a basic flow sheet of a bag filter applied downstream of an ESP or a cyclone.

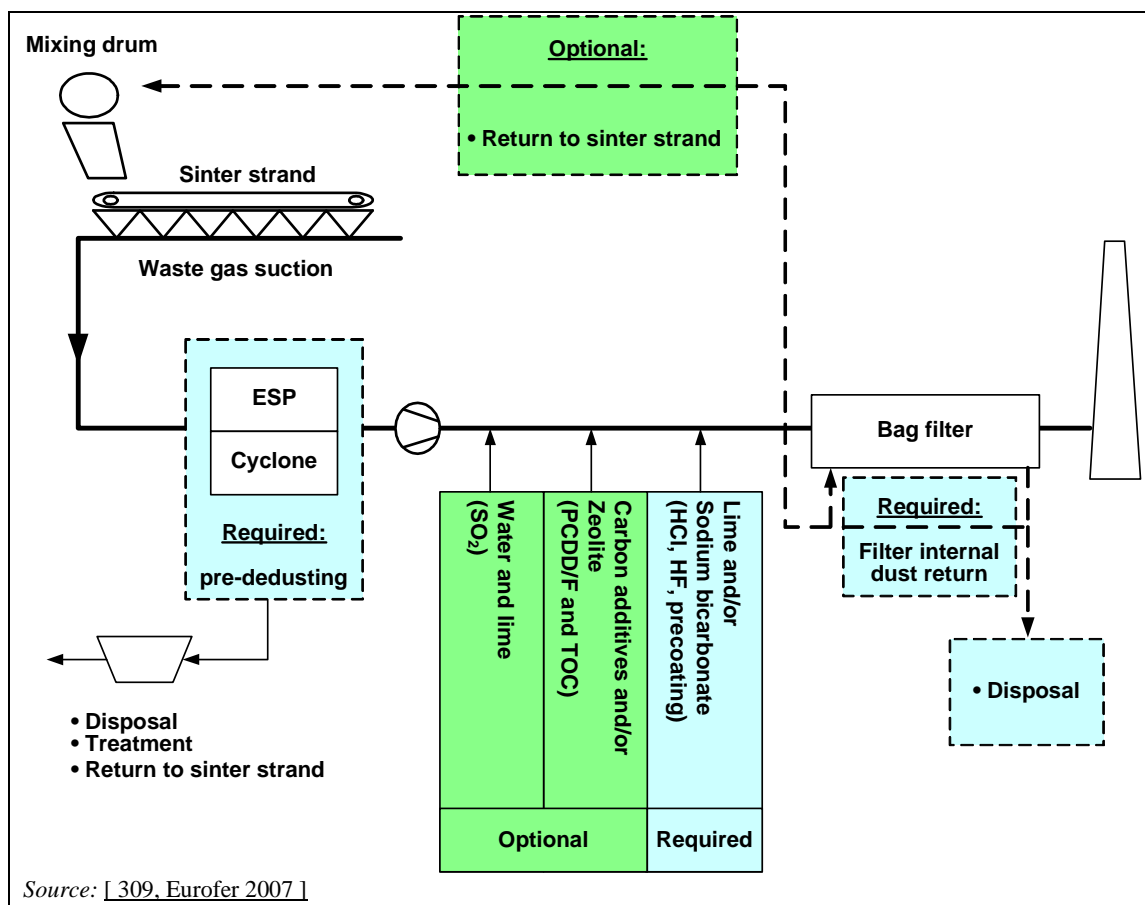

Figure 3.15: Basic flow sheet of a bag filter downstream of an existing ESP or cyclone

Figure 3.16 shows a typical flow scheme of a sinter plant with a SIMETAL MEROS[®] system added.

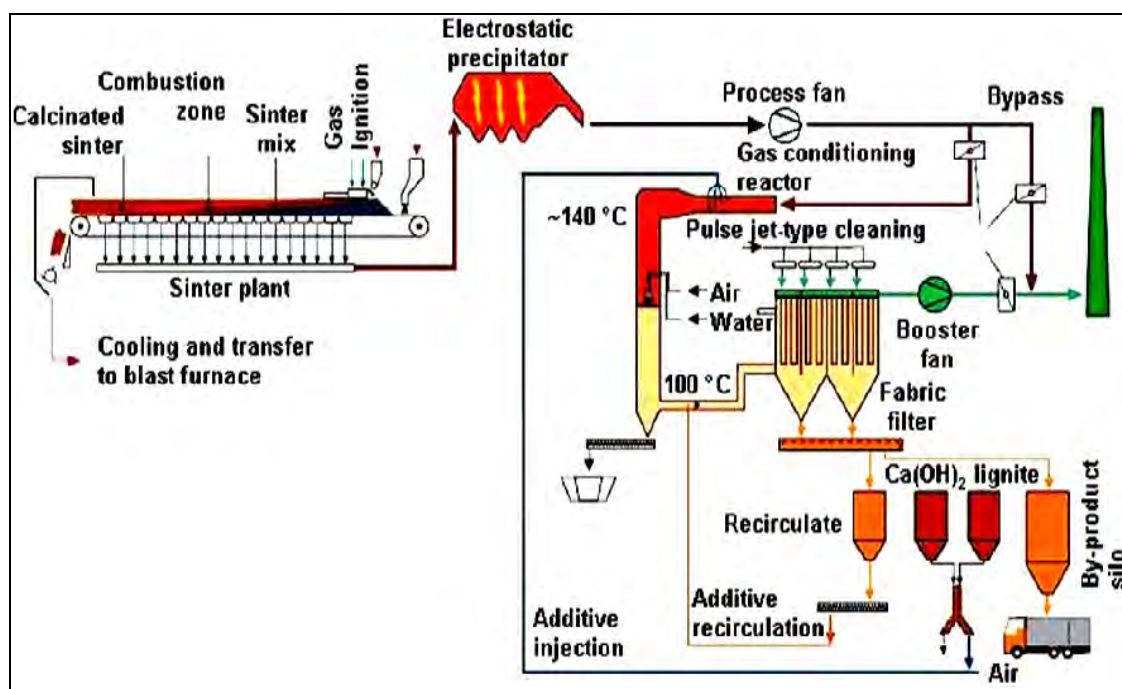

Figure 3.16: Flow scheme of a sinter plant with a SIMETAL MEROS[®] system added

Although this technique is different in process layout, the processes mentioned above have in common that the conventional use of additives like activated carbon or activated lignite coke for heavy metals and PCDD/F removal is accompanied by dust recycling and SO_x abatement in case of additional lime and water injection [127, Dr. Fleischanderl, Alexander 2006].

The abated dust consists of primary dust, carbon/coke and non-reacted deSO_x reagents. To reduce additive costs, most of the dust separated in the bag filter is recycled to the gas stream allowing these non-reacted additives to come once again into contact with the off-gas and thereby decreasing the costs of the additives.

Another advantage is that the highly recirculated dust concentration (between 1 and up to 1000 g/Nm³ depending on the technique) leads to a rapid collection of dust on the bag filter, which promotes the further removal of heavy metals and PCDD/F. SO_x is reduced by hydrated lime for all mentioned techniques, although sodium bicarbonate can also be applied.

Achieved environmental benefits

A bag filter is highly efficient at reducing dust and simultaneous heavy metals emissions in a waste gas stream. Bag filters enhanced with additives also reduce the emissions of PCDD/F, hydrochloric acid (HCl), hydrofluoric acid (HF) and to a lesser extent, sulphur dioxide (SO₂). In particular, emissions of PCDD/F may be reduced significantly. A significant removal of VOCs and PAH is also reported.

Operational data for European sinter plants using bag filters are usually in the range of 1 to 10 mg/Nm³ particulates expressed on a daily average basis that includes peak periods. The non-volatile heavy metals are reduced simultaneously with the dust.

The addition of lime and carbon enables the reduction of dioxin emissions to <0.1 ng I-TEQ/Nm³.

Volatile heavy metals and VOCs are reduced simultaneously by the application of additives and zeolites which contain carbon. For example, mercury is reduced by 80 – 95 %.

SO₂ can be reduced by approximately 30 – 80 % with slaked lime and up to 90 % with sodium bicarbonate. This leads to SO₂ emissions of between 100 and 500 mg/Nm³ depending on the

amount of lime or sodium bicarbonate that is injected. Depending on the SO₂ input in practice, daily averages for SO_x of lower than 350 mg/Nm³ have been achieved.

With lime addition, HF emissions concentrations of 0.2 – 1 mg/Nm³ and HCl emissions concentrations of 1 – 10 mg/Nm³ (daily average) can be achieved.

The achieved environmental levels reported for clean gas from bag filter systems are given in Table 3.17.

Table 3.17: Performance of three sinter strand plants with bag filter systems

Parameter	Input (raw gas)	Outputs ⁽¹⁾	Units
Dust	80 – <500	0.73 – 15	mg/Nm ³
SO ₂	450 – <800	225 – <500 ⁽²⁾	mg/Nm ³
HCl	<60	0.31 – 30 ⁽³⁾	mg/Nm ³
HF		0.34 – 1 ⁽³⁾	mg/Nm ³
PCDD/F		<0.1	ng/Nm ³
Pb		0.17	mg/Nm ³
Sum of Hg, Tl, Cd		0.007	mg/Nm ³
Temperature	145	100	°C
⁽¹⁾ Some values are guaranteed performances. ⁽²⁾ SO ₂ removal strongly depends on particulate recirculation in the filter system and on the water addition. Values achieved by injection of lime/activated coke. ⁽³⁾ Lower end of the range is achieved by lime injection. <i>Source:</i> [190, Eurofer 2010] [194, Leroy et al 2007] [211, Remus, Rainer 2008] [287, MVAE 2005] [296, Leroy et al. 2007] [244, Plickert 2007].			

Table 3.18 shows examples of achieved emission concentration values for sinter strand emissions after dedusting with a combination of an ESP and a bag filter including statistical information and the corresponding reference time periods.

Table 3.18: Achieved emission concentration values for sinter strand dedusting in five EU sinter plants

Parameter	Emission level	Percentile		Unit	Reference time period
		5 %	95 %		
Dust	0.73 – 15			mg/Nm ³	DAV
	0.9 ⁽¹⁾	0.8	1.4		DAV
CO	21 000			mg/Nm ³	AAV
NO _x	48 – 290			mg/Nm ³	DAV
	240 ⁽¹⁾	230	260		DAV
SO _x	495			mg/Nm ³	NA
	455	399	498		DAV
	263 ⁽¹⁾				DAV
HF	0.34			mg/Nm ³	AAV
	0.2 ⁽¹⁾				DAV
HCl			3	mg/Nm ³	HHAV
	0.31 – 3				NA
	2 ⁽¹⁾	<1	2.4		HHAV
Cd	0.0003			mg/Nm ³	AAV
	0.013				AAV
	<0.002 ⁽¹⁾				HHAV
As	<0.001			mg/Nm ³	AAV
As, Ni Ni	0.0006			mg/Nm ³	AAV
	<0.002 ⁽¹⁾				HHAV
Hg	0.01 – 0.075 (¹) (²)			mg/Nm ³	DAV/ HHAV
Cr V	<0.002 ⁽¹⁾			mg/Nm ³	HHAV
	0.007 ⁽¹⁾				HHAV
Pb	<0.001			mg/Nm ³	AAV
	<0.002 ⁽¹⁾				AAV
Pb, Cr, Cu, Mn	0.05			mg/Nm ³	AAV
NMVOC	47 – 50			mg/Nm ³	AAV
	30 ⁽¹⁾	22	33		HHAV
CH ₄	18.5 ⁽¹⁾	15	21	mg/Nm ³	HHAV
PCDD/F	0.08 – 0.18			ng/Nm ³	AAV
	0.05 ⁽¹⁾	0.044	0.057		8 HAV
BaP	0.1 ⁽¹⁾			µg/Nm ³	8 HAV

(¹) Performance data from a sinter strand using the MEROS technique (full size installation).
(²) Depending on the mercury content in the domestic ores, the values can reach as high as 0.075.
NB: — NA = Not available.
— AAV = Annual average value.
— DAV = Daily average value.
— HHAV = Half-hourly average value.
— 8 HAV = Average value every eight hours.

Source: [190, Eurofer 2010] [193, Voestalpine Linz 2010] [244, Plickert 2007] [382, Linz 2008].

Figure 3.17 shows the daily average values for dust from one sinter strand equipped with a bag filter technique for over 23 months (January 2008 to October 2009).

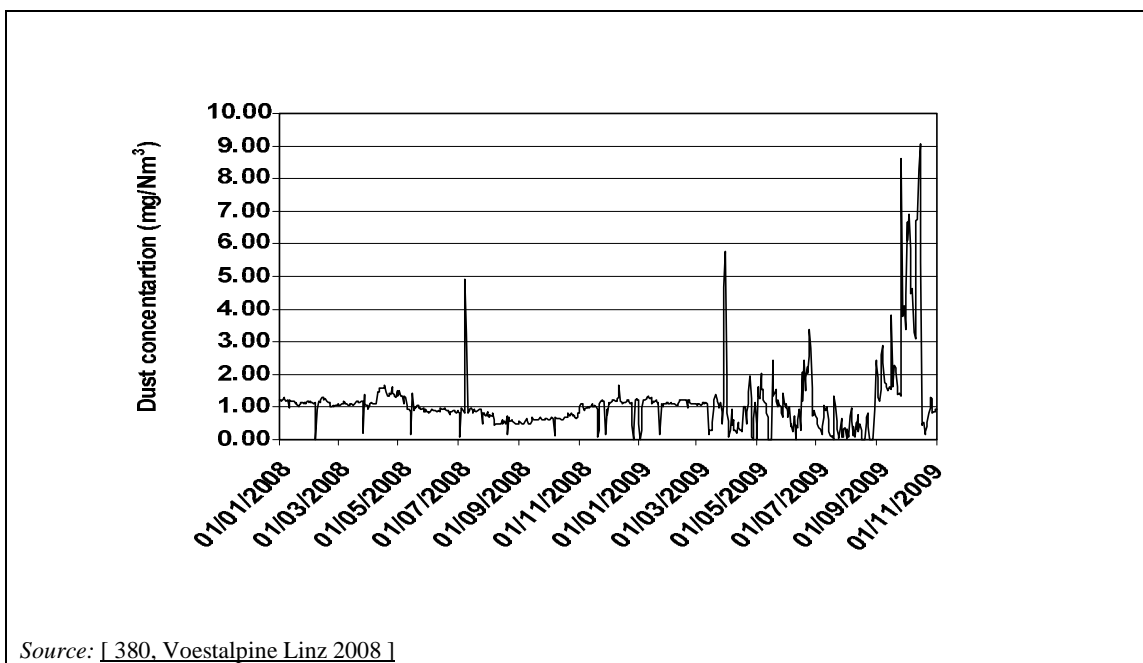

Figure 3.17: Daily means for the dust emissions from one sinter strand equipped with a bag filter technique from January 2008 to October 2009

Applying bag filters facilitates increasing the recycling of dioxin and heavy metal-containing residues. In one example the amount of recycled dust from the blast furnace gas has been increased from 6000 tonnes to 39000 tonnes per year [183, Weiss 1998].

Cross-media effects

Bag filters generate a solid process residue flow (0.5 to 1 kg/t sinter), which is preferably recycled into the sintering process. In some cases, the captured dust contains unwanted compounds (e.g. zinc, lead, alkalis), hampering its reuse. In this case, some or the entire solid process residues should be discarded as waste for further treatment or disposal.

At the sinter plant of ArcelorMittal Bremen in Germany that operates without desulphurisation, the separated dust and additives from the bag filter are fully returned to the sinter strand where the PCDD/F are cracked in the flame front. The separated dust at Voestalpine Stahl GmbH, Donawitz, Austria must be disposed of because it contains significant amounts of sulphur, chloride, fluoride and alkalis. The dust separated in the ESP (only used as a predestining device) is recycled or disposed of depending on the alkali chloride content, which can increase the residual dust content in the treated waste gas when returned to the sinter strand.

The use of a bag filter requires the installation of new booster fans. The additional electricity energy demand including fans, heating devices, motors and auxiliary installations is approximately 1.5 kWh/1000 Nm³/h compared to 1.0 kWh/1000 Nm³/h with an ESP only.

Operational data

The recirculation of particulates inside the system to build up a precoating layer at the surface of the bags is used to improve the dedusting efficiency and to increase the lifetime of bags.

Durable bag filter material is an important aspect of this technique. Different types of filter fabric material with specific qualities can be used to achieve a balance between abatement efficiency, lifetime and costs (see Table 3.22).

The use of activated carbon or lignite coke differs in grain size and in the effective adsorption surface area and consequently the amount of injection required. Activated coal has the highest specific free surface and shows a very good adsorptive effect. Activated lignite coke is the more economic alternative to activated coke and the super-milled lignite coke with diameters of 0.024

mm also shows a very good adsorptive efficiency and leads to half the dosing rates necessary compared to the application of standard lignite coke [367, Prüm et al. 2005]. Sometime inerts have to be added to the injected carbon-based materials to prevent ignition. Table 3.19 shows the characteristics of different adsorbents and absorbent materials.

Table 3.19: Characteristics of different adsorbent and absorption materials

Adsorption and absorption materials		Grain size (mm)	Surface area BET ⁽¹⁾ (m ² /g)	Precipitative pollutants
Lime	CaO	12	1 – 3	HCl, HF, SO ₂
Slaked lime	Ca (OH) ₂	<8	15 – 45	
Sodium bicarbonate	NaHCO ₃		NA	
Standard powdered activated lignite coke	Carbon	0.063	300 – 400	Organics, heavy metals
Super-milled powdered activated lignite coke	Carbon	0.024	1200	
Powdered activated (charcoal) carbon	Carbon		500 – 1600	
Zeolite	Z		4 – 90	

⁽¹⁾ BET – Created from the initials of the family names of the people who developed this theory as a rule for the physical adsorption of gas molecules on a solid surface.
 NB: NA = Not available.
 Source: [59, Nethe 2005].

To achieve effective adsorption of the PCDD/F, it is necessary to ensure that the carbon additive is distributed rapidly across the duct section. After injection, the absorption and adsorption process starts in the ducts and continues in the filter cake. The carbon additives together with the dust are captured in the bag filter and are removed from the filter in the usual way. A significant proportion of the dust and additives is returned to the waste gas stream; the rest is discharged out of the system for disposal. In some cases, the discharged dust and additives are fully returned into the sinter strand where the PCDD/F are cracked in the flame front.

Table 3.20 shows a comparison between the use of sodium bicarbonate and slaked lime.

Table 3.20: Typical operational values when using sodium bicarbonate and slaked lime as additives

Parameter	Sodium bicarbonate	Slaked lime
Stoichiometric coefficient	1.1 – 1.4	2 – 4
Residuals ⁽¹⁾	60 – 70 %	100 %
Reactant cost ⁽¹⁾	140 – 210 %	100 %
DeNO _x (if required)	Less fuel for gas heating	More fuel for gas heating
Gas temperature at the outlet	Same as inlet	90 – 100 °C

⁽¹⁾ Relative values refer to the amount when slaked lime is used.
 Source: [277, Wiesenberger 2007] [294, Fleischanderl 2006].

By injection of water, the temperature of the waste gas is reduced and the abatement efficiency of acid pollutants is increased. Modern bag filter techniques have systems which decrease the flue-gas temperature to 120 °C or even down to 80 °C either directly or by spraying water into the reactor chamber or indirectly by conditioning the recirculated particles with water. Freshly ground sodium bicarbonate is injected into the flue-gas duct at a temperature above 140 °C. The use of slaked lime needs more energy to reheat the gas.

There is flexibility with the use of additives (e.g. slaked lime, lignite coke, sodium bicarbonate) depending on the environmental needs. Sodium bicarbonate is used when higher desulphurisation or a deNO_x system is required. Additives are stored in silos and sodium bicarbonate is milled before injection.

In order to enhance the gas cleaning efficiency and to significantly reduce additive costs, most of the separated dust in the bag filter is recycled to the off-gas stream after the conditioning reactor. Unreacted adsorbents once again come into contact with the off-gas, thus increasing the adsorbent efficiency and reducing the costs of consumables. The reaction products and the dust are usually deposited underground due to their fine grain sizes.

If carbon is used to achieve further reductions of PCDD/F emissions, then special attention has to be paid to the risk of filter fire. Spark detection equipment may be installed and when necessary, the filter is bypassed. Filters usually get bypassed during the start/shut down of the sinter strand.

Bag filters are divided into lines and subdivided into different chambers. When a bag filter element is broken, only the corresponding chamber has to be shut down in order to replace this filter element.

Applicability

The bag filter can be regarded as an end-of-pipe technique which can be applied at both new and existing plants. For existing plants requirements such as space for a downstream installation to the ESP can be relevant. Special regard should be given to the age and the performance of the existing ESP.

Economics

When estimating the costs of bag filter with a flow-injection unit, it should be borne in mind that these installations are not only used for dust separation but also for reducing PCDD/F, heavy metals and acid gases such as HF, HCl and SO₂. The investment is in the range of EUR 16 to 35/Nm³/h (for new and existing plants).

Decisive cost factors are pressure drop, the waste gas flow, fabric material and filter loading. The operating cost is around EUR 0.3 – 0.6/t sinter and mostly depends on the costs of supplying activated carbon and limestone, and the extra energy. Examples of costs are shown in Table 3.21.

Driving force for implementation

Sinter plants are the major source for dust and dioxin/furan emissions from integrated steelworks. The driving force for implementation is to meet the prescribed emission limit values for dust, heavy metals and PCDD/F, to lower national emissions to meet the national reduction goals according to national and international regulations, environmental reputation and in the case of the plant at Voestalpine Stahl GmbH, Linz, Austria improved economics compared to the AIRFINE system.

According to the Basel Convention and the corresponding Regulation (EC) 850/2004 regarding the treatment of POP-containing waste materials, amended by Regulation (EC) 304/09/EC, transboundary shipments of wastes like iron-bearing filter dust or sludges for recycling purposes are only permissible if the receiving facility complies with an ELV for PCDD/F of 0.1 ng I-TEQ/m³.

Table 3.21: Examples of the cost of bag filters installed in sinter plants

Sinter plant	Economic characteristics	Cost (EUR)	Comments
ArcelorMittal Bremen, Germany	Investment costs	EUR 6.5 million in 1992 (EUR 3.6/t sinter in 1992) EUR 16.25/Nm ³ /h	Additional carbon injection; waste gas volume: 0.4 million Nm ³ /h
Voestalpine Stahl GmbH, Donawitz, Austria	Investment costs	Total EUR 9.3 million in 2002 (= EUR 6/t sinter in 2002). Bag filter EUR 6.5 million (= EUR 4.17/t sinter) EUR 29/Nm ³ /h in 2002	Bag filter after ESP; waste gas volume: 0.32 million Nm ³ /h in 2008
	Operational costs, e.g.: <ul style="list-style-type: none"> • waste disposal • energy demand • depreciation costs 	1.6 – 1.8 EUR/t sinter in 2008 0.5 – 0.7 EUR/t sinter in 2008 0.4 EUR/t sinter in 2008 0.3 EUR/t sinter in 2008	
ArcelorMittal, Fos sur Mer, France	Investment costs	Total EUR 16 million (= EUR 2.4/t sinter considering the total production; EUR 4.8/t sinter considering the size of the installation = 50 % of the flow) EUR 21/Nm ³ /h All data are from 2005	The project has three parallel bag houses. Waste gas volume: 1.4 million Nm ³ /h. However, only 50 % of the waste gas is treated by a bag filter (700 000 Nm ³ /h)
Rogesa, Dillingen, Germany (Sinter off-gas cleaning system EFA at sinter plant No 2 in Dillingen is still in the trial operation phase)	Investment costs	Around EUR 22 million 20/Nm ³ /h Data are from 2006 and do not cover some of the necessary subsequent costs for modifications and optimisations	Bag filter with recirculation injection of lime and activated lignite coke; waste gas volume: 0.6 million Nm ³ /h
NB: In EU countries, disposal of filter dusts from sintering can introduce significant additional costs. Source: [200, Commission 2001] [249, Netherlands 2007] [252, France 2007] [260, Germany 2007] [277, Wiesenberger 2007] [296, Leroy et al. 2007] [309, Eurofer 2007].			

Sinter off-gas cleaning system EFA at sinter plant No 2 in Dillingen is still in the trial operation phase

Example plants

Bag filters have been applied to the sinter process for the dedusting of waste gas since the beginning of the 1990s. In Europe, the number of sinter plants treating the waste gases with bag filters has increased since the year 2002 and now include the following:

- ArcelorMittal, Bremen, Germany since 1992
- DK Recycling, Duisburg, Germany
- Voestalpine Stahl GmbH, Donawitz, Austria. This sinter off-gas cleaning plant has been in operation since 2002 with a capacity of 400000 Nm³/h
- Voestalpine Stahl GmbH, Linz, Austria. The MEROS full size installation has been in operation since August 2007 and replaced the AIRFINE system
- ArcelorMittal, Fos sur Mer, France. Industrial operation has been ongoing since 2006. Sinter production is at 21000 t/day. Bag filter system is equipped with slaked lime as the adsorbent at a capacity of 700000 m³/h sinter off-gas (50 % of the total sinter off-gas)
- Rogesa, Dillingen, Germany. A sinter off-gas cleaning system with a capacity of 600000 Nm³/h with bag filter downstream to an ESP has been in trial operation since 2009. The system also injects hydrated lime and activated lignite coke before the bag

filter. For the second sinter strand, another plant has been commissioned for a capacity of 900000 Nm³/h.

In the US, at least three sinter plants treat the off-gases from sinter strands in bag filters:

- Inland Steel, East Chicago, US.
- Warren Consolidated Industries (WCI), Youngstown Sinter Company, Warren, Ohio, US.
- US Steel, Gary Works, Gary, Indiana, US.

For the following three sinter plants, the installation of bag filters is scheduled or commissioned:

- Thyssen Krupp Stahl, Duisburg, Germany announced to retrofit all three sinter plants with bag filters after the existing ESPs by 2011
- Salzgitter AG, Salzgitter, Germany. A sinter off-gas cleaning system with a capacity of 680000 Nm³/h with bag filter downstream to an ESP has been commissioned. The plant is scheduled to go into full operation in March 2010
- At Corus, IJmuiden, the Netherlands, trials with bag filters will be put through in 2009. Depending on the results, one of three sinter strands will be equipped with a full scale bag filter in 2010 and the other two sinter strands will be retrofitted with bag filters in 2013.

Reference literature

[217, Siemens-vai 2006] [294, Fleischanderl 2006] [295, Hartig et al. 2006] [298, Fleischanderl 2006] [244, Plickert 2007] [252, France 2007] [277, Wiesenberger 2007] [382, Linz 2008]

Table 3.22: Operational data and economics of bag filters at sinter plants

		Unit	ArcelorMittal, Bremen, Germany	Voestalpine, Donawitz, Austria	Voestalpine, Linz, Austria	DK Recycling Duisburg, Germany ⁽¹⁾	ArcelorMittal Fos sur Mer, France
Sinter capacity	Design	t sinter/h		NA			21 000 t/d
	Actual		325	177		59	
Waste gas flow	Design	1 x10 ⁶ Nm ³ /h	0.58	NA			
	Actual		0.49	0.32		0.28	
Prededusting			Dry ESP (two fields)	Dry ESP (three fields)		Prededusting by ESP, injection of hydrated lime and lignite coke, bag filter	
Dust	Inlet	mg/Nm ³	Approx. 211 – 267	150 – 250			80
	Outlet	mg/Nm ³	1 – 15	<3	<2	<0.5	<10
	Efficiency	%	>98.5	>98.5			
Dioxin removal	Inlet	ng I-TEQ/Nm ³	0.64 – 0.91	Approx. 0.4			
	Outlet	ng I-TEQ/Nm ³	0.07 – 0.11	<0.1	<0.05	0.23	<0.1
	Efficiency	%	90	>90			
HCl removal	Inlet	mg/Nm ³		Max. 100			
	Outlet	mg/Nm ³	2.6 – 3.6	10	<1	<0.4 – 1.4	
	Efficiency	%		Approx. 90			
HF removal	Inlet	mg/Nm ³		7.4			
	Outlet	mg/Nm ³	0.57 – 0.60	<0.2	<0.2	<0.40	
	Efficiency	%		Approx. 95			
SO ₂ removal	Inlet	mg/Nm ³		700			450
	Outlet	mg/Nm ³	500	380	263	399.8	<225
	Efficiency	%		45			

		Unit	ArcelorMittal, Bremen, Germany	Voestalpine, Donawitz, Austria	Voestalpine, Linz, Austria	DK Recycling Duisburg, Germany ⁽¹⁾	ArcelorMittal Fos sur Mer, France
Heavy metal removal	Efficiency	mg/Nm ³	After ESP: Al: 0.2 As: 0.009 Cd: 0.076 Cr: 0.01 Cu: 0.93 Hg: 0.013 Ni: 0.01 Pb: 13.4 Zn: 0.41	After bag filter: Al: 0.04 As: 0.0003 Cd: 0.001 Cr: 0.003 Cu: 0.003 Hg: 0.0013 Ni: 0.006 Pb: 0.02 Zn: 0.12	NA	Cd: <0.002 Ni: <0.002 Pb: <0.002	Cd: <0.001 Ni: <0.002 Pb, Cr, Cu, Mn: <0.02 – <0.05
Additives		mg/Nm ³	Slaked lime (Ca(OH) ₂): approximately 450 Lignite coke powder: approximately 100	Ca(OH) ₂ approximately 1500 Activated lignite coke approximately 100		Ca(OH) ₂ Lignite coke	Active carbon
Waste product	Generation	kg/t sinter	Approx. 1	Approx. 2.5		9.7	
	Reuse		Recycled to sinter plant	NA		partly	
Type of fabric			Nomex [®] , Rastex [®]	Nomex [®]		PTFE	Aramid
Type of cleaning			Pulse jet	Pulse jet		Pulsed air	
Pressure drop		mm water column	150	Approx. 150		170	
Investments ⁽²⁾		EUR × 10 ⁶	Bag filter: 7.3 (in 1993) Additive dosage device: 1.1	Bag filter: 6.5 (in 2002) Total system: 9.3		10.5	
Operational costs ²		EUR/t sinter	Energy: 0.11 (in 1996) Other: strongly dependent on type and operation time of the bag filter	1.6 – 1.8 (see Table 3.22)		3.32	
⁽¹⁾ Data for 2008. ⁽²⁾ For all examples, the currency was converted into ECU in 1996 and for the review into EUR. NB: NA = Not available. Source: [65, InfoMil 1997] [99, DK Recycling 2009] [107, N.N. 2009] [164, Weiss 1996] [211, Remus, Rainer 2008] [244, Plickert 2007] [309, Eurofer 2007] [342, GWAA Bremen 2005] [382, Linz 2008].							

3.3.2.3 Cyclones

Description

Cyclones are only pretreatment devices, or used as shelter for vulnerable downstream equipment (e.g. for spark separation), but in Europe they are never used as standalone abatement techniques in the sinter process. Cyclones separate out dust by centrifugal action. As they rely on inertia, cyclones are only efficient abatement devices when the dust is relatively coarse. A multicyclone applies the same principle by means of a parallel series of cyclones, thus obtaining greater efficiency. Cyclones are sometimes used in sinter plants as an intermediate gas cleaning device in order to protect equipment (e.g. ducts and fans) from the abrasive effect of the dust present in the waste gas.

Achieved environmental benefits

For particles $>10\ \mu\text{m}$, a removal efficiency of 90 – 95 % achieved by the use of a multicyclone was reported. However, because of the relatively small size of dust in the sinter plant waste gas, 60 to 80 % removal efficiency is assumed here. Thus, outlet concentrations from sinter plants are between 300 and 600 mg/Nm^3 , depending on the inlet concentration and the particle size distribution.

Cross-media effects

A slight pressure drop (0.5 kPa) increases the energy consumption of the waste gas suction pumps by approximately 200 kW for a sinter plant with a waste gas flow of 1 million Nm^3/h and a production of 4 million tonnes sinter per year. This amounts to 1 MJ/t sinter, or less than 0.1 % of the energy consumption of the sinter plant. Furthermore, a solid waste flow is generated, which is fully returned to the sinter process.

Operational data

Cyclones operate smoothly under abrasive and moist conditions, reducing dust concentrations at sinter plants with an efficiency of approximately 60 to 80 %, depending on the specific weight of the dust. At Corus, IJmuiden, the Netherlands an outlet concentration of 300 mg/Nm^3 was achieved with a multicyclone.

Applicability

Cyclones can be applied at both new and existing plants.

Economics

Investments were estimated to be EUR 500 to 750 per 1000 Nm^3/h . For a sinter plant with a waste gas flow of 1 million Nm^3/h , this amounted to EUR 0.5 million to 0.75 million. Operational costs depend on the pressure drop and thus the energy costs. A figure of EUR 0.007 to 0.015 per 1000 Nm^3 treated was mentioned. For the sinter plant mentioned above, this amounted to EUR 60000 to 127000 per year, corresponding to EUR 0.02 to 0.04/t sinter. For all examples, the currency was converted into ECU in 1996 and for the review into EUR.

Driving force for implementation

No data submitted.

Example plants

Many sinter plants worldwide use cyclones as a coarse dust abatement device. For example: Corus, IJmuiden, the Netherlands; Wakamatsu/Yawata Works, Japan.

Reference literature

[65, InfoMil 1997] [310, Eurofer 2007]

3.3.2.4 Fine wet scrubbers

Description

In a scrubber, the dust in the waste gas is abated by using a liquid. The contaminated liquid is removed from the system and it is usually recycled after treatment. The solid matter retained in sludge also undergoes further treatment.

Traditional scrubbers (e.g. venturi scrubbers, spray column scrubbers) are ineffective when applied to sinter plant waste gases due to the relatively fine sizing of the dust and the high concentration of hydrocarbons. Traditional scrubbers are not applied at sinter plants in Europe.

A high performance scrubber has been in operation in Europe since 1993 (manufactured under the name AIRFINE).

The main components of the gas cleaning system include:

- a cyclone or an electrostatic precipitator (ESP) for the removal of coarse dust all of which can be returned to the sinter strand
- a quenching scrubber for waste gas cooling, removal of coarse dust particles and removal of acid components by means of NaOH addition
- a fine scrubber system for fine dust separation and simultaneous gas cleaning
- a water treatment facility for residue/waste processing.

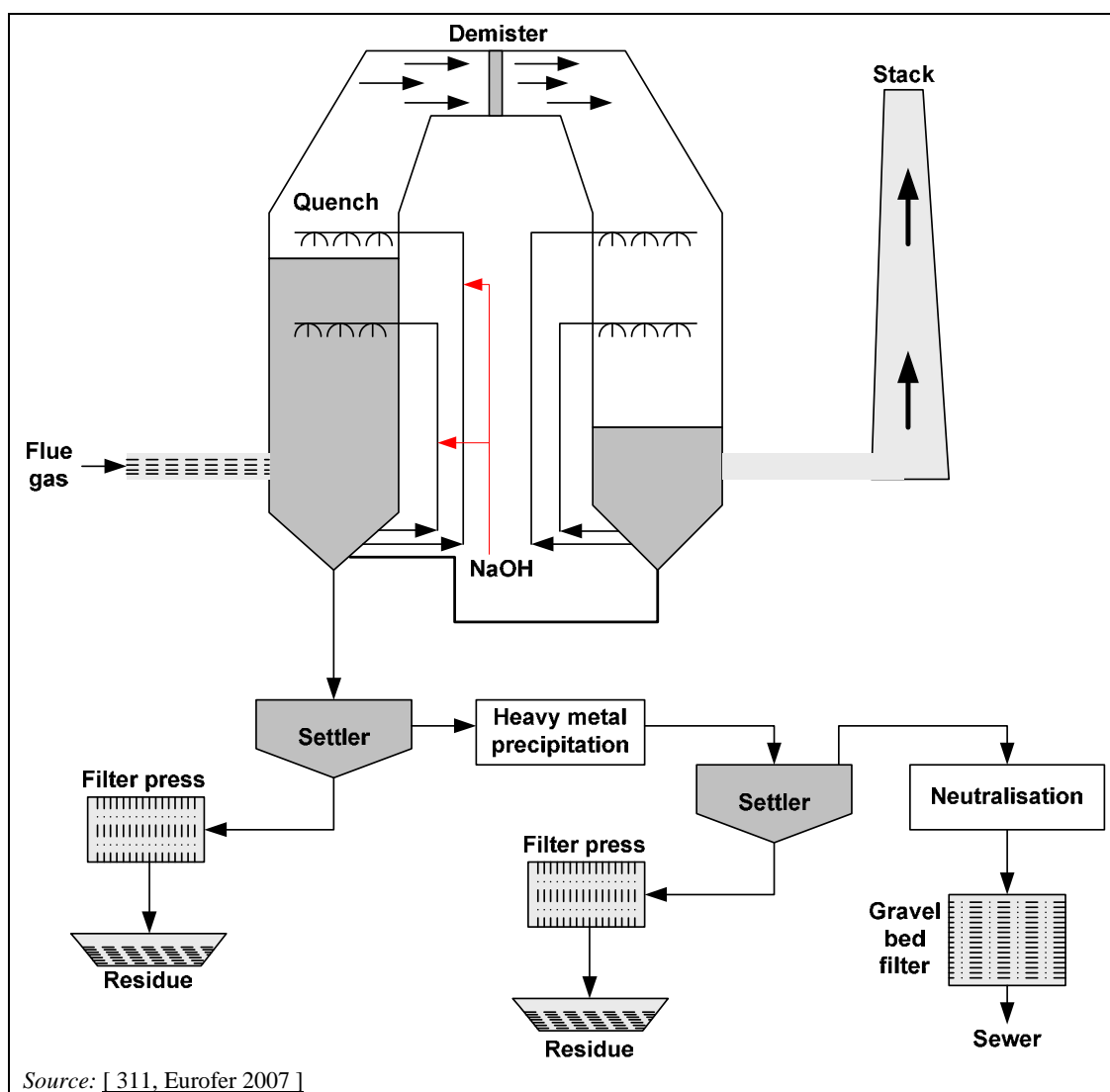

Figure 3.18: Treatment of the waste gas from the sinter plant using the AIRFINE system

In the quench operation, water dosed with NaOH is sprayed across the surface of the scrubber. In the fine scrubber system, dual flow nozzles jet water and compressed air as a high-pressurised mist into the cooled waste gas stream.

The AIRFINE scrubber allows for the simultaneous removal of the finest dust particles (including alkali and heavy metal chlorides – see Section 3.2.2.1.2.1) and other noxious components of the waste gas. The latter (e.g. PCDD/F, heavy metals) are mainly associated with fine dust. Compared with dry abatement techniques, this technique can also remove water-soluble compounds, such as alkali chlorides (see Section 3.2.2.1.2.1) and heavy metal chlorides (see Section 3.2.2.1.2.2). When alkalines such as NaOH are added to the scrubbing water, significant removal of acidic components like HF, HCl and SO₂ can be achieved. Consequently, the aqueous solution which contains alkali and heavy metal salts is treated by precipitation/flocculation. At Corus, IJmuiden, the Netherlands, the solids were being returned to the sinter plant until 2008. Since 2008, most of the solids have been disposed of in a secured landfill. The overflow is neutralised and passed through several gravel beds before being discharged.

Achieved environmental benefits

Operational data for European sinter plants using wet scrubbers are in the range of 40 to 80 mg/Nm³ expressed as annual averages. Depending on the condition of the unit, dust emission levels lower than this can be achieved on an instantaneous basis. Table 3.23 presents actual operational performance data expressed on an annual average basis for the system at Corus, IJmuiden, the Netherlands using the AIRFINE system.

Table 3.23: Achieved air emission parameters at Corus, IJmuiden, the Netherlands using the AIRFINE system

Component	Emissions concentrations (mg/Nm ³) ⁽¹⁾
dust	32.3 ⁽²⁾
As	0.0003
Cd	0.09
Cr	0.025
Cu	0.032
Hg	0.0156
Ni	0.0065
Pb	3.75
Zn	0.64
HCl	0.48
HF	0.27
SO ₂	170
VOC	50
PCDD/F	0.18 ng I-TEQ/Nm ³
⁽¹⁾ These emission data correspond to an installation where the solids from the waste gas treatment are returned to the sinter feed. ⁽²⁾ This figure is lower than the range in the text because it is for the AIRFINE scrubber alone. The figure in the text above the table refers to the total operation of the sinter plant (when the AIRFINE scrubber is operated for 95 % of the time). All measurements are continuously monitored. Source: [200, Commission 2001] [247, Netherlands 2007] [311, Eurofer 2007].	

The technique is also efficient at removing PCDD/F. Under normal operating conditions, 0.4 ng I-TEQ/Nm³ is guaranteed, 0.18 ng I-TEQ/Nm³ is achievable, corresponding to >90 % efficiency for an inlet concentration of 2.5 – 3.0 ng I-TEQ/Nm³. This technique is able to reduce the emissions of organic pollutants such as PCDD/F because of the efficient removal of fine dust (at the temperatures of operation, dioxin-like compounds are condensed onto the dust).

No additives (activated carbon) are included to achieve this value. Furthermore, 80 to 95 % of HCl and HF are removed. SO₂ emissions can be removed with high efficiency if a facility with an injection of additives is installed (see Section 3.3.2.7.2). Heavy metal concentrations are also reduced efficiently (>90 %) as a result of their water solubility. Non-polar pollutants such as PAH are also reduced because of the efficient removal of fine dust.

Cross-media effects

At Corus IJmuiden, the solids were being returned to the sinter plant until 2008. From 2008, the solids have been disposed of in a secure landfill.

Lead salts in the waste gas have a negative effect on the performance of wet scrubbers (especially at the fine scrubber part). This is typically avoided by maintenance procedures.

At Corus, IJmuiden, the Netherlands, the flow of cooling water is 800 m³/h and of waste water 50 m³/h. This contaminated waste water flow must be treated.

The waste water emissions concentrations and emissions factors achieved by a fine scrubber and a dust prefilter (ESP) and after treatment (precipitation/flocculation) at Corus, IJmuiden, the Netherlands are given in

Table 3.24 (for data from 2007, see Table 5.22).

Table 3.24: Achieved emissions concentrations and emissions factors of the treated waste water from waste gas scrubbing and ESP filter dust extraction at Corus, IJmuiden the Netherlands in 2004

Component	Concentration (mg/l)
Treated waste water flow	50 m ³ /h ⁽¹⁾
pH	9 – 12
Suspended solids	30
As	0.002 – 0.005
Cd	0.005 – 0.01
Cr	0.02 – 0.05
Cu	0.05 – 0.1
Hg	0.0001 – 0.0002
Ni	0.05 – 0.1
Pb	0.2 – 0.5
Zn	0.05 – 0.1
COD	250 – 350
Kjeldahl-N	250 – 350
⁽¹⁾ Annual average. NB: Data from 2004. Source: [200, Commission 2001] [311, Eurofer 2007].	

The waste water gets further treated in a biological treatment plant (see Table 5.25, Figure 5.23 and Figure 5.24)

Operational data

The actual removal efficiency is related to the energy input (compressed air for atomisation) and the operating efficiency of the quench part.

Table 3.25 gives the data on electricity consumption and coarse dust separation.

Table 3.25: Operational data for the Corus IJmuiden plant

Parameter	Corus, IJmuiden (2005)	Units
Electricity consumption	43	MJ/t
	12	kWh _e /t
Course dust separation ⁽¹⁾	250 – 350 (by cyclones)	mg/Nm ³
⁽¹⁾ Values achieved at the outlet of the course dust separation and before the scrubbers. <i>Source:</i> [200, Commission 2001] [311, Eurofer 2007].		

At the sinter plant of Corus, IJmuiden, the Netherlands, emissions reductions are achieved with the installed high-pressure wet scrubber. For instance, emissions of PCDD/F and dust are reduced by approximately 90 %, and SO₂ emissions by approximately 85 %.

However, due to maintenance, disturbances and start-up/shutdown periods, technically unavoidable stoppages, disturbances, or failures of the high pressure scrubbing system occur. One of the reasons for these stoppages is when the nozzles, installed for correct distribution of water and compressed air, are clogged up with lead sulphate. This clogging process will have an adverse effect on the efficiency of the installation and therefore the nozzles need to be rinsed. Because of the aforementioned reasons, the scrubbing system was in bypass operation for approximately 500 hours per year. An analysis showed that approximately 50 % of this period was a consequence of maintenance operations, and 50 % was due to process disturbances. The emissions from bypass operations, therefore, are a significant part of the installations yearly emissions (for dust approximately 50 %, for SO₂ approximately 15 %).

It is difficult or impossible to predict exactly how much reduction per year is achieved. However, a reduction of the total bypass operation time of 200 h has been estimated which may achieve an emissions reduction of approximately 30 t/yr of dust and 125 t/yr of SO₂, as well as significant amounts of PCDD/F and HF relative to the steel plants total yearly emissions.

Applicability

This technique is applicable to both new and existing plants. However, it should be noted that the applicability is site-specific. Residual cleaned waste water should be extracted out of the water treatment units. Therefore, application of these systems is often dependent on the handling of the residual waste water and subsequently on the location of the sinter plant.

Economics

In Corus, IJmuiden, the Netherlands the investments and infrastructure costs were approximately EUR 40 million in 1997. The plant has been operational since May 1998 and the waste gas from three sinter strands totalling 630 000 Nm³/h has been treated since then. For this example, the currency was converted into ECU in 1997 and for the review into EUR.

Actual costs will differ widely depending upon the plant and the local requirements for waste water treatment services.

Driving force for implementation

No data submitted.

Example plants

In Europe the AIRFINE scrubber technique was applied at two sinter plants: Voestalpine, Linz, Austria, start-up in 1993 and at Corus, IJmuiden, the Netherlands start-up in 1998. The AIRFINE scrubber at Voestalpine, Linz, Austria was replaced by a bag filter in August 2007. A third unit is operated at BHP, Whyalla, Australia on a pelletisation plant.

At the State Council (Court of Appeals, Highest Administrative Court) in the Hague, an agreement was made between the competent authority (the province of North Holland), Corus and the (State) Environmental Inspectorate about the fabric filters. According to that agreement, the construction of a fabric filter downstream of the first of three sinter lines will start before December 2010. This will be a full scale pilot plant in order to test, adapt and improve the performance of the installation. By the year 2015 all three lines will be equipped with a fabric filter.

Reference literature

[45, Gebert 1995] [247, Netherlands 2007] [248, Eurofer 2007] [249, Netherlands 2007] [295, Hartig et al. 2006] [311, Eurofer 2007]

3.3.2.5 Reduction of VOC emissions

3.3.2.5.1 Lowering the content of volatile hydrocarbons in the sinter feed

Description

The input of hydrocarbons can be minimised, especially by the reduction of the oil input. Oil enters the sinter feed mainly by addition of mill scale. The oil content of mill scales can vary significantly, depending on their origin. Sometimes, oil content of up to 10 % is found but these are not normally used in sinter plants without prior treatment.

Most of the oil hydrocarbons volatilise from the sinter mixture at temperatures in the 100 to 800 °C range and are emitted from the sinter plant via the waste gas.

Several techniques can be applied to minimise oil input via dusts and mill scale and include the following:

1. limiting input of oil by segregating and then selecting only those dusts and mill scale with a low oil content
2. the use of ‘good housekeeping’ techniques in the rolling mills can result in a substantial reduction in the contaminant oil content of mill scale
3. de-oiling of mill scale by:
 - a) Heating the mill scale to approximately 800 °C, the oil hydrocarbons are volatilised and clean mill scale is yielded. The volatilised hydrocarbons can be combusted.
 - b) Extracting oil from the mill scale using a solvent.

Achieved environmental benefits

Non-methane volatile organic compounds (NMVOC) of <math><20 \text{ mg/Nm}^3</math> can be achieved (expressed as an annual average). The emissions can be significantly higher if precautionary measures are not taken to reduce the oil content of the sinter feed materials or as a result of the fuel that is used. These higher emissions levels are for plants operating ESPs alone as their main end-of-pipe abatement system.

Cross-media effects

When some of the residues/wastes which contain iron are rejected as suitable sinter plant feedstock, they are either processed in another way or they enter the waste stream and are disposed of. Thus, emissions may, in effect, be transferred to another site.

Whenever mill scale is de-oiled thermally, energy is consumed. The volatilised hydrocarbons should be combusted properly (rule of thumb: temperatures >850 °C for >2 seconds at >6 % O₂).

Operational data

Low oil content is preferred in dusts and mill scale residues used at the sinter plant for several reasons; for example, avoidance of fires and scaling in the ESP or blinding in the bag filter.

High oil content also could give rise to a higher potential for the formation of PCDD/F (see Section 3.2.2.1.2.8). Lower oil contents typically lead to lower VOC emissions.

Applicability

The reduction of VOC emissions can be applied both at new and existing plants.

Economics

No data available regarding de-oiling.

Driving force for implementation

No data submitted.

Example plants

Many plants regulate oil input in the sinter plant via the wastes which contain iron, especially those with an ESP or with a bag filter.

A number of plants for the de-oiling of mill scales were operated on a trial basis in the late 1990s in Germany but these have all ceased to operate. Thus, treatment techniques (3a and 3b above in the 'Description' section) are not used commercially in the EU steel industry at present.

Reference literature

[45, Gebert 1995] [65, InfoMil 1997] [145, UBA Comments 1997] [242, Caughlin 2007]
[303, Eurofer 2007] [387, Fisher et al. 2005]

3.3.2.5.2 Top layer sintering

Description

In Section 3.3.4 the recycling of materials which contain iron back into the sinter strand is described. With respect to recycled materials which contain hydrocarbons, especially oil, in Section 3.3.2.5.1 techniques are described to lower the oil/hydrocarbon input. There is another possibility to recycle such materials with a higher oil content by insuring that the oil content in the total mix does not exceed 3 %. It is called 'top layer sintering' and is claimed to be much cheaper compared to de-oiling techniques. Top layer sintering means that a certain mixture of by-products/residues which contain oil/hydrocarbons are conditioned to approximately 7 % water content and then deposited with a feeding drum on the main sinter layer. A second ignition hood with an energy output of 25 to 35 % of the energy output of the main burner is used to ignite this second layer. For achieving a high sinter quality from the second sinter layer of by-products/residues which contain oil, it is important that a balanced selection of energy carriers be present within this layer in order to satisfy the enthalpy requirements for water and oil evaporation, for the cracking of the inherent organic components, as well as for the complete sintering of this layer. In addition to this careful proportion of the sinter feed components, the exact positioning and timing of ignition of the second sintering layer is of critical importance.

Achieved environmental benefit

The combustion of hydrocarbons (mainly deriving from the oil content of recycled materials) within the sinter layers is optimised in order to protect the ESP (from fires) and to avoid blue haze (which represents incomplete combusted organic compounds). In addition, the emissions of PCDD/F can be reduced; pot grate tests showed a reduction of 60 – 65 % but data from sinter strands are not available.

Cross-media effects

Additional fuel for the ignition of the second layer needs to be available.

Operational data

The sinter strand of Voestalpine Stahl Donawitz GmbH, Austria has a suction area of 120 m² and a productivity of 35 t/m²/day. The productivity did not change after the introduction of top layer sintering in January 1995. The capacity for recycling production residues which contain iron is 18 t/h.

Applicability

There is limited applicability to existing plants because of missing space for additional storage facilities and for a second feed system as well. New plants would normally go for techniques minimising the hydrocarbon/oil input of the recycled by-products/residues. Flexibility in the selection of raw materials is very limited.

Economics

No data submitted.

Driving force for implementation

No data submitted.

Example plants

In Europe this technique is installed at the sinter plant of Voestalpine, Donawitz, Austria but is at time of writing (2010) not used.

Reference literature

[159, VAI 1997]

3.3.2.6 Reduction of PCDD/F

3.3.2.6.1 Suppression of PCDD/F formation by addition of nitrogen compounds in the sinter mix

Description

The formation of PCDD/F can be suppressed by the addition of substances which have an inhibiting effect on the formation of PCDD/F assuming that the formation of such substances takes place mainly in the sinter itself. In this case, an effective method for reducing PCDD/F is to add nitrogen compounds to the solid sinter mix in order to inhibit catalytic reactions on the surfaces involved. For this reason, tests with triethanolamine (TEA), monoethanolamine (MEA) or urea addition were carried out in different sinter plants. The addition of urea prills to the sinter feed upstream of the mixer and/or pelletiser has been applied on a full industrial scale in several plants. The urea prills are thereby homogeneously distributed throughout the raw sinter mixture prior to feeding it onto the strand.

Achieved environmental benefits

At the Corus sinter plant, Port Talbot, United Kingdom, the achieved PCDD/F performance using urea addition was approximately 1 ng I-TEQ/m³ at 17 % residual oxygen under optimal conditions. Typically, the dioxin emission concentration is reduced by 40 – 60 % at sinter plants using ESPs alone as the end-of-pipe abatement system so the individual final level of PCDD/F emissions is dependent upon the inlet PCDD/F concentration. The use of urea also minimise hydrogen chloride and hydrogen fluoride emissions.

Cross-media effects

Urea addition has some distinct disadvantages:

- the potential for a detrimental effect on the dust abatement performance of the ESP
- the exhaust plume from the sinter plant tends to become highly visible, leading to complaints from the public
- the use of urea leads to releases of ammonia

- the dust and micropollutant emissions actually increased, owing to a combination of several factors mentioned above.

Operational data

The handling and dispensing of the urea prills can present some problems specific to the material (it is hygroscopic in nature). In one case, 40 kg urea/h was added which equates to 0.12 kg/t of graded sinter.

Applicability

The technique can be applied at existing plants and could be equally incorporated into the designs for a new plant.

Economics

There is a relatively low investment cost and low operating costs for applying this technique. The investment cost for a 4 million tonnes/yr sinter plant is approximately EUR 700 000 (brick shelter, humidity-controlled storage silo, dosing and control equipment). The operating costs are about EUR 0.08 to 0.14/t of sinter (as per 2004 prices in the UK at GBP 1 = EUR 1.44).

An alternate, simpler system has also been installed for a similarly sized plant at a cost of about EUR 145 000 and the operational costs here are expected to be about EUR 0.05 to 0.07/t of sinter (as per 2007 prices in the UK at GBP 1 = EUR 1.45).

Driving force for implementation

The driving force for the implementation of this technique is the reduction of dioxin emissions.

Example plants

Preliminary trials with a temporary dosing system at the former Corus sinter plant, Llanwern, United Kingdom from 1996 – 98 led to a patent application in 1998. Transferability of the technology was demonstrated by further trials at the Corus sinter plant, Scunthorpe, United Kingdom in the period 2000 – 2001. A continuous dosing system was installed at Corus sinter plant, Port Talbot, United Kingdom from 2003 – 2004 for longer-term continuous dosing trials. The technique has been installed on a permanent basis at both Corus sinter plants, Scunthorpe and Corus, Teesside, United Kingdom in 2007.

Tests with urea, MEA and TEA addition were carried out in 1999 and 2001 at ArcelorMittal, Ghent, Belgium and in 2008 in Taranto, Rivagroup, Italy, where an industrial plant of urea storage and dosing system was installed in 2009.

Reference literature

[140, Eurofer 2009] [230, Brouhon et al. 2001] [265, Tan et al. 2004] [306, Eurofer 2007]

3.3.2.7 Reduction of SO₂

3.3.2.7.1 Primary measures for reduced SO₂ emissions from the sinter process

Description

The SO₂ emissions from sintering can be reduced in four ways:

- the use of raw materials with a low sulphur content
- minimising fuel consumption, mainly coke breeze
- increasing the sulphur uptake in the sinter
- the use of coarser coke breeze.

Sulphur compounds mainly enter the sintering process with the coke breeze and to a lesser extent with the ores. The SO₂ emissions can be reduced by using raw materials with a low sulphur content. A sulphur content of ≤0.8 % S in coke breeze and ≤0.08 % S in iron ores can be regarded as low and will directly correlate with lower SO₂ emissions.

The specific coke breeze consumption has been reduced over the past 30 years by approximately 50 % at EU sinter plants down to a current consumption of 39 – 64 kg/t sinter.

Another important factor is the degree of sulphur uptake in the sinter. The sulphur remains partly in the sinter product (in the order of 13 – 25 %), depending on the sinter basicity. Also the use of coarser coke breeze can reduce SO₂ emissions considerably (see Section 3.2.2.1.2.4).

Achieved environmental benefits

Emission concentrations of <500 mg SO₂/Nm³ can be achieved on an average daily basis.

Cross-media effects

The retention of additional sulphur in the sinter could have an adverse effect on the operation of the blast furnace when a low-sulphur iron is required.

Operational data

No specific problems are known. The plants operate smoothly.

Applicability

Minimising sulphur inputs into the sinter feed (use of low-sulphur coke breeze and iron ore and minimising specific coke breeze consumption) can be applied both at new and existing plants. However, it should be noted that the availability of low-sulphur breeze and ore might be a constraint.

Economics

No data submitted.

Driving force for implementation

No data submitted.

Example plants

ArcelorMittal, Ghent, Belgium; Corus sinter plants, United Kingdom; Thyssen Krupp Stahl, Duisburg, Germany and Rivagroup, Taranto, Italy. Examples outside the EU also exist.

Reference literature

[7, Bothe 1993] [304, Eurofer 2007]

3.3.2.7.2 Wet desulphurisation

Description

There are wet and dry desulphurisation processes but only a wet system is considered here. After waste gases are cooled, SO_2 is absorbed in a spray tower with a solution which contains calcium (Ca) or magnesium (Mg). This forms gypsum (CaSO_4) or magnesium sulphate (MgSO_4), which is removed from the column as a slurry. Several reaction agents may be used:

- steel slag (steel slag desulphurisation (SSD) process). Steel slag, which contains 30 – 40 % CaO is pulverised, mixed with water and added as a slurry which contains $\text{Ca}(\text{OH})_2$
- slaked lime ($\text{Ca}(\text{OH})_2$)
- calcium chloride (CaCl_2) and slaked lime ($\text{Ca}(\text{OH})_2$)
- slaked lime ($\text{Ca}(\text{OH})_2$) and chalk (CaCO_3)
- magnesium hydroxide ($\text{Mg}(\text{OH})_2$).

The gypsum is dewatered. Its quality strongly depends on the efficiency of the preinstalled dust abatement device. In some countries, this gypsum can be sold to the cement manufacturing industry.

Water is separated from the gypsum slurry and most of it is recirculated. Because of chloride build-up, there will be a scrubbing water bleed. Thus, both a solid (gypsum) and waste water are generated.

When ammonium hydroxide (NH_4OH) is used as a reaction agent, an ammonium hydrogen sulphite (NH_4HSO_3) solution is generated. This solution is processed by wet oxidation in the gas treatment plant of the coke oven producing ammonium sulphate ($(\text{NH}_4)_2\text{SO}_4$).

Wet desulphurisation can be also achieved with fine scrubber systems (see Section 3.3.2.4).

Activated lignite coke can also be injected into the flue-gas for PCDD/F adsorption. After this reaction, the activated lignite coke is separated by a bag filter.

Achieved environmental benefits

Desulphurisation efficiencies of 85 – 90 % can be achieved, although efficiencies of 95 – 99 % have been reported. With these performance values, less than $200 \text{ mg}/\text{Nm}^3$ of SO_x have been reported for input values below $1.5 \text{ g}/\text{Nm}^3$. Furthermore, HCl, HF and dust are scrubbed from the waste gas. The system does not remove NO_x .

Cross-media effects

A slurry that contains gypsum is generated. The disposal of the gypsum can create considerable problems. In countries where there is no market for gypsum, the dewatered material should be disposed of as an active waste, requiring further stabilisation before dumping and thereby generating higher disposal costs. Even where there is a market for gypsum, the contamination of the product with dust makes it less attractive and it may have to be disposed of. Furthermore, additional waste water treatment is necessary when the unit removes dust simultaneously.

In one case, the gypsum was separated in a contaminated part (10 %), which was disposed of, and a 'clean' part (90 %), which was sold. But this system is no longer in operation.

Most of the scrubbing water can be recirculated, especially when a dust abatement device is used prior to the desulphurisation unit. A bleed is usually needed to avoid the build-up of chloride. Bleeds in the range of 5 to $20 \text{ m}^3/\text{h}$ are reported. However, in some cases no bleed occurs and water is supplemented.

Electricity consumption is estimated at 6.1 – 7.2 MJ/t sinter. Furthermore, the cleaned waste gas should be reheated before being emitted in order to achieve a sufficient plume rise. In some

cases, coke oven gas is used for this purpose and sometimes the CO present in the sinter plant waste gas is catalytically combusted.

Slaked lime consumption depends on the SO₂ inlet concentration, the amount of waste gas treated and the desired efficiency. Reported consumption is 3 – 4 kg slaked lime (Ca(OH)₂) per m³ SO₂ at Wakamatsu Works, NSC, Japan.

Operational data

Table 3.28 gives an overview of operational and economic data from three desulphurisation units. All these units have been installed to meet environmental regulations set by the local authorities. No specific operational difficulties have been mentioned.

Applicability

This technique can be applied both at new and existing plants, although the requirements of space may be of significance. However, at the time of writing this BREF (2010), there are no examples where wet desulphurisation has been applied at a sinter plant in Europe. Due to high investment and operational costs and significant cross-media effects such as slurry generation and disposal and additional waste water treatment measures, the wet desulphurisation process is not applied in Europe, although, it might be an option in circumstances where environmental quality standards are not likely to be met.

Economics

The desulphurisation efficiency figures quoted in Table 3.28 do not take plant downtime into account and so reflect a 24 hours-per-day operation; thus, in practice, the overall efficiency figures would be considerably lower. As noted above, the sale of the resulting gypsum may not be possible in some European countries, thus leaving a disposal problem.

The following costs for wet desulphurisation equipment were reported:

For these examples the currency was converted into ECU in 1996 and for the review into EUR.

- investment: EUR 50 – 80/Nm³/h
- operational: EUR 0.5 – 1.0 per kg SO₂ removed.

For a sinter plant with a capacity of 4 Mt/yr, with a waste gas flow of 1 million Nm³/h, 8640 operational hours per year, with untreated SO₂ emissions of 1200 g/t sinter and 90 % desulphurisation efficiency, to the following costs would be typical:

- investment: EUR 50 – 80 million
- operational: EUR 0.5 – 1.1/t sinter.

Because the investments are relatively high (greater than the cost of a new sinter plant) and depend strongly on the waste gas flow, it may be beneficial to restrict desulphurisation to the waste gas sections with the highest sulphur concentration (see Figure 3.7) and concentrate efforts on lowering the sulphur input to the process (see Section 3.3.2.7.1).

Table 3.26 shows the total investment and operational costs for a wet desulphurisation system with simultaneous NO_x reduction for two different cases. It is a qualitative comparison between dry and wet desulphurisation processes for sinter plants only (see Table 3.31).

Table 3.26: Cost estimation of wet process together with an SCR system

Abatement efficiency required	deSO _x : 95 % deNO _x : 40 %	deSO _x : 95 % deNO _x : 80 %
Initial cost:	110 ⁽¹⁾	147
• main facility	85.4	122.6
• water treatment plant	7.3	5.9
• other (piping, electricity and instruments, civil facility, engineering)	17.3	18.5
Running cost (8476 h/yr):	154.4	197.5
• electrical power	51.0	56.8
• coke oven gas	54.5	77.6
• Mg(OH) ₂	29.9	29.9
• other (catalyst, NH ₃ , chemicals for WWTP, utilities, steam)	19.0	33.2

⁽¹⁾ The total cost of a wet system in Case 1 is 110 % (this value is referenced to the 100 % shown in Table 3.31 of Section 3.3.2.7.3).

NB: — Gas flow rate 1.5 million Nm³/h; gas temperature 120 °C, SO₂ input: 373 mg/Nm³, NO_x input: 454 mg/Nm³.
 — Wet process with Mg(OH)₂ and SCR.
 — Wet desulphurisation can be also achieved with fine scrubber systems (see Section 3.3.2.4).

Source: [268, SHI 2006].

Driving force for implementation

No data submitted.

Example plants

In Table 3.27, details on a number of sinter plants that apply wet desulphurisation are given.

Table 3.27: Wet desulphurisation units at sinter plants

Company	Works	Plant	Amount of gas treated (design) (1 x 10 ⁶ Nm ³ /h)	Reaction agent
Nippon Kokan KK	Fukuyama		0.76	Ammonium hydroxide
	Keihin		1.2 – 1.3	
Kawasaki Steel Corporation	Chiba	Sinter plant no 4	0.62 – 0.75	Slaked lime
	Chiba	Sinter plant no 3	0.32	
	Mizushima	Three sinter plants	0.75; 0.75; 0.9	
Kobe Steel Ltd.	Kakogawa		1	CAL (*)
	Kobe		0.35	
Sumitomo Metal Industries	Wakayama	Sinter plant no 5	0.4	Slaked lime and chalk
	Kashima	Two sinter plants	0.88; 0.2	Slaked lime and chalk
	Kokura		0.32	Magnesium hydroxide

(*) CAL: Calcium chloride and slaked lime.

NB: In one plant the technique was under operation in the EU until the plant was closed. The reason for this is that the technique was succeeded by a process-integrated measure preventing cross-media effects as waste water and solid waste.

Source: [65, InfoMil 1997] [313, Eurofer 2007].

Reference literature

[65, InfoMil 1997] [249, Netherlands 2007] [251, Eurofer 2007] [268, SHI 2006] [295, Hartig et al. 2006] [313, Eurofer 2007]

Table 3.28: Operational data and economics of three sinter plant wet desulphurisation units

		Unit	Nippon Kokan KK-Keihin	Nippon Steel Corp. Wakamatsu/Yawata	Sumitomo Metal Ind. Wakayama
Sinter production	Design	t/h	500	1000	NA
	Actual		NA	600	185
Total waste gas flow	Design	10 ⁶ Nm ³ /h	1.2 – 1.3	2	NA
	Actual		NA	1	0.4
Sinter basicity		CaO/SiO ₂	1.8	1.92	2.2
Desulphurisation capacity	Design	10 ⁶ Nm ³ /h	1.2 – 1.3	1 (partial deSO _x)	NA (partial deSO _x)
	Actual		NA	0.45 – 0.51 (partial deSO _x)	0.2 (partial deSO _x)
Preinstalled dedusting	Type	mg/Nm ³	Dry ESP	Cyclone	Dry ESP
	Clean gas		50	NA	40
Reaction agent			NH ₄ OH	Slaked lime	Slaked lime and chalk (50:50)
SO ₂ inlet concentration	Design	mg/Nm ³	NA	1140	1830
	Actual		560 – 840	513 – 684	730 – 940
SO ₂ outlet concentration	Design	mg/Nm ³	NA	<110	370
	Actual		3 – 9	6 – 29	NA
Desulphurisation efficiency	Design	%	NA	90	80
	Actual		>99	95 – 98	NA
By-product	Type	kg/t sinter	Ammonium sulphate	Gypsum	Gypsum
	Amount		NA	1.0 – 1.34	4.5
	Processing		Sold	Sold	Mainly disposed of
Energy demand		GJ/t sinter	NA	0.0061 – 0.0072 (electricity) (<0.3 % of total energy consumption)	NA
Investment ⁽¹⁾		EUR 10 ⁶	NA	NA	19.4 (in 1976)
Operational costs ⁽¹⁾		EUR/t sinter	NA	0.016 (in 1986); Only maintenance	0.62 (in 1986); Without maintenance without depreciation

⁽¹⁾ For the example the currency was converted into ECU in 1996 and for the review into EUR.
NB: NA = Not available.
Source: [65, InfoMil 1997].

3.3.2.7.3 Regenerative activated carbon (RAC) process for desulphurisation and reduction of NO_x

Description

Dry desulphurisation techniques are based on an adsorption of SO₂ on activated carbon. When the SO₂-laden activated carbon is regenerated, the process is called regenerated activated carbon (RAC). In this case, a high quality, expensive activated carbon type may be used and sulphuric acid (H₂SO₄) is yielded as a by-product. The bed is regenerated either with water or thermally. This technique is applied at municipal waste incinerators, refineries, power plants and sinter plants.

In some cases, lignite-based activated carbon is used. In this case, the SO₂-laden activated carbon is usually incinerated under controlled conditions. This technique is usually only applied for 'fine-tuning' downstream of an existing desulphurisation unit.

The RAC process (illustrated in Figure 3.19) allows for the removal of several components from the waste gas: SO₂, HCl, HF, mercury (Hg), dust, PCDD/F and optional NO_x. The system can be developed as a single-stage or a two-stage process. In the single-stage process, the waste gases are led through a bed of activated carbon and pollutants are adsorbed by the activated carbon. NO_x removal only occurs when ammonia (NH₃) is injected into the gas stream before the catalyst bed.

In the two-stage process, the waste gases are led through two beds of activated carbon. Ammonia can be injected before the bed to reduce NO_x emissions.

In the regenerator, PCDD/F are decomposed at temperatures ranging from 400 to 450 °C.

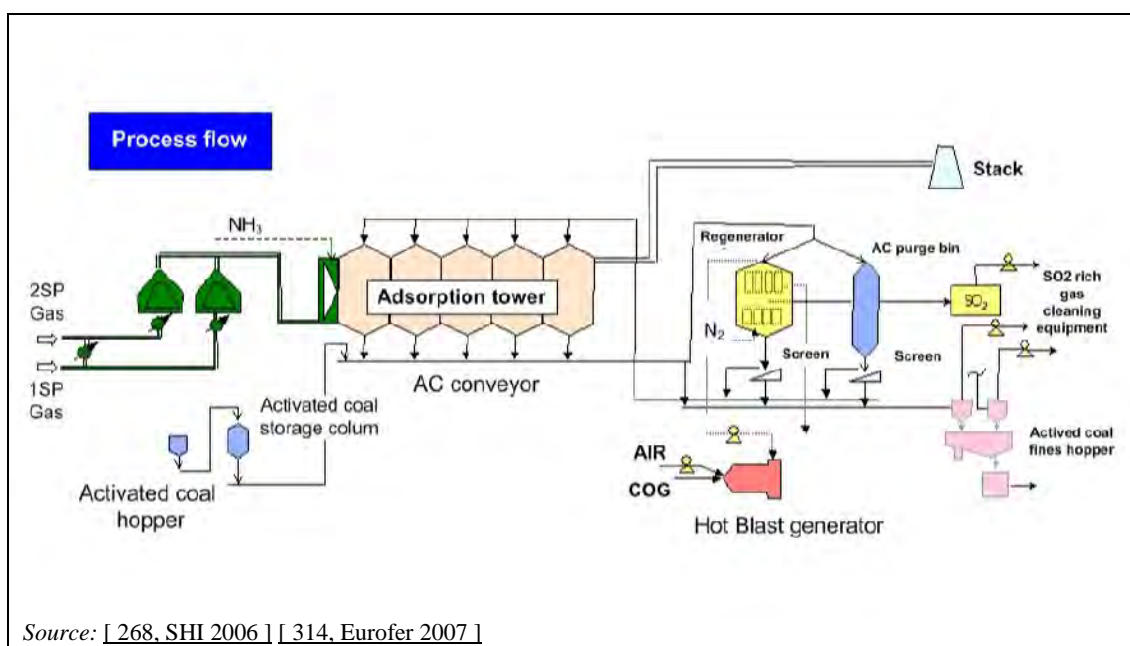

Figure 3.19: Regenerative activated carbon (RAC) process

Achieved environmental benefits

Highly efficient desulphurisation is possible (>95 %). The efficiency in NO_x reduction can be as high as 80 – 90 %, depending on operating temperatures, the addition of NH₃ and design. These efficiency figures do not consider plant downtime and reflect a 24 hours-per-day operation. Thus, actual efficiency figures would be considerably lower.

Table 3.29: Concentration of waste gas components

Parameter	Units	Values
Waste gas flow rate	Nm ³ /min	14200
Temperature	K	414 – 415
Moisture	vol-%	6.9
O ₂	vol-%	14.7
CO ₂	vol-%	7.9
CO	vol-%	1.2
NO _x	mg/Nm ³	266 – 322
SO _x	ppm	7 – 127
SO ₃	ppm	0.1
Dust	mg/Nm ³	6 – 10
NB: The SO _x processing plant has magnesium hydroxylation equipment. If this system is not working, emissions of up to 168 ppm can be reached. The system is composed of a cyclone, an ESP and a dry desulphurisation system.		
Source: [261, Kasama et al. 2006].		

Table 3.30: Achievable performance of a sinter plant when applying activated char coal

Pollutant	Achievable performances	Units	Comments
SO ₂	95 – >98 ⁽¹⁾	%	
	Inlet: 572 – 858	mg/Nm ³	
	Outlet: 20 – 30	mg/Nm ³	
NO _x	>40 or 60 ⁽²⁾	%	In cases where >60 % abatement is required, a two-stage process is needed
	Inlet: 300 – 520	mg/Nm ³	
	Outlet: 120 – 200	mg/Nm ³	
PCDD/F	Inlet: 0.03 – 3	ng I-TEQ/Nm ³ -dry	Inlet 1 – 2
	Outlet: 0.000001 – 0.1		
Dust	Inlet: 10 – 140	mg/Nm ³	Inlet <100. Lower performances depend on particle size distribution
	Outlet: 2 – 20		
Hg	95 – >99	%	Performance not guaranteed
	Inlet: 20 – 30	µg/Nm ³	
⁽¹⁾ Data based on continuous monitoring during one month at two existing plants show high constant efficiencies.			
⁽²⁾ Data based on continuous monitoring during one month at three existing plants show efficiency fluctuations between 40 and 60 % for single-stage system and between 62 – 75 % for a two stage system.			
Source: [268, SHI 2006].			

The RAC process reduces dust levels from 80 – 100 mg/Nm³ to less than 20. Dioxin emissions are reduced from 3 ng/Nm³ to less than 0.3.

Cross-media effects

When the RAC process is applied, the total energy consumption per tonne of sinter increases and a small water flow is generated. In an integrated iron and steel plant, the water flow can be treated in an existing waste water treatment plant if one exists that is conveniently located. If not, additional costs would be incurred for a suitable waste water treatment. Sulphuric acid is produced as a by-product.

No solid waste is generated in the RAC process, because the activated carbon is regenerated and partially combusted. Electricity consumption is 1200 kW or 8.6 MJ/t sinter (around 0.4 % of the total sinter energy consumption).

When the non-regenerative process is applied, the total energy consumption per tonne of sinter increases and a contaminated solid waste is yielded, which should be properly treated.

The dust extracted from the gas cleaning process is very fine, and contains heavy metals (radioactive materials may also appear). Therefore, the dust cannot be readily recycled into the ironmaking process in the same way as other iron-bearing dusts.

Operational data

Sinter plant No 3, Nagoya Works, Nippon Steel Corporation has a capacity of 12000 tonnes of sinter per day, with a waste gas flow of 900000 Nm³/h. Sinter basicity was 1.72 – 2.1 in 1991. The RAC process was designed as two parallel single-stage absorption towers, each with a capacity of 450000 Nm³/h. Prior to desulphurisation, dust is removed in a cyclone and subsequently by an ESP (clean gas concentration: 20 – 30 mg/Nm³). Measurements were carried out which showed SO₂ inlet concentrations of 360 mg/Nm³ and a desulphurisation efficiency of 97 %. The corresponding outlet concentration was 11 mg/Nm³. Dust outlet concentrations were 15 – 20 mg/Nm³ (particle size 2 – 4 µm; 60 % carbon).

NO_x reduction with RAC is applied in one of the two adsorption towers only, with NH₃ injection. The overall NO_x removal efficiency is low at 15 % (or 30 % on the one adsorption tower with NH₃ injection).

The SO₂-laden activated carbon is regenerated by thermal treatment at 380 – 430 °C. The carbon is indirectly heated by a coke oven gas-fired heater. Nitrogen (N₂) is admixed (500 m³/h). The water-saturated SO₂-rich (15 %) gas is led to the sulphuric acid plant of the coke oven gas treatment. The regenerated carbon is screened and fed back to the adsorption beds. The small size particles are used as sinter plant feedstock. These characteristics are specific to the plant considered and are not generally applicable to other plants. Activated carbon consumption amounts to 150 kg/h. Steam consumption (40 bar) is 600 kg/h and water consumption is 0.08 m³/h.

Special attention should be paid to the inlet temperature of the waste gas (<140 °C), and to the inlet concentration of dust (max. 50 mg/Nm³). Dust abatement (e.g. ESP or high-performance multiple cyclones) should be installed prior to the RAC process to reduce the inlet dust concentration.

Applicability

The RAC process can be applied as an end-of-pipe technique both at new and existing plants. The process is usually installed for the simultaneous removal of several components from the off-gas (e.g. SO₂, HF, HCl, NO_x but also dust and PCDD/F). Generally the layout of the plant and space requirements are important factors when considering this technique but especially for a site with more than one sinter strand.

However, at the time of writing (2010), there have been no examples where the RAC process has been applied at a sinter plant in Europe. Due to high investment and operational costs, in particular when high quality, expensive, activated carbon types may be used and a sulphuric acid plant is needed, the RAC process is not applied in Europe. Although, it might be an option in new plants targeting SO_x, NO_x, dust and PCDD/F simultaneously or in circumstances where environmental quality standards are not likely to be met.

Economics

Investments (excluding the sulphuric acid plant and the waste water treatment plant) in 1987 were approximately EUR 21 million. In 1991, the investment costs at Voestalpine, Linz, Austria were quoted as being approximately EUR 73 million for a RAC plant.

Operating costs (excluding maintenance and depreciation) were EUR 0.75/t sinter in 1991. Maintenance costs are estimated at EUR 0.17/t sinter (EUR 750 000 per year). Note that these data are for an RAC installation for the combined removal of SO₂ and NO_x.

(¹) For all examples the currencies was converted into ECU in 1996/1997 and for the review into EUR.

Table 3.31 shows the total investment and operational costs for a dry desulphurisation system with simultaneous NO_x reduction for two different cases. It is a qualitative comparison between dry and wet desulphurisation processes for sinter plants only (see Table 3.26).

Table 3.31: Cost estimation of an activated coal system

Abatement efficiency required	deSO _x : 95 % deNO _x : 40 %	deSO _x : 95 % deNO _x : 80 %
Initial cost:	110 (¹)	136.1
• main facility	60.8	86.2
• initial filling of activated char coal	8.8	16.2
• by-product facility (H ₂ SO ₄)	8.5	8.5
• other (piping, WWTP, electricity and instruments, civil facility, engineering)	21.9	25.2
Running cost (8476 h/yr):	100	166.8
• activated char coal	57.7	115.4
• electrical power	29.8	35.3
• NH ₃ (for deNO _x)	10.4	14.0
• other (COG, utilities, steam, NaOH)	13.6	13.6
• H ₂ SO ₄ (on the market) (²)	-11.5	-11.5
<p>(¹) Total cost of dry system is 100 % (this value is referenced to the 110 % shown Table 3.26 of Section 3.3.2.7.2). (²) Sulphuric acid produced. NB: Gas flow rate: 1.5 million Nm³/h; gas temperature: 120 °C; SO₂ input: 373 mg/Nm³; NO_x input: 454 mg/Nm³. Source: [268, SHI 2006].</p>		

Investments for regenerative activated carbon are estimated to be around EUR 60 million in a sinter plant with a 500 – 600 m² sinter strand and operational costs are estimated to be approximately EUR 1/t (Arcelor).

Driving force for implementation

No data submitted.

Example plants

At least eight sinter plants have implemented this technique using activated coal in Japan, Korea and Australia. The RAC process targeting SO_x has been in operation at sinter plant No 3, Nagoya Steelworks, Nippon Steel Corporation in Japan, since August 1987. In 1999, sinter machines 1 and 2 at Nagoya Steelworks were equipped to target SO_x, NO_x and dust for 1.3 million Nm³/h of waste gas. Other plants reported to have installed this system or a variation on the process include:

- BlueScope Steel, Port Kembla Works, Australia, sinter machine No 3, to treat 1552000 Nm³/h of waste gas for dust and PCDD/F (start-up June 2003)
- Nippon Steel Corporation, Oita Works, Japan, sinter plant No 1, to treat 1300000 Nm³/h of waste gas for SO_x, NO_x, dust and PCDD/F (start-up 2003)
- POSCO, Pohang Steelworks, Korea, sinter machines Nos 3 and 4, to treat 1350000Nm³/h of waste gas for SO_x, NO_x dust and PCDD/F (start-up November 2004)
- Nippon Steel Corporation, Kimitsu Steelworks, Japan, sinter plant No 3, to treat 1700000 Nm³/h of waste gas for SO_x, NO_x and dust (start-up 2004)
- Kobe Steel Corporation, Kakogawa Steelworks, Japan, sinter plant No 1, to treat 1500000 Nm³/h of waste gas for SO_x, NO_x dust and PCDD/F (at planning stage in 2007).

The carbon packed bed filter technology has been tested in one pilot plant installation in Australia (BHP Steel) and is working in some sinter plants in Japan.

No sinter plants in Europe operate with the regenerative activated carbon (RAC) process.

Reference literature

[65, InfoMil 1997] [215, BSS 2007] [252, France 2007] [254, Eurofer 2007] [261, Kasama et al. 2006] [268, SHI 2006] [314, Eurofer 2007]

3.3.2.8 Reduction of NO_x

3.3.2.8.1 Primary measures for reduced NO_x emissions

The use of anthracite may decrease NO_x emissions and depends on the availability of anthracites with a lower N content compared to coke breeze.

An additional measure which can be considered less significant is the use of low-NO_x burners for ignition.

Another option to reduce total NO_x emissions is to apply one of the waste gas recycling techniques described in Section 3.3.5.2.

3.3.2.8.2 Selective catalytic reduction (SCR)

Description

In this process, NO_x in the waste gas is catalytically reduced by ammonia (NH₃) or urea to N₂ and H₂O. Vanadium pentoxide (V₂O₅) or tungsten oxide (WO₃) on a titanium oxide (TiO₂) carrier are often used as catalysts. Other possible catalysts are iron oxide and platinum. Optimal operating temperatures range from 300 to 400 °C.

SCR can be applied as a high dust system, a low dust system and as a clean gas system; each with its own characteristics. Until now, only clean gas systems have been applied at sinter plants.

Special attention should be paid to the deactivation of the catalyst, the accumulation of explosive ammonium nitrate (NH₄NO₃), ammonia slip, and the formation of corrosive SO₃. Usually, the off-gases should be reheated before entering the SCR device in order to achieve the required operational temperature.

Achieved environmental benefits

A NO_x reduction efficiency of about 80 % has been achieved at sinter plants, depending on the catalyst type used, operating temperature and NH₃ addition. Outlet concentration values of between 56 – 120 mg/Nm³ (reference O₂: 15 %) have been reported (input values are between 180 – 600 mg/Nm³).

Cross-media effects

Because SCR is a dry technique, there are no emissions to water. The only waste generated is deactivated catalyst, which can be reprocessed by the manufacturer. This technique implies the storage and use of ammonia, but not necessarily as liquid ammonia; urea or ammonia solutions may also be used.

Overall energy consumption increases as the off-gases have to be reheated before coming into contact with the catalyst. This reduces the possibilities for recovery of sensible heat from the sinter process. Furthermore, the SCR device consumes electrical energy.

The use of SCR shows N₂O emissions lower than 8 ppm. NH₃ slip is reported at two sinter plants to be between <1 – 3 ppm.

Operational data

At the sinter plant at Kawasaki Steel Corporation, Chiba Works, Japan, an SCR was installed in 1975 to reduce NO_x emissions. The sinter plant has a capacity of 7000 t sinter/day and a waste gas flow of 620 000 to 750 000 Nm³/h. The NO_x emissions were reduced from 450 mg/Nm³ to 37 mg/Nm³ on a platinum (Pt) catalyst, thus achieving a reduction efficiency of >90 %. The SCR is operated as a clean gas system, which means that the SCR is installed after dedusting and desulphurisation.

The SCR can be operated at either 260 °C or at 400 °C. At 260 °C, the catalyst should be revitalised several times per year by heat treatment. At this temperature, the 90 % efficiency is only obtained by adding NH₃ at 1.2 times above the stoichiometric ratio. In this situation, NH₃ slip occurs. After three years of operation at 260 °C, a CO converter was installed upstream from the SCR device. In the converter, CO in the waste gas is catalytically combusted and heat is generated. The CO converter increases the gas temperature from approximately 400 °C to 480 °C. NO_x removal of approximately 90 % efficiency has been achieved with the addition of NH₃ at a stoichiometric ratio of 0.9. No NH₃ slip occurs. The pressure drop over the catalyst bed (1 m) is 140 mm (water column).

At the sinter plant of Nippon Kokan, Keihin Works, Japan, an SCR device was installed in 1979. This system is operated as a clean gas system after dedusting and desulphurisation. The sinter plant has a capacity of 12000 tonnes of sinter per day and a waste gas flow of 1.2 million to 1.3 million Nm³/h.

The SCR uses lump ore (limonite and gasite ores from Asia) as a catalyst. The used catalyst is screened and used as feedstock in the blast furnace or the sinter plant.

The gases enter the SCR after being preheated to a temperature of 340 °C with a NO_x concentration of 410 mg/Nm³. The clean gas concentration is 100 – 120 mg/Nm³, equivalent to an SCR efficiency of 70 – 75 %.

The pressure drop over the SCR device is 60 – 70 mm (water column). The heat exchanger has a pressure drop of 80 mm (water column).

NH₃ consumption is 120 g/t sinter. Electricity consumption is 0.014 GJ/t sinter, or <1 % of the total sinter energy consumption.

The SCR has operated without any reported problems.

COG is used for reheating in the operation of the deNO_x plant at sinter plants Nos 1, 3 and 4 of China Steel, Taiwan. SCR devices for sinter plants 3 and 4 were installed in June 1997 and an SCR device for sinter plant 1 in June 1999. The NO_x emissions have been reduced to 52 – 100 mg/Nm³ (reference O₂: 15 %). Reduction rates are about 80 %. COG is used for reheating in the operation of the deNO_x plant. The waste gas volumes for these plants are:

- sinter plant No 1: waste gas volume approximately 464 000 Nm³/h
- sinter plant No 3: waste gas volume approximately 850 000 Nm³/h; catalyst volume 193.2 m³
- sinter plant No 4: approximately 1 164 000 Nm³/h (19 400 Nm³/min).

The NH₃ slip for sinter plants No 1 and No 3 is <1 ppm and for sinter plant No 4 between 1.5 and 3 ppm.

Applicability

This technique can be applied as an end-of-pipe technique at both new and existing plants. At sinter plants, only clean gas systems, after dedusting and desulphurisation, have been commissioned. It is essential that the gas is low in dust (<40 mg dust/Nm³) and heavy metals,

because these species can make the surface of the catalyst ineffective. Additionally, desulphurisation prior to the catalyst might be required. Another prerequisite is a minimum off-gas temperature of about 300 °C. This requires an energy input.

However, at the time of writing (2010), there have been no examples where the SCR technique has been applied at a sinter plant in Europe. Due to high investment and operational costs and due to the need for catalyst revitalisation, NH₃ consumption and slip, additional energy required for reheating which can reduce the possibilities for recovery of sensible heat from the sinter process, the SCR technique has not been applied in Europe. Although, it might be an option in circumstances where environmental quality standards are not likely to be met.

Economics

Kawasaki Steel Corporation sinter plant, Chiba Works, Japan costs include:

- investments: EUR 27.3 x10⁶ in 1975
- maintenance costs: EUR 0.08/t sinter in 1992 (EUR 200000/yr)
- operational costs: EUR 0.40/t sinter in 1992 (EUR 1 000 000/yr); including preheating costs.

Nippon Kokan sinter plant, Keihin Works, Japan costs include:

- investments: EUR 50 × 10⁶ in 1979
- maintenance costs: EUR 0.57/t sinter in 1992 (EUR 900000/yr)
- operational costs: EUR 0.75/t sinter in 1992.

[65, InfoMil 1997] reports the following costs for SCR:

- investment: EUR 25 – 45/(Nm³/h)
- operational: EUR 0.7 – 0.9/1000 Nm³ treated.

For a sinter plant with a capacity of 4 million t/yr, a waste gas flow of 1 million Nm³/h and 8640 operational hours per year, this would correspond to the following costs:

- investment: EUR 25 to 45 million
- operational: EUR 1.5 to 2.0/t sinter.

For the two examples, the currency was converted into ECU in 1996 and for the review into EUR.

In 1997, an estimated cost of about EUR 30 million was quoted for an SCR unit including a reheating system for a waste-gas flow of 630000 Nm³/h at Corus, IJmuiden, the Netherlands.

Decisive cost factors are the use of a catalyst, the ammonia consumption and, if applicable, costs for preheating the waste gas.

No sinter plants in Europe at the time of writing (2010) operate a deNO_x system of this type.

Driving force for implementation

Research has shown that neither NO_x prevention techniques as partial replacement of coke breeze with iron-rich slag, propane, DRI and petroleum coke, nor the use of ammonia solution or ammonium carbonate as blend additives offered a practical solution for reducing NO_x emissions from sinter plants.

Example plants

1. Kawasaki Steel Corporation, Chiba Works, Japan
2. Nippon Kokan, Keihin Works, Japan
3. Sinter plants 3 and 4, China Steel, Taiwan (installed in June 1999 and June 1997).

The new installations are located in Taiwan and Korea. No new SCR plants have been installed in Japan since 1997.

At least one SCR plant at Voestalpine Stahl GmbH, Linz, Austria is being planned; however, as of 2008, no SCR installation has become operational in the EU. In 2008 – 2009, an SCR was installed for 1/10 of the waste gas in a demonstration plant. The results of the demonstration plant will be used for upscaling, which is scheduled for 2011.

Reference literature

[65, InfoMil 1997] [387, Fisher et al. 2005] [277, Wiesenberger 2007]

3.3.3 Collection and abatement of dust emissions from secondary sources

Description

Secondary emissions can be captured by secondary dedusting systems (the term ‘room dedusting’ of sinter plants is also used). This technique comprises different sources such as the hearth laying, the strand discharge zone with crushing and sieving, and transfer points of the sinter conveyor. The evacuated gases are usually treated in a dedusting device, like an ESP or bag filter. Operations are performed in a closed building to further help the collection of diffuse/fugitive emissions.

Achieved environmental benefits

At one sinter plant, the majority of these evacuated gas streams from these sinter plant operations and from transfer points are combined and dedusted in three parallel ESPs. The dust emissions are measured continuously and have a yearly value of 270 t, for a combined gas flow of approximately 815000 m³/h. The dust concentration is approximately 35 mg/Nm³.

At a German plant, sinter room dedusting emissions of <4 mg dust/Nm³ are achieved as an annual mean with bag filters [342, GWAA Bremen 2005]. Another German plant achieves <21 mg dust/Nm³ for room dedusting and <18 mg dust/Nm³ for the sinter cooler dedusting. In both cases, ESPs are applied and the values are half-hourly averages, measured continuously. A third German sinter plant achieves <19 mg dust/Nm³ for the dedusting of the hot crusher and handover points with an ESP (daily average value). In another German plant, the room dedusting is carried out with an ESP and for parts of the off-gases from sinter cooling with a fabric filter (FF). The corresponding achieved emission concentrations are 25 for an ESP and <15 mg dust/Nm³ for the FF [244, Plickert 2007].

In one Austrian plant, the room dedusting including sinter discharge, crushing, screening and sinter conveying is carried out with an ESP and with an FF. The off-gases are merged and the achieved emission concentration is <16 mg dust/Nm³ (half-hourly average). Another Austrian sinter plant achieves values of 3 mg dust/Nm³ [211, Remus, Rainer 2008].

Cross-media effects

No data submitted.

Operational data

No data submitted.

Applicability

Secondary dedusting is used for all of the elements of preparatory and support processes which result in emissions of pollution to the air including transshipment points, mix or sinter burdening, and sinter cooling, blending, screening and crushing operations.

Economics

For the mentioned example with a gas flow of 815 000 m³/h, the investments costs for the bag filters were EUR 12 million and the operational yearly costs are EUR 3.25 million.

Driving force for implementation

The various sinter plant operations like blending, crushing, cooling and screening as well as transport (especially at the transfer points between the conveyor belts) and recycling of the sinter between these different operations are a source of dust emissions. The dust consists of 75 % PM₁₀ and 35 % PM_{2.5}.

Example plants

At the sinter plant from Voestalpine Stahl Linz, Austria a collection and cleaning of one part of the flue-gas (370 000 m³/h) is performed with ESPs. Another part of the flue-gas (160 000 m³/h) is dedusted in a bag filter.

In a Dutch sinter plant, the off-gas from the charging zone is dedusted by means of a bag filter. The emissions from discharging, crushing and screening zones, from conveyers and from parts of the cooler are extracted and dedusted by means of ESPs [114, Remus, Rainer 2008].

At ArcelorMittal, Eisenhüttenstadt, Germany the dedusting of the emissions of the cooling strand and other secondary sources is carried out with ESP.

The Thyssen Krupp Stahl, Duisburg, Germany installation has the particular characteristic of having the sinter cooler situated close to the boundary of the iron and steel works. Measurements have proven that these emissions make a relevant contribution to the dust deposition in the area beyond the boundary of the plant. For this reason, a cooler dedusting system was installed and started up in April 2003. The dust created by the transport, handling and cooling of the sinter is collected. The dust-laden air from the cooler, hot screens and some other plant areas are separated from the existing plant dedusting facility and fed to a new ESP. Diffuse emissions are considerably reduced from the cooler area by optimising the airflow rates in the dedusting system at the various extraction points ensuring a relatively high flow (300 000 Nm³/h) at the strand discharge area. An installed ESP treats a total waste airflow rate of approximately 1 400 000 Nm³/h and it was designed to achieve a particulate content of 30 mg/Nm³ at discharge, measured as a half-hourly mean value. The dust collected in the ESP is sent by a chain conveyor to a surge bin. After that, it is wetted and sent to the fine ore beds by conveyor belts.

Reference literature

[128, Sporenberg 2006] [241, Poland 2007] [249, Netherlands 2007] [342, GWAA Bremen 2005]

3.3.4 Use of production residues such as waste and by-products in the sinter plant

Description

The utilisation of residues is an important function of the sinter plant in an integrated steelworks. Residues generated consist mainly of iron scale from the rolling mills and a wide variety of dusts and sludges including those from waste gas treatment devices. Whenever these dusts, sludges and mill scale have a high enough iron or carbon content (or other mineral content, e.g. lime, magnesia), they can be considered for use as a raw material in the sinter

plant. Materials with a high lime content, such as the case with many steel slags, may also be accepted, reducing the supplementary lime and limestone input. There may be process restrictions on the use of residue materials in the sinter plant other than those associated with the cross-media effects reported below. These restrictions are related to the negative impact that some elements have on the smooth operation of the blast furnace. Therefore, dependent upon the make-up of the blast furnace burden, restrictions may be applied to the zinc, lead and chloride content of the sinter, thereby limiting the extent of residue usage at the sinter plant. At the time of writing (2010), nearly all sinter plants in the world utilise some dusts, sludges and mill scale. In most EU plants these account for 5 – 6 % of the sinter feed although rates of up to 10 – 20 % can be found. In at least two plants, 100 % of the dusts, sludges, slags and additives are used.

Achieved environmental benefits

The amount of raw material saved is equal to the amount of sludges, dusts and mill scale used. Furthermore, disposal of these residues is avoided.

Cross-media effects

Some process residues have a significant oil content, which may lead to higher emissions of some volatile organic compounds (e.g. hydrocarbons, PCDD/F). Using residues which contain significant amounts of volatile heavy metals (e.g. Hg, Cd) can lead to an increase in the emissions of these metals. The recirculation of certain residues can also contribute to the increase of these metals in the waste gas. Furthermore, undesired components such as alkalis and chlorides may accumulate in the sinter process and as a result may increase waste gas emissions (e.g. increase particulate loadings at the abatement equipment). To avoid these problems, sometimes the abatement equipment is improved (e.g. bag filter or improved/advanced ESP techniques) to cope with the use of the required amounts of waste/residues material [247, Netherlands 2007] [248, Eurofer 2007] [302, Eurofer 2007].

The recycling of precipitated sinter dust may have the effect of increasing the PCDD/F air emissions due to the recycling of dioxin de novo catalysts and chlorine [224, Xhrouet 2002] [255, Kasai et al. 2001]. Bag filter/ESP dust contaminated with PCDD/F recycled back to the sinter bed does not increase the concentration of PCDD/F in the subsequently precipitated bag filter/ESP dust [255, Kasai et al. 2001].

Operational data

No data submitted.

Applicability

This technique can be applied at new and existing plants.

Economics

With the technique described here, raw material costs are saved and disposal costs (including pretreatment) are avoided.

Driving Force for Implementation

The most important driving forces for the implementation of this technique are the maximisation of residue utilisation in the interest of sustainable consumption, thereby minimising the use of virgin raw materials and in many cases practical disposal options are limited and/or costly [302, Eurofer 2007].

Example plants

Almost all sinter plants around the world utilise sludges, dusts and mill scale arising in the integrated steelworks. The sinter plant at DK Recycling, Duisburg, Germany has been specifically designed to treat production residues from iron and steel making operations and is integrated into a blast furnace route to recover the valuable iron units together with the zinc and lead-rich dusts and sludges that can be utilised in the non-ferrous metal industry.

Reference literature

[65, InfoMil 1997] [116, Rentz et al. 1996] [224, Xhrouet 2002] [247, Netherlands 2007] [248, Eurofer 2007] [255, Kasai et al. 2001] [302, Eurofer 2007] [317, Endemann, G. et al 2006]

3.3.5 Heat recovery in the sinter process

3.3.5.1 Heat recovery from sintering and sinter cooling

Description

Two kinds of potentially reusable waste energies are discharged from the sinter plants:

- a) the sensible heat from the main exhaust gas from the sintering machines
- b) the sensible heat of the cooling air from the sinter cooler.

Concerning item a), under normal operating conditions, the use of a heat exchanger to recover heat from the waste process gases would result in unacceptable condensation and corrosion problems. These constraints have meant that the recovery of heat from the waste gases by means of a heat exchanger has not been practised.

Partial waste gas recirculation is a special case of heat recovery and is dealt with in Section 3.3.5.2. The sensible heat is transferred directly back to the sinter bed by the hot recirculated gases. At the time of writing (2010), this is the only practical method of recovering heat from the waste gases.

Concerning item b), the sensible heat in the hot air from the sinter cooler can be recovered by one or more of the following ways:

- steam generation in a waste heat boiler for use in the iron and steel works
- hot water generation for district heating
- preheating combustion air in the ignition hood of the sinter plant (see Figure 3.20)
- preheating the sinter raw mix
- use of the sinter cooler gases in a waste gas recirculation system.

The amount of waste heat recovered can be influenced by the design of the sinter plant and the heat recovery system.

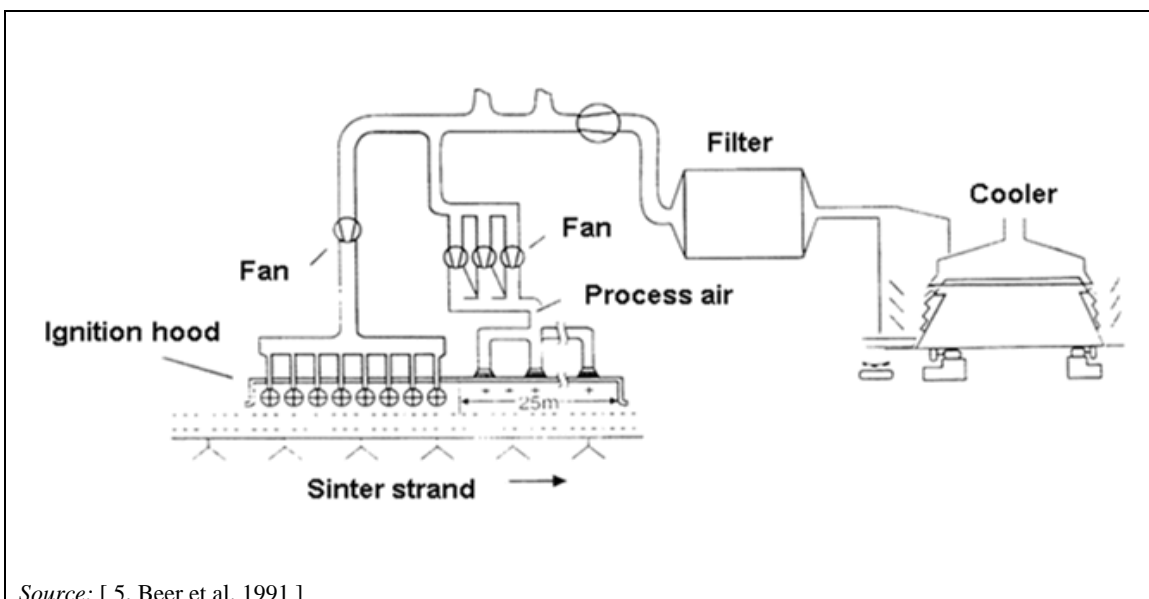

Source: [5, Beer et al. 1991]

Figure 3.20: Heat recovery from cooling air from the sinter cooler

Five different examples of heat recovery are given below:

1. Sinter cooler waste heat recovery with conventional sintering

The sensible heat of the sinter cooling hot air gas is used for producing steam in a waste heat boiler and for preheating the combustion air in the ignition hoods.

Achieved environmental benefits

Reported energy recovery amounts to 18 % of the total energy input for the waste heat boiler and 2.2 % of total energy input for recirculation to the ignition hoods [65, InfoMil 1997].

Operational data

No data submitted.

2. Sinter cooler and waste gas heat recovery with sectional waste gas recirculation

At sinter plant No 3 at Sumitomo Heavy Industries, Kokura, Japan, sectional waste gas recirculation is applied. Before recirculation, the waste gases are led through a waste heat boiler. The gases from the sinter cooler are also led through a waste heat boiler.

Achieved environmental benefits

Energy recovery reported at this plant by means of this system is 23.1 % of the energy input.

Operational data

120 kg steam/t sinter was produced at a temperature of 273 °C and at a pressure of 9 bar [123, SHI 1987].

3. Sinter cooler waste heat recovery to the sinter bed with waste gas recirculation

At sinter plant No 5 of Voestalpine, Linz, Austria, waste heat recovery from the sinter cooler is achieved through the EPOSINT process (see Section 3.3.5.2.1). When a waste gas recirculation system is used, the hot air from the cooler can be used instead of a fresh air addition to raise the oxygen content of the recycled gases returned to the sinter bed. Under these circumstances, the heat contained in the sinter cooler gases is recovered in the sintering process. A small proportion of the hot air from the cooler may also be used to preheat the ignition air in the ignition hood.

Achieved environmental benefits

A specific reduction of 2 – 5 kg coke/t sinter was achieved at Voestalpine Linz, Austria.

Operational data

No data submitted.

4. Strand cooling and waste heat recovery with partial waste gas recirculation

At the sinter plant No 4 at Sumitomo Heavy Industries in Wakayama, Japan, the sinter cooler is integrated into the sinter strand (strand cooling). At this plant, waste gases from both the sintering and the cooling zone on the grate are led through waste heat boilers and subsequently recirculated to the strand.

Achieved environmental benefits

Recovered heat amounts to 30 % of the input heat.

Operational data

Approximately 120 kg steam/t sinter is produced at a pressure of 25 bar and a temperature of 375 °C. The plant is designed for a sinter production of 10 000 t/day and has a sinter area of 360 m² [123, SHI 1987], but productivity could be adversely affected if the system were applied to an existing plant operating at or near maximum output.

5. Sinter cooler heat recovery for district heating

At sinter plant No 3 at ArcelorMittal, Dunkirk, France, the sinter cooler hot air is collected and sold to a partner who transforms the heat into hot water (105 °C), which is delivered by pipelines to the city for district heating.

Achieved environmental benefits

Approximately 15 kW/t sinter are recovered.

Operational data

No data submitted.

Achieved environmental benefits

CO₂ emissions may be prevented by replacing fossil fuels where the cooler waste gases are used for district heating energy production.

Cross-media effects

In some cases, emissions of dust are reduced, due to the preinstalled coarse dust separators. The use of the sinter cooler waste gases in a waste gas recirculation system will result in a reduction in diffuse dust emissions from the sinter cooler.

Applicability

Waste heat recovery from the stack or sinter cooling can be applied both at new and existing plants. It is recognised, however, that investments are lower for a new plant incorporating heat recovery systems from the planning stage, but at some existing plants, the existing configuration may make costs very high. In 1995, it was reported that 64 % of the Japanese sinter plants had heat recovery from sinter cooling and 43 % of the Japanese sinter plants applied waste heat recovery from the stack.

Economics

Investments will be site-specific. However, the application of waste heat recovery reduces operational costs.

Driving force for implementation

No data submitted.

Example plants

Heat recovery from sinter cooling is applied frequently in the EU (e.g. at Corus, IJmuiden, the Netherlands; Riva, Taranto, Italy; Thyssen Krupp Stahl, Duisburg, Germany).

Heat recovery from sinter cooler hot air has been practiced at ArcelorMittal Dunkirk, France, sinter plant No 3 since 1991. Three strands at Corus in the United Kingdom recover heat from the sinter cooler hot air.

At sinter plant No 5 of Voestalpine, Linz, Austria, waste heat recovery from the sinter cooler has been implemented as part of the EPOSINT process since April 2005.

Reference literature

[1, Arimitsu 1995] [65, InfoMil 1997] [103, OECD 1988] [123, SHI 1987] [305, Eurofer 2007] [241, Poland 2007]

3.3.5.2 Partial recycling of waste gas

In the partial recycling of waste gas, some portions of the sinter waste gas are recirculated to the sintering process. The fraction of the waste gas that is recirculated to the strand passes through the hot sinter and the flame front (see Figure 3.3). Various processes have been developed to

apply partial waste gas recirculation on an industrial scale. The following techniques included in Table 3.32 are included in this section:

Table 3.32: Partial waste gas recirculation techniques included in this section

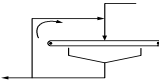
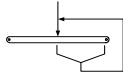
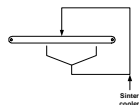
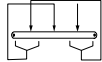
Section	Technology commercial name	Example of installation	Schematic diagram (arrows indicate gas flows)
3.3.5.2.1 Partial recycling of waste gas from the whole strand	Emission optimised sintering (EOS)	Corus IJmuiden, Netherlands	
3.3.5.2.2 Recycling of waste gas from the end sinter strand combined with heat exchange	Low emission and energy optimised sintering process (LEEP)	HKM, Germany	
3.3.5.2.3 Recycling of waste gas from part of the end sinter strand and use of waste gas from sinter cooler	Environmental process optimised sintering (EPOSINT)	Voestalpine Linz, Austria	
3.3.5.2.4 Recycling of parts of waste gas to other parts of the sinter strand		NSC, Tobata sinter plant No 2 in Japan	

Source: [307, Eurofer 2007].

General considerations on applicability

The applicability of this technique is site specific. The accompanying measures to ensure that sinter quality (here namely the cold mechanical strength) and strand productivity are not negatively affected must be considered on a case by case basis. Depending on local conditions, these can be relatively minor and easy to implement or, on the contrary, they can be of a more fundamental nature and may be costly and difficult to introduce. In any case, the operating conditions of the strand should be reviewed when this technique is introduced.

Important considerations in determining the applicability of this technique include:

- initial configuration of the strand (e.g. dual or single wind-box ducts, space available for new equipment and, when required, lengthening of the strand);
- initial design of the existing equipment (e.g. fans, gas cleaning and sinter screening and cooling devices);
- initial operating conditions (e.g. raw materials, layer height, suction pressure, percentage of quick lime in the mix, specific flow rate, percentage of in-plant reverts returned in the feed);
- existing performance in terms of productivity and solid fuel consumption;
- basicity index of the sinter and composition of the burden at the blast furnace (e.g. percentage of sinter versus pellet in the burden, iron content of these components).

Introduction of this technique can decrease the operational flexibility of the strand. Indeed, a significant change in raw mix or operating conditions can substantially modify the profiles of the emissions along the strand and consequently compromise the adopted equilibrium for gas recirculation. Whilst this technique can contribute to reducing the mass emission footprint of the sinter plant (in terms of pollution loads), the concentration of certain substances can rise (e.g.

the acidic compounds) in the recirculated and the exhausted gases. With respect to acidic compounds, tight control of temperature, moisture and acid dew points are essential to prevent excessive corrosion.

All mentioned considerations are based on the experiences of three companies; in these specific cases of waste gas recirculation application described here below, the plants succeeded in overcoming the aforementioned constraints by countermeasures.

3.3.5.2.1 Partial recycling of waste gas from the whole strand

Description

The concept of this technique is to recycle a part of the mixed waste gas from the whole strand back to the entire surface of the strand (see Figure 3.21). The recycling rate of the sintering waste gas is of the order of 40 – 45 %, corresponding to a 14 – 15 % oxygen concentration in the wet gas/air mixture in the hood and resulting in a 45 – 50 % decrease of the waste gas flow emitted to the atmosphere.



Figure 3.21: Covered sinter strand according to the EOS process

The waste gas is dedusted in a cyclone before being recycled through an additional fan to the hood above the strand. Under these conditions, the strand productivity remains unchanged and the consumption of coke breeze is reduced by 10 – 15 % compared to conventional practice at Corus IJmuiden, the Netherlands. The sinter quality, defined as reduction disintegration, is constant, the FeO in the sinter increases by 1.5 %, reducibility increases, cold strength decreases slightly and the mean diameter remains approximately 17 mm. The use of the sinter produced in the blast furnace does not show any adverse effects but it should be noted that this sinter only accounts for about 50 % of the charge because of the high percentage of pellets used in blast furnaces at Corus, IJmuiden, the Netherlands. Elsewhere, the level of sinter used in the blast furnace burden can be much higher (up to 95 %).

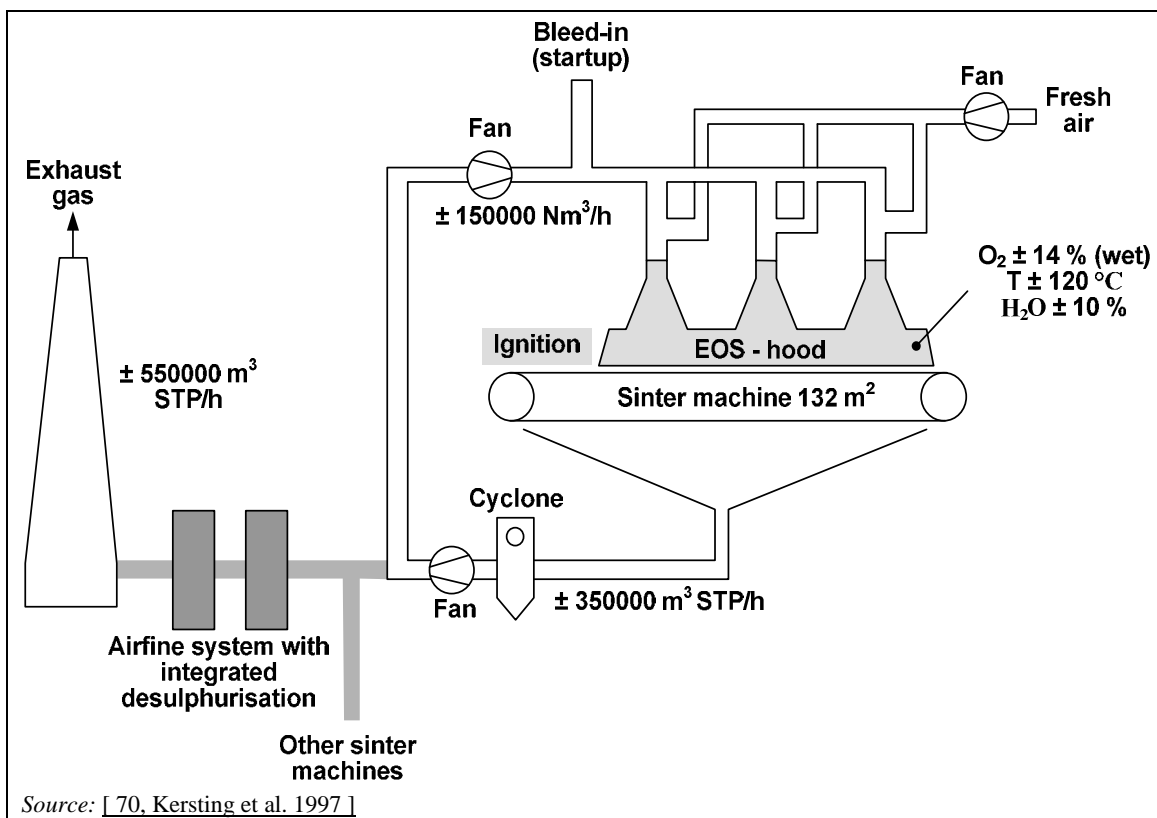

Figure 3.22: Schematic diagram of the emission optimised sintering (EOS) process

Achieved environmental benefits

Partial recycling of waste gas from the whole strand was primarily developed to reduce waste gas flow and thus the mass emissions of dust and PCDD/F with the benefit that additional abatement equipment to further treat the waste gas before discharge to the atmosphere would have to treat lower volumes, with implied capital and operational cost savings. Prior to the installation of this system at the plant in Netherlands, the end-of-pipe abatement technique used was a cyclone and it was inevitable that additional abatement equipment would also be required (see Section 3.3.2.4). The results from this particular commercial plant for high basicity sinter (≥ 1.7 CaO/SiO₂) indicate that successful implementation of this technique is possible (see Table 3.33). The results for sinter with low basicity are similar.

Table 3.33: Comparison of characteristics and emission values of conventional sintering and emission optimised sintering at a sinter strand at Corus, IJmuiden, the Netherlands

Component	Unit	Conventional sintering		Emission optimised sintering (EOS)	
		July 1994	October 1994	July 1994	October 1994
Total gas flow	Nm ³ /h	394000	372000	328000	328000
Recirculation flow	Nm ³ /h	0	0	153000	120000
Emitted waste gas flow	Nm ³ /h	394000	372000	175000	208000
Temperature	°C	164	114	155	149
Percentage of moisture	%	10	11	16	19
Acid dew point	°C	46±5	ND	71±5	ND
Dust ⁽¹⁾	g/t sinter	500	ND	170	ND
O ₂	%	15	15	11.5	12.1
CO ₂	%	7.5	7	11.7	11.2
CO	%	1	1.2	1	1
SO ₂	g/t sinter	1430	890	840	680
NO _x	g/t sinter	630	570	300	410
C _x H _y	g/t sinter	200	145	95	83
PCDD/F	µg I-TEQ/t sinter	2	ND	0.6	ND

⁽¹⁾ In 1994 the particulate emissions were abated by cyclones only.
 NB: — The suction area of 132 m² and a production of 4700 t high basicity sinter/d.
 — ND = No data.
 Source: [104, te Lindert et al. 1997].

The emission reductions (by mass) resulting from the application of this technique at Corus IJmuiden are given in Table 3.34.

Table 3.34: Reported emission reduction (by mass) of emission optimised sintering (EOS) at Corus, IJmuiden, the Netherlands

Parameter	Emission reduction ⁽¹⁾ (mass %)	
	Low basicity sinter	High basicity sinter
Waste gas flow	40	40 – 50
Dust	50	60
Carbon monoxide (CO)	45	50
SO ₂	NA	15 – 20
NO _x	35	30 – 45
Hydrocarbons (C _x H _y)	NA	50
PCDD/F	70	65

⁽¹⁾ Emissions reduction is expressed as a mass flow reduction of the component.
 This does not necessarily imply a reduction in concentration.
 NB:NA = Not available.
 Source: [104, te Lindert et al. 1997].

This technique allows for the consumption of coke breeze to be reduced from 60 kg/t sinter to 48 kg/t sinter. This significant savings in thermal energy in the Dutch plant described above is not necessarily transferable to other plants because they may already be operating at low thermal energy inputs from the solid fuels as a result of the application of process optimisation measures. Data from the European Blast Furnace Committee survey of the operational data for sinter plants (1996), clearly demonstrate that many European plants already operate at significantly lower levels.

The application of EOS requires the installation of extra suction fans. This will result in an additionally installed electric capacity of 200 to 400 kW, amounting to an increase in energy consumption by 3 – 8 MJ/t sinter, which is low compared to the overall potential savings.

Cross-media effects

This technique reduces both emissions to air and the energy consumption of the sintering process. The additional suction fans increase electricity consumption, but this increase is negligible compared to the savings in coke breeze. Special attention need to be paid to carbon monoxide (CO) in the recirculated waste gas in order to prevent carbon monoxide poisoning of employees.

Operational data

This technique first came into operation in the EU in May 1994 on sinter strand 31 of the Corus, IJmuiden, the Netherlands sinter plant. Now, EOS is being used at all three sinter strands at the plant. To date, availability of the system has been >95 %. In case of failure, the system is automatically switched to conventional sintering.

Applicability

This technique can be applied at both new and existing plants although it is recognised that investment costs are lower in the case of new plants incorporating the system from the planning stage, than at some existing plants which may have considerably higher costs due to plant design. In existing plants, it may not be possible to install a partial recycling of waste gas due to space restrictions. The application of waste gas recirculation requires special efforts to ensure that the sinter quality and productivity are not affected negatively (see Section 3.3.5.2).

Economics

The investment required to implement this technique at the sinter plant at Corus, IJmuiden, the Netherlands with a total conventional waste gas flow of approximately 1.2 million Nm³/h from three sinter strands was EUR 17 million. Operational costs were decreased compared to conventional sintering due to a reduced input of coke breeze. Operational savings are estimated at EUR 2.5 million/yr. This figure is based on a reduced consumption of coke breeze by 6 kg/t sinter, at a price of EUR 100/t coke breeze and sinter production of 4.2 Mt/yr. These figures may be exceptional and may not be possible to achieve at many other EU sinter plants, particularly those already operating at significantly lower solid fuel inputs than those quoted for Corus, IJmuiden, the Netherlands (see above). It should also be stressed that the estimated average price of the coke breeze used at other EU sinter plants is about 40 % cheaper, rendering any possible coke breeze savings less economically attractive. However, the smaller volume of waste gases emitted from the sinter strand following the application of waste gas recirculation means the cost of end-of-pipe abatement will be reduced.

For all examples, the currencies have been converted into ECU in 1996 and for the review into EUR.

Driving force for implementation

The most important driving forces for implementation have been stringent requirements and emission standards laid down by authorities.

Example plants

Corus, IJmuiden, the Netherlands. All sinter production at this plant is, at the time of writing (2010), performed with this technique. Other examples outside of the EU (such as the US) have also implemented this technique.

Reference literature

[49, Goverde et al. 1995] [104, te Lindert et al. 1997] [252, France 2007] [254, Eurofer 2007] [307, Eurofer 2007]

3.3.5.2.2 Recycling of waste gas from the end sinter strand combined with heat exchange

Description

Due to the nature of the sintering process, the concentrations of the various waste gas components show no homogeneous distribution over the length of the sinter strand (see Figure 3.5, Figure 3.7 and Figure 3.12). The first half of the process mainly extracts the water content from the ore mix. In the second half, higher concentrations of sulphur oxides, chlorine compounds and PCDD/F are present. The amounts of carbon monoxide and carbon dioxide as well as oxides of nitrogen are evenly distributed between the two halves of the sinter strand. After the water has been removed half way along the sinter strand, the temperature of the waste gas increases in the second half of the strand until it reaches its maximum level in the area of the hot zone burn-through point.

In contrast to other techniques for the recycling of waste gas, this technique collects all waste gases of the second half of the strand. These gases are recirculated to the system across the entire length of the sinter strand. The oxygen remaining in the recycled gas provides most of the oxygen required to burn the fuel. When the waste gas is recirculated, the dust content is filtered out in the sintering bed, PCDD/F are partially destroyed, and sulphur oxides as well as chlorine compounds are adsorbed. The oxidation of the carbon monoxide in the recirculated gas in the flame front provides heat to the system, displacing some of the heat derived from the solid fuel addition and allowing the solid fuel rate to be reduced.

Due to the recirculation of the waste gas from the second section of the sinter strand, only the waste gas from the first half with the lower concentrations leaves the process through the stack. This significantly reduces the amount of waste gas and emissions. The emission concentrations are determined by the efficiency of the assimilation of the dust in the sinter bed, the adsorption of species such as chlorides and oxides of sulphur, and the oxidation of some species (e.g. CO, PCDD/F) as the recirculated gas passes through the flame front.

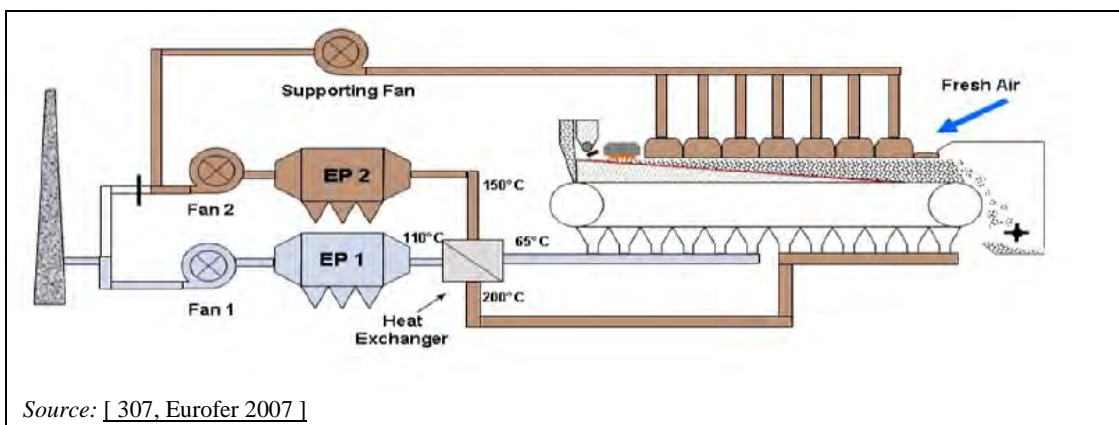

Figure 3.23: Low emission and energy optimised sintering process (LEEP) developed by Hüttenwerke Krupp Mannesmann

Before the two gas streams enter one of the ESPs, they flow through a gas/gas heat exchanger. The levelling of the temperatures of the gas stream (before the heat exchanger: 200/65 °C, after the heat exchanger: 150/110 °C) allows the existing exhaust fans to work at the same operating points as in the conventional sintering process. Furthermore, the area where the colder gas of the first strand section reaches dew point is restricted to the gas tubes located before the heat exchanger. The temperature levels in all additional gas tubes exceed the acid dew point. The cooling of the hot gases that circulate with temperatures of about 150 °C also guarantees that the quality properties of the sinter are maintained.

After the waste gases have passed through the ESPs and the exhaust fans, the recirculating process gas is blown back to the sinter strand via an additional speed-controlled supporting fan. The exhaust from the first strand section is emitted to the atmosphere through the stack.

Achieved environmental benefits

With the LEEP technique, the abatements of specific mass emissions shown in Table 3.35 can be achieved compared to a conventional sintering process.

Table 3.35: Some environmental benefits achieved with LEEP compared to a conventional sintering process

Parameter	Reduction
Specific waste gas volume per tonne of sinter	Approximately 50 % at the stack
Dust emissions from the sinter strand	50 – 55 %
SO ₂ emissions	27 – 35 %
NO _x emissions	25 – 50 %
CO emissions	50 – 55 %
HF emissions	50 %
HCl emissions	50 %
PCDD/F emissions	Approximately 75 – 85 %
Solid fuel	Approximately 5 – 7 kg/t sinter gives a reduction of CO and CO ₂
NB: The energy contained in the coke breeze saved is equivalent to the energy content of the recycled gas. 10 MJ/t of sinter of electrical energy are required to operate the supporting fan, resulting in a total reduction of the energy requirement of 213 MJ/t of sinter or 12.5 %.	
<i>Source: [307, Eurofer 2007] [374, Eisen, H.-P. et al 2004].</i>	

Cross-media effects

There is a slight increase in the use of electrical energy from the additional fan. Special attention must be paid to CO in the recirculated waste gas in order to prevent carbon monoxide poisoning of employees.

Operational data

When this technique was used the first few times, a reduction in productivity was observed. At the time of writing (2010) the same level of productivity is attained, compared to conventional sintering. In the future, higher productivity is expected following changes to the ignition furnace, the addition of O₂, the increase in the sinter basicity and by reducing the amount of false air. Compared with conventionally produced sinter, the sinter quality with LEEP shows the same level of grain size and strength and reducibility and a better performance for low temperature breakdown.

The sinter plant of Hüttenwerke Krupp Mannesmann has a suction area of 420 m². The strand has two waste gas mains parallel to the sinter strand. In order to separate the two exhaust zones, a partition has been installed to separate one waste gas main completely from the rear area of the sinter strand, ensuring that this main only extracts the air in the first half of the strand. Shutters separate the windboxes of the front strand section from the second exhaust main, ensuring that this main only collects the exhaust from the rear section of the strand. Since operating conditions can change, four windboxes (from a total of 29) in the middle section of the sinter strand can be optionally integrated either into the circulation or the exhaust gas circuit.

Applicability

This technique can be implemented in new and existing sinter plants. In existing plants, it may not be possible to install a partial recycling of waste gas due to space restrictions. If the existing sinter plant has two separate waste gas mains, there is an advantage as illustrated by Hüttenwerke Krupp Mannesmann, where the original main blowers and ESPs were able to be

retained. The application of waste gas recirculation requires special efforts to ensure that the sinter quality and productivity are not affected negatively (see Section 3.3.5.2).

Economics

With an investment of EUR 14 million, solid fuel consumption is reduced by 5 – 7 kg solid fuel/t sinter (12.5 % of the fuel demand) with a corresponding savings in operational cost.

Driving force for implementation

No data submitted.

Example plants

This technique has been in operation since December 2001 at Hüttenwerke Krupp Mannesmann, Duisburg-Huckingen, Germany.

Reference literature

[277, Wiesenberger 2007] [295, Hartig et al. 2006] [307, Eurofer 2007]

3.3.5.2.3 Recycling of waste gas from part of the end sinter strand and use of waste gas from the sinter cooler

Description

Selective waste gas recirculation in the EPOSINT process (environmentally process optimised sintering) takes advantage of the fact that the release of particulate and other species from the sinter bed tend to be more concentrated in those windboxes towards the discharge end of the sinter strand where the waste gas temperature rise shows a rapid acceleration (see Figure 3.7, for example). Those windboxes are selected for waste gas recycling where the burn-through is at or near the bottom of the bed. It was established that the temperature of the recycled gas should be the same as the gas led to the waste gas stack to avoid corrosion problems in resulting gases at temperatures below the acid dew point. At the Voestalpine Stahl sinter plant in Linz, Austria, Windboxes 11 to 16 of the newly extended strand were found to be the most suited for waste gas recycling. This is shown schematically in Figure 3.24. A second suction fan is installed parallel to the existing process fan to ensure that the suction pressure for sintering can be maintained. This fan is designed to take the waste gases from the selected windboxes and recycle it via an ESP to the recirculation gas hood.

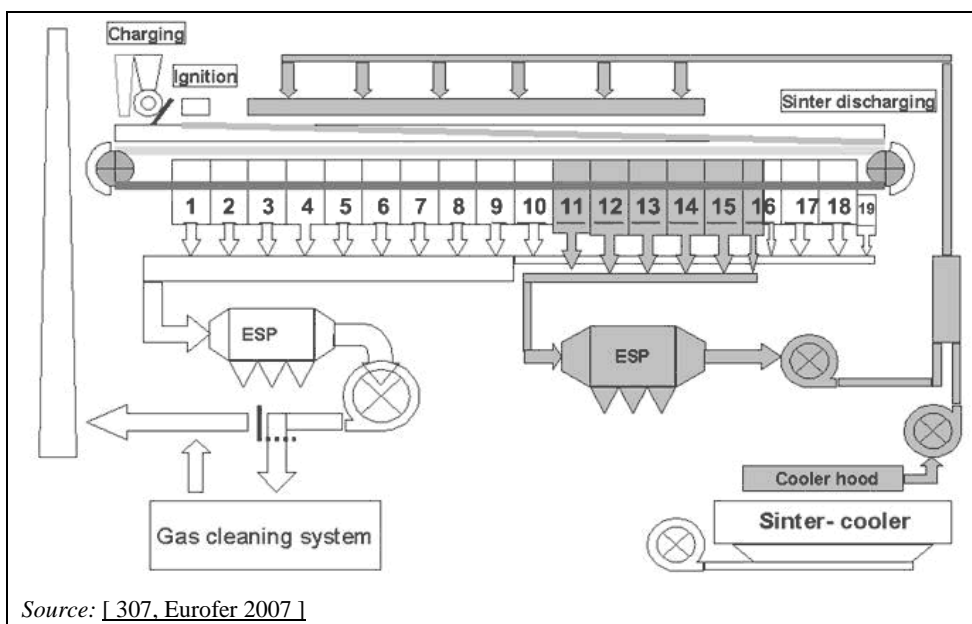

Figure 3.24: Schematic diagram of the EPOSINT gas recycling technique installed at sinter strand No 5 of Voestalpine, Linz, Austria

The area in which the temperature increases may vary along the strand length dependent upon the sinter mix and other operational considerations. A feature of this process is the ability to divert the waste gases from the individual windboxes in the range 11 to 16 independently to the stack or to the recirculation hood. This feature gives the process a high degree of flexibility.

To overcome the problem of oxygen deficiency in the recirculated gases, the hot exhaust gases from the sinter cooler are returned to the system via another fan, a gas mixing chamber and the recirculation hood. Not only does this have the effect of boosting the oxygen level in the recirculation hood to help ensure that sinter quality can be maintained, but it also increases the potential to reduce the coke rate by increasing the gas temperature and decreasing the diffuse particulate emissions from the cooler.

The hood structure covers the entire width of the strand and is sealed to the pallet sidewalls through a non-contact, narrow gap labyrinth seal preventing the unintentional release of the recirculated gas and dust particles. Since the entire pallet structure is not enclosed, the pallet wheels, etc. are able to operate in a clean atmosphere eliminating wear/failure from dust ingress to the bearings. The seal provides security against the escape of the recirculated gas which contains CO and special measures are in place to prevent escapes due to plant or instrument failures. The hood structure does not extend across the whole length of the strand (see Figure 3.24), allowing cold air to be drawn through the sinter bed in the last few windboxes. This helps to ensure that the sinter is adequately cooled on the strand prior to the cooler and facilitates the ease of removal of pallets as necessary from time to time for maintenance purposes.

Some characteristics of the EPOSINT application include the following:

- the recirculation of a part of the waste gas is selective from the field of rising temperature, where all relevant emissions are higher than the average values
- the recirculation leads to a reduction in coke breeze consumption and waste gas volume
- the gas recycling hood covers the sinter strand width
- the gas recycling hood does not cover the whole suction area
- due to the low O₂ concentration in the recirculated waste gas, in combination with a high efficient sealing system of the hood to minimise false air, additional air from the sinter cooler is used. To ensure that there are no negative effects on sinter production and sinter quality, the minimum O₂ concentration in the recirculated gas (i.e. process combustion air) is 13 %.

Achieved environmental benefits

Some environmental advantages of this technique are a decrease in energy consumption, up to 40 % reduction in off-gas volume and a decrease in coke consumption. Recirculation of sinter waste gas (also used in the case of the techniques described in Sections 3.3.5.2.1 and 3.3.5.2.4) reduces the emissions of NO_x and PCDD/F due to their decomposition in the sinter bed. SO_x is also absorbed or filtered by the sinter layer and the CO is used as fuel. With this gas recirculation technique, not only is a significant reduction of waste gas volume achieved, but particulate and gaseous emissions reductions are also achieved and the abatement of diffuse dust emissions of the sinter cooler is also realised. Table 3.36 shows the benefit from the application of the selective waste gas recirculation technique in percentages for certain parameters.

Table 3.36: Main environmental benefits of the application of the sectional waste gas recirculation technique

Parameter	Reduction
Waste gas volume per tonne of sinter	Decrease of about 25 – 28 % at the stack
Dust emissions ⁽¹⁾	Decrease of 30 – 35 %
Dust emissions from the sinter cooler	85 – 90 %
Particulate heavy metals	About 30 – 35 % ⁽⁵⁾
SO ₂ emissions	About 25 – 30 %
NO _x emissions ⁽²⁾	About 25 – 30 %
PCDD/F emissions ⁽³⁾	Can be reduced by about 30 %
CO emissions	Can be reduced by about 30 %
Coke breeze consumption ⁽⁴⁾	About 2 – 5 kg per tonne of sinter
⁽¹⁾ Dust emissions abatement is higher than that of gas volume, due to a recirculation of a gas stream with a very high dust concentration and a cleaning of this gas stream with an ESP. ⁽²⁾ The recirculated gas stream has a relatively high NO _x concentration, whereas the gas at the end of the sinter strand, with high O ₂ and low NO _x concentration is conducted to the stack. ⁽³⁾ The concentration in the waste gas in the last quarter of the sinter strand (part of the gas stream led to the stack) is low. ⁽⁴⁾ Without degradation of productivity and quality figures. ⁽⁵⁾ Corresponding to dust emission reduction. <i>Source: [307, Eurofer 2007].</i>	

Table 3.37 gives some operational data for the emissions concentrations and emissions factors before and after the application of the sectional waste gas recirculation technique for one plant in Austria.

Table 3.37: Operational data of the sinter plant before and after installation of sectional waste gas recirculation (2007, applying Airfine for waste gas abatement)

Parameter	Units	Before installation enlargement	After enlargement (including the installation of selective waste gas recycling)
Sinter production	t/day	6350	8300 (8500 max.)
Fuel rate	kg/t sinter	45	41
Ignition gas	MJ/t sinter	50	40
Total electricity consumption (including waste gas treatment)	kWh/t sinter	40	40
Emissions after waste gas treatment			
Dust emissions	mg/m ³	46	38
	g/t sinter	104	66
SO ₂ emission	mg/m ³	420	390
	g/t sinter	952	677
NO _x	mg/m ³	240	240
	g/t sinter	544	416
HF	mg/m ³	1	0.6
	g/t sinter	2.3	1
<i>Source: [277, Wiesenberger 2007].</i>			

Cross-media effects

The additional electrical energy due to the additional fan is recouped through higher production and a decrease in the solid fuel requirement of 2 – 5 kg coke/t sinter. Special attention should be paid to carbon monoxide (CO) in the recirculated waste gas in order to prevent carbon monoxide poisoning of employees.

Operational data

Sinter strand No 5 of Voestalpine Stahl in Linz, Austria has operated with this technique since April 2005. The quality parameters for the sinter remained the same as before the installation of the technique. The reduction in coke breeze consumption is reported at 2 – 5 kg/t sinter (45 kg/t sinter to 40 kg/t sinter). There have been no reported problems associated specifically with the process. Some operational advantages of this technique are an increased sinter production per Nm³ off-gas and stable sinter quality and the capacity of existing sinter plants to be increased by approximately 40 % (e.g. by lengthening the sinter machine) without any increase in the sinter off-gas volume.

Applicability

Waste gas recirculation with this technique can be implemented in new and existing sinter plants. In existing plants, it may not be possible to install a partial recycling of waste gas due to space restrictions. In the Linz plant, it was possible to design the system so as to retain the existing waste gas system (i.e. collecting main, gas cleaning system, main fan and stack) that remained unmodified. The application of waste gas recirculation requires special efforts to ensure that the sinter quality and productivity are not affected negatively (see Section 3.3.5.2).

Economics

Investment costs for a suction area of 250 m² are about EUR 15 million. At the plant cited, the installation was particularly economic because no modifications had to be made to the existing waste gas system. A reduction in operating costs results from a decrease in fuel consumption of about 2 – 5 kg coke/t sinter and a minimisation of costs for waste gas cleaning due to a smaller gas volume, especially when using expensive gas cleaning systems such as fine wet scrubbers or bag filters with the addition of adsorbing agents.

The application of this technique lowers the investment and operational costs for modern waste gas cleaning facilities.

In 2007 the cost of a selective gas recirculation system for the ArcelorMittal, Ghent, Belgium sinter plants was estimated in 2007 at EUR 14 million for sinter plant 1 (175 m²) and EUR 27.3 million for sinter plant 2 (498 m²).

Driving force for implementation

No data submitted.

Example plants

This technique has been in operation since May 2005 at Voestalpine in Linz, Austria on sinter strand No 5 and has been upgraded from 56 to 74 m.

Reference literature

[217, Siemens-vai 2006] [277, Wiesenberger 2007] [295, Hartig et al. 2006] [307, Eurofer 2007]

3.3.5.2.4 Recycling of parts of waste gas to other parts of the sinter strand**Description**

The concept of the selective recycling technique is based on a local suction of the sintering waste gas under the strand and its local recycling above the sinter bed. This selective suction and recycling is the main difference between this and the emission optimised sintering (EOS) process. Figure 3.25 shows a schematic diagram of such a sectional waste gas recirculation implemented at a sinter plant in Japan.

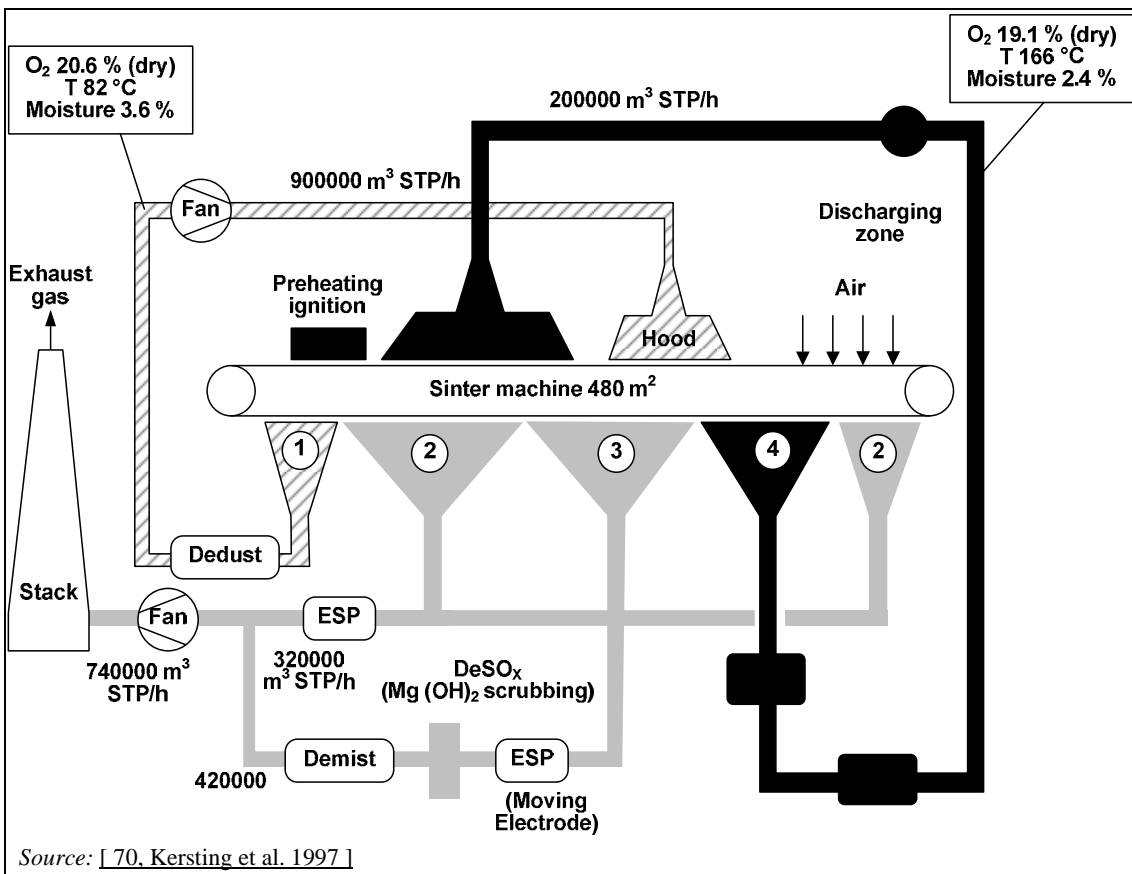

Figure 3.25: Schematic diagram of selective waste gas recirculation in sinter plant No 3 of Nippon Steel Corporation, Yawata Works, Tobata, Japan

In this case, the 480 m² sintering surface is divided into four different zones (see Figure 3.5 and Figure 3.7 and Table 3.38):

- Zone 1: gas corresponding to the preheating section of the raw mix to be recycled in the middle of the strand (high O₂, low H₂O, low temperature)
- Zone 2: gas low in SO₂ to be discharged at the stack after dedusting (low O₂, high H₂O, low temperature)
- Zone 3: gas rich in SO₂ to be discharged at the stack after dedusting and desulphurisation (scrubbing with a magnesium hydroxide solution, in this case) (low O₂, high H₂O, low temperature)
- Zone 4: gas rich in SO₂ corresponding to the hot section around the flame front, to be recycled in the first half of the strand just after the ignition zone (high O₂, low H₂O, very high temperature).

In this procedure, the O₂ concentration of the recycled waste gas remains high (19 %) and the moisture low (3.6 %). A recycling rate of 25 % is achieved without a negative impact on sinter quality (the RDI remains practically constant and the SI (shatter index) increases by 0.5 %). A solid fuel savings of 6 % is also reported.

There are two advantages to this system compared to conventional sintering:

1. The unused oxygen in the waste gas can be used effectively by recirculation.
2. The waste gas from the different sections can be treated separately depending on the composition of the gas. Thus, investments and operational costs of waste gas treatment facilities can be significantly reduced compared to conventional sintering even in comparison with the EOS system.

Table 3.38 shows the characteristics of waste gas flows using sectional waste gas recirculation in sinter plant No 3 of Nippon Steel Corporation, Yawata Works, Tobata, Japan.

Table 3.38: Characteristics of waste gas flows using sectional waste gas recirculation in sinter plant No 3 of Nippon Steel Corporation, Yawata Works, Tobata, Japan

Waste gas flow section	Waste gas composition					Waste gas treatment
	Flow (Nm ³ /h)	Temp. (°C)	O ₂ (vol-%)	H ₂ O (vol-%)	SO ₂ (mg/Nm ³)	
Windboxes 1 – 3	62000	82	20.6	3.6	0	Recirculated to the sinter strand
Windboxes 4 – 13 + 32	290000	99	11.4	13.2	21	Led to the stack after ESP
Windboxes 14 – 25	382000	125	14.0	13.0	1000	Led to the stack after ESP and desulphurisation
Windboxes 26 – 31	142000	166	19.1	2.4	900	Recirculated to the sinter strand
Stack	672000	95	12.9	13.0	15	Emission to air

Source: [119, Sakuragi et al. 1995].

Achieved environmental benefits

The following improvements have been achieved in terms of pollution abatement: a substantial decrease in the waste gas released into the atmosphere (about 28 %), in dust emissions (about 56 %). Note that this includes the effect of revamping the electrostatic precipitator, which is equipped with moving electrodes) and in SO₂ discharge (about 63 %, including the end-of-pipe desulphurisation of the gas arising from Zone 3). A slight decrease in the NO_x emissions (about 3 %) is also reported. Table 3.39 compares emissions before and after the application of sectional waste gas recirculation.

Table 3.39 gives a comparison of final waste gas composition before and after rebuild to sectional waste gas recirculation in sinter plant No 3 of Nippon Steel Corporation, Yawata Works, Tobata, Japan.

Table 3.39: Comparison of final waste gas composition before and after rebuild to sectional waste gas recirculation in sinter plant No 3 of Nippon Steel Corporation, Yawata Works, Tobata, Japan

Characteristic/ component	Unit	Conventional sintering (with desulphurisation plant)	Sintering with sectional waste gas recirculation	Improvement
Waste gas flow	Nm ³ /h	925000	665000	28 %
Dust ⁽¹⁾	mg/Nm ³	50	30 ⁽²⁾	56 % by mass
SO _x ⁽³⁾	mg/Nm ³	26	14	63 % by mass
NO _x	mg/Nm ³	408	559	3 % by mass
Net energy consumption	GJ/t sinter	1.662	1.570	6 % ⁽⁴⁾

⁽¹⁾ Waste gas treated by electrostatic precipitation.
⁽²⁾ Reduction in dust emissions partially achieved by repairing ESP.
⁽³⁾ Part of waste gas treated in desulphurisation unit.
⁽⁴⁾ This reduction in net energy consumption should be considered in relation to the relative productivity and quality requirements in Japan and the EU sinter plants.

Source: [119, Sakuragi et al. 1995].

Cross-media effects

The installation of additional fans results in more electricity being consumed. However, this increased energy demand is negligible compared to the decreased coke breeze consumption.

Operational data

A system using sectional waste gas recirculation was installed in the Tobata sinter plant No 3 at Nippon Steel Corporation's Yawata Works in October 1992. The waste gas is divided into four sections, each of which is treated separately. The system operates smoothly and waste gas recycling does not affect the sinter quality. However, this latter point should be considered in relation to the lower productivity of the cited Japanese plant when compared with many sinter plants in the EU.

Applicability

Sectional waste gas recirculation can be applied at both new and existing plants although it is recognised that investment costs would be lower for a new plant incorporating the system from the planning stage than at some existing plants which may have considerably higher costs due to plant design. In existing plants, it may not be possible to install a partial recycling of waste gas due to space restrictions. The application of waste gas recirculation requires special efforts to ensure that the sinter quality and productivity are not affected negatively (see Section 3.3.5.2).

Economics

European investment costs for the gas recycling system were quoted at EUR 8 million – 10 million in 1997, excluding the deNO_x, deSO_x and other abatement equipment. Operational costs were reported confidentially. A 6 % reduction in coke consumption was reported.

Driving force for implementation

No data submitted.

Example plants

There are five plants in Japan which apply this technique. The data given here refer to Tobata sinter plant No 3, Yawata Works, Nippon Steel Corporation.

Reference literature

[65, InfoMil 1997] [119, Sakuragi et al. 1995]

4 PELLETISATION PLANTS

[208, Lindfors et al. 2006] [318, Eurofer 2007]

As mentioned in Section 3.1.1, the pelletisation and sintering of iron ore are complementary process routes for the preparation of iron oxide raw materials for primary iron and steel making. Each has its own specific advantages and drawbacks. These are highly influenced by local conditions such as the availability and type of raw materials. For various reasons, sinter is practically always produced at the steelworks site: it allows solid wastes to be recycled; coke breeze is available at the steelworks for use as a fuel; sinter is prone to degradation during transport and handling. Pellets are formed from the raw materials – fine ore and additives of <0.05 mm – into 9 – 16 mm spheres using very high temperatures and this is mainly carried out at the site of the mine or its shipping port. In the EU, there is only one integrated steelworks which includes a pelletisation plant (in the Netherlands). In 2007, Sweden had five standalone pelletisation plants. Pellet production in these six plants in 2007 was about 27 million tonnes/yr. The consumption of pellets in the EU-25 is about 43 million tonnes.

4.1 Applied processes and techniques

Pellets are small, crystallised balls of iron ore with a size of 9 – 16 mm. Figure 4.1 shows the balling drum, which is part of a pelletisation plant.



Source: [200, Commission 2001] [318, Eurofer 2007]

Figure 4.1: Balling drum as part of a pelletisation plant where the green pellets are formed

The pelletisation process consists of grinding and drying or dewatering, wetting and mixing, balling and induration followed by screening and handling (see Figure 4.2).

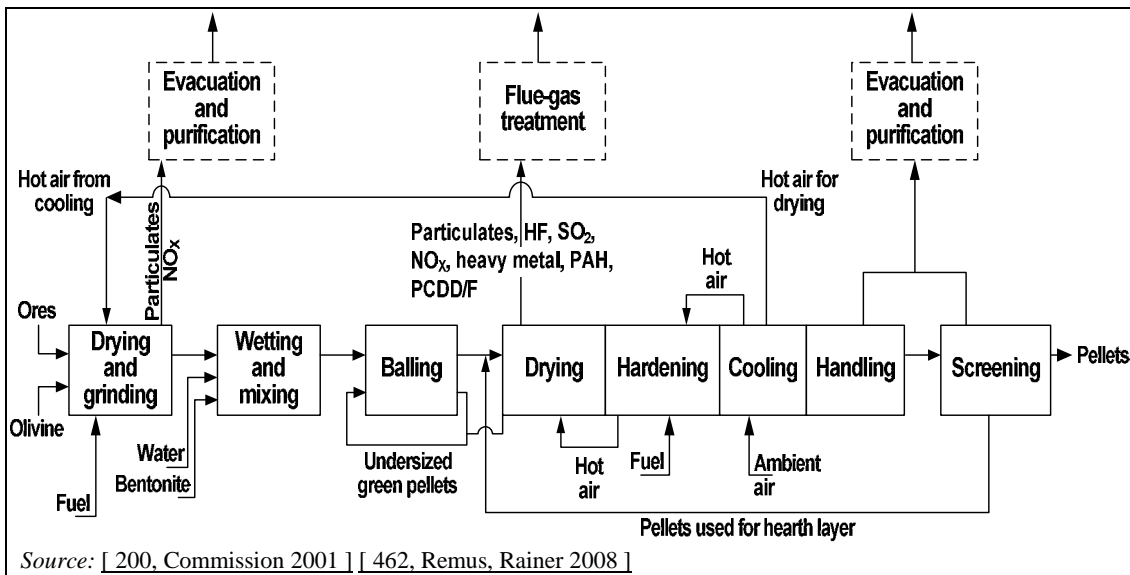

Figure 4.2: Schematic of the pelletisation plant in the Netherlands

4.1.1 Grinding and drying/dewatering

[208, Lindfors et al. 2006]

The Swedish pellet plants are generally situated at the mine site and ore beneficiation, including magnetic separation, is carried out ahead of the pelletising process. Since these processes are carried out wet, the final grinding prior to balling is also carried out wet (see Figure 4.3). Additives (olivine, dolomite, quartzite and/or limestone depending on the end-product) are

ground and then added to the ore slurry, typically at a level of 3 to 3.5 %, before dewatering. The binder is added at a mixing stage ahead of the balling process.

In contrast, the Dutch plant operates on imported ores that are blended ahead of the grinding process (unless the ore is already fine enough where it can bypass the grinding stage and join the flow sheet at the wetting and mixing stage (see Figure 4.2). The ores are dried and ground simultaneously together with compatible flux additions such as olivine. The heat for drying is mostly provided by a natural gas or BOF gas and oxygen burner and supplemental heat is supplied from the pellet cooling stage. The temperatures are approximately 100 °C.

The dry grinding mills at Corus IJmuiden are operated in a closed circuit with an air classifier system. The ground ore discharged from the mills is separated into two fractions by the air classifier, the oversized fraction is returned to the mill for further treatment while the fine, correctly sized particles are fed forward to the wetting and mixing stage. The very fine particles are captured in an electrostatic precipitator and are returned to the product stream, the ESP being an integral part of the classification system.

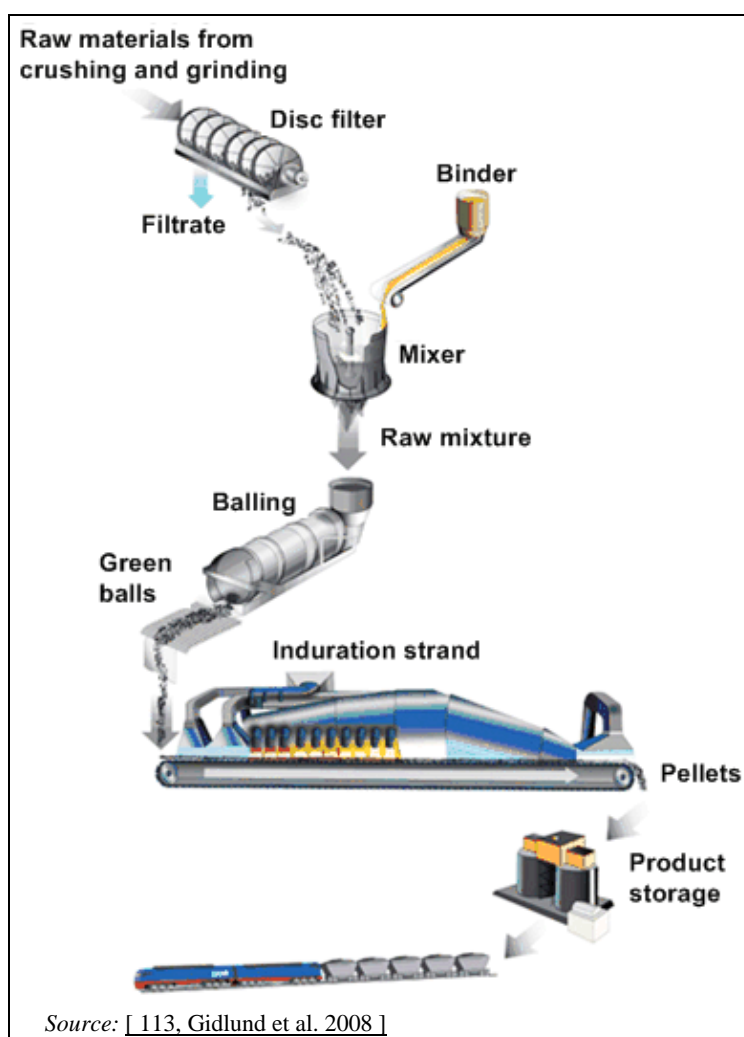

Figure 4.3: Schematic of a pelletisation plant with wet grinding

4.1.2 Green ball preparation

[318, Eurofer 2007]

After hot grinding, the material is combined with additives before being rewetted in a separate wetting stage and is mixed with a binder (bentonite or organic binder depending upon the type of pellet). At the mixing and wetting stage in the Dutch plant, additions of carefully sized solid fuel (coke breeze and/or anthracite) are made together with the bentonite binder.

In both the Swedish and the Dutch plants, the moisture level of the pellet mix going forward to the balling stage is between 7 – 9 %.

The moisture-adjusted pellet feed (raw mixture) is then processed in the (green) ball preparation plant. This is typically equipped with four to seven balling circuits consisting of a feed bin, balling drum, roller screens and conveyors for circulating the materials. The balling drum is inclined 6 to 8° to the horizontal plane. To obtain a well-defined green ball size, typically in the range of 9 to 16 mm, undersized and oversized fractions are screened off and recirculated within the balling stage.

4.1.3 Induration

[208, Lindfors et al. 2006]

Induration, which means thermal treatment, consisting of drying, heating and cooling can be carried out in two different systems: in 'straight grate' or 'grate kiln' systems. During thermal treatment, magnetite is almost completely oxidised to hematite. Swedish ores have a very high magnetite content. Since the oxidation of magnetite is exothermic this reaction can supply up to 60 % of the energy needed for pellet induration. The mixture of ores processed in the Dutch plant has a lower magnetite content (maximum 25 %) the actual amount being dependent upon the circumstances on the world market where there is a dearth of magnetite ores available. The addition of coke breeze and/or anthracite is made to the Dutch pellets in order to compensate for the lower magnetite content compared with the Swedish situation (see Table 4.1 for the information on the energy and fuel demand).

4.1.3.1 The straight grate process

[114, Remus, Rainer 2008] [318, Eurofer 2007]

The straight grate process consists of a travelling grate divided into a number of different sections for drying, preheating, firing and cooling of the green balls (see Figure 4.4).

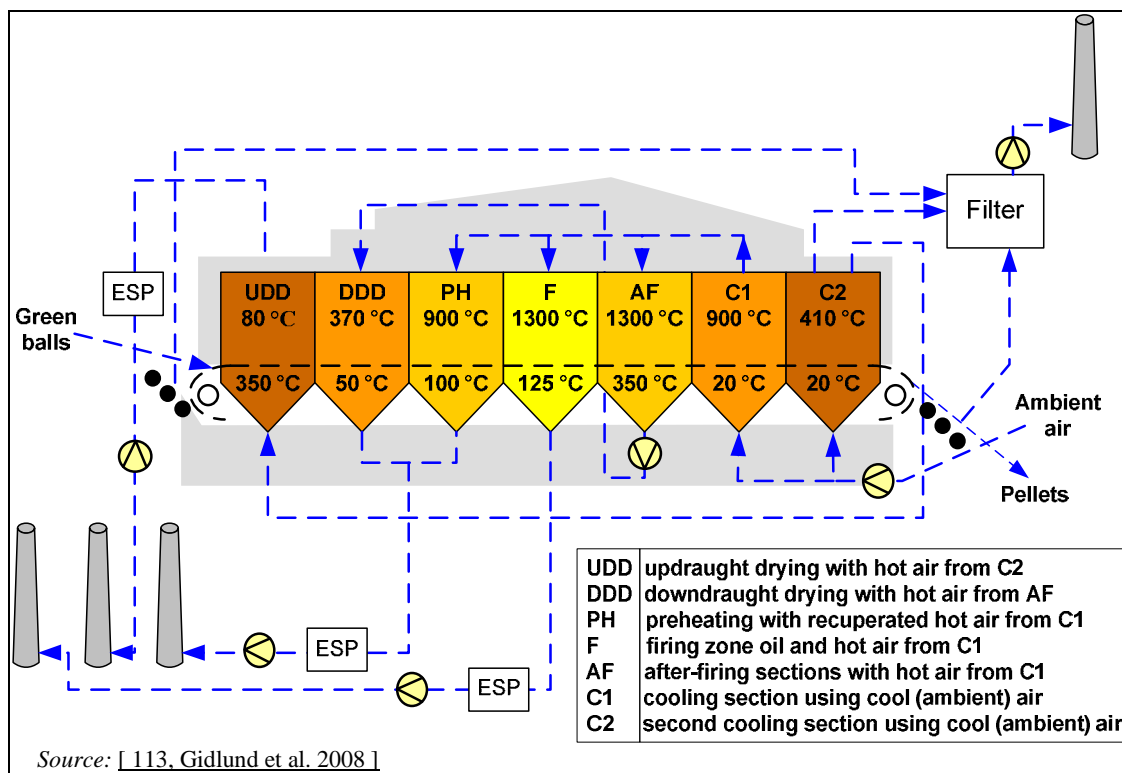

Figure 4.4: Schematic of the straight grate process

Before the green balls are fed onto the grate bars, the bars are covered with a 5 to 10 cm thick hearth layer of fired pellets. The green balls are then charged on top of the hearth layer to form a gas-permeable bed with a total depth of 40–55 cm. The green balls must be heated to approximately 1300–1350 °C during oxidation and sintering to obtain pellets of a high strength. This can be achieved by means of a row of burners on each side of the travelling grate, usually fired with oil or gas. In the Dutch plant at the steelworks site, COG is used to fire the burners whilst the coke breeze/anthracite added to the pellets provides additional internal heating (as does the oxidation of the magnetite in the Swedish pellet practice). At the end of the induration strand, a fraction of indurated pellets is recycled for use as the hearth layer.

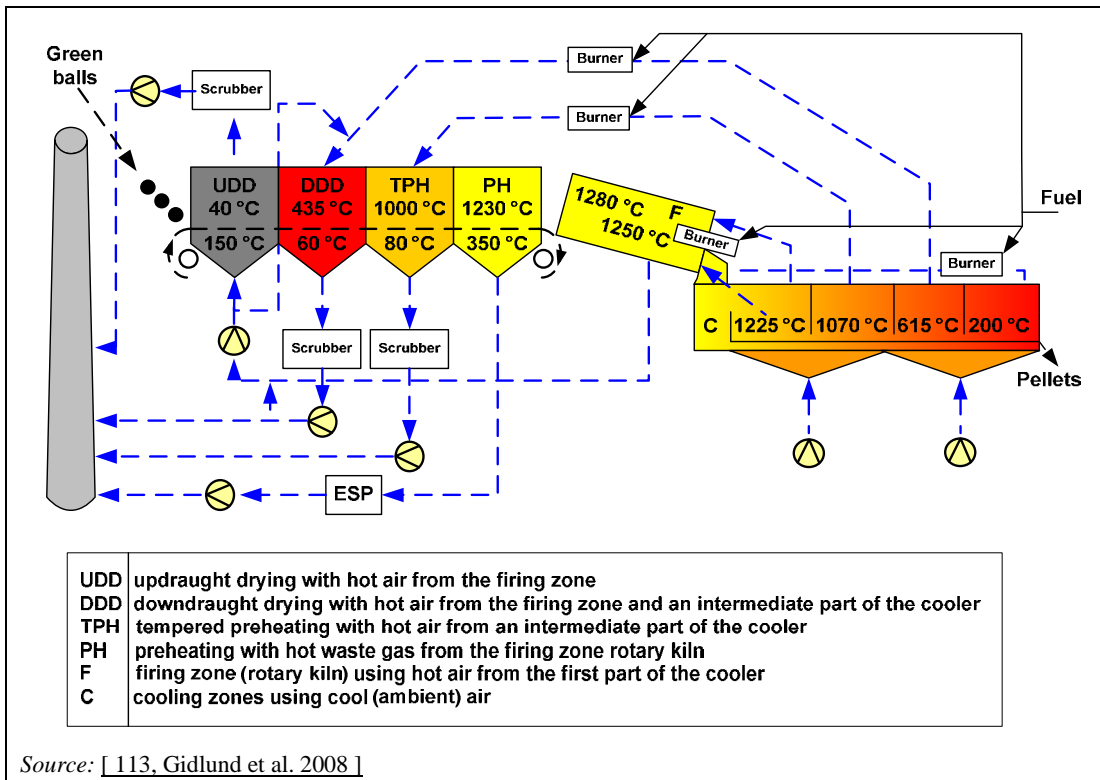

Figure 4.5: Schematic of the grate kiln process

4.1.3.2 The grate kiln process

[318, Eurofer 2007]

The grate kiln process consists of a travelling grate similar to the straight grate process. The firing takes place in a rotary kiln and the cooling is carried out in a separate annular cooler.

The travelling grate consists of an endless chain of grate plates which are connected with windboxes in a gas-tight manner. The green balls are fed directly onto the grate plates to create a bed of about 20 – 25 cm deep. After pretreatment on the grate, the pellets are charged via a chute to the rotary kiln. The kiln has a single oil-fired or coal-fired burner at the discharge end, and operates at a temperature of approximately 1250 °C. The annular cooler has a grate bottom which permits cool air to penetrate the pellet layer. Walls divide the cooler into sections so as to provide hot air to the earlier process steps.

When processing magnetite ores, oxidation to hematite and sintering takes place downstream of the preheating stage of the travelling grate, the firing zone and the cooling zones.

4.1.4 Screening and handling

[318, Eurofer 2007]

At the end of the induration strand, the pellets are collected and screened. Undersized or broken pellets can be recycled, e.g. as hearth layer (see Figure 4.2). Significant dust emissions may occur.

For the standalone plants in Sweden, the heat-treated pellets are kept in covered product bins before charging to open railway wagons for transportation to the harbours at Narvik and Luleå. In connection with ship loading, 2 – 3 % of the material is screened off as undersized, and is sold as sinter feed. As for all blast furnace material (coke, sinter, pellets and lump ore), a final screening takes place at the blast furnace site.

4.2 Current emission and consumption levels

4.2.1 Mass stream overview and input/output data

Figure 4.6 gives an overview of the input and output mass streams of a pelletisation plant. This overview may be used for the collection of data from single pelletisation plants.

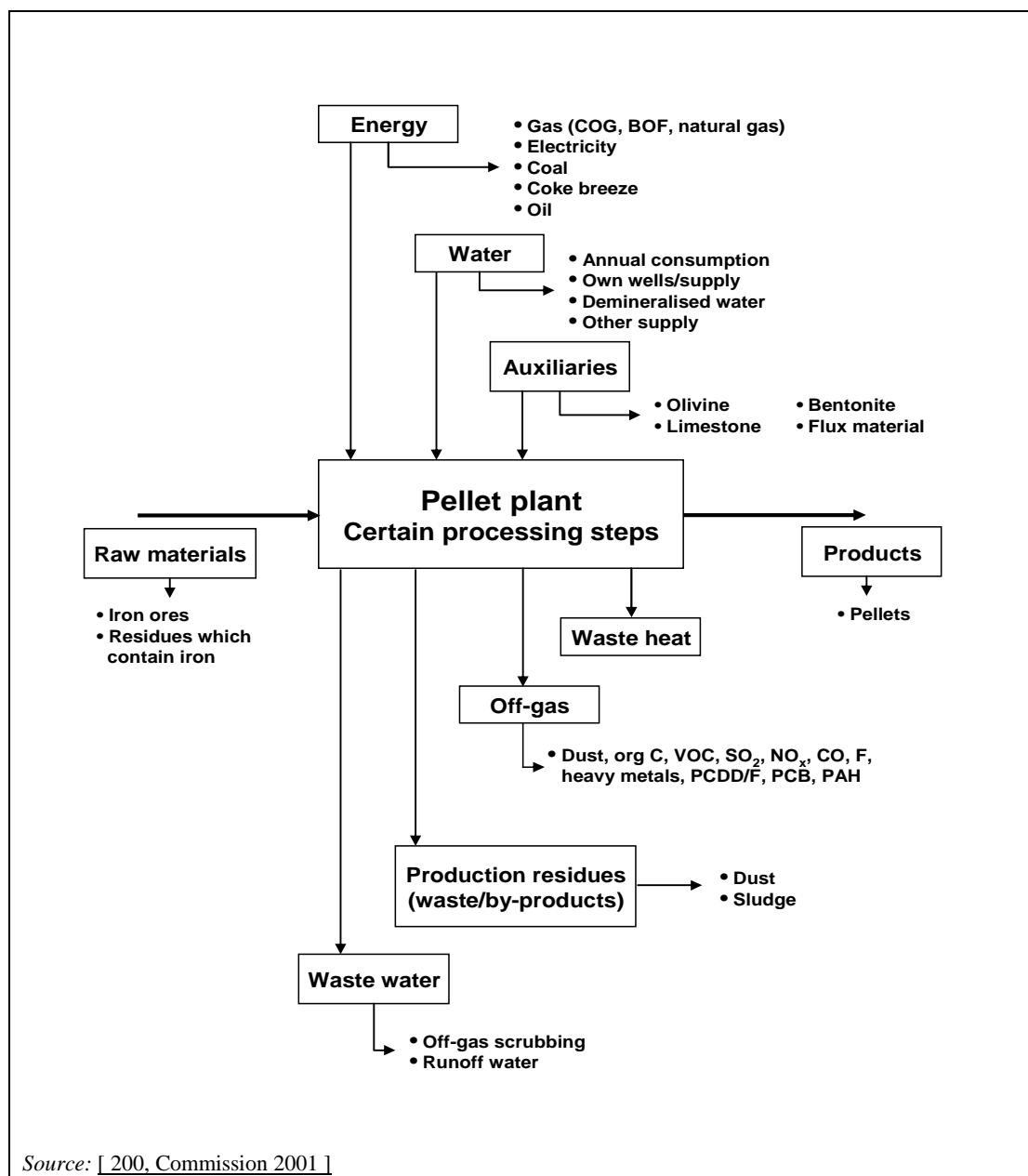

Figure 4.6: Mass stream overview of a pelletisation plant

Specific input factors and emission factors have been determined for pellet plants. Values of these factors from three pelletisation plants in the EU are shown in Table 4.1.

Table 4.1: Input/output data from three pellet plant sites in the EU-25

Input			Output		
Raw materials			Product		
Iron ore	kg/t	935 – 965	Pellets	kg/t	1000.00
Bentonite	kg/t	4.1 – 6.8			
Olivine ⁽¹⁾	kg/t	0 – 27.6	Emissions		
Limestone	kg/t	0 – 5	Waste gas flow	Nm ³ /t	1940 – 2400
Dolomite ⁽²⁾	kg/t	0 – 13.5	Dust	g/t	14 – 150
Quartzite	kg/t	0 – 20	Dust	mg/Nm ³	7 – 70
			Cd	mg/t	0.02 – 2.2
Energy			Cr	mg/t	5.1 – 22.4
COG/BOF ⁽³⁾	MJ/t	306	Cu	mg/t	1.5 – 6.7
Natural gas ⁽³⁾	MJ/t	14	Hg ⁽⁴⁾	mg/t	0.4 – 24.2
Coke breeze ⁽³⁾	MJ/t	342	Mn	mg/t	5.1 – 64.3
Coal ⁽⁵⁾	MJ/t	223	Ni	mg/t	6.5 – 12.7
Oil ⁽⁵⁾	MJ/t	43 – 186	Pb	mg/t	15.6 – 70.8
Electricity	MJ/t	54 – 99	Tl	mg/t	0.6 – 3.0
			V	mg/t	13.4 – 15.1
Water	m ³ /t	0.11 – 1.25	Zn	mg/t	3 – 1300
			HF ⁽⁶⁾ ⁽⁷⁾	g/t	1.8 – 5.8
			HCl ⁽⁶⁾ ⁽⁷⁾	g/t	2.4 – 41
			SO _x ⁽⁸⁾ ⁽⁷⁾	g/t	11 – 213
			NO _x	g/t	150 – 550
			NO _x	mg/Nm ³	73 – 283
			CO	g/t	<10 ⁽⁵⁾ – 410
			CO ₂	kg/t	17 – 193
			VOC ⁽⁹⁾	g/t	<5 ⁽⁵⁾ – 40 ⁽³⁾
			PAH ⁽¹⁰⁾	mg/t	0.7 – 1.1
			PCDD/F ⁽⁴⁾	ng I-TEQ/t	8.2 – 196
			PCDD/F ⁽⁴⁾	ng I-TEQ/Nm ³	0.005 – 0.1
			Production residues (waste/by-products)		
			Dusts	kg/t	–

⁽¹⁾ In the case of pellets production for blast furnaces.

⁽²⁾ In the case of pellets production for direct reduction.

⁽³⁾ When the pelletisation plant is part of an integrated steelworks (i.e. NL). Data from [200, Commission 2001].

⁽⁴⁾ Mercury predominately in elemental form. Load depends on ores processed.

⁽⁵⁾ In the case of standalone pelletisation plants in Sweden (magnetite ores). Data from [200, Commission 2001].

⁽⁶⁾ Lower value if techniques for the removal of acidic waste gas components are applied.

⁽⁷⁾ Calculated from mass balance.

⁽⁸⁾ Lower value if desulphurisation techniques are applied.

⁽⁹⁾ Measurement technique is not known.

⁽¹⁰⁾ Information as to whether it is Borneff 6, EPA 16 or benzo(a)pyrene is not available.

NB: Data are from 2004 and relate to three pellet plant sites that produced almost 13 million tonnes of pellets in 2004 among them, representing around 63 % of the production in the EU-25.

Source: [208, Lindfors et al. 2006] [318, Eurofer 2007].

4.2.2 Environmental issues for the pellet-making process

The pelletisation plant is primarily a source of particulate and gaseous emissions to air. When abatement techniques are applied to reduce emissions, cross-media effects occur. Sections 4.2.2.1 to 4.2.2.5 below describe the most relevant environmental issues for pelletisation plants.

4.2.2.1 Emissions to air

[208, Lindfors et al. 2006] [300, Eurofer 2007]

Dust emissions from grinding

Process discharge gas after the air classifier step contains large quantities of dust. This dust consists mainly of iron and reflects the composition of the raw material. Emissions can be abated by means of electrostatic precipitation.

Dust from screening and handling

Screening and handling take place at the balling stage at the beginning of the process where the materials are all damp. Some dust emissions can occur but these are not particularly significant and are mostly contained within the balling area of the plant. At the end of the induration strand, the pellets are collected and screened. Undersized or broken pellets can be recycled. Significant dust emissions from these areas are prevented by the application of various measures. In the IJmuiden plant, the pellets are wetted (3 % moisture) to prevent dust emissions and some transfer points are locally dedusted.

Dust and gaseous emissions from the induration strand

Emissions of gas and dust originate from the firing zone of the induration strand. They occur continuously and should be removed by efficient ESPs, bag filters or scrubbing.

NO_x emissions from induration and drying

Emitted NO_x are formed during combustion via two mechanisms. The oxidation of nitrogen compounds in the hydrocarbon fuel generates 'fuel NO_x'. The other, and most important mechanism, is the formation of NO_x in the pelletisation process as a result of the high temperatures involved. These cause airborne nitrogen and oxygen to dissociate and react to form 'thermal NO_x'. The data shown in Table 4.1 reflect the significant differences in NO_x formation. Sometimes the coke breeze is substituted by anthracite which can lead to a reduction of NO_x emissions of up to 25 %. Another applied way to reduce NO_x emissions is to inject water to lower the peak temperatures.

SO₂ emissions from induration

Sulphur dioxide (SO₂) is formed during the induration process. The source of sulphur is primarily from the coal and oil and to a lesser extent from the ores and the additions of coke breeze and/or anthracite. Table 4.1 shows that SO₂ emissions are about ten times higher when abatement techniques are not applied.

HCl and HF emissions

The pelletisation plant is also a source of hydrofluoric acid (HF) and hydrochloric acid (HCl). These components are formed during minerals (apatite) induration which are present in the ore and contain fluoride and chloride. Table 4.1 indicates that emissions of HF and HCl are about ten times higher without the application of abatement techniques.

Ores from Sweden are known to contain a high content of fluoride (see Section 3.2.2.1.2.5)

Polychlorinated dibenzo-p-dioxins and dibenzofurans (PCDD/F)

[318, Eurofer 2007]

PCDD and PCDF formation during high-temperature processes are generally explained by two different mechanisms:

1. incomplete destruction of PCDD/F present in raw material/fuel.
2. de novo synthesis from carbon and chlorine sources.

During combustion at pelletising plants, ring-structured hydrocarbon species (precursors) are partly formed as intermediate combustion products. In the presence of chlorine, these can react to form PCDD/F. Precursors include dibenzofurans or polycyclic aromatic compounds (PAH) formed through incomplete combustion. Soot is another source of dioxin formation as oxidation can contribute to the formation of non-chloride precursors. Reactions take place in cooling zones, probably between 300 and 400 °C.

Table 4.1 indicates significant differences in dioxin formation. Results from direct measurements range from 8.2 to 196 ng I-TEQ/t pellets. The reasons for this range can be explained by the fact that PCDD/F emissions are associated with the items listed below:

- formation: the fewer precursors present, the less dioxin will be formed. The high oxygen content of flue-gases reduces the possibility of the presence of carbon precursors, so fewer PCDD/F compounds will form
- abatement techniques: if the flue-gas is quenched to low temperatures (<80 °C), the PCDD/F compounds formed will condense on dust particles, so PCDD/F emissions will become congruent with dust emissions
- effective dust abatement at low temperatures will remove PCDD/F effectively.

4.2.2.2 Water flows

Whenever scrubbers are used to remove pollutants, a waste water flow is generated. This waste water needs a bleed, due to the presence of HF. This bleed is relatively small when waste water recycling and NaOH addition are applied. In some cases, this bleed water is treated in an arsenic removal plant.

In addition, waste water is discharged from the wet rinsing of the plant and equipment. In the plant at Corus IJmuiden, NL, this water is 100 % recycled and this flow is about 0.04 m³/t pellets. Cooling water may derive from the grinding and drying section as well as from the induration strand. For the mentioned Dutch plant, the specific flow is 0.16 m³/t pellets from grinding and drying and 0.05 m³/t pellets from induration respectively.

For the Swedish plant, the situation is to some extent special. Parts of the mine water are used as process water for scrubbers and wet ESPs in the refining stages. The process waste water, runoff water and mine water enter through a thickener from where the waters are further conducted to a tailing pond where presettling takes place. From there, water is led to a clarification pond where additional sedimentation is achieved.

At the new MK3 pellet plant in Malmberget (Sweden), the pollution of the water is continuously measured. Table 4.2 shows the achievable concentration values for the plants located in Kiruna and Malmberget, Sweden.

Table 4.2: Operational data from the Malmberget and Kiruna (Sweden) water treatment

	Malmberget 2006	Malmberget 2007	Kiruna 2006	Kiruna 2007	Units
Parameter	Concentration				
Suspended solids	9.12	10.9	4.13	2.33	mg/l
Total N	39.5	41	19.8	17.5	mg/l
Phosphorus	41.4	48.7	0.039	0.028	µg/l
Cadmium	0.018	0.011	0.025	0.014	µg/l
Cobalt	3.63	6.23	0.35	0.37	µg/l
Chromium	0.70	0.35	0.05	0.1	µg/l
Copper	2.30	3.73	2.68	4.03	µg/l
Mercury	<0.002	<0.002	<0.002	<0.002	µg/l
Lead	0.20	0.14	0.13	0.24	µg/l
Zinc	6.87	5.95	0.63	4.56	µg/l
Nickel	13.7	16	1.83	2.39	µg/l
Arsenic	3.34	1.47	3.56	0.7	µg/l
<i>Source: [113, Gidlund et al. 2008] [166, Lundqvist, A. 2009].</i>					

4.2.2.3 Process residues such as wastes and by-products

The pelletisation plant itself is not a primary source of solid waste but the sorting and beneficiation of raw material. In addition, solid waste is generated whenever emissions of dust are abated. The precipitated dust ends up as sludge in the waste water treatment plant.

4.2.2.4 Energy consumption

[318, Eurofer 2007]

Specific energy consumption has successively decreased during the last decades. The decrease has been made possible through systematic improvements of the process. In 2005 the specific energy consumption was in the range of 186 to 662 MJ/t of pellets.

There are some differences between the various types of plants both when it comes to the kind of energy used and the kind of energy consumed. The grate kiln process predominantly uses coal while the travelling grate process uses oil or gas.

At most pelletising plants in the world, as is the case in the Netherlands, carbon-bearing additives to the pellets provide part of the heat required for sintering. This case refers to the higher end of the range of external energy consumption, as mentioned above.

The Swedish standalone plants use ores predominantly from magnetite deposits which give great advantages by magnetite oxidation. In fact, approximately 60 % of the thermal energy required is supplied by magnetite oxidation, hence resulting in external thermal energy consumption at the lower end of the above-mentioned range.

To save energy, heat supplied from the oxidation of magnetite and fuel is recovered in the pelletising process. The main part of the surplus heat from the cooling sections of the machines is recirculated to the hot zones, thus reducing the need for external energy input. At some industrial sites, waste heat is recovered into the internal heating system. Where it is practically possible, waste heat is also transferred into municipal heating networks.

4.2.2.5 Noise

The dry grinding mills at Corus IJmuiden are filled with 150 t of iron balls and turn at a speed of two revolutions per second (the rate of rotation is set to achieve optimum grinding efficiency). These mills can generate noise emissions of about 85 dBA and for this reason are fully enclosed in acoustic cabinets. Wet grinding mills do not generate the same level of noise and generally there is no need to house these mills in acoustic enclosures.

4.3 Techniques to consider in the determination of BAT for pelletisation plants

This section describes techniques (or combinations thereof), and associated monitoring, considered to have the potential for achieving a high level of environmental protection in the activities within the scope of this document.

It covers process-integrated techniques and end-of-pipe measures. Waste prevention and management, including waste minimisation and recycling procedures are also considered. Furthermore, techniques for reducing the consumption of raw materials, water and energy are covered.

Annex III to the Directive lists a number of criteria for determining BAT, and the information within this chapter will address these considerations. As far as possible, a standard structure as shown in Table 4.3 is used to outline the information gathered concerning each technique, to enable a comparison of techniques and the assessment against the definition of BAT given in the Directive.

This section does not necessarily provide an exhaustive list of techniques which could be applied in the sector and other techniques may exist or may be developed, which could be considered for the determination of BAT for an individual installation.

Table 4.3: Information breakdown for each technique described in this section

Type of information considered	Type of information included
Description	Brief technical description using, as appropriate, pictures, diagrams and flow sheets.
Achieved environmental benefits	Main potential environmental benefits to be gained through implementing the technique (including energy, water, raw material savings, as well as production yield increases, energy efficiency, etc.).
Cross-media effects	<p>Potential environmental side effects and disadvantages to other media due to implementing the technique, including details of the environmental effects of the technique in comparison with others (advantages and disadvantages supported by data if available) in order to assess the impact of the technique on the environment as a whole. This may include issues such as:</p> <ul style="list-style-type: none"> • consumption of raw materials and water • energy consumption and contribution to climate change • stratospheric ozone depletion potential • photochemical ozone creation potential • acidification resulting from emissions to air • particulate matter in ambient air (including microparticles and metals) • eutrophication of land and waters resulting from emissions to air or water • oxygen depletion potential in water • persistent/toxic/bioaccumulable components in water or to land (including metals) • creation or reduction of (waste) residues • ability to reuse or recycle (waste) residues • noise and/or odour • risk of accidents.

Type of information considered	Type of information included
Operational data	Actual performance data (including reference conditions, monitoring periods and monitoring methods) on emission levels, consumption levels (raw materials, water, energy) and amounts of waste generated. Any other useful information on how to operate, maintain and control the technique.
Applicability	Indication of the type of plants or processes in which the technique may or cannot be applied as well as constraints to implementation in certain cases, considering, e.g. plant age (new or existing), factors involved in retrofitting (e.g. space availability), plant size (large or small), techniques already installed and type or quality of product.
Economics	Information on costs (investment and operating) and any possible savings (e.g. reduced raw material or energy consumption, waste charges) or revenues including details on how these have been calculated/estimated. Economic information relevant to new build and retrofit to existing installations will be included. This should allow for identifying, where possible, the overall economic impact of the technique.
Driving force for implementation	Specific local conditions, requirements (e.g. legislation, safety measures) or non-environmental triggers (e.g. increased yield, improved product quality) which have driven or stimulated the implementation of the technique to date.
Example plants	Reference to the plant(s) where the technique has been implemented and from which information has been collected and used in writing the section. Indication of the degree to which the technique is in use in Europe or worldwide.
Reference literature	Literature or other reference material (e.g. books, reports, studies, websites) that was used in writing the section and that contains more detailed information on the technique.

4.3.1 Electrostatic precipitation at the grinding mills (dry grinding)

Description

After grinding, the particles are separated by means of air classification. Coarse particles are recycled to the grinding mills and fine, correctly sized particles are fed to the mixing stage. The air used for the air classification contains large amounts of dust which have to be captured. The characteristics of the dust are such that they can be effectively captured using an ESP. The captured material can be fed directly to the mixing stage as it has the same composition as the raw material (approximately 1.1 wt-% coke breeze, approximately 1.3 wt-% Olivine (FeO, MgO, SiO₂) and the rest is a blend of ores, being magnetite (FeO) and hematite (Fe₂O₃)).

Achieved environmental benefits

The ESP operates more or less as an integrated part of the air classification system. Achieved emissions concentrations are <20 mg/Nm³. Modern-design ESPs may achieve lower emissions and hence recover raw materials as well.

Cross-media effects

The precipitate from the ESP is completely used as raw material in the balling mill. The operation of the ESP consumes energy. At a waste gas flow of 300000 Nm³/h and a production of 4 Mt/yr, the energy consumption is approximately 1 MJ/t pellet.

Operational data

No data submitted.

Applicability

ESPs are applicable for new and existing plants.

Economics

An ESP is an integrated part of the plant design; part of the raw material from the air classification step is recovered by the ESP. However, it can be calculated that a dry ESP for treatment of a waste gas flow of 300 000 Nm³/h will require an investment of approximately EUR 2 million (1996 prices). Operational costs can be calculated as EUR 0.03 to 0.05/t pellet (1996 prices) for a pelletisation plant with an annual production of 4 Mt and a drying mill waste gas flow of 300 000 Nm³/h.

Driving force for implementation

The driving forces for this technique are full recovery of raw materials and thus savings of resources.

Example plants

Pelletisation plant, Corus IJmuiden, the Netherlands.

Reference literature

[65, InfoMil 1997] [318, Eurofer 2007] [247, Netherlands 2007]

4.3.2 Individual or combined reduction of solid and gaseous pollutants from the drying and induration zone

Description

In pelletisation plants several techniques are used for dust removal. The main techniques used are mechanical collectors (for coarse particles), multicyclones, wet scrubbers, bag filters and electrostatic precipitators (ESP). ESPs and bag filters provide a high cleaning efficiency but can operate only over a limited range of temperature and moisture conditions. Wet scrubbers are therefore also used in pelletisation plants to remove dust. Scrubbers can be highly efficient dust removers. Scrubbing water is collected and treated by sedimentation (clarifier). The solid matter is recycled back into the process.

Achieved environmental benefits

Dust removal efficiency for the techniques listed above is normally >95 %, and in some cases >99 %. Dust emissions can be <10 mg/Nm³ (see Table 4.1). For example, at the latest Swedish plant, KK3 in Kiruna, the dust concentrations in the emitted waste gas from the drying and induration zone are below 10 mg/Nm³ and the total dust emissions from the plant as a whole are below 100 g/t pellets, applying a scrubber for the abatement of emissions from the drying zone and an ESP for the induration zone emissions.

An advantage of wet scrubbers is that SO_x, HF and HCl can also be removed. Achievable emissions concentrations to air (wet scrubber with NaOH addition) for SO₂ are <30 – 50 mg/Nm³ and for both HF and HCL, <1–3 mg/Nm³. In addition, fumes and aerosols are also captured. With scrubbers, the SO₂ emissions were reduced by more than 95 % at the LKAB Kiruna pellet plant in 1995 [114, Remus, Rainer 2008].

Cross-media effects

Normally the collected dust is recycled to the pelletisation process. In the case of scrubbers, some surplus water should be discharged after appropriate treatment.

The application of bag filters downstream from a wet scrubber requires that the waste gas streams are reheated after the scrubbers.

Operational data

No specific problems are known.

Applicability

The end-of-pipe techniques described can be applied both at new and existing plants.

Economics

A study has been performed in one installation of a bag filter downstream of the scrubber. Since it is necessary to reheat the waste gas streams after the scrubbers, the investment and operational costs include a provision for the costs of heating. The investment for bag filters including reheating equipment is estimated at EUR 25 million. Operational costs are high, EUR 8 million/yr, mainly due to the cost of reheating [249, Netherlands 2007].

Driving force for implementation

No data submitted.

Example plants

KK3 and LKAB pelletisation plant, Kiruna, Sweden; Corus IJmuiden, the Netherlands.

Reference literature

[65, InfoMil 1997] [114, Remus, Rainer 2008] [169, LKAB 2004] [208, Lindfors et al. 2006] [249, Netherlands 2007] [251, Eurofer 2007] [318, Eurofer 2007]

4.3.3 Gas suspension absorber (GSA)

Description

The GSA is a semi-dry process. A wet lime slurry is sprayed in the waste gas in a fluidised bed reactor. The water from the lime slurry evaporates and the slaked lime reacts with the impurities (HF, HCl and SO₂). A high concentration of dust in the waste gas enhances the performance of the GSA and as it increases the reaction surface, dust is coated with the slaked lime solution.

After the fluidised bed reactor, the waste gases are led through cyclones. Part of the dry product (reacted lime and dust) is removed here and recirculated into the reactor, in order to maintain a high concentration of dust in the reactor. Final cleaning of the waste gas is performed using electrostatic precipitation.

The rate of injection of slaked lime is proportional to the SO₂ concentration in the waste gas.

Achieved environmental benefits

The performance data of a GSA at a pelletisation plant are summarised in Table 4.4. These data were provided by the Swedish company LKAB, which operates a GSA to treat the waste gas from the induration strand at their KK3 pelletisation plant. Waste gas from the drying zone of the induration strand is led through venturi scrubbers to remove dust before being emitted to the air.

The values in Table 4.4 show the low overall emissions from this plant.

Table 4.4: Performance data of a gas suspension absorber (GSA)

Component	Before GSA (mg/Nm ³)	After GSA (mg/Nm ³)	Removal efficiency (%)
Sulphur oxides (SO ₂)	300	9.6	96.8
Hydrofluoric acid (HF)	78	<0.1	99.9
Hydrochloric acid (HCl)	133	0.6	99.5
Dust	1400	2	99.9
NB: KK3 pelletisation plant of LKAB, Kiruna, Sweden in 1995. Source: [200, Commission 2001].			

The following data can be given for this plant: the plant was commissioned in January 1995 and has an annual production capacity of 4.5 Mt. Actual production in 1995 was 2.8 Mt pellet. The plant is equipped with two burners: one burner in the firing zone of the induration strand and

one burner to increase the temperature of the off-gas from the second cooling section, which is used as preheating air in the first preheating zone.

Cross-media effects

A GSA is a semi-dry device, with an electrostatic precipitator (ESP) as the last cleaning stage. The dry precipitate from the ESP contains dust, CaSO_3 , CaCl_2 , and CaF_2 and some unreacted lime (CaO). The dry precipitate is deposited.

Slaked lime consumption is 264 kg/h (design) and water consumption is 10.6 m³/h (design). Furthermore, pressurised air (7 bar) is used: 690 kg/h (design). Energy consumption is about 0.64 MJ/t pellet (design).

Operational data

No specific problems are known.

Applicability

A GSA is an end-of-pipe measure that can be applied at both new and existing plants.

Economics

No data submitted.

Driving force for implementation

No data submitted.

Example plants

KK3 pelletisation plant, LKAB, Kiruna, Sweden.

Reference literature

[200, Commission 2001] [247, Netherlands 2007] [248, Eurofer 2007]

4.3.4 Process-integrated NO_x abatement

Description

The primary sources for NO_x formation in a pelletisation plant are ‘thermal’, ‘fuel’ and ‘prompt’ NO_x. NO_x that is formed in the pellet bed mainly consists of ‘fuel’ NO_x and ‘prompt’ NO_x. Both are formed by reactions between hydrocarbons in the coke breeze, nitrogen in the coke breeze and oxygen and nitrogen in the air (coke breeze addition made in the Dutch plant). The main factors for ‘thermal’ NO_x formation are the high temperatures (1300 – 1400 °C) in the induration strand and the high availability of oxygen in the burner zone. It is not possible to distinguish between the various forms of NO_x after they have formed, there being no difference in chemical composition. For pelletisation plants, it can be assumed that the overall NO_x emissions are dominated by ‘thermal NO_x’.

The most important measure aims to reduce the formation of thermal NO_x. This can be achieved by lowering the (peak) temperature in the burners and reducing the excess oxygen in the combustion air. Additionally, lower NO_x emissions can be achieved by a combination of low energy use, low nitrogen content in the fuel (coal and oil) and by limiting the excess oxygen.

Achieved environmental benefits

At the KK3 pelletisation plant of the company LKAB in Kiruna (Sweden) NO_x emissions from the firing zone are 175 – 196 g/t pellets or related to a specific off-gas flow of 2400 Nm³/t pellets 73 – 82 mg/Nm³. This plant was commissioned in January 1996 and no end-of-pipe techniques are used to reduce NO_x emissions. The low NO_x emissions were achieved by a combination of low energy use, low nitrogen content in the fuel (coal and oil) and by limiting the excess oxygen. The plant uses two large burners in the induration strand.

At the KK2 pelletising plant of the company LKAB in Kiruna, Sweden, the indirect coal firing technique is used. The NO_x emissions from this plant are 150 g/t pellets. The ‘indirect coal’ means that the coal is milled, filtered and is stored before it is used in the burner. The technique makes it possible to finely adjust energy use and the amount of transport air is small which means that one of the requirements for the formation of thermal NO_x is minimised.

The situation at the Corus IJmuiden, the Netherlands pelletisation plant is somewhat different. The plant uses 56 long burners (of which 44 are operated simultaneously). NO_x emissions from the induration strand are approximately 550 g/t pellet or (with 1940 Nm³/t pellets) 283 mg/Nm³. Process-integrated measures at this plant are complicated and were tailor made for it.

The new MK3 pellet plant in Malmberget, Sweden is equipped with extra burners in the recuperation hood to allow for lower flame temperatures in the burner hoods. When using this technique, it might be expected that NO_x formation can be reduced. Furthermore, the burner chambers are designed to allow for shaping and varying the geometry of the flame. In addition, long-term work has recently started on the development of new burner techniques for pelletising plants to reduce NO_x.

Cross-media effects

No cross-media effects occur.

Operational data

No data submitted

Applicability

When building a new plant, process-integrated measures for reducing the generation of NO_x can be considered at the design stage. In the case of existing plants, process-integrated NO_x abatement techniques are preferable. Non-design related measures can be considered for both new and existing plants.

Economics

The costs for new plants are considerably lower compared with retrofitting.

Driving force for implementation

The driving force is to lower national emissions to meet the national reduction goals according to national and international regulations, environmental reputation and improved economics.

Example plants

KK2 and KK3 pelletisation plants, LKAB, Kiruna, Sweden; MK3 plant, Malmberget, Sweden and Corus IJmuiden, the Netherlands.

Reference literature

[114, Remus, Rainer 2008] [200, Commission 2001] [208, Lindfors et al. 2006] [318, Eurofer 2007]

4.3.5 Selective catalytic reduction (SCR)

Description

See Section 3.3.2.8.2.

Achieved environmental benefits

Reduction of NO_x emissions.

Cross-media effects

See Section 3.3.2.8.2.

Operational data

The fact that the SCR might be successfully installed in a new pellet plant does not automatically mean that the installation would give the required effects at reasonable costs in existing plants. LKAB has already investigated the possibilities of end-of-pipe techniques for existing plants. Generally, the temperatures are too low to optimise the abatement of NO_x. Therefore, the gas flow must be preheated in this kind of installation, which involves negative effects like increased fuel use and consequently higher emissions and costs.

Applicability

For the existing plants, both straight grate and grate kiln systems, it is difficult to obtain the operating conditions necessary to suit an SCR reactor. For a new pelletising plant, however, the plant and the SCR system can be correctly designed with respect to the required temperature of the reactor and moderate gas flows. Due to high costs, the end-of-pipe nitrogen oxide reduction of waste gas should only be considered in circumstances where environmental quality standards are otherwise not likely to be met.

Economics

No data submitted.

Driving force for implementation

The driving force is to lower national emissions to meet the national reduction goals according to national and international regulations.

Example plants

LKAB will be involved in an extensive research programme on NO_x abatement until 2010. In this respect, it has been decided that the new pellet plant KK4 in Kiruna, Sweden, will be equipped with a deNO_x facility.

The Alstom selective catalytic reduction (SCR) reactor was installed in KK4 for a full-scale pilot test. The test started in spring 2008 and the result will be reported by the end of 2009. This installation will be the first in the world on a grate kiln pelletising plant and the aim is to evaluate an SCR reactor in a new plant, under circumstances where the working conditions for this technique can be optimised.

Laboratory tests concerning the lifespan for an SCR were performed on a small scale and so far have given positive results. Many uncertainties still remain, however, regarding the functioning of an SCR reactor in pelletising plants.

Reference literature

[318, Eurofer 2007]

4.3.6 Pellet plant water treatment

Description

The waste water from scrubbers undergoes neutralisation before it enters a circulation basin. From there it is further processed to settling tanks. The sedimentation properties of the sludge are very often improved by dosage of flocculation agents. A part of the waste water from the settler is reused as scrubbing water. At Corus IJmuiden, the Netherlands another part is directed as a bleed to the arsenic removal plant to be further precipitated (see Section 4.3.7).

Achieved environmental benefits

Precleaning of process water and separation of sludge enables the recycling of water in the scrubber.

Cross-media effects

Sludge needs to be recycled or disposed of and may contain heavy metals such as Ni, Cr, and Cd.

Operational data

No specific problems are known.

Applicability

No data submitted.

Economics

No data submitted.

Driving force for implementation

No data submitted.

Example plants

Corus IJmuiden, the Netherlands

Reference literature

[114, Remus, Rainer 2008]

4.3.7 Arsenic removal plant

Description

The waste water from the water treatment plant at the Corus IJmuiden, the Netherlands, pellet plant contains dissolved arsenate (As^{5+}) and arsenite (As^{3+}). Arsenic compounds are present in some iron ores. The arsenite is converted to arsenate by means of Fenton's reagent (combination of Fe(II)chloride and peroxide) at pH 7, after which the arsenate is precipitated. After dewatering, the filter cake which contains arsenic can be recycled or disposed of. After sedimentation, the waste water passes through sand filters in order to remove residual suspended solids, and three ion exchangers to control the level of other heavy metals, e.g. Cd, Cr, Cu, Ni. (see Figure 4.7).

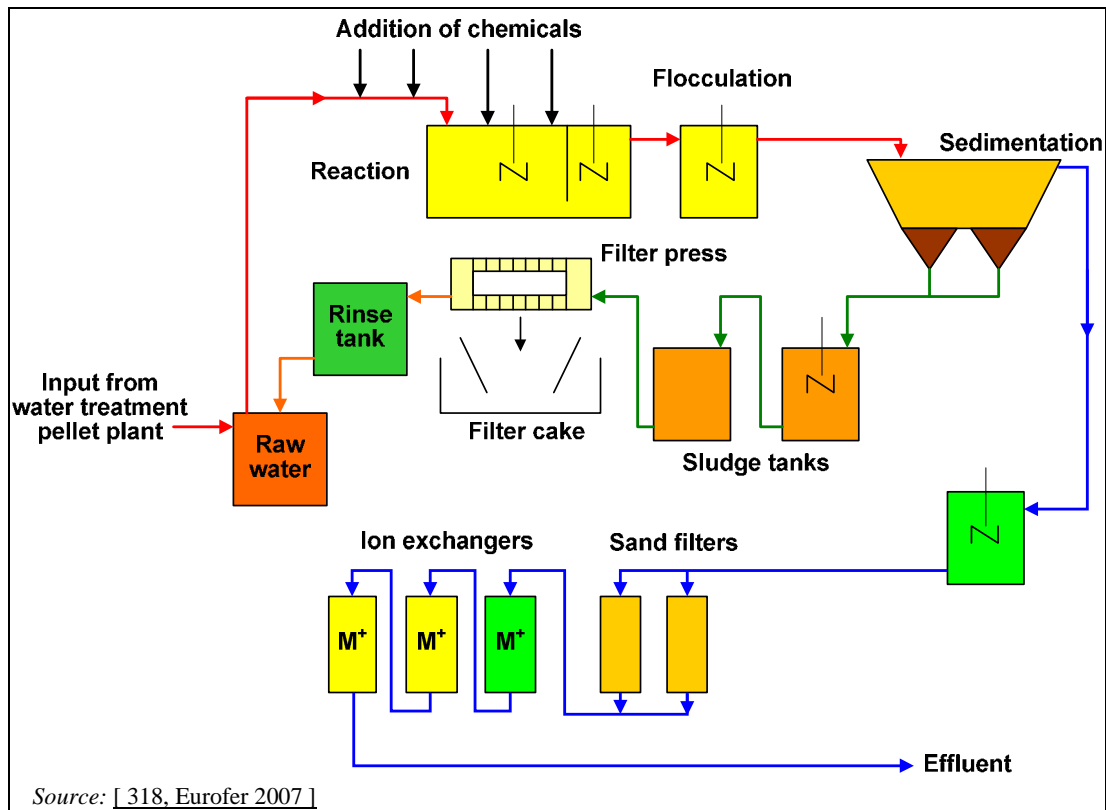

Figure 4.7: Process flow diagram of an arsenic removal plant

Achieved environmental benefits

The operational data from the arsenic removal plant are shown in Table 4.5.

Table 4.5: Operational data from the arsenic removal plant (2007)

Parameter	Range	Units
Suspended solids	<10 – 95	mg/l
COD	56 – 81	mg/l
Kjeldahl-N	8.1 – 15	mg/l
Fluorides	1300 – 2000	mg/l
Cd	<1 – 1.7	$\mu\text{g/l}$
Hg	0.25 – 2	$\mu\text{g/l}$
As	10 – 27	$\mu\text{g/l}$
Cr	13 – 18	$\mu\text{g/l}$
Pb	10 – 83	$\mu\text{g/l}$
Zn	43 – 95	$\mu\text{g/l}$
Ni	44 – 64	$\mu\text{g/l}$
Cu	<1 – 19	$\mu\text{g/l}$

Source: [163, Infomil 2009].

Cross-media effects

An arsenic sludge needs to be recycled or disposed of and may contain heavy metals such as Ni, Cr, and Cd.

Operational data

No specific problems are known. Consumption of chemicals has not been reported.

Applicability

The removal of arsenite and arsenate can be implemented as an end-of-pipe solution at all types of new and existing water treatment plants.

Economics

The investment cost for an arsenic removal plant with a capacity of 55 m³/h was EUR 2.6 million in 2004. These costs also depend on the effluent limits of arsenic and the heavy metals.

Driving force for implementation

The Corus plant in IJmuiden, the Netherlands is being optimised in order to comply with legal limits and to reduce operating costs.

Example plants

The Corus, IJmuiden, the Netherlands arsenic removal plant has been operational since August 2004.

Reference literature

[318, Eurofer 2007]

4.3.8 Recovery of sensible heat from the induration strand

Description

A pelletisation plant is designed in such a way that the sensible heat of the flue-gases of the induration strand can be used efficiently. For example, the hot air from the primary cooling section is used as secondary combustion air in the firing section. In turn, the heat from the firing section is used in the drying section of the induration strand. Heat from the secondary cooling section is also used in the drying section.

For the Dutch pelletisation plant in an integrated steelworks, the cooling section generates more sensible heat than can be used in the induration strand. Formerly, this heat was not used, but since the mid 1980s, this sensible heat has been used in the drying chambers of the drying and grinding unit. The hot air is transported through an insulated pipeline called a 'hot air recirculation duct'.

The 'hot air recirculation duct' transports approximately 150 000 m³/h hot air (250 °C) from the cooling section of the induration strand to the mills in the drying and grinding section. In the drying section, hot air (600 – 800 °C) is used to dry the concentrates and fines before grinding. By using the hot air from the cooling section, considerably less firing is needed in the drying chamber.

Achieved environmental benefits

Gross energy consumption of the above-mentioned pelletisation plant is approximately 1.4 GJ/t pellet (compared to the standalone plants in Sweden operating on a magnetite concentrate feedstock, this consumption is significantly higher – see Table 4.1 and Section 4.2.2.4). About 0.7 GJ/t pellet is supplied by means of heat recuperation, whereas approximately 0.7 GJ/t pellet is introduced by means of fuel. The 'hot air recirculation duct' is included in this calculation and accounts for an energy recovery of approximately 67.5 MJ/t pellet (approximately 4 % of gross energy consumption).

Cross-media effects

The use of hot air from the cooling zone in the firing zone of the induration strand may give rise to higher flame temperatures in the burner(s) and thus to higher NO_x emissions.

Operational data

No data submitted.

Applicability

Recovery of sensible heat is a process-integrated part of pelletisation plants. New plants can be expected to have a more efficient design than existing ones. The 'hot air recirculation duct' can be applied at existing plants with a comparable design and a sufficient supply of sensible heat.

Economics

Heat recuperation in the induration strand is an integrated part of the plant design and does not require additional investment. The 'hot air recirculation duct' was commissioned in 1984. The estimated investment was EUR 5 million. Savings in energy costs total EUR 2.8 million per year.

Driving force for implementation

No data submitted.

Example plants

Pelletisation plant, Corus, IJmuiden, the Netherlands.

Reference literature

[65, InfoMil 1997] [318, Eurofer 2007]

5 COKE OVEN PLANTS

[320, Eurofer 2007]

Coal pyrolysis means the heating of coal in an oxygen-free atmosphere to produce coke (solid), gases and liquids. Coal pyrolysis at high temperature is called carbonisation. In this process, the temperature of the flue-gases from under firing is normally 1150 – 1350 °C indirectly heating the coal up to 1000 – 1100 °C for 14 – 28 hours. The duration depends, e.g. on the width of the oven (in the case of heating by the side), the density of coal and on the quality of the desired coke (e.g. use in foundries or blast furnaces). The most important reducing agent in hot metal production is coke which removes the oxygen either indirectly by forming carbon dioxide or directly using its inherent carbon content. The gasification of the coke also serves to supply the heat necessary for the reduction process. Coke functions both as a support material and as a matrix through which gas circulates in the stock column. Coke cannot be wholly replaced by coal or other fuels.

Only certain coals, for example coking or bituminous coals, with the right plastic properties, can be converted to coke and, as with ores, several types may be blended to improve blast furnace productivity and extend coke battery life. Other materials which contain carbon can also be applied in small quantities (e.g. petroleum coke (petrolcoke), used crushed rubber tyres) under the precondition that there is no negative influence on the environment. Oil or oil residues are added to give a better compaction of the coal.

5.1 Applied processes and techniques

[204, Neuwirth et al. 2003] [207, Ameling et al. 2004] [320, Eurofer 2007]

By the 1940s, the basic design of modern coke ovens had been developed. The ovens were about 12 m long, 4 m high and 0.5 m wide, and were equipped with doors on both sides. The air supply was preheated by the hot exit gas; waste heat recovery enabled higher temperatures and increased coking rates. Since the 1940s, the process has been mechanised and the materials used in the construction of the ovens have been improved without significant design modifications. Batteries may contain up to 70 ovens as large as 14 m long and 6 m high. Because of heat transfer considerations, widths have remained at between 0.3 and 0.6 m. Each oven in the battery holds up to 30 tonnes of coal. Some recently constructed coke oven plants have increased dimensions further. For instance, the chambers of the coke oven plant used in Duisburg-Schwelgern, Germany (see Figure 5.1), which was put into operation in 2003, are approximately 20 m long, 8.3 m high and 0.59 m wide, and each chamber has a capacity of approximately 70 tonnes of coal. Figure 5.1 shows a photograph of the coke oven plant in Duisburg-Schwelgern, Germany.



Source: [312, Dr. Michael Degner et al. 2008]

Figure 5.1: Photograph of the coke oven plant in Duisburg-Schwelgern, Germany

Developments in recent years have also been particularly aimed at minimising emissions from the processes and at improving working conditions for operators.

Besides the horizontal chamber coking as described before the so-called ‘heat recovery’ (non-recovery) cokemaking gained importance during recent years, although this technique is not applied in Europe to date. Heat recovery coke making needs oven systems which differ clearly in design when comparing with conventional horizontal chamber systems.

The coke-making process can be subdivided into:

- coal handling and preparation
- battery operation (coal charging, heating/firing, coking, coke pushing, coke quenching)
- coke handling (discharge, storage, conveyance) and preparation
- coke oven gas (COG) treatment with recovery and treatment of by-products in the case of a conventional coking plant

- recovery of the heat of the cooking and treatment of the flue gas in the case of a heat recovery coking plant.

In order to make the description of the waste water (coming from the COG treatment) treatment clearer, the water flows in the conventional coking process are also described here.

Figure 5.2 shows a simplified scheme of the whole sequence of operations and processes required to produce coke (showing emissions sources). The main steps mentioned above are described in more detail below.

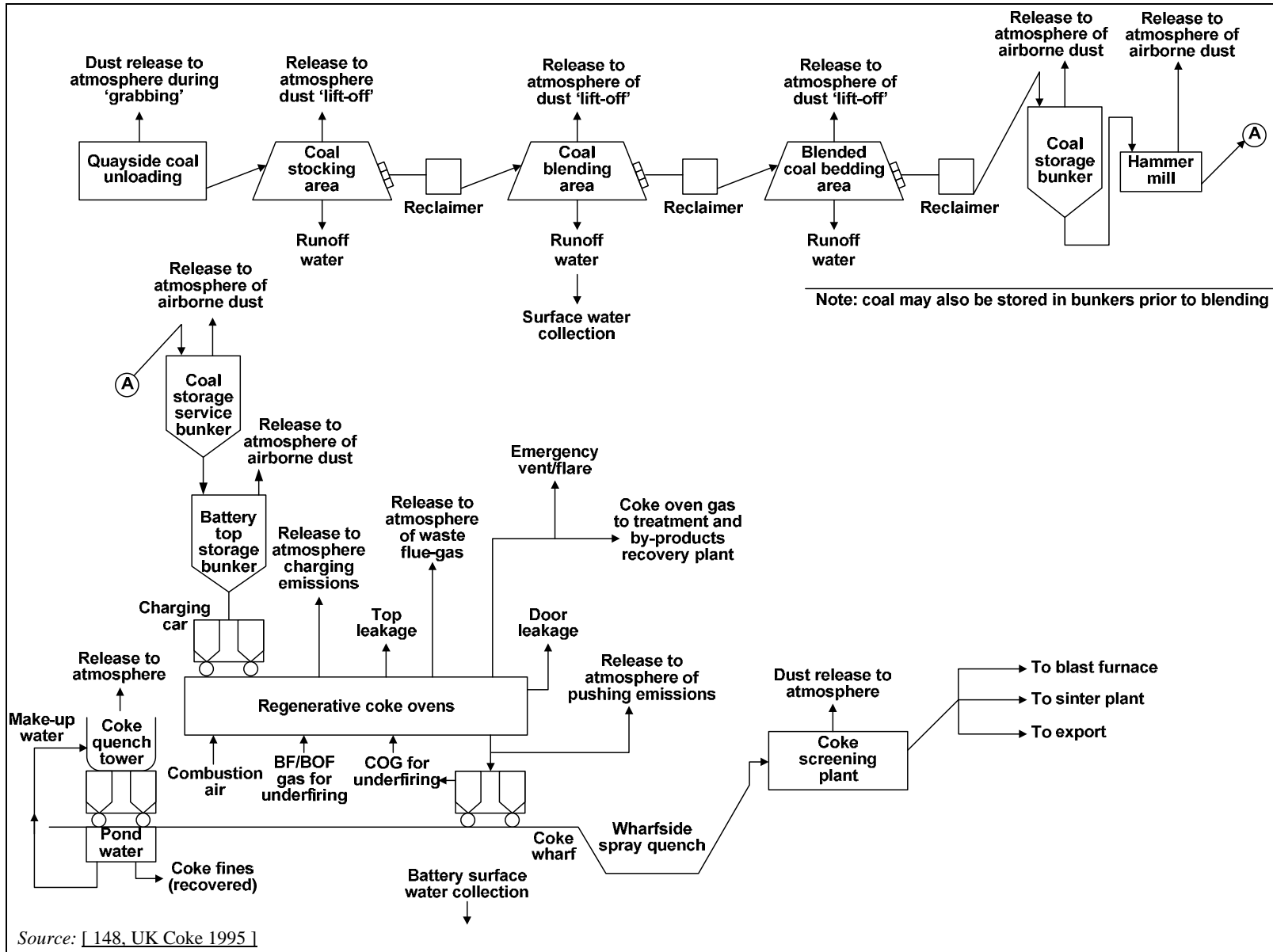

Figure 5.2: Typical flow diagram of a coke oven plant showing emissions sources

5.1.1 Coal handling and preparation

[223, USEPA 2001] [320, Eurofer 2007]

Coal handling and preparation comprises the following steps:

- discharge of coal: the coal is discharged from ships or trains onto a transportation system or for storage. Usually large cranes with grabs are used. Wind and handling operations may cause coal dust emissions
- coal storage: coke oven plants are normally associated with large coal stocking areas. Wind may cause coal dust emissions. Attention should be paid to treatment (sedimentation) of runoff water from rain and water spraying
- coal transport: coal transport by conveyor, possible transfer points outside buildings and transportation by road should be taken into consideration
- coal preparation: this comprises crushing and bed or bunker blending, which may lead to dust emissions. Coal is prepared for coking by pulverising it in such a way that 80 – 90 % of the coal passes through a 3.2 mm screen. During blending, recycled substances such as tar may be added, which may lead to the emissions of volatile compounds
- charging of the coal tower (coal dust emissions may occur)
- charging of the charging car (coal dust emissions may occur)
- operation of two blending beds which can be filled and emptied alternatively. While one bed is filled, the other delivers the coal to the coal tower by scratching devices. Water sprayers prevent dust emissions and a continuous water spraying and height control of the feeder takes place.

5.1.2 Coke oven battery operations

The operation of a coke oven battery comprises:

- coal charging
- heating/firing of the chambers
- coking
- coke pushing
- coke quenching.

These operations dominate the emissions from a coke oven plant. They are therefore described in more detail here, together with information about emissions sources. Figure 5.3 shows the layout of the battery and shows the main emissions sources.

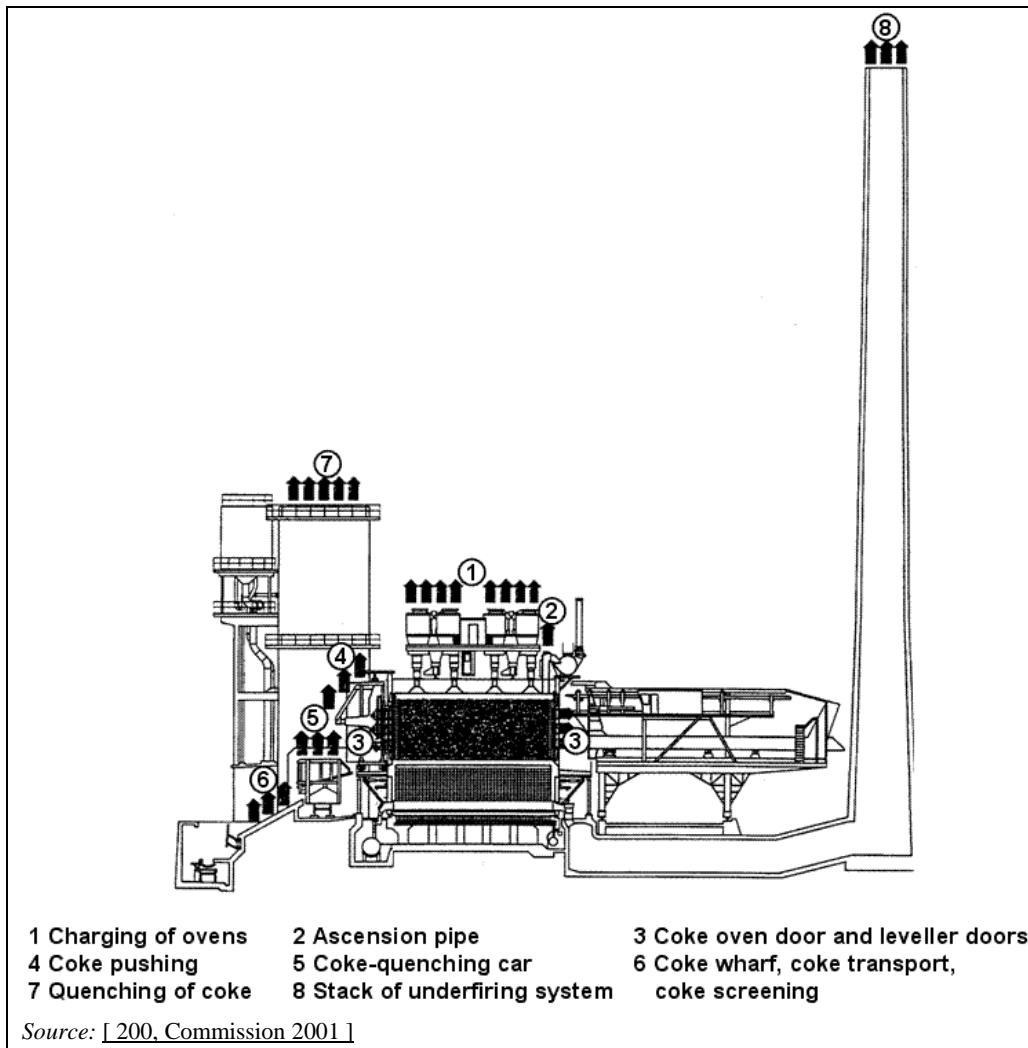

Figure 5.3: Schematic diagram of a coke oven battery showing the main emission sources

5.1.2.1 Coal charging

[320, Eurofer 2007] [102, Eurofer 2008]

There are a number of techniques for charging coke ovens with pulverised coal (80 – 90 % of the pulverised coal is <3.2 mm) through the charging holes. The most common technique is gravity charging by charging cars (see Figure 5.4). The charging process starts by lifting the first charging hole lid and finishes with closing the last charging hole. The whole procedure takes about 2 to 3 minutes, whereas the charging process itself takes about 45 to 60 seconds, depending on the size of the chamber. This can be simultaneous, sequential or stage charging by speed controlled horizontal screw feeders or turntables. Other systems like pipeline charging or stamp charging are also applied.

In a stamp charging system, charging is realised at the machine side through door opening of the coke oven battery. Two systems of the stamp charging technique are applied in coke oven plants as follows:

- in the classical stamp charging technique, the charging machine consists of a coal bunker and a charging box which moves after every charge. The coal blend demand necessary for one coke oven chamber filling is loaded from the feeder to the charging box. In the charging box, the blend is compacted and is then loaded into the coke oven chamber

- a new way of coal stamping is 'stationary stamping'. Rammer units are installed under the coal tower and they compact and deliver the charge to the charge box of the charging machine. A charging machine is a mobile element and its main task is to load compacted charge into the coke oven chamber.

The advantage of stamp charging is that even with low quality coal high quality coke can be produced. The stamping of coal in the charging machine takes 4 to 17 minutes. The density of the charge is 20 – 50 % higher than the density of the coal in gravity charging systems. Additionally, 'stationary stamping' allows better efficiency operation of the rammers unit and the charging machine is smaller and lighter in comparison to classical charging machines.

Regardless of the system, the flow of the coal must be kept under control. General measures are given for all of these systems. The aim of these measures is to achieve 'smokeless' charging (charging with reduced emissions).

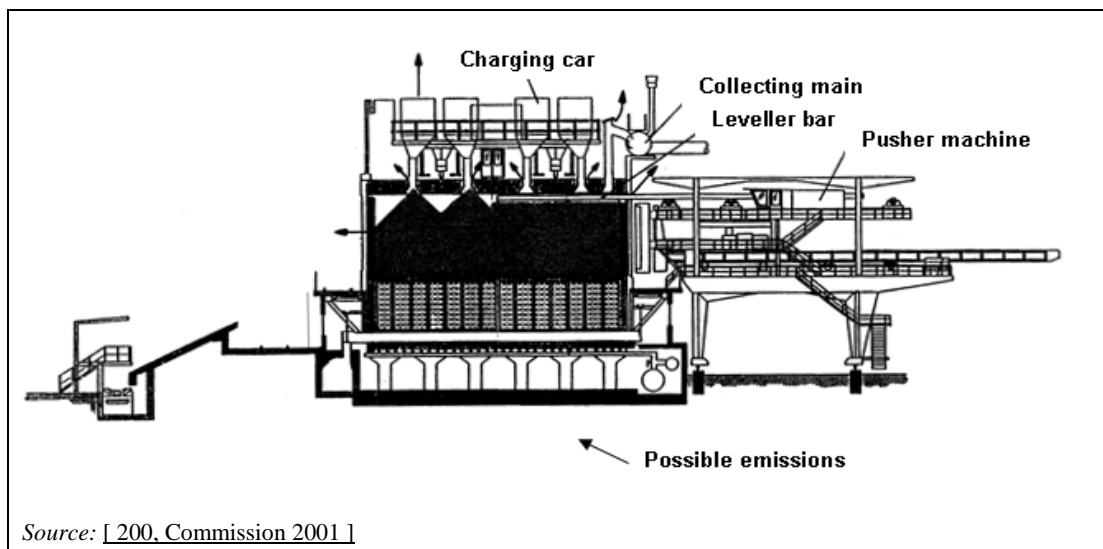

Figure 5.4: Diagram of coal charging of a coke oven chamber using a charging car showing the emissions points

5.1.2.2 Heating/firing of the chambers

[223, USEPA 2001] [320, Eurofer 2007]

The individual coke oven chambers are separated by heating walls. All of the chambers are lined with refractory (silica) bricks. These heating walls consist of a number of heating flues with nozzles for fuel supply and with one or more air inlet boxes, depending on the height of the coke oven wall. The average nozzle brick temperature, characterising the heating flue operation, is usually set at between 1150 and 1350 °C. Usually, cleaned coke oven gas is used as a fuel, but other gases such as (enriched) blast furnace gas can be used. The cleaned coke oven gas has a calorific value of about 17540 kJ/m³ and the mixed fuel gases have about 4200 kJ/m³.

In order to improve energy efficiency, regenerators are located directly under the ovens, exchanging heat from flue-gases with combustion air and/or process gases. Figure 5.5 shows a schematic diagram of a coke oven heating system together with the emissions points. If the heating walls are not completely gas-tight because of cracks, coke oven gas produced during coking will reach the flue-gas and will cause incomplete combustion resulting in emissions at the stack.

For the mechanisms and products of sooting resulting from an incomplete combustion of benzene see [213, Bittner et al. 1983] and [214, Richter et al. 2000].

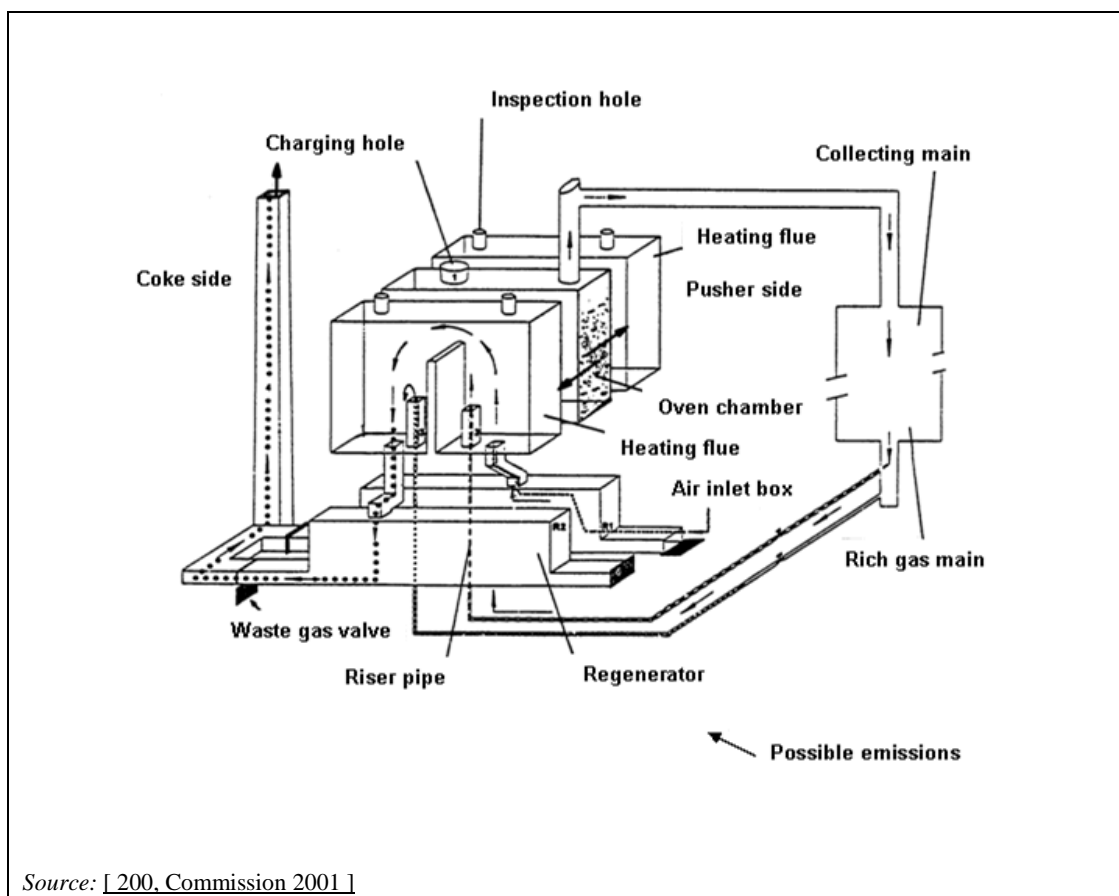

Figure 5.5: Schematic diagram of a coke oven heating system showing the emissions points

The design shown Figure 5.5 is for a single stage combustion whereas today most modern plants have multi-stage combustion; crude coke oven gas (COG) used as a fuel is normally desulphurised beforehand.

5.1.2.3 Coking

The coking process starts immediately after coal charging. The moisture driven off accounts for about 8 – 15 % of the charged coal. In addition to the moisture, carbonisation gas is produced. The total amount of volatiles is about 25 % [320, Eurofer 2007]. This crude coke oven gas (COG) is exhausted via ascension pipes into the collecting main. The high calorific content of this gas means that after purification it can be used as a fuel (e.g. for battery heating). The coal is heated by the heating/firing system described above and remains in the coke oven until the centre of the coal has reached a temperature of 1000 – 1100 °C.

The complete coking process takes around 14 – 28 hours, depending e.g. on the width of the oven (in case of heating by the side), the density of coal and on the quality of the desired coke (e.g. use in foundries or blast furnaces) [207, Ameling et al. 2004] [223, USEPA 2001]. The coking time is determined by the coal mixture, moisture content, rate of under firing and the desired properties of the coke (e.g. foundry coke requires more time than blast furnace coke). When the coking time is not correct, 'green' coke is produced. Green coke is a bad quality coke that is not preferred by coke producers [223, USEPA 2001].

Figure 5.6 shows the main emissions sources during coking. Due to the positive pressure (10 – 15 mm H₂O column at 5 – 7 m tall ovens) within coke oven chambers, there may be door emissions, emissions from charging holes and ascension pipes and also, where there are wall cracks, emissions of incompletely combusted COG (see Section 5.1.2.2) [320, Eurofer 2007].

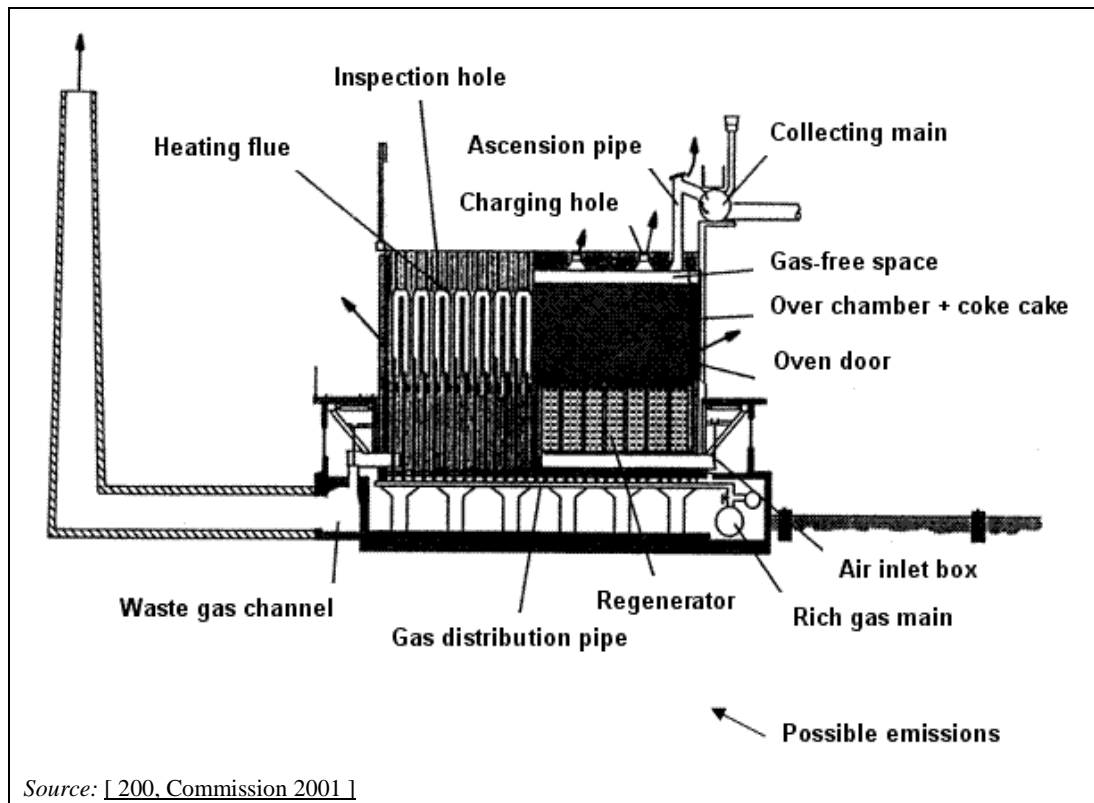

Figure 5.6: Schematic diagram of a coke oven chamber showing possible emissions points during coking (indicated by arrows)

In general, the coke yield varies from 700 to 800 kg dry coke/t dry coal and the gas production varies from 140 to 200 kg COG/t dry coal. However it should be noted that coke yield and COG production and composition depend, to a large extent, on coal composition and coking time.

5.1.2.4 Coke pushing

Fully-carbonised coke is pushed out of the oven into a container by the ram of the pusher machine usually in less than one minute (see Figure 5.7) [223, USEPA 2001] through a coke guide car (transfer machine) into a 'coke quenching car'. Contact with atmospheric oxygen causes the coke to start burning instantaneously.

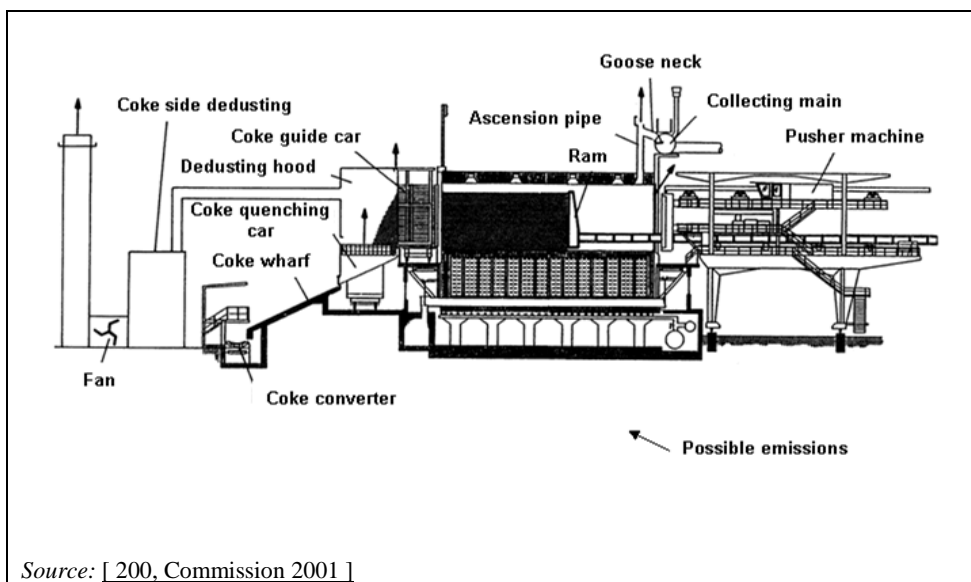

Figure 5.7: Pushing of carbonised coke from the coke oven into a quenching car showing the emissions points

5.1.2.5 Coke quenching

Basically there are two ways of quenching the red hot coke from the coke oven: wet quenching and dry quenching [320, Eurofer 2007] [334, Eurofer 2007]. When applying wet quenching the quenching car transports the coke to the quenching tower. Wet quenching consumes large volumes of water. The temperature of the coke is reduced from 1100 to 80 °C to avoid combustion [223, USEPA 2001]. The water fraction that does not evaporate can be collected and is used in the next batch, thus reducing water consumption [320, Eurofer 2007].

When applying dry quenching, the quenching car takes the hot coke to a vertical quenching chamber. Inert quenching gas circulates around the chamber, which is isolated from the atmosphere, thus preventing combustion whilst cooling the coke. The gas is cooled by a heat exchanger in order to recover thermal energy.

5.1.3 Coke handling and preparation

After quenching, the coke can be stored in stock piles from where it is transported by conveyors (with transfer points), road, rail or any combination of these to a separate building for crushing and screening. At the bottom of the wet quench tower, a small fraction (coke breeze) settles and is conveyed directly to the sinter strand or set aside for the sinter process [227, WB 1998].

Large fractions (20 – 70 mm) are used in the blast furnace or sold to the market [320, Eurofer 2007] [321, Eurofer 2007]. Small fractions (<20 mm) are used for the sinter process and in steel plants, the latter to permit a higher rate of scrap addition.

According to the specific requirements for the sinter process and the blast furnace process, these fractions undergo further crushing in order to meet the required size.

5.1.4 Coke oven gas treatment

[206, Diemer et al. 2004] [223, USEPA 2001]

In principle, there are two options for dealing with the large amount of generated coke oven gas:

- in the first case, the coke oven gas is fully collected and further processed by the cleaning and recovery of by-products. The cleaned coke oven gas (after the removal of economically valuable by-products) is internally or externally used by other steelworks consumers as a fuel in coke oven batteries, hot blast stove (cowper), blast furnaces, for the heating of ignition furnaces in sinter plants, for pusher-type heating furnaces in rolling mills and for electric power generation in power plants
- in the second case, the heat recovery process, the raw coke oven gas is burnt directly at its source in the coking reactor by a prudent air supply and no further recovery steps are necessary. The heat produced is partly used for the coking process. The excess energy is subsequently converted to steam and/or electricity. The heat recovery coking process has been operating successfully in the US since 1998.

The first case is described in more detail below as it is the commonly applied technique in Europe.

Another possibility is to use the cleaned coke oven gas as a raw material in the chemical synthesis of methanol or for hydrogen separation. In China approximately 10 methanol production installations with capacities of 70 – 200 000 tonnes/yr each are in use. An example is the installation in Shaanxi Hancheng Heima Coking Company. Methanol synthesis from coke oven gas after deep desulphurisation in one step with a fixed bed reactor is a technique developed by Second Design Institute of Chemical Industry (SEDIN) which has been in operation since 2006.

5.1.4.1 Collection and treatment of coke oven gas (COG) with the recovery of by-products

Raw COG has a relatively high calorific content due to the presence of hydrogen, methane, carbon monoxide and hydrocarbons. Furthermore, the raw coke oven gas contains valuable products such as tar, light oil (mainly consisting of BTX (benzene, toluene and xylene)), sulphur and ammonia. Table 5.1 shows the composition of raw coke oven gas. For several reasons, the coke oven gas must be treated before use as a fuel.

Table 5.1: Raw coke oven gas yield and composition

Raw gas	Values	Units
Yield	280 – 450	m ³ /t coal
Density	0.42 – 0.65	kg/Nm ³
Lower calorific value	17.4 – 20	MJ/Nm ³
H ₂	39 – 65	vol-%
CH ₄	20 – 42	vol-%
C _x H _y ⁽¹⁾	2.0 – 8.5	vol-%
CO	4.0 – 7.0	vol-%
H ₂ S	4 – 12	g/Nm ³
CO ₂	1 – 3	vol-%
BTX	20 – 30	g/Nm ³
NH ₃	6 – 8	g/Nm ³
PAH	NA	mg/Nm ³

⁽¹⁾ C_xH_y is mainly ethylene and ethane. Others are cyclopentadiene, propane, propylene, butane, acetylene and pentene. Tar oil, tar acids (C_xH_yOH), tar bases (C_xH_yN), heavy hydrocarbons, and crude light oil are removed as liquid products during cooling. Oxygen, nitrogen and water vapour also appear in the composition of raw coke oven gas. PAH (e.g. naphthalene, phenanthrene, benzopyrenes), nitrogen compounds (e.g. pyridine, HCN, (CN)₂ and NO₂) and other sulphur compounds (e.g. COS, CS₂, thiophenes) also appear.

NB: — All given figures are based on the input of dry coal.
— NA = Not available.

Source: [65, InfoMil 1997] [206, Diemer et al. 2004] [223, USEPA 2001] [276, Italy 2007] [320, Eurofer 2007] [322, Eurofer 2007].

The composition of coke oven gas depends on coking time and coal composition. The data given refer to water-free and ash-free coal. Tar and naphthalene in the raw gas may foul the piping and the equipment and should be removed first. For each tonne of coke produced, approximately 25 to 45 kg of tar may be recovered [223, USEPA 2001]. Several products can be recovered from the tar, e.g. pitch, anthracene oil, wash oil, naphthalene oil, carbolic oil (phenol) and light oil [320, Eurofer 2007].

Sulphur compounds and ammonia would cause corrosion of the piping and equipment and the sulphur compounds would cause emissions of SO₂ if raw uncleaned COG were used as a fuel. For each tonne of coke produced, approximately 3 kg of ammonia and 2.5 kg of H₂S are generated.

In some cases BTX is recovered from the raw COG as a valuable by-product. Up to 15 kg of light oil may be recovered per tonne of coke produced. This oil contains benzene, toluene, xylenes, non-aromatics, homologous aromatics, phenol, pyridine bases and other organic compounds such as polycyclic aromatic hydrocarbons (PAH).

Figure 5.8: Typical scheme of a COG treatment plant with the recovery of by-products shows a typical COG treatment plant. The main steps in the process are described below.

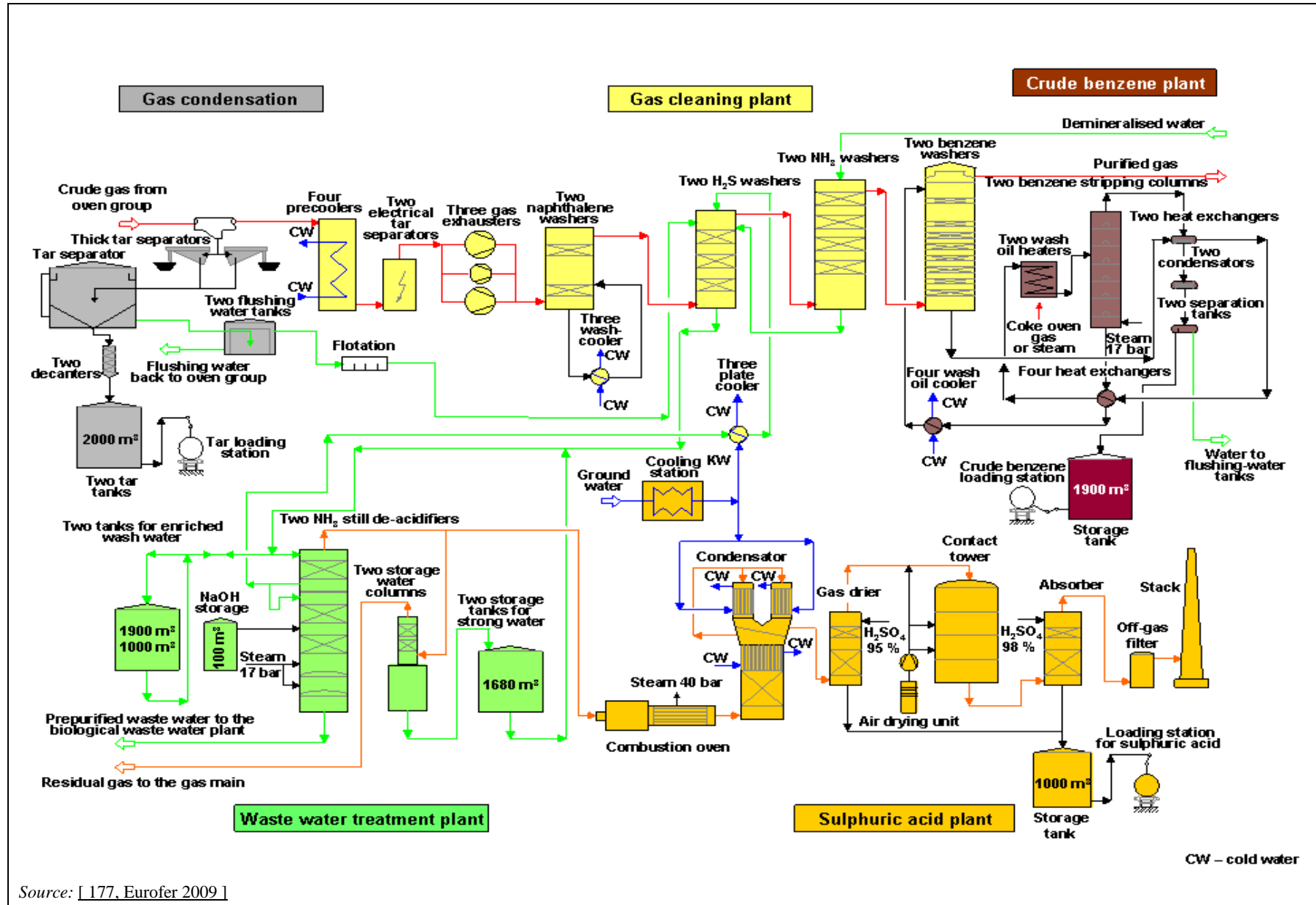

Figure 5.8: Typical scheme of a COG treatment plant with the recovery of by-products

5.1.4.2 Gas cooling

Hot crude oven gas enters the ascension pipes at a temperature of approximately 1000 °C. Gas cooling is carried out by the means of different liquids. Figure 5.9 shows schematic diagram of example water flows in a coke oven plant. However, many other alternative layouts exist.

In the gooseneck, it is directly cooled by an ammonia liquor spray to a steam saturation temperature of around 80 °C. This requires 2 – 4 m³ of ammonia liquor for every tonne of coal carbonised.

The liquid phase built by the used ammonia liquor and the condensate of the coal moisture and chemical water is fed to the tar/water separator, whilst the gas phase is led to the primary coolers. It used to be common for primary coolers to be operated as open systems. Nowadays, indirect cooling with closed cooling systems is more frequent. When sufficient cooling water of the right temperature is available, the gas can be cooled to below 20 °C, given a moderate ambient temperature. Under these conditions, most of the higher boiling point compounds and the water from the steam fraction of the gas will condense [320, Eurofer 2007].

Droplets and particles are precipitated in the downstream electrostatic tar precipitators before the gas is drawn into the washing facilities by exhausters (suction fans). Occasionally, electrostatic tar precipitators are installed downstream of the exhausters. The precipitate from the electrostatic tar precipitator is also led to the tar/water separator.

The suction fans cause compression of the gas, and even if the fans are such that this is only slight, the associated temperature increase cannot be tolerated in view of the downstream processing conditions. This makes it essential to use ‘final coolers’.

Final coolers may be indirect or direct. When direct cooling is applied, the cooling water absorbs the impurities from the COG. Subsequently at the end of the cooling cycle, during return-flow cooling using natural draught or fan coolers, emissions are inevitably generated. Closed systems are therefore usually preferred for final cooling, though open circuits are still operated at some plants [320, Eurofer 2007].

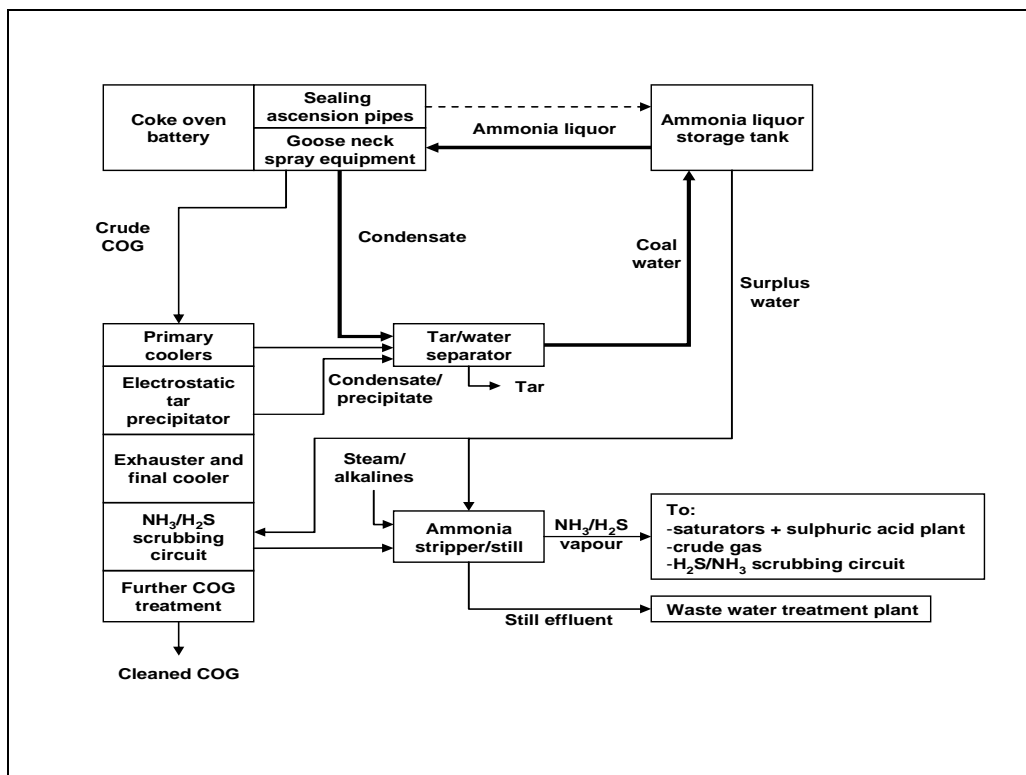

Figure 5.9: Schematic diagram of example water flows in a coke oven plant

5.1.4.3 Tar recovery from the coke oven gas

Most of the water and the high-boiling point hydrocarbons are condensed during coke oven gas cooling. The condensate from the pipes and the electrostatic tar precipitator is led to the tar/water separator, where the tar is recovered. The water phase is separated off as 'coal water' and led to the ammonia liquor storage tank. From there the surplus water goes to the ammonia stripper/still or to the H₂S washers.

Sometimes scrapers are installed to remove coal tar residues (thick tar) from the condensate. This coal tar contains reasonable amounts of PAH and is usually fed back to the coal feed [320, Eurofer 2007].

5.1.4.4 Desulphurisation of coke oven gas

Coke oven gas contains hydrogen sulphide (H₂S) and various organosulphur compounds (carbon disulphide (CS₂), carbon oxysulphide (COS), mercaptans, etc.). All wet desulphurisation techniques in use are highly efficient at removing H₂S. They are less efficient at removing organosulphur compounds. Commercial coke oven gas desulphurisation processes can be divided into two categories:

- processes using wet oxidation to produce elemental sulphur (S⁰)
- processes which absorb and strip hydrogen sulphide (H₂S) for subsequent conversion into sulphuric acid (H₂SO₄) or elemental sulphur.

All wet oxidation processes utilise a reduction oxidation catalyst to facilitate the wet oxidation of hydrogen sulphide to elemental sulphur or sulphate. All these processes are characterised by very efficient removal of hydrogen sulphide (efficiency of >99.9 % for achieving residual H₂S concentrations as low as 1 – 10 mg/Nm³, depending on the inlet concentration), but have the disadvantage of producing highly contaminated waste water and/or air, which makes elaborate treatment facilities a necessary part of the process [153, UN-ECE 1990] [320, Eurofer 2007].

Absorption/stripping processes are characterised by generally lower H₂S removal (achieving residual H₂S concentrations as low as <1000 mg/Nm³, depending on the inlet concentration) but, since air is not included in the regenerating system and no toxic catalysts are used, emissions to air and water of process-related chemicals are minimised or eliminated. The processes can be operated to produce sulphuric acid (sulphuric acid plants), or a very high-purity elemental sulphur (Claus plants). Further developed absorptive processes such as the optimised OxyClaus[®] process or the ASK (ammonium sulphide Kreislaufwäscher) process, which is an ammonium sulphide scrubbing circuit, achieve efficiencies of >95 % desulphurisation with a residual H₂S concentrations in the coke oven gas of usually between 50 – 500 mg/Nm³.

A common process combination is NH₃/H₂S circuit scrubbing in the low pressure stage and potassium carbonate scrubbing (vacuum carbonate process) in the high pressure stage, combined with a BTX washer either at a low or at an enhanced pressure. Potassium carbonate scrubbing at both pressure stages, combined with a BTX washer is also common.

5.1.4.5 Recovery of ammonia from the coke oven gas

The ammonia formed during coking appears in both the coke oven gas and the condensate (weak liquor) from the gas. Typically 20 – 30 % of the ammonia is found in the weak liquor.

The processes described below are applied commercially to remove ammonia from the coke oven gas:

- the $\text{NH}_3/\text{H}_2\text{S}$ scrubbing circuit: in this process, the ammonia is scrubbed from the coke oven gas in an ammonia scrubber using water or dilute liquor wash as a scrubbing liquid. The effluent from the ammonia scrubber is used as a scrubbing liquor in the H_2S scrubber. The effluent from the H_2S scrubber contains H_2S and NH_3 and is led to the ammonia stripper and the still. This process is also known as the Carl Still, Diamex or ASK) process, which is an ammoniumsulphide scrubbing circuit. Some scrubbers use packed columns for the scrubbing system [204, Neuwirth et al. 2003] [320, Eurofer 2007]
- direct recovery as ammonium sulphate ($(\text{NH}_4)_2\text{SO}_4$): two types of this process can be used:
 - the Otto-type absorber and the Wilputte low differential controlled crystallisation process: in both systems the COG is sprayed with a dilute sulphuric acid solution and ammonium sulphate is yielded
 - direct recovery as anhydrous ammonia (NH_3): the recovery of ammonia from the gas as anhydrous ammonia was developed by the United States Steel Corporation under the name USS PHOSAM. In this process, ammonia is scrubbed from the COG by countercurrent contact with an ammonia-lean phosphate solution (phosphoric acid). Ammonia removal efficiency is 98 – 99 % [153, UN-ECE 1990].

5.1.4.6 Recovery of light oil from coke oven gas

The gas leaving the ammonia absorbers contains light oil, a clear yellow-brown oil with a specific gravity of 0.88. It is a mixture of COG products with boiling points mostly between 0 and 200 °C, containing well over a hundred constituents. Most of these are present in such low concentrations that their recovery is seldom practicable. The light oil is usually referred to as BTX. The principal usable constituents are benzene (60 – 80 %), toluene (6 – 17 %), xylene (1 – 7 %) and solvent naphtha (0.5 – 3 %). Four main methods are used for the recovery of light oil [153, UN-ECE 1990]:

- refrigeration and compression to temperatures below -70 °C and pressures of 10 hPa.
- adsorption by solid adsorbents, in which the light oil is removed from the gas by passing the latter through a bed of activated carbon and recovering the light oil from the carbon by heating with indirect or direct steam [320, Eurofer 2007]
- absorption by solvents, consisting of washing the COG with a petroleum wash oil, a coal tar fraction or other absorbent, followed by steam distillation of the enriched absorbent to recover the light oil.

5.1.5 Water flows from coke oven and by-product plants

Figure 5.9 shows an example of possible water flows in a coke oven plant. However, many other alternative layouts exist.

The main water flows to be drained from the coke oven results from the steam or ammonia liquor used in the goosenecks for the suction and direct cooling of the charging gases, the coal moisture and ‘chemical water’ (which is formed during the coking process).

Additional condensates occur from the coke oven gas treatment in the by-product plant in case of direct cooling, in the electrostatic precipitator and the scrubbing units.

The condensed water and tar from the collecting main (downstream of the gooseneck), the coolers and the electrostatic precipitator are led to the tar/water separator.

Primary cooling can be conducted by direct, or more usually, by indirect cooling. In the case of indirect cooling, the water is circulated in a close cycle and will not influence the waste water quantity. In the case of direct gas cooling, the cooling water is considered to be a washing liquor and is eventually drained via the still.

Water losses occur during the recooling of cooling waters and condensates by evaporation of the cooling waters.

The water from the tar/water separator referred to as 'coal water' contains high concentrations of ammonia and is led to the ammonia liquor storage tank.

The ammonia liquor storage tank provides water for the gooseneck spray equipment. The surplus water from the ammonia liquor storage tank is led to the ammonia stripper/still [320, Eurofer 2007] or to the H₂S washers [102, Eurofer 2008]. Together with parts of the steam used in the ammonia stripper/still and the scrubbing liquor from the NH₃/H₂S scrubbing circuit these waters generate the waste water referred to in Table 5.2.

It should be noted that usually all water flows, except for water from indirect cooling systems and wet oxidative desulphurisation systems, are eventually drained from the ammonia still and led to a waste water treatment plant.

High concentrations of NH₃ are present in the ammonia still. There are several reasons for decreasing the ammonia concentration before discharging the water to a waste water treatment plant or to the environment:

- the ammonia can be recovered as a valuable by-product (as ammonium sulphate or anhydrous ammonia)
- free ammonia is highly toxic for aquatic ecosystems (including biological waste water treatment plants)
- ammonia has a very high specific oxygen demand (it requires 4.5 times its own weight of oxygen for oxidation to nitrates). Thus, there is a risk of oxygen depletion of the waste water treatment plant or the recipient water.

These reasons have led to ammonia strippers being installed in almost all coke oven plants. This device strips H₂S and NH₃ from the liquid by steam and alkaline additions. The vapours are subsequently led to the crude gas or to the NH₃/H₂S scrubbing circuit (to improve H₂S scrubbing efficiency) or to a sulphuric acid plant, where NH₃ and H₂S are incinerated together. Sometimes the NH₃ is removed from these vapours in saturators, producing ammonium sulphate [320, Eurofer 2007].

The most commonly used alkali is caustic soda (NaOH). Formerly, slaked lime (CaOH₂) was often used.

Some possible water flows that were not indicated in Figure 5.9 include:

- waste water from BTX recovery which is led to the tar/water separator
- phenol (concentration >3 g/l) which may be recovered from the coal water by a solvent extraction process, before the coal water is led to the ammonia liquor storage tank
- waste water from the oxidative desulphurisation processes which is usually discharged separately after pretreatment
- chemical water from the (optional) sulphuric acid plant which is usually led to the still
- chemical water from the (optional) Claus process which will usually not be condensed but discharged to the atmosphere via a stack [21, EC Coke 1996]. An alternative is to inject this water into the raw gas before treatment

- indirect gas cooling water which is recirculated and will not influence the waste water quantity. In the case of direct gas cooling, the cooling water is considered to be a washing liquor and is eventually drained via the still.

5.2 Current emission and consumption levels

5.2.1 Mass stream overview and input and output data

Figure 5.10 shows an overview of the input and output mass streams of a coke oven treatment plant. This overview might be used for the collection of data from single coke oven plants.

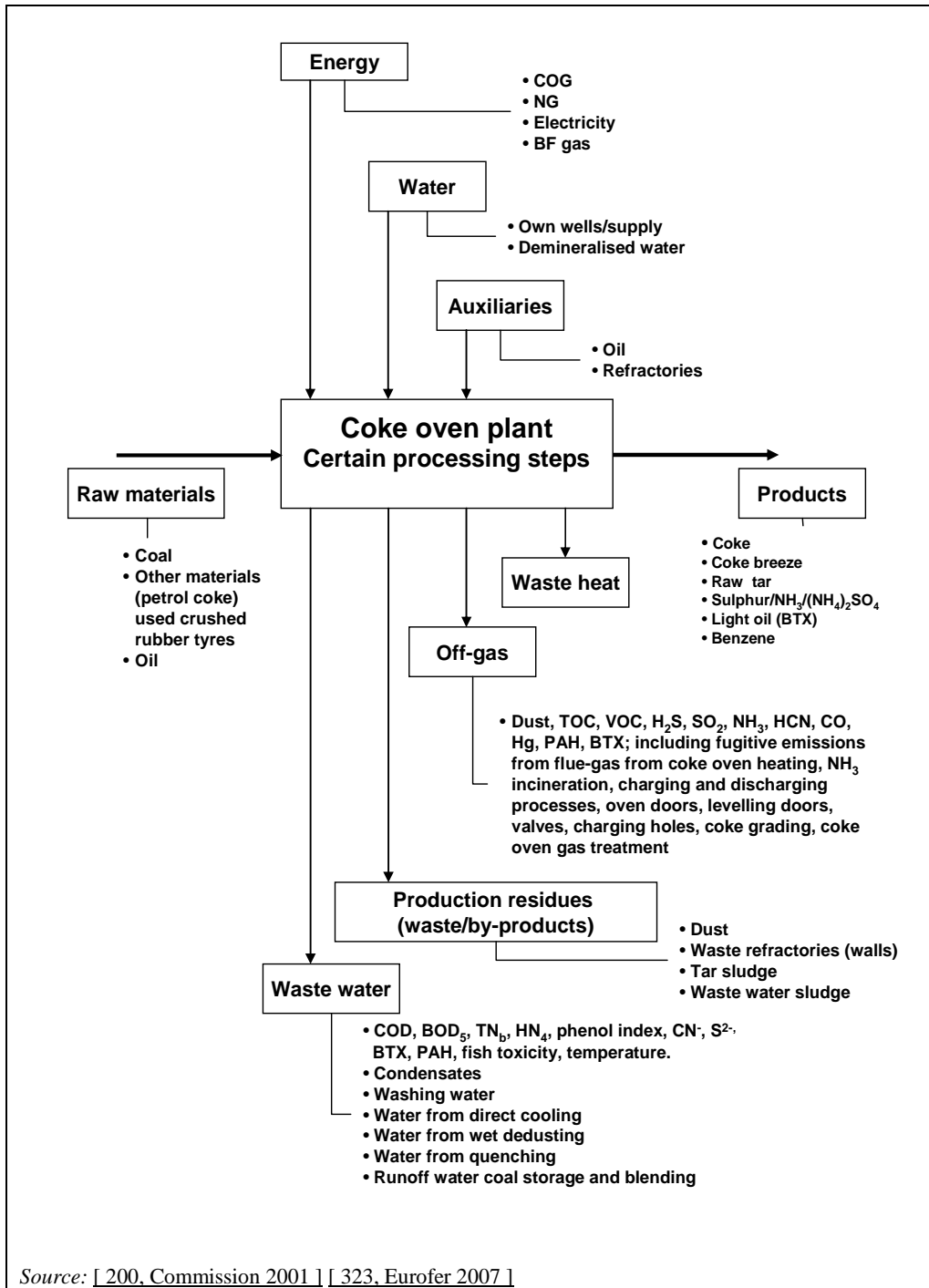

Figure 5.10: Mass stream overview of a coke oven plant

Specific input factors and emission factors have both been determined for coke ovens. Input and output data from coke oven plants in different EU Member States from 2005 complemented by other references are shown in Table 5.2.

Table 5.2: Input and output data from coke oven plants in different EU Member States from 2005 complemented by other references

Input			Output		
Raw materials			Products		
Coal (dry)	kg/t coke	1220 – 1350	Coke (dry)	kg/t	1000.0
			COG	Nm ³ /t coke	360 – 518
			NetCV of COG	kJ/Nm ³	17000 – 18000
Energy			Energy	MJ	7200 – 9000
BF gas + COG	MJ/t coke	3200 – 3900	Steam ⁽²⁾	MJ/t coke	9 – 267/1500 ⁽⁴⁾
Electricity	MJ/t coke	20 – 230 ⁽¹⁾	Air emissions ⁽⁵⁾		
			Dust	g/t coke	15.7 – 298 ⁽¹⁾
Steam			SO _x ⁽⁶⁾	g/t coke	80 – 900 (2820) ⁽⁷⁾
	MJ/t coke	60 – 800 ⁽³⁾	NO _x	g/t coke	336 – 1783 ⁽¹⁾
Compressed air	Nm ³ /t coke	1 – 15	NH ₃	g/t coke	0.5 – 24.7
Oxygen	Nm ³ /t coke	0.0007	H ₂ SO ₄	g/t coke	2 ⁽⁹⁾
Nitrogen ⁽⁸⁾	Nm ³ /t coke	0.0047	HCN	g/t coke	0.05 – 1.87
Acetylene	g/t	0.24	H ₂ S	g/t coke	12 – 100 ⁽¹⁾
Water			CO	g/t coke	200 – 4460 ⁽¹⁾
Process water ⁽¹⁰⁾	m ³ /t coke	0.24 – 1.5	CO ₂	kg/t coke	160 – 860 ⁽¹²⁾
Quenching water ⁽¹¹⁾	m ³ /t coke	0.5 – 1	CH ₄	g/t coke	1 – 80 ⁽¹³⁾
			TOC	g/t coke	12 – 24 ⁽²⁾
			Benzene	g/t coke	0.1 ⁽¹⁴⁾ – 45
			PAH ⁽¹⁵⁾	mg/t coke	115 – 1091 ⁽¹⁶⁾
			PCDD/F	ng I-TEQ/Nm ³	<0.1 ⁽¹⁷⁾
			Production residues (waste/ by-products)		
			Benzene	kg/t coke	5.3 – 14
			Light oil (BTX)	kg/t coke	9.1 – 14
			H ₂ SO ₄ ⁽⁹⁾	kg/t coke	4.2 – 9
			Tar	kg/t coke	26 – 48
			(NH ₄) ₂ SO ₄ as SO ₄ ²⁻ ⁽¹⁸⁾	kg/t coke	28 – 48
			Sulphur ⁽¹⁹⁾	kg/t coke	0.9 – 2
			Sodium phenolate	kg/t coke	1.4
			Waste water	m ³ /t coke	0.1 – 0.5

⁽¹⁾ High value for old plants with cracks in the oven walls (older than 20 years).

⁽²⁾ Values up to 983 g/t coke produced have been reported but they are not considered to be representative of the EU coke ovens [110, Brouhon 2008].

⁽³⁾ Old plants (older than 20 years) can have a steam consumption of 1200 MJ/t coke.

⁽⁴⁾ High values in cases of coke dry quenching (with heat recovery in the form of steam); value of 270 MJ/t coke from two plants which have been in operation for 14 and 15 years respectively; value of 1500 MJ/t coke from a plant which has been in operation for about 7 years.

⁽⁵⁾ Off-gas flow from battery under firing only is approximately 1000 – 1700 m³/t coke, depending on the combustion air demand for the different fuel gases.

⁽⁶⁾ The H₂S content of coke oven gas is analysed and a sulphur balance is made. The emissions include heating with coke oven gas, burning raw gas, quenching, shutdown of the catalytic cracker and the Claus plant and the operation of old combustion chambers.

⁽⁷⁾ The high value of this range indicates no or insufficient desulphurisation.

⁽⁸⁾ Some nitrogen is consumed from bottles.

⁽⁹⁾ In case of SO₂ absorption and H₂SO₄ production as the final by-product.

⁽¹⁰⁾ Process water corresponds to the 'total flow' mentioned in Table 5.24.

⁽¹¹⁾ Water losses due to evaporation.

⁽¹²⁾ Depending on the kind of fuel gases.

⁽¹³⁾ Only data from one plant available.

⁽¹⁴⁾ Low value for one modern plant (about 5 years old).

⁽¹⁵⁾ PAH as EPA 16 (sum of the following 16 PAH: (Σ (FLU+PYR+TRI+CPP+BaA+CHR+BNT+BeP+BbF+BkF+BaP+DbahaA+BghiP+INP+ANT+COR)))
Calculated from measurements taken from pushing, quenching and emissions from the stack of the battery.

⁽¹⁶⁾ Only data from three plants available.

⁽¹⁷⁾ Data from one installation in Germany.

⁽¹⁸⁾ In the case of SO₂ absorption with ammonia liquor.

⁽¹⁹⁾ In the case of SO₂ absorption and sulphur recovery as elemental sulphur.

Source: [110, Brouhon 2008] [177, Eurofer 2009] [206, Diemer et al. 2004] [210, Brouhon 2006] [218, Dong et al. 1988] [223, USEPA 2001] [225, Brouhon 2006] [226, EEA 1999] [227, WB 1998] [228, UNEP 2001] [234, Poland 2007] [237, USEPA 2003] [320, Eurofer 2007] [324, Eurofer 2007].

It should be noted that Table 5.2 should not be used for proper calculations, e.g. benchmarking purposes, since it comprises the performances of existing and new plants all over Europe which results in very wide ranges of emission factors. Furthermore it should be pointed out that not all operators provided information. Table 5.2 only includes the emissions from stacks and quenching towers. Stack emissions occur from the under firing and the cleaning of the collected emissions during charging and pushing, if applied. It does not include non-captured diffuse or fugitive sources caused by battery operation or by the by-products. The emissions data represent the emissions after abatement; they do not comprise emissions from coal and coke handling due to missing information, but these emissions are of less significance. Information about the determination of the data such as sampling methods, analysis methods, time intervals, computation methods and reference conditions is not entirely available for all given data in this section.

Table 5.3 gives the emission factors for specific compounds and should be seen as a complement to Table 5.2.

Table 5.3: 2004 output data from a Polish coke oven

Location	Benzo(a) pyrene	Pyridine	Toluene	Xylene	Phenol	CS ₂
	g/t coke					
Directed emissions sources	0.012	2.35	0.74	0.69	5.67	0.30

Source: [234, Poland 2007].

5.2.2 Environmental issues for the coke-making process

The coke oven plant is primarily a source of dust and gaseous emissions to air. When abatement techniques are applied to reduce emissions, cross-media effects occur. Generally, the information given in Section 5.2.2.1 to 5.2.2.5 below describe the most relevant environmental issues for coke ovens plants.

5.2.2.1 Emissions to air

It should be noted that coke oven plants have a relatively large number of emission sources. However, it is necessary to distinguish between the following three types of emission sources:

- directed emissions sources, like stacks for the off-gas from battery heating or from the various dedusting facilities, which are transported by pipes and leave via the stack. They can be treated and minimised. They can be measured without any problems in most cases (e.g. according to the rules of the Verein Deutscher Ingenieure VDI)
- diffuse emissions which occur during regular operation, e.g. coal and coke handling, transport of coal and coke, coal blending beds, ascension pipes, coke pushing and coke quenching. If these are not captured, they can be released through the roof, roof-hatch, windows or from stored material. Minimisation is possible only by prevention and/or further treatment after transferring them into ducted emissions (i.e. by capturing them)
- fugitive emissions which occur during irregular operation from leakages at the battery, e.g. because of leakage from vessels, oven doors, flanges, or at the by-product plant. For minimisation, the first option is to prevent emissions by good maintenance. PAH compounds, like benzo(a)pyrene (BaP), and benzene play an important role with regard to fugitive emissions [320, Eurofer 2007] [324, Eurofer 2007].

Diffuse and fugitive emissions are difficult to quantify.

In many cases, the emissions from the different sources vary considerably over time (e.g. semi-continuous emissions from doors, lids, ascension pipes and discontinuous emissions from pushing and quenching).

Comparison of emission factors between plants also needs to take account of plant-specific parameters. For instance, specific door emissions vary widely depending upon the type of doors, the size of ovens and the quality of maintenance. Maintenance can be a determining factor. Indeed, examples of good results with traditional (knife-edged) doors on well-maintained small ovens and poor results with modern flexible sealing doors on poorly maintained large ovens can be found. This should be borne in mind when assessing the information on individual emission sources to air given in Table 5.4. The wide range of values for emissions factors can primarily be explained by the maintenance programme, the degree of care taken in its performance (enabling smooth and stable operating conditions) and the abatement techniques applied [320, Eurofer 2007] [324, Eurofer 2007].

Estimation method of emissions from coke oven leaks and openings

Because of the high expenditure for leakage monitoring, there is very little actual data available for non-captured emissions caused by battery operation as shown in Table 5.4, where the situation of coke plants in the EU is described by the emission factors given. The results are supported by measurements from various plants in Europe, which differ in age, state of repair as well as in the emissions control techniques applied. The monitoring was carried out by capsulation of the leakages when a sample from the formed space was taken. While the lower level of the given range represents emissions from modern plants in a good state of repair, the higher emissions relate to older plants with poorer emissions control techniques and/or in a worse state of repair. Comparison of the figures in Table 5.4 shows that emissions from door leakages represent the largest portion of all fugitive emissions from the battery. The accuracy of these emissions factors, especially for BaP emissions, could be confirmed by reverse dispersion calculations, and by single emissions measurements from 7 m doors which gave specific emissions of BaP only up to 10 mg/t (coke). However, measurements taken at the doors with the most modern sealing systems showed that emissions of below 1 mg/t (coke) could be achieved [320, Eurofer 2007] [324, Eurofer 2007].

Fugitive emissions occur from the ascension pipe and charging hole sealings and from the oven doors and frame seals during coking. In addition to the direct measurements of fugitive emissions as described before, different methods for estimating these fugitive emissions from coke ovens are in use and all these methods have one thing in common: experienced or certified observers visually determine the visual emissions.

From these results achieved emission levels are expressed as a frequency of leaking percentage of the total number of openings at the battery showing visible leaks or mass/time depending on the monitoring method. For example the EPA 303 method enables the results from the observation procedure to be expressed in percentages of leakage.

However the DMT (Deutsche Montan Technologie GmbH) methodology, which is to a large extent consistent with the EPA method, allows emissions per day based on basic measurements to be calculated, assigning four different degrees of strength to the emissions and taking the duration of the visible emissions during the observation into consideration. Another method was developed by BCRA (British Carbonization Research Association). In contrast to the DMT method, the visible emissions are assigned five different degrees of strength. Another method which is used at Corus IJmuiden in the Netherlands is described in Section 5.3.3.

As there are still older plants in Europe which can be in bad condition, the emission situation for all European coke plants can best be described by the complete range of factors given in Table 5.2. In the case of temporary failure, the actual emissions can exceed the range quoted.

The values for CO are usually reported to be higher than those indicated in Table 5.5. The emissions concentration is very much relative to the design, the age, and the maintenance of the

combustion chambers. High CO values indicate incomplete combustion resulting in high CO stack emissions. Usually the specific emissions concentrations for CO are about or below 1000 g/t coke.

Coal handling and preparation

Diffuse dust emissions are associated with material handling operations. These operations consist of the unloading, storing, crushing and screening of coal. No information about emissions caused by these operations has been submitted.

Coal charging

During the coal charging of pulverised coal, not only do particular dust emissions occur, but also organic compounds such as benzene and BaP from coal decomposition and SO₂, H₂S and NH₃ are emitted [223, USEPA 2001] [320, Eurofer 2007], [324, Eurofer 2007].

The charging concept and the geometry and proper sealing of the charging holes and systems are very important elements in the reduction of charging emissions.

While charging, a distinction can be made between:

- emissions near the charging holes during the charging process itself
- evacuation and cleaning of the charging gases
- leveller door emissions during the levelling of the coal with the leveller bar
- diffuse emissions from material spilled onto the oven deck.

Factors for diffuse or fugitive emissions to air caused by battery operation of coke oven plants are given in Table 5.4.

Table 5.4: Factors for diffuse or fugitive emissions to air caused by battery operation of coke oven plants

Operation	Emissions						
	Dust (g/t)	CO (g/t)	SO ₂ (g/t)	H ₂ S (g/t)	NH ₃ (g/t)	Benzene (mg/t)	BaP (mg/t)
Charging	0.3 – 10	0.1 – 71	0.01 – 1		<0.3	10 – 1200	0.02 – 4.5
Coking:							
Doors	0.3 – 6	1.5 – 30	0.1 – 1.5	0.02 – 1	0.1 – 1.5	200 – 14000	4.5 – 45
Lids	0.2 – 1	1.5 – 9	0.1 – 1	<0.01	0.1 – 0.3	800 – 8000	9 – 15
Ascension pipes (off-takes)	<0.2	0.003 – 0.3	0.01 – 0.1	<0.01	<0.01	10 – 100	0.3 – 3

Source: [200, Commission 2001].

Coke oven undergrate heating and firing

Directed emissions from the stacks occur during the combustion of fuel gases used to heat coke ovens. Sulphur dioxide emissions may be present if coke oven gas is not completely desulphurised. COG contains aromatic components (mainly BTX as shown in Table 5.1). If COG is used without scrubbing, these aromatic compounds have the tendency to form soot (which contains PAH) [213, Bittner et al. 1983] [214, Richter et al. 2000].

One source of fugitive emissions from the coke ovens that causes public concern is the black emissions from the battery combustion stacks of the coke ovens. Black emissions are caused by incomplete combustion of the fuel gases used to heat the ovens, or when leakage occurs from the ovens to the heating walls. In this case, coal fines and coking decomposition products may leak from the coke oven into combustion exhaust gases.

Table 5.2 shows emissions factors of between 336 and 1783 g/t coke for NO_x. For existing modern plants which have already incorporated low-NO_x techniques, such as staged air

combustion and waste gas recirculation, NO_x concentrations of 322 – 414 mg/Nm³ at 5 % O₂ are reported. For existing plants without process-integrated deNO_x measures, achievable levels for NO_x are in the higher range up to 1783 g/t coke, with concentrations up to 1700 mg/Nm³ at 5 % O₂).

Table 5.5 provides emissions data for directed emissions concentrations from coke oven plants in Germany and the Czech Republic.

Table 5.5: Directed emissions concentrations from coke oven plants in Germany and the Czech Republic

Location	Dust	CO	NO _x	SO _x	PCDD/PCDF
	(mg/Nm ³)				(ng I-TEQ/Nm ³)
Coke oven undergrate firing ⁽¹⁾	0.8 – 4.8	20	322 – 414	111 – 157 ⁽²⁾	0.001
Coke pushing	0.9 30 ⁽³⁾				
Coke grading plant	0.5 – 4.5 100 ⁽³⁾				
⁽¹⁾ Data for the use of mixed gas, coke gas or desulphurised coke gas at two coke oven plants. ⁽²⁾ Values after coke gas desulphurisation. ⁽³⁾ Czech data [372, Czech TWG member 2008]. NB: All data are annual averages. Reference oxygen content for particulates, NO _x and SO _x is 5 %. Source: [220, Eurofer 2008] [244, Plickert 2007] [372, Czech TWG member 2008].					

Emissions from flaring off or bypassing COG

On rare occasions, the production of COG exceeds demand. In these cases, and for safety reasons, the excess COG must be flared off. The flaring of coke oven gas generates some emissions. An estimation for one example is shown in Table 5.6 [223, USEPA 2001].

Table 5.6: Estimation of emissions from COG flaring

Parameter	Emissions	Unit
CO	2.4	kg/t
CO ₂	390	kg/t
H ₂ S	0.05	kg/t
Heavy hydrocarbons	0.85	kg/t
SO ₂	6.5	kg/t
Source: [223, USEPA 2001].		

Bypassing can also be necessary due to maintenance of the sulphuric acid plant. During these periods, the raw coke oven gas is used as a fuel for coke oven firing leading to increased SO₂ emissions.

Coking

The coking process starts immediately after coal charging. In addition to the coal moisture, carbonisation gas is produced. The total amount of volatiles is about 25 % [320, Eurofer 2007]. This crude COG is exhausted via ascension pipes into the collecting main. Due to the positive pressure (10 – 15 mm H₂O column 5 – 7 m tall ovens) within coke oven chambers, there may be diffuse and fugitive door emissions, emissions from charging holes and ascension pipes and also, where there are wall cracks, emissions of incompletely combusted COG via the heating gases. Figure 5.6 shows the main emissions sources during coking. Table 5.4 gives some ranges for the corresponding emissions factors for some pollutants during the coking process.

Coke pushing

Prior to pushing, the oven doors are automatically taken away. Eventually the fully carbonised coke is pushed out of the oven by a coke guide car (the coke transfer machine) into a 'coke quenching car'. The coke transfer machine is equipped with hoods. Emissions during pushing are collected by the pusher machine via an adequate extraction flow. Subsequently the off-gas is treated in a dust abatement device.

In cases where bag filters are applied, sparks need to be precipitated prior to the filter. As an annual average after a bag filter, the dust emissions concentration has been observed to be below 1 mg/Nm³ in one plant (see Table 5.5) [244, Plickert 2007].

Coke quenching

Quenching hot coke with cold water creates thermal shock, releasing particulates from hot coke. Water vapour from water heated during contact with hot coke rises from quenched coke and pulls up dust from the coke mass. In addition, dissolved solids from the quench water may also become extracted in the steam plume rising from the tower. For the quenching process, the main components of the emissions are dust, CO, NH₃ and H₂S. Additionally, traces of different organic compounds can be emitted particularly when the coal is not fully coked. The emissions from quenching are considered to be within the ranges given in Table 5.7. Quenching towers can be equipped with a spraying system for dust abatement.

Table 5.7: Emissions factors for directed emissions from coke quenching towers

Location	Dust	CO	H ₂ S	NH ₃
	(g/t coke)			
Coke quenching	10 – 50 ⁽¹⁾	100 – 2000	25 – 150	1 – 8
⁽¹⁾ The values for dust depend very much on the kind of dust sampling. Isokinetic sampling results in higher emissions values.				
Source: [109, Hein, M. et al 2000] [200, Commission 2001].				

Coke handling

Usually after quenching, the coke is conveyed to a separate building for crushing and screening. This generates particulate emissions which need to be extracted and this requires further abatement. The use of cyclones can reduce the emissions to 3 g/t coke. The dust emission concentration as an annual mean after a bag filter has been observed to be between 0.5 and 4.5 mg/Nm³ respectively in two plants (see Table 5.5) [244, Plickert 2007]. The handling of dry quenched coke causes more dust emissions than the handling of wet quenched coke [276, Italy 2007] [320, Eurofer 2007] [321, Eurofer 2007].

COG treatment and by-product processing

Emissions from by-product processing like light oil, tar, naphthalene, phenol and ammonia are mainly organic compounds. Usually the by-product plant installations consist of closed processes. Fugitive emissions occur from leakages of, e.g. pumps, valves, exhausters, pressure relief devices and losses during transfers. Few data could be found for estimations of fugitive emissions from coke oven by-product plants based on measurements (see Table 5.8).

Table 5.8: Emissions factors for fugitive emissions from by-product plants

Location	Benzene	BaP	PAH
	(mg/t coke)		
By-product plant	100 – 24000 ⁽¹⁾ 4000 – 26000 ⁽²⁾	0.06 – 0.09	1.5 – 4.5
⁽¹⁾ The higher values are for plants without a gas balancing pipe system.			
⁽²⁾ Data from US by-product plants referring to tables C54 – C57 from [237, USEPA 2003].			
Source: [200, Commission 2001] [237, USEPA 2003].			

The estimations are made for plants using the maximum achievable control technology (MACT). Examples for such technologies are gas blanketing, gas balancing or vapour recovery. For plants not using MACT the emissions can be significantly higher. For some plants the reported annual Benzene emissions are in the range of 200 – 320 tonnes.

One method for describing procedures for the measurement of volatile organic compounds fugitive emissions is the EPA method 21. A complete methodology for a comprehensive inventory of the leaks and the further management of fugitive emissions is described in [216, sniffers et al. 2006].

5.2.2.2 Water usage and waste water

Figure 5.9 shows an example of possible water flows in a coke oven plant. However, many other alternative layouts exist.

Use of water

[320, Eurofer 2007] [325, Eurofer 2007]

A wide variety of processes and variants are used for the downstream processing of coke oven gas. The amount of waste water originated by gas treatment plants depends on the water demand, for instance steam, fresh water addition to the washing liquids, diluting water, etc.

A substantial proportion of water to be drained from the coking process is the coal moisture from the coke oven. The average moisture content of coal is about 8 – 15 %, i.e. 0.08 – 0.15 m³/t coal. Thus, a representative coke yield of 780 kg coke/t coal produces a water flow of about 0.1 to 0.17 m³/t coke.

Thermal decomposition of coal generates additional water. Depending on the coal quality, 3 – 5 wt-% of ‘chemical water’ is produced which corresponds to 0.03 – 0.05 m³/t coal corresponding to 0.04 – 0.06 m³/t coke.

If steam injection is used for aspiration (cooling and suction of charging gases), condensation of this steam will result in further water being produced in the primary coolers. The condensate is then also part of the waste water from the coke oven plant.

The condensed water and tar from the collecting main (downstream of the gooseneck), the coolers and the electrostatic precipitator are led to the tar/water separator where the ‘coal water’ is separated off [21, EC Coke 1996]. This water is led to the ammonia liquor storage tank. The ammonia liquor storage tank provides water for the gooseneck spray equipment. The surplus water from the ammonia liquor storage tank is led to the ammonia stripper/still [320, Eurofer 2007] or to the H₂S washers [102, Eurofer 2008]. Together with parts of the steam used in the ammonia stripper/still this water corresponds to the process water referred to in Table 5.2.

Cooling water

[320, Eurofer 2007]

Cooling by the use of water comprises:

- the direct cooling of the hot crude COG with ammonia liquor
- the further primary cooling of the crude COG (indirect or direct)
- the further cooling (indirect)
- the recooling of the condensates or the waters from indirect cooling.

For direct cooling of COG in the gooseneck, between 6 and 10 m³ ammonia liquor/t coke are normally used and kept in a closed circuit. In the case of a coke plant capacity of 100 to 300 t/h this equates to 600 up to 3000 m³ ammonia liquor per hour.

Normally most cooling water is used for indirect cooling. In the case of indirect primary cooling in coke oven gas (COG) treatment, the water is recirculated in a closed loop and will not influence the waste water quantity. In the case of direct gas cooling, the cooling water should be considered to be a washing liquor and it is eventually drained via the still.

Water losses occur during the recooling of cooling waters and condensates by evaporation of cooling waters, e.g. in cooling towers. The amount of fresh water to replace evaporation and drainage losses from recooling is of around 6 – 10 m³/h, which equates to 1 – 2 % of the used water.

Cooling water management in a coke oven plant primarily depends on local conditions, above all on the availability of fresh water and on legal requirements. Legal constraints of the local authorities in some countries demand the avoidance of plumes or the formation of industrial snow and ice during the winter period from recooling towers, which prevents further cooling water recycling. In such cases of a once-through cooling system, the cooling water demand is about 17 m³/t coke.

Waste water from the coke oven plant

[227, WB 1998]

The ammonia liquor storage tank provides water for the gooseneck spray equipment. The surplus water from the ammonia liquor storage tank is led to the ammonia stripper/still [320, Eurofer 2007] or to the H₂S washers [102, Eurofer 2008]. Together with parts of the steam used in the ammonia stripper/still and scrubbing liquor from the NH₃/H₂S scrubbing circuit, this water corresponds to the waste water flow referred to in Table 5.2. The specific amount of waste water for the plants mentioned in Table 5.9 is 0.31 to 0.69 m³/t coke.

After ammonia removal by distillation (see ‘still effluent’ in Figure 5.9) the waste water effluent contains various organic compounds (such as phenols) and inorganic compounds (such as residual ammonia and cyanides). These compounds have a negative impact on the recipient water when directly discharged. The still effluent is therefore usually treated in a waste water treatment plant before discharge.

Data concerning the composition of the amounts and composition of waste water before treatment can differ considerably from one plant to another, both in terms of concentration and load per tonne of coke produced. The main reason for the wide variation lies in the gas treatment systems, the type of charging processes and the type of coal at the individual coke oven plants. For coals used for stamp charging, a higher moisture content is preferred since they show better characteristic during compaction prior to charging.

In cases where water sealing of ascension pipes is applied, a small water consumption occurs due to evaporation losses. To guarantee gas tightness, the sealing should always be filled with water. During the filling of the seals, a small water overflow occurs. Compared to the ammonia liquor from direct cooling, this water is comparably clean and usually treated separately. Figure 5.9 shows that this water is led directly to the ammonia liquor storage tank.

Additional waste water flows can be generated from condensed steam in the ammonia stripper/still, collected rainwater and runoff water, bleed from cooling and recooling circuits and filter backwash water from water treatment which can lead to a dilution of the surplus coal water flow.

Table 5.9: Influent and effluent concentrations and some aspects of waste water treatment systems with the predenitrification-nitrification system

Aspect/component		Unit	Data
Coke production		Mt/yr	0.63 – 1.25
Coal water flow (surplus water)		m ³ /h	16 – 80
Dilution by other waste waters		m ³ /h	0 – 40
Total effluent flow		m ³ /h	22 – 86
Specific effluent flow (specific waste water amount)		m ³ /t coke	0.31 – 0.69
Influent	pH	–	8.5 – 9.5
	Suspended solids	mg/l	30 – 40
	COD (x±s)	mg/l	200 – 6500
	TOC (x±s)	mg/l	835 – 1215
	BOD ₅	mg/l	800 – 3000
	Phenol	mg/l	500 – 1500
	SCN	mg/l	150 – 380
	Kjeldahl-N	mg/l	300
	Ammonia (x±s)	mg/l	50 – 200
	Nitrite	mg/l	NA
	Nitrate	mg/l	NA
	Oil and tar	mg/l	40
	PAH (6 Borneff)	µg/l	200
	Effluent	pH	–
Suspended solids		mg/l	42 – 75
COD (x±s)		mg/l	45 – 800
TOC (x±s)		mg/l	30 – 60
BOD ₅ (x±s)		mg/l	<20
Phenol		mg/l	0.1 – <2
SCN ⁻		mg/l	<4.0
Kjeldahl-N		mg/l	3 – 10
TNb		mg/l	3 – 30
Ammonia (x±s)		mg/l	0.6 – 80
Nitrite		mg/l	<1.3
Nitrate		mg/l	0 (*) – 27
Oil and tar		mg/l	5 – 15
PAH (6 Borneff)		µg/l	0.2 – <50

(*) From the coking plant at Lorfonte Serémange this value is reported, although in theory it is impossible; but high residual ammonia content and a negligible nitrate concentration indicate nitrification inhibition.

NB:— Ranges reflect the maximum and minimum of daily averages over two years (2004 – 2005) except for BOD, BTX and PAH that refer to fewer samples.

— TNb = Total nitrogen bound.

— NA = Not available.

Source: [65, InfoMil 1997] [88, Löhr et al. 1996] [89, Löhr et al. 1997] [260, Germany 2007] [272, Germany 2007] [320, Eurofer 2007] [341, Eurofer 2007] [372, Czech TWG member 2008].

The COD as a sum parameter comprises a large variety of different organic chemical compounds such as phenol (1000 – 2000 mg/l), nitrogen compounds (Kjeldahl-N: 250 – 500 mg/l) and polycyclic aromatic hydrocarbons (PAH) (up to 30 mg/l). In addition to ammonia, other compounds which contain inorganic nitrogen are also present, such as thiocyanides (150 – 350 mg/l) [65, InfoMil 1997].

The levels of concentration of the monocyclic hydrocarbon aromatics are rather low. The PAH are essentially present in an adsorbed state on solid particles. Benzo(a)pyrene has also been detected [201, Colin et al. 2003] [202, USEPA 2002].

Waste water from wet oxidation desulphurisation processes

Waste water from wet oxidative desulphurisation processes is usually treated separately owing to the presence of compounds that have a detrimental effect on the biological waste water treatment plant.

Table 5.10 shows the waste water composition of two wet oxidative desulphurisation processes. The application of one of the other wet oxidative techniques may lead to water emissions of arsenic compounds (Thylox process), 1,4-naphthoquinone-2-sulphonic acid (Takahax process), picric acid and thiocyanides (Fumaks/Rhodacs process).

Table 5.10: Composition of waste water of two wet oxidative desulphurisation processes

Component	Stretford desulphurisation (g/l)
NH ₃ (free)	0.1
Na ₂ CO ₃	5.7 – 65
SCN ⁻	80 – 300
S ₂ O ₃ ²⁻	50
SO ₄ ²⁻	12.2
Vanadate (VO ₃ ⁻)	1.2
Anthraquinone disulphonate	1.9
<i>Source:</i> [21, EC Coke 1996] [320, Eurofer 2007] [327, Eurofer 2007].	

Wet coke quenching

Usually no waste water results from wet quenching. The consumption of quenching water depends on the quenching process itself and can be considered between 1 – 3 m³/t coke. When quenching is operated correctly, the excess water is collected and is reused. Solids can be separated in settling chambers or sand filters prior to use for the next quenching procedure. Evaporation losses are between 0.5 and 1 m³/t coke and are replaced with fresh water.

5.2.2.3 Process residues from coke oven plants

Coke production facilities generate process solid wastes other than coke breeze and biosludges of about 1 kg/t of coke as shown in Table 5.11.

Table 5.11: Main waste/residues from coke oven plants

Waste/residue	Amount (kg/t of coke)
Coal tar recovery	0.1
Tar decanter	0.2
Tar storage	0.4
Light oil processing	0.2
Waste water treatment	0.1
Naphthalene collection and recovery	0.02
Tar distillation	0.01
Sludges from biological waste water treatment	–
Total	1.03
<i>Source:</i> [227, WB 1998].	

Most of the solid wastes contain hazardous components such as benzene and PAH. All process wastes are usually recycled to the coke ovens. Waste water sludges should be dewatered.

Dewatered sludges can also be charged to the coke ovens or disposed of in a secure landfill or an appropriate combustion unit.

5.2.2.4 Energy demand

Figure 5.11 shows an example for the annual energy demand/balance of a coke oven plant in an integrated iron and steel works. The COG produced by coke oven plants means that this plays an important role in energy supply and management in integrated steelworks (see Section 2.1.1) [320, Eurofer 2007].

The expression ‘rest of balance’ refers to losses.

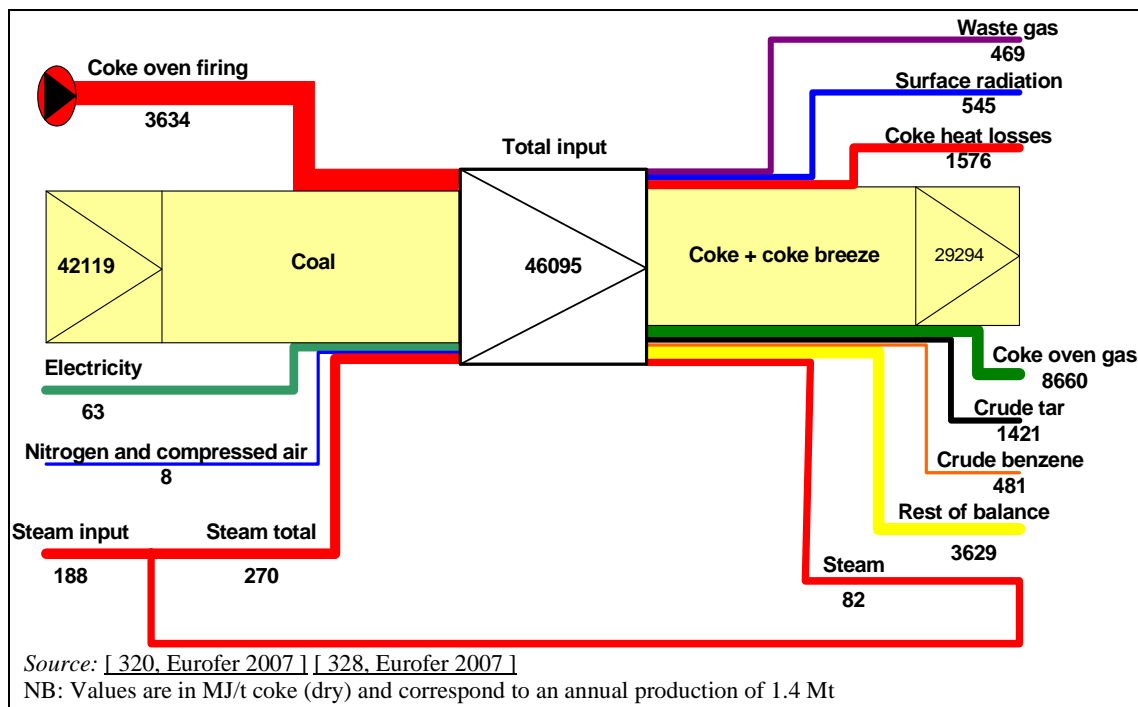

Figure 5.11: Example for the annual energy demand/balance of a coke oven plant in an integrated iron and steel works

5.2.2.5 Soil pollution

In the coke oven gas treatment plant, tar and other organic compounds (e.g. BTX) are recovered from coke oven gas. Spillage or leakage of these compounds may cause a soil pollution hazard, depending on local soil conditions. Furthermore, spillage or leakage of coal water may also cause a soil pollution hazard. Only a brief description of possible measures will be given here and include:

- minimising the number of flanges and appendages
- maintaining pipes and flanges visible for inspection as much as possible (e.g. placed above ground or in mantle pipes), unless the age and design of the plant make this impossible
- storing and transporting substances which are potentially a soil pollution hazard in such a way that precautions are taken to prevent spillage to soil from occurring
- groundwater precipitation if necessary or in case of remediation (see Table 5.22).

5.3 Techniques to consider in the determination of BAT

This section describes techniques (or combinations thereof), and associated monitoring, considered to have the potential for achieving a high level of environmental protection in the activities within the scope of this document.

It covers process-integrated techniques and end-of-pipe measures. Waste prevention and management, including waste minimisation and recycling procedures are also considered. Furthermore, techniques for reducing the consumption of raw materials, water and energy are covered.

Annex III to the Directive lists a number of criteria for determining BAT, and the information within this chapter will address these considerations. As far as possible, a standard structure as shown in Table 5.12 is used to outline the information gathered concerning each technique, to enable a comparison of techniques and the assessment against the definition of BAT given in the Directive.

This section does not necessarily provide an exhaustive list of techniques which could be applied in the sector and other techniques may exist or may be developed, which could be considered for the determination of BAT for an individual installation.

Table 5.12: Information breakdown for each technique described in this section

Type of information considered	Type of information included
Description	Brief technical description using, as appropriate, pictures, diagrams and flow sheets.
Achieved environmental benefits	Main potential environmental benefits to be gained through implementing the technique (including energy, water, raw material savings, as well as production yield increases, energy efficiency, etc.).
Cross-media effects	<p>Potential environmental side effects and disadvantages to other media due to implementing the technique, including details of the environmental effects of the technique in comparison with others (advantages and disadvantages supported by data if available) in order to assess the impact of the technique on the environment as a whole. This may include issues such as:</p> <ul style="list-style-type: none"> • consumption of raw materials and water • energy consumption and contribution to climate change • stratospheric ozone depletion potential • photochemical ozone creation potential • acidification resulting from emissions to air • particulate matter in ambient air (including microparticles and metals) • eutrophication of land and waters resulting from emissions to air or water • oxygen depletion potential in water • persistent/toxic/bioaccumulable components in water or to land (including metals) • creation or reduction of (waste) residues • ability to reuse or recycle (waste) residues • noise and/or odour • risk of accidents.
Operational data	Actual performance data (including reference conditions, monitoring periods and monitoring methods) on emission levels, consumption levels (raw materials, water, energy) and amounts of waste generated. Any other useful information on how to operate, maintain and control the technique.
Applicability	Indication of the type of plants or processes in which the technique may or cannot be applied as well as constraints to implementation in certain cases, considering, e.g. plant age (new or existing), factors involved in retrofitting (e.g. space availability), plant size (large or small), techniques already installed and type or quality of product.
Economics	Information on costs (investment and operating) and any possible savings (e.g. reduced raw material or energy consumption, waste charges) or revenues including details on how these have been calculated/estimated. Economic information relevant to new build and retrofit to existing installations will be included. This should allow for identifying, where possible, the overall economic impact of the technique.
Driving force for implementation	Specific local conditions, requirements (e.g. legislation, safety measures) or non-environmental triggers (e.g. increased yield, improved product quality) which have driven or stimulated the implementation of the technique to date.
Example plants	Reference to the plant(s) where the technique has been implemented and from which information has been collected and used in writing the section. Indication of the degree to which the technique is in use in Europe or worldwide.
Reference literature	Literature or other reference material (e.g. books, reports, studies, websites) that was used in writing the section and that contains more detailed information on the technique.

5.3.1 Coal preparation

Description

A prerequisite for the good operation of a coke oven plant as described in Section 5.3.4 is optimised coal handling. The purchased coal can be preprocessed by beneficiation (preferably at the coal mine) and blending processes that improve the quality of coal feed to produce coke of a desired quality together with reduced emissions of sulphur oxides and other pollutants.

The optimal operation of a coke oven plant requires a coal blend, which is as homogeneous as possible. A modern coal pretreatment plant consists of mixing hoppers, a crushing/screening plant, transporting equipment, dedusting equipment, conveyor belts in a closed building and possibly additional processes such as coal drying or the addition of coal additives.

These crushing and screening processes are usually carried out in buildings. All relevant devices should be enclosed. The emissions from these devices and material transfer points should be extracted and abated by cyclones, RotoClones[®], building enclosures of primary coal pulverisers, secondary coal pulverisers with building enclosures, scrubbers, wet ESPs and bag filters.

For the transport of the coal, enclosed or covered conveyors can be used if required. For the storage of the coal, sprinklers and plastic emulsions can be used to suppress dust formation. Windbreak fences or upwind mounds can be applied to lower wind velocity. If necessary, enclosed storage shall be applied. The free fall height is to be minimised depending on the plant size and construction. If feasible, it should be less than 0.5 m.

Achieved environmental benefits

For the extracted emissions, values of <10 – 20 mg/Nm³ can be achieved.

Cross-media effects

No data submitted.

Operational data

No data submitted.

Applicability

No data submitted.

Economics

No data submitted.

Driving force for implementation

No data submitted.

Example plants

No data submitted.

Reference literature

[211, Remus, Rainer 2008] [223, USEPA 2001] [227, WB 1998] [283, EC 2006]

5.3.2 Minimising oven charging emissions

Description

Oven charging is most commonly performed by gravity charging with charging cars. Three basic techniques are used to reduce emissions during charging in this way:

1. 'smokeless' charging. This system uses gas-tight connections between the coke oven and the charging car. The chambers are rapidly filled through four or five charging holes. Suction is generated by steam or water injection in the gooseneck of the ascension pipe
2. sequential charging or stage charging. In this process, the charging holes are charged one after the other. This type of charging takes a relatively long time. Suction is generated on both sides of the oven, either by the use of two ascension pipes (when present) or the use of the ascension pipe and a jumper pipe to the adjacent oven. The connections between the charging car and the oven are not gas-tight, but due to the suction, virtually no emissions occur when only one opening to the atmosphere is present
3. charging with telescope sleeves also known as 'Japanese charging'; this kind of charging is done by simultaneous charging through the (usually) four charging holes. The connections between the charging car and the coke oven are not gas tight, but are enclosed by 'telescope sleeves' from which the gases are extracted and led to a collecting main via a connection between the collecting main and the charging car. The extracted gases are combusted and subsequently led through a dust arresting device, which is stationed on the ground. In some cases, the charging cars are equipped with dedusting devices for the treatment of the extracted gases [227, WB 1998].

By levelling already during charging, a free gas space should be created in the top of the oven, resulting in an undisturbed gas suction during charging and during coking. Thus, charging emissions can be reduced. The effect of this technique depends greatly on the oven design and subsequently on the method of levelling and charging.

Achieved environmental benefits

Charging emissions can be very low in all of these systems. The main determining factor is the overpressure in the oven chamber and the charging telescopes.

Emissions from charging are difficult to quantify but <30 seconds of visible emissions per charge is generally achievable. Emissions of less than 10 seconds are achievable under optimum conditions. The standard in force in the US according to EPA method 303 for all by-product coke oven batteries is 12 seconds of visible emissions per charge. Values of less than 5 seconds were measured in practice on 51 U.S. batteries [235, Ailor 1999].

Reported dust emissions from charging with telescope sleeves with a dust collecting unit on the charging car are less than 5 g/t coke (concentration <50 mg/Nm³). In this case, the evacuated gas is burnt before discharge.

Cross-media effects

No data submitted.

Operational data

Some of the systems are more vulnerable to operational problems than others.

Applicability

Can be applied at both new and existing plants.

Economics

No data submitted.

Driving force for implementation

No data submitted.

Example plants

Emissions-minimised charging is applied at many plants all over the world. Table 5.13 gives some examples.

Table 5.13: Example plants with emission-minimised coke oven charging systems

Charging technique	Example plants
'Smokeless'	<ul style="list-style-type: none"> • Dust is Coke oven 2, Corus, IJmuiden, the Netherlands • Coke oven plant ArcelorMittal, Ghent, Belgium • Coke oven plant ArcelorMittal, Dunkirk, France • Coke oven plant ArcelorMittal, Fos sur Mer, France • Coke oven plant Gijón, Spain • Voestalpine Stahl GmbH, Linz, Austria • Rivagroup Taranto, Italy
Sequential/stage	<ul style="list-style-type: none"> • Many plants in the US; • Coke oven Hüttenwerke Krupp Mannesmann, Duisburg-Huckingen, Germany • Coke oven Prosper, Bottrop, Germany
'Japanese'	<ul style="list-style-type: none"> • Coke oven 1, Kawasaki Steel Corporation, Chiba Works, Japan • Coke oven, Nippon Steel Corporation, Kimitsu Works, Japan • Coke oven, Sumitomo Metal Industries, Wakayama Works, Japan • Coke oven 1, Corus, IJmuiden, the Netherlands • Coke oven plant ArcelorMittal, Seremange, France • BHP Steel, Australia

Reference literature:

[33, Eisenhut et al. 1988] [215, BSS 2007] [223, USEPA 2001] [227, WB 1998] [320, Eurofer 2007] [337, Eurofer 2007]

5.3.3 Sealing of ascension pipes and charging holes

Description

During the coking period, diffuse emissions from coke oven openings can be minimised by sealing these openings efficiently after the pushing and charging operation. However, such measures can only be successful when accompanied by careful maintenance and cleaning.

Water-sealed ascension pipes are standard equipment at most coke oven plants (see Figure 5.12).

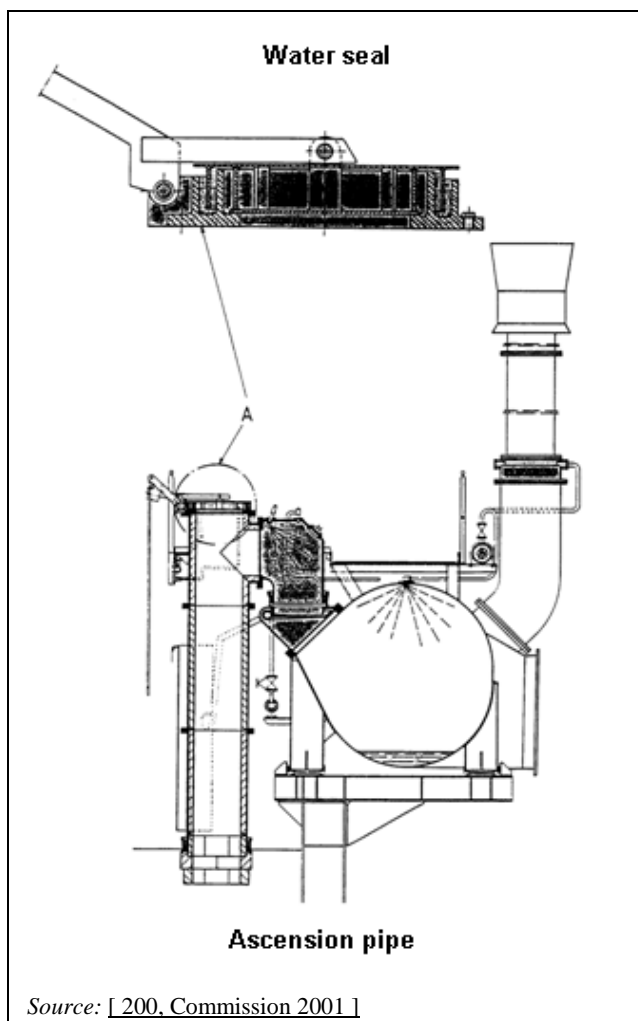

Figure 5.12: Ascension pipe of a coke oven chamber

Additionally, many older plants are also fitted with water-sealed ascension pipes. The water sealing can be very effective, provided that the water supply and runoff pipes are kept free of obstructions.

The best way to keep the charging holes leak-proof is to lute them carefully with a clay-type material or similar product.

The performance of the ascension pipe and charging hole sealings should be monitored. Different methods for estimating the fugitive emissions from coke ovens are in use. The achieved emission levels, expressed as a frequency of leaking percentage of the total number of ascension pipes and charging holes showing visible leaks or mass/time, depend on the monitoring method. The EPA 303 method for example enables the results from the observation procedure to be expressed in percentages of leakage. However, the DMT methodology, which, according to the EPA method, allows emissions per day based on basic measurements to be calculated, assigning four different degrees of strength to the emissions and takes the duration of the visible emissions during observation into consideration.

The following monitoring methodological steps are used at one example plant:

- visible leaks of the ascension pipes and charging holes are determined on the oven deck at a distance of 2 m from the ascension pipes and charging holes. Visible leaks of the ascension pipes are also determined from the collecting main
- ascension pipes and charging holes are observed once a day (random check)

- visible emissions due to normal operations (coal charging, coke pushing) are not counted as leaks
- a weekly average of the frequency of leaking is determined.

Achieved environmental benefits

Water-sealed ascension pipes and charging holes with luted lids will significantly reduce dust emissions, CO and hydrocarbons (see also Table 5.2).

With luted lids, a maximum of 1 % of charging holes showing visible leaks is achievable. Also for the apparatus which provides a passage from the coke oven battery to the collecting main, including the ascension pipe, gooseneck and stationary jumper pipes, 1 % is achievable, both determined as a weekly average of the frequency of leaking.

Cross-media effects

Water-sealed ascension pipes generate a waste water flow. However, this waste water can, in some cases, be recycled to the ammonia liquor tank or can be led to the ammonia stripper/still. Electricity is consumed by the pumps to circulate the water.

Luting of charging holes causes no significant cross-media effects.

Operational data

No data submitted.

Applicability

This technique is applicable both at new and existing plants. In new plants the design of the ascension pipes and the charging holes can be optimised in order to reduce fugitive emissions.

Economics

No data submitted.

Driving force for implementation

No data submitted.

Example plants

Many plants in the world have water-sealed ascension pipes. Furthermore, almost all plants lute the charging holes, either automatically or manually.

Reference literature

[33, Eisenhut et al. 1988] [249, Netherlands 2007] [320, Eurofer 2007]

5.3.4 Smooth and undisturbed operation of the coke oven plant

Description

Together with the maintenance regime and cleaning operations, the smooth and undisturbed operation of the coke oven is one of the most important process-integrated measures for emissions control. Failure to do so leads to severe temperature fluctuations and increased chances of coke sticking during pushing. This has an adverse effect on the refractory and on the coke oven itself and may lead to increased leakage and an increase in abnormal operating conditions.

A prerequisite for smooth and undisturbed operation is good reliability of the oven machinery and installations. This also leads to higher productivity.

A disturbance-free operation of the by-product plant will also have a positive influence on the emissions from the batteries.

By controlling the temperature of the heating surface (the measuring device at the ram bar) it is possible to determine the temperature distribution in the chamber which allows conclusions on the efficiency of the heating system.

Based on these results, actions to repair or to optimise the coke oven operation can be taken.

Checking and ensuring that the coke mass is fully coked can prevent emissions of VOC or emissions from spontaneous combustion of residual coke gases when the door is opened.

Automation of the coke making enables a coke oven plant to be operated at optimum efficiency. Some examples of control options are:

- an infrared measuring system of the surface temperature of the two heating walls
- an infrared pyrometer with an integral data memory for taking manual measurements at the heating flues
- reducing the number of plumes by implementing a system to register plumes (for example, an infrared thermal camera system) which allows all abnormal events to be recorded. Analysing the records and linking them with the main identified causes for plumes, e.g. pushing green coke, coke cake components, mechanical reasons (clogging) and hood system quality and finally defect correction (charging height and heating adjustments, charge quality modifications, cleaning operations, etc.)
- placing a set of strategically located video cameras to monitor air emissions from the coke ovens. Some can be mounted within the coke oven plant and others can be mounted at certain distances to provide an overview of the operations. The cameras transmit images to the control room operators and these images can be recorded and archived for analytical purposes
- a computer system to calculate the amount of heat required in each battery
- a system to automatically push and charge to assist operating crews
- a system to control gas treatment plants.

Achieved environmental benefits

A significant part of the coke oven plants emissions is caused by leakage through cracks between the heating chamber and the oven chamber and as a result of deformed doors, door frames, buckstays, etc. These emissions can be prevented, to a large extent, by a more smooth and undisturbed operation of the coke oven plant. Furthermore, this technique may significantly increase the duration of the life of the coke oven plant.

The recorded images can be used to investigate and identify emissions and to clarify exactly where they came from and what was happening in the plant at the time. This analysis provides valuable information for the prevention of future abnormal incidents.

The dust emissions from plumes are prevented to a large extent.

Cross-media effects

No significant cross-media effects are known.

Operational data

No data submitted.

Applicability

Can be applied both at new and existing plants. Because of the modular design of a coke oven, the design of coke-making automation equipment allows for tailor-made solutions according to the customer's specific requirements.

Economics

In general, the avoidance of green coke improves the productivity of the coke plant.

Driving force for implementation

No data submitted.

Example plants

Most operators in the world are trained to operate their coke oven plant as smoothly as possible. However, economic incentives may induce higher production levels and increase the chances of a less stable plant operation.

One example for the technique described in the third bullet point above is the coke oven plant at ArcelorMittal, Dunkirk, France.

One example for the technique described in the fourth bullet point is BHP steel in Australia.

Reference literature

[65, InfoMil 1997] [215, BSS 2007] [223, USEPA 2001] [227, WB 1998] [252, France 2007] [253, ICSTI'06 2006] [320, Eurofer 2007]

5.3.5 Maintenance of coke ovens

Description

The maintenance of coke ovens is one of the most important process-integrated measures and is a decisive factor for smooth and undisturbed operations.

The maintenance can be performed in campaigns or continuously. No fixed or minimum period of maintenance can be set. Maintenance should follow a systematic programme and be carried out by specially-trained maintenance personnel (e.g. during two shifts).

The maintenance programme at ArcelorMittal, Ghent, Belgium is described below as an example. There, each oven receives a complete overhaul after five years on average, depending on the state of the ovens. This entails leaving the oven empty for a week while the following operations are carried out:

- periodic inspection of the ovens (e.g. one oven per day)
- degraphitising of all deposits within the chamber (walls, ceiling, ascension pipes)
- oxythermic welding of cracks, holes and surface damage of the refractory brickwork
- repair of the oven chamber floor by flooding with cement
- injection of dust into the fine cracks
- complete overhaul of the doors; complete dismantling of all individual parts, cleaning and reassembling; readjustment of the sealing elements. Replacement of damaged door bricks; in many cases a complete rebricking of the door is necessary.

In addition to this overhaul, the bracing system of the ovens (springs, anchoring, etc.) is regularly checked and adjusted.

Other programmes include, for example:

- frequently cleaning goosenecks and the main collecting passages to prevent obstructions
- cleaning of lids
- development of a coke oven chamber wall diagnosing-repairing apparatus.

Achieved environmental benefits

Good maintenance prevents cracks in the refractory brickwork and minimises leakage and consequently emissions of incompletely combusted raw gas. This prevents black smoke from being visible at the stacks discharging flue-gas from coke oven firing. In addition, the

maintenance, readjustment and overhaul of the doors and frames prevents leaks. Well-maintained goosenecks and collecting mains also prevent emissions from charging.

Cross-media effects

No significant cross-media effects are known.

Operational data

The maintenance programme described has been applied in general by all operators (e.g. ArcelorMittal, Ghent, Belgium since 1986), with considerable success.

Applicability

Continuous or campaign maintenance programmes can be applied both at new and existing plants.

Economics

Personnel costs for skilled workers carrying out the maintenance programme are considerable (about EUR 2/t coke in the case of ArcelorMittal, Ghent, Belgium) but as part of the measures of smooth and undisturbed operation, better skilled operators contribute to higher productivity, thus compensating for costs.

Driving force for implementation

The intention to operate the coke oven plant as smoothly as possible with optimised productivity and minimised emissions is the driving force for the implementation of this technique.

Example plants

ArcelorMittal coke oven plant in Ghent, Belgium. This is a common technique carried out by all coke operators.

Reference literature

[200, Commission 2001] [223, USEPA 2001] [225, Brouhon 2006] [242, Caughlin 2007] [253, ICSTI' 06 2006] [254, Eurofer 2007] [276, Italy 2007] [320, Eurofer 2007] [330, Eurofer 2007]

5.3.6 Larger coke oven chambers

Description

The development of wider and taller coke oven chambers is inspired by two main principles:

- to improve environmental performance by reducing the number of ovens pushed per day and to reduce of the length of the sealing faces
- to lower investment and production costs because only one set of machines is needed.

The main characteristics of the tall or wide chamber coke ovens is the large oven volume compared to conventional ovens. Thus for a given output, the door seal is decreased in length and the frequency of pushing is reduced. However, special attention should be paid to the sealing because it is more difficult to keep such ovens gas-tight, especially at the top and bottom ends.

Achieved environmental benefits

When properly maintained and when spring-loaded flexible sealing doors are used under comparable operational circumstances, the total (fugitive) emissions per tonne of coke from the door and frame seals can be expected to be directly proportional to the reduction of the seal length compared to conventional coke ovens.

A reduction in emissions from pushing operations can be expected, given that fewer pushing operations are required per tonne of coke and that emissions are directly proportional to the number of pushes. Nevertheless, emission factors (e.g. emissions per lid, emissions per door) are not influenced by the application of larger coke oven chambers.

Cross-media effects

No data submitted.

Operational data

Larger oven doors demand more intensive maintenance. Table 5.14 shows the characteristics of several coke ovens types.

Table 5.14: Characteristics of several coke oven types

Aspect	Unit	Small	Medium	Large		
• Dimensions (useable):						
• height	m	4.5	6.0	7.1	7.85	8.23
• length	m	11.7	14.2	15.9	17.2	20.8
• width	m	0.45	0.45	0.59	0.55	0.59
Useable volume	m ³	22.1	36.4	62.3	70.0	93
Productivity	t coke/oven	12.7	21.3	39.8	43.0	55
Number of ovens	#	322	187	142	120	140
Total oven openings	#	2898	1496	1278	1080	380
Length of sealing faces	km	10.5	6.9	6.2	6.0	5.0
Oven pushes	#/d	430	257	138	128	135
Total opening actions	#/d	3870	2056	1242	1152	945
Length of sealing faces to be cleaned	km/d	14.0	9.5	6.0	5.6	4.9
<i>Source: [33, Eisenhut et al. 1988] [204, Neuwirth et al. 2003] [320, Eurofer 2007] [335, Eurofer 2007].</i>						

No specific problems are known with the plants with wide and high chambers. Greater demands are placed on wall strength.

Applicability

Only applicable to new plants. In some cases, a larger coke oven chamber can be chosen at a complete rebuild of the plant on the old foundations.

Economics

No data submitted.

Driving force for implementation

No data submitted.

Example plants

- coke oven battery, Hüttenwerke Krupp Mannesmann, Duisburg-Huckingen, Germany
- prosper No 3 coke oven battery, Bottrop, Germany
- coke plant Schwelgern, KBS, Duisburg-Schwelgern, Germany
- coke plant, ArcelorMittal, Ghent, Belgium.

Reference literature

[33, Eisenhut et al. 1988] [129, Stalherm et al. 1990] [204, Neuwirth et al. 2003] [320, Eurofer 2007] [335, Eurofer 2007]

5.3.7 Improvement of oven door and frame seals

Description

Oven door gas-tightness is essential and can be achieved by applying the following techniques:

- use of spring-loaded, flexible sealing doors
- careful cleaning of the door and its frame at each coke push
- gas channels inside the doors.

Existing batteries can be equipped with new spring-loaded sealing doors if door frames and armour plates are not too deformed. In this respect, the strength of the buckstays plays an important role, because the armour plates (holding the brickwork in place) are preferably held in place by springs, which are mounted to the buckstays.

It must be noted that the situation differs for small and large ovens. For ovens less than 5 m high, knife-edge doors in combination with good maintenance may be sufficient to prevent door emissions.

The performance of the oven doors and frame seals should be monitored (see Section 2.5.5.6.3).

Achieved environmental benefits

The specific emission values from flexible sealing doors are much lower than those from conventional doors. Provided they are kept clean, state-of-the-art doors make it possible to keep visible emissions below 5 % of all the coke oven doors per battery, both on the pusher side and on the coke side determined as a weekly average. Based on the determination according to EPA 303 with an average of 30 days, values of below 4 % have been achieved at U.S. coke oven batteries. However, examples can be found of good results with traditional (knife-edge) doors on well-maintained small ovens and poor results with flexible sealing doors on poorly-maintained large ovens but generally flexible sealings offer much better opportunities for tightness especially for large ovens.

Gas channels with large cross-sections behind the door body (by cutting back of the door plug or by a heat shield) or integrated into the sealing, reduce the pressure gradient between the inside and outside of the sealing edge.

Improvements applied to the leveller door have achieved a 93 % reduction in fugitive emissions from that door.

Cross-media effects

No cross-media effects occur.

Operational data

No data submitted.

Applicability

Applicable at new and, in some cases, existing plants.

Economics

The investment for replacing the doors of a coke oven battery is around EUR 6 million in a coke oven plant with about one hundred ovens and which produces 1.2 – 1.5 Mt coke/yr.

Driving force for implementation force

No data submitted.

Example plants

The following new and rebuilt plants have applied spring-loaded flexible sealing doors:

- coke oven 1, Corus, IJmuiden, the Netherlands
- coke oven Hüttenwerke Krupp Mannesmann, Duisburg-Huckingen, Germany
- coke oven in BHP Steel in Australia
- ArcelorMittal, Fos sur Mer, France
- ArcelorMittal, Dunkirk, France
- Rivagroup Taranto, Italy.

Reference literature

[161, Vos 1995] [215, BSS 2007] [223, USEPA 2001] [252, France 2007] [320, Eurofer 2007] [331, Eurofer 2007]

5.3.8 Cleaning of oven doors and frame seals

Description

Many older European coke oven plants still have original non-spring-loaded knife-edge doors. In these plants, especially with ovens higher than 5 m, leaking doors can be a serious problem. However, with good maintenance, any visible emissions from existing doors can be under 10 %. The success of the maintenance plan depends, to a large extent, on a stable coking process, permanent staffing for maintenance, continuous monitoring and feedback regarding achievements. An indoor maintenance workshop for doors is highly recommended.

Advanced door cleaners using scrapers at every cycle also show good results. Another method of cleaning coke oven doors is to use a high-pressure water-jet. High-pressure water-jet coke oven door cleaning, however, cannot be performed every cycle.

Maintenance programmes applied to coke oven doors contain, for example, door cleaning equipment and a door service maintenance strategy.

Achieved environmental benefits

The high-pressure water-jet cleaner system makes it possible to virtually eliminate visible emissions – a reduction of 95 % can be achieved (according to the EPA method). The use of a door cleaner system with scrapers also contributes to drastically reducing the visible emissions from the doors.

Cross-media effects

Cleaning with a high-pressure water-jet generates a contaminated waste water flow, which can be treated along with the waste water from the coke oven batteries. In some plants it is discharged into the quencher.

Operational data

No data submitted.

Applicability

Applicable to both new and existing plants.

Economics

No data submitted.

Driving force for implementation

No data submitted.

Example plants:

Coke oven 2, Corus, IJmuiden, the Netherlands.

BHP Steel, Australia.

Reference literature

[97, Murphy et al. 1991] [161, Vos 1995] [215, BSS 2007] [276, Italy 2007] [320, Eurofer 2007] [332, Eurofer 2007]

5.3.9 Maintaining free gas flow in the coke oven**Description**

A free space is maintained at the top of the oven chamber to allow the gases and volatilised tar to flow towards the ascension pipe, which, depending on the design, is usually situated either on the pusher machine side of the oven or on both sides. The gas flow may be hampered by charged coal reaching the oven top and by the top of the oven becoming clogged with graphite. Whenever the gas flow in the oven is obstructed, door and charging hole leakage will occur because the overpressure behind the obstruction increases.

This situation can be prevented by an adequate levelling of the charged coal. The build-up of graphite on the top of the chamber and on the oven roof can be minimised by adequate heat distribution over the oven walls and by lowering the upper wall temperature. Nevertheless, if the accumulation of graphite becomes too much, the leveller can get stuck in the coke oven chamber. To avoid this, the pusher is equipped with a special scratching device to clean the roof and the walls of the upper chamber area during pushing.

Achieved environmental benefits

A good pressure distribution in the coke oven chamber significantly reduces diffuse emissions and leakage. Furthermore, the risk of the coke charge jamming during pushing operations is reduced.

Cross-media effects

No cross-media effects occur.

Operational data

No data submitted.

Applicability

Applicable at new and existing coke ovens.

Economics

No data submitted.

Driving force for implementation

No data submitted.

Example plants

All plants with a proper maintenance programme and which aim to minimise door leakage apply this technique.

Reference literature

[65, InfoMil 1997] [320, Eurofer 2007]

5.3.10 Variable pressure regulation of ovens during the coking process**Description**

For conventional coke ovens one of the most difficult environmental problems is to avoid diffuse gaseous emissions, which mainly appear at coke oven closures such as coke oven doors, ascension pipe lids and at charging hole lids. The main cause and driving force of these emissions is the pressure in the oven chambers resulting from the raw gas generated during the

carbonisation process. Driven by this pressure, the raw gas penetrates the seals of the diverse coke oven closures.

The oven chamber is usually kept under slightly positive pressure during coking. Negative pressure would allow air to penetrate the oven chamber and would partially burn the coke, leading to destruction of the oven. The oven bottom should be at atmospheric pressure. As a rule of thumb, the overpressure (in mm water column) in the collecting main is maintained at twice the height of the oven in metres. Hence, for a modern 7 m tall oven, the corresponding overpressure would be a 14 mm water column. For older 4 m tall ovens, the overpressure in the collecting main would be a 8 mm water column.

During the coking process, the COG pressure reaches its maximum after a carbonisation period of two hours. Within the coking time, the specific raw gas ratio and the chamber pressure both decrease.

The conventional way for pressure regulation and emission reduction is to fix high or low pressure adjustment. This technique of keeping the collecting main under overpressure is used by most coke plants in the EU-25.

However, as soon as the oven is connected to the collecting main, the pressure in the collecting main determines the pressure in the oven chamber. The need for a positive collecting main pressure is a main cause for a higher emissions rate at the oven closures. To uncouple the collecting main pressure from the chamber, a novel collecting main valve (brand name 'FixCup') was developed that replaces the conventional mechanical flap at the individual ovens. This valve is an essential component of an innovative pressure regulation system that acts individually for each oven (brand name PROven[®] that stands for 'Pressure Regulated Oven'). A scheme of the PROven[®] system is shown in Figure 5.13. The new valve gives the opportunity to control the water immersion seal level as a function of the gas pressure in the oven. The gas pressure is measured at the ascension pipe or at the gooseneck. For obtaining a sturdy control system suited for the rough conditions of coke oven operation, the FixCup valve is equipped with a fixed cup-type water seal, a permanent water flow and a controlled effluent. Hereby the water level in the FixCup can be altered and the gas pressure can be kept for each individual oven on a freely selectable low level - typically near 0 hPa (0 mm w.c.) in the first hours, stepwise increasing to approximately 1.3 hPa (13 mm w.c.) at the end of the coking time. Thus a variable flow resistance to the crude gas to be discharged from a coke oven is generated. Whereas the pressure level in the oven is in the positive range the collecting main is operated under suction (typical pressure: -3 to -3.5 hPa (-30 to -35 mm w.c.)). This suction is also used very effectively for charge gas transfers without any need for a high pressure liquor aspiration system.

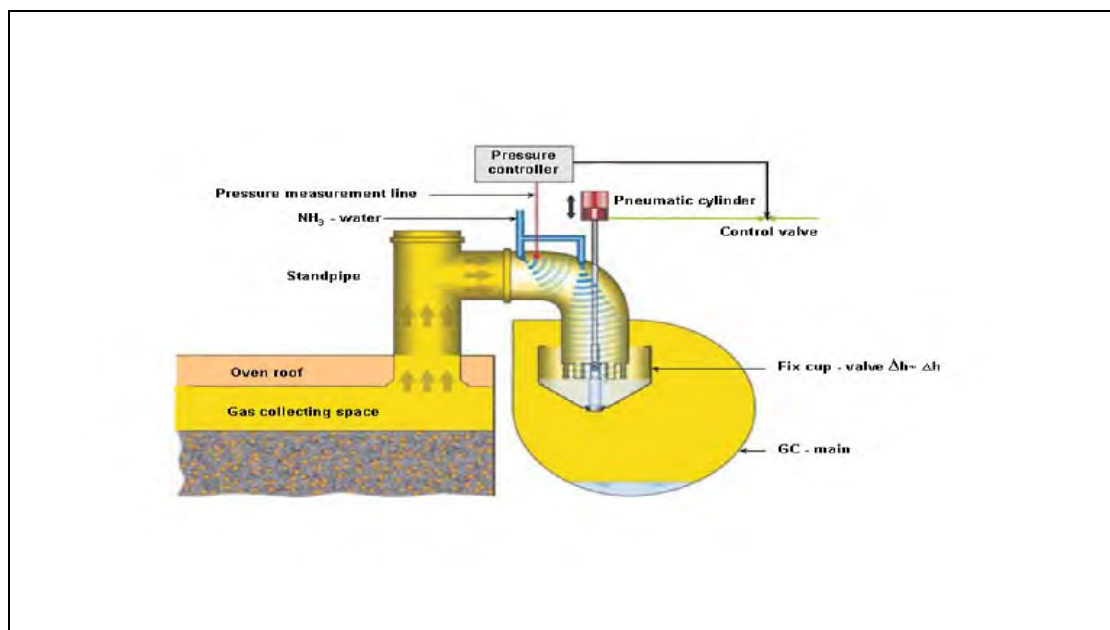

Figure 5.13: PROven[®] system scheme

Achieved environmental benefits

The amount of dust and coke particulates in the coke oven gas is drastically reduced. Table 5.15 shows the results of PAH emissions carried out before and after the installation of the variable pressure regulation technique.

Table 5.15: Measured PAH emissions with variable pressure control

Location	Coking period after charging (h)	PAH emissions reduction with variable pressure control (%)
Pusher side	0 – 2	64
	2 – 5	73
Coke side	0 – 2	69
	2 – 5	73

Source: [203, Liszlo et al. 2004] [225, Brouhon 2006].

Furthermore because the collecting main is under suction no high pressure liquor aspiration is necessary.

Cross-media effects

No significant cross-media effects are known.

Operational data

The operational data of the conventional technique are well known. Experiences with the operational characteristics of the variable pressure technique have been gathered since 1999. No specific problems have been reported.

Applicability

The variable pressure regulation technique is applicable to new coke plants and can be an option for existing plants. The possibility of installing this technique in existing plants should be determined carefully and is subject to the individual situation of every plant.

Economics

No data submitted.

Driving force for implementation

The reduction of emissions is the driving force for the implementation of this technique.

Example plants

In 1999, the variable pressure regulation system was tested in an old coking plant in Germany (52 coke ovens, 6 m height). It was working for three years before the coking plant was dismantled. This pressure regulation system was in 2003 installed at the new coke plant in Duisburg, Duisburg-Schwegern (two batteries of 70 ovens each with a height of 8.4 m). Thereafter the system was applied at coke oven plants in Brazil, China and South-Korea. By 2008 more than 1200 ovens with the PROven[®] technology had already been built or were under contract.

Reference literature

[203, Liszlo et al. 2004] [204, Neuwirth et al. 2003] [225, Brouhon 2006] [320, Eurofer 2007] [329, Eurofer 2007]

5.3.11 Heat recovery coking

Description

This coking system is often also called ‘non-recovery coking’ because of unrecovered gas and coal chemicals. At the time of writing (2010), however, the term ‘heat recovery’ is applied, when the waste heat is used and the off-gas is desulphurised as is typical for new constructions.

In the heat recovery coking process, essentially all the tar and gases released from the coking process are combusted within the oven and the sole flue. The heat recovery coking process requires a different oven design from that traditional horizontal chamber system. A coke oven gas treatment plant and waste water treatment plant are not needed.

Traditional heat recovery plants without any waste gas use and/or cleaning are the ‘beehive ovens’ which are still in operation in China. The basis for the heat recovery plants is the ‘Jewell-Thompson oven’ (see Figure 5.14), in which several ovens are grouped together to form one battery.

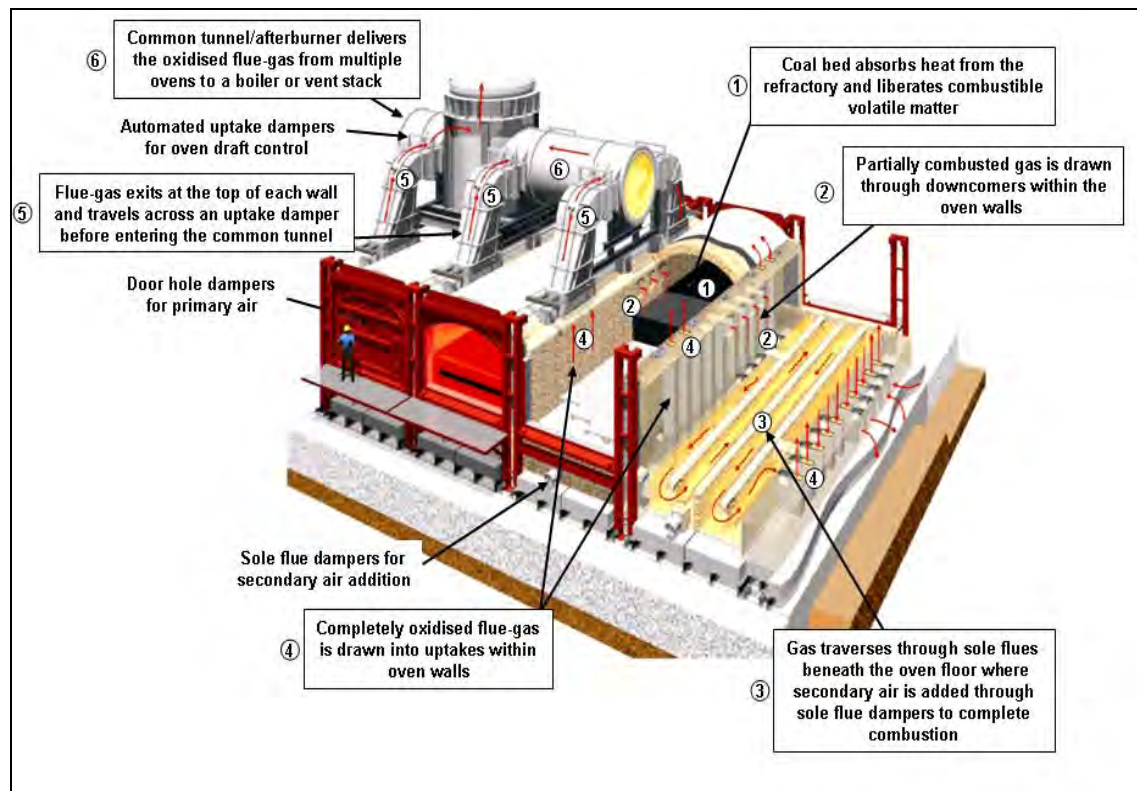

Figure 5.14: Jewell-Thompson oven and heat recovery coke plant

Shaped with a rectangular ground area and an arched top, the dimensions of the chambers of the plant run at Indian Harbor Coke Company in East Chicago (US) (see Figure 5.14) are $14 \times 3.5 \times 2.4$ m ($l \times w \times h$). The oven brick lining is composed of refractory silica material. Coal charging (40 to 45 tonnes per charge) of ovens is accomplished through the open pusher side door with the aid of a water-cooled coal conveyor. Typical charging heights are 1000 mm.

The carbonisation process is started by the heat which exists from the preceding carbonisation cycle. The released coke oven gas is partly burnt in the crown by the addition of ambient air through the oven doors and passed through ‘downcomers’ into the heating flues situated in the oven sole. By way of a further supply of ambient air, the complete combustion of raw gas is effected here at temperatures of between 1200 and 1400 °C.

Thus, coking of the input coal takes place by direct heating from the oven crown and by indirect heating from the refractory floor. The whole system operates at sub-atmospheric pressure. With the heat recovery of a modern plant, the hot waste gas is utilised to generate energy and subsequently be subjected to desulphurisation before being emitted into the atmosphere.

The coking time in Jewell-Thompson ovens amounts to approximately 48 hours. After that time, the coke is pushed out and quenched in wet mode. The most essential features by which the heat-recovery technique differs from the conventional coke-making technique are given in Figure 5.15 and can be summarised as follows:

- flat bed coke making
- operation of ovens under negative pressure
- supply of air directly into the oven chambers
- complete combustion of crude gas in each single oven
- no aqueous effluents
- gypsum as a by-products can be generated.

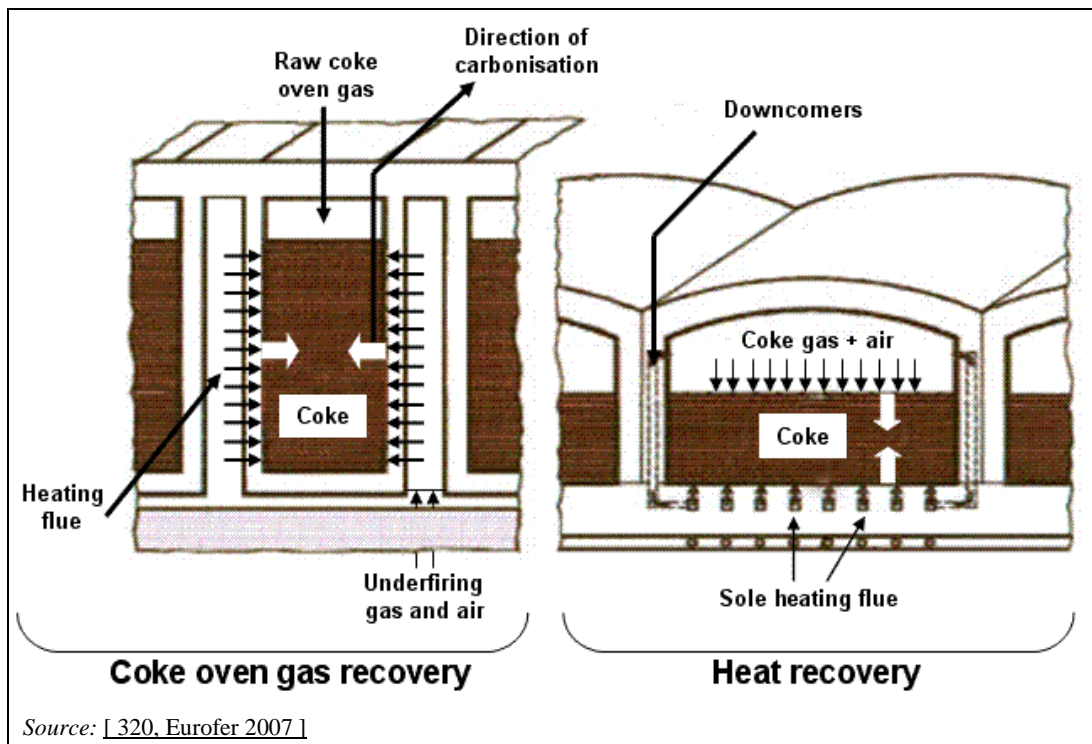

Figure 5.15: Most essential features of the heat recovery technique in contrast to COG recovery

Only about 6 % of worldwide cokemaking facilities (accounting for approximately 556 million tonnes coke yearly), which were totally installed in 2005, are operated as heat recovery plants. The relevant plants are located in the US, South America, Asia and Australia. The heat recovery plant in Haverhill Ohio, US was commissioned in 2005.

Achieved environmental benefits

Table 5.16 gives figures for the emissions from a non-recovery coking plant. The values refer to emissions without the application of an emissions abatement system. At Vansant, Virginia, US, a portion of the flue-gas is scrubbed in a thermal dryer, but the remainder of the ovens operate without flue-gas purification devices.

Because the coke oven operates at sub-atmospheric pressure, emissions from the doors during the coking operation are negligible. Emissions from charging and pushing operations at non-recovery coking plants without emission abatement are given in Table 5.16. Note that the two existing batteries where this information comes from are not equipped with dedusting facilities during charging and pushing.

Table 5.16: Emissions from charging and pushing at non-recovery coking without emissions abatement

Component	Value	Charging	Pushing	Unit
Dust	1960	7.35	276	g/t coke
SO ₂	7000			g/t coke
NO _x	380			g/t coke
CO	77			g/t coke
Benzene-soluble organics		Not detected	0.65	g/t coke
Benzo(a)pyrene		1.3×10^{-5}	Not detected	g/t coke

NB: Based on EPA-US emission factors. Calculated from g/t coal, based on assumption: 1 tonne coal yields 0.78 tonnes coke (see Section 5.1.2.3).

Source: [74, Knoerzer et al. 1991].

A precondition for an environmentally-friendly operation of the heat recovery technique is the utilisation of waste gas heat and of an emissions abatement system (desulphurisation) for cleaning the off-gas.

NO_x emissions can exceed typical emissions from staged combustion applied during conventional battery heating.

Because the coke oven operates under negative pressure, fugitive emissions from the doors caused by leakages during the coking operation are negligible. Thus, emissions with carcinogenic substances (e.g. benzo(a)pyrene) can almost be avoided during coking operations. Emissions of both particulates and benzo(a)pyrene, can occur during coal charging.

Improved emissions controls can be achieved by a modified suction via the oven or by additional suction facilities at the pusher side including a dedusting system. Generally, particulate emissions from coke pushing are lower than those from horizontal chamber coking because of the lower height from which the coke is plunged from the flatbed down into the quench car. To capture remaining particulate emissions, a hood combined with relevant suction devices and a dedusting system are installed at the coke side.

Cross-media effects

A disadvantage of heat recovery coking is the large area occupied by the ovens, due to their flat-bed design in comparison with conventional coke-making systems.

Partial combustion of the coal during coking results in a smaller output of blast furnace coke.

The heat recovery technique can use lower quality coals, which means also cheaper coals, including weak-coking coals and swelling coals for producing coke equivalent in quality to that produced in a conventional plant.

Operational data

The heat recovery plant at Indiana Harbor, Indiana, US started operation in 1998. The reported data on the operational experience are sufficient, and include consideration of environment-related aspects. Problems were reported on soot depositions in the waste gas boilers when the coke gas is not sufficiently combusted. Because of the negative pressure during carbonisation, visible emissions from the doors are negligible.

High-quality coke can be produced by the heat recovery process using a wide variety of coals including those that produce a high swelling pressure. Coke qualities are comparable to those produced by the horizontal chamber coking technique. An additional improvement in coke quality can be achieved by compacting the charging coal.

Applicability

This technique is only applicable as a whole new plant concept depending on the conditions at the operational site.

The decision for the construction of a heat recovery plant depends also on the site. It seems to be difficult to achieve an economically profitable energy link when integrating a heat recovery coking plant into an existing steelworks. A heat recovery plant generates no COG that can be used for heating so there must be consumers for the generated steam or electricity on-site.

Economics

Based on the information for the heat recovery plant in Indiana Harbor, Indiana, US, the investment for a greenfield heat recovery plant producing 1.2 million tonnes coke per year was USD 365 million including the coke oven facilities, coal handling/blending and the power plant in 1998. For the energy facility, investment costs of only USD 140 million are reported for 1998.

Operational costs are generally lower compared to COG recovery coking.

Driving force for implementation

The main advantages of using heat recovery coking are lower labour requirements and the chance to use lower quality coals, which means cheaper coals.

Example plants

There are no heat recovery coking plants in Europe. Several plants are in operation in the US and China.

Reference literature

[115, Walker, D.; Barkdoll, M. 2002] [117, Hoffmann, A. et al 2001] [121, Hein, M. 2002]
[124, Arendt, P. et al 2006] [200, Commission 2001] [320, Eurofer 2007]
[336, Eurofer 2007]

5.3.12 Emissions reduction at coke oven firing

Firing a gaseous fuel in the heating chambers provides the heat for the coking process. Heat is transferred to the coke oven chamber by heat conduction through the refractory brick wall. The higher the temperature in the oven chamber the shorter is the coking time. The most important pollutants from coke oven firing are NO_x , SO_2 and dust. Emissions reduction at the coke oven firing comprises a good maintenance of the brickwork as well as primary and secondary reduction measures for each pollutant.

5.3.12.1 Minimising leakage between coke oven chambers and heating chambers

Description

By performing systematic and continuous maintenance of the coke oven in accordance with the description given in Section 5.3.3, leakage through the brickwork can be prevented to a large extent. Leaks through cracks in the brickwork allow raw COG to reach the flue-gas from coke oven firing. This causes additional emissions of SO_2 , dust and hydrocarbons. The presence of cracks is easily detectable by the visible black smoke emissions from the coke oven stack during firing. However, it is not easy to identify which coke oven chamber is leaking. The most common technique used to locate cracks is to observe the two heating walls after pushing and to look inside the heating flues immediately after charging. The position of the cracks is revealed by flames appearing in the flues.

Because of cracks in the walls, particulate emissions will often increase with the operation time and exceed 10 mg/Nm^3 . By monitoring the amount of soot in the gas vented through the stack, coke oven personnel are able to identify any pattern in black emissions from the stacks and relate the emissions to the particular ovens being charged. They are able to manage the coke-making process to reduce leakage between the oven and the heating wall.

Once the problem is identified, cracks, holes and other damage to the surface of the refractory brickwork can be efficiently repaired by oxythermic welding, silicon welding, and by wet or dry spraying with refractory cement. In some extreme cases, it may be necessary to renew the brickwork.

Achieved environmental benefits

Usually the particulate stack emissions are below 10 mg/Nm^3 . Emissions can be reduced to nearly zero when the spraying is properly applied and the occurrence of cracks is monitored. The quality and condition of the coke oven refractory walls are also very important in this respect.

Cross-media effects

No data submitted.

Operational data

No data submitted.

Applicability

This technique can only be applied to existing plants.

Economics

No data submitted.

Driving force for implementation

No data submitted.

Example plants

Many plants in the EU.

Reference literature

[33, Eisenhut et al. 1988] [65, InfoMil 1997] [130, Stalherm et al. 1995] [215, BSS 2007]
[244, Plickert 2007] [320, Eurofer 2007] [338, Eurofer 2007]

5.3.12.2 Reduction of NO_x by primary measures**Description**

The NO_x generated consists almost entirely of thermal NO_x, which is formed by the reaction between N₂ and O₂ in the flame. Thermal NO_x formation is strongly related to peak temperatures and O₂ concentrations in the flame. Indirectly, NO_x emissions are also related to the fuel (enriched blast furnace gas or COG) and to the type of coal used, the specific charge weight of the coal, the coking time and the dimensions of the coke oven chamber.

The most effective way of reducing NO_x formation is to reduce the flame temperature in the heating chamber. The aim is therefore to burn with a cool flame. Three methods have shown to be effective:

- waste gas recirculation: the waste gas from the coke oven is admixed with fuel and combustion air. The lower O₂ and higher CO₂ concentrations reduce the flame temperature. However, the preheat effect of waste gas recirculation may counteract the temperature reducing effect
- staged air combustion: by adding the combustion air in several stages, combustion conditions become more moderate, and NO_x formation is reduced
- lowering coking temperatures: temperature has an influence on economics and the energy efficiency of the coke ovens. A lower coking temperature requires a lower heating chamber temperature, which results in less NO_x formation.

Furthermore, the heating chamber temperature (and thus NO_x formation) can be reduced while a normal coking temperature is maintained by decreasing the temperature gradient over the refractory brick wall from the heating chamber side to the coke oven chamber side. This can be done by using thinner bricks and a refractory with a better thermal conductivity. Formerly, a heating chamber temperature of 1320 °C would lead to a coke oven chamber temperature of 1180 °C. Nowadays, a coke oven chamber temperature of 1200 °C is achieved at the same heating chamber temperature due to thinner bricks.

Achieved environmental benefits

Staged air heating in combination with internal waste gas recirculation generates a long and 'cool' flame which is a precondition for minimising NO_x concentrations in the waste gas.

Plants which have implemented process-integrated deNO_x measures emit about 340 g NO_x/t coke (concentrations: 322 – 414 mg/Nm³ at 5 % O₂).

Emissions shown by several German plants are in the following ranges:

- fired with mixed gas: NO_x concentration is 322 – 358 mg/Nm³
- fired with coke oven gas: NO_x concentration is 332 – 414 mg/Nm³.

Cross-media effects

When the cooling capacity of the crude gas coolers is increased to improve desulphurisation efficiency, the energy consumption increases and possible thermal emissions are increased. No cross-media effects have been identified as a result of lowering NO_x emissions from coke oven firing.

Operational data

No data submitted.

Applicability

Process-integrated deNO_x measures are applicable in new plants. Lowering the temperature in an existing plant will result in longer coking times and operations below nominal capacity.

The use of thinner bricks and refractory with a better thermal conductivity can only be applied in new plants.

Economics

No data submitted.

Driving force for implementation

No data submitted.

Example plants

Newly built or renovated plants are equipped with low-NO_x firing systems. For example:

- Coke oven Hüttenwerke Krupp Mannesmann, Duisburg-Huckingen, Germany
- Coke oven Prosper, Bottrop, Germany
- Coke oven plant KBS, Schwelgern-Duisburg, Germany
- Coke plant B3, ArcelorMittal, Fos sur Mer, France
- Coke plant ArcelorMittal, Seremange, France
- Coke plant 2, Battery ACO, Corus, Scunthorpe, United Kingdom
- Coke oven Rivagroup, Taranto, Italy.

Reference literature

[33, Eisenhut et al. 1988] [130, Stalherm et al. 1995] [253, ICSTI' 06 2006] [276, Italy 2007] [320, Eurofer 2007] [333, Eurofer 2007]

5.3.12.3 Reduction of NO_x by secondary measures

Description

NO_x emissions from coke oven firing are preferably minimised by process-integrated measures, but end-of-pipe techniques may also be applied.

In the SCR process, NO_x in the flue-gas is catalytically reduced by ammonia (NH₃) to N₂ and H₂O. Vanadium pentoxide (V₂O₅) or tungsten oxide (WO₃) on a titanium oxide (TiO₂) carrier are often used as catalysts. Other possible catalysts are iron oxide and platinum. Optimal operating temperatures are in the 300 to 400 °C range. Such high temperatures decrease the

energy recovery in the regenerators (180 – 250 °C is optimum) of the coke ovens or necessitate additional heating of the waste gas.

Special attention should be paid to the deactivation of the catalyst, the accumulation of the explosive ammonium nitrate (NH_4NO_3), the ammonia slip and the formation of corrosive SO_3 .

Achieved environmental benefits

A de NO_x efficiency of 90 % can be achieved. There is not much experience in the sustainability regarding use in coke oven plants.

Cross-media effects

An increase in energy consumption and ammonia consumption occurs. Part of the catalyst has to be deposited when it is not effective any more.

Operational data

In 1976, an SCR was commissioned at Kawasaki Steel Chiba Works, Japan to treat the waste gas from coke oven firing. The SCR had a capacity of 500 000 Nm^3/h . The operation temperature was 240 °C and the reduction medium was ammonia (NH_3). De NO_x efficiency is 90 %. The formation of ammonium sulphate and accumulation of dust meant the catalyst had to be regenerated once a day by heating the waste gases to >260 °C.

In 1992, the SCR was taken out of operation with the closing down of batteries 2 to 4.

Applicability

SCR is only applicable to new plants.

Economics

The following costs have been reported for SCR in general: investments: EUR 47 million in 1976; operational costs were not available.

The following costs have been reported for SCR in general: investment costs of EUR 50/ Nm^3/h \pm 30 % in 1996. Thus, for a coke oven plant with a battery flue-gas flow of 300000 Nm^3/h and a production of 1 Mt coke per year this cost:

- investment: EUR 15 million \pm 5 million in 1996
- operational: EUR 0.17 – 0.51/t coke in 1996.

Example plants

SCR for De NO_x of waste gas from coke oven firing was applied at coke oven battery 2, 3 and 6, Kawasaki Steelworks, Chiba, Japan. All SCR installations have been shut down in the meantime, currently no SCR installation is in operation at coke oven batteries worldwide.

Reference literature

[65, InfoMil 1997] [276, Italy 2007] [339, Eurofer 2007]

5.3.12.4 Reduction of SO_2 by coke oven gas desulphurisation

Description

The level of SO_2 emissions is strongly related to the sulphur content of the fuel. Thus, emissions of SO_2 can be minimised by minimising the sulphur content of the fuel. Usually, (enriched) blast furnace gas or coke oven gas is used to fire the coke oven. The sulphur content of the coke oven gas depends on the desulphurisation performance of the coke oven gas treatment plant. The H_2S content in the treated coke oven gas may vary from around 1 to 1000 mg/Nm^3 , depending on the type of desulphurisation used and the corresponding efficiency. If no desulphurisation is applied (which is still the case at some plants in the EU) the H_2S content can be as high as 8 – 12 g/Nm^3 . Enriched blast furnace gas has a lower sulphur content.

Emissions of dust may be significantly increased and SO₂ emissions may also increase when crude coke oven gas from the oven chambers leaks through cracks in the heating walls and is combusted together with the heating fuel. In parallel, dust will be formed by the incomplete combustion of COG as well as of the used under firing gas. If that occurs, particulate emissions (black smoke) can be visually detected at the battery stack. Particulate emissions will also occur when the under firing gas contains dust.

Unpurified COG is not suitable for use in many industrial applications due to its H₂S content. When the gas has been desulphurised, however, its use for a variety of applications becomes viable. Many plants sell COG after desulphurisation at a profit. Desulphurisation for commercial reasons coincides with the need to protect the environment from the effect of 'acid rain', because desulphurised coke oven gas decreases SO₂ emissions at the site of coke oven gas combustion. In many cases, sulphur is removed in two stages: a low pressure stage and a high pressure stage. COG desulphurisation is becoming increasingly common in the EU-27.

Coke oven gas also contains a variety of organic sulphur compounds such as carbon disulphide (CS₂), carbon oxysulphide (COS), mercaptans, etc. (approximately 0.5 g/Nm³ total). However, there is only limited knowledge so far about recovering organic sulphur compounds from coke oven gas.

As described in Section 5.1.4.4 there are two main types of coke oven gas desulphurisation processes: wet oxidative processes and absorptive processes with subsequent stripping. The absorptive processes combine H₂S and ammonia (NH₃) removal and processing. The removed hydrogen sulphide and ammonia are recovered as vapours in the de-acidifier/NH₃ stripper columns. The stripping steam for the de-acidifier/NH₃ stripper is fed directly into the column. The H₂S/NH₃-rich vapours can be fed either to a Claus plant where ammonia is destructed and the hydrogen sulphide is processed into elemental sulphur or sent to a sulphuric acid plant in combination with ammonium sulphate production.

Throughout the years, the Claus process has undergone a continuous evolution to increase the sulphur recovery efficiency of the process. One of these developments is the OxyClaus[®] process. This technique is the same as the Claus process but air is replaced by oxygen. NH₃ is first removed by heat cracking (at 1450 °C) the coke oven ammonia steams. H₂S is then removed by a pure oxygen treatment (OxyClaus) which yields liquid sulphur.

Table 5.17 lists the different COG desulphurisation processes and their characteristics.

Table 5.17: Coke oven gas desulphurisation processes and their characteristics

Wet oxidative processes		Absorption/stripping processes	
Name	Description	Name	Description
Stretford	H ₂ S is scrubbed from the coke oven gas by a sodium carbonate solution (Na ₂ CO ₃) and elemental sulphur (S ⁰) is yielded using vanadate (VO ₃) as an intermediate. Regeneration of the scrubbing liquid takes place by aeration (O ₂), using anthraquinone disulphonic acid (ADA) as an intermediate	Carl Still, Diamex [®] , Cyclasulf [®] or ASK (*)	H ₂ S is scrubbed from the coke oven gas by a NH ₃ solution. The NH ₃ solution is derived from the NH ₃ scrubber. The H ₂ S and NH ₃ are stripped from the washing liquor by steam stripping and the vapours are led to a Claus plant or a sulphuric acid plant
Takahax [®]	Similar to the Stretford process, except that 1,4-naphthoquinone-2-sulphonic acid is used as an intermediate for the regeneration	Vacasulf [®]	Applied process for ammonia lean coke oven gas. H ₂ S (and also HCN and CO ₂) is scrubbed from the COG with a sodium carbonate solution or a potassium carbonate solution (Na ₂ CO ₃ or K ₂ CO ₃). The potassium variant allows higher carbonate concentrations. The washing liquor is regenerated in a column, using high temperature and low pressure (0.12 – 0.14 bar). Acid gases are stripped from the liquor and can be treated in a Claus plant or a sulphuric acid plant
Thylox [®]	Sodium thioarsenate (Na ₄ As ₂ S ₅ O ₂) binds the H ₂ S and regeneration is done by oxygen treatment. Elemental sulphur is yielded	Sulfiban [®]	Coke oven gas is scrubbed with monoethanolamine (MEA). NH ₃ removal prior to H ₂ S removal is necessary to prevent pollution of the washing liquor. H ₂ S is stripped from the MEA solution using steam and can be treated in a Claus plant or a sulphuric acid plant. Insoluble organic S compounds are removed from the MEA solution as solid waste
Perox [®]	The gas is scrubbed with an ammonia solution. Parabenzoquinone is used for sulphur oxidation and regeneration of the scrubbing liquor is done by oxygen	Desulf [®]	Virtually the same as the ASK process, but the NH ₃ is removed from the NH ₃ /H ₂ S vapour in saturators, producing ammonium sulphate ((NH ₄) ₂ SO ₄)
Fumaks [®] Rhodacs [®]	H ₂ S is oxidised by picric acid in the Fumaks-phase, yielding elemental sulphur. Cyanides are recovered in the Rhodacs phase		

(*) ASK (Ammoniumsulphide Kreislaufwäscher) process.
Source: [21, EC Coke 1996] [153, UN-ECE 1990] [186, Sowa et al. 2009] [242, Caughlin 2007] [252, France 2007] [254, Eurofer 2007].

In Europe, the most commonly used process is the absorptive process using an ammonia liquor to scrub the H₂S from the coke oven gas (Carl Still, Diamex, ASK or Cyclasulf processes). Figure 5.16 shows a flow diagram of a COG desulphurisation plant with an ASK process installed in 1997.

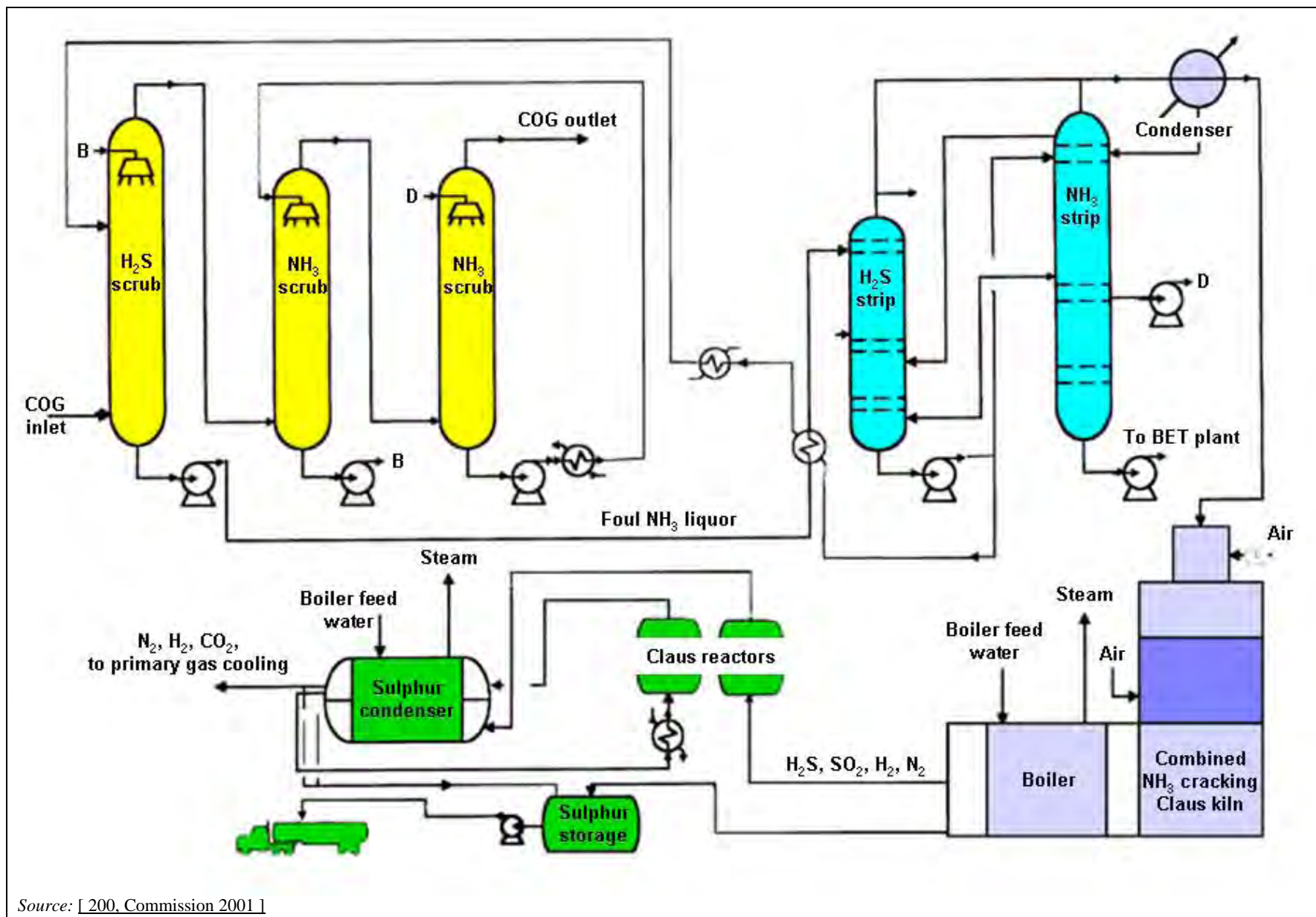

Figure 5.16: Flow diagram of a COG desulphurisation plant with an ASK process installed in 1997

The most commonly applied wet oxidative process is the 'Stretford' process. The Stretford process is applicable in a wide range of desulphurisation capacities. Reported coke oven gas desulphurisation design capacities range from 400 to 110000 Nm³/h.

More information on the sulphuric acid plants can be found in the BREF on Large Volume Inorganic Chemicals [168, EC 2007].

Achieved environmental benefits

Wet oxidative processes have a better desulphurisation efficiency than absorptive processes. Wet oxidative processes can have an efficiency of >99.9 %, achieving residual H₂S concentrations as low as 1 mg/Nm³ in the coke oven gas. Further developed absorption/stripping processes such as ASK or Cyclasulf achieve efficiencies of >95 % desulphurisation with residual H₂S concentrations in the coke oven gas of usually between 50 and 500 mg/Nm³.

In an optimised OxyClaus process, an NH₃ cracking efficiency and a H₂S recovery efficiency close to 99.9 % can be achieved. This technique significantly increases the H₂S recovery compared to traditional Claus techniques but is operating at higher temperatures.

None of the available techniques remove organic sulphur compounds with a high efficiency. In the low pressure stage of gas cleaning, organic sulphur compounds are only reduced from 0.5 g/Nm³ to 0.2 – 0.3 g/Nm³.

In the optimised Oxy-Claus process, an NH₃ and H₂S reduction efficiency of 99.9 % can be achieved. This technique increases desulphurisation by up to 50 % more than traditional techniques.

Coke oven under firing emissions shown by two German plants applying absorptive coke gas desulphurisation are in the following ranges:

- fired with mixed gas + coke gas desulphurisation: SO₂ concentration of 111 – 157 mg/Nm³
- fired with coke oven gas + coke gas desulphurisation: SO₂ concentration of 118 – 128 mg/Nm³.

Cross-media effects

Any wet oxidative process used for desulphurising coke oven gas will remove most of the hydrogen cyanide from the coke oven gas as well and form sodium thiocyanide by the following reaction:

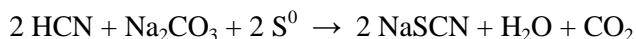

The sodium thiocyanate and the small amounts of sodium sulphate and thiosulphate formed by side reactions are not regenerated by the process and build up in the circulating liquor.

It is therefore necessary to purge a liquid stream to prevent the salting out of the chemicals. In the case of the Stretford process, this discharge flow contains vanadium compounds, quinone and hydroquinone compounds (from anthraquinone disulphonic acid), thiocyanide and thiosulphate. Discharge of these components is undesirable from an environmental and economic point of view (water pollution and loss of expensive chemicals). Normally this material is recycled via the coal blending.

To reduce chemical consumption, cyanic acid (HCN) can be removed prior to desulphurisation in a pre-washer using a sodium polysulphide or ammonium polysulphide solution. Preremoval of HCN does not reduce the total volume of effluent produced.

For the OxyClaus process, energy is needed for cracking but a catalyst is not needed for removing ammonia. NO_x emissions are also reduced.

On rare occasions, e.g. when the production of COG exceeds the demand for it, the excess of COG should be flared off for safety reasons. The flaring of coke oven gas generates some emissions. An estimation for one example is shown in Table 5.6. The combustion efficiency of the flare should be >95 %.

Bypass operations can lead to significant emissions. At one of the two coke oven plants of Corus, IJmuiden, the Netherlands, H₂S is removed from the coke oven gas by the Sulfiban absorptive process using MEA (monoethanolamine). The desulphurisation efficiency of this process is approximately 95 %. The H₂S is stripped from the MEA and converted into sulphuric acid. The sulphuric acid plant is out of operation for three weeks per year due to the maintenance of the MEA stripper (1.5 weeks) and of the sulphuric acid plant itself (1.5 weeks). During this period raw coke oven gas is added to the fuel gas grid or is used for firing the coke ovens, leading to additional SO₂ emissions of approximately 400 tonnes.

Operational data

The OxyClaus process has been operational in the coke oven plant of ArcelorMittal, Fos sur Mer, France since 2002. During this time SO₂ emissions have decreased from around 1900 to below 500 g/t coke.

Applicability

Coke oven gas desulphurisation of both the wet oxidative and the absorptive type can be applied at new and existing plants. The choice depends on the cleaned coke oven gas specifications, environmental considerations, integration within the gas cleaning plant, etc.

Economics

Typical operating and capital costs for the desulphurisation of 42000 Nm³/h coke oven gas containing 6 g/Nm³ H₂S and 6 Nm³ NH₃ of the two main types of coke oven gas desulphurisation techniques used in Europe (ASK and Stretford) are given in Table 5.18. It was reported that an increase in desulphurisation efficiency from 95 to 99.9 % in the Stretford process only costs 10 % extra. In the Stretford process, the most important operating costs items are the capital charges and the chemicals (see Table 5.18). Coke oven gas with high HCN concentrations (>2 g/Nm³) consumes relatively large amounts of chemicals. In this case it might be beneficial to install an HCN prewash before the Stretford unit.

Implementing the gas desulphurisation technique costs around EUR 30 million (capital cost) in a coke oven plant with about a hundred ovens (ArcelorMittal).

Table 5.18: Typical operating and capital costs for the desulphurisation of 42000 Nm³/h of coke oven gas containing 6 g/Nm³ H₂S and 6 Nm³ NH₃ of the two main types of coke oven gas desulphurisation techniques used in Europe (ASK and Stretford)

Parameter		Unit	Ammonium sulphate/ Stretford Process	ASK Process/Claus plant
Crude COG	H ₂ S	g/Nm ³	6	6
	NH ₃	g/Nm ³	6	6
Clean COG	H ₂ S	mg/Nm ³	2	300
	NH ₃	mg/Nm ³	30	30
Price of consumables (EUR)				
Price of consumables (EUR)	Consumables	Unit	Ammonium sulphate/ Stretford process	ASK Process/Claus plant
11.9/t	Steam	t/d	154	264
0.34/kWh	Electricity	kWh/d	11900	6600
128/t	H ₂ SO ₄ (98 %)	t/d	17.5	–
7.7/kg	ADA	kg/d	24	–
27/kg	Vanadate	kg/d	10	–
5.5/kg	Tartrate	kg/d	13	–
370/t	Soda	t/d	2.6	–
110/t	Caustic soda	t/d	9.6	9.6
Products and Revenues				
Parameter		Unit	Ammonium sulphate/ Stretford process	ASK Process/Claus plant
Products	Sulphur	t/d	4.8	5.4
	Ammonium sulphate	t/d	23.5	–
Revenues	Sulphur	EUR/t	125 ⁽¹⁾	250 ⁽¹⁾
	Ammonium sulphate	EUR/t	180 ⁽²⁾	–
Annual dept service on capital costs		%	11	11
Annual maintenance on capital costs		%	4	4
Total net costs				
Steam at costs		EUR/1000Nm ³	9.80	9.20
Steam at no costs		EUR/1000 Nm ³	8.00	6.10
NB: Sulphur and ammonia prices show a high fluctuation. At the time of writing this BREF (2010) the prices are: ⁽¹⁾ EUR 16 – 21/t sulphur for ASK/Claus process – lower or even zero value for sulphur from the Stretford process. ⁽²⁾ EUR 50 – 70/t ammonium sulphate. <i>Source: [65, InfoMil 1997] [118, Rothery 1987] [186, Sowa et al. 2009] [320, Eurofer 2007].</i>				

The cost of replacing an ammonia steam incineration plant by an OxyClaus desulphurisation plant was around EUR 12 million for a 1.5 Mt/yr coke oven plant.

Driving force for implementation

No data submitted.

Example plants

Table 5.19 gives an overview of example plants (not exhaustive).

Table 5.19: Table of example plants for coke oven gas desulphurisation processes

Wet oxidative	
Stretford	<ul style="list-style-type: none"> • ArcelorMittal, Hamilton, Canada • Metarom, Romania • Erdemir, Turkey • ArcelorMittal, Lorraine, France • Kobe Steel, Kakogawa Works, Japan • Posco, Korea
Takahax	<ul style="list-style-type: none"> • Nippon Steel, Yawata Works, Japan • Nippon Steel, Nagoya Works, Japan • Nippon Steel, Hirohata Works, Japan • Nippon Steel, Oita Works, Japan • Nippon Steel, Muroran Works, Japan • Nippon Kokan, Fukuyama Works, Japan • Nippon Kokan, Keihin Works, Japan
Fumaks Rhodacs	<ul style="list-style-type: none"> • Nippon Steel, Kimitsu Works, Japan • Sumitomo Metal Industries, Wakayama Works, Japan • Sumitomo Metal Industries, Kashima Works, Japan • Kawasaki Steel, Chiba Works, Japan
Thylox	• Not available
Absorptive processes	
Vacasulf	• Maanshan Iron & Steel Company Ltd., China
Carl Still, Diamex, ASK or Cyclasulf	<ul style="list-style-type: none"> • Prosper, Bottrop, Germany • ZKS, Dillingen, Germany • Coke oven KBS, Duisburg-Schwelgern, Germany • Kawasaki Steel, Mizushima Works, Japan • Coke oven No 2, Corus, IJmuiden, the Netherlands • Coke oven of ArcelorMittal, Ghent, Belgium • Voestalpine, Linz, Austria • Rivagroup, Taranto, Italy • ArcelorMittal, Dunkirk, France • ArcelorMittal, Fos sur Mer, France
Sulfiban	<ul style="list-style-type: none"> • Coke oven No 1, Corus, IJmuiden, the Netherlands • Nippon Kokan, Keihin Works, Japan
<i>Source: [65, InfoMil 1997] [252, France 2007].</i>	

Reference literature

[33, Eisenhut et al. 1988] [65, InfoMil 1997] [118, Rothery 1987] [223, USEPA 2001]
 [242, Caughlin 2007] [249, Netherlands 2007] [252, France 2007] [254, Eurofer 2007]
 [277, Wiesenberger 2007] [297, Hekkema et al. 2004] [320, Eurofer 2007]

5.3.13 Emission reduction during coke pushing

Description

Several techniques have been developed for minimising coke side dust emissions from coke pushing and include:

- use of coke side sheds, including evacuation and dedusting. The dust is evacuated by means of a coke side shed and dedusted in a bag filter
- use of a container car. The coke is pressed directly from the coke oven chamber into a container car. The coke does not make contact with oxygen and only small amounts of dust are generated. Usually applied in combination with coke dry quenching

- use of a coke transfer machine with (integrated) hood, stationary duct and stationary gas cleaning, preferably by bag filtration, so-called 'Minister Stein System'. During the whole pushing process, the quenching car is to be positioned in the catchment area of the dedusting collection system (use of a one-point or a mobile quenching car with integrated hoods on the coke transfer machine). An example of a dedusting system for dust from coke pushing is shown in Figure 5.17.
- maintaining a sufficient coking time, homogeneous heating and optimal charging heat which are important in order to avoid 'green pushes'.

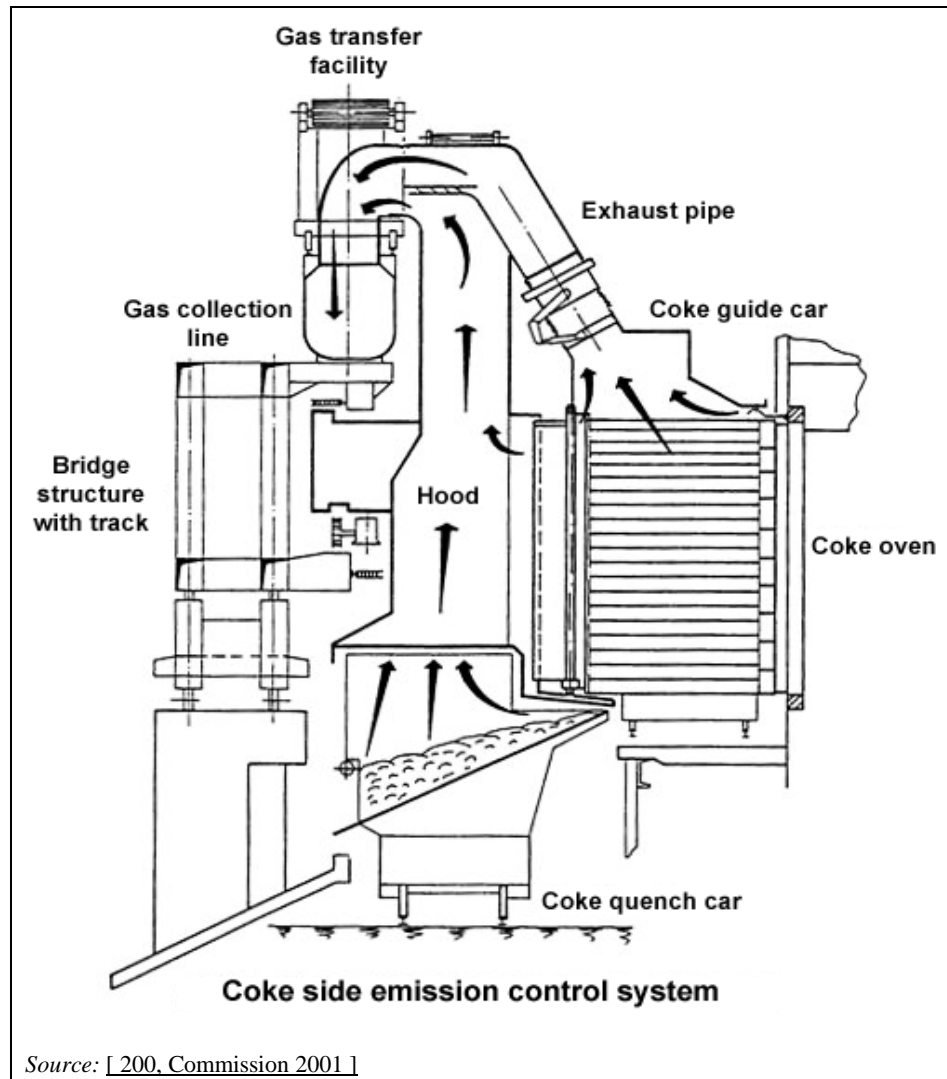

Figure 5.17: Example of a dedusting system for dust from coke pushing

Achieved environmental benefits

Dust emissions without abatement are about 500 g/t coke. Of the four techniques mentioned above, the Minister Stein System gives the best performance concerning the collection efficiency, combined with good working conditions for operators (in contrast to coke side sheds). At existing plants, a dust collection rate of >99 % is achievable. The system is also based on evacuation through a stationary duct.

The air extraction capacity is often in the order of 200 000 Nm³/h in plants using the Minister Stein System but is dependent on chamber size. At Thyssen Krupp Stahl AG, Duisburg, Germany the extraction volume is approximately 400 000 Nm³/h.

Often bag filters are used to minimise particulate emissions. In one case for a bag filter in coke pushing, dust emissions were reported to be 0.9 mg/Nm³ as an annual average and 1.5 mg/Nm³

for the 95th percentile (the reference time period was a half hourly mean). In general a dust emission concentrations in the exhaust gas are reported to be $<30 \text{ mg/Nm}^3$ with any notice to the corresponding technique applied. Wet abatement systems, which are still applied, achieve dust concentration values of $<20 \text{ mg/Nm}^3$.

In general emissions factors (at the stack) of below 5 g dust/t coke can be achieved. From the aforementioned gas volumes a specific extraction volume of 500 – 1000 m^3/t coke can be estimated. With this figure and the emission factor of 5 g/t coke, an emission concentration of 5 – 10 mg/m^3 can be calculated, when using efficient abatement techniques.

Cross-media effects

The operation of a dedusting device requires energy to drive the fans for air evacuation. The collected solids can be recycled back into the process.

Operational data

No data submitted.

Applicability

Coke side dedusting is applicable both at new and existing plants. At existing plants, a site-specific solution may have to be engineered. Sometimes lack of space at the plant is a constraint.

Economics

No data submitted.

Driving force for implementation

No data submitted.

Example plants

The Minister Stein System is operational at the following plants:

- US Steel Clairton Works, Pittsburgh, PA, US
- ArcelorMittal, Ghent, Belgium
- ArcelorMittal, Dunkirk, France
- ArcelorMittal, Fos sur Mer, France
- ArcelorMittal, Seremange, France
- Mannesmann Hüttenwerke Krupp, Duisburg-Huckingen, Germany
- Prosper, Bottrop, Germany
- Corus, IJmuiden, the Netherlands
- Kansai Coke and Chemicals, Kakogawa, Japan
- Voestalpine, Linz, Austria
- Rivagroup, Taranto, Italy.

Reference literature

[33, Eisenhut et al. 1988] [65, InfoMil 1997] [223, USEPA 2001] [227, WB 1998] [244, Plickert 2007] [253, ICSTI' 06 2006] [276, Italy 2007] [320, Eurofer 2007]

5.3.14 Coke dry quenching

Description

Figure 5.18 shows a scheme of a coke dry quenching plant (CDQ plant) design consisting of the shaft-like cooling unit, the waste heat boiler and the gas recycling system.

Operational data

According to an actual operational record in Japan, this system has a high availability of approximately 97 %. Maintenance is usually carried out during the periodic maintenance of the coke ovens. Only a small amount of additional maintenance time is required.

The moisture content of coke is approximately 0.05 % compared to that of wet quenched coke which is approximately 2 – 5 %. Therefore coke is more applicable and its quality is more uniform for blast furnace operation and the handling/preparation costs of dry coke are lower, particularly during winter conditions. In addition, the strength of the coke is 1.5 to 2 points higher in terms of drum index 150/15 than conventional water-quenched coke due to the fact that shocked cracks do not occur because the coke is not rapidly cooled by wet quenching. This leads to an improved coke ratio, PCI ratio and a higher productivity of the blast furnace.

Applicability

CDQ can be applied at new and existing plants. For the continuous operation of CDQ plants, there are two options. In one case, the CDQ unit comprises two to up to four chambers. One unit is always on stand by. Hence no wet quenching is necessary but the CDQ unit needs an excess capacity against the coke oven plant with high costs. In the other case, an additional wet quenching system is necessary. For retrofitting wet quenching plants, the existing wet quenching system can be used. Such a CDQ unit has no excess processing capacity against the coke oven plant.

Economics

The investment of a CDQ plant with an annual processing capacity of 2 million tonnes of coke is approximately EUR 100 million (of which equipment costs are generally expected to be EUR 70 million), although it depends on the site conditions, scope, specifications and market conditions of materials, etc. Based on the latest technologies of CDQs recently constructed in Asia for the efficiency of electricity production, an CDQ with an annual coke processing capacity of 2 million tonnes can generate yearly approximately 320 000 MWh by 100 % steam utilisation. Taking into account an interest rate of 5 % and EU-27 average electricity prices for industrial users [http://www.veoe.at/fileadmin/071107_Strompreise_Eurostat_2007.pdf], this means that the payback period of investment is 4.4 years. However payback is rather sensitive to electricity prices and can vary within the EU-27 between 3 and 8 years. In addition, taking into account some European energy saving schemes such as ‘Tradable Certificates for Energy savings’ (or ‘White Certificates’), which have been implemented in some European countries, the above payback is expected to be much shorter.

Driving force for implementation

Environmental reasons, improved stability of the coke quality compared with conventional wet quenching (mainly related to moisture content) and energy efficiency are the driving forces for the implementation of CDQ.

Example plants

By March 2008, the number of CDQ plants (chambers) in operation was: 104 in East Asia, 12 in Central Asia, 5 in South America and 21 in Europe. From Europe, 5 are in Hungary, 3 in Finland, 4 in Poland, 4 in Romania and 5 are in Turkey.

[290, Nippon Steel Engineering Co. 2008]

Reference literature

[207, Ameling et al. 2004] [208, Lindfors et al. 2006] [227, WB 1998] [276, Italy 2007] [277, Wiesenberger 2007] [290, Nippon Steel Engineering Co. 2008] [320, Eurofer 2007] [334, Eurofer 2007]

5.3.15 Coke wet quenching

Coke wet quenching (CWQ) can be performed by conventional wet quenching or by the more advanced coke stabilisation quenching.

5.3.15.1 Conventional wet quenching

Description

When coke is quenched with water in the quenching tower, dust and water mist are generated by the evaporation of quenching water from the glowing coke and emitted with the plumes. The quantity of entrained dust depends on the operating conditions, coke properties and the type of water addition. Attempts have been made to reduce dust and water vapour emissions by means of constructional and other measures; for example, by spraying the plume with water.

Optimum solutions to reduce the emissions of dust include the use of lamella stack baffles and favourable designs of the quenching tower (see Figure 5.19).

In addition, swamp top quenching can be applied as a modification to quench the coke with water. The water is partly injected through a piping system at the bottom of the quenching car (drowning the coke) and partly sprayed on the top of the coke (whereas, in most wet quenching systems, the water is only sprayed on the top of the coke). Nevertheless, the quenching tower itself is the same as for top quenching with the same dust arrestment device (see Figure 5.19). One disadvantage of swamp quenching is the emission of pieces of coke from the quenching car due to the instant formation of steam under and inside the coke mass in the quenching car, especially when operating with high coke levels. Quench water is reused.

The dust-catching equipment consists of individual frames in which the louvre-shaped plastic lamellas are installed. Quenching towers are made of wood and concrete.

Quenching towers are in use, e.g. every 15 minutes. In order to reduce emissions, a restricted number of hours per month (e.g. 4 hours) are scheduled for maintenance. Another way to decrease these emissions is to have a standby (second) quenching tower.

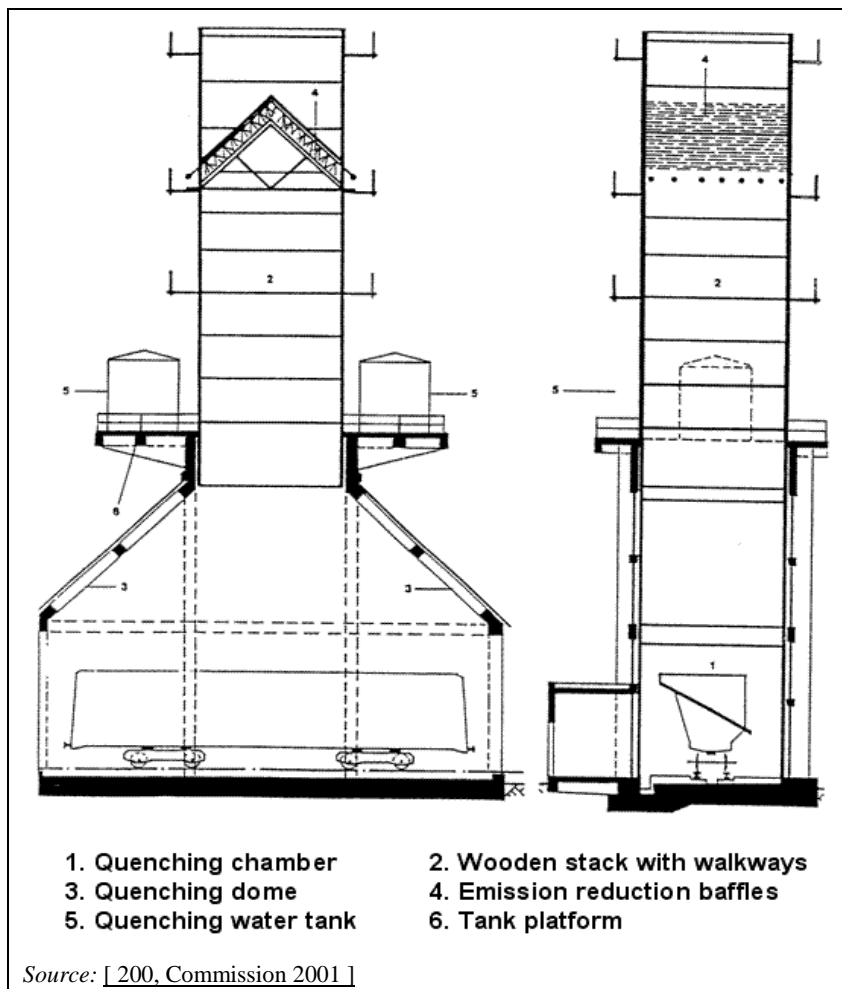

Figure 5.19: Schematic diagram of a quenching tower with emissions reduction baffles

Achieved environmental benefits

Emissions of dust during wet quenching without reduction measures is about 200 – 400 g/t coke. With the system described, these can be reduced to at least 50 g/t coke (with an emissions factor before abatement of maximum 250 g/t coke and a solids content of quenching water below 50 mg/l).

In practice, emissions of less than 25 g/t coke are normally achieved. It must be noted that the emissions depend very much on the measurement method used. The emissions factors quoted were determined by the VDI 2303 method ('Guideline for Sampling and Measurement of Dust Emissions from Wet Quenching'). This guideline describes a sampling method which is also known as the 'Mohrhauer method' and which is adjusted to the conditions at wet quenching towers.

Cross-media effects

Additional energy is consumed in water spraying, although not in significant amounts.

Operational data

There are many quenching towers round the world equipped with emissions reduction baffles. A good operational performance has been reported.

Applicability

Wet quenching techniques are applicable at both new and existing plants. Existing quenching towers can be equipped with emissions reduction baffles. A minimum tower height of at least 30 m is necessary in order to ensure sufficient draught conditions.

Economics

The costs for the retrofitting of an existing quenching tower with emissions reduction baffles are in the order of EUR 200 000. However retrofitting is only possible if the quenching tower is suitable. Otherwise a new tower must be installed and the costs are much higher.

Driving force for implementation

Normally legal requirements and enforcement by local authorities initiate the retrofitting of existing quenching towers.

Example plants

Examples of built or retrofitted quenching towers with emissions reduction baffles are located at:

- ArcelorMittal, Ghent, Belgium
- Hüttenwerke Krupp Mannesmann, Duisburg-Huckingen, Germany
- Coke plant ArcelorMittal Atlantique, Dunkirk, France
- Kokerei Salzgitter, Salzgitter Flachstahl GmbH, Germany
- Port Talbot, UK.

All of these plants achieve emissions factors of less than 25 g dust/t coke.

Reference literature

[100, Nathaus et al. 1997] [223, USEPA 2001] [227, WB 1998] [242, Caughlin 2007]
[320, Eurofer 2007] [334, Eurofer 2007]

5.3.15.2 Coke stabilisation quenching

Description

In the given example of a coke stabilisation quenching plant (CSQ plant), the quenching system is designed for six pushes per hour and a coke quantity of 54 tonnes per push. This system comprises the quenching tower, the quench water settling plant and the quenching car. These towers are larger than conventional quenching towers (e.g. 16 × 16 × 70 m high). Two emissions control stages consist of baffle plates and water sprays for the quenching vapours which reduce dust emissions. The special feature of this technique is the simultaneous application of spray and sump quenching.

Achieved environmental benefits

The dust emissions are 6–12 g/t of coke. The high quenching rate is an essential process element. It enables a rapid reduction of the coke temperature, a shorter reaction time, less formation of water gas and hydrogen sulphide as well as a high mechanical impact and stabilisation of the quenched coke, uniform grain distribution and thus better coke quality.

It must be noted that the emissions depend very much on the measurement method used. The emission factors for dust as given before were measured isokinetically in accordance with the preconditions of VDI 2066 which means that the sampling was carried out isokinetically which usually results in considerably higher emission values.

Cross-media effects

No data submitted.

Operational data

The amount of coke breeze produced by this system is higher than in conventional quenching. The specific quenching water demand is 2 m³/t coke of which 1.5 m³ goes to the settling basin as circulated water.

Table 5.20: Dust emissions from a coke stabilisation quenching tower

	Values	Units
<i>Characteristics of the coke oven batteries</i>		
Number of coke ovens	140	
Coke oven heating	1300	°C
Coking duration	25	h
Coke oven chamber volume	93	m ³
Pushed coke mass (mean value)	56.6	t coke per oven
No of daily coke pushing processes in total	135	
Daily coke production	7600	t
<i>Characteristics of the CSQ quenching tower</i>		
Quenching method: CSQ		
Exhaust area	256 (16 m × 16 m)	m ²
Tower height	70	m
Quenching water quality: Quenching tower recycling water		
Water consumption per quenching batch	Total 98	m ³
<i>Measurements over the total measuring grid:</i>		
Dust concentration measurements between March - April 2004	6, 8, 9 and 12	g/t coke
Mean average value	9	g/t coke
Max. value	12	g/t coke
<i>Source: [264, Germany 2007].</i>		

Applicability

As the system is larger than that necessary for conventional quenching, more space is needed.

Economics

No data submitted.

Driving force for implementation

Lower dust emissions can be achieved with CSQ.

Example plants

Coke plant KBS, Duisburg-Schwegern, Germany.

Reference literature

[204, Neuwirth et al. 2003] [207, Ameling et al. 2004] [253, ICSTI' 06 2006] [264, Germany 2007]

5.3.16 Emissions reduction in coke handling**Description**

The grading process consists of crushing, grinding and sieving and generates particulate emissions which need to be extracted and require further abatement. The dust emissions concentration as an annual mean after a bag filter has been reported in two plants to be 0.5 and 4.5 mg/Nm³. The handling of dry quenched coke causes more dust emissions than the handling of wet quenched coke. The grading plant building should be kept closed.

For the transport of the coke, enclosed or covered conveyors are used. For the storage of the coke, sprinklers can be used for surface moistening and to suppress dust formation. Windbreak fences or upwind mounds can be applied to lower the wind velocity. The free fall height of the materials should be less than 0.5 m.

Achieved environmental benefits

With bag filters, particulate emissions concentrations of between 0.5 – 4.5 mg/Nm³ can be achieved (annual averages).

Cross-media effects

No data submitted.

Operational data

No data submitted.

Applicability

No data submitted.

Economics

No data submitted.

Driving force for implementation

No data submitted.

Example plants

No data submitted.

Reference literature

[227, WB 1998] [244, Plickert 2007]

5.3.17 Closed belt conveyors

Description

A means for the transport of goods such as fine granular coal or coke is the closed belt or pipe conveyor, which protects the environment against all material emissions. Pipe conveyors consist of a flexible conveying belt which is formed by special devices in a sealed pipe. At the beginning – in the material loading area – the belt is open and the coal or coke is supplied as in a normal belt conveyor. This area extends for about 12 m, when the belt is closed and forms a pipe over the entire conveying distance. At the end – about 12 m before the discharging point – the belt opens again. After the discharge, the belt is closed again as can be seen in Figure 5.20.

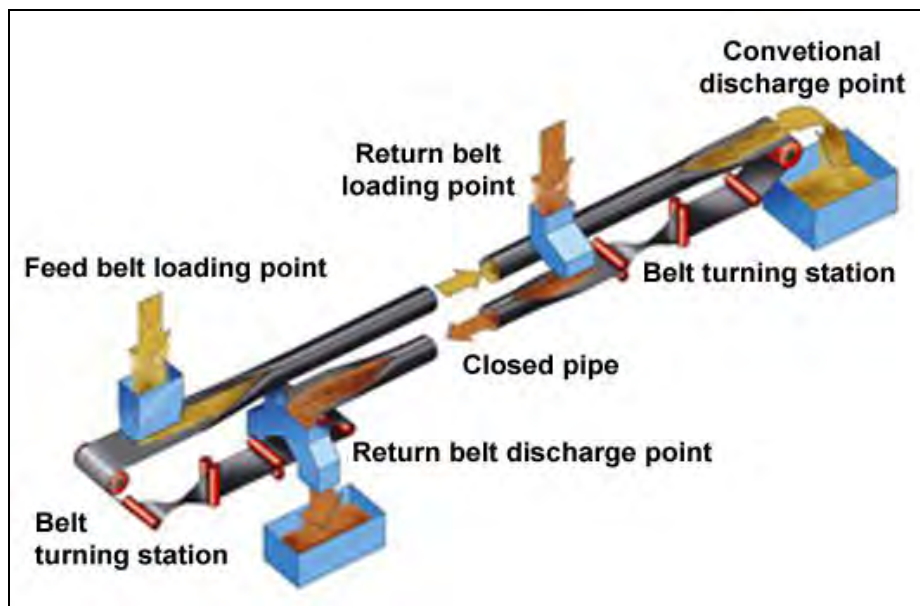

Figure 5.20: Example of a pipe conveyor system

Achieved environmental benefits

The closed structure of the conveying belt prevents the diffuse and fugitive discharge of coal/coke during transport.

Cross-media effects

No data submitted.

Operational data

The technical data for a pipe conveyor at a coke oven plant in Germany is given in Table 5.21.

Table 5.21: Technical data for a pipe conveyor at a coke oven plant in Germany

Parameter	Value	Unit
Diameter	500	mm
Belt-width	1900	mm
Maximum capacity	800	t/h
Velocity	2.09	m/s
Length	736	m

Applicability

Pipe conveyors are generally applicable to new and existing plants for the transport of goods generating dust such as coke, fine granular coal or sponge iron (DRI).

Economics

No data submitted.

Driving force for implementation

No data submitted.

Example plants

One coke oven plant in Germany.

Reference literature

[260, Germany 2007] [269, Germany 2007] [273, Eurofer 2007] [283, EC 2006]

5.3.18 Gas-tight operation of the gas treatment plant

Description

In a gas treatment plant, the crude coke oven gas is cleaned in several stages for subsequent use as a fuel. The relatively volatile character of the crude coke oven gas components means emissions can occur at flanges, pressure valves, pumps, etc. Apart from the negative environmental effects, occupational safety considerations are also important as some COG compounds are known carcinogens (e.g. PAH and benzene). The BTX plant incorporated in the coke oven gas treatment plant is particularly important in this respect. In such a plant, BTX, which mainly consists of benzene, toluene and xylenes, is scrubbed from the coke oven gas by means of a scrubbing liquid. Subsequently, the loaded scrubbing liquid is regenerated and the BTX is recovered and can be sold.

The gas-tight operation of a gas treatment plant is mainly a health and safety issue.

All measures to enable virtually gas-tight operation of the gas treatment plant should be considered and include the items listed below:

- minimising the number of flanges by welding piping wherever possible

- using gas-tight pumps (e.g. magnetic pumps or double sealed pumps)
- avoiding emissions from pressure valves in storage tanks. This is most commonly achieved by connecting the valve outlet to the coke oven gas collecting main (collection of the gases and subsequent combustion or gas blanketing or vent scrubbers could also be used)
- using special sealings for flanges and valves to prevent air pollution as well as closed processes without emissions such as the Claus process with tail gas recycling or the tar and liquid treatment with tar sludge recycling
- enclosing the tar sludge system. Solid particulates are separated from the raw tar coming from the tar decanter in a gas-tight centrifuge. The centrifuged tar is fed via a receiver vessel to the tar storage tanks. The separated tar sludge from the solid outlet of the centrifuge is collected in a vessel before it is pumped by a high pressure solid pump to the coal weighing hopper inside the coal tower. The charging is interlocked with the flow of the coal, so that a perfect mixture of tar sludge and coal is ensured. If necessary, disposal of the tar sludge into a mobile container is possible.

Achieved environmental benefits

No data submitted.

Cross-media effects

No cross-media effects occur.

Operational data

No data submitted.

Applicability

Applicable both at new and existing plants. In new plants, a gas-tight design will probably be easier to achieve than at existing plants.

Economics

No data submitted.

Driving force for implementation

No data submitted.

Example plants

Voestalpine, Linz, Austria; Corus, IJmuiden, the Netherlands; and ArcelorMittal, Ghent, Belgium all operate virtually gas-tight treatment plants to treat coke oven gas.

Reference literature

[65, InfoMil 1997] [204, Neuwirth et al. 2003] [216, sniffers et al. 2006] [320, Eurofer 2007]

5.3.19 Removing tar (and PAH) from still effluent

Description

The ammonia-still effluent normally contains no tar but when it does this tar has an adverse effect on the operation of the biological waste water treatment. In particular, the presence of polycyclic aromatic hydrocarbons (PAH) in the tar may cause problems as the PAH may have a toxic effect on the microorganisms in the activated sludge. Those PAH are relatively hard to degrade. Therefore, it is advisable to remove tar from the coal water prior to the biological treatment of the water.

The tar can be removed by adding coagulating chemicals and subsequent separation using a technique such as:

- gravitational sedimentation sometimes followed by filtration
- centrifuging the coal water
- flotation
- sand filtration.

This treatment removes most of the tar from the waste water in the form of a highly concentrated filter cake or sludge which has to be treated further, e.g. by recycling to the coke ovens.

Achieved environmental benefits

With sand filtration effluent concentrations of less than 700 – 800 µg/l (EPA-PAH) at a removal efficiency of 99 % can be achieved.

Cross-media effects

All of these tar removal techniques generate waste. However, this tar-laden waste, including tar decanter sludge, can be recycled into the coke ovens.

Operational data

No data submitted.

Applicability

Removal of tar prior to waste water treatment is applicable both at new and existing plants.

Economics

No data submitted.

Driving force for implementation

No data submitted.

Example plants

Sedimentation and filtration: Coke oven, Corus, IJmuiden, the Netherlands.

Reference literature

[65, InfoMil 1997] [320, Eurofer 2007] [340, Eurofer 2007]

5.3.20 Stripping of ammonia from the waste water

Description

Keeping the concentration of ammonia in the stripper and still effluent low benefits the operation of a biological waste water treatment plant. The removal efficiency strongly depends on the alkaline and steam addition and on the design of the stripper (i.e. the number of stages). A larger dose of NaOH and an increase in the number of stages can significantly reduce the ammonia concentration in the effluent.

When plant effluent treatment involves nitrification and subsequent denitrification, ammonia stripping of the effluent is less critical. In this case, an economic and environmental optimum between ammonia stripping and ammonia removal in the biological waste water treatment plant should be found.

Achieved environmental benefits

Effluent ammonia concentrations may vary from 20 to 150 mg/l, depending on steam and alkali dosage and stripper design. Values of between 20 and 40 mg/l are achievable but may not be required because of adjustment of an appropriate balance of BOD₅/P/N ratio in the waste water prior to biological treatment.

Cross-media effects

Strippers consume energy in the form of steam (0.1 – 0.2 t steam/m³ waste water) and consume alkalis (NaOH; 6 – 22 l/m³). Formerly, lime was used instead of NaOH. Higher doses of steam and alkalis lead to lower NH₃ concentrations in the effluent. Furthermore, an ammonia-laden and H₂S-laden steam is generated, which must be treated, for example in a sulphuric acid plant, a Claus plant, or in ammonium sulphate crystallisation units.

Operational data

No data submitted.

Applicability

Applicable both at new and existing plants.

Economics

For an Ammonia stripper, treating 150 m³ effluent per hour the following costs are required:

- investment: EUR 0.75 – 0.9 million in 1993 for the columns
- operational costs: EUR 0.18 EUR/m³ in 1993.

For an ammonia stripper, treating 120 m³ effluent per hour. the investment was EUR 0.8 million in 2005 as reported by a plant in Spain (ArcelorMittal, Avilés, Spain).

Driving force for implementation

No data submitted.

Example plants

Almost all coke oven plants around the world use an ammonia stripper.

Reference literature

[65, InfoMil 1997] [276, Italy 2007] [320, Eurofer 2007]

5.3.21 Waste water treatment

The waste water from a coke oven plant contains a mixture of hydrocarbons, cyanide compounds and nitrogen compounds in relatively high concentrations. Several methods are available to treat this waste water. In all cases, the waste water goes through an ammonia stripper before further treatment.

The waste water can be treated biologically and chemically. When biological treatment is applied, tar is often removed by a physico-chemical process and the waste water is often diluted in order to avoid the influents having toxic effects on the microorganisms, especially the inhibition of nitrifying bacteria.

The most commonly applied biological technique for the treatment of coke oven waste water is the aerobic, biological system with activated sludge. In some cases, special attention has been paid to nitrification and (anoxic) denitrification. In other cases, a biological system based on a fluidised bed is used to treat the waste water.

Description

Techniques included and further described in this section are:

- a) an aerobic system with activated sludge
- b) nitrification
- c) nitrification-denitrification.

Technique a) an aerobic system with activated sludge

In an aerobic system with activated sludge, the biodegradable contaminants are mainly biologically degraded to CO₂, H₂O and minerals and the non-degradable, non-polar components (like most PAH and heavy metals) are removed from the water phase by partial adsorption to the activated sludge. In practice, most of the potentially hazardous contaminants, such as phenols, cyanides and aromatic hydrocarbons, are biologically degraded and heavy metals are partially removed by adsorption to the activated sludge.

Activated sludge systems with a low food/microorganism ratio (F/M) are preferred from an environmental point of view. A low F/M ratio also enables biodegradation of heavily biodegradable organic compounds. The F/M ratio is the ratio of organic matter to activated sludge as mixed-liquor suspended solids (MLSS) and it is expressed as 'kg COD/kg MLSS/d', in which COD is the chemical oxygen demand.

Aeration may use oxygen instead of ambient air. This increases process control and reduces 'stripping' of volatile components in the waste water. For example, oxygen aeration is used at ArcelorMittal, Ghent, Belgium.

Technique b) nitrification

Some waste water treatment plants are designed to remove ammonium (NH₄⁺) efficiently by means of nitrification. The traditional design of an aerobically-activated sludge system can be taken as a starting point for this kind of plant. The system should have a very low F/M ratio and a high recirculation rate in order to prevent the slow growing nitrification bacteria from being washed out. The nitrification bacteria convert the ammonium into nitrate (NO₃⁻). Under such conditions, heavily biodegradable organic compounds can also be mineralised with a high removal efficiency

Technique c) nitrification-denitrification

In some cases, local authorities have demanded low discharges of all nitrogen compounds (including nitrates) from the effluent. This requires additional anoxic treatment of the waste water. Several plant layouts are possible, but good results have been obtained at waste water treatment plants with the predenitrification-nitrification concept (pre-DN/N). Two examples are given below in Figure 5.21 and Figure 5.22.

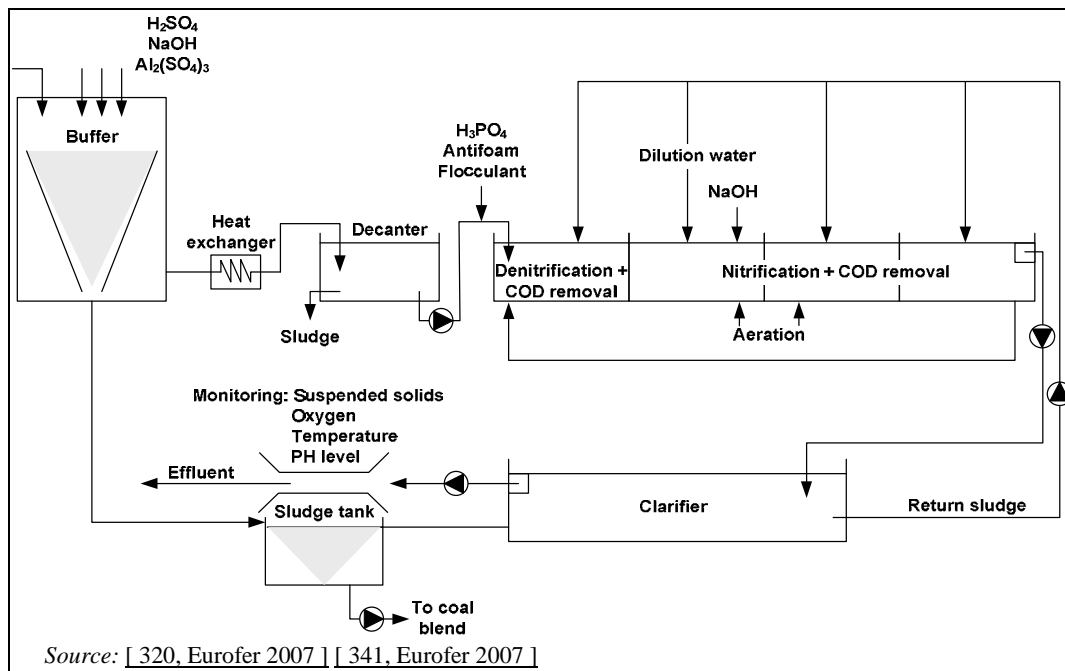
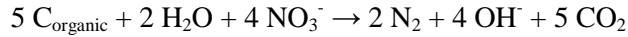

Figure 5.21: Example of a typical biological waste water treatment with nitrification-denitrification steps

In the pre-DN/N concept, the aerobically-activated sludge system is also used as a starting point. However, before the waste water is aerated, nitrate-rich water from the nitrification step is added. Under anoxic conditions, bacteria use the nitrate as terminal electron acceptors instead of molecular oxygen (O₂). The nitrogen is emitted as molecular nitrogen (N₂). The overall reaction is:



The waste water treatment plant (WWTP) of Hüttenwerke Krupp Mannesmann in Duisburg, Germany is designed as a multistage biological system, made up of (according to the water flow):

- a heat exchanger to cool down the aqueous effluent from the H₂S/NH₃ stripping column
- an equalisation basin
- an aeration basin (activated sludge process for the degradation of the organic content) with a preinstalled denitrification part as a first denitrification step
- an intermediate clarifier
- a nitrification basin, designed as carrier biology
- a second denitrification step, with methanol feed as the external carbon source
- a post-aeration basin, to resaturate the activated sludge
- a final clarifier.

To monitor the quality of the biologically purified waste water, the monitoring and control equipment includes online monitoring to alert the operators of irregular conditions early.

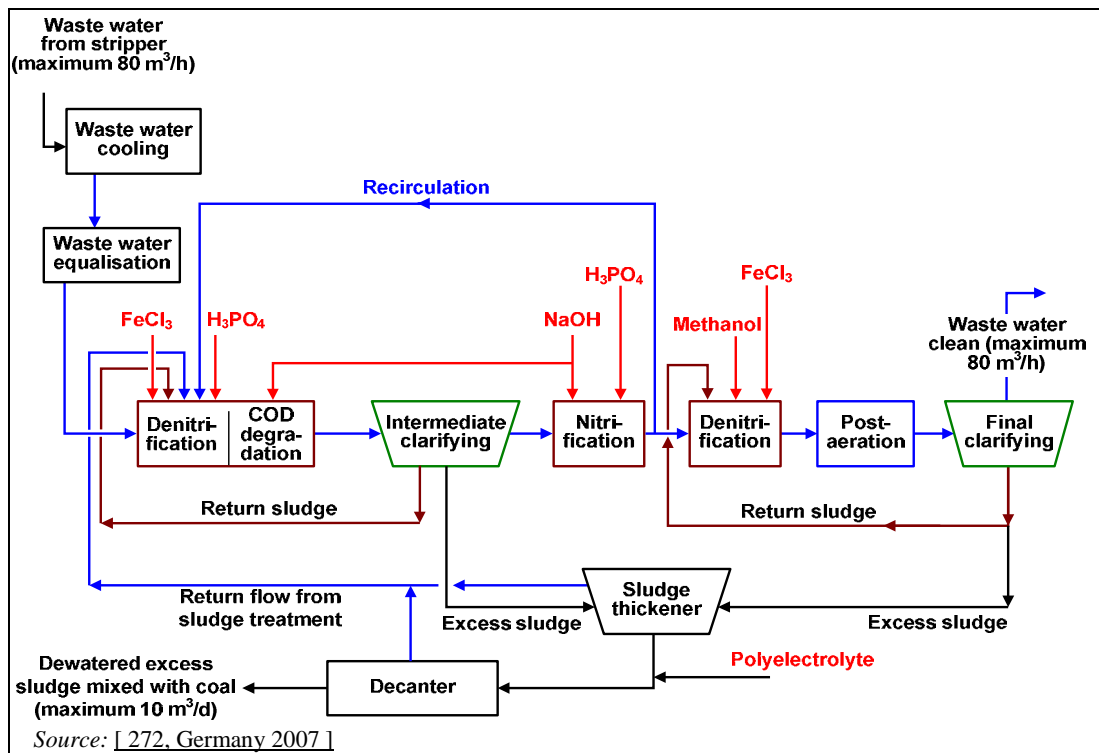

Figure 5.22: Example of a biological treatment plant with predenitrification-nitrification-denitrification

This plant shows very good results with the purification of coke oven waste water by very low emissions of nitrogen, sulphur and cyanide compounds. Influent and effluent concentrations are given in Table 5.24.

Another example of the 'pre-DN/N' concept has been successfully in operation since the year 2000 at Corus, IJmuiden, the Netherlands.

It is called BIO 2000 and consists of the combined treatment of waste water from the coke oven plant, the blast furnaces and from the sinter plant in an activated sludge system with predenitrification and nitrification in order to minimise COD and nitrogen compounds emissions.

Nitrification and COD removal takes place simultaneously in the aerobic part of the installation. The end-products from this conversion are CO₂, water and nitrate, NO₃⁻.

Denitrification is the biological process where nitrate is converted by bacteria into nitrogen gas. This process happens under anaerobic or anoxic conditions. So, there should be a special part of the installation where dissolved oxygen concentrations are more or less equal to zero. However, in denitrifying bacteria, some COD as feed is also needed. By putting in (part of) the influent in the anoxic part of the installation and recycling nitrified waste water, COD and nitrate come together. Because the denitrification takes place in the first part of the installation, this is called predenitrification.

Table 5.22: Composition of the different waste water flows at Corus, IJmuiden, the Netherlands (2007)

Parameter	Units	Blast Furnace	Sinter Plant.	Coke Plant	Ground Water ⁽¹⁾	Total
Flow	m ³ /h	140 – 150	50 – 55	80 – 90	35 – 40	320
Temperature	°C	40 – 44	35 – 40	30 – 35	10 – 12	33
Suspended solids	mg/l	25 – 35	10 – 25	20 – 50	<10	25
COD	mg/l	65 – 120	250 – 450	3000 – 3500	150 – 350	1100
Kjeldahl-N	mg/l	130 – 150	200 – 300	200 – 300	100 – 200	180
CN ⁻ total	mg/l	5 – 20	–	20 – 60	20 – 50	15
Zinc	mg/l	2 – 4	–	–	–	–
Metals	mg/l	1 – 3	1 – 3	–	–	–
Phenols	mg/l	–	–	500 – 700	–	–
SCN ⁻	mg/l	–	–	200 – 250	–	–

⁽¹⁾ Polluted groundwater from the coke plant.

The heart of the new water treatment configuration at Corus in IJmuiden is the biological treatment plant, a carrousel-type installation that was built from 1999 – 2000 (see Figure 5.23 and Figure 5.24). Carrousel-type installation are quite common in Western Europe where they are applied quite often for the treatment of domestic waste water.

The large basins with surface aerators and the relatively high velocities make the installation more of a complete mix reactor than a plug flow. The aerators are controlled by measuring dissolved oxygen continuously and comparing it with a set point of 1.5 – 2 mg/l. Also, pH is controlled by adding caustic soda when the pH is lower than 6.8 or by adding sulphuric acid when the pH in the basin is higher than 7.4.

Behind the biological treatment continuous backwashing sand filters were installed. Despite the fact that the combination of waste waters can easily be treated, sometimes very fine biological flocks are present in the overflow of the final settling basin.

Excess sludge is pumped to a thickener first. Thereafter the sludge is dewatered and mixed with the coal that is used as input for the ovens.

The carousel with the surface aerators installed in the blue boxes is visible in Figure 5.24 below. These boxes are isolated to prevent problems with noise in the direct neighbourhood of the installation. The light blue columns in front are the six sand filters.

The dimensions of the carousel are the following: the aeration volume is 15 000 m³; this means a hydraulic retention time of 33 hours. The settling volume is 1500 m³. The diameter of the settling basin is 29 m. The surface load is 5 m³/m²/h.

The sludge thickener is a basin with a diameter of 9.5 m and a volume of 250 m³. Average sludge waste is 45 m³/day with 3 % dry solids. The sludge recirculation flow is max 640 m³/h (twice the amount of influent). Dosage of phosphoric acid is based on 2 mg/l phosphate in effluent. That means approximately 5 l/h 75 % phosphoric acid has to be added [379, Corus IJmuiden 2009].

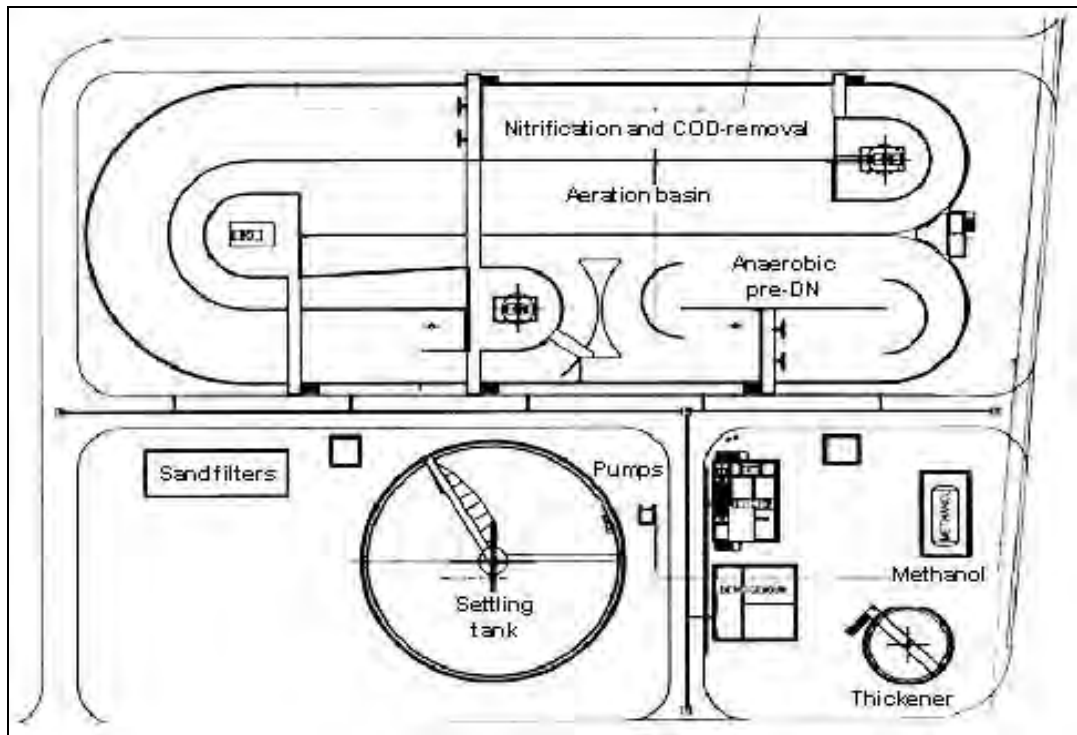

Figure 5.23: Floor plan of the biological treatment plan at Corus, IJmuiden, the Netherlands



Figure 5.24: Aerial view of the biological waste water treatment plant at Corus, IJmuiden, the Netherlands

Other techniques to remove suspended solids like flotation and sandfilters or waste water treatment in combination with domestic waste water can be an alternative if the prerequisites are given.

Achieved environmental benefits

Technique a) aerobic system with activated sludge

Table 5.23 gives the performance figures for aerobically-activated sludge systems from European coke oven plants.

Table 5.23: Effluent concentrations and specific emissions from European coke oven plants using aerobically-activated sludge waste water treatment

Component	Concentration	Unit	Specific emissions value	Unit
COD	140 – 700	mg/l	0.2 – 1	(kg/t coke)
TOC	37	mg/l		
Kjeldahl-N	20 – 120	mg/l	0.01 – 0.1	(kg/t coke)
NH ₃	<1 – 100	mg/l	0 – 0.1	(kg/t coke)
SCN ⁻	<0.1 – 35	mg/l	0 – 0.05	(kg/t coke)
Cyanides, easily released	<0.1	mg/l		
Phenol	<0.1 – 10	mg/l	0 – 0.005	(kg/t coke)
PAH	0.003 – 0.2	mg/l	0 – 0.001	(kg/t coke)

Source: [200, Commission 2001] [208, Lindfors et al. 2006].

Technique b) nitrification

Generally, systems with a low specific load give a better performance and allow the degradation of ammonia by means of nitrification. A low specific load also enhances the degradation of

organic compounds with a low degradation rate. If nitrification is applied, the effluent nitrate (NO₃⁻) concentrations will be relatively high (in the order of 200 mg/l).

Technique c) nitrification-denitrification

Nitrification-denitrification systems have a very low F/M ratio (0.05 – 0.2 kg COD/kg MLSS/d) and achieve very good results in cleaning coke oven waste water. Nitrogen emissions from these system are especially low compared to systems with high F/M ratios or with nitrification alone. Influent and effluent concentrations at four of these plants are given in Table 5.24.

Table 5.24: Influent and effluent concentrations and some aspects of waste water treatment systems with the predenitrification-nitrification system at four plants

Aspect/parameter		Unit	Plant A	Plant B ⁽¹⁾	Plant C	Plant D ⁽²⁾
Coke production		Mt/yr	1.25	0.60	1.03	1.08
Coal water flow (surplus water)		m ³ /h	42	22	65	80
Dilution by other waste waters (see Section 5.2.2.2)		m ³ /h	40	5–10	20	–
Total flow		m ³ /h	86	30.1±3.5	85	80
Specific effluent flow (specific waste water amount)		m ³ /t coke	0.59	.44	0.69	0.65
Food/microorganism (F/M) ratio		kg COD/kg MLSS/d	≤ 0.15	NA	0.5 ⁽³⁾	NA
Influent:	pH	–	NA	9.2±0.33	9.0 – 9.5	8.5
	Suspended solids	mg/l	30 – 40	NA	NA	NA
	COD	mg/l	3650±310	3161±1269	3220±590	200 – 2000
	TOC	mg/l	NA	NA	1025±190	NA
	BOD ₅	mg/l	2100	NA	NA	800 – 3000
	Phenol	mg/l	964	705±276	650	500 – 1500
	SCN ⁻	mg/l	355	NA	350	150 – 200
	Kjeldahl-N	mg/l	NA	NA	300	NA
	Ammonia-N	mg/l	125±25	NA	50±15	150±200
	Nitrite-N	mg/l	NA	NA	NA	NA
	Nitrate-N	mg/l	NA	NA	NA	NA
	Oil and tar	mg/l	40	NA	NA	NA
	PAH (6 Borneff)	µg/	200	NA	NA	NA
Effluent:	pH	–	7.7	8	7.6	8.1±0.3
	Suspended solids	mg/l	42	33±21	75	NA
	COD	mg/l	189±30	137±43	213±70	74±10
	TOC	mg/l	NA	NA	45±16	NA
	BOD ₅	mg/l	8.1±2.3	NA	15±5	4.8±1.7
	Phenol	mg/l	0.06	0.02±0.03	<0.1	0.02±0.01
	SCN ⁻	mg/l	3	NA	1.3	0.87±0.46
	CN ⁻ , easily released	mg/l	NA	0.01	NA	0.02±0.01
	Sulphides, easily released	mg/l	NA	NA	NA	0.03±0.02
	Kjeldahl-N	mg/l	8.8±4 ⁽⁴⁾	NA	NA	4.96±1.33
	TNb-N	mg/l	NA	NA	13	10.67±7.04
	Ammonia-N	mg/l	3±3 ⁽⁴⁾	0.28±0.56	<1	<1
	Nitrite-N	mg/l	0.9±1.5 ⁽⁴⁾	0	1.3	0.01±0.07
	Nitrate-N	mg/l	22±6.6 ⁽⁴⁾	8.2±6.92	11	6.11±6.68
	Oil and tar	mg/l	5	NA	NA	<5 ⁽⁵⁾
	PAH (6 Borneff)	µg/l	<50	NA	<20	1.06±1.12
Phosphorus	mg/l	NA	0.4±0.29	NA	1.3±0.4	

⁽¹⁾ Ranges reflect the mean of the annual averages for the effluent in 2009.
⁽²⁾ Ranges reflect the daily averages for the effluent in 2005 except for SCN where the 2004 value has been used.
⁽³⁾ In the first of three stages.
⁽⁴⁾ Ranges reflect the mean of the annual averages for the effluent in 2006, 2008 and 2009.
⁽⁵⁾ BTX.

NB: – TNb: Total nitrogen bound.
 – All values are arithmetic averages ± standard deviation, if available.
 – NA = Not available.

Source: [65, InfoMil 1997] [88, Löhr et al. 1996] [89, Löhr et al. 1997] [173, UBA-Germany 2005] [196, Josis 2010] [197, Jost 2010] [260, Germany 2007] [272, Germany 2007] [320, Eurofer 2007] [341, Eurofer 2007].

The achieved discharge concentrations for the biological waste water treatment plant at Corus, IJmuiden, the Netherlands (2007) after combined treatment of waste water from the coke oven plant, the blast furnaces and from the sinter plant are shown in Table 5.25.

Table 5.25: Discharge concentrations for the biological waste water treatment plant at Corus, IJmuiden, the Netherlands (2007) after combined treatment of waste water from the coke oven plant, the blast furnaces and from the sinter plant

Parameter	Unit	Average	Maximum
Flow	m ³ /h	340	400
Suspended solids	mg/l	60	80
COD	mg/l	135	150
Kjeldahl-N	mg/l	15	30
Phosphate	mg/l	5	10
CN ⁻ total	mg/l	11	13
CN ⁻ easily released	mg/l	0.35	0.45
SCN ⁻	mg/l	2.0	4.0
Phenols	mg/l	<0.5	1.0
Sum of Cr, Cu, Pb, Ni, and Zn	mg/l		0.011 – 0.013
Cd	µg/l		10
Hg	µg/l		5
As	µg/l		2.5
NB: Average means rolling average of 10, in composite samples . Maximum means maximum in random samples. Source: [379, Corus IJmuiden 2010].			

Cross-media effects

Activated sludge occurs from the waste water treatment plant. The surplus activated sludge can be added to the coal feed of the coke oven plant.

Operational data

Technique a) aerobic system with activated sludge

Phosphate and caustic soda are added. Caustic soda is used for pH adjustment. Sedimentation is enhanced by the addition of FeCl₃ and a polymer. Although some plants do not need to make any of these additions and achieve good results.

Applicability

To obtain optimum results, an appropriate treatment will use pre-DN/N as described under description technique c) above.

Economics

Technique c) nitrification-denitrification

- investment: EUR 0.6 million in 1994 for an extension of a nitrification system to a pre-DN/N system. Total investments were EUR 4.6 million
- operational costs: were EUR 345 000 per year, including waste water levies calculated in 1996 (EUR 0.57/t coke).

Driving force for implementation

The demand for low discharges of nitrogen compounds requires a suitable waste water treatment system.

Example plants

Technique a) Aerobic system with activated sludge

SSAB Tunnbrått AB, Luleå Works, Sweden.

Technique c) nitrification-denitrification

Coke oven waste water treatment plants using the pre-DN/N concept have been installed at ArcelorMittal, Ghent, Belgium; ArcelorMittal, Seremange, France; ZKS, Dillingen, Germany; Hüttenwerke Krupp Mannesmann, Duisburg-Huckingen, Germany (see Table 5.24).

A coke oven waste water treatment plant using the final additional stripping of ammonia is installed at Rivagroup Taranto Italy.

Reference literature

[21, EC Coke 1996] [65, InfoMil 1997] [88, Löhr et al. 1996] [89, Löhr et al. 1997] [201, Colin et al. 2003] [208, Lindfors et al. 2006] [260, Germany 2007] [272, Germany 2007] [320, Eurofer 2007] [341, Eurofer 2007]

6 BLAST FURNACES

6.1 Applied processes

The first true coke-based blast furnace was introduced in 1735 [152, Ullmann's 1994]. The blast furnace remains by far the most important process for the production of hot metal (pig iron). The technique is likely to continue to dominate hot metal (HM) production in the medium term. Figure 6.1 shows a general view of two blast furnaces [344, Eurofer 2007].



Figure 6.1: General view of two blast furnaces with three hot stoves each and the stack for the waste gas from the hot stoves

A blast furnace is a closed system into which iron-bearing materials (iron ore lump, sinter and/or pellets), additives (slag formers such as limestone) and reducing agents (i.e. coke) are continuously fed from the top of the furnace shaft through a charging system that prevents escape of blast furnace gas (BF gas). Figure 6.2 shows a simplified layout of a blast furnace consisting of the furnace itself, the cast house, the hot stoves and a two-stage treatment of BF gas.

A hot air blast, enriched with oxygen and auxiliary reducing agents are injected on the tuyère level providing a countercurrent of reducing gases. The air blast reacts with the reducing agents to produce mainly carbon monoxide (CO), which in turn reduces iron oxides to metal iron. The liquid iron is collected in the hearth along with the slag and both are cast on a regular basis. The liquid iron is transported, i.e. in torpedo vessels to the steel plant and the slag is processed to produce aggregate, granulate or pellet for road construction and cement manufacture. The blast furnace gas is collected at the top of the furnace. It is treated and distributed around the works to be used as a fuel for heating or for electricity production.

Various reducing agents are available. Carbon/hydrocarbons in the form of granular or pulverised coal, heavy fuel oil, oil residues, used oils, fats and emulsions, animal fats, eco-oil, natural gas, coke oven gas, BOF gas, BF gas, waste plastics, coal tar, etc. are generally available in sufficient quantities at reasonable costs. However, the choice between several reducing agents is not determined by costs alone. Apart from being a reducing agent, coke also serves as a carrier of the bulk column in the blast furnace. Without this carrying capacity, blast furnace operation would not be possible.

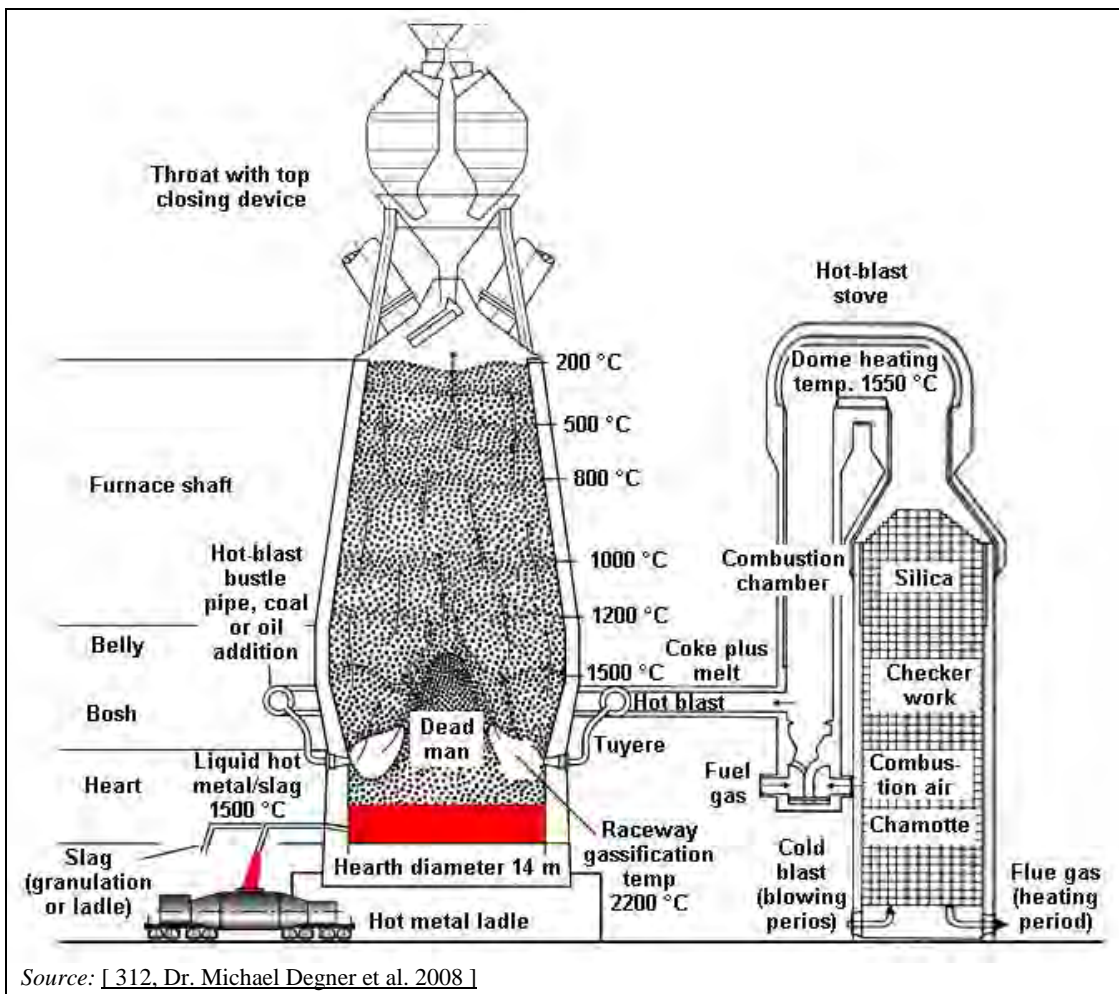

Figure 6.2: Simplified scheme of a blast furnace

Iron ore processed nowadays contains a large content of hematite (Fe_2O_3) and sometimes small amounts of magnetite (Fe_3O_4). In the blast furnace, these components become increasingly reduced, producing iron oxide (FeO) then a partially reduced and carburised form of solid iron. Finally, the iron charge melts, the reactions are completed and liquid hot metal and slag are collected in the bottom. The reducing carbons react to form CO and CO_2 . Fluxes and additives are added to lower the melting point of the gangue, improve sulphur uptake by slag, provide the required liquid hot metal quality and allow for further processing of the slag.

As the blast furnace burden moves down, its temperature increases, thus facilitating oxide reduction reactions and slag formation. The burden undergoes a series of composition changes as this happens:

- the iron oxide in the burden becomes increasingly reduced (forming sponge iron and finally molten hot metal)
- the oxygen from the iron ore reacts with the coke or the carbon monoxide, thus forming carbon monoxide or carbon dioxide, which is collected at the top
- the gangue components combine with the fluxes to form slag. This slag is a complex mix of silicates of a lower density than the molten iron
- the coke primarily serves as a reducing agent, but also as a fuel. It leaves the furnace as carbon monoxide, carbon dioxide or carbon in the hot metal
- any hydrogen present also acts as a reducing agent by reacting with oxygen to form water.

The main operations are as follows:

- burden preparation
- charging and conveying of raw materials
- blast furnace processing
- generation of hot blast
- direct injection of reducing agents
- casting
- slag cooling and processing.

6.1.1 Burden preparation

The production of hot metal requires large amounts of bulk materials like lump ore, any blend of lump ore agglomerates and pellets, iron-sinter and auxiliaries.

Excessively coarse lumps of ore have to be crushed, ground and screened to produce defined sizes of particles required. Ores usually undergo specific preparation steps.

Usually pretreated ores and other materials are delivered by ships, by trains and sometimes by lorries being unloaded by appropriate unloading devices. Depending on the prerequisites and their properties, e.g. their drift sensitivity and their wettability, they undergo outdoor, under roof, bunker, silo or packed short, intermediate or long-term storage. Irregularities within the ores from one or more provenances are balanced out by mixing. This homogenising process is performed in bedding yards.

Concerning the question what burden preparation exactly comprises, different views can be found. Commonly, burden preparation includes the ore preparation processes, the blending processes before the sinter plant in bedding yards, the conveying of the sinter, the coke and the possible direct conveying of lump ore and all batching processes up to the BF top charging. Sometimes the unloading, conveying and storage of ores and coke is included and sometimes only ores are regarded.

The batching system includes screens (for iron ore and coke), vibro feeders (for fluxes) and weighing bins. From the weigh bins, the raw material is conveyed to the skips or the BF top via a belt conveyor. In case of the use of sinter and/or pellets in addition to lump ore, suitable storage and batching systems are added to the stockhouse.

For the majority of BF the raw material batching and BF top charging is handled automatically through a supervisory system from the control room and the burden preparation system is fully dedusted by a bag filter system.

6.1.2 Conveying and charging of raw materials

The mixture of iron-bearing materials (iron ore rubble, sinter and/or pellets) and additives (flux material) are known collectively as the 'burden'. The burden and the accompanying coke are charged into the top of the furnace either via skips or mechanical conveyor belts. They enter into the furnace via a sealed charging system which isolates the furnace gases from the atmosphere. This system is necessary because blast furnace pressure exceeds atmospheric pressure (0.25 – 2.5 bar gauge). Whilst many new large blast furnaces have high top pressures (up to 2.5 bar gauge), there are modern furnaces operating at pressures much lower than this. These pressures can be as low as 0.25 bar gauge, depending on the age of the furnace and other constraints such as available blast pressure and limitations due to the gas treatment plant construction.

The sealed charging system can be a bell charging system or a bell-less charging system. Some dust and BF gas emissions may arise during charging. The evacuation of gas at the top of the furnace and connection to the BF gas treatment system can be used to control emissions at this stage of the process.

6.1.3 Blast furnace operation

In a blast furnace, the raw materials enter at the top, while the products (molten iron and slag) are tapped from the bottom (the hearth). The solid burden moves downwards, meeting a rising stream of hot reducing gas. BF gas with residual calorific value is collected from the top of the furnace for treatment.

A blast furnace can be divided into six temperature zones:

- the top: At the top, charging of the burden and evacuation of BF gas occurs
- the shaft: in the shaft, the hot BF gas gives its heat to the solid burden. The temperature of the burden rises from ambient temperature to approximately 950 °C and the iron oxide becomes partially reduced in this zone
- the belly: the belly links the shaft to the bosh. In this section, the temperature rises further from 950 °C to approximately 1250 °C. Further reduction of the iron oxide takes place and coke reaction begins
- the bosh: coke reactions continue to take place in the zone of the bosh. The iron melts and slag is formed
- the tuyères: in this zone the hot blast is introduced into the furnace by means of a series of tuyères (up to 42). The tuyères are located around the upper perimeter of the hearth and are fed by a large pipe (bustle pipe), circling the furnace at the height of the bosh. Temperatures here can exceed 2000 °C and the oxides are completely reduced
- the hearth: the hearth collects the molten hot metal and slag. One to four tap holes are located around the hearth, with one or two in operation at any time.

The shaft, belly, bosh and tuyère belt are typically water-cooled with the hearth water, oil or air-cooled. The furnace is lined with refractory material (the hearth being up to 1.5 m thick at least at the hearth level).

Hot metal production ranges from approximately 0.5 Mt/yr for small blast furnaces to about 5.5 Mt/yr for large blast furnaces.

Blast furnace technology uses high-grade ore. Any elements accompanying the iron are distributed between the hot metal phase and slag. Those passing into the hot metal include phosphorus, sulphur, manganese and silicon. Titanium, aluminium, calcium, magnesium and the bulk of silicon and sulphur pass into the slag as oxides or metalloids. It is also possible for a variety of elements to volatilise and deposit on different parts of the blast furnace. This is especially the case for zinc (Zn) and lead (Pb) which reach the blast furnace via iron ores and recycled by-products via the sinter plant.

The total zinc in the charge generally varies from 100 – 250 g/t of hot metal produced. As a rule of thumb, most modern plants restrict zinc to 100 – 150 g/t hot metal. Dusts and sludges with a high zinc or lead content are usually not accepted as returns to the sinter plant, or are only used in limited amounts [[344, Eurofer 2007](#)].

Removal of Zn and Pb from the furnace is done by operating the blast furnace in such a way that the temperature in the centre of the furnace is kept above 400 °C. The zinc is then more likely to be removed with the top gas as fine ZnO particles, which are almost completely retained in the BF gas treatment [[105, Pazdej et al. 1995](#)].

Blast furnace top gas

BF gas contains about 20 – 28 % CO, 1 – 5 % H₂, inert compounds (50 – 55 % N₂, 17 – 25 % CO₂), some sulphur and cyanide compounds and large amounts of dust from the burden. BFs with NG and COG injection have higher hydrogen contents of up to 10 % in the top gas. The amount of cyanide may be especially high during blowdown operations of the blast furnace; but this only occurs occasionally and then additions are made to the system to minimise cyanide formation. The heating value of BF gas is approximately 2.7 – 4.0 MJ/Nm³. The production of BF gas is approximately 1200 – 2000 Nm³/t hot metal.

After cleaning, the BF gas is often used as a fuel after enriching with coke oven gas, BOF gas or natural gas, which have higher heating values. BF gas can also be used without upgrading (e.g. in the hot stoves) if modern burners and/or combustion air preheating are applied and if appropriate safety precautions are taken [145, UBA Comments 1997].

6.1.3.1 Reducing agents application

The reducing agents used for processing the iron oxides in the blast furnace are coke, coal, oil gas and other hydrocarbon sources. These are mainly used to produce the reducing gas and thus to promote the reduction of the iron oxides to metallic iron, and then for carburising the iron. The most important reducing agent is coke provided by the coking process (see Chapter 5).

A portion of the coke in the blast furnace might be replaced by coal, oil or gas injected at the tuyère level, which is also called direct injection.

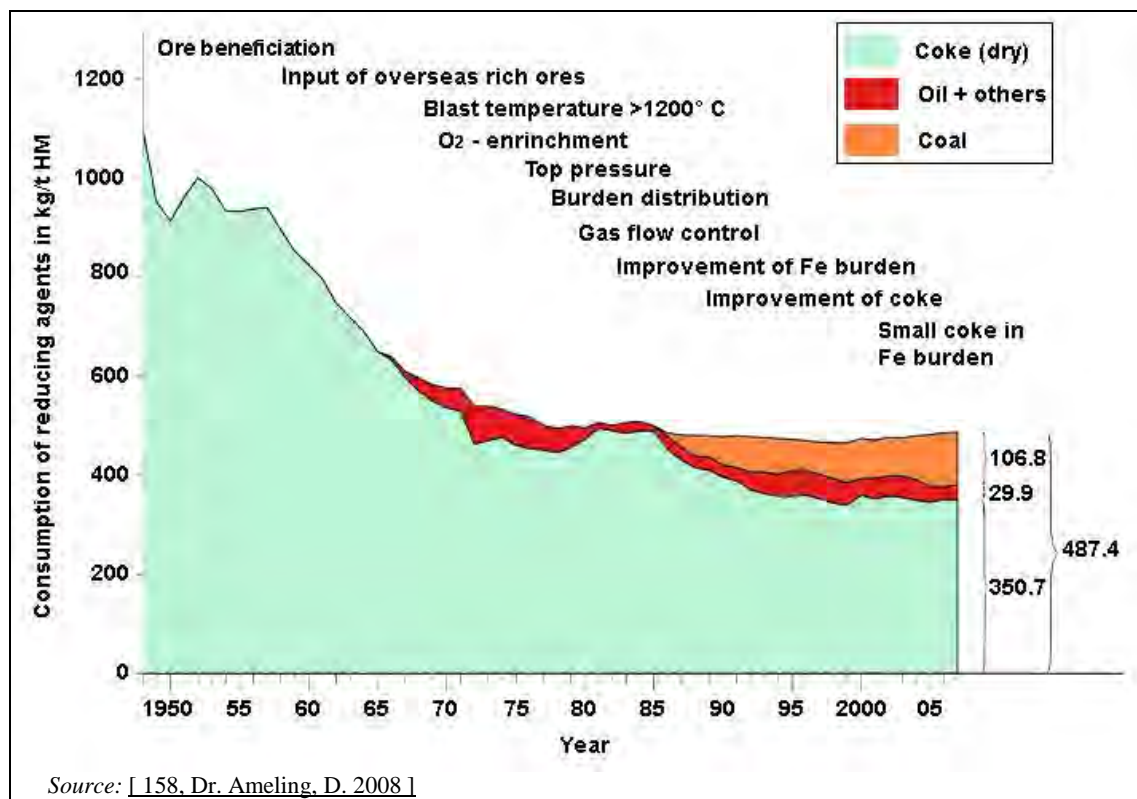

Figure 6.3: Average consumption of reducing agents of the blast furnaces in Germany

Figure 6.3 shows the average consumption of reducing agents of the blast furnaces in Germany and the development in reducing agent demand and types since 1950. What can be seen is that the total demand has been reduced drastically over the years by the mentioned measures. The

application of oils started in the late 60s, whereas coal injection appeared in 1985 and has increased since.

Coal or oil injection into blast furnaces is a technique now widely applied in Europe and worldwide. Figure 6.4 gives the reducing agents consumption levels for different countries or regions in the year 2006. It can be seen that worldwide, coke and coal are the main reducing agents used. The use of coke replacement through coal injection depends upon factors such as productivity, coke properties, desired hot metal quality, type (e.g. anthracite) and condition (humidity) of coal, etc. [11, Campell et al. 1992] [65, InfoMil 1997].

It should be stressed, however, that a certain amount of coke is still necessary in the blast furnace to allow proper blast furnace operation. The theoretical maximum for coal injection at the tuyère level is thought to be 270 kg/t hot metal. This limit is set by the carrying capacity of the coke and the thermochemical conditions in the furnace. The coke provides the required carrying capacity to sustain the blast furnace charge and ensures sufficient gas penetration.

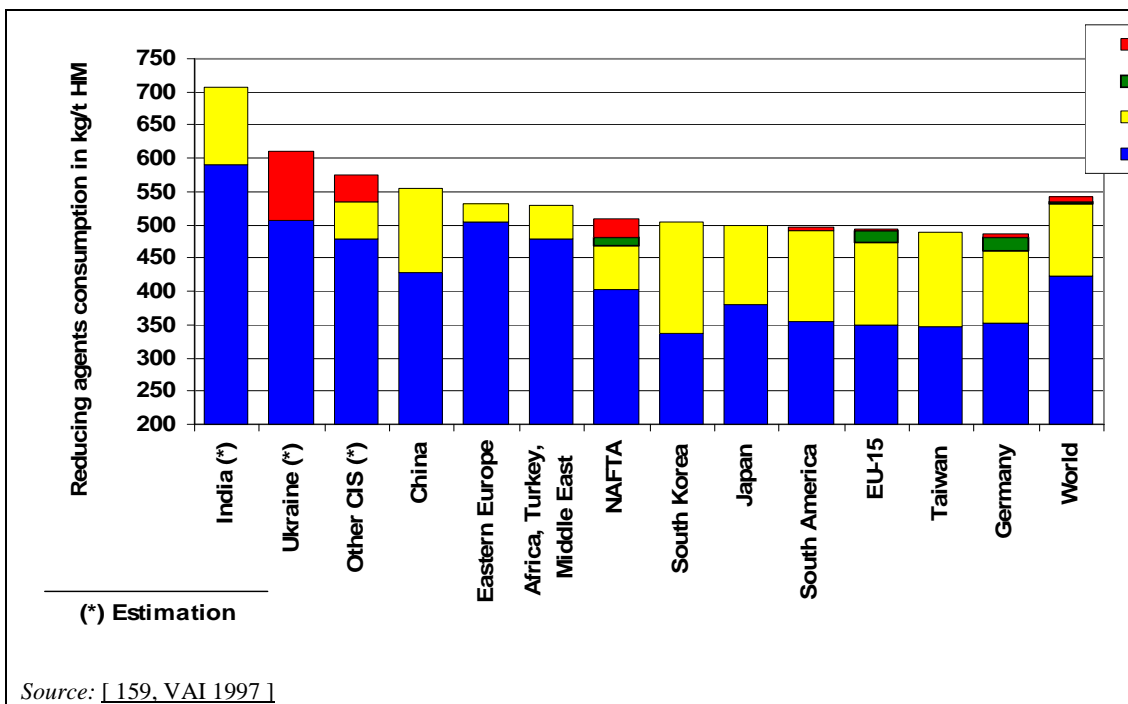

Figure 6.4: Reducing agent consumption in blast furnaces in the world in 2006

Direct injection of reducing agents means replacing part of the coke by another hydrocarbon source, which is injected in the furnace at the tuyère level (see also Section 6.2.2.4). As mentioned above, coal and oil are the most commonly used of the tuyère injectants. Other hydrocarbons may be used such as heavy fuel oil, oil residues, recovered waste oil, coal tar, granular material or, more commonly, pulverised coal, natural gas or coke oven gas and plastics. By reducing the need for coke, overall pollution and energy demand decrease.

Pulverised coal injection (PCI) or oil injection can provide important economic and operational benefits. These include:

- lower consumption of expensive coking coals and a wider range of coals being used
- extended coke oven life
- higher BF productivity
- greater flexibility in BF operation (adjusting the tuyère input is much easier than the burden adjusting charge)
- improved consistency in hot metal quality and silicon content
- reduced overall emissions from steel plants due to lower emissions from coke making.

The disadvantages of PCI are:

- additional costs for air enrichment. Providing with consistently large oxygen amounts require an air separation plant
- additional demand on the pulverisers in existing plants and additional requirements for injection unit maintenance.

The injection of significant amounts of coal and oil decreases the raceway temperatures which influences the efficiency of the blast furnace. This means that in blast furnaces with conventional smelting reduction, the allowed coal injection is limited to 150 kg/t hot metal. To maintain suitable raceway conditions and at the same time achieve higher input rates of coal and/or oil (up to 260 kg/t hot metal), different options exist. The common option is to use oxygen to enrich the blast or to inject the coal or oil together with the oxygen at the tuyère level. The latter ones are called oxy-coal or oxy-oil injection (see Section 6.3.12).

At the time of writing this BREF (2010), new BFs or upgraded existing injection systems are designed for PCI rates of 200 kg/t hot metal or more.

Reference literature

[158, Dr. Ameling, D. 2008] [160, IEA Clean Coal Centre 2006] [208, Lindfors et al. 2006] [211, Remus, Rainer 2008] [277, Wiesenberger 2007]

6.1.4 Hot stoves operation

The hot blast for the blast furnace operation is provided by the hot stoves (sometimes called 'blast furnace cowpers'). Stoves are auxiliary installations used to heat the blast. Increased blast temperature results in a reduction of carbon requirements. The main function of the hot blast is to provide the oxygen necessary for coke gasification, and thus produce the gas that, on contact with the burden, reduces iron oxides.

The stoves operate on a cyclical basis. They are heated up by burning gases (usually enriched BF gas) until the dome is at the correct temperature (approximately 1100 – 1500 °C). Combustion gas is then cut off and cold ambient air is forced through the stoves in the opposite direction. The cold air is heated by the hot bricks and thus forms the hot blast (900 – 1350 °C), which is fed to the blast furnace. The process continues until the stove can no longer generate the proper blast gas temperature, after which the initial heating cycle is started again. The duration of each cycle depends on individual site conditions such as energy source, system characteristics and conservation measures.

In principle, hot stoves can be classified as being of either the internal or external combustion chamber type (see Figure 6.5). This distinction is important for CO emissions.

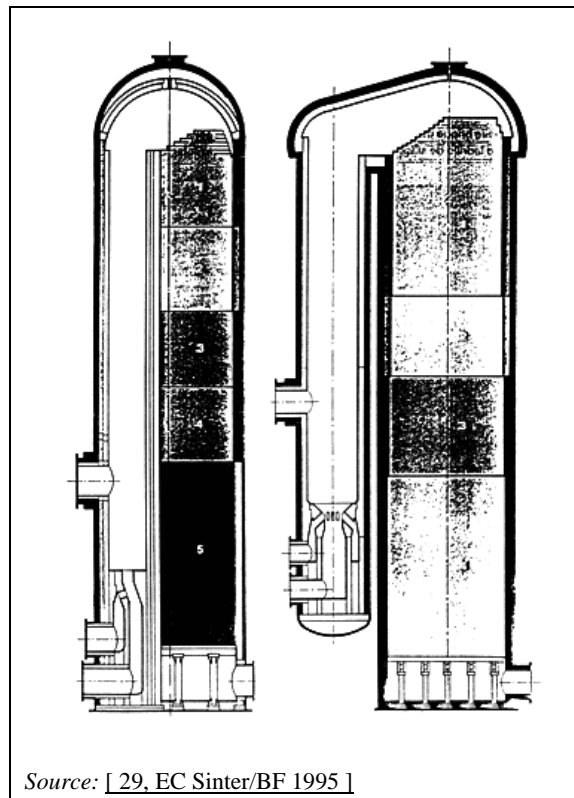

Figure 6.5: Cross-section of hot stoves (‘cowpers’) with an internal and external combustion chamber

Three or four hot stoves are necessary for each blast furnace. Emissions to air occur during the heating phase of the stove.

6.1.5 Casting

The blast furnace is periodically cast to remove the hot metal and slag from the hearth. For this purpose, one of the tap holes is opened in the side wall of the hearth by means of a tap hole drill or soaking bar. In some cases, an oxygen lance is used to open the tap hole. Usually, a blast furnace has one to four tap holes. The number of tap holes is determined by the capacity (size) of the blast furnace.

In modern blast furnaces, hot metal and slag are tapped together (typically slag starting to run after the hot metal). The slag and hot metal are subsequently separated at the skimmer in the cast house, after which each continues in a separate runner.

Hot metal tapped from the blast furnace flows along refractory or low cement covered runners, lined with a heat-resistant alumina-carbon or silica-carbide mixture, and is poured into ladles (directly or via tilted runners). These ladles can be open or closed top types, or torpedo cars. In this molten state, the metal has a temperature of approximately 1440 – 1500 °C.

Slag tapped from the furnace flows in runners to a granulation plant to slag ladles or to an open pit.

At the end of the casting cycle, the tap hole is closed mechanically by injecting a specific heat-resistant tap hole clay mixture, using a ‘mud gun’ or ‘tap hole gun’.

6.1.6 Slag cooling and processing

[174, Euroslag 2006] [347, Eurofer 2007]

The amount of slag produced depends upon the gangue content of the blast furnace, the ferrous burden, the coke ash and ash from the injection material, e.g. coal, and the amount of flux required to achieve the necessary hot metal quality. In order for blast furnace slag to be acceptable for use outside the iron and steel works, it is necessary to take additional measures to ensure that the slag chemistry and/or physical properties are requisite. Slag can be put to a variety of uses including material for road building, as concrete aggregate, as thermal insulation (mineral wool), and as a clinker substitute in cement production. Total utilisation of blast furnace slag is a target that has already been met in many cases [347, Eurofer 2007].

At the time of writing (2010), three principal processes are used to treat liquid blast furnace slag:

- a slag granulation process with water (75 %)
- a slag pelletising process (2 %)
- a slag pit process (also called cooling in air) (23 %).

All of these slag cooling processes may generate hydrogen sulphide, which can result in odour.

The granulation by air is presently used for processing blast furnace slags in some industrial scale plants. In all air granulation processes, the slag is dispersed and the particles are cooled off during their way through the surrounding air. Often an additional water spray is applied to the dispersed slag in order to achieve a faster cooling. Due to some disadvantages (e.g. high space requirements, noise, uncontrollable gaseous sulphur compound emissions, PM emissions), the air granulation is operated in very few industrial plants.

Other processes such as blowing to produce slag wool and foaming to produce foamed blast furnace slag are used less frequently.

The possible flow lines for the liquid slag tapped from the blast furnace and the measures to influence the quality are shown in Figure 6.6.

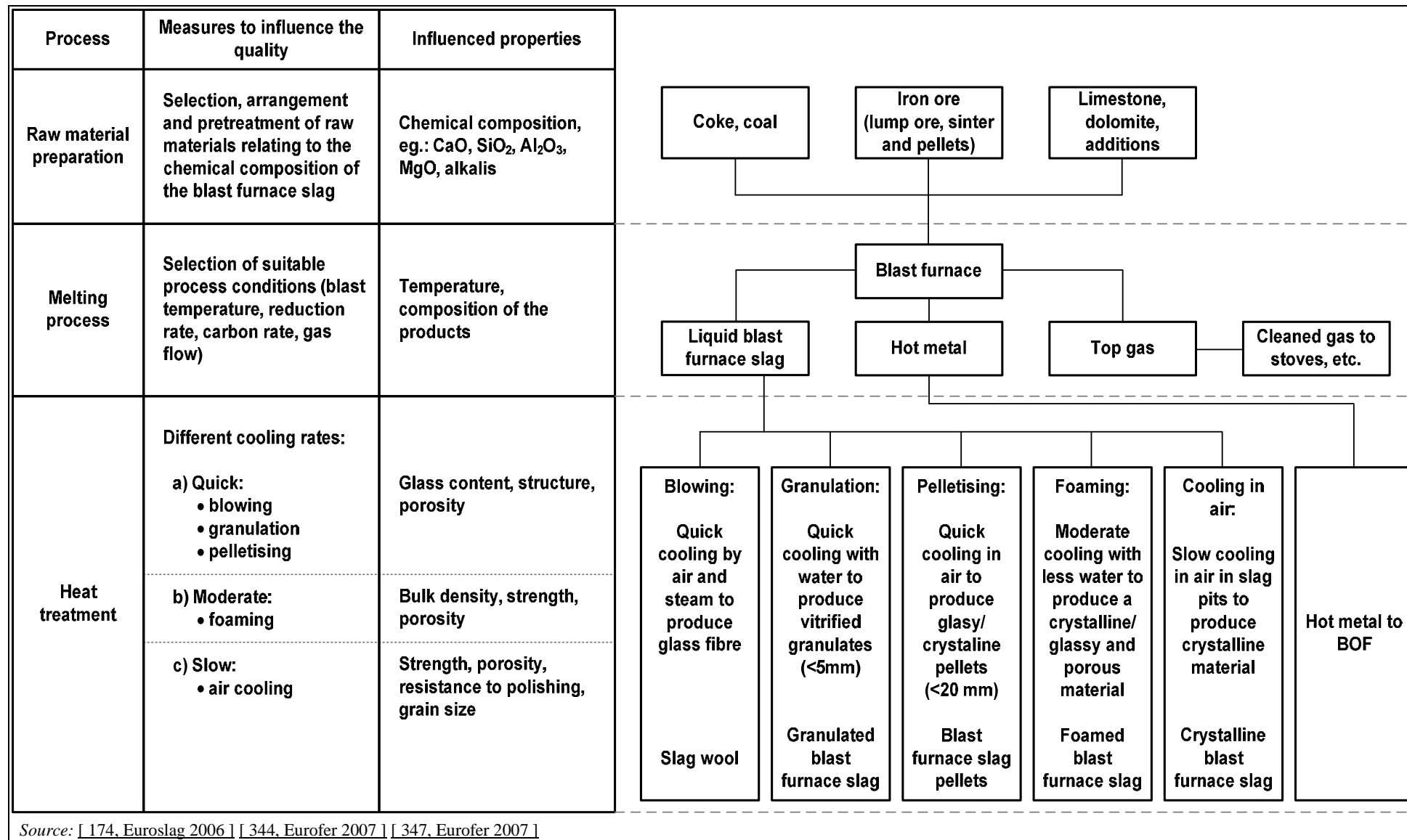

Source: [174, Euroslag 2006] [344, Eurofer 2007] [347, Eurofer 2007]

Figure 6.6: Summary of control methods and flow sheet for liquid BF slags

6.1.6.1 Slag granulation processing

[241, Poland 2007] [347, Eurofer 2007] [392, Schmidt et al. 2003]

Granulation is the most common process used at the time of writing (2010) in the EU to process blast furnace slag. The process involves pouring the molten slag through a high-pressure water spray in a granulation head (sometimes in granulation chambers), located in close proximity to the blast furnace. For slag granulation, fresh water in open/closed circuit or in some cases sea water in open circuits are used.

After granulation, the slag/water slurry is typically transported to a drainage system, consisting of a horizontal filtering basin (e.g. the OCP – open circuit process), a vertical filtering hopper or a rotating dewatering drum (e.g. the INBA® and the RASA® process). In several cases, the slag/water slurry is transported to a separation tank prior to water drainage. In some cases, water vapour is collected and condensed or emitted via a stack.

After dewatering, the residual moisture of the slag sand is generally around 10 %. The filter bed is periodically backwashed with water and air to remove the fine particles. Figure 6.7 and Figure 6.8 show two examples of granulation techniques: the OCP and the INBA process.

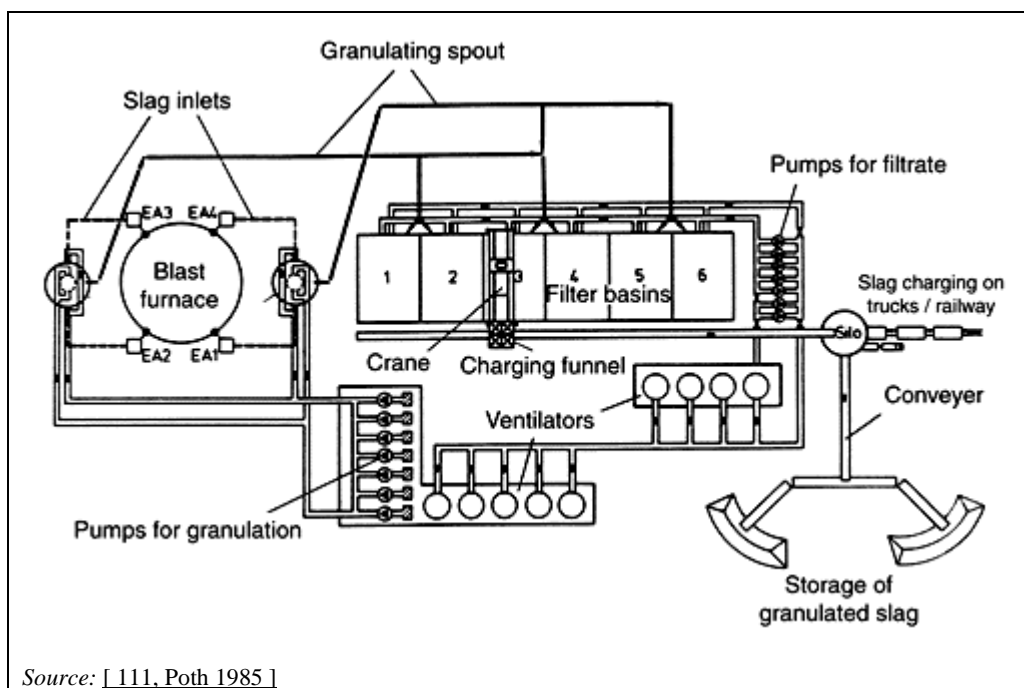

Figure 6.7: Example of a granulation of slag from the blast furnace in the open circuit process

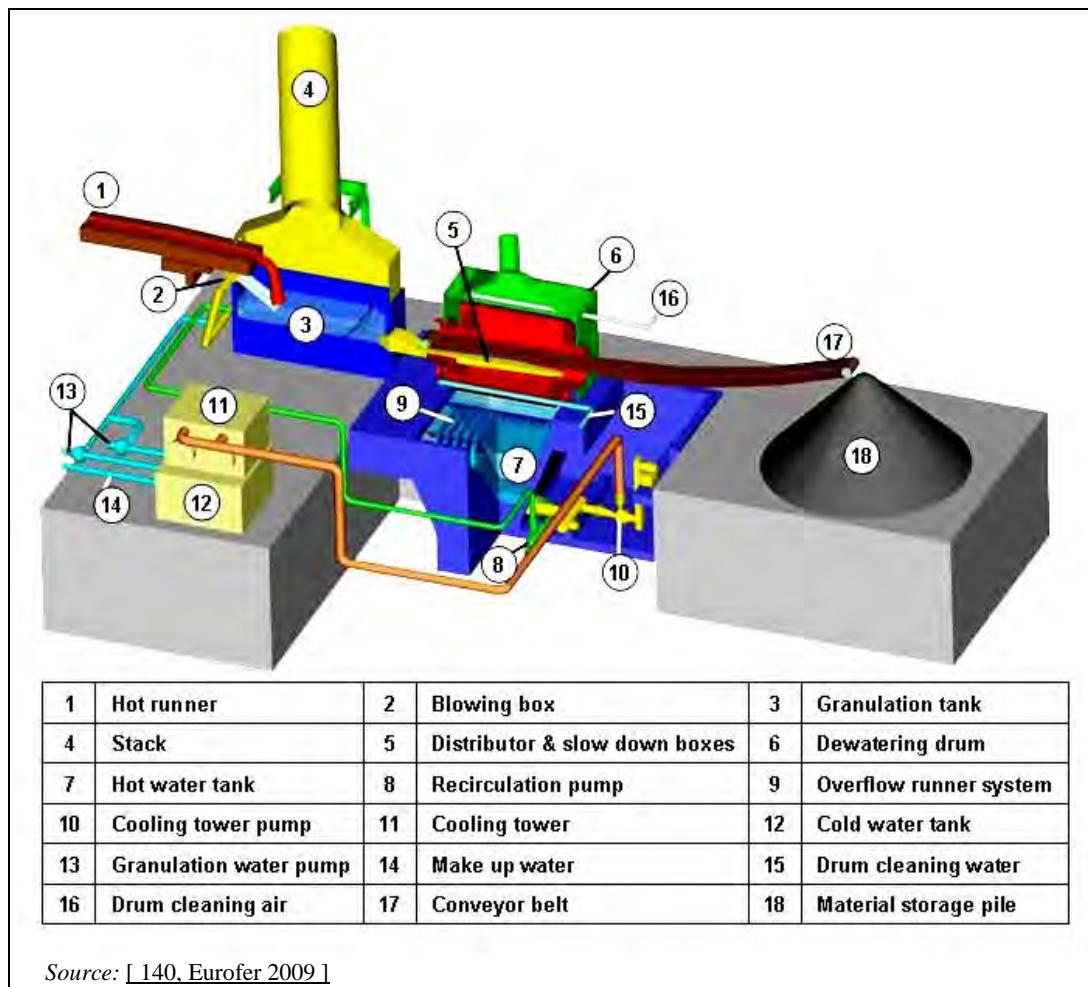

Figure 6.8: Granulation of slag from the blast furnace in the INBA process

6.1.6.2 Slag pelletising process

The pelletising process is only in use in a few plants in the EU and in some plants in Canada. The molten slag is spread in a layer on a plate, which acts as a deflector. The sheet of slag is sheared by controlled water-jets which initiate the swelling and cooling of the slag. The slag is then projected centrifugally into the air on a rotating drum to complete the blowing up and cooling. The slag particles follow different trajectories according to their size, which range from granulated sand to expanded pellets [347, Eurofer 2007].

When properly applied, process water is totally consumed by evaporation and as moisture in the product. Specific water consumption is less than that required for wet granulation.

Similar to the granulated slag, the pelletised slag is used as a clinker substitute in cement production.

6.1.6.3 Slag pit process

[392, Schmidt et al. 2003]

The slag pit process (also called cooling in air) involves pouring thin layers of molten slag directly into slag pits adjacent to the furnaces. Alternatively, after the collection of slag in ladles, the molten slag is slowly cooled and crystallised in the open air. The pits are alternately filled and excavated, and lump slag is broken up and crushed for use as coarse aggregate. In practice, cooling time can be reduced by spraying the hot slag with a controlled amount of

water, although this increases the potential for odour emissions. When properly applied, the cooling water is totally consumed by evaporation.

The slag pit process produces lump crystalline slag that is a desirable aggregate in construction (i.e. raw material for road construction). The cooling time has a strong influence on the quality of lump slag produced. Water cooling also improves the microstructure, achieving better mechanical properties.

Some identified disadvantages of this process are that the product quality at this point can hardly be influenced which leads to limited product applications, and that the handling of liquid slag and the crushing of solid slag requires a great deal of work compared to granulation and pelletisation.

6.2 Current emission and consumption levels

6.2.1 Mass stream overview and input/output data

Figure 6.9 provides an overview for the input and output mass streams of a blast furnace. This overview may be used for the collection of data from single blast furnaces.

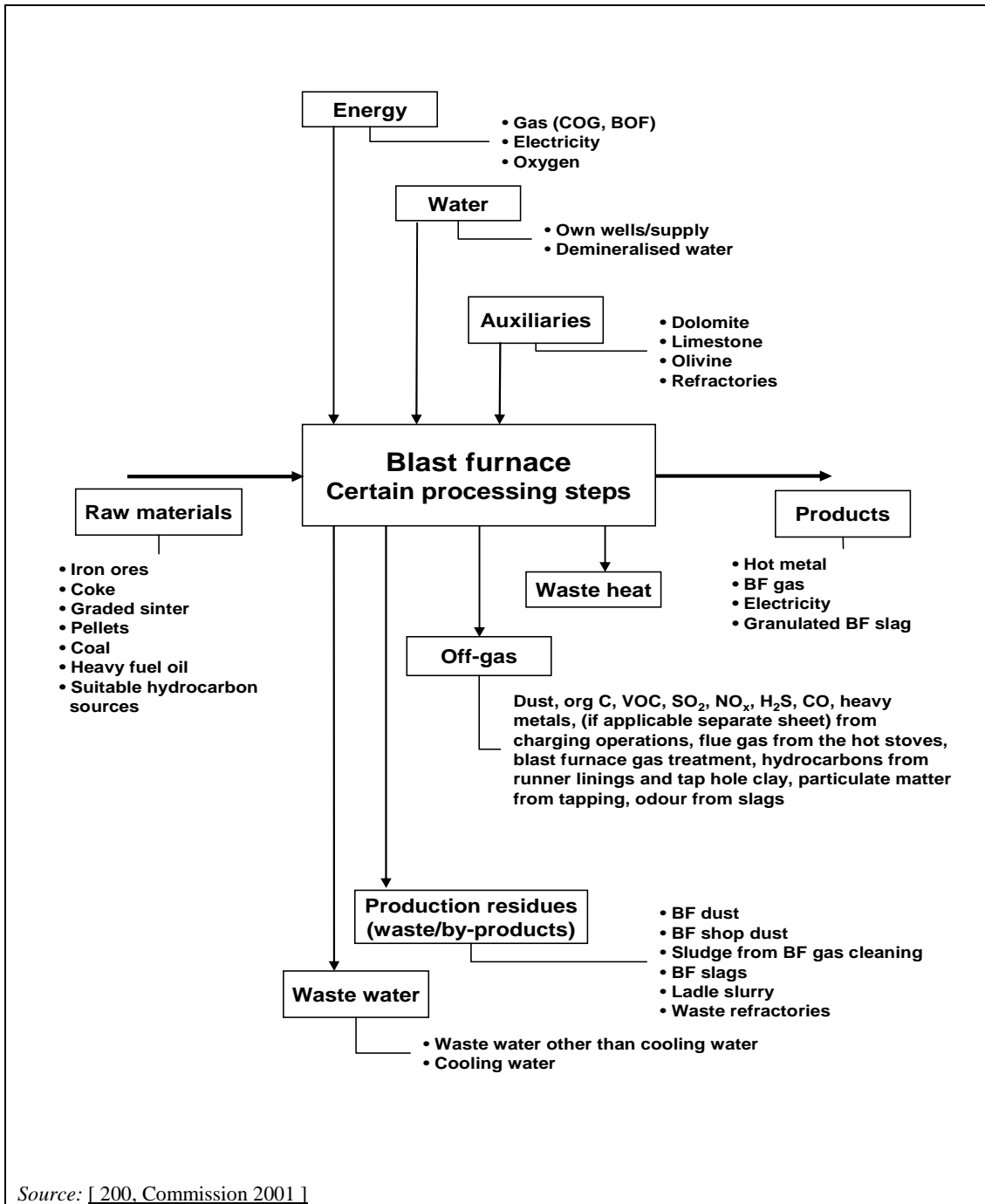

Figure 6.9: Mass stream overview of a blast furnace

Figure 6.10 shows an example of the general process layout of a blast furnace along with the input and output mass streams.

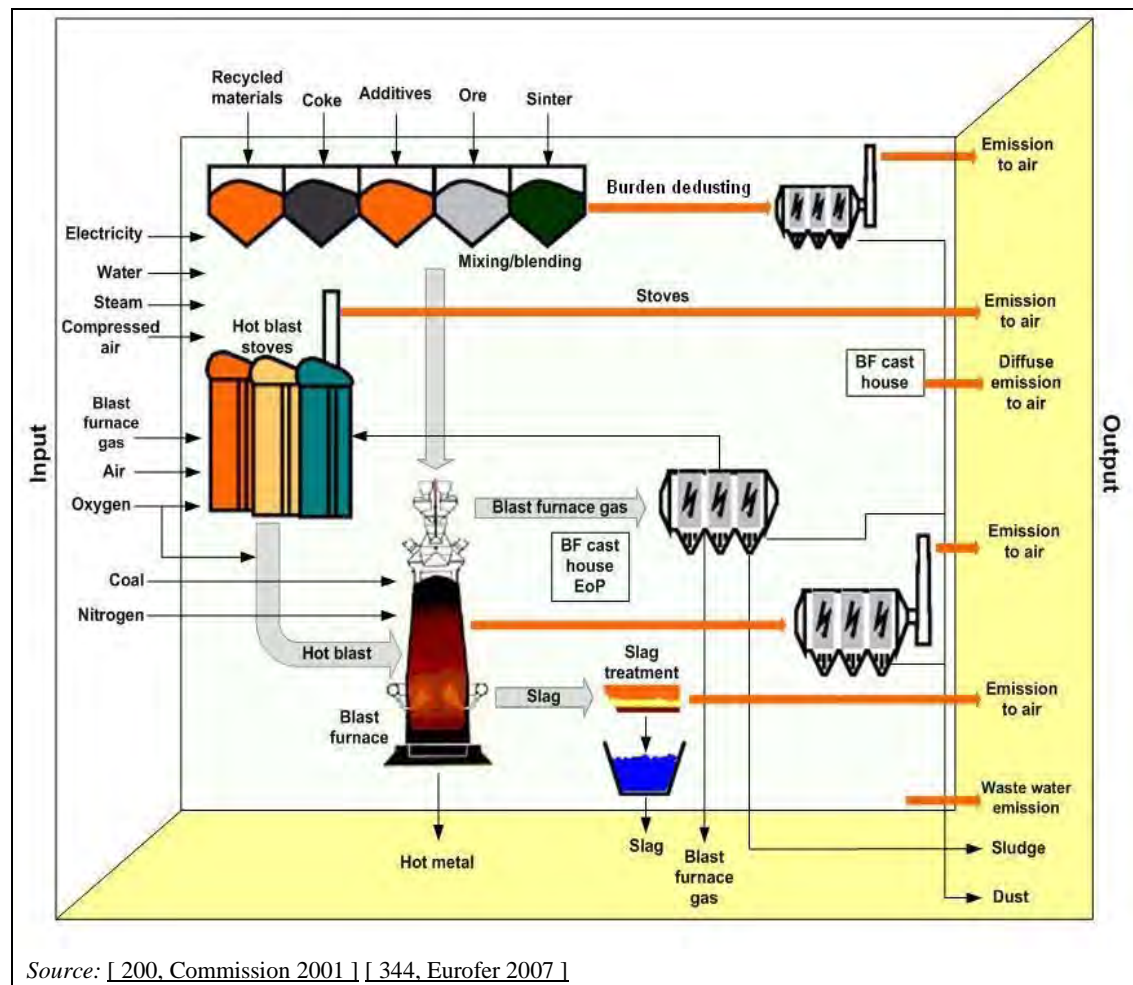

Figure 6.10: General process layout of a blast furnace with indication of the individual operations and the input and output mass streams

Specific input factors and specific emission factors have been determined for blast furnaces. Table 6.1, Table 6.2 and Table 6.5 give figures for these factors taken from many blast furnaces, thus giving a representative picture of modern plants.

Inputs

Table 6.1: Input data from blast furnaces in different EU member states

Inputs	Units	Maximum	Minimum	Weighted average value
Raw materials				
Sinter	kg/t HM	1621	116	1088
Iron ore	kg/t HM	684	0	180
Pellets	kg/t HM	972	0	358
Coke	kg/t HM	515	282	359
Returned material	kg/t HM	106	0	20.1
Limestone/Lime	kg/t HM	80	0	25.7
Tuyère injection				
Oil	kg/t HM	116	0	30.1
Coal	kg/t HM	232	0	162
COG	kg/t HM	46.9	0	1.1
Natural gas	kg/t HM	5.6	0	2.2
Oxygen	kg/t HM	85.1	0	54.4
Other ⁽¹⁾	kg/t HM	73.5	0	3.6
To stoves				
BF gas	MJ/t HM	2287	1.2	1536
COG	MJ/t HM	817	0.024	284
Natural gas	MJ/t HM	819	0	168
BOF gas	MJ/t HM	259	0.124	213
Energy				
Electricity	MJ/t HM	850	107	268
Other				
Oxygen	m ³ /t HM	67	4.6	43
Nitrogen	m ³ /t HM	59	33	46
Steam	MJ/t HM	435	14.8	48
Compressed air	m ³ /t HM	35	0.008	9.1
Cooling water ⁽²⁾	m ³ /t HM	22.9 ⁽⁴⁾	0.37 ⁽⁴⁾	–
Process water ⁽³⁾	m ³ /t HM	13	0.28	3.4
⁽¹⁾ Other could include plastic, recovered oils, fats, emulsions, etc. ⁽²⁾ Water that does not have direct contact in the process. ⁽³⁾ Process water is an integral part of the process and is not contained in a defined cooling system, e.g. slag pit water. ⁽⁴⁾ Differences reflect once-through systems and closed systems. Weighted averages are not calculated since once-through systems should not be compared to closed systems. NB: — HM: hot metal. — Blast furnace input data for 2004, based upon a production of 73.4 Mt HM. Source: [140, Eurofer 2009] [234, Poland 2007] [346, Eurofer 2007].				

Outputs

Table 6.2: Blast furnace output data for 2004

Outputs	Units	Maximum	Minimum	No	Tonnage HM
Energy					
BF gas	MJ/t HM	6061	3377	16	62956753
Electricity	MJ/t HM	91	40	6	31 160 302
Production residues (waste/by-products)					
Slag	kg/t HM	346.6	150.0	18	69 223 393
Top gas dust	kg/t HM	18.0	3.4	13	61 044 562
Top gas sludge	kg/t HM	22.3	2.0	15	66 268 056
Dust from cast house dedusting	kg/t HM	5.1	0.6	8	41 197 012
Used refractory, etc.	kg/t HM	5.9	0.3	8	48 063 570
Waste water	m ³ /t HM	13.736 (*)	0.096 (°)	12	54 428 253
Data based upon: – Tonnes of hot metal = 73 459 787. No single output has been reported for all installations. This is the reason why the figure is higher than any other in the column Tonnage HM. – Tonnes of BF slag = 19 562 299 (*) Differences reflect once-through systems and closed systems. NB: — HM = Hot metal. — No = Number of EU installations that have reported. — Tonnage of hot metal: Amount of hot metal produced by the installations that have reported data for each item. Source: [140, Eurofer 2009] [208, Lindfors et al. 2006] [234, Poland 2007] [346, Eurofer 2007].					

The following tables Table 6.3 – Table 6.6 complement the information with more details on emission factors to air (after abatement) for the charging zone, the BF cast house and main individual operations associated with a blast furnace.

Table 6.3: Emissions from coal preparation for injection

Operation/emission source: Coal preparation for injection	Dust (g/t HM)
Number of data	15
Range (min.-max. values)	2 – 54
x±s	12±16
NB: – HM = Hot metal (crude liquid steel). – x±s = Mean value and standard deviation (only calculated if enough data are available). Source: [200, Commission 2001].	

Table 6.4: Emissions from the charging zone

Parameter	Units	Range
Dust	g/t HM	2.7 – 81.4
PM ₁₀	g/t HM	0.2 – 11.0
Source: [200, Commission 2001] [346, Eurofer 2007].		

High values for dust emissions from the charging zone have been reported depending on the type of spout and the presence or not of an offtake system directing the gas from the airlock to the BF gas treatment system (see Section 6.3.5). In the absence of the latter device, the emission factors for the charging zone are reported to be as high as 400 and 850 g dust/t hot metal in two Belgian plants [170, N.N. 1997].

Table 6.5: Emission to air from BF cast house (end-of-pipe)

Parameter	Units	Maximum	Minimum
Dust	g/t HM	41.95	0.42
PM ₁₀	g/t HM	25.92	0.26
SO ₂	g/t HM	193.80	7.34
NO _x	g/t HM	2.08	2.08
CO	g/t HM	35.63	21.52
Cr	mg/t HM	10.41	2.76
Mn	mg/t HM	53.02	45.12
Ni	mg/t HM	10.61	1.99
Pb	mg/t HM	24.33	2.19
Zn	mg/t HM	12.9	3.81
Hg	µg/t HM	200.3	55.50
As	µg/t HM	299.8	205.69
Cd	µg/t HM	223.3	65.3

NB: — Particulates are generated in the air during casting as a consequence of the oxidation; two areas are of concern: a) at the tap hole and b) at the spout to the torpedo. To reduce the pollution to the atmosphere from this minor oxidation of the hot metal, the runners are covered and suction is applied at both the tap hole and torpedo filling station. The air from this is treated in ESPs or bag filters before discharge to the atmosphere. The data provided refer to discharge from the abatement equipment.
— HM = Hot metal.

Source: [140, Eurofer 2009] [346, Eurofer 2007].

Particulates are released into the air during casting as a consequence of oxidation. Two areas are of concern; the area at the tap hole and the area at the spout to the torpedo ladles. To reduce the pollution to the atmosphere from this minor oxidation of the hot metal, the runners are covered and a suction is applied at both the tap hole and the torpedo filling station. The air from this is treated in ESPs or bag filters before discharge to the atmosphere. The data provided in Table 6.5 refer to discharge from the abatement equipment.

Table 6.6: Emission to air for slag granulation in blast furnaces

Operation/emission source	Dust (g/t HM)	H ₂ S (g/t HM)	SO ₂ (g/t HM)	NO _x (g/t HM)	CO (g/t HM)
Slag granulation NR	NA	14/1 – 300 ⁽¹⁾	13/1 – 142 ⁽¹⁾	LS	LS
x±s		63±95	31±42		

⁽¹⁾ Low values (around 1 g/t HM) are for slag granulation plants with fume condensation.
NB: — HM = Hot metal (crude liquid steel).
— x±s = Mean value and standard deviation (only calculated if enough data are available)
— NR = Number of data/range of data (min-max).
— LS = Low significance.
— NA = Not available.

Source: [200, Commission 2001].

6.2.2 Environmental issues for the blast furnace process

The blast furnace is primarily a source of dust and gaseous emissions to air. When abatement techniques are applied to reduce emissions, cross-media effects can occur.

Generally, Sections 6.2.2.1 to 6.2.2.5 below describe the most relevant environmental issues in the blast furnace process:

- Emissions to Air from:
 - burden preparation
 - charging and conveying
 - blast furnace gas (as an indirect emission at the site of combustion)
 - hot stoves
 - cast house
 - slag processing
- Waste water from:
 - overflow water from BF gas scrubbing
 - waste water from slag granulation
 - blowdown from cooling water circuits
- Process residues such as wastes and by-products from:
 - dust from casting
 - dust and sludge from BF gas treatment
 - slag from blast furnace
- Process residues such as wastes and by-products from:
 - direct injection of reducing agents
 - reducing agent demand
- Noise.

6.2.2.1 Emissions to Air

[145, UBA Comments 1997] [247, Netherlands 2007]

Burden preparation

Emissions from the drying/crushing of coal can be relevant. Available data from one Belgian plant show that the emissions for dust are between 54 – 139 mg/Nm³, for CO 292 – 383 mg/Nm³ and for CH₄ 1250 mg/Nm³. All values are related to an oxygen content of 3 % [171, N.N. 2007].

Pulverised coal for direct injection is usually stored in bunkers and silos. Emission to air can also occur by displaced air during loading. For this reason the dust-containing air is usually captured and subsequently dry dedusted.

Charging and conveying

Since the furnace pressure is higher than atmospheric pressure, a sealed charging system based on ‘bell-shaped’ or ‘bell-less type’ charging is used.

All components present in the BF gas may be emitted here, but the main components are carbon monoxide (CO) and dust. When using systems with gas recovery, much lower charging and conveying emissions are possible.

Blast furnace gas

Raw BF gas contains dust (including heavy metals and carbon), carbon monoxide, carbon dioxide, sulphur compounds, ammonia, cyanide compounds, hydrocarbons and PAH. BF gas is contained and used as an energy source. The gas is purified in order to meet quality specifications and is reused for various firing processes such as blast generation in the hot stoves (see Section 6.1.4) or for coke oven firing (see Section 5.1.2.2). Thus (indirect) emissions of combusted BF gas occur.

BF gas treatment usually consists of pretreatment for the removal of coarse dust and subsequently wet scrubbing for the removal of fine dust (and thus heavy metals), SO₂ and cyanide compounds. In some plants an electrostatic precipitation is applied.

The dust content of raw BF gas is very different from one plant to another and is also highly dependent on process conditions, varying from 5.5 – 40 kg/t hot metal produced. After cleaning, the BF gas contains normally less than 10 mg/Nm³ dust. This is emitted at the site of combustion.

In Table 6.7 specific factors of several components in raw untreated BF gas are given.

Table 6.7: Raw blast furnace gas composition (before treatment)

Raw BF gas component	Value	Unit	Specific factor	Unit
BF gas production	1.0 – 7.0	$1 \cdot 10^5 \text{ Nm}^3/\text{h}$	1200 – 2000	$\text{Nm}^3/\text{t HM}$
Dust	3500 – 30000	mg/Nm^3	7000 – 40000	$\text{g}/\text{t HM}$
Hydrocarbons	67 – 250	mg/Nm^3	130 – 330	$\text{g}/\text{t HM}$
Cyanide compounds (as CN)	0.26 – 1.0 ⁽¹⁾	mg/Nm^3	0.5 – 1.3	$\text{g}/\text{t HM}$
Ammonia	10 – 40	mg/Nm^3	20 – 50	$\text{g}/\text{t HM}$
• PAH ⁽²⁾				
• Benzo(a)pyrene	0.08 – 0.28	mg/Nm^3	0.15 – 0.36	$\text{g}/\text{t HM}$
• Fluoranthene	0.15 – 0.56	mg/Nm^3	0.30 – 0.72	$\text{g}/\text{t HM}$
Carbon monoxide	20 – 28	vol.-%	300 – 700	$\text{kg}/\text{t HM}$
Carbon dioxide	17 – 25	vol.-%	400 – 900	$\text{kg}/\text{t HM}$
Hydrogen	1 – 5	vol.-%	1 – 7.5	$\text{kg}/\text{t HM}$

⁽¹⁾ Emissions during blowdown may be significantly higher.
⁽²⁾ Many other polycyclic aromatic hydrocarbons (PAH) are also present.
Source: [65, InfoMil 1997] [344, Eurofer 2007].

During the two-stage treatment of BF gas, dust is removed with a high degree of efficiency as are compounds associated with dust such as most heavy metals and PAH. Table 6.8 shows the BF gas composition after treatment. The gas still contains some heavy metals but compared with sinter plants (see Section 4.2.1), the load is much lower.

Table 6.8: Blast furnace gas composition (after two-stage treatment)

Treated BF gas component	Concentration	Unit	Specific factor	Unit
BF gas production	1.0 – 7.0	$1 \cdot 10^5 \text{ Nm}^3/\text{h}$	1200 – 2000	$\text{Nm}^3/\text{t HM}$
Dust	1 – 10	mg/Nm^3	1 – 20	$\text{g}/\text{t HM}$
Hydrocarbons	NA	mg/Nm^3	NA	$\text{g}/\text{t HM}$
H ₂ S	14	mg/Nm^3	17 – 26	$\text{g}/\text{t HM}$
Cyanide compounds (as CN)	NA	mg/Nm^3	NA	$\text{g}/\text{t HM}$
Ammonia	NA	mg/Nm^3	NA	$\text{g}/\text{t HM}$
Metals				
• Mn	0.10 – 0.29	mg/Nm^3	0.22 – 0.37	$\text{g}/\text{t HM}$
• Pb	0.01 – 0.05	mg/Nm^3	0.02 – 0.07	$\text{g}/\text{t HM}$
• Zn	0.03 – 0.17	mg/Nm^3	0.07 – 0.22	$\text{g}/\text{t HM}$
Carbon monoxide	20 – 28	vol.-%	300 – 700	$\text{kg}/\text{t HM}$
Carbon dioxide	17 – 25	vol.-%	400 – 900	$\text{kg}/\text{t HM}$
Hydrogen	1 – 5	vol.-%	1 – 7.5	$\text{kg}/\text{t HM}$

NB: NA = Data not available.
Source: [65, InfoMil 1997] [344, Eurofer 2007].

In the EU, wet scrubbing is the technique most commonly applied as a second step in BF gas treatment. Scrubbing generates a contaminated waste water flow, which contains suspended solids (e.g. carbon and heavy metals), cyanide compounds, nitrogen compounds, etc. The separated solids generate a waste problem because of heavy metals, especially zinc. Whereas coarse dust is normally recycled to the sinter plant, sludge from scrubbing is usually dewatered and either recycled to the sinter plant (normally via a hydrocyclone that separates fractions with a low and high concentration of heavy metals) or put to secure landfill [247, Netherlands 2007] [248, Eurofer 2007].

Hot stoves

Hot stoves are fired with gas. Depending on the installation, the combinations are:

- BF gas + COG gas
- BF gas + natural gas
- BF gas + BOF gas
- any other combination of the four gases used (BF gas, COG gas, Natural gas, BOF gas) or pure gas.

Coke oven gas contains sulphur compounds, which are emitted as SO₂ at the hot stove when the gas is used for firing. [145, UBA Comments 1997] reports that several hot stoves with modern burners and combustion air preheating are operated using BF gas without enrichment [344, Eurofer 2007].

Table 6.9 shows measured emission concentrations for the main pollutants from hot stoves.

Table 6.9: Emission concentrations from hot stoves

Parameter	Range (mg/Nm ³) Annual average	Range (mg/Nm ³) Half hourly average
Dust	<0.1 – 12	
CO	4.11 – 2891	20
NO _x	19 – 115	20 – 120
SO _x	4 – 154	60 – 210
Hg	0.003	
Cd, Tl	0.0057 ⁽¹⁾	
Sb, Pb, Cr, Co, Cu, Mn, Ni, V	0.24 ⁽¹⁾	
HF	<0.08	
HCl	3 ⁽¹⁾	
PCDD/F	0.002 – 0.004 (ng/Nm ³)	
⁽¹⁾ Values correspond to maximum values, not to annual averages. NB: The values are derived from seven EU installations and correspond to annual averages and for three German plants additionally to half-hourly averages. Source: [171, N.N. 2007] [200, Commission 2001] [244, Plickert 2007] [346, Eurofer 2007].		

Flue-gas flow from the hot stoves is approximately 100 000 to 500 000 Nm³/h per blast furnace. The specific off-gas flow is 400 – 1500 Nm³/t hot metal. Emissions concentrations for SO₂ are in the range of 4 – 154 mg/Nm³ depending on the used gas (on an annual average basis, see Table 6.9) which corresponds to 1.6 – 154 g/t hot metal. In case of a mixture of BF gas and non-desulphurised COG, the emission factor can be up to 400 g SO₂/t hot metal which corresponds to up to 267 – 1000 mg/Nm³.

The hot stoves are the main source of emissions of NO_x in the blast furnace process. NO_x is formed as a result of high temperatures in the stove. Emission concentrations are in the range of 19 – 115 mg/Nm³ (on an annual average basis, see Table 6.9) which corresponds to 6 – 173 g/t hot metal produced [344, Eurofer 2007].

Dust emissions from the hot stoves are usually between 1 and 12 mg/Nm³ which corresponds to 0.4 – 18 g/t hot metal [344, Eurofer 2007].

CO emissions are considerable in the case of internal combustion chambers (see Figure 6.5). Cracks in the brick work, which are very difficult to avoid, mean BF gas can move without combustion to the waste gas and can be emitted in concentrations of up to 2891 mg CO/Nm³. In

the case of an external combustion chamber with controlled combustion, the concentration is about $<50 \text{ mg CO/Nm}^3$ [171, N.N. 2007] [344, Eurofer 2007].

Cast house

The casting of hot metal generates dust emissions. On average, unabated emissions are in the range of 400 – 1500 g/t hot metal produced. These emissions mainly arise from contact between the hot metal and slag and ambient oxygen. In order to catch the dust formed during casting in many blast furnaces in the EU, cast house dedusting systems (dust extraction at tap hole, skimmer and hot metal charging to the torpedo ladle) with flows of between 200 000 and 700 000 Nm^3/h are used. Dust emissions depend on applied abatement techniques (in some cases there are still none) and dust collection efficiency. In many cases, bag filters are applied, achieving less than 10 mg dust/Nm^3 . Dust emission factors vary between 0.5 and 45 g/t hot metal with an average of 32 g dust/t hot metal. Furthermore, a certain amount of SO_2 is emitted from the liquid slag and iron during casting (7 – 195 g/t hot metal) [344, Eurofer 2007].

Table 6.10: Emission concentrations from the BF cast house and burden dedusting

Parameter	Range (mg/Nm^3) Annual average	Reference time period
Dust	0.3 – 10.4	AAV
	0.38 – 0.49	DAV
SO_x	12	AAV
Hg	<0.0001	AAV
Cd, Tl	0.00004	AAV
As, Co, Ni, Se, Te	<0.003	AAV
Pb, Co, Ni, Se, Te	<0.5	AAV
Pb, Cr, Cu, Mn, V	0.004 – 0.014	AAV
Sb, Cr, CN, F, Cu, Mn, V, Sn	<1	AAV
HCl	0.7	AAV
H_2S	1.2	AAV
NB: Values are the ranges derived from four EU installations and correspond to annual averages and for dust correspond to daily averages for one German plant.		
Source: [200, Commission 2001] [244, Plickert 2007] [346, Eurofer 2007].		

Slag processing

The reaction of water with molten slag, particularly with sulphur compounds (essentially CaS and MnS) generates both steam and diffuse H_2S and SO_2 emissions. These emissions cause potential odour and corrosion problems. Their importance varies according to the slag processing technique used. Blast furnace slag taken from the slag runner has a sulphur content of around 1 – 2 wt-%. The major sulphur compound in the slag is CaS [392, Schmidt et al. 2003].

Emissions can vary greatly from one plant to another, from one slag treatment cycle to another and within the slag treatment cycle itself. The range of available emission factors is wide. Available figures vary from 1 – 320 g $\text{H}_2\text{S}/\text{t}$ hot metal and 1 – 150 g SO_2/t hot metal for slag granulation. For an industrial INBA plant with an average slag flow rate of 3.5 t/min and a supposed exhaust air/steam flow rate of 10000 Nm^3/h at the stack, the resulting concentrations of H_2S and SO_2 are in the range of 50 – 28000 mg/Nm^3 for H_2S and 135 – 15600 mg/Nm^3 for SO_2 . If slag is not exposed to water but air-cooled, long-lasting low emissions of mainly SO_2 will occur. From the perspective of nuisance abatement, this can be considered an advantage [344, Eurofer 2007] [392, Schmidt et al. 2003].

Emissions of H_2S and SO_2 cause potential odour and corrosion problems. The gaseous sulphur compounds emissions depend strongly on the kind of granulation system, slag flow rate, slag/water ratio and on the granulation water temperature. Since the solubility of H_2S and SO_2

decreases with rising water temperatures, at cold water granulation systems, lower gaseous sulphur compounds emissions are observed than at hot water systems [242, Caughlin 2007] [392, Schmidt et al. 2003].

In order to reduce emissions, some plants are operated with fume condensation. The condensate and the slag dewatering water are circulated after cooling where fresh water is utilised. The reuse of water is not operated when sea water is utilised for slag granulation and fume condensation. With this technique, H₂S emissions within the range of 1 – 10 g per tonne of hot metal are achievable.

The water used in the granulation and the pelletising process can largely be collected and reused if fresh water is utilised. These systems can be operated so as to generate very small amounts of waste water. The steam generated during this process contains dust, SO₂ and H₂S, which is usually emitted to the atmosphere. Tests have been carried out to reuse the sensible heat of the slag, but no system is commercially available at the moment. The potential for energy recovery is approximately 0.35 GJ/t hot metal.

The production of lump slag from pits usually leads to larger emissions of SO₂ and H₂S, which can be more difficult to control. Conditioning with water can influence the emissions of H₂S.

6.2.2.2 Waste water

Waste water from BF gas treatment

Water from BF gas scrubbing is normally treated, cooled and recycled to the scrubber (see Figure 6.11). Treatment usually takes place in circular settling tanks.

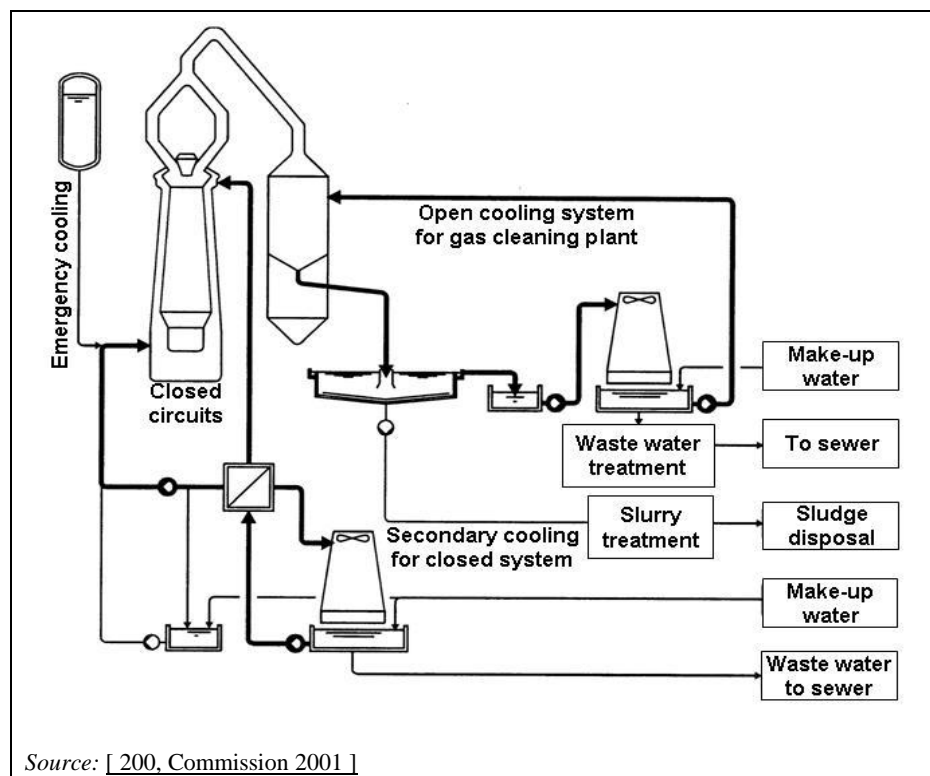

Figure 6.11: Schematic diagram of water management at a blast furnace

The overflow of the circuit is normally 0.1 – 3.5 m³/t hot metal depending on raw material quality/specification and water availability which influences the measures taken to optimise water recycling. Especially raw materials with a high salt content can require significantly higher volumes of wash water.

Table 6.11 shows some data about the composition of the waste water from BF gas scrubbing before treatment.

Table 6.11: Composition of waste water from BF gas scrubbing before treatment

Parameter	Concentration (mg/l)
CN ⁻	0.1 – 50
Cl	73.6 ⁽¹⁾
F	1.74 ⁽¹⁾
SO ₄ ²⁻	42 ⁽¹⁾
NH ₄ ⁺	2.0 – 200
S	0 – 5
Fe	6.77 ⁽¹⁾
Mn	0.48 ⁽¹⁾
Zn	0.1 – 29.36
Pb	0.01 – 5
Na	19.19 ⁽¹⁾
Phenols	0.1 – 5
⁽¹⁾ Average value. NB: Data from a study carried out in 1990 and 1992. Six blast furnaces (volume: 837 – 1680 m ³) producing between 280 – 400 kg slag/t hot metal. Average basicity: CaO/SiO ₂ 0.9 – 1.1. Alkali input: 1.4 – 4.8 kg/t hot metal. Source: [232, Brouhon et al. 1990] [233, Poos et al. 1993].	

Cyanide content is shown to increase during a burden descent in the blast furnace and during transitional periods (stopping, restarting) that are more frequent at the end of a production campaign. Under these conditions, higher values of cyanide in the scrubbing water can be found. It seems that the formation of cyanides in the blast furnace are related to the presence of alkali metals [232, Brouhon et al. 1990] [233, Poos et al. 1993].

Waste water from slag granulation

Overflow of water from slag granulation primarily depends on water availability and is in the range of 0.125 – 10 m³/t hot metal produced. Information on pollutant concentrations and emission factors for waste water from blast furnace slag granulation with fresh water is available in Table 6.12. The emission factors are based on a fresh water consumption of 7921113 m³ and a hot metal production of 2221686 t which results in a specific fresh water demand of 3.57 m³/t hot metal.

Table 6.12: Pollutant concentrations and emission factors for waste water from blast furnace slag granulation

Parameter	Unit	Average	Median	Range (min-max)	SD	Emission factor	Unit
Water demand						3.57	m ³ /t HM
Pb	µg/l	2.52	2.00	<2.00 – 6.40	1.10	7.13	mg/t HM
Cr	µg/l	2.41	2.00	<2.00 – 6.90	1.08	7.13	mg/t HM
Cu	µg/l	4.06	3.80	<2.00 – 9.50	2.05	13.55	mg/t HM
Zn	µg/l	20.92	20.00	<20.00 – 38.00	3.62	71.31	mg/t HM
Cd	µg/l	0.20	0.20	<0.20 – 0.23	0.01	0.71	mg/t HM
Ni	µg/l	3.74	3.15	<2.00 – 10.00	1.98	11.23	mg/t HM
Fe	mg/l	0.44	0.18	0.03 – 2.60	0.61	0.64	g/t HM
Cl	mg/l	262.96	264.00	140 – 402	57.60	941.26	g/t HM
AOX	µg/l	21.63	16.50	<10.0 – 66.0	13.18	58.83	g/t HM
Suspended solids	mg/l	27.11	5.90	0.6 – 145.0	42.68	21.04	g/t HM
DOC	mg/l	4.70	4.00	3.10 – 8.70	1.46	14.26	g/t HM
TOC	mg/l	5.51	5.00	3.10 – 11.3	2.06	17.83	g/t HM
COD	mg/l	22.17	22.50	14.00 – 27.00	4.22	80.22	g/t HM
HC	mg/l	0.15	0.10	<0.10 – 0.25	0.05	0.36	g/t HM

NB: — SS: Suspended solids.
— HC: Mineral oil hydrocarbons.
— SD: Standard deviation.
— The data are based on the median of 24 measurements (for COD on six measurements).
— Data from Stahlwerke, Bremen Germany, random sample measurements for the composition of waste water from slag granulation from March 2000 to November 2006.
— Figures in *italics* indicate that measurement values below the detection limit have been computed as the detection limit.

Source: [357, Germany 2007].

Blowdown from cooling water circuits

Blowdowns of the cooling water circuit take place (see Figure 6.11). Information on representative quantities and chemical composition is not available.

6.2.2.3 Process residues such as wastes and by-products**Dust from casting**

Between 0.6 and 5.1 kg of dust can be extracted from the cast house per tonne of hot metal (see Table 6.2). It is common practice to separate this dust in a bag filter so that it can easily be recycled for example to the sinter strand or back to the BF after cold briquetting (see Section 2.5.4.4.4) or where applicable using direct injection [344, Eurofer 2007].

Dust and sludge from BF gas treatment

BF gas is usually treated in two stages: coarse dusts separation, i.e. by dust-catchers or cyclones, followed by fine dust separation in a wet ESP or scrubber. This produces 3.5 – 18 kg of dry dust per tonne of hot metal and 2 – 22 kg of sludge/t hot metal (see Table 6.2).

Table 6.13 shows the typical composition of dry coarse dust. This dust mainly contains carbon and iron from coke and sinter abrasion respectively. This coarse dust is normally returned to the sinter strand. This is much more difficult for the sludge because its zinc content is 10 – 20 times higher and lead content is 20 – 30 times higher.

Table 6.13: Typical composition in (wt-%) of dry coarse dust from BF gas treatment

Parameter	Concentration (wt-%)	Parameter	Concentration (wt-%)
C	25 – 40	S	0.2 – 1.3
Fe	15 – 40	SiO ₂	4 – 8
Pb	0.02 – 0.07	P ₂ O ₅	0.04 – 0.26
Zn	0.1 – 0.5	CaO	2 – 8
Mn	0.1 – 0.5	MgO	0.3 – 2
Al ₂ O ₃	0.2 – 3.7	Na ₂ O	0.03 – 0.64
Ti	0.02 – 0.2	K ₂ O	0.24 – 0.96

Source: [64, IISI 1985] [95, Mertins 1986].

The zinc and lead compounds are mainly removed from BF gas in a wet treatment stage. Most of the particles associated with zinc and lead compounds or these heavy metals themselves have grain sizes of less than 25 µm and concentrate in this fraction of the sludge. This makes them amenable to separation from the ferrous and carbon-rich fraction, i.e. in a hydrocyclone [344, Eurofer 2007].

Table 6.14: Typical composition in (wt-%) of sludge from BF gas treatment

Parameter	Concentration (wt-%)	Parameter	Concentration (wt-%)
C	15 – 47	S	2.4 – 2.5
Fe	7 – 35	SiO ₂	3 – 9
Pb	0.8 – 2.0	P ₂ O ₅	0.1 – 0.44
Zn	1 – 10	CaO	3.5 – 18
Mn	0.12 – 0.14	MgO	3.5 – 17
Al ₂ O ₃	0.8 – 4.6	Na ₂ O	0.15 – 0.24
		K ₂ O	0.08 – 0.36

Source: [64, IISI 1985] [95, Mertins 1986].

Figure 6.12 shows the fate of dust and sludge from BF gas treatment without distinguishing them

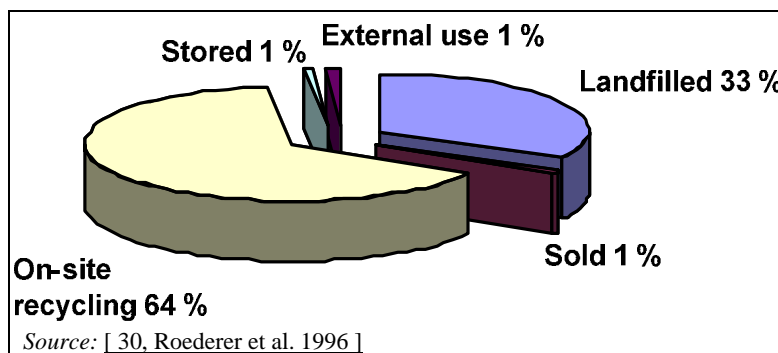

Figure 6.12: Fate of dust and sludge from BF gas treatment in the EU

Slag from blast furnaces

The specific quantity of slag mainly depends on the raw materials used, but generally lies in the range of 175 – 350 kg/t hot metal produced. The composition of different blast furnace slags is given in Table 6.15 [344, Eurofer 2007].

Table 6.15: Chemical composition in (wt-%) of blast furnace slag for basicity below and above 1.0 and other examples

Classification CaO/SiO ₂	>1.0 middle	<1.0 high	BF1	BF2	BF3
Fe _{total}	0.2 – 0.6	0.4			
FeO			0.49	0.24	0.80
Mn _{total}	0.2 – 0.7	0.3			
MnO			0.48	0.66	1.00
TiO ₂	0.5 – 2.7	0.7		0.77	
Al ₂ O ₃	9.0 – 14.0	9.2	13.09	12.63	10.90
S _{total} , mainly CaS	0.8 – 2.0	1.6		1.12	1.15
SiO ₂	33.2 – 37.0	38.4	32.88	36.78	36.90
CaO	38.1 – 41.7	35.6	33.76	36.64	35.80
MgO	7.0 – 11.0	18.0	15.96	11.19	10.70
Na ₂ O	0.3 – 0.6	0.5		0.35	0.35
K ₂ O	0.6 – 0.8	0.8		0.54	0.40
CaO/SiO ₂	1.1 – 1.2	0.9			
(CaO+MgO)/SiO ₂	1.3 – 1.5	1.2			
TiO ₂			2.05		

Source: [47, Geiseler 1992] [270, Reynard 2007] [385, Malmberg et al. 2005] [392, Schmidt et al. 2003] [394, Colletta et al. 2002].

The slag is used for various purposes (see Figure 6.13).

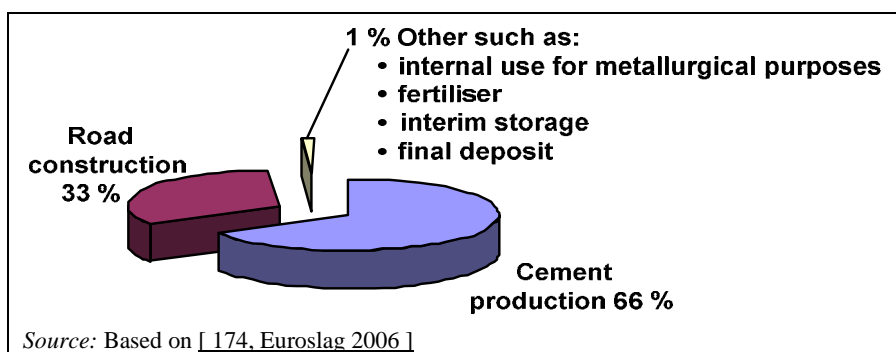

Figure 6.13: Final use of blast furnace slag in the EU

6.2.2.4 Energy and reductant demand

A major parameter for the consumption of energy is the use of reducing agents (e.g. coke, coal, oil), which also determines CO₂ emissions of the blast furnace process to a major extent. Input of reducing agents is influenced by several operating parameters, such as hot blast temperature, rates and quality of sinter and pellets, quality of coke (ash content, sulphur content, CSR value), input of alkaline, slag amount, ilmenite, Pb/Zn and Si. Thus, the average reducing agent demand for different countries within the European Community in 2002 show a wide range from 453 – 514 kg per tonne of hot metal, with an average reducing demand in the EU-15 of 486 kg per tonne of hot metal.

In a special BF-process, where iron which contains waste materials are processed via a sinter strand to produce foundry crude iron in a blast furnace, the consumption of reducing agents are considerably higher than in the usual blast furnace due to a higher input of the influencing factors mentioned above (see Section 2.5.4.4.2).

The blast furnace process is the most energy-consuming process and thus CO₂ emitting unit (in the form of reducing agents) in iron and steel production (see Figure 2.1 and Figure 2.2). Table 6.16 gives an example of the energy input/output of a blast furnace with high top pressure using coal injection and top gas pressure recovery in 1986 for electricity generation without considering the energy content of the hot metal.

Table 6.16: Example of energy input/output of a blast furnace with high top pressure using coal injection and top gas pressure recovery in 1986

Energy carrier		Specific energy value (GJ/t HM)
Input:	Coke	12.4
	Powdered coal	1.63
	Hot blast (from stoves)	4.52
	Electricity	0.12
	Total (gross)	18.67
Output:	Electricity	0.35
	BF gas	5.15
<i>Source: [65, InfoMil 1997].</i>		

Many plants with adequate top gas pressure (>1.5 bar gauge) and sufficient pressure drop are suitable for installation of expansion turbines for the recovery of top gas pressure energy. Process improvements have meant that the specific coal consumption in European steelworks has decreased considerably.

A trend towards direct reducing agent injection will probably further decrease specific coke consumption. Direct reducing agent injection in the blast furnace replaces the use of coke, thus saving energy in coke production. Most blast furnace installations inject reducing agents into the furnace at the tuyère level. This partially replaces coke in the top charge. This practice enables the operator to optimise the use of reducing agents. Other advantages are a lowered production of coke, thereby decreasing the specific coke oven emissions per tonne of steel produced. Many plants inject pulverised or granular coal or oil. Some blast furnace operators now inject coke oven gas or natural gas. Two companies have been injecting plastic waste into their furnaces to utilise the high hydrocarbon content for reduction processes for several years [145, UBA Comments 1997] and at least one new facility has been installed in the EU since 2001. Where appropriate, other injectants classified as eco-oils, reclaimed or waste oils, fats, tar, animal fats and emulsions have also received attention [344, Eurofer 2007].

6.2.2.5 Noise emissions

Noise emissions may be generated from blast furnace tuyères, particularly when they are not aligned [242, Caughlin 2007].

6.3 Techniques to consider in the determination of BAT

This section describes techniques (or combinations thereof), and associated monitoring, considered to have the potential for achieving a high level of environmental protection in the activities within the scope of this document.

It covers process-integrated techniques and end-of-pipe measures. Waste prevention and management, including waste minimisation and recycling procedures are also considered. Furthermore, techniques for reducing the consumption of raw materials, water and energy are covered.

Annex III to the Directive lists a number of criteria for determining BAT, and the information within this chapter will address these considerations. As far as possible, a standard structure as shown in Table 6.17 is used to outline the information gathered concerning each technique, to enable a comparison of techniques and the assessment against the definition of BAT given in the Directive.

This section does not necessarily provide an exhaustive list of techniques which could be applied in the sector and other techniques may exist or may be developed, which could be considered for the determination of BAT for an individual installation.

Table 6.17: Information breakdown for each technique described in this section

Type of information considered	Type of information included
Description	Brief technical description using, as appropriate, pictures, diagrams and flow sheets.
Achieved environmental benefits	Main potential environmental benefits to be gained through implementing the technique (including energy, water, raw material savings, as well as production yield increases, energy efficiency, etc.).
Cross-media effects	<p>Potential environmental side effects and disadvantages to other media due to implementing the technique, including details of the environmental effects of the technique in comparison with others (advantages and disadvantages supported by data if available) in order to assess the impact of the technique on the environment as a whole. This may include issues such as:</p> <ul style="list-style-type: none"> • consumption of raw materials and water • energy consumption and contribution to climate change • stratospheric ozone depletion potential • photochemical ozone creation potential • acidification resulting from emissions to air • particulate matter in ambient air (including microparticles and metals) • eutrophication of land and waters resulting from emissions to air or water • oxygen depletion potential in water • persistent/toxic/bioaccumulable components in water or to land (including metals) • creation or reduction of (waste) residues • ability to reuse or recycle (waste) residues • noise and/or odour • risk of accidents.
Operational data	Actual performance data (including reference conditions, monitoring periods and monitoring methods) on emission levels, consumption levels (raw materials, water, energy) and amounts of waste generated. Any other useful information on how to operate, maintain and control the technique.
Applicability	Indication of the type of plants or processes in which the technique may or cannot be applied as well as constraints to implementation in certain cases, considering, e.g. plant age (new or existing), factors involved in retrofitting (e.g. space availability), plant size (large or small), techniques already installed and type or quality of product.
Economics	Information on costs (investment and operating) and any possible savings (e.g. reduced raw material or energy consumption, waste charges) or revenues including details on how these have been calculated/estimated. Economic information relevant to new build and retrofit to existing installations will be included. This should allow for identifying, where possible, the overall economic impact of the technique.
Driving force for implementation	Specific local conditions, requirements (e.g. legislation, safety measures) or non-environmental triggers (e.g. increased yield, improved product quality) which have driven or stimulated the implementation of the technique to date.
Example plants	Reference to the plant(s) where the technique has been implemented and from which information has been collected and used in writing the section. Indication of the degree to which the technique is in use in Europe or worldwide.
Reference literature	Literature or other reference material (e.g. books, reports, studies, websites) that was used in writing the section and that contains more detailed information on the technique.

6.3.1 Cast house dedusting (tap holes, runners, skimmers, torpedo ladle charging points)

Description

Hot metal and slag are cast from the blast furnace and run through the runners to the ladle and the slag treatment unit respectively. During tapping/casting, the liquid metal comes into contact with atmospheric oxygen (O_2) when flowing along the runners. As a result of the high temperature of the iron (1300 – 1500 °C) it reacts with the oxygen to form iron oxides (e.g. Fe_2O_3), ‘brown fume’. Slag does not react with atmospheric oxygen because most of its components are already oxidised. However, alkaline oxides (e.g. Na_2O and K_2O) can vaporise out of the slag forming particulate emissions.

First measurements of flue-gas of the cast house dedusting indicate dust emissions when no abatement is applied in the range of 100 – 400 mg/Nm³ (single measurements).

Generally, two types of measures can be applied to reduce dust emissions from casting:

- covering the runners with movable lids
- dissipating oxygen from the tapped hot metal by means of covering the hot metal with nitrogen (N_2). In this way, the formation of iron oxides is prevented (see Section 6.3.2).

Achieved environmental benefits

During tapping, approximately 400 – 1500 g dust is generated per tonne of hot metal when no abatement measures are applied. Evacuation of air from above the runners essentially leads to greater dust generation, due to the increased availability of oxygen.

In cases where the runners are covered by lids and dust is evacuated and treated, the most important parameter is evacuation efficiency. Special attention should be paid to the covering of the runners. The runner covers should be tightly connected, aiming for a leak-free system. At the tap hole, efficient evacuation of the generated dust is difficult, due to the space required for operation of the tap hole drill and the mud gun and due to the presence of the bustle pipe, which serves the tuyères and circles the blast furnace at the height of the bosh. Usually, a very large flow is needed to efficiently evacuate the dust generated in the vicinity of the tap hole.

The main evacuation points in a cast house are:

- the tap hole
- the skimmer
- the tilted runner (charging the torpedo ladle).

The specific flow of evacuated gas (waste gas) is 1200 – 3300 Nm³/t hot metal. With an effective dust collection and abatement system (e.g. a bag filter), specific emission factors of less than 10 g/t hot metal can be achieved [65, InfoMil 1997]. The dust collection efficiency can exceed 99 % and the dust removal efficiency of bag filters can also exceed 99 % [65, InfoMil 1997].

At Voestalpine blast furnace A in Linz, Austria (hot metal production of about 3.5 Million t/yr), a cast house dedusting with a bag filter system treating 700000 m³/h has been installed. Dust emissions are measured continuously. Annual average emissions have been at 11.0 mg/Nm³ (2004), and 2.2 mg/Nm³ (2005) after relining the blast furnace and adapting the cast house dedusting emissions, which took place at the end of 2004. Recent daily average emission values are in the range of 3 – 10 mg/Nm³.

At Voestalpine, a cast house dedusting system with a bag filter treating 355000 m³/h was installed for blast furnaces 5 and 6 at the end of 2005. Dust emissions are measured continuously. Recent emission values based on daily average values are about 1 mg/Nm³ (see Section 2.5.5).

German installations achieve dust emissions applying bag filters of $0.3 - 1 \text{ mg/Nm}^3$ (annual average) and $0.38 - 0.49 \text{ mg/Nm}^3$ (daily average).

Table 6.18: Emission concentrations from the BF cast house and burden dedusting

Parameter	ESP	Bag filter
Dust	10.4	0.3 – 1 0.38 – 0.49 ⁽¹⁾
Hg		<0.0001
Hg, Tl		<0.0005
Cd, Tl	0.00004	<0.0018
As, Co, Ni, Se, Te	0.003	
As, Co, Ni		<0.003
Pb, Co, Ni, Se, Te		<0.5
Pb, Cr, Cu, Mn, V	0.014	
Pb, Cr, Mn		0.00434
Sb, Cr, CN, F, Cu, Mn, V, Sn		<1
⁽¹⁾ Daily average. NB: – Data from abatement of gases from the casting bay and burden dedusting. – Annual averages in mg/Nm^3 . Source: [244, Plickert 2007].		

Figure 6.14 shows achieved daily average emissions over three months in the cast house emissions from three blast furnaces.

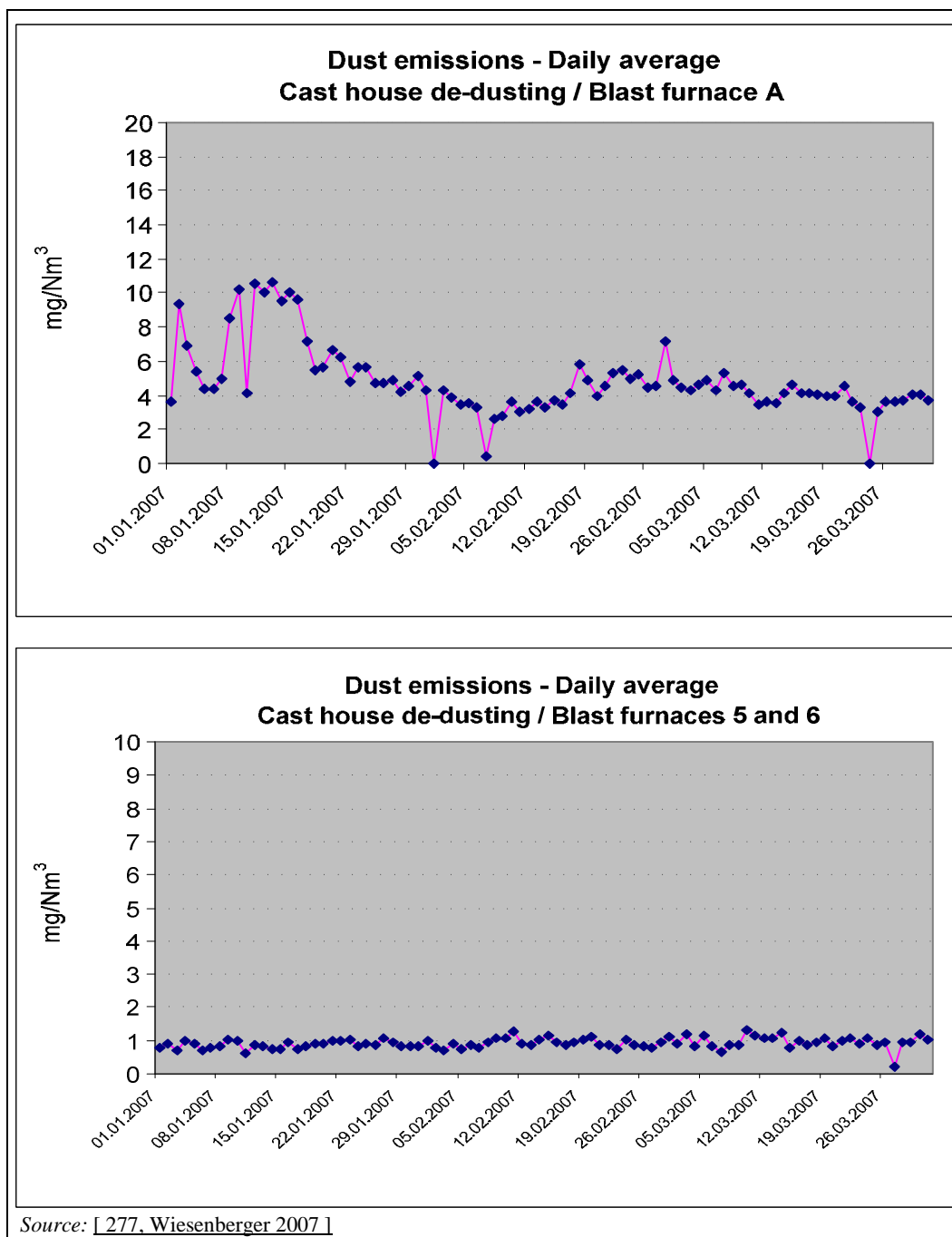

Figure 6.14: Daily average emission values of cast house dedusting systems at tap holes and runners of blast furnaces at Voestalpine, Linz, Austria

Cross-media effects

The application of evacuation and treatment of gases consumes additional energy as it requires powerful fans. From [65, InfoMil 1997], an energy consumption of approximately 0.007 GJ/t hot metal can be calculated, based on an annual hot metal production of 3 million tonnes by BF-7 at 8640 operational hours.

The collected dust has a high iron content and can be recycled to the sinter plant or back to the BF after cold briquetting (see Section 2.5.4.4.4) or where applicable using direct injection at the tuyère level [344, Eurofer 2007].

Operational data

The described technique is operated, in practice, without significant problems.

Applicability

The covering of runners and subsequent evacuation and cleaning can be applied at new and existing plants.

Economics

At Corus, IJmuiden, the Netherlands, investments for a bag filter system treating 690 000 Nm³/h were reported to be in the range of EUR 1 million – 2.3 million. This only includes the bag filter equipment. Runner covering and evacuation layout are not included in this figure.

Operational costs can be calculated as EUR 0.5 – 2.8/t hot metal, based on an annual production of 3 million tonnes hot metal per year in BF-7 and 8640 operational hours [65, InfoMil 1997].

Installation costs for the cast house dedusting system at blast furnace A of Voestalpine, Linz, Austria with a nominal production capacity of 3 million t/yr was approximately EUR 14.5 million. Operational costs (without energy) are about EUR 0.42 million per year.

For all examples the currencies were converted into ECU in 1996 and for the review into EUR.

At Corus, Scunthorpe, United Kingdom the installation cost for one cast house dedusting system at a blast furnace with a nominal production capacity of one million t per year was approximately EUR 4.0 million in 1997.

Driving force for implementation

No data submitted.

Example plants

Evacuation and treatment of gases:

Blast furnaces 7, Corus, IJmuiden, the Netherlands; blast furnaces 5, 6 and A, Voestalpine, Linz, Austria; blast furnace Thyssen Krupp Stahl AG, Duisburg-Schwelgern, Germany; ArcelorMittal, Dąbrowa Górnicza, Poland; SSAB, Sweden and Rivagroup, Taranto, Italy.

Reference literature

[65, InfoMil 1997] [353, Eurofer 2007] [241, Poland 2007] [244, Plickert 2007] [277, Wiesenberger 2007]

6.3.2 Fume suppression during hot metal charging

Description

Section 6.3.1 describes conventional dedusting systems of cast house emissions. These systems are rather complex and costly. New approaches prevent the molten iron from reacting with atmospheric oxygen to form ‘brown fume’ (fume suppression). In order to prevent the reaction, the whole transport route for the hot metal, from the tap hole via various distribution and transfer points to the torpedo ladle is enclosed by means of carefully designed screening structures. The space between the molten metal and the covers is kept as small as possible, and it is, if necessary, flooded with nitrogen (inert gas). In integrated steelworks, the nitrogen yielded in air separation for oxygen generation may be available for this purpose.

This new method eliminates the installation and operation of complex and expensive exhaust and filter systems which were necessary previously, and thus leads to considerable cost savings. The cost of recycling filter dust is also reduced. This method works particularly well when the volumes to be enclosed at both the tap hole and the torpedo charging point are relatively compact. Under these conditions, closed housings can be constructed of limited volume facilitating the application of this technique. However, it has been found necessary to use an exhaust system at the tap hole and when the charging point to the torpedo has a large volume, e.g. when using a tipping spout (as opposed to a swinging spout), then the efficiency of the

nitrogen suppression system is not sufficient and it is necessary to switch to the classical exhaust suction system. A common filter for the exhaust systems for both the tap hole and torpedo charge point can be used.

Figure 6.15 shows the dust generation characteristic with and without nitrogen inertisation during hot metal charging (to the torpedo level) depending on the flow of hot metal. These figures are about 100 times lower when nitrogen inertisation is used.

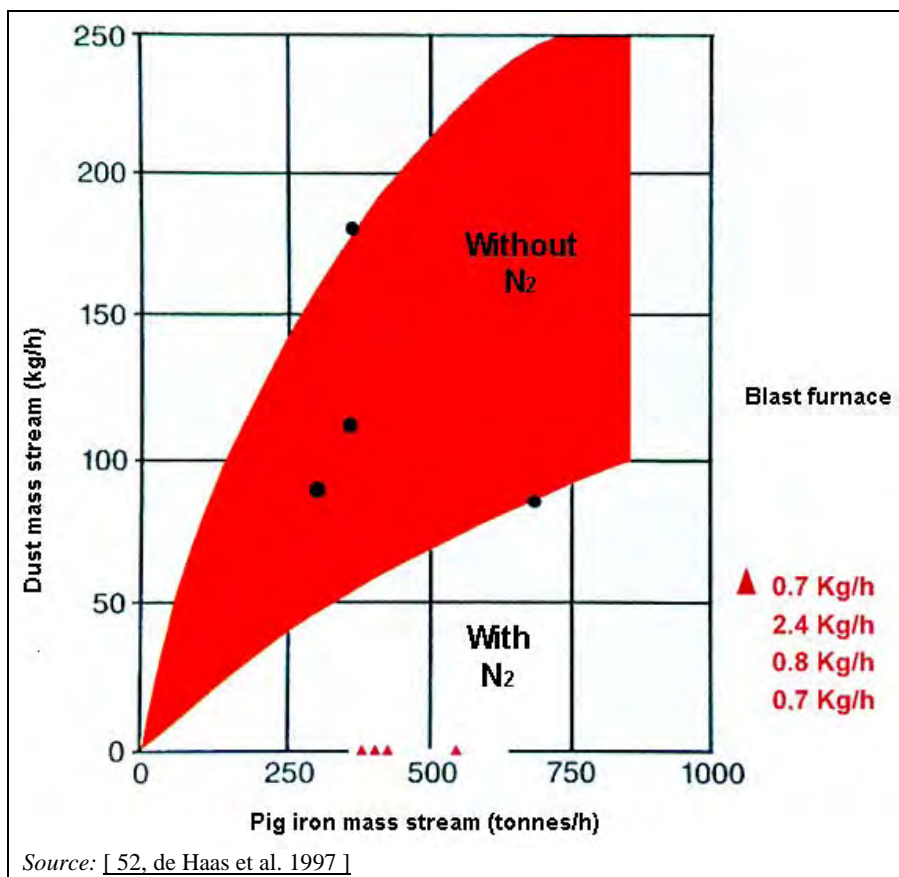

Figure 6.15: Dust generation with and without nitrogen inertisation during hot metal charging (to the torpedo level) depending on the flow of hot metal

Achieved environmental benefits

During conventional casting, 0.4 – 1.5 kg dust/t hot metal is generated (see Table 6.10). This quantity is reduced by dust suppression to about 0.012 kg dust/t hot metal [52, de Haas et al. 1997]. Figure 6.16 shows the charging of hot metal into the torpedo ladle with dust suppression with inert gas.



Figure 6.16: Charging of hot metal into torpedo ladle with dust suppression with inert gas

Cross-media effects

There are no significant cross-media effects if the system is compared to conventional dedusting systems. When using such large amounts of nitrogen, it should be ensured that the nitrogen does not accumulate within the cast house due to the danger of suffocation.

Operational data

Experience with fume suppression at ArcelorMittal, Bremen, Germany shows constant operational conditions without significant problems. However due to changes at the tap hole and the torpedo charging point within the recent BF relining a conventional exhaust suction system has been added to the fume suppression system.

Applicability

Applicable both at new and existing plants, although the efficiency of the system is restricted if the volumes to be suppressed are large.

Economics

A comparison of costs is shown in Figure 6.17. The new fume suppression technique is considerably cheaper. The installation at ArcelorMittal, Bremen, Germany with a production of 3 million tonnes hot metal/yr required an investment of EUR 6.8 million including dust suppression and tap hole dedusting with a subsequent bag filter.

For the example, the currencies were converted into ECU in 1996 and for the review into EUR.

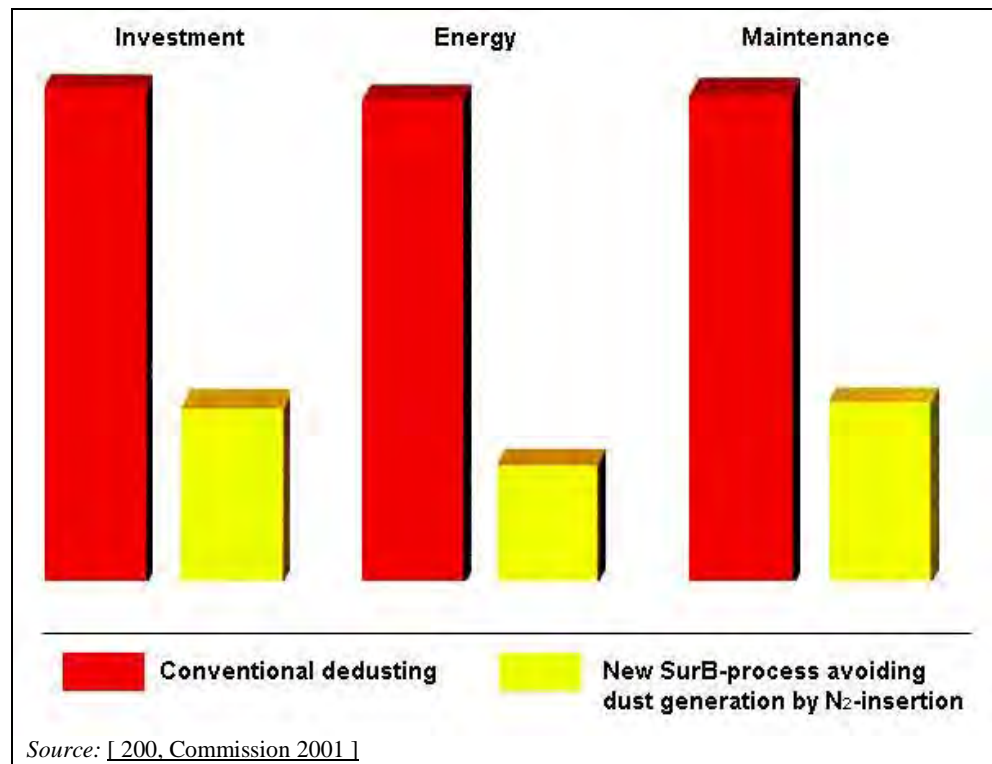

Figure 6.17: Comparison of investment, energy and maintenance costs for the fume suppression system at ArcelorMittal, Bremen Germany

Energy costs are about EUR 190 000/yr and maintenance costs about EUR 170 000/yr. This is also much lower than conventional systems. Nitrogen costs can, however, vary depending on local circumstances.

Driving force for implementation

No data submitted.

Example plants

At ArcelorMittal, Bremen, Germany, this fume suppression technique has been in operation since 1991.

Reference literature

[50, Grützmacher et al. 1991] [52, de Haas et al. 1997] [353, Eurofer 2007]

6.3.3 Use of tar-free runner linings

Description

The runner system in the cast house of a blast furnace is made of a refractory outer layer (e.g. concrete). The runners are lined with a heat-resistant material, which is based on alumina embedded in a carbon matrix. Coal tar pitch can serve as a binder.

The linings protect the outer layer against the heat of the liquid iron and (especially) the liquid slag. The linings are subject to wear and are renewed every few weeks. The quality of the carbon matrix is an important factor in the durability of runner linings. A weak matrix does not hold the alumina and causes the linings to wear more rapidly.

The required strength of the mixture is only achieved after heating for several hours with burners. Tar decomposition during heating gives rise to emissions of hydrocarbons (and PAH). A minor part of the emissions occur during the casting of slag and hot metal.

A new type of runner lining which does not contain tar has been developed and is being applied successfully. With the new runner lining, emissions of volatile organic compounds (VOC) and polycyclic aromatic hydrocarbons (PAH) are much lower. The new material has the same slag resistance and the durability can be even better than that of traditional runner linings.

Achieved environmental benefits

Table 6.19 shows figures for emissions reduction resulting from the use of tar-free runner linings. The figures shown are estimates based on a theoretical model.

Table 6.19: Emissions from tar free runner linings

Component	Traditional runner lining (g/t HM)	Tar-free runner lining (g/t HM)	Emission reduction
Volatile organic compounds(VOC)	100	1	99 %
Polycyclic aromatic hydrocarbons (PAH)	3.5	0.03	99 %

Source: [65, InfoMil 1997] [351, Eurofer 2007].

Cross-media effects

Application of this measure has a positive effect on the health of employees because they are less exposed to harmful components. No other cross-media effects are known.

Operational data

At Corus IJmuiden, the Netherlands the tar-free runner linings are currently applied without problems and have even led to improved runner lining durability.

Applicability

In principle, tar-free runner linings are applicable at both new and existing blast furnaces.

Economics

No data submitted.

Driving force for implementation

No data submitted.

Example plants

Many blast furnace operators in the EU use tar-free runners linings.

Reference literature

[65, InfoMil 1997]

6.3.4 Blast furnace gas treatment

Description

Blast furnace gas must be cleaned in order to meet grid gas requirements. When leaving the blast furnace, the BF gas (or 'top gas') contains dust, cyanides (HCN), ammonia (NH₃) and sulphur compounds (see Table 6.7 and Table 6.8).

Blast furnace gas is usually cleaned in three stages: preliminary coarse cleaning; cooling, which is part of the cleaning operation and fine cleaning.

The preliminary cleaning removes coarse particles, which facilitates the subsequent fine cleaning and allows the iron-bearing dust to be added back into the charge or to be recycled to the sinter plant (see Table 6.13).

The coarse cleaning is done using deflectors, dry cyclonage or dust catchers. The velocity of the gas decreases as it descends through the duct and the dust particles in the gas are deposited in the lower part of the dust catcher under the influence of gravity. The gas then leaves the dust catcher and travels through a pipe to the equipment that performs the fine cleaning.

In the second stage, dust – including zinc oxide (ZnO) and carbon (C), – cyanide and ammonia are removed by wet scrubbing. The scrubbers are specially designed hurdle type, venturi or annular gap scrubbers. In some cases, wet electrostatic precipitation is applied.

In modern plants, special attention is paid to the pressure drop of the gas cleaning system, because a high-pressure drop has a negative effect on the energy efficiency of the top gas pressure recovery turbine (see Section 6.3.13). The aim is therefore to construct gas cleaning systems with a low-pressure drop and a high gas cleaning efficiency.

Achieved environmental benefits

BF gas cleaning systems are usually highly efficient, achieving a residual dust concentration of 1 – 10 mg/Nm³. Dust not caught by the gas cleaning system is emitted or combusted at the site of combustion of the BF gas.

The pressure drop of the gas cleaning system depends on the type of equipment used. Reported pressure drops of two modern systems were between 0.07 and 0.14 bar. Pressure drops in older systems range from 0.15 – 0.5 bar.

Cross-media effects

It should be noted that the scrubbers generate a contaminated waste water flow. Gross water consumption of the blast furnace systems is 0.1 – 3.5 m³/t hot metal. Raw materials with a higher salt content can make greater flows necessary in order to clean the BF gas. The water flow generated contains suspended solids, e.g. carbon and heavy metals (Zn, Pb), cyanide compounds and ammonia. Usually, the waste water is treated by means of heavy metal precipitation and a solid waste (sludge) is generated.

This blast furnace sludge contains relatively high concentrations of zinc (Zn) and lead (Pb) (see Table 6.14). This hampers the recycling of the sludge into the production process. Zinc in particular is a ‘poison’ to the blast furnace. Therefore, some plants apply hydrocyclonage to separate the sludge flow into two flows; one with a low zinc content, which can be returned to the sinter plant, and a second with a high zinc content, which can be stored or disposed of (see Section 6.3.7).

Operational data

No data submitted.

Applicability

Blast furnaces around the world apply BF gas cleaning systems. At new plants, a modern system with a low-pressure drop and low water and energy consumption can be applied. Many old blast furnaces are equipped with ‘old-fashioned’ scrubbers. These scrubbers are able to achieve the grid gas requirements, but consume considerable amounts of water and energy and have a relatively large pressure drop. It is sometimes possible to replace the scrubber with a more modern one, but this should be considered in conjunction with the application of a top gas pressure turbine (see Section 6.3.13), which depends on the operating pressure of the furnace, amongst other factors.

Economics

No data submitted.

Driving force for implementation

No data submitted.

Example plants

BF gas treatment is widely applied at blast furnaces around the world.

Reference literature

[65, InfoMil 1997] [105, Pazdej et al. 1995] [241, Poland 2007] [244, Plickert 2007] [352, Eurofer 2007]

6.3.5 Gas recovery system for top hopper release**Description**

The blast furnace burden (coke and ferrous materials) enters the blast furnace at the top (see Section 6.1.2) via a sealed charging system that isolates the furnace gases from the atmosphere. It is necessary to use such a system because the pressure inside the blast furnace is in excess of atmospheric pressure (0.25 – 2.5 bar gauge). The charging system may be a double bell arrangement or, more common in modern blast furnace operations, a bell-less system (such as those supplied by Paul Wurth, see Figure 6.18).

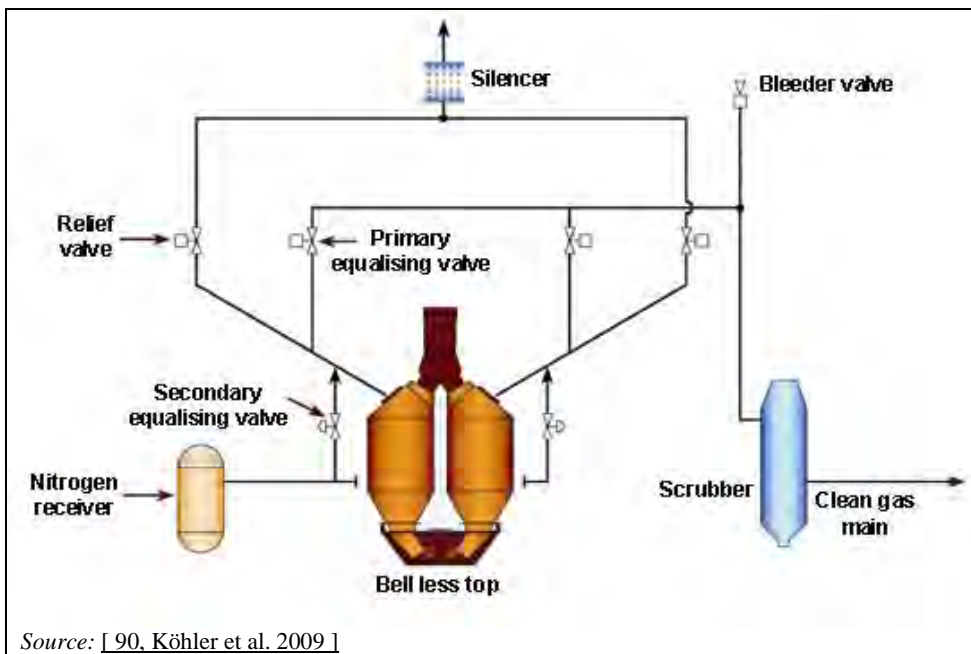

Figure 6.18: Diagram of a bell-less top with primary and secondary equalising and without a gas recovery system

Filling of the top hopper is done at atmospheric pressure. For charging the blast furnace, the pressure of the gas in the top hopper should be matched to the gas inside the blast furnace. There are various means to achieve this pressurisation; the most common is to use semi-clean blast furnace gas drawn from the blast furnace gas system after the removal of the coarse dust and to lead it into the bunker via the primary equalising valve. Minor pressure losses are equalised by means of a secondary valve with nitrogen.

In some installations, the top hoppers are purged and pressurised using nitrogen gas only.

Once the hopper has discharged its contents into the blast furnace, it is isolated from the furnace and the pressure is normally equilibrated with atmospheric pressure by discharging the gas via a silencer to the air. Depending on the size of the blast furnace, there is therefore a potential to release 40 to 80 m³ of dirty blast furnace gas per charge.

The discharge of blast furnace gas to the atmosphere during pressure equilibration of the top hopper(s) can be prevented by a gas recovery system in which the gases are redirected via the gas recovery valve into the clean gas main after the scrubber. An example is shown in the Figure 6.19.

An alternative system for blast furnaces operating at normal pressure is to pressurise the furnace top bunkers with a gas, e.g. nitrogen or steam, which at the time of writing (2010) is being installed at the blast furnaces 5 and 6 of Voestalpine Stahl GmbH, Linz, Austria. The achieved environmental benefits are nearly the same as with the gas-recovery system for top hopper release.

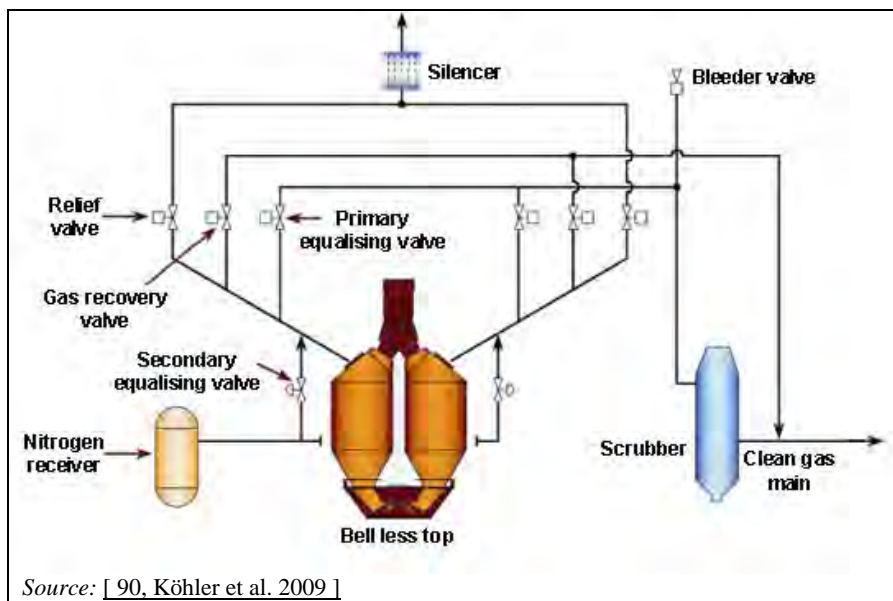

Figure 6.19: Diagram of a bell-less top with equalising, relief and a gas recovery system

Achieved environmental benefits

The reduction in the emissions of top gas (CO and H₂) and dust during charging is dependent upon factors such as the top hopper volume, the number of dumps per day and top gas pressure. The conditions for Voestalpine Stahl GmbH, Blast Furnace A, Linz, Austria are given in Table 6.20.

Table 6.20: Conditions for Blast Furnace A at Voestalpine Stahl GmbH, Linz, Austria

Parameter	Units	Value
Production	t/day	7500
Equivalent HM	t/charge	49.34
Charges	Number/day	152
Discharges	Number/day	304
Top hopper volume	m ³	55
Top pressure (absolute)	kPa	336
Top gas temperature	°K	373
Reference temperature	°K	273
Reference pressure	kPa	101
Furnace availability	Days per year	355
Top gas emission	Nm ³ /dump	134
	Nm ³ /day	40611
	Nm ³ /yr	14416757
CO in top gas	%	23.53
Emission of CO	Nm ³ /yr	3 392 263

There will be times when the blast furnace operations are suspended, e.g. for plant maintenance, when it is not possible to prevent some diffuse emissions from the blast furnace top. However, an application of this system at Blast furnace A at Voestalpine Stahl GmbH, Linz, Austria, has resulted in a reduction in the diffuse top gas emission of between 70 and 95 %.

Cross-media effects

There are no known cross-media effects.

Operational data

The data shown in Table 6.21 show the effect of the application of this system at Blast Furnace A at Voestalpine Stahl GmbH, Linz, Austria. The operating costs for this system are about EUR 0.01/t hot metal, including the costs of maintenance. Therefore, for this furnace, the costs are approximately EUR 26600 per year.

Table 6.21: Reduction in fugitive emissions with a gas recovery system for top hopper release at Voestalpine Stahl GmbH, Blast Furnace A, Linz, Austria

Components	Total reduction of emission	Specific reduction of emissions
BF dust total	6.19 t/yr	1.73 g/t HM
PM ₁₀ (50 %)	3.09 t/yr	0.86 g/t HM
CO	3262 t/yr	911 g/t HM
Pb	16.0 kg/yr	4.5 mg/t HM
Cr	1.09 kg/yr	0.30 mg/t HM
Hg	0.0105 kg/yr	0.0029 mg/t HM
Ni	0.22 kg/yr	0.06 mg/t HM
Cd	0.314 kg/yr	0.088 mg/t HM
V	1.36 kg/yr	0.38 mg/t HM
Zn	1.34 kg/yr	0.40 mg/t HM
HF	1.39 kg/yr	0.39 mg/t HM
HCl	0.026 t/yr	0.007 g/t HM

Applicability

Applicable for both new plants and existing plants provided the furnace has a bell-less charging system. It is not suited to plants where the gases other than blast furnace gas (e.g. nitrogen) are used to pressurise the furnace top bunkers. However, the capital investment will be minimised when a complete rebuild of the furnace top is made or when first installing a bell-less top.

Economics

The investment costs were EUR 1.2 million in 2004 for the Voestalpine Stahl GmbH, Linz, Austria blast furnace, with a production of 2.75 million tonnes hot metal/yr. Operating costs including the costs of maintenance are about EUR 0.01/t hot metal. In terms of dust releases over a ten year period, this investment prevents the release of 62 tonnes of dust. On the other hand, it may be possible to realise a return on the investment from the saving in the CO and H₂ release. These are thought to amount to approximately EUR 151000/yr.

Driving force for implementation

In principle the driving force to apply this technique is a reduction in fugitive dust emissions. There might also be energy savings associated with the utilisation of the recovered CO and H₂ in the blast furnace stoves, for example.

Example plants

The bell-less system with primary and secondary equalising systems and without gas recovery systems is applied in almost all Blast Furnaces in Europe. The only known example of the application of gas system recovery is at Blast Furnace A of Voestalpine Stahl GmbH, Linz, Austria.

Reference literature

[90, Köhler et al. 2009] [277, Wiesenberger 2007]

6.3.6 Treatment and reuse of scrubbing water

Description

BF gas is usually cleaned in specially designed hurdle type, venturi or annular gap scrubbers (see also Section 6.3.4). This generates a contaminated water flow which contains suspended solids (1 – 10 kg/t hot metal), heavy metals, cyanides and phenols. Measures can be taken to minimise discharges to water and to minimise water consumption.

To scrub the pollutants from the BF gas, approximately 0.3 – 4.0 l of water/Nm³ are needed. This figure corresponds to a gross water consumption of 0.4 – 8 m³/t hot metal. A large part of this water can be treated and recycled.

The treatment is usually performed in circular settling tanks. The sedimentation properties of the sludge are very often improved by dosage of flocculation agents (anionic polyelectrolytes, mixed polymers or activated silicic acids) or by sludge contact plants. Attention must be paid to pH value and water hardness.

The overflow of the sedimentation step is usually taken to a cooling device (e.g. a cooling tower) to adjust the water temperature and is then taken back to the scrubbing unit for further reuse. Fresh water is added after the cooling devices in order to avoid an enrichment of dissolved matter.

Operational data from seven German sludge contact plants for the treatment of scrubbing water can be seen in Table 6.22.

Table 6.22: Operational data from seven German sludge contact plants for the treatment of scrubbing water

Plant No	BF gas flow	Water flow	Content of suspended solids (mg/l)		Flocculation type	Agent dosage (mg/l)	Water content of the sludge (%)	Electricity Consumption (kWh/1000m ³)
	(10 ³ Nm ³ /h)	(m ³ /h)	before treatment	after treatment				
1	50	225 – 375	1000 – 3000	10 – 50	Activated silicic acid	5 – 10	60 – 85	40
2	250	1500	500	50	Mixed polymer	0.4	85 – 90	17.8
3	55	500	300 – 600	20	Activated silicic acid	6	75 – 85	–
4	550	50	100 – 300	20 – 30	Activated silicic acid	–	85 – 95	8
5	225	1100	260	10	Anionic polyelectrolyte	0.13	63	27.5
6	320	1400	430	13	Anionic polyelectrolyte	0.13	60	21.5
7	125	800	150	20	Mixed polymer	10	60	–

Source: [136, Theobald 1988].

Depending on the operational conditions of the blast furnace, cyanide treatment may be necessary, particularly during blowdown operations. Figure 6.20 shows a scheme of the process for the cyanide treatment of scrubbing water at blast furnaces, which is mainly performed by formaldehyde addition to the water circuit before sedimentation. The addition of formaldehyde

is continuously controlled by a controlling circuit (redox potential) attached to the water flow before the sedimentation unit. Long term experience indicates that:

- the optimum pH is between 8 – 9
- there is no reaction below pH 7
- glyconitrile is decomposed at above pH 12 into cyanide and formaldehyde.

In addition to the transformation of cyanide with formaldehyde to form glyconitrile, an oxidation of glyconitrile can be performed to lower the environmental impact.

At ArcelorMittal, Bremen the discharge water from the scrubbing water circuit is taken to a sedimentation unit for further treatment. The pH is adjusted with sodium hydroxide solution to pH 10.2 and a hydrogen peroxide solution (H₂O₂) is added to oxidise the glyconitrile to glycol acid. The high pH furthermore ensures an optimal separation of heavy metals in the discharged scrubbing circuit water before sending to the recipient.

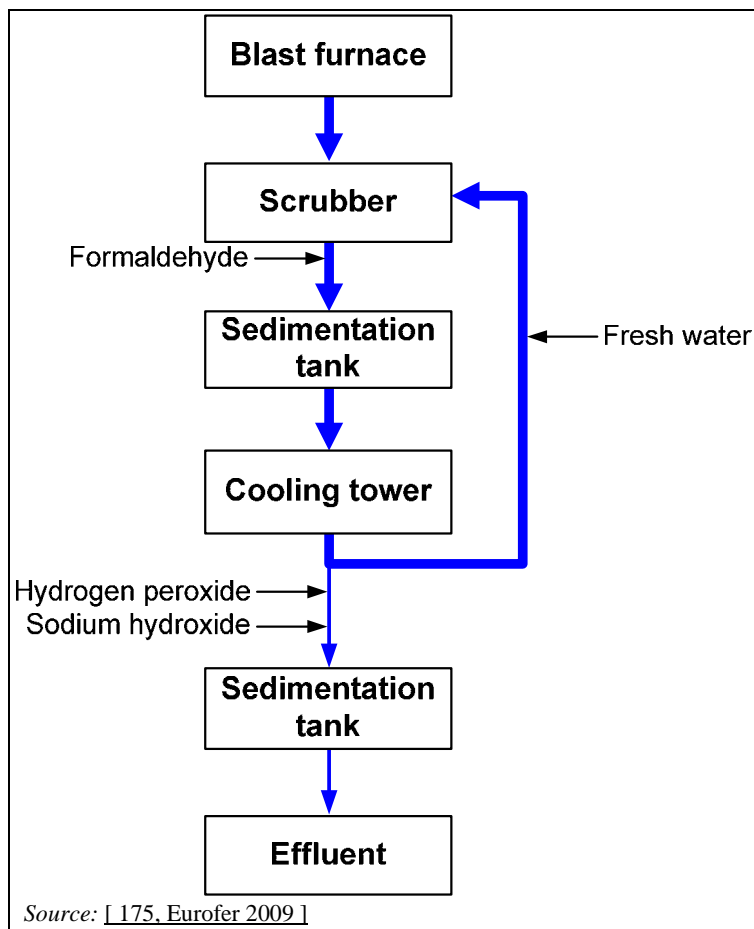

Figure 6.20: Example process for the cyanide treatment of scrubbing water at blast furnaces

The sludge from the fine particle precipitation has a relatively high zinc content (see Table 6.14) and can be treated by means of hydrocyclonage (see also Section 6.3.7).

A new concept of waste water treatment is used at Corus, IJmuiden, the Netherlands. It is called BIO 2000 and consists of the combined treatment of waste water from the coke oven plant, the blast furnaces and from the sinter plant in an activated sludge system with predenitrification and nitrification in order to minimise COD and nitrogen compounds emissions. This system is described in detail in Section 5.3.21.

Achieved environmental benefits

High recycling efficiency of the scrubbing water can be achieved with an overflow of only 0.1 m³/t hot metal. This water is removed from the system with the blast furnace sludge and may undergo further treatment.

The achieved discharge concentrations for BF gas scrubbing water for a waste water treatment plant are shown in Table 6.23. The total water demand in 2006 was 719713 m³. With a hot metal production of 3 152 134 tonnes, this equates to a specific waste water amount of 0.23 m³/t hot metal.

Table 6.23: Discharge concentration for waste water from the BF gas scrubbing water circuit after treatment at ArcelorMittal, Bremen, Germany

Parameter	Units	No of measurements	Mean value	Median	Max.	Min.	Standard deviation
Cd	µg/l	39	0.36	0.20	3.00	0.20	0.58
Cr	µg/l	39	2.20	2.00	3.90	2.00	0.47
Cu	µg/l	39	9.52	6.10	13.00	2.00	13.75
Fe	µg/l	39	460.77	90.00	3700.00	13.00	861.79
Ni	µg/l	39	12.93	8.90	39.00	2.00	10.10
Pb	µg/l	39	24.93	8.00	390.00	<2.00	62.08
Zn	µg/l	39	354.00	130.00	2600.00	20.00	582.73
CN	mg/l	39	0.84	0.22	9.80	0.01	2.05
CN, easily released	mg/l	39	0.25	0.04	5.50	0.01	0.89
Cl	mg/l	39	1000.21	854.00	1360.00	452.00	414.52
AOX	µg/l	39	37.33	19.00	450.00	10.00	70.13
Suspended solids	mg/l	39	21.91	9.60	166.00	0.60	31.79
DOC	mg/l	39	55.25	54.25	170.00	1.70	40.77
TOC	mg/l	39	55.66	45.00	174.00	2.20	42.06
COD	mg/l	28	144.12	145.50	280.00	<15	69.84
Mineral oil hydrocarbons	mg/l	39	0.16	0.18	0.56	0.10	0.08
Fish egg toxicity		12	6.58	4.00	32.00	1.00	8.16
NB: Random sample measurement data from April 2000 to November 2006. Figures in italics indicate that measurement values below the detection limit have been computed as the detection limit.							
<i>Source: [260, Germany 2007] [358, Germany 2007].</i>							

The composition of the BF gas scrubbing water and the achieved discharge concentrations for the aforementioned combined waste water treatment at Corus, IJmuiden, the Netherlands, are shown in Section 5.3.21 in Table 5.22 and Table 5.25.

Cross-media effects

When large amounts of water are recirculated, an efficient water treatment system must be used. Otherwise, operational problems will occur affecting the scrubbers (clogging, etc.) and scrubbing efficiency will drop. Water treatment and recycling generates a (zinc-rich) sludge. A small overflow from the circuit is necessary to prevent the accumulation of minerals/salts.

Scrubbing water recycling requires a significant amount of energy (see Table 6.22). In addition, the dosage of flocculation agents should be considered.

Applicability

Both new and existing plants can apply the treatment and recycling of scrubbing water. Modern plants have a significant advantage because the plant can be designed with an efficient water circuit. The salt content of the washwater influences the recycling rate. However, it is also possible to install an efficient water circuit in older plants.

Economics

No data submitted.

Driving force for implementation

No data submitted.

Example plants

ArcelorMittal, Bremen, Germany; Corus, IJmuiden, the Netherlands.

Reference literature

[65, InfoMil 1997] [136, Theobald 1988] [138, Theobald 1997] [260, Germany 2007] [358, Germany 2007] [379, Corus IJmuiden 2009]

6.3.7 Hydrocyclonage of blast furnace sludge

Description

Blast furnace top gas contains large amounts of dust (7 – 40 kg/t hot metal – see Table 6.7). A large part of this dust is removed in the dry first step of the BF gas treatment system. This part mainly consists of relatively coarse material with a high iron and carbon content and is recycled to the sinter plant.

The remainder (1 – 10 kg/t hot metal) is scrubbed from the BF gas by means of wet scrubbing. After precipitation 3 – 5 kg of sludge per tonne of hot metal is generated. This sludge has a relatively high zinc (Zn) content. The high zinc content presents an obstacle to reusing the sludge in the sinter plant.

By means of hydrocyclonage of the sludge, a zinc-rich and a zinc-poor sludge can be generated out of the total sludge. The zinc is mainly present in the form of zinc oxide (ZnO), which appears as very small particles. Hydrocyclonage concentrates these small particles in the overflow, whereas the zinc-poor fraction leaves the cyclones through the underflow. It should be noted that the efficiency of hydrocyclonage depends on the characteristics of the sludge.

The sludge from the underflow is reused in the sinter plant. Note that this reuse should be seen in relation to the total zinc input in the blast furnace. The zinc-rich sludge from the overflow is stored or landfilled. Some of the material has been successfully recovered for its zinc content e.g., by DK Recycling (see Section 2.5.4.4.2). Additional problems may arise from radioactive components which preferably remain in the fine fraction.

Achieved environmental benefits

In Table 6.24, the zinc contents of the hydrocyclonaged BF sludges are given

Table 6.24: Example for the zinc content of hydrocyclonaged blast furnace sludge

	Specific sludge generation (kg/t hot metal)	Zn content (%)	Weight on dry basis (%)	Treatment
Untreated sludge	1.0 – 9.7	0.1 – 2.5	100	Hydrocyclonage
Hydrocyclonage overflow	0.2 – 2.7	1 – 10	20 – 40	Stored on stock pile/landfill
Hydrocyclonage underflow	0.8 – 7.8	0.2 – 0.6	60 – 80	Recycled to sinter plant

Source: [65, InfoMil 1997] [105, Pazdej et al. 1995].

Cross-media effects

A small but unquantified amount of energy is consumed to operate the cyclones.

Operational data

The system operates without problems.

Applicability

Hydrocyclonage can be applied at new and existing plants as an end-of-pipe technology whenever wet dedusting is applied and where Zn content distribution in the different grain size allows a reasonable separation.

Economics

[116, Rentz et al. 1996] reports that the investment for a three-stage plant with a capacity of 20000 t/yr is EUR 2 million and operational costs are EUR 25/t.

For the example the currency was converted into ECU in 1994 and for the review into EUR.

Driving force for implementation

No data submitted.

Example plants

Corus, IJmuiden, the Netherlands; Thyssen Krupp Stahl AG, Duisburg, Germany.

Reference literature

[105, Pazdej et al. 1995] [116, Rentz et al. 1996]

6.3.8 Condensation of fume from slag processing

Description

As mentioned in Section 6.2.2.1 there are H₂S and SO₂ emissions from slag processing. This may lead to odour problems. In order to solve this problem, some granulation plants are operated with fume condensation (see Figure 6.21). The condensate and the slag dewatering water are also circulated after cooling if fresh water is utilised. The reuse of water is not operated when sea water is utilised for slag granulation and fume condensation.

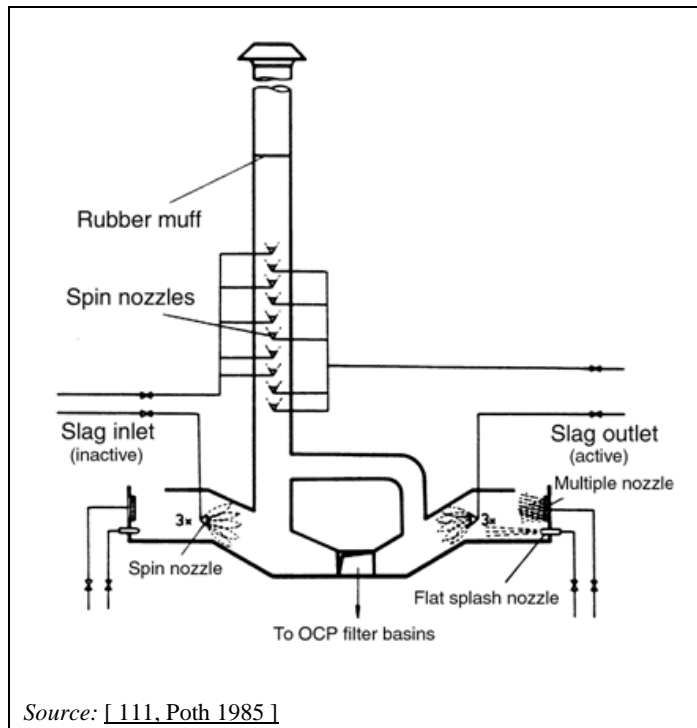

Figure 6.21: Granulation of blast furnace slag with fume condensation

Achieved environmental benefits

With fume condensation, H₂S emissions are within the range of 1 – 10 g H₂S per tonne of hot metal produced.

Cross-media effects

Cooling the circulated water requires considerable amounts of energy. Energy generation itself is very often linked with sulphur emissions. During fume condensation, the absolute quantity of reduced sulphur is relatively small and may be related to the quantity emitted during energy generation. In the design of these units, safety issues should be considered, especially concerning problems with hydrogen.

Operational data

No data submitted.

Applicability

Applicable both at new and existing plants.

Economics

No data submitted.

Driving force for implementation

No data submitted.

Example plants

Several slag granulation plants in Germany are equipped with a fume condensation system, e.g. at Thyssen AG, Duisburg, Germany, but also Corus plants at Port Talbot and Scunthorpe. Other plants that use this technique are located in Finland.

Reference literature

[208, Lindfors et al. 2006] [242, Caughlin 2007] [354, Eurofer 2007]

6.3.9 Use of high quality ores

Description

The idea of this technique is to use preferably sinter or pellets as raw material with a high iron content and low gangue content. Sinter with an iron content of 61 – 63.5 % and pellets with an iron content in the range of 66.6 – 66.8 % are used. Other important factors are moderate ash content of coke and low ash content of coal for injection.

Achieved environmental benefits

The use of high quality ores increases the productivity and the energy efficiency of the ironmaking process. The consumption of reducing agents is lower, which leads to reduced CO₂ emissions. A yield of 3.4 tonnes/m³/day and reduction of CO₂ emissions by 15 – 80 kg/t of hot metal can be achieved. Additionally, the slag volume is reduced to about 150 – 200 kg/t hot metal which also lowers the emissions from slag processing.

Cross-media effects

No data submitted.

Operational data

Using sinter and pellets very rich in iron as raw materials is, in principle, applicable to other plants, but it needs development and a fundamental understanding of the effects of different iron ores to the blast furnace, i.e. one effect associated with low slag practice can be the reduced life of blast furnace refractory.

Applicability

The applicability is strongly limited to the availability of ores with a high iron content.

Economics

The economic benefits are connected with increased productivity, reduced energy consumption and a decrease in the demand of reducing agents. The availability of iron-rich ores is limited. The introduction of this practice in European blast furnaces will lead to the building of monopolies for mines whose iron ore content is very high, against the principles of a free market and workable and fair competition. The generated stringency would cause worldwide higher prices for such qualities of iron ores.

Driving force for implementation

The improvement in productivity and energy efficiency are the driving forces for the implementation of this technique.

Example plants

Sinter – Ruuki in Finland

Pellets – SSAB, Oxelosund, Sweden

Pellets – SSAB, Lulea, Sweden

Reference literature

[208, Lindfors et al. 2006]

6.3.10 Increase of energy efficiency in blast furnaces

Description

Models can be used for controlling the wear in the blast furnace hearth. There are two separate models in use:

- a) A model, which estimates the location of the 1150 °C isotherm based on thermal conductivities and thermocouple measurements in the hearth refractory lining by using the Finite Element Method (FEM).
- b) A model, which approximates the height of the 'dead man' in the hearth according to the thermal conductivity.

Closed-loop operations of cooling water help to provide good furnace management.

- c) Smooth continuous operation at a steady state.

Achieved environmental benefits

An increase in the energy efficiency and a reduction of CO₂ emissions and a reduction in maintenance (e.g. refractories) can be achieved by the use of this technique. The consumption of reducing agents are reduced approximately by 5 kg/t hot metal on a long-term basis. This means a reduction of CO₂ emissions by approximately 15 – 20 kg/t hot metal. The BF campaign life can be prolonged by several years.

To c):

Achieving smooth continuous operation help to reduce the emissions and reduce the likelihood of burden slips.

Cross-media effects

No data submitted.

Operational data

High availability (e.g. >99 %).

The blast furnace is very well controlled.

The models are of significant importance for the control of the blast furnace process and for the wear in the BF hearth. Also the quality of the produced BF iron can be held at constant and desired level, e.g. with respect to C, Si- and S contents, when the process and the phenomena in the hearth can be controlled.

Applicability

Systems to increase the energy efficiency are usually applied in blast furnaces all over Europe.

Economics

No data submitted.

Driving force for implementation

Benefits are the improvement of process control which leads to energy savings and an improvement in iron quality.

Example plants

Ruukki, Finland.

SSAB, Lulea, Sweden.

Ovako, Koverhar, Finland.

UK plants.

Reference literature

[208, Lindfors et al. 2006] [220, Eurofer 2008] [242, Caughlin 2007]

6.3.11 Recovery and use of blast furnace gas

Description

A typical blast furnace produces approximately 1200 – 2000 Nm³ of BF gas per tonne of hot metal. The BF gas consists of 20 – 28 % carbon monoxide (CO) and 1 – 5 % hydrogen (see Table 6.7 and Table 6.8). The carbon monoxide is formed during the oxidation of carbon in the blast furnace. Much of the CO is further oxidised to CO₂ in the blast furnace. Carbon monoxide and hydrogen represent a potential energy source and measures are taken at all blast furnaces around the world to recover this energy.

Blast furnace top gas is therefore cleaned and buffered in gasholders for subsequent use as a fuel. Given the low energy content of BF gas per Nm³, it is often enriched with coke oven gas, BOF gas or natural gas prior to use as a fuel.

Achieved environmental benefits

The energy content of BF gas typically varies from 2.7 – 4.0 MJ/Nm³, depending on its carbon monoxide concentration. This is only 10 % of the energy content of natural gas. Nevertheless, the large amounts of BF gas generated mean that the energy recovering potential is very high. Total export from the blast furnace is approximately 5 GJ/t hot metal, which equals 30 % of the gross energy consumption of the blast furnace.

Cross-media effects

BF gas cleaning is unavoidable and results in waste water and solid residues.

Operational data

No data submitted.

Applicability

Applicable at all new and existing plants.

Economics

Significant economic benefits are achieved through energy savings.

Driving force for implementation

Benefits are gained from the efficient use of energy and economics.

Example plants

Applied at many new and existing blast furnaces in the world.

Reference literature

[200, Commission 2001]

6.3.12 Direct injection of reducing agents

General

Direct injection of reducing agents means replacing part of the coke with another hydrocarbon source, which is injected in the furnace at the tuyère level (see more information in Section 6.1.3.1). These hydrocarbons may be in the form of heavy oil, oil residues, recovered waste oil, granular or pulverised coal, natural gas or coke oven gas and waste plastics. Coal and oil are the most commonly used of the tuyère injectants. By reducing the need for coke, overall pollution and energy demand decrease.

It should be stressed, however, that a certain amount of coke is still necessary in the blast furnace to allow proper blast furnace operation. The coke provides the required carrying

capacity to sustain the blast furnace charge and ensures sufficient gas penetration. Tuyère injection of hydrocarbons requires an additional injection of oxygen (at increasing levels as tuyère injection rates increase), in order to achieve the required temperatures within the furnace raceway. Little experience has been gained at very high tuyère injection rates (and thus elevated oxygen levels), and here, safety also becomes a more important issue, among other things.

Figure 6.22, Table 6.25 and Table 6.26 show applied injection rates for reducing agents in existing blast furnaces.

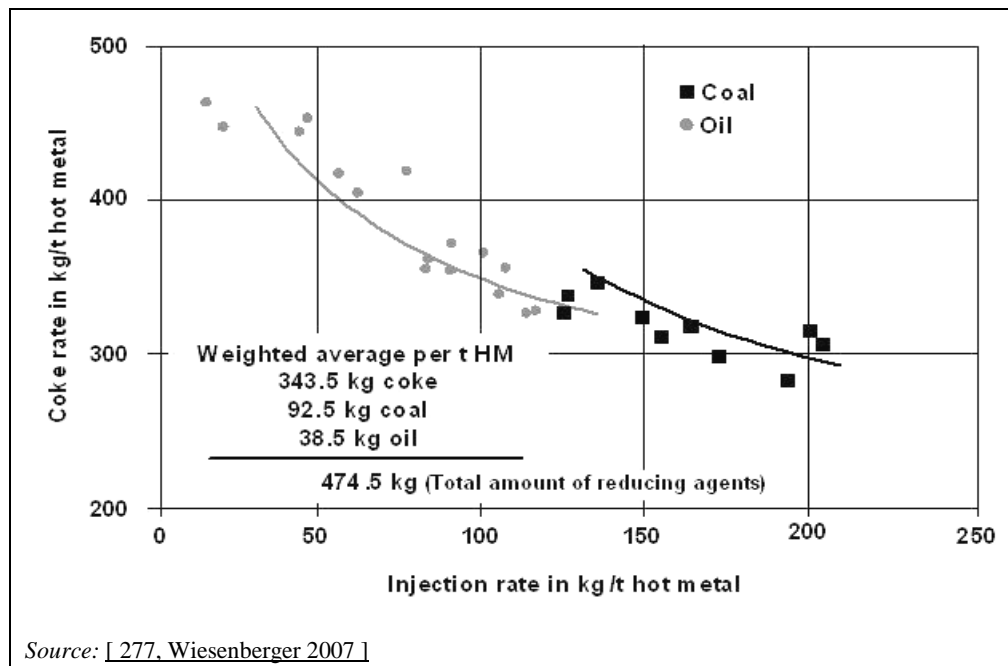

Figure 6.22: Coke rates and injection rates at 26 blast furnaces

NB: Data are from 1999 and correspond to members of the VDEh association.

Table 6.25: Comparison of residual coke consumption and total coal consumption at different levels of direct injection of pulverised coal

	Injection rate (kg/t HM)	Residual coke rate (kg/t HM)	Total coal consumption ⁽¹⁾ (kg/t HM)
None	0	500	625
Typical	150 – 180	310	538 – 568
Higher achieved	~240	270 – 300	577 – 615

⁽¹⁾ One kg of coke is assumed to be produced from 1.25 kg of coal.
 NB: Figures are related to dry coke and dry coal.
 Source: [248, Eurofer 2007] [276, Italy 2007] [348, Eurofer 2007].

Table 6.26: Applied reducing agents at different blast furnaces

Type of reducing agent	BF1	BF2	BF3	BF4	BF5	BF6	BF7	BF8	BF9	BF10 ⁽¹⁾
Coke	267	272	278	333	306	353	389	395	389	
Fine coke	50	78	89	61	22	56				
Coal	150	0	0	0	142	0	0	0	0	
Oil	0	106	78	61	0	50	43	43	49	130
Coke oven gas	0	0	0		0		46	43	0	
Others	0	0	0	28	0	22	0	0	19 ⁽²⁾	
Total	467	465	445	483	470	481	478	481	457	460 – 470

⁽¹⁾ BF running at 100 % with pellets. Working volume of BF: 600 m³; oxy-oil injection applied.
⁽²⁾ Tar.
 NB: Values in kg per tonne of HM.
 Source: [208, Lindfors et al. 2006] [277, Wiesenberger 2007].

The net energy savings of coal injection have been calculated at 3.76 GJ/t coal injected. At an injection rate of 180 kg/t hot metal, energy savings amount to 0.68 GJ/t hot metal or 3.6 % of the gross energy consumption of the blast furnace (see Table 6.16). These energy savings are achieved indirectly as a consequence of reduced coke consumption. Higher input rates will enable higher energy savings.

Direct injection of reducing agents is applicable both at new and existing blast furnaces. It should be noted that this highly process-integrated measure is closely related to the operation of the blast furnace itself, the resulting stability, and the hot metal and slag quality.

6.3.12.1 Coal injection

Description

Coke replacement through coal injection depends upon factors such as productivity, coke properties, desired hot metal quality, BF pressure, type (e.g. anthracite) and condition (humidity) of coal, etc. [11, Campell et al. 1992] [65, InfoMil 1997].

The injection of coal into a blast furnace at the tuyère level decreases the raceway temperature. The extent of the decrease in temperature is dependent upon the amount of coal injected, and this decrease in temperature can have a deleterious influence on blast furnace operation. In blast furnaces with conventional smelting reduction, the allowed coal injection is limited to 150 kg/t hot metal providing a stable furnace operation.

The theoretical maximum for coal injection at the tuyère level is thought to be 270 kg/t hot metal. This limit is set by the carrying capacity of the coke and the thermochemical conditions in the furnace. In order to maintain suitable raceway conditions and at the same time achieve higher input rates of coal of up to 260 kg/t hot metal, oxygen enrichment of the hot blast and oxy-coal injection at the tuyère level (see Section 6.1.3.1) are applied in EU blast furnace plants. At Corus, IJmuiden, the Netherlands, pulverised coal is injected on a commercial scale. A standard rate of 250 kg coal per tonne of hot metal is applied. Depending on the carbon content of the pulverised coal, between 210 and 260 kg of coal per tonne of hot metal were injected in 2006 (the data differs from Table 6.1 since the considered reference data there are for 2004).

Achieved environmental benefits

Direct injection of reducing agents decreases the need for coke production. Thus, emissions at the coke oven plant are prevented. For every kg of coal injected, approximately 0.85 – 0.95 kg of coke production is avoided.

The application of the oxy-coal injection has increased the injection rate by approximately 20 % and correspondingly has decreased the coke rate. The performance of the ESP used for the BF gas cleaning has improved. Together with the improved positive effect on the permeability in the blast furnace and the improved coal distribution, the whole blast furnace performance has improved.

Cross-media effects

Measurements have indicated that less than 1 % of the injected coal escapes through the blast furnace top.

Operational data

In the case of oxy-coal injection, the two blast furnaces have restrictions concerning hot blast temperature and oxygen enrichment of the hot blast. Therefore, oxy-coal injection is applied by a swirl type, coaxial, oxy-coal lance to improve the gasification of the coal. The oxy-coal lances have eliminated earlier experienced problems with lance clogging and thereby have improved the distribution of the coal between the tuyères of the blast furnaces.

At high coal injection rates, the furnace tends toward low wall working and an increase in blast furnace resistance. This indicates that careful control of the burden distribution with low coke rates and a delicate balance between wall and central gas flow are necessary.

In general, a fully prepared burden is necessary to be able to consistently achieve the highest levels of coal injection.

At constant blast furnace output levels, the introduction of high coal injection rates will result in an increase in the residence time of coke and burden in the blast furnace compared to an 'all coke' operation. As such, the coke and the ferrous burden materials will be subject to a longer time under the influence of halogenated alkali metal species in the blast furnace gas. However, the introduction of coal injection provides an opportunity to increase blast furnace productivity through co-injection of oxygen. Dependent upon the absolute levels of coal and oxygen injection and the gain in furnace productivity, the rate at which the coke transits the stack may be lower than under conditions of all coke operation.

The presence of ungasified coal char particles modifies the characteristics of the melted ferrous materials, thus affecting the position and the shape of the melting zone in the blast furnace.

Applicability

The method is applicable at all blast furnaces equipped with pulverised coal injection and oxygen enrichment. Direct injection of reducing agents is applicable both at new and existing blast furnaces.

Economics

There are economic incentives for using high rates of coal injection to achieve greater cost savings, particularly at plants which might otherwise face capital expenditure on rebuilding coke ovens or may have to purchase coke. Furthermore, coal injection can allow the use of coals of a lower quality compared to coking coals. This may also reduce costs.

Costs at EUR 10/GJ in 1988 are reported [65, InfoMil 1997]. However, [11, Campell et al. 1992] indicate that costs are saved, due to the lower coke consumption. The capital cost of installing coal injection at Corus, UK, Port Talbot No 4 Blast Furnace in 1997 was approximately EUR 24 million (including some redundant parts from another site). For the examples, the currency was converted into ECU in 1996 or 1997 and for the review into EUR.

Additional costs will arise for air enrichment providing consistently large amounts of oxygen, the additional demand on the pulverisers in existing plants and additional requirements for the injection unit maintenance.

Driving force for implementation

Cost savings, increased productivity and reduced CO₂ emissions and environmental benefits as a result of improved BF operation are the driving forces for the implementation of this technique.

Example plants

Coal or oil injection into blast furnaces is a technique now widely applied in Europe and worldwide (e.g. coal injection into blast furnaces in plants from ArcelorMittal, Corus; Corus, IJmuiden, the Netherlands; Rivagroup, Taranto Italy; Thyssen Krupp Stahl AG, Duisburg, Germany).

Oxy-coal injection has been used in SSAB Oxelösund AB in Sweden since 1993.

Reference literature

[140, Eurofer 2009] [208, Lindfors et al. 2006] [348, Eurofer 2007]

6.3.12.2 Oxy-oil injection**Description**

The injection of oils or other liquid hydrocarbons reduces the raceway temperature as is the case for coal injection. For blast furnaces with conventional smelting reduction, the injection of oil is restricted to about 65 kg/t hot metal before the reduction in raceway temperature causes a significant loss in furnace stability. In order to maintain suitable raceway conditions and at the same time achieve higher input rates of oil, up to 130 kg/t hot metal oxy-oil injection is applied. In this case, oxy-oil lances are installed at all tuyères designed for the use of heavy oil only. Oil and oxygen are fed separately and the oil must be preheated up to 220 °C. The amount of oxygen enrichment is 7 – 9 %.

Information about other options like increasing the blast temperature using electrically-powered plasma blast superheating or using oxygen enrichment of the hot blast has not been submitted.

Achieved environmental benefits

With oxy-oil technology, the amount of oil injected doubles. Coke consumption can be decreased and the CO₂ emissions can be decreased as well. The oil consists of carbon and hydrogen and compensates coke with a ratio of 1:1.2 (1 kg oil also compensates 1.2 kg coke). With the help of the oxy-oil equipment, the oil amount is doubled to a level of 130 kg/t hot metal. The savings of coke is thus about 15 kg/t hot metal and the reduction in CO₂ emissions is roughly 50 kg/t hot metal. The environmental benefits and energy efficiency gained are thus significant.

Cross-media effects

No data submitted.

Operational data

In practice, oxy-oil injection is working very reliably.

Applicability

The equipment for the feeding of oil and oxygen is highly available. The practice of applying oxy-oil injection is considered to be well established. Direct injection of reducing agents is applicable both at new and existing blast furnaces.

Economics

The use of oil injection results in cost savings by increased productivity. Additional costs will arise for air enrichment to provide consistently large oxygen amounts and additional requirements for the injection unit maintenance.

Driving force for implementation

Cost savings, increased productivity and reduced CO₂ emissions are the driving forces for implementation which are both economic and environmental as a result of an improved BF operation.

Example plants

Oxy-oil technology has been used at Ovako, Kovehar, Finland since 2000.

Reference literature

[208, Lindfors et al. 2006]

6.3.12.3 Gas injection

Description

Since 2002, Voestalpine Stahl GmbH, Linz, Austria has operated their small blast furnaces 5 and 6 with a simultaneous injection of reduction gas and heavy fuel oil as standard operational procedure with a replacement of 70 % of the heavy fuel oil by COG. In 2004, these furnaces averaged an oil injection rate of 45.5 kg/t hot metal and a COG rate of 46.9 kg/t hot metal with a total equivalent coke rate of 477.8 kg/t hot metal. The Eta-CO was 43.5 with about 8 % H₂ in the BF gas.

The maximum level for COG injection at the tuyère level is thought to be 100 kg/t hot metal. This limit is set by the thermochemical conditions in the furnace. The COG contains residual H₂S and organic sulphur compounds. The real input of COG is much lower (see Table 6.1). The concentration level of these sulphur compounds depends on the level of sulphur in the coals and/or the desulphurisation efficiency of the plant. The use of COG in the BF process as a reductant instead of using it as a fuel elsewhere in the works could result in a reduction in the sulphur emissions from the works since a proportion of the sulphur will be captured in the BF slag.

An example of the layout for COG injection is shown in Figure 6.23.

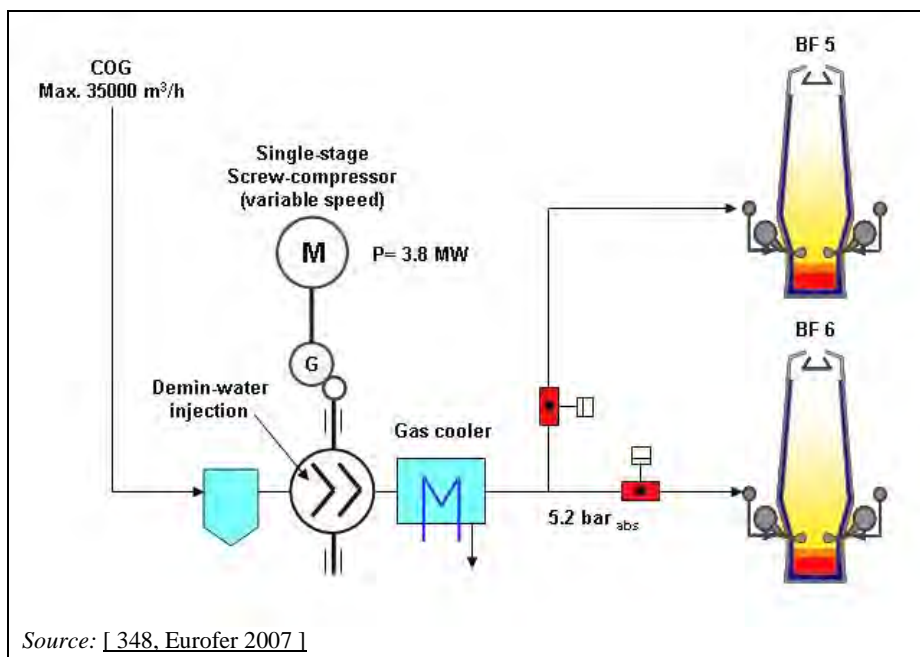

Figure 6.23: Example of the layout for COG injection**Achieved environmental benefits**

No data submitted.

Cross-media effects

No data submitted.

Operational data

The replacement ratio for COG is about 1 kg of gas for 0.98 kg coke or 0.81 kg of heavy oil. Additionally, the replacement of a carbon-rich reductant like coke and heavy oil in the BF process by a carbon-lean reductant like COG leads to an absolute reduction of the CO₂ emissions from the BF process. When COG is used at the blast furnace, it is necessary to substitute this gas that is normally used in reheat furnaces, etc. with BF gas, BOF gas or natural gas. A consequential reduction of SO₂ emissions of between 70 and 90 % may then result at these former COG consumers.

A reduction of the hot metal sulphur content may also be possible because COG has a lower sulphur input than heavy oil or coke. The consumption of desulphurisation agents (e.g. lime, CaC₂, Mg) at the pretreatment desulphurisation process of the hot metal can then be reduced. A compressor unit is required for COG injection resulting in an additional energy consumption of about 204 kWh/t COG (based on consumption at a reference plant in 2005).

Applicability

Whilst tuyère injection of COG is also applicable both at new and existing blast furnaces, it is also highly dependent upon the availability of the gas that may be effectively used elsewhere in the integrated steelworks. Direct injection of reducing agents is applicable both at new and existing blast furnaces.

Economics

No data submitted.

Driving force for implementation

The main driving forces are both economic and environmental benefits as a result of improved BF operation.

The investment at Voestalpine Stahl GmbH for the gas injection plant was about EUR 10 million for a production of about 5000 tonnes hot metal per day. The total specific operational costs are: EUR 1.3/t hot metal or EUR 12/1000 m³ COG (EUR 2 400 000/year and 200 million m³ COG/year).

Example plants

COG injection into blast furnaces is a technique applied in Europe at Voestalpine Stahl GmbH, Linz, Austria.

Reference literature

[348, Eurofer 2007]

6.3.12.4 Plastic injection**Description**

The maximum level for plastics injection at the tuyère level is thought to be 70 kg/t hot metal. This limit is set by the thermochemical and kinetic conditions in the raceway. Plastics can contain Cl and heavy metals like Hg, Cd, Pb and Zn. The concentration level of these elements in the plastics influences the composition of the gaseous and particulate bound compounds in

the BF gas and the dust separation behaviour in the BF gas cleaning system. As a result of this, plastic should meet certain input criteria for these elements. A small modification of the scrubber parameters allows these concentration levels in the BF gas to be kept comparable to the standard conditions of operation when plastics are not injected.

Achieved environmental benefits

In the BF the plastics substitute a part of the reducing agents such as coke and thus the emissions associated with coke production are prevented.

Cross-media effects

The ratio for plastics is dependant upon the relative amounts of carbon and hydrogen that can be derived from the plastic injected. A kilogram of plastic can replace about 0.75 kg of coke. A reduction of the hot metal sulphur content is possible because plastics have a lower sulphur input than heavy oil or coke. The consumption of desulphurisation agents (e.g. lime, CaC₂, Mg) at the pretreatment desulphurisation process of the hot metal can be reduced.

Depending on the composition of the wastes used (e.g. shredder light fraction), the amount of Cr, Cu, Ni and Mo in the BF gas may increase.

Operational data

Voestalpine Stahl GmbH, Linz, Austria received final permission for the injection of 220000 tonnes of plastics per year in 2005 and is increasing the capacity up to a level of 70 kg/t hot metal. In 2008 the plastic injection rate was 18 – 25 kg using high-pressurised air. The plastic should meet certain composition requirements. Table 6.27 provides requirements on the plastics used for injection at Voestalpine.

Table 6.27: Requirements for the composition of plastics used for injection into the blast furnace at Voestalpine Stahl GmbH, Linz, Austria

Parameter	Concentration (wt-%)		Parameter	Concentration (wt-%)
Cl	<2 %		Pb	250
S	<0.5 %		Ni	500
Co	1000		Hg	0.5
Cr	500		Cd	9
As	5		Zn	1000

NB: Figures are all in mg/kg dry plastic.
Source: [211, Remus, Rainer 2008].

The plastics injection plants in ArcelorMittal, Bremen and ArcelorMittal, Eisenhüttenstadt, both located in Germany, have been in operation for several years. In 2004, the No 3 furnace at Bremen averaged 52.3 kg/t hot metal while the No 1 furnace at Eisenhüttenstadt averaged 67.4 kg/t hot metal plastic injection. At the time of writing (2010), both have stopped the injection of plastics for economic reasons.

Applicability

Direct injection of reducing agents is applicable both at new and existing blast furnaces. It should be noted that this technique is highly dependent on the local circumstances and market conditions.

Economics

The investment for the plastics injection plant at Voestalpine Stahl GmbH, Linz, Austria was about EUR 20 million for an injection capacity of up to 220 000 tonnes per year. Additional costs will arise for the injection unit maintenance.

Driving force for implementation

For some types of wastes, it is no longer possible to landfill due to the restriction put on the content of hydrocarbons. Therefore, other routes should be found to treat this material.

Example plants

Plastics injection into blast furnaces is a technique applied in Europe at Voestalpine Stahl GmbH, Linz, Austria. It has been reported that four blast furnaces have experience to treat shredder light fraction (~200 kt/yr).

Salzgitter Flachstahl GmbH, Salzgitter, Germany started its plastics injection in March 2008.

Reference literature

[11, Campell et al. 1992] [65, InfoMil 1997] [132, Steeghs et al. 1994] [211, Remus, Rainer 2008] [221, Thomas et al. 2002] [222, Janhsen et al. 2002] [238, Janke et al. 1997] [276, Italy 2007] [277, Wiesenberger 2007] [348, Eurofer 2007] [390, Atkinson et al. 2004]

6.3.12.5 Direct injection of used oils, fats and emulsions as reducing agents and of solid iron residues

Description

Used oils, fats and emulsions of used oil and water are generated throughout the industry. These residues can be injected into the blast furnace at the tuyère level as a partial substitute for coke and coal. A simplified diagram of the scheme for direct injection of liquid reverts to the blast furnace is given in Figure 6.24. Alternative techniques are chemical or thermal splitting.

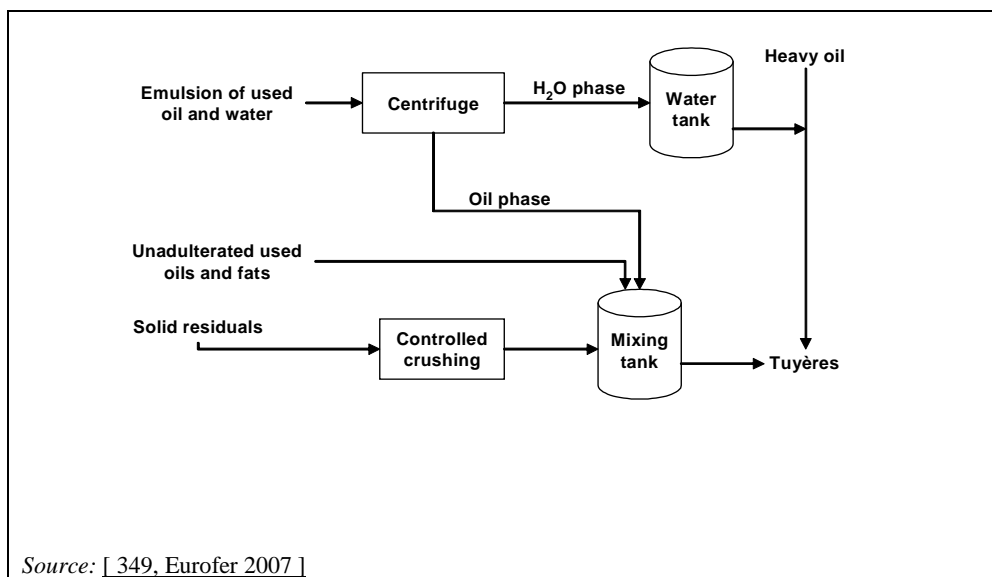

Figure 6.24: Simplified diagram of the scheme for direct injection of liquid reverts to the blast furnace

The crucial point of this procedure is the separation of water, oil and dust in the emulsions to ensure that the injection of water into the blast furnace is tightly controlled. Disc stack centrifuges are used to carry out this operation.

An integral part of this process is to add the water separated in the centrifuge operation to the heavy oil injected to the blast furnace. The level of this water addition can be used to control the raceway adiabatic flame temperature (RAFT) i.e., increasing the level of water addition decreases the RAFT. One advantage of using these revert materials is dependent upon a desire to adjust the flame temperature in the specific furnace operation.

Oily mill scale residues consist of solid material with a high iron content contaminated with up to 20 % hydrocarbons. The first step in the use of this type of material is often the separation of the oil (degreasing) from the iron-rich solids. In this system, oily mill scale and similar residues are reduced in size (for example by crushing) and mixed with the used oils and the oil phase separated from the emulsion in the centrifuge. The suspension produced is injected into the tuyères with discrete lances. The hydrocarbons act as reducing agents, the iron oxides are reduced to iron and report with the molten steel particles to the hot metal.

The injection of material (e.g. oily mill scale) at the tuyère level showed that dioxin and PAH emissions remained well within accepted limits in both cases, confirming the ability to achieve a complete reaction of the oil within the blast furnace raceway.

Achieved environmental benefits

The rate of exchange between the separated oil phase and heavy oil is slightly lower than 1 because a total separation of water from the oil phase is not achievable.

The reduction of the coke rate at the blast furnace can be between 3 and 8.5 kg/t hot metal, depending on the amount of injected residues. The direct injection of mill scale at the blast furnace gives a one-to-one substitution of iron ores.

Table 6.28: Injection rates and substitution factors for different materials injected into the tuyères

Material	Injection rate (kg/t hot metal)	Substitution factor
Used oils and fats	4 – 12	0.9
Heavy oil	3.5 – 78	0.8
Coke (theoretical)	3 – 8.5	0.8
Iron residues/iron ores		1
<i>Source: [211, Remus, Rainer 2008] [349, Eurofer 2007].</i>		

Cross-media effects

Extensive investigations did not reveal any detrimental cross-media effects. The consumption of heavy oil can be substituted by a similar amount of separated oil phase. The consumption of coke can be reduced by about 3 to 8.5 kg/t hot metal and thus emissions associated with the production of this amount of coke are prevented.

Operational data

No data submitted.

Applicability

Direct injection of residues can be applied to new and existing blast furnaces. It should be noted that the continuous operation of this system is reliant on the logistical concept of delivery and the storage of residues. Also, the conveying technology applied is of particular importance for a successful operation.

Economics

The profitability of residues injection is achieved by substituting coke and iron ores and by reducing disposal costs. The capital costs of installing the direct injection of residues is about EUR 4 million – 6 million. The maximum capacity of the Voestalpine Stahl GmbH, Linz, Austria installation is 12 kg residues/t hot metal or 15000 t residues/yr for a blast furnace with a production of about 2500 tonnes of hot metal per day.

Driving force for implementation

No data submitted.

Example plants

Direct injection of production residues as described is installed at blast furnaces 5 and 6 of Voestalpine Stahl GmbH, Linz, Austria.

Reference literature

[349, Eurofer 2007]

6.3.13 Energy recovery from top gas pressure**Description**

High top pressure blast furnaces provide an ideal opportunity for recovering energy from the large volumes of pressurised top gas which they generate. Energy is recovered by means of an expansion turbine which is installed after the top gas cleaning device.

Achieved environmental benefits

The amount of energy that can be recovered from the top gas pressure depends on the top gas volume, the pressure gradient and the admission temperature. Energy recovery in this way is viable when the BF gas cleaning device and distribution network has a low-pressure drop.

Top gas pressure in modern blast furnaces is approximately 0.25 – 2.5 bar gauge. The pressure of the BF gas collecting main is approximately 0.05 – 0.1 bar. Part of the top gas pressure is ‘consumed’ by the gas cleaning device.

The electricity generated is reported to be as much as 15 MW in a modern blast furnace with a top gas pressure of 2 – 2.5 bar.

Energy savings are estimated at up to 0.4 GJ/t hot metal for a 15 MW turbine. The savings amount to 2 % of the gross blast furnace energy demand. Application of top gas pressure recovery at blast furnaces is common in furnaces with high top pressure.

Cross-media effects

No cross-media effects are known.

Operational data

The technique of recovering energy from top gas pressure usually operates automatically without problems. Axial turbines can be used which are more efficient than radial turbines. The critical point is when the turbine should be shut down and the pressure gradient is transferred to the gas cleaning device. Special safety measures are always taken to avoid damaging to the gas cleaning device and/or the collecting main.

It should be noted that the use of turbines requires a thorough cleaning of the BF gas. First of all a high content of alkalis causes technical problems (corrosion).

Applicability

Top gas pressure recovery can be applied at new plants and in some circumstances at existing plants, albeit with more difficulties and additional costs. Fundamental to the application of this technique is an adequate top pressure that must be in excess of 1.5 bar gauge.

At new plants, the top gas turbine and the BF gas cleaning facility can be adapted to each other in order to achieve a high efficiency of both scrubbing and energy recovery.

Economics

Profitability of the turbine increases with increasing volume and pressure gradient of the top gas and with increasing energy costs. In a modern blast furnace, a payback period of less than three years is possible, but dependent on local circumstances and top gas pressure, this can be more than 10 years.

Driving force for implementation

The main driving force for installing a top gas pressure recovery turbine is the economic benefit.

Example plants

Top gas pressure recovery is applied worldwide at modern blast furnaces with a high top gas pressure and volume.

Reference literature

[1, Arimitsu 1995] [42, EC 2003] [65, InfoMil 1997] [66, Joksch 1995] [350, Eurofer 2007]

6.3.14 Energy savings at the hot stoves

Description

The hot stoves are fired with BF gas (often enriched). Several techniques are available to optimise the energy efficiency of the hot stove and include:

1. the use of a computer-aided hot stove operation which prevents unnecessary reserves by adapting the energy supply to the actual demand and which minimises the amount of enriching gas added (in cases where enrichment takes place)
2. preheating of the fuel or combustion air in conjunction with insulation of the cold blast line and waste gas flue. Sensible heat from the flue-gas can be used to preheat the fuel media. The feasibility of this depends on the efficiency of the stoves as this determines the waste gas temperature (e.g. at waste gas temperatures below 250 °C, heat recovery may not be a technically or economically attractive option). The heat exchanger preferably consists of a heating oil circuit, for economic reasons. In some cases, imported heat may be used, e.g. sinter cooler heat, if the distances are reasonable. A preheated fuel medium reduces energy consumption. At plants that use enriched blast furnace gas, preheating the fuel could mean that enrichment would no longer be necessary
3. use of more suitable burners to improve combustion
4. rapid O₂ measurement and subsequent adaptation of combustion conditions.

Achieved environmental benefits

[66, Joksch 1995] reported the following energy savings:

1. the use of computer-aided hot stoves leads to an efficiency improvement of the hot stove of more than 5 %. This equals an energy savings of approximately 0.1 GJ/t hot metal.
2. preheating of the fuel or combustion air can lead to an energy savings of approximately 0.3 GJ/t hot metal as well. Significant energy savings are reached by using the combustion gas to preheat the blast furnace gas. The savings from this technique are about 170 MJ/t steel. The emission levels that can be achieved are: NO_x 20 – 25 g/t hot metal, SO₂ 70 – 100 g/t hot metal, CO₂ 0.4 – 0.5 g/t hot metal.
3. concerning techniques No 3 and 4, an additional 0.04 GJ/t hot metal may be saved by improved combustion and adaptation of combustion conditions.

The total energy savings possible by a combination of techniques is of the order of 0.5 GJ/t hot metal.

Cross-media effects

No cross-media effects were reported by [66, Joksch 1995]. It might be expected that preheating of the fuel media and a reported increase of the flue-gas temperature would lead to higher NO_x emissions from the hot stoves. The application of modern burners may reduce NO_x emissions.

Operational data

No data submitted.

Applicability

The techniques mentioned above for saving energy at the hot stoves are applicable both at new and existing plants where design permits and the prerequisites are present.

Economics

These measures might be attractive from an economic point of view because energy consumption is reduced and thus money is saved. The profitability depends on the amount of energy saved and on the investment and operational costs of the measures. Typical installation costs for heat recovery were EUR 6 million in 1997 per set of stoves, i.e. per blast furnace.

Implementation of computer-aided control could require the construction of a fourth stove in the case of blast furnaces with three stoves (if possible) in order to maximise benefits.

Driving force for implementation

The economic benefits connected with increased productivity and reduced energy consumption are the driving forces for the implementation of these techniques.

Example plants

Thyssen Krupp Stahl AG, Duisburg, Germany

Blast Furnace No 7; Corus, IJmuiden, the Netherlands

ArcelorMittal, Ghent, Belgium

ArcelorMittal, Gijón, Spain

Ruukki, Finland

Voestalpine Stahl GmbH, Linz, Austria

Voestalpine Stahl GmbH, Donawitz, Austria.

Reference literature:

[66, Joksch 1995] [208, Lindfors et al. 2006]

7 BASIC OXYGEN STEELMAKING AND CASTING

The replacement of air with oxygen in steelmaking was originally suggested by Henry Bessemer. Since 1950, oxygen has been used in steelmaking irrespective of the specific production method. A prerequisite for the cost-effective use of the basic oxygen furnace (BOF) process on an industrial scale was the availability of the required tonnage of technically pure oxygen, as well as the water-cooled lance technology necessary for introducing the oxygen into the converter.

The first production scale BOF (also called an oxygen converter) was erected in Linz, Austria in 1952 [363, Eurofer 2007].

The BOF process and the electric arc furnace (EAF) have since replaced existing, less energy efficient steelmaking processes such as the Thomas process and the open-hearth process (Siemens-Martin process). In the EU, the last Siemens-Martin ovens were taken out of operation at the end of 1993. The BOF process and the EAF are the only processes being used to produce steel in the EU. The BOF process accounts for two thirds of production and the EAF process accounts for the remaining third (EU-27 in 2006. See also Figure 1.2).

Figure 7.1 shows a BOF at the moment of charging hot metal.



Figure 7.1: Basic oxygen furnace at the moment of charging hot metal

7.1 Applied processes and techniques

The objective in oxygen steelmaking is to burn (i.e. oxidise) the undesirable impurities contained in the hot metal feedstock. The main elements thus converted into oxides are carbon, silicon, manganese and phosphorus [363, Eurofer 2007]. Sulphur content is mainly reduced during pretreatment of the hot metal. The purpose of this oxidation process, therefore, is:

- to reduce the carbon content to a specified level (from approximately 4 – 5 % to typically 0.01 – 0.4 %)
- to adjust the contents of desirable foreign elements
- to remove undesirable impurities to the greatest possible extent.

The production of steel by the BOF process is a discontinuous process which involves the following steps:

- transfer from the BF and discharge
- pretreatment of hot metal (desulphurisation, deslagging)
- transfer, weighing and reladling
- oxidation in the BOF (decarburisation and oxidation of impurities)
- secondary metallurgical treatment
- casting (continuous or/and ingot).

The individual steps and their associated emissions are summarised in Figure 7.2.

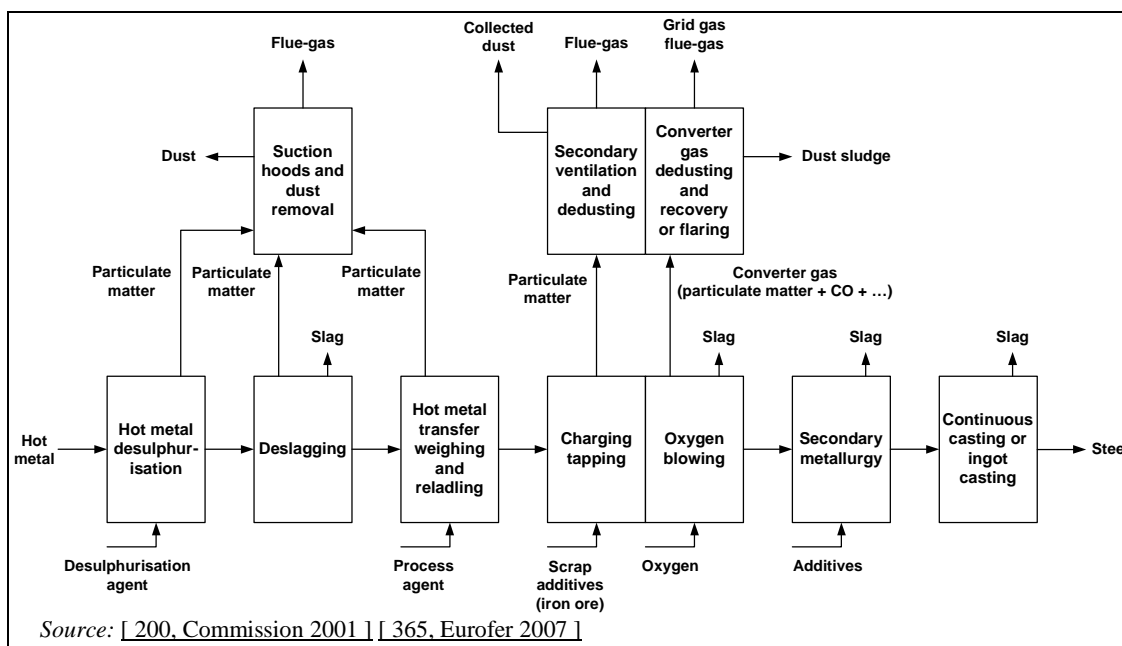

Figure 7.2: The sequence of oxygen steelmaking indicating the individual emission sources

7.1.1 Transport and storage of hot metal

Hot metal is supplied from the blast furnace to the steelmaking plant using transfer cars or torpedo ladles. The ladles are lined with corundum, mullite, and bauxite or dolomite brick with an additional insulating interlayer between the steel and the refractory material. The torpedo ladle, a form of hot metal mixer travelling on rails, has become the predominant system. The mixing vessel is supported on either side and can be rotated to discharge its contents. Torpedo ladles are commonly designed with capacities between 100 and 300 tonnes, with the largest units holding up to 400 tonnes. The design of the torpedo ladle minimises heat loss. The fact

that the torpedo ladle doubles as a hot metal mixer eliminates the need for a separate hot metal storage system.

The service life of torpedo ladles in normal use varies between 150 000 and 400 000 tonnes. Desulphurisation in the torpedo ladle shortens its potential utilisation cycle between relinings and requires special care in the selection of refractory materials.

While transporting in an open-top ladle, hot metal is, in some cases, stored in mixers. These are rotatable horizontal steel containers lined with refractory brick. They serve to compensate for production fluctuations of the blast furnace and the steelmaking plant to equalise the chemical composition of individual blast furnace heats, and to ensure homogeneous temperatures. Modern hot metal mixers have capacities of up to 2000 tonnes.

7.1.2 Pretreatment of hot metal

The aim of the pretreatment is to reduce the content of sulphur, phosphorus and silicon in the hot metal [363, Eurofer 2007].

In Europe, only the desulphurisation step is used when preparing hot metal for the BOF process. Dephosphorising and desiliconising the feedstock involves costly and sophisticated process technology which appears unwarranted in the foreseeable future, given current requirements. The use of these processes depends on the raw materials used in the blast furnace and the required steel grade [363, Eurofer 2007].

Improved blast furnace metallurgy and a reduction of sulphur input by coke and other reduction agents have resulted in lower hot metal sulphur levels. Today, specified sulphur concentrations (typically between 0.001 and 0.020 %) for charging in the converter are commonly adjusted in a hot metal desulphurisation facility located at the steel shop. External desulphurisation also implies benefits in terms of environmental protection. With an upstream blast furnace process, these generally include reduced consumption of coke and sinter, lower losses of hot metal and improved quality of the metallurgical slag. That finally results in a decrease of consumption of the refractory linings and oxygen [363, Eurofer 2007].

Desulphurisation agents are mainly calcium carbide but also lime, magnesium, calcium oxide and rarely materials which contain soda ash.

The most widespread hot metal desulphurisation method used in Europe today is that based on calcium carbide, which has superseded the previous soda process for waste disposal and air quality management reasons. The use of a mixture of calcium carbide, magnesium and lime allows the hot metal to be desulphurised to final levels down to 0.0010 %, regardless of the initial sulphur content. Disadvantages lie in the fairly low exhaustion of the desulphurising agent and the need for intense mixing of the desulphurising agent with the hot metal. One specific benefit is that the process gives rise to a crumbly slag which can be easily removed. The use of magnesium in addition to calcium carbide is approximately just as common as the use of calcium carbide alone [363, Eurofer 2007].

Soda desulphurisation with soda ash is a straightforward process due to the low melting temperature and the resulting easy miscibility of the product with the hot metal. Its drawbacks include the low specificity and the need to find a disposal route for the soda slag produced. The sulphur content of these slags varies between 1 and 15 % and their Na₂O content between 5 and 40 %, depending on the process employed. Recycling soda slag within the plant is an impractical proposition because of its high alkalinity. A cost-efficient, alternative recycling method has not been devised to date. When dumped, sodium sulphite decomposes into sodium hydroxide solution and hydrogen sulphide due to the presence of water. The use of soda ash is restricted. Small amounts of soda ash may be utilised to a limited extent during the skimming process.

The desulphurisation process is carried out by a number of different methods and systems. In the more common variants, desulphurisation takes place:

- in the blast furnace launder
- in the pouring stream
- in the transfer ladle, or
- in specially-designed metallurgical vessels.

Known desulphurisation equipment includes the immersion lance, the siphon ladle, rotating and oscillating vessels, and agitating equipment for use in the ladle. Calcium carbide is most commonly used in conjunction with the immersion lance and the stirring method. Magnesium is added in powdered form in a carrier gas via an immersed lance. The desulphurisation process is performed at separate treatment stations.

An example of practice is as follows: a desulphurising agent is blown through a lance into the hot metal with the aid of nitrogen or dried air. The sulphur is bound in the slag, which floats to the top of the hot metal. The slag is then removed in the slag separation unit and the liquid iron is fed from the ladle into the weighing pit. If necessary, process agents are added in these pits. In some cases, a second slag removal is performed here using slag scrapers. Mostly the ladle is weighed by crane balance. After weighing, the hot metal is charged into the converter [363, Eurofer 2007]. The difference between the filled ladle and the empty ladle is the accurate weight of the hot metal filled into the converter.

7.1.3 Oxidation in the basic oxygen furnace

In order to meet the objectives mentioned above, undesired impurities are oxidised with subsequent removal of the off-gas or slag. Table 7.1 lists the main chemical reactions during the oxidation process occurring in the basic oxygen furnace (BOF). Undesirable impurities are removed with the off-gas or the liquid slag. The energy required to raise the temperature and melt the input materials is supplied by the exothermic oxidation reaction, so that no additional heat input is required. On the other hand scrap or ore have to be added to balance heat. In some BOF and combined blowing processes, gaseous hydrocarbons (e.g. natural gas) are injected as tuyère coolants (see Figure 7.4).

Table 7.1: Main chemical reactions taking place during the oxidation process

Oxidation process	Chemical reaction
Carbon elimination	$[C] + [O] \leftrightarrow CO$ (off-gas)
	$[CO] + [O] \leftrightarrow CO_2$ (off-gas)
Oxidation of accompanying and tramp elements	
- Desiliconisation	$[Si] + 2[O] + 2[CaO] \leftrightarrow (2CaO \cdot SiO_2)$
- Manganese reaction	$(Mn) + (O) \leftrightarrow (MnO)$
- Dephosphorisation	$2[P] + 5 [O] + 3 [CaO] \leftrightarrow (3CaO \cdot P_2O_5)$
Deoxidation	
Removal of residual oxygen through ferro-silicon	$[Si] + 2[O] \leftrightarrow (SiO_2)$
Aluminium reaction	$2[Al] + 3[O] \leftrightarrow (Al_2O_3)$
NB: — [] = Dissolved in the hot metal. — () = Contained in the slag.	
Source: [200, Commission 2001] [363, Eurofer 2007].	

The operation of a BOF is semi-continuous. A complete cycle consists of the following phases: charging scrap and molten hot metal, oxygen blowing, sampling and temperature recording, and tapping. In modern steelworks, up to 380 tonnes of steel are produced in a 30 – 40 minute cycle.

During the process, a number of additives are used to adapt the steel quality and to form slag. During charging and tapping, the converter is tilted. During oxygen blowing, the converter is placed in an upright position [363, Eurofer 2007].

There are several types of reactors used for the basic oxygen steelmaking process. The most commonly used type is the LD converter (Linz-Donawitz) applied for hot metal with a low phosphorus content. The converter is a pear-shaped, refractory-lined reactor into which a water-cooled oxygen lance is lowered. Through this lance, pure oxygen (>99 %) from an air separation plant is blown onto the liquid hot metal (see Figure 7.3) [363, Eurofer 2007].

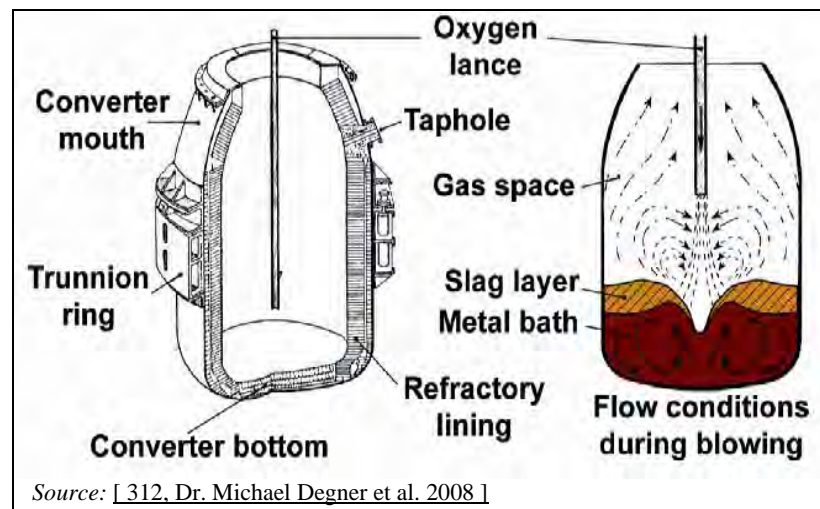

Figure 7.3: Basic oxygen steelmaking converter

Other types of steelmaking reactors are the oxygen bottom Maxhuette (OBM) process known in the English speaking world as the Q-BOP process (see Figure 7.4) and the Loire-Wendel-Sprunck (LWS) process. These processes differ from the LD converter in that oxygen and fluxes are blown through submerged tuyères in the furnace bottom using hydrocarbons for cooling [19, EC BOF 1995] [312, Dr. Michael Degner et al. 2008] [363, Eurofer 2007].

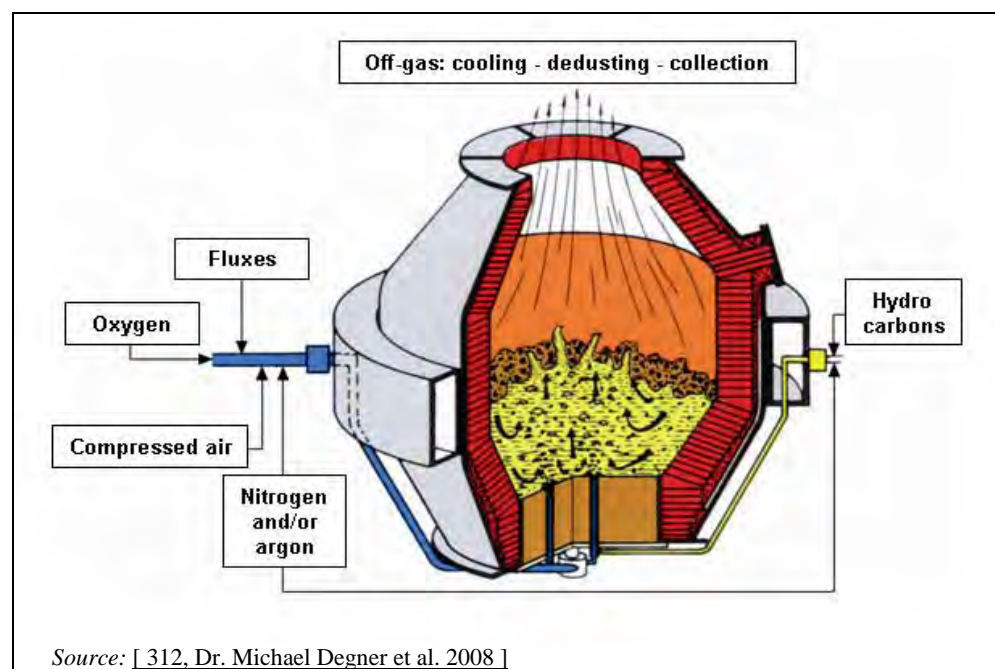

Figure 7.4: Cutaway model of a OBM (Q-BOP) converter

Combined blowing techniques have also been developed. Where necessary, the LD converter process can be enhanced by ‘bottom stirring’ with argon gas (Ar) or nitrogen (N₂) through porous bricks in the bottom lining in certain phases of the process. The most frequent types are the lance bubbling equilibrium (LBE) process and the Thyssen blowing metallurgy (TBM) process. An example of the latter is shown in the schematic of a combined blowing converter system with top-blowing in Figure 7.5. Alternatively, bottom tuyères may be used to inject pure oxygen or other gases during the blowing processes such as the lance tuyère equilibrium (LTE) or the LD-HC technique. These combined blowing techniques produce a more intensive circulation of the molten steel and improve the reaction between the oxygen and the molten metal [363, Eurofer 2007].

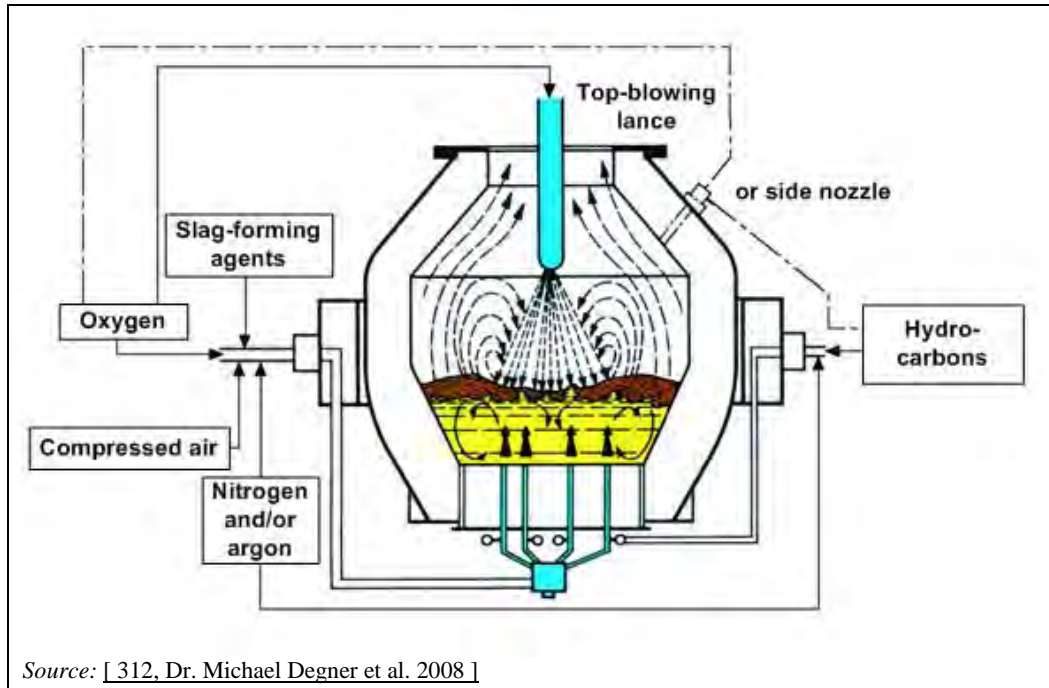

Figure 7.5: Schematic of a combined blowing converter system with top-blowing

Table 7.2 gives an overview of number of oxygen converters in use in the EU, arranged by process types. Obviously the LD process is the dominant one.

Table 7.2: Types, number and rated capacities of basic oxygen furnaces (oxygen converters) in operation in the EU

Process	Numbers		Rated capacity (kt/yr)	
	1997	2004	1997	2004
LD	17	5	12400	5400
LD with bottom stirring	44	36	64960	54300
LBE	22	10	27550	12700
OBM	5		2780	
KOBM	1		2200	
EOF	1		400	
TBM		5		10200
LWS	2	2	2900	2200
LET		2		4400
Total	92	60	113190	89200

Source: [200, Commission 2001] [363, Eurofer 2007] [365, Eurofer 2007].

The amount of oxygen consumed depends on the composition of the hot metal (i.e. C, Si, P content).

Progress of the steelmaking process is measured by taking samples of the molten metal. In modern plants, sampling is performed without interrupting the oxygen blowing using a substance. The same result is obtained by standardising the process procedures and/or by using adequate dynamic modelling and monitoring. Those practices sustain quality, productivity and reduce fume emissions during former converter tilting. When the steel quality meets the demands, the oxygen blowing is stopped and the crude steel is tapped from the converter into a ladle. The molten steel is then transported, after secondary metallurgy, to the casting machine.

The oxidising reactions are exothermic thus increasing the temperature of the molten iron. Scrap, iron ore or other coolants are added to cool down the reaction and maintain the temperature at approximately 1600 – 1700 °C. Usually, approximately 190 kg/t LS is scrap, but values of 300 kg/t LS and even higher are sometimes reached. The amount of scrap charged depends on the pretreatment given to the hot metal and the required liquid steel tapping temperature [145, UBA Comments 1997]. Variations in the market value of scrap and the required steel specifications also have an influence [363, Eurofer 2007].

The gases produced during oxygen blowing (converter gas) contain large amounts of carbon monoxide. In most steelmaking plants, measures have been taken to recover the converter gas and use it as an energy source. Open combustion systems introduce air into the converter flue-gas duct, thus partially or fully combusting the carbon monoxide. In the suppressed combustion system, a skirt is lowered over the converter mouth during oxygen blowing. Thus, ambient oxygen cannot enter the flue-gas duct and the combustion of carbon monoxide is prevented. The CO-rich flue-gas can be collected, cleaned and buffered for subsequent use as fuel. A main advantage of suppressed combustion is the smaller flue-gas flow since no combustion occurs and no additional air-nitrogen is introduced. This results in higher productivity since oxygen blowing speed can be increased. Both ‘open combustion’ and ‘suppressed combustion’ systems are in use. The heat generated in open combustion is usually recovered in a waste heat boiler [363, Eurofer 2007].

The oxygen steelmaking process also generates considerable quantities of dust during the charging of scrap and hot metal, blowing, and during the tapping of slag and liquid steel. All steelmaking shops in the EU have taken measures to reduce dust emissions.

During the steelmaking process, BOF slag is formed. Slag control is intended to adjust the composition of the hot metal and to generate slag of a desired quality [363, Eurofer 2007]. During slag production and after cooling, several measures are taken depending on the market conditions to influence the quality of the BOF slag (see Figure 7.6). Usually the crystalline slag is crushed and sieved which is part of the production process. Slag can also be treated when still liquid just after having been generated by adding silicium in order to produce very high quality aggregates. Phosphates may also be added to produce agricultural soil conditioner. The technical and chemical properties of the slag make it suitable for applications in civil and hydraulic engineering as well as in agriculture [363, Eurofer 2007]. Sometimes the slag is disposed of in landfills.

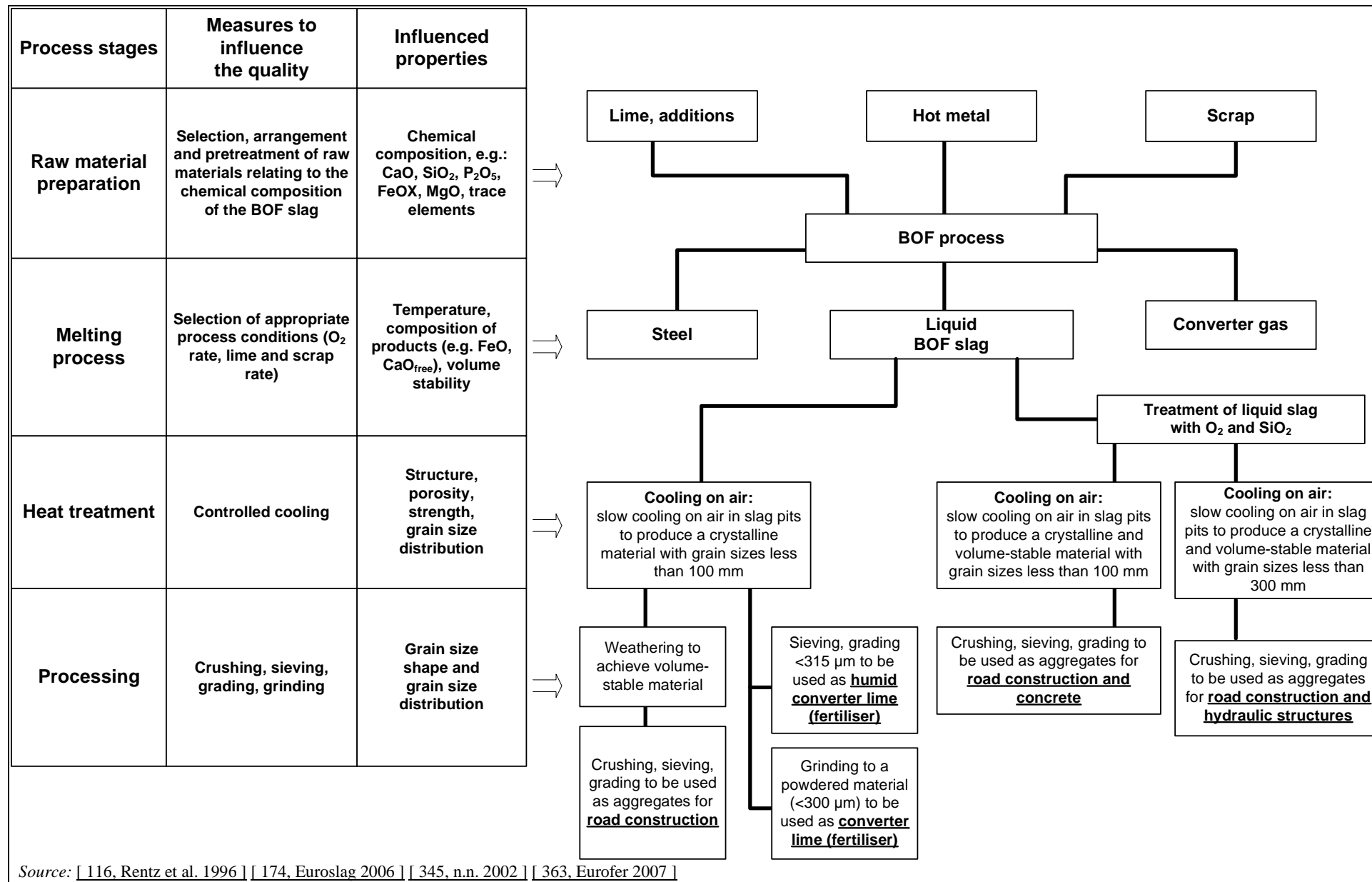

Figure 7.6: Treatments of BOF slag

7.1.4 Secondary metallurgy

The oxidising process in the converter is usually followed by post-treatment including a number of diverse metallurgical operations. Referred to as 'secondary metallurgy', this treatment was developed in response to ever increasing quality requirements and has led to substantial productivity increases by shifting the burden of metallurgical refining processes away from the converter. The main objectives of secondary metallurgy are:

- mixing and homogenising
- adjustment of chemical compositions to close analysis tolerances
- temperature adjustment in time for the downstream casting process
- deoxidation
- removal of undesirable gases such as hydrogen and nitrogen
- improvement of the oxidic purity by separating non-metallic inclusions.

An overview of secondary metallurgy operations is given in Figure 7.7. These steps are performed in the ladle or ladle furnace, in a vacuum system, or in specially-designed furnaces.





<p>Prevention of slag carryover</p>	
<p>Mixing/ homogenising</p>	<p>Gas injection Bottom bubbling (porous plug) Lance Electromagnetic stirring Coil</p> 
<p>Charging of solids</p>	<p>Alloying elements Gas Powder/ gas Wire Gas</p> 
<p>Vacuum treatment</p>	<p>Ladle degassing RH/DH VOD</p> 
<p>Heating</p>	<p>Ladle furnace VAD</p> 
<p>Ladle/tundish casting stream shrouding</p>	<p>Gas Gas Gas</p> 
<p>Electromagnetic stirring during continuous casting</p>	<p>MS EMBR</p> 
<p>Source: [200, Commission 2001] [312, Dr. Michael Degner et al. 2008] [363, Eurofer 2007] [365, Eurofer 2007]</p>	

Figure 7.7: Overview of secondary metallurgy operations and cleaning during tapping
 NB: VOD is an operation used for the production of stainless steel (see Chapter 8)

An important step in secondary metallurgy is vacuum treatment. This mainly serves to remove gaseous hydrogen, oxygen, nitrogen or residual carbon concentrations from the steel at a vacuum below 0.5 mbar (50 Pa). Today, vacuum treatment operations include the precision decarburisation and deoxidation of unalloyed steels, the decarburisation of chromium-alloy grades, the removal of sulphur and inclusions, as well as various alloying, homogenisation, temperature management and reoxidation prevention steps. Using vacuum treatment, the mass content of hydrogen and carbon can be lowered to contents of between 0.0002 and 0.0020 %, respectively. Vacuum metallurgy has given us steels of improved purity, lower gas content, and tighter alloying tolerances [172, Fandrich et al. 2008].

The following vacuum treatment methods are used:

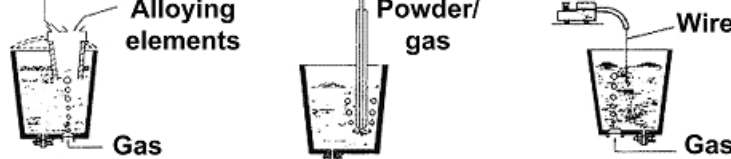
- ladle stand or tank degassing and
- recirculating degassing.

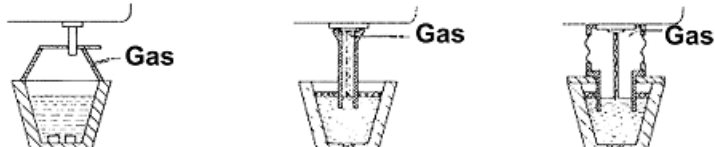
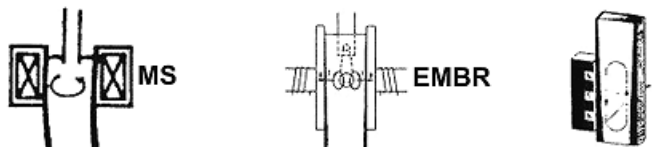
Of these, recirculating degassing is the most common process today, although ladle stand degassing is coming back into widespread use.

In ladle degassing the ladle which contains the oxidised metal is placed in a vacuumised container. An input of agitation energy ensures higher reaction speeds and reduces the final concentration of undesirable bath constituents. This agitation may be accomplished by injecting argon through one or more porous plugs in the ladle bottom by homogenising the melt via a lance or by an inductive stirring process. In case of a tank degasser, it is also possible to noticeably decrease nitrogen and to reach very low levels of sulphur (lower than 10 ppm) thanks to a very strong stirring between slag and metal.

Depending on individual requirements, it is possible to adjust the temperature of the melt at this stage by applying an appropriate combination of:

1. adding high-purity scrap (cooling scrap) to cool the melts
2. adding aluminium and blowing oxygen to raise the temperature
3. electrical heating by graphite electrodes [363, Eurofer 2007].

Alloying agents are also added to the melt to obtain a precision adjustment of steel composition (e.g. Fe/Ni, Fe/Mo, Fe/Mn, Fe/Cr). These alloys are in solid form or enclosed in a hollow wire which is unwound from a reel system, or else by powder injection via lances. Before the end of the stirring cycle, the oxygen level may be determined with the aid of a special probe and adjusted by adding deoxidants. Throughout the stirring process, the dust/gas mixture rising up from the ladle is drawn off by a movable fume hood [275, Kobelco 2005] [363, Eurofer 2007].

In recirculating degassing, the molten metal is vacuum treated continuously or in separate portions. Depending on the process design, a distinction is made between DH (Dortmund-Hörder)-type vacuum lift degassing and RH (Ruhrstahl-Heraeus)-type vacuum recirculating degassing.

7.1.5 Casting

Once the final steel quality has been achieved, the steel is conveyed in a casting ladle to the casting machines. Some years ago, the standard method was to pour the molten steel into permanent moulds (permanent mould or ingot casting) by a discontinuous process. Today, the method of choice is continuous casting, whereby the steel is cast in a continuous strand (i.e. slabs of different sizes, thin strip).

7.1.5.1 Continuous casting

[373, Eurofer 2007]

Figure 7.8 shows the schematic diagram of a continuous casting plant.

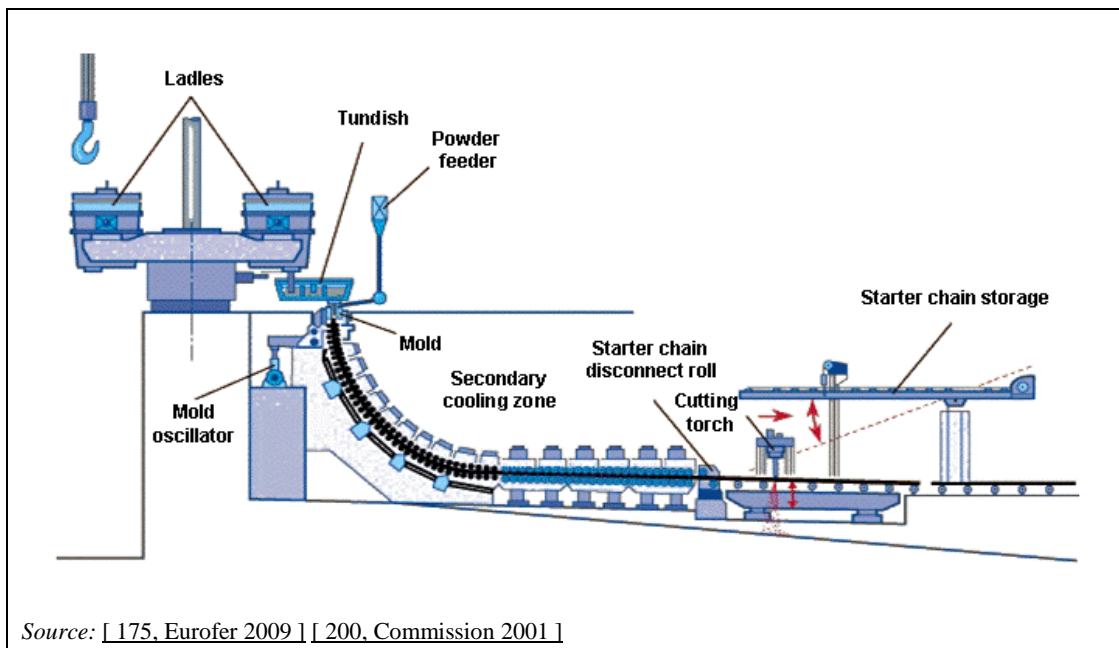

Figure 7.8: Scheme of a continuous casting plant with a soaking furnace and a rolling mill with hot charging

Continuous casting offers several important benefits in comparison with ingot casting: [363, Eurofer 2007]

- energy savings, reduced emissions and reduced water utilisation due to the elimination of slabbing mills and billet mills
- improved working conditions
- high yield rates, in excess of 95 %
- high productivity.

Since continuous casting was first introduced on an industrial scale in the late 1960s, its share in overall EU steel output has risen to approximately 97 %. Worldwide, about 90 % of all steel is now cast by the continuous method. Apart from the traditional ingot casting process, continuous casters have also replaced the blooming-slabbing and semifinishing operations of conventional hot rolling mills. Today, almost all steel grades for rolled products can be handled by the continuous casting route, since the necessary preconditions such as deoxidation and degassing are provided by modern secondary metallurgy.

Various types of continuous casters exist and are referred to as vertical type, bending-and-straightening type, bow type and oval bow type machines, depending on their configuration.

The liquid steel is poured from the converter into a ladle which transports the steel after secondary metallurgy to the ‘tundish’ of the continuous casting machine (CCM). This is an intermediate ladle with a controllable outlet. The ladles are preheated prior to accepting a liquid steel charge in order to avoid temperature stratification in the tundish.

When the liquid steel has reached the desired temperature, it is poured into the tundish. From here, it passes to a short water-cooled copper mould where no air is present and which performs oscillating up and down movements to prevent the steel from sticking. The mould gives the metal the desired shape. Continuous casting is a process which enables the casting of one or a sequence of ladles of liquid steel into a continuous strand of billet, bloom, slab, beam blank or strip. Mould lubricant is added in powder form or vegetable oil. When the metal leaves the casting mould, a ‘skin’ of solidified steel has formed and a large number of trundles (the ‘pinch-

roll²) guide the cast steel with a gentle curve toward a horizontal position. Here, the endless casting is cut in pieces with a torch cutter. Slabs, blooms and billets are cast in this way.

In the case of non-self-supporting sections, the red-hot strand, with its solidified surface zone, moves through a number of driven and undriven roll pairs which support its shell against ferrostatic pressure. As the core is still liquid, it is sprayed carefully with water and cooled until fully solidified (secondary cooling). This process prevents cracks in the strand surface zone, which is still fairly thin, and also protects the rolls from overheating. The supporting, conveying and driving elements are commonly equipped with idler-roller with interior and exterior cooling. In the secondary cooling zone, interior roll cooling becomes dispensable as soon as the temperature is reduced sufficiently by the water spray. A number of bearings are connected to an automatic grease-lubricating system. Once the strand has fully solidified, it can be cut to size by cutting torches moving with the strand or by shears. The rapid cooling process gives the steel a uniform solidification microstructure with favourable technological properties. The solidification microstructure of the strand can be influenced by downstream air or water cooling.

The shape of the strand is determined by the mould geometry. Current mould types include rectangular, square, round or polygonal sections. For the production of steel shapes, it is possible to use moulds resembling the approximate cross-section of the intended product. Typical strand dimensions in continuous casting vary between 80×80 mm and about 310×310 mm, 600 mm (round) in billet and 450×650 mm in bloom systems, while slab casters produce sizes of up to 350 mm in thickness and up to 2720 mm in width. Billet casters can handle several (currently up to eight) strands at the same time, while the number of strands in slab casting is limited to two.

7.1.5.2 Near net shape casting

Since the end of the 1980s, continuous casting has been developed for the manufacturing of flat products. These route can be summarised under the heading 'near net shape casting' which includes thin slab casting, near net shape strip casting also known as direct strip casting (DSC) and thin strip casting. There is actually an installed capacity of about 7 million tonnes of these processes in the EU. The thin strip casting shortens the process from liquid steel to hot rolled sheet, therefore reducing the overall energy demand and increasing material efficiency but requires other secondary metallurgical steps. Typical dimensions for thin slab casting vary between sizes of 15 and 50 mm in thickness. Near net shape strip casting leads to a strand thickness of below 15 mm and thin strip casting to less than 5 mm [312, Dr. Michael Degner et al. 2008].

This process is further discussed in this BREF but it is also included in the Ferrous Metals Processing Industry BREF [188, European Commission 2001]. The decision to build a thin strip casting highly depends on local conditions and the required product quality. In case near net shape strip casting is used, it should be taken into account that special secondary metallurgical steps are needed and therefore the emissions and energy consumption for these treatments in relation to LS production could be higher compared with other processes [363, Eurofer 2007]. Scale formation during this type of casting is typically higher than in conventional casting [384, Max-Planck-Institut et al. 2002].

7.1.5.3 Ingot casting

In ingot casting, the liquid steel is cast into casting moulds. Depending on the desired surface quality, degassing agents (such as NaF) can be added during casting in the ingot mould. After cooling, the ingots are taken out of the casting mould and transported to the rolling mills. Subsequently, after preheating, the ingots are rolled into slabs, blooms or billets. In many places, ingot casting has been replaced by continuous casting. In 2004, 3 % of steelmaking of the EU-15 was produced as ingot casting. For the new Member States (EU-10), this percentage

is about 4.2 %. It is expected that ingot casting will eventually be almost completely replaced by continuous casting except in the case of those products which require ingot casting to achieve the necessary quality, such as producing heavy weights for forging [363, Eurofer 2007].

Ingot casting in EAF is also still applied for some grades and applications.

7.2 Current emission and consumption levels

7.2.1 Mass stream overview and input/output data

Figure 7.9 provides an overview of the input and output mass streams of basic oxygen steelmaking. This overview may be used for the collection of data from a single oxygen steelmaking plant.

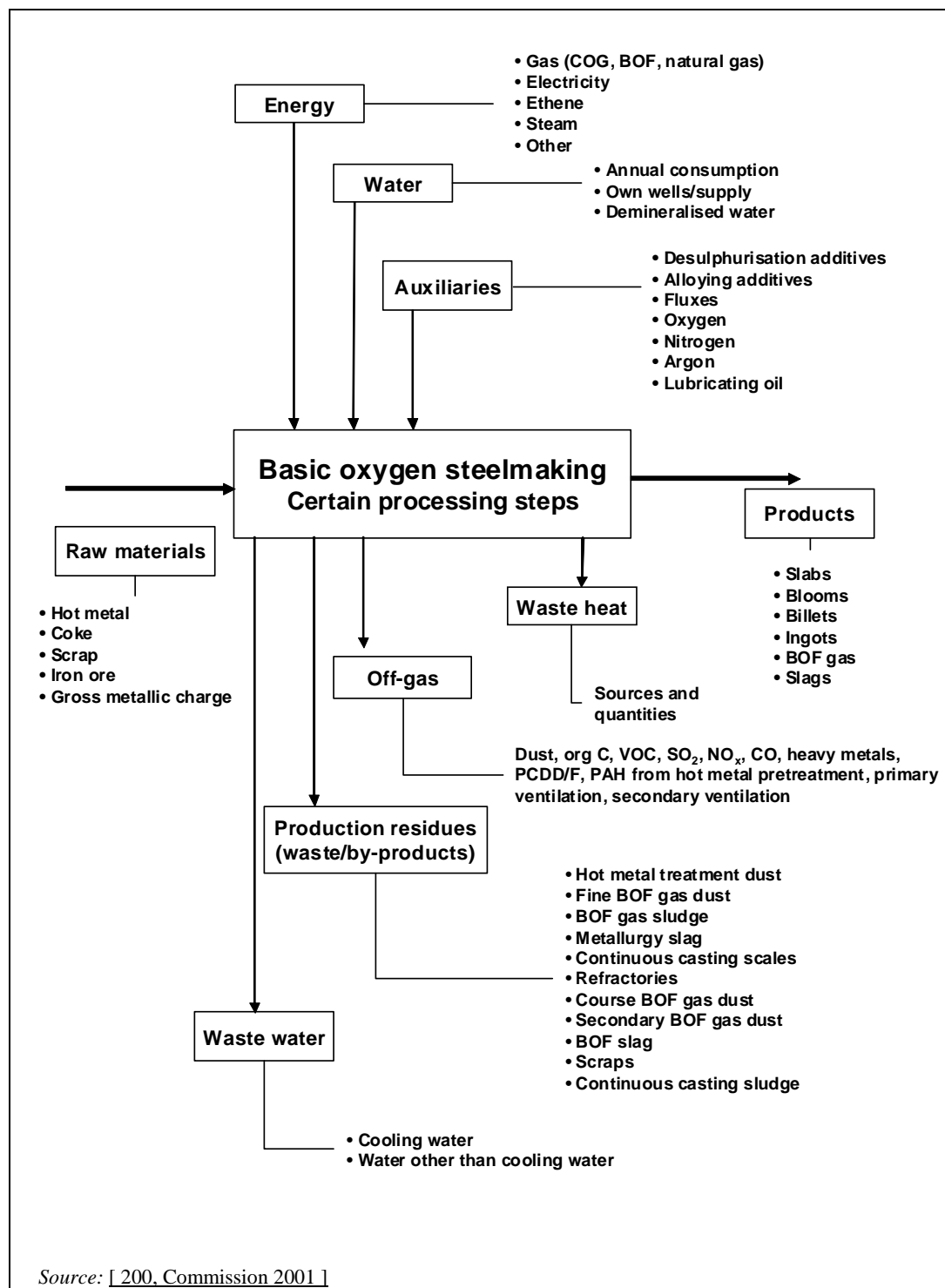

Figure 7.9: Mass stream overview of a basic oxygen steelmaking plant

Figure 7.10 presents the general process layout of basic oxygen steelmaking and presents a visualisation of the input and output mass streams.

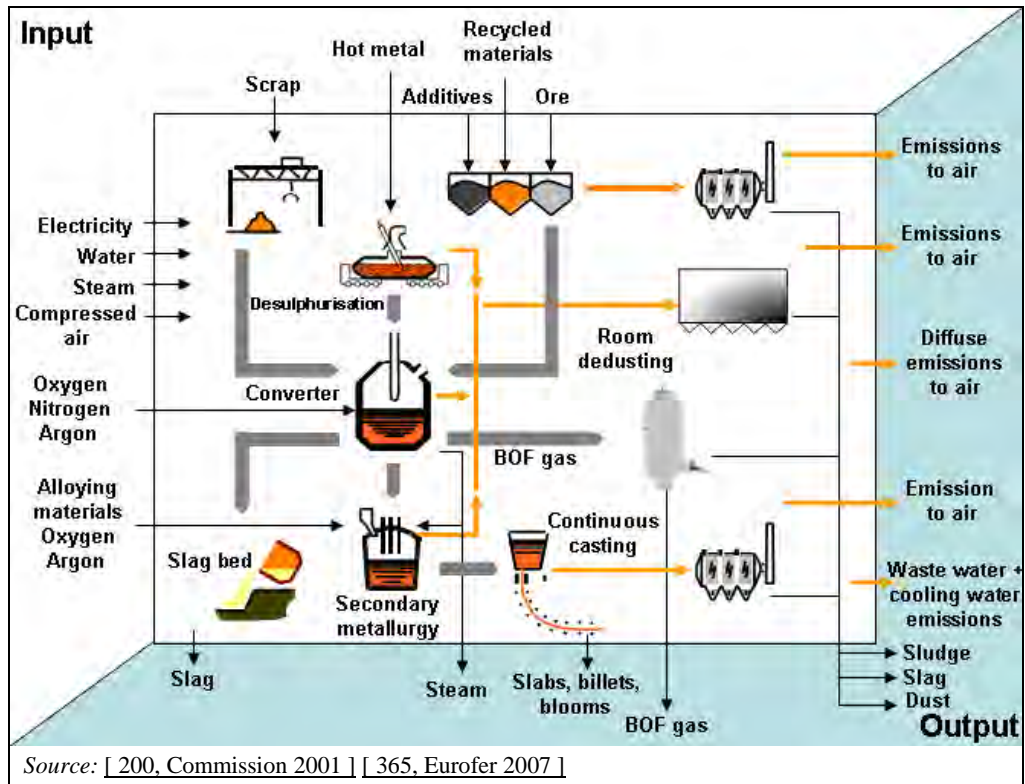

Figure 7.10: General process layout of basic oxygen steelmaking indicating the individual operations and the input and output mass streams

Specific input factors and specific emission factors have been determined for the basic oxygen furnaces. Values for these factors are shown in Table 7.3 from basic oxygen steelmaking plants located in different EU Member States.

Table 7.3: Input/output-data from 21 existing basic oxygen steelmaking plants in different EU Member States

Input			Output		
Raw materials			Products ⁽¹⁾	kg/t LS	1000.0
Hot metal ⁽²⁾	kg/t LS	788 – 931	Slabs ⁽³⁾		
Scrap	kg/t LS	101 – 340	Blooms		
Iron ore	kg/t LS	0.02 – 19.4	Billets		
Other Fe material	kg/t LS	0 – 60	Ingots		
Coke	kg/t LS	0 – 0.4	Foundry		
Lime	kg/t LS	30 – 67			
Dolomite	kg/t LS	0 – 28.4			
Alloys ⁽⁵⁾	kg/t LS	1.3 – 33			
Gases			Energy		
Oxygen	m ³ /t LS	49.5 – 70	BOF gas	MJ/t LS	(0 ⁽⁴⁾) 350 – 700
Argon	m ³ /t LS	0.55 – 1.1	Steam ⁽⁶⁾	MJ/t LS	(0) 124 – 335
Nitrogen	m ³ /t LS	2.3 – 18.2			
Energy ⁽⁹⁾			Emissions		
Natural gas	MJ/t LS	44 – 730	Dust ⁽⁷⁾ ⁽⁸⁾	g/t LS	14 – 143
Electricity	MJ/t LS	35 – 216	Cr ⁽⁷⁾	g/t LS	0.01 – 0.075
COG	MJ/t LS	0 – 800	Fe	g/t LS	45.15
BF gas	m ³ /t LS	1.84 – 17.6	Cu ⁽⁷⁾	g/t LS	<0.01 – 2.72
			Pb ⁽⁷⁾	g/t LS	0.17 – 0.98
			Mn ⁽⁷⁾	g/t LS	0.3 – 1.56
			NO _x	g/t LS	8.2 – 55 (100)
			CO ⁽¹⁰⁾	g/t LS	393 – 7200 (18000)
			CO ₂ ⁽¹¹⁾	kg/t LS	22.6 – 174
			PAH ⁽¹²⁾	mg/t LS	10
			PCDD/F	µg I-TEQ/t LS	0.043 – 0.094
Overall steam	MJ/t LS	13 – 150	Production residues (waste/by-products)		
			Slag from desulphurisation	kg/t LS	3 – 40
Compressed air	Nm ³ /t LS	8 – 26	BOF slag	kg/t LS	85 – 165
			Slag from secondary metallurgy	kg/t LS	9 – 15
Water	m ³ /t LS	0.8 – 41.7	Spittings	kg/t LS	2.8 – 15
			Dusts	kg/t LS	0.75 – 24
			Slag from continuous casting	kg/t LS	4 – 5.7
			Mill scale	kg/t LS	2.3 – 7.7
			Rubble	kg/t LS	0.05 – 6.4
			Waste water	m ³ /t LS	0.3 – 6

(¹) Sum of products (slabs, blooms, billets or ingots). Some BOF plants operate slab caster in combination with bloom, billet or ingot caster. The output is normalised to 1000 per plant.

(²) A distinction can be drawn between high phosphorus (1.5 – 2.2 % P) and low phosphorus hot metal (0.08 – 0.25 % P).

(³) Slabs are the most common product obtained from the BOF route. Long products such as billet and blooms are very often produced from EAFs.

(⁴) Zero in the case of non-recovery of BOF gas.

(⁵) Important alloying additions are: Fe-Ti, Fe-W, Fe-Ni, Fe-V, Fe-Si and Fe-Mo.

(⁶) High value in the case of non-suppressed combustion and heat recovery from flue-gases in the form of steam and hot water; zero in the case of the quantitative recovery of BOF gas without any heat recovery (no steam generation).

(⁷) Higher value in the case of less sufficient secondary dedusting.

(⁸) Information on PM₁₀ and PM_{2.5} are generally not available today.

(⁹) The wide range of energy inputs shows the variety of energy management at different sites.

(¹⁰) The wide range reported is due to the different kinds of gas utilisation.
Information about the determination of the data like sampling methods, analysis methods, time intervals, computation methods and reference conditions is not sufficiently available. Data in the table are yearly mean values and refer to 2004. Emission data reflect the situation after abatement and include primary and secondary ventilation.

(¹¹) High value in the case of partial to full combustion of the BOF gas – indicative value. Emissions also depend on energy input and individual energy and material.

(¹²) PAH as Borneff 6; data available from one plant only.

NB: — LS = liquid steel (crude steel).
— Values between brackets represent special conditions or abnormal situations. They are not considered representative of BOF operation.

Source: [200, Commission 2001] [234, Poland 2007] [359, Netherlands 2007] [363, Eurofer 2007] [365, Eurofer 2007] [372, Czech TWG member 2008].

7.2.2 Environmental issues for basic oxygen steelmaking

The basic oxygen steelmaking process is a source of primarily dust and solid wastes/by-products and waste water. When abatement techniques are applied to reduce emissions, cross-media effects occur. Generally, the Sections 7.2.2.1 to 7.2.2.4 below describe the most relevant environmental issues in the oxygen steelmaking process [363, Eurofer 2007].

7.2.2.1 Emissions to Air

The ducted emissions to air from all of the below mentioned processes/emission sources have been summarised in Table 7.3 in the previous section.

Table 7.4 shows some other air pollutants not appearing in Table 7.3.

Table 7.4: Other air pollutants

Air pollutant	Emissions (mg/t LS)
SO _x	3790 – 13400
HF	116 – 760
CH ₄	215
Cd	200 – 2316
Ni	572 – 2316
Zn	66154
NB: Values correspond to two EU installations.	
Source: [234, Poland 2007].	

Depending on the quality of the scrap used various other organic pollutants such as PCB and chlorobenzenes resulting from the thermal degradation of organic materials (oils, paints, lubricants or plastics) may be present in the emissions from the charging of scrap. No data on the emissions of these pollutants are available. Appropriate screenings of these emissions as well as a balance of the toxics detected might be highly advisable.

Following the material flow, emissions to air occur from the following process stages.

Hot metal pretreatment

- reladling and deslagging
- hot metal desulphurisation

BOF operations:

- BOF charging
- BOF oxygen blowing (converter gas or BOF gas generation)
- tapping of liquid steel and slag from BOF (converters)

Secondary metallurgy:

- tapping operations (i.e. ladles, ladle furnaces, converters and other equipment used in secondary metallurgy)
- degassing
- refractory preheating (ladle, tundish, degasser)
- handling of additives

Casting

- ingot or continuous casting

Diffuse emissions

- diffuse emissions occur from all the above-mentioned processes whenever off-gases are not fully captured.

Usually the BOF gas (converter gas) is referred to as primary off-gas. The subsequent extraction and dedusting is indicated as a primary dedusting system. The emissions from all other sources related to the aforementioned BOF steelmaking processes are usually referred to as secondary off-gases and being dedusted by the secondary dedusting system. Sometimes the emissions from the hot metal pretreatment are extracted and treated separately. Usually they are part of the secondary dedusting system.

7.2.2.1.1 Emissions from hot metal pretreatment

During reladling, desulphurisation and deslagging, emissions of dust occur. The exhaust air generated in the desulphurisation process, subsequent slag separation and weighing is laden with up to 10000 mg/Nm³ or 1000 g/t steel of dust [19, EC BOF 1995] [76, Koeller 1995]. An efficient collection of the emissions from hot metal pretreatment can be obtained during these processes applying appropriate hoods and doghouses. The off-gas is subsequently cleaned by means of wet scrubbers or any other dedusting systems with the same removal efficiency such as bag filters or ESPs (secondary or separate dedusting systems) [363, Eurofer 2007].

When the dust is efficiently extracted and subsequently led through a bag filter (or an ESP), emissions of less than 10 mg/Nm³ (around 1 g/t LS) can be achieved.

In some cases, calcium carbide has been employed in the desulphurisation process. Where water has been used for cooling purposes in order to prevent dust emissions, severe odour problems have been observed. The reason for this was the formation of H₂S and organic sulphides which were probably formed by sulphur and residual carbide. By the use of calcium oxide instead of calcium carbide, the slag can be cooled in the air with significantly fewer odour problems.

In one plant, SO₂ emissions have been monitored continuously. In 2006 daily average emission values of SO₂ are in the range of 20 – 100 mg/Nm³ (see Figure 7.21). About 85 % of the half-hour average SO₂ values are below 100 mg/Nm³ (reference period 1/2007 – 5/2007); however, single values are significantly higher (up to 340 mg/Nm³) [277, Wiesenberger 2007].

7.2.2.1.2 Emissions from BOF operations

Emissions from BOF operation occur during:

- BOF charging
- BOF oxygen blowing.
- slopping during oxygen blowing
- tapping of liquid steel and slag from BOF (converters).

The emissions from charging, blowing and slopping during the blowing of the BOF (converter) and the tapping of liquid steel and slag are of major relevance and are described in more detail here.

Secondary ventilation and dedusting systems at BOF operations:

Dust is emitted during all of the above-mentioned processes as the charging of scrap and hot metal, oxygen blowing and during the tapping from the BOF. During charging or tapping operations, the converter is tilted. A ‘secondary ventilation’ and dedusting system, is often installed to abate the dust emissions that occur. The secondary ventilation system usually

consists of a canopy hood just above the converter in a tilted position and a doghouse around the remaining 3/4 of the converter. During blowing, the secondary system extracts most of the emissions that are not captured by the primary ventilation system. Subsequent treatment of the evacuated gases is usually performed by means of a bag filter or an ESP.

Primary ventilation and dedusting systems at BOF operations

During oxygen blowing, converter gas is released from the converter. This gas contains carbon monoxide (CO) and large amounts of dust (mainly consisting of metal oxides, including heavy metals), relatively small amounts of sulphur oxides (SO₂) and nitrogen oxides (NO_x). In addition, very small amounts of PCDD/F and PAH are emitted (see Table 7.3 in the previous section).

Generally, two systems can be used to recover energy from the converter gas:

- partial/full combustion
- suppressed combustion.

In the full (or open) combustion system, the process gas from the converter furnace is combusted in the flue-gas duct. An opening between the converter furnace and the primary (or converter gas) ventilation allows the entrance of ambient air and thus allows for a partial or full combustion of the converter gas. In this case, the process gas contains approximately 15 – 20 kg dust per tonne of liquid steel and approximately 7 kg carbon monoxide per tonne of liquid steel. Energy is recovered by using the sensible heat in a waste heat boiler. Note that open combustion systems have a large flow (500 – 1000 Nm³/t LS) compared to suppressed combustion systems (50 – 100 Nm³/t LS). This is due to the introduction of air into the BOF gas (converter gas) duct.

When suppressed combustion is applied, a retractable water-cooled skirt is lowered over the mouth of the converter. In this way, carbon monoxide combustion in the flue-gas duct is suppressed and the carbon monoxide can be recovered. The absence of nitrogen (given that air is excluded) means higher oxygen blowing speeds are possible and thus process time is reduced.

The chosen type of recovery influences the emissions.

BOF gas (converter gas) must be classified as a lean gas in terms of its calorific value and Wobbe index, but belongs to the group of rich gases when considered in terms of its combustion properties (and particularly, its combustion temperature). The composition of the converter gas varies with the process used, the recovery method and, specifically, the oxygen volume (see Table 7.5).

Table 7.5: Composition and characteristics of BOF gas

Parameter	Unit	Average value (¹)	Variation range
Composition			
CO	vol-%	72.5	55 – 80
H ₂	vol-%	3.3	2 – 10
CO ₂	vol-%	16.2	10 – 18
N ₂ + Ar	vol-%	8.0	8 – 26
Characteristic			
Density	kg/Nm ³	1.33	1.32 – 1.38
Lower calorific value	kJ/Nm ³	9580	7100 – 10100
Theoretical flame temperature	°C	2079 (²)	
Specific air demand (wet)	Nm ³ /Nm ³	1.81	1.34 – 1.90
Specific off-gas quantity (wet)	Nm ³ /Nm ³	2.43	
⁽¹⁾ Combustion gas figures refer to conditions downstream of the gasholder at a temperature of 15 °C, a gauge pressure of 60 mbar, barometer level 1013 Pa and a humidity of 100 %. ⁽²⁾ With total humidity and 0 °C. Source: [200, Commission 2001].			

Figure 7.11 shows the BOF gas collection in the case of suppressed combustion. It illustrates how the CO content of BOF gas, which is a key parameter for the utilisation, changes with time. On account of its low CO content and for safety reasons, the BOF gas generated during the start and the end of blowing (a few minutes each) is not collected but flared after dedusting [363, Eurofer 2007].

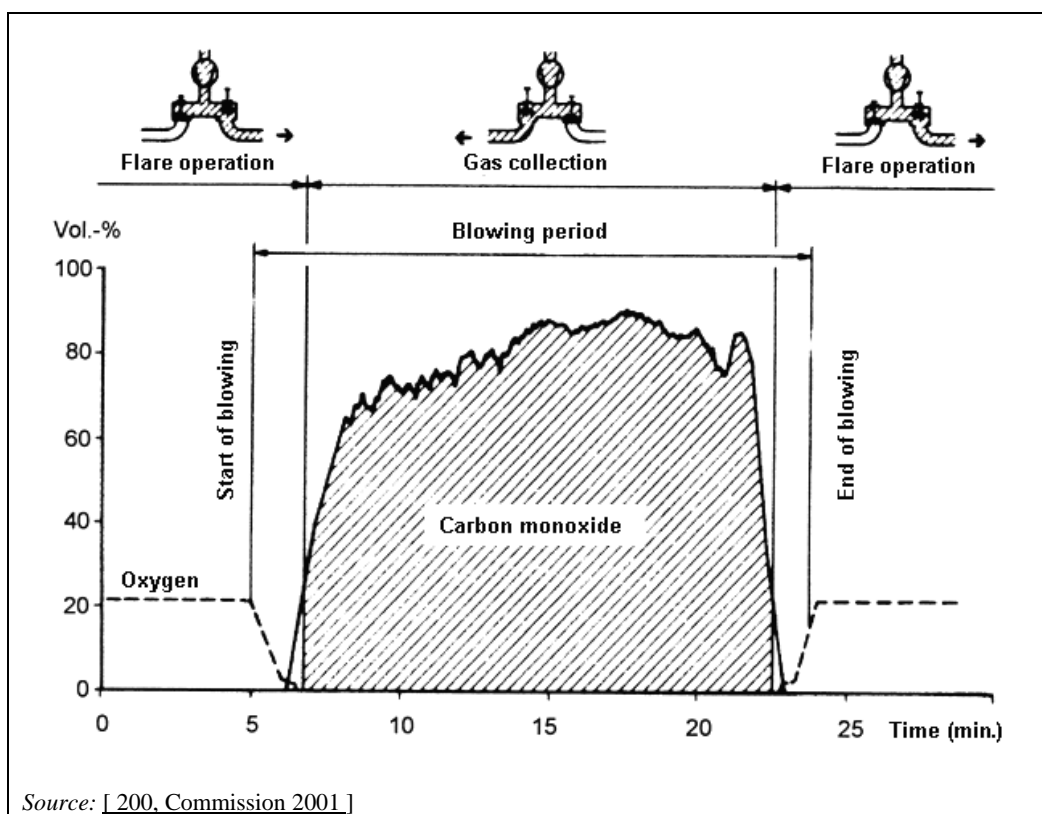

Figure 7.11: BOF gas collection in the case of suppressed combustion

Dust is usually removed from BOF gas by means of venturi scrubbers but also by dry or wet electrostatic precipitators. When suppressed combustion is employed, the venturi scrubbers may achieve a dust concentration of 5 – 10 mg/Nm³ in the grid gas (higher concentrations up to 50 mg/Nm³ are also possible amongst others depending on the particulate size distribution). This

corresponds to 1 g/t LS. The iron content of the dust recovered is 42 – 75 %. The dust in the grid gas is emitted at the site of incineration of the grid gas [363, Eurofer 2007]. Before and after blowing, the comparatively small amount of collected off-gas flow is flared off as shown in Figure 7.11 and Figure 7.23.

When full combustion is employed, dust emissions to the atmosphere are in the range of 25 – 100 mg/Nm³ after treatment. As a result of the much higher flue-gas flow of open combustion systems, this figure corresponds to dust emissions of up to 180 g/t LS. Table 7.6 summarises the emissions to air from a BOF with suppressed combustion after abatement, if there is no other indication.

Table 7.6: Specific emission values to air from a basic oxygen furnace with suppressed combustion after abatement, if there is no other indication

Component		Specific emission value	Unit
Flow of primary (BOF gas) ventilation	Flow of primary (BOF gas) ventilation	65 000 – 300 000	Nm ³ /h
	Full combustion	500 – 1000	Nm ³ /t LS
	Suppressed combustion	50 – 120	Nm ³ /t LS
Dust from oxygen blowing	Unabated	15 – 20	kg/t LS
	After primary (BOF gas) dedusting	0.3 – 55	g/t LS
	Filtered dust/sludge	12 – 23	kg/t LS
Flow of secondary ventilation		1300 – 4800	Nm ³ /t LS
		300 000 – 3 441 000	Nm ³ /h
Dust from charging and tapping	Unabated	200 – 1000	g/t LS
	After secondary dedusting	2 – 60	
	Not caught by enclosure	8 – 120	
Dust from secondary dedusting	Filtered dust/sludge	0.1 – 1.2	kg/t LS
(Heavy) metals	Al	0.60 – 0.68	g/t LS
	As	0.00 – 0.02	
	Cd	0.07 – 0.20	
	Cr	0.00 – 0.04	
	Cu	0.04	
	Fe	2.8 – 83	
	Hg	0.00 – 0.02	
	Mg	1.45 – 2.40	
	Mn	2.7 – 60	
	Pb	1.5 – 2.9	
Zn	8.2		
Sulphur oxides (SO ₂)		0.4 – 5.5	g/t LS
Nitrogen oxides (NO _x)		5.0 – 20	g/t LS
Carbon monoxide (CO)		7.0 – 16	kg/t LS
Hydrogen fluoride (*)		0.008 – 0.01	g/t LS
PAH (Borneff 6)		0.08 – 0.16	mg/t LS
PCDD/F		<0.001 – 0.11	µg I-TEQ/t LS
(*) Whenever fluorspar (CaF ₂) is added as a flux in hot metal desulphurisation, emissions of fluorides may be much higher.			
NB: LS = (Crude) Liquid steel.			
Source: [65, InfoMil 1997] [365, Eurofer 2007] [372, Czech TWG member 2008].			

Note that gradations between suppressed and full combustion exist; some plants employ full combustion while other plants employ partially suppressed combustion and other plants still fully suppress BOF gas combustion. In some cases, the BOF gas is not recovered but flared. However, suppressed combustion and subsequent BOF gas recovery is the most common process. In the case of suppressed combustion a large gas tank is required for a continuous use with controlled BOF gas quality. There also has to be local use of the recovered gas. The absence of the aforementioned prerequisites explains why there are still some basic oxygen steelmaking plants in the EU without BOF gas recovery [363, Eurofer 2007].

The lance hole is an important aspect in dust emissions. As the oxygen lance needs to be retractable, dust in the flue-gas duct may escape through the lance hole reaching the building atmosphere. The shielding and blowing of steam or inert gas can prevent these emissions. PAH emissions can be reduced by using tar-free refractories.

7.2.2.1.3 Other emission sources in the BOF process including secondary metallurgy and continuous casting

Other emissions as mentioned in Sections 7.2.2.1.1 and 7.2.2.1.2 in the BOF process occur during:

- tapping operations (i.e. ladles, ladle furnaces, converters and other equipment used in secondary metallurgy)
- degassing
- refractory preheating (ladle, tundish, degasser)
- the handling of additives
- continuous casting.

Some of the above-mentioned processes are connected with the secondary ventilation and dedusting system.

Dust releases from the various processes are in the range of 1 – 275 g/t LS [38, EUROFER BOF 1997]. Emissions to air after abatement are in the range of 0.1 – 50 g/t LS.

Concerning the production of leaded steel (see Section 7.3.2.3) emissions occur during the addition of lead into the ladle which contains liquid steel. The resulting off-gas is sucked off and normally treated in a bag filter especially for this waste gas to achieve a low residual dust content (<5 mg/Nm³). But the ladle itself is not gas tight and thus there are also fugitive emissions which are not caught but can be of considerable significance. Information on flow and Pb emissions is not available. Such Pb emissions are typical for BOF plants for long products with Pb alloyed steels for automatic, computerised numerical control (CNC) cutting machines [363, Eurofer 2007].

7.2.2.1.4 Diffuse emissions from the BOF processes

Diffuse emissions occur from all of the above-mentioned processes whenever the emissions are not fully captured. Diffuse emissions should in any case be avoided as much as possible. For this reason, the primary and, in particular, the secondary extraction system should be optimised. Usually the evacuation flow of secondary dedusting systems is quite high. An efficient measure to prevent or reduce diffuse emissions and to limit the needed extraction flows is to capture the emissions as close as possible to the emissions source. An additional extraction device at the roof is generally considered to be less cost-efficient than extraction at the source. But as already mentioned, it is not always possible to capture all of the dust, therefore, a roof extraction system might be an efficient option in environmental terms, in order to reduce the total emissions from a steel plant.

As seen in Table 7.7, large gas volumes have to be treated with comparatively low emission concentrations. However, worldwide, only a few plants apply roof extraction.

Diffusely emitted particulates are partially deposited in the production halls or are being emitted via openings in the roof from open doors and windows.

Today, no standardised measurement technique for roof emissions exists so that the estimation of these emissions varies widely. In Table 7.7 the results of measurements according to VDI 2463 part 7 for the emitted dust via the roof are shown. Although an efficient secondary ventilation and dedusting system is used with hoods close to the emissions sources and an extraction flow of 300 000 – 1 000 000 m³/h, a considerable amount of dust is still emitted via the roof openings. Related to the average steel production, the specific dust emissions are approximately 100 g/t. In general, roof emissions are estimated to be in the range of 8 – 120 g/t crude liquid steel. Some process conditions, e.g. slopping from the converter, can result in temporarily higher emission values. The actual emissions depend mainly on the capture efficiency and the charging sequence of scrap and hot metal [363, Eurofer 2007].

Table 7.7: Measurements of roof dust emissions from basic oxygen steelmaking

Unit	PM ₁₀ (mg/m ³)	Total dust (mg/m ³)	Gas flow (m ³ /h)	Total dust mass stream (kg/h)
Roof above charge preparation hall ⁽¹⁾				
Roof opening 1	1.8	3.7	1 112 000	4.1
Roof opening 2	1.5	4.4	1 199 000	5.3
Roof opening 3	2.2	4.5	1 089 000	4.9
Average:	1.8	4.2		
Total:			3 400 000	14.3
Roof above converter hall				
Roof opening 1; (with two converters in operation)	NA	2 – 13	1 430 000 – 2 120 000	5 – 26
Average of 10 daily mean values	NA	7.2	1 980 000	14.3
Roof opening 1; (with one converter in operation)	NA	2 – 22	1 430 000 – 2 120 000	5 – 46
Average of 10 daily mean values	NA	11.3	1 980 000	23.4
⁽¹⁾ Measurements carried out in July and August 2005 according to VDI 2463 part 7. NB: – These measurements were continuous measurements over a period of 10 days in the case of the converter hall. For the charge preparation hall, six one hourly samples were taken at two days. – NA = Data not available. Source: [151, TÜV Süd Industrie Service GmbH 2005]				

In one BOF plant where no secondary dedusting system was applied the diffuse dust emissions during the hot metal reladling at one pouring stand were reported to be four tonnes per year and during charging and tapping of one converter to be 56 tonnes per year [359, Netherlands 2007].

7.2.2.2 Waste water

[363, Eurofer 2007]

Water is used for the following purposes:

- scrubbing water from BOF gas treatment
- scrubbing water from the wet dedusting of desulphurisation
- water from vacuum generation
- water from direct cooling from continuous or ingot casting.

In order to optimise the use of waste water in integrated steelworks single flows can be mixed and subsequently treated together (see Section 2.4). In such cases, information about the composition of waste water from a single production step might not be available [363, Eurofer 2007].

Waste water from BOF gas treatment

BOF gas is treated either wet or dry. In the case of wet cleaning, waste water is produced which is normally recycled after treatment. This treatment is very often performed in two steps: separation of coarse particles ($>200 \mu\text{m}$ grain size) followed by sedimentation in circular settling tanks. Flocculating agents are added to improve sedimentation.

The purpose of electrical flocculation is to eliminate small and slowly settling particles by means of an electrical field. Particles with the same polarity tend to repel each other, thus decelerating the sedimentation process. In electrical flocculation, the surface of the particles is discharged when passing the electrical field which enables the agglomeration of particles.

The electrical flocculation system consists of several segments that are installed in the middle of the settling tank near the waste water inlet. Each segment consists of one anode and four cathode pipes. A DC current is conducted from the anode to the cathodes via the waste water, thus generating an electrical field.

The capacity of settling tanks is remarkably increased and no chemical flocculants are needed. The process also has an anti-scaling effect which prevents the sedimentation of particles on the surfaces of the settling tank [363, Eurofer 2007].

The sludge is dewatered by means of rotary vacuum filters, chamber filter presses or centrifuges. Representative data about flow and quality of the treated waste water discharged from the circuit (overflow) are not available.

Waste water from vacuum generation

For the vacuum treatment, the usual specific process water flow from vacuum generation ranges from 5 – 8 m^3/t LS vacuum treated. In a few cases, the specific process water demand is higher; in one case 41 m^3/t LS (see Table 7.3). This water is almost fully recycled. It should be mentioned that not all of the liquid steel has to be vacuum treated. Therefore, the weighted specific overall waste water output from vacuum treatment is 1.3 m^3/t LS. Data on composition and treatment or recycling are not available [140, Eurofer 2009] [363, Eurofer 2007] [365, Eurofer 2007]. Usually this waste water is treated together with other streams from the rolling mill(s) where they are located in the direct vicinity.

Waste water from continuous casting

Emissions to water from continuous casting machines are generated by the direct cooling system. This is used for the direct cooling of slabs, blooms, billets and the machines. The waste water contains mill scale (1 – 3 g/l) and oil/grease. This water is very often treated together with waste water from rolling mills where they are located in the direct vicinity. The amount of waste water strongly depends on local conditions and water management. The specific water demand for continuous casting is usually between 5 and 35 m^3/t LS [72, N.N. 2005]. The amount of waste water which can arise from continuous casting is up to 2 m^3/t LS.

7.2.2.3 Process residues such as wastes and by-products

The various solid residues resulting from basic oxygen steelmaking are compiled with their specific quantities in Table 7.8 [363, Eurofer 2007] and show the results of an inquiry from European oxygen steelmakers.

Table 7.8: Kind and specific quantity of solid residues resulting from oxygen steelmaking

Generated solid material (waste/by-product/residues)	Specific quantity (range) (kg/t LS)
Desulphurisation slag	3 – 21
BOF slag	85 – 165
Slag from secondary metallurgy	9 – 15
Slag from continuous casting	4.0 – 5
Spittings	2.8 – 15
Fine and coarse dusts	0.75 – 24
Mill scale from continuous casting	2.3 – 6.4
Rubble	0.05 – 6
NB: LS = Liquid steel. Source: [363, Eurofer 2007] [365, Eurofer 2007].	

From Table 7.8, the following percentages can be derived: BOF slag: approximately 80 %, desulphurisation slag: approximately 10 %, slag from the secondary metallurgy: approximately 7 % and slag from continuous casting: approximately 3 % [363, Eurofer 2007].

The slag from basic oxygen furnace (BOF) make up the largest share as shown in Table 7.9.

Table 7.9: Production of BOF and secondary steel slags

Steel slags	Amount (ktonnes)	(%)
BOF slag	9424	87.3
Secondary steel slag including desulphurisation and secondary metallurgy	1368	12.7
Total	10792	100
NB: Data from 2004 and related to the following EU countries: AT, BE, DE, DK, ES, FR, FI, LU, NL, UK, SE, SK. Source: [174, Euroslag 2006].		

Desulphurisation slag

Desulphurisation slag is a heterogeneous slag which is only partially melted. The composition of desulphurisation slags strongly depends on the used desulphurisation agents. An example of the composition of such a slag is presented in Table 7.10.

Table 7.10: Chemical composition of slag from hot metal desulphurisation

Parameter	Concentration (wt-%)	Parameter	Concentration (wt-%)
CaO	27.0	MnO	≤0.5
SiO ₂	18.0	P ₂ O ₅	≤0.2
Al ₂ O ₃	8.0	Cr ₂ O ₃	≤0.1
MgO	10.0	Free CaO	≤5
Total Fe	20.0	S	≤4
Metallic Fe	15.0	CaO/SiO ₂	1.5
Source: [363, Eurofer 2007].			

The relatively high sulphur content and unsatisfactory mechanical properties do not make desulphurisation slag ideal for reuse. It is normally recycled to the sinter mix of the integrated steelworks or partially used for landfill construction or for noise protection barriers. It is also landfilled (see Figure 7.12) [363, Eurofer 2007]. New investigations showed that the slag can be used as sulphur-containing soil conditioners, so there could be a new application for this kind of slag.

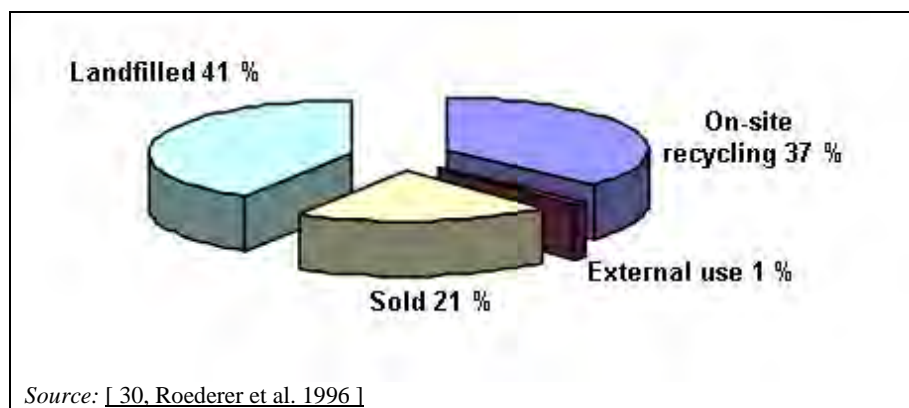

Figure 7.12: Fate of slag from hot metal desulphurisation in the EU

BOF slag

The chemical composition of BOF slag depends on the processes employed (see Table 7.11).

Table 7.11: Examples of chemical composition of BOF slags

Process	LD-AC	LD1	LD2	LD3	LD4
CaO	50.0	50.0	52.4	51.4	44.2
Free CaO	≤7	≤10	8.2	4.8	<0.2
SiO ₂	9.0	15.0	12.6	14.8	23.7
CaO/SiO ₂	4	2.5			
Al ₂ O ₃	≤2	≤2	1.6	1.3	1.6
MgO	≤3	≤3	3.1	4.1	2.1
Total Fe	12.0	16.0			
Metallic Fe	≤1	≤1			
FeO			12.6	12.7	12.2
Fe ₂ O ₃			11.7	10.8	11.6
MnO	2.0	≤4	4.3	4.9	2.4
Cr ₂ O ₃	≤1	≤1	0.4	0.31	0.16
TiO ₂			0.5	0.9	0.7
V ₂ O ₃			0.33	0.29	0.12
P ₂ O ₅	15.0	≤2			

NB: — Values in wt-%.
 — LD-AC = Linz-Donawitz-Arbed-CRM process.
 — LD = Linz-Donawitz process (four examples).

Source: [46, Geiseler 1991] [363, Eurofer 2007] [365, Eurofer 2007] [385, Malmberg et al. 2005].

The mineral composition of these slags is different and very site-specific as shown in Table 7.12.

Table 7.12: Three examples of the range of mineral constituents of converter slags

Mineral	Tricalcium silicate	Dicalcium silicate	Dicalcium iron oxide	Spinels	Wüstite	Lime
Formula:	3 CaO·SiO ₂	2 CaO·SiO ₂	2 CaO·Fe ₂ O ₃	MeO·Me ₂ O ₃	FeO	CaO
LD slag 1	0	40	30	0	20	10
LD slag 2	20	35	25	0	15	5
LD slag 3	0	70	0	20	10	0

NB: Values in wt-%.
Source: [365, Eurofer 2007].

Most of the BOF slag is used as an aggregate in road construction as base/sub-base, in asphalt mixtures and in water way construction (in hydraulic engineering, e.g. to stabilise shores). But there is also a percentage of BOF slag that is still put to landfill due to market conditions.

Steel slag can also partially be used as a lime source in the sinter mix or directly in the blast furnace burden or in the BOF as well (internal use). This is partly restricted due to the limited amount of phosphorus allowed in the hot metal. A considerable amount of slag is still used as a fertiliser and a liming agent in agriculture because of the relatively high free CaO content [363, Eurofer 2007].

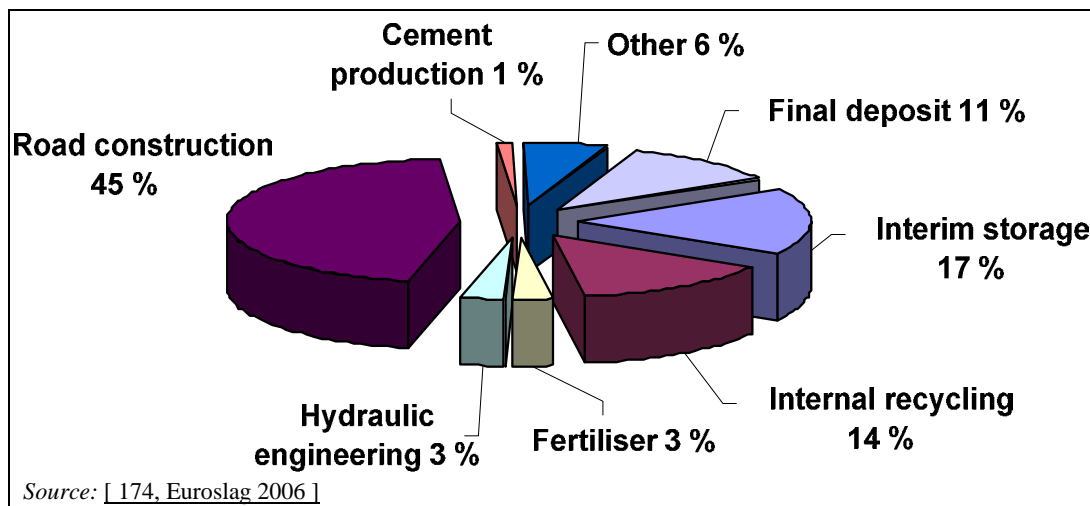
**Figure 7.13: Use of steel slags in Europe in 2004**

Slags from secondary metallurgy

The composition of secondary metallurgy slag is quite different and a very wide range of compositions can be found because they depend on the production technology and on the kind of steels produced.

The slag from secondary metallurgy represents a small proportion of residues from steel shops as shown in Table 7.9.

The mineral composition of secondary slags is different and site-specific. Table 7.14 shows the range for the composition of secondary steelmaking slags.

Table 7.13: Major mineral constituents of secondary metallurgical slags

Secondary metallurgy slag		
Name	Mineral	Formula
Beta dicalcium silicate	Larnite	$\beta\text{-Ca}_2\text{SiO}_4$
Gamma dicalcium silicate	Ingesonite	$\gamma\text{-Ca}_2\text{SiO}_4$
Calcium magnesium silicate	Bredigite	$\text{Ca}_7\text{Mg}(\text{SiO}_4)_4$
Calcium fluoride silicate	Cuspidine	$\text{Ca}_4\text{F}_2\text{Si}_2\text{O}_7$
	Spinel	$\text{Me}^{2+}(\text{Me}^{3+})_2\text{O}_4$
Calcium aluminium oxide	Mayenite	$\text{Ca}_{12}\text{Al}_{14}\text{O}_{33}$
Magnesia	Periclase	MgO
Calcium oxide	Lime	CaO
NB: Me = Combination of metals with valence 2 and 3 (e.g. Mg^{2+} , Al^{3+}).		
Source: [365, Eurofer 2007].		

Table 7.14: Range for the chemical composition of secondary steelmaking slags

Parameter	Lower limit (wt-%)	Upper limit (wt-%)
CaO	20	65
FeO	0.1	20
SiO ₂	1	40
MgO	2	20
Al ₂ O ₃	0.5	40
P ₂ O ₅	<0.01	1
Mn	0.03	7.7
Ti	0.02	3
Cr	<0.01	2.6
F	<0.01	10
S _{total}	<0.05	4
Source: [220, Eurofer 2008].		

Dust and sludge from BOF gas treatment

Coarse dust comes from the first dedusting step and fine dust from the second one. There are different systems for separating coarse and fine dust. This can be done in the process itself, e.g. by individual capture and separation of the dust of the consecutive dedusting steps or by treatment of the dust/sludge afterwards, e.g. coarse sludge can be recovered in a presettling tank and fine sludge in a second settling tank. The composition of coarse dust can be seen in comparison with the one for fine dust in Table 7.15.

Table 7.15: Composition of coarse and fine dust and sludge

Parameter	Coarse dust	Fine dust	Primary dedusting	Secondary dedusting	Sludge
Total Fe	30 – 85	54 – 70	38 – 85	32 – 63	48 – 70
Metallic Fe	72	20	Only poor information of the metallic content		
CaO	8 – 21	3 – 11	5.7 – 40	3.7 – 35	3.0 – 17
Zn	0.01 – 0.4	1.4 – 3.2	0.1 – 1.5 (*)	0.5 – 13	0.2 – 4.1
Pb	0.01 – 0.04	0.2 – 1.0	0.05 – 0.4	0.09 – 0.8	0.04 – 0.14
S	0.02 – 0.06	0.07 – 0.12	0.02 – 1.3	0.1 – 1.1	0.03 – 0.35
C	1.4	0.7	0.1 – 6.5	1.0 – 8	0.7 – 4.6
(*) Values of up to 8.5 wt-% are possible.					
NB: Values in wt-%.					
Source: [55, Harp et al. 1990] [64, IISI 1985] [365, Eurofer 2007].					

The coarse dust after preparation is usually returned to the oxygen steelmaking process or is recycled to the sinter strand or to cold bonded briquettes for use in blast furnaces. In the EU, a smaller percentage is sent to landfill (see Figure 7.14).

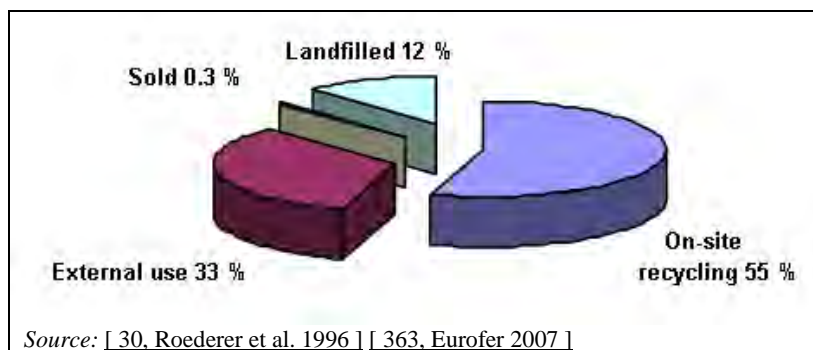

Figure 7.14: Fate of dust from dry BOF gas treatment

Table 7.15 indicates that fine dust compared to coarse dust contains significantly larger amounts of lead and zinc. The main source of these heavy metals is usually scrap charged to the BOF. In some cases it is possible to control the lead and particularly the zinc input with the scrap. However, it has been noticed that the availability of scrap with a low content of zinc (e.g. less than 1 %) has decreased continuously during the last years. Because of the zinc content, a lower part of the fine dust or sludge cannot be recycled but is put to landfill (see Figure 7.14) [363, Eurofer 2007].

Sludge is generated during hydrocyclonage and/or the sedimentation of the suspended solids in the scrubbing water circuit. This sludge can be 100 % recycled within the iron and steelmaking process if the zinc input via the scrap is strictly limited, i.e. back to the sintering plant or the BOF after cold briquetting (see Section 2.5.4.4.4). At many other steelmaking plants in the world, the sludge cannot be used and is either externally used in the cement making industry or stored or disposed of.

Spittings

Spittings occur from slopping caused by extreme foaming in the converter during blowing. The spittings have a high content of iron which is separated and recycled to the sinter plant. The rest of the slag (with less iron) is normally landfilled [363, Eurofer 2007].

Mill scale from continuous casting

The range of the composition of mill scale is shown in Table 7.16.

These by-products are normally recycled to the sinter strand [363, Eurofer 2007].

Table 7.16: Composition of mill scale

Parameter	Mill scale
Fe _{total}	33 – 72
Fe _{metallic}	NA
CaO	0.4 – 16
C	0.1 – 0.8
Oil	In practice the oil content of fine mill scale is usually <1 %. Contents up to 8 % might occur occasionally. Coarse mill scale contains almost no oil.

NB: — Values in wt-%.
 — NA = Data not available.
 Source: [150, Bakker, Wim 2008] [365, Eurofer 2007].

The total amount of dust/sludge and mill scale from oxygen steelmaking was 2.23 million tonnes in 2004 (covering 86 % of the EU-15 production).

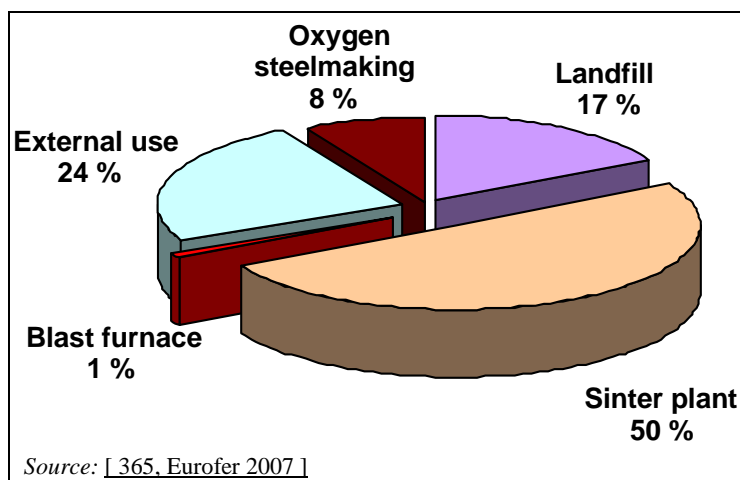

Figure 7.15: Use of dust/sludge and mill scale from oxygen steelmaking

Rubble

Rubble mainly consists of spent refractories. There are no representative data available on the fate of this solid waste/by-product. In some steelworks it is partly recycled to the BOF or reused for the production of new refractory material. In other cases, it is put to landfill [363, Eurofer 2007].

7.2.2.4 Energy consumption

Basic oxygen furnace (BOF)

In the BOF (converter), fuel is consumed to preheat and dry the converters after relining and repair. This thermal energy consumption totals to approximately 0.051 GJ/t LS. Electricity consumption is estimated at 23 kWh/t LS or 0.08 GJ/t LS. This figure includes the production of oxygen and the operation of the converters.

The process gas from the converter contains large amounts of carbon monoxide (CO) and is hot. When the energy from the BOF gas is recovered (waste heat recovery and/or BOF gas recovery), the BOF becomes a net producer of energy. In a modern plant, energy recovery can be as high as 0.7 GJ/t LS.

Continuous casting

Fuel consumption for preheating the ladle which contains liquid steel is estimated at 0.02 GJ/t LS. Electricity consumption of the casting machines is estimated at 0.04 GJ/t LS [65, InfoMil 1997].

7.3 Techniques to consider in the determination of BAT

This section describes techniques (or combinations thereof), and associated monitoring, considered to have the potential for achieving a high level of environmental protection in the activities within the scope of this document.

It covers process-integrated techniques and end-of-pipe measures. Waste prevention and management, including waste minimisation and recycling procedures are also considered. Furthermore, techniques for reducing the consumption of raw materials, water and energy are covered.

Annex III to the Directive lists a number of criteria for determining BAT, and the information within this chapter will address these considerations. As far as possible, a standard structure as shown in Table 7.17 is used to outline the information gathered concerning each technique, to enable a comparison of techniques and the assessment against the definition of BAT given in the Directive.

This section does not necessarily provide an exhaustive list of techniques which could be applied in the sector and other techniques may exist or may be developed, which could be considered for the determination of BAT for an individual installation.

Table 7.17: Information breakdown for each technique described in this section

Type of information considered	Type of information included
Description	Brief technical description using, as appropriate, pictures, diagrams and flow sheets.
Achieved environmental benefits	Main potential environmental benefits to be gained through implementing the technique (including energy, water, raw material savings, as well as production yield increases, energy efficiency, etc.).
Cross-media effects	<p>Potential environmental side effects and disadvantages to other media due to implementing the technique, including details of the environmental effects of the technique in comparison with others (advantages and disadvantages supported by data if available) in order to assess the impact of the technique on the environment as a whole. This may include issues such as:</p> <ul style="list-style-type: none"> • consumption of raw materials and water • energy consumption and contribution to climate change • stratospheric ozone depletion potential • photochemical ozone creation potential • acidification resulting from emissions to air • particulate matter in ambient air (including microparticles and metals) • eutrophication of land and waters resulting from emissions to air or water • oxygen depletion potential in water • persistent/toxic/bioaccumulable components in water or to land (including metals) • creation or reduction of (waste) residues • ability to reuse or recycle (waste) residues • noise and/or odour • risk of accidents.
Operational data	Actual performance data (including reference conditions, monitoring periods and monitoring methods) on emission levels, consumption levels (raw materials, water, energy) and amounts of waste generated. Any other useful information on how to operate, maintain and control the technique.
Applicability	Indication of the type of plants or processes in which the technique may or cannot be applied as well as constraints to implementation in certain cases, considering, e.g. plant age (new or existing), factors involved in retrofitting (e.g. space availability), plant size (large or small), techniques already installed and type or quality of product.
Economics	Information on costs (investment and operating) and any possible savings (e.g. reduced raw material or energy consumption, waste charges) or revenues including details on how these have been calculated/estimated. Economic information relevant to new build and retrofit to existing installations will be included. This should allow for identifying, where possible, the overall economic impact of the technique.
Driving force for implementation	Specific local conditions, requirements (e.g. legislation, safety measures) or non-environmental triggers (e.g. increased yield, improved product quality) which have driven or stimulated the implementation of the technique to date.
Example plants	Reference to the plant(s) where the technique has been implemented and from which information has been collected and used in writing the section. Indication of the degree to which the technique is in use in Europe or worldwide.
Reference literature	Literature or other reference material (e.g. books, reports, studies, websites) that was used in writing the section and that contains more detailed information on the technique.

7.3.1 Primary dedusting

Description

During oxygen blowing, BOF gas is generated. This gas is loaded with a large amount of dust. When the BOF gas is recovered for use as a fuel (see Section 7.3.7), the gas should meet certain requirements. When BOF gas is combusted in the flue-gas duct, the flue-gas is emitted and should meet local emission standards. Nowadays, most plants recover the BOF gas as a fuel. Full combustion systems introduce ambient air in the primary ventilation system to combust the BOF gas. This leads to a large flue-gas flow (2000 – 3000 Nm³/t LS); suppressed combustion systems only generate BOF gas (50 – 100 Nm³/t LS) (see Table 7.6). This results in significant differences in the dimensions of the primary dedusting facilities. The reduced waste gas flow rate characterising the suppressed combustion method results in a higher raw gas mass concentration, so that the efficiency of the dust recovery system must be increased for an identical clean gas dust load. From a dust recovery point of view, therefore, the suppressed combustion principle allows the use of dedusting systems designed for smaller volumetric flow rates which must nevertheless achieve higher dust recovery rates.

Primary dedusting is usually performed by venturi-type scrubbers (approximately 60 % of the plants) or dry and wet ESP. Prior to the venturi or the ESP, coarse particulates are usually removed by means of a deflector, etc.

Special attention should be paid to the emission of dust through the oxygen lance hole. Emissions from this hole can be as large as 50 g/t liquid steel. Emissions can be abated by means of a movable ‘mill stone’, which covers the hole during oxygen blowing and/or injection of inert gas (N₂/CO₂) or steam in the lance hole to dissipate the dust. Other designs of lance hole seals are also efficiently combined with lance cleaning devices.

Achieved environmental benefits

The achieved environmental benefits for each of the primary dedusting techniques are given below:

- dry dedusting and suppressed combustion: by applying an ESP, residual dust concentrations in the BOF gas may be reduced to as little as 10 mg/Nm³ (equivalent to 0.5 – 1.0 g/t LS), at any rate below 50 mg/Nm³. Before the gas is treated in the ESP, coarse dust is removed in a deflection zone and the gas is conditioned in an evaporation cooler
- dry dedusting and open combustion: dust emissions of the BOF gas may be reduced to 20 – 50 mg/Nm³
- scrubbing and suppressed combustion: applying a wet system first, coarse particles are removed in a wet separator, then fine particles are removed by venturi scrubbers. The dust concentration in the BOF gas after scrubbing is usually between 15 and 50 mg/Nm³, but can also be less than 10 mg/Nm³
- scrubbing and open combustion: when BOF gas is combusted in the flue-gas duct and cleaned by means of venturi scrubbers, the residual dust content is between 10 and 50 mg/Nm³.

Table 7.18 shows the achieved emission concentrations when using wet air abatement techniques.

Table 7.18: Achieved emission concentrations when using wet air abatement techniques

Parameter	Scrubber and wet ESP	Scrubber
PM	32.5	<42
CO	15	2
NO _x	25	
Hg		0.002
Cd, Tl	0.003	
As, Co, Ni, Se, Te	0.02	
Pb, Cr, Cu, Mn, V	0.4	
Pb		0.3
PCDD/F	0.04	
HF	<0.5	
NB: Values are in mg/Nm ³ except for PCDD/F that are in ng I-TEQ/Nm ³ . Values are annual averages. Source: [244, Plickert 2007].		

Cross-media effects

The extracted dusts and sludges may contain high concentrations of zinc, thus hampering their reuse. The use of zinc-poor scrap may enable recycling of the BOF sludge/dust to the sinter plant. Plants using dry ESPs may hot briquette the solid waste and recycle the briquettes directly into the steelmaking process (see Section 7.3.5).

In addition, wet dedusting implies the generation of a contaminated waste water flow.

Furthermore, the operation of a dedusting device consumes energy. In a suppressed combustion system, this would correspond to 0.001 – 0.005 GJ/t steel for a venturi scrubber and <0.001 GJ/t steel for a dry ESP.

In an open combustion system, this would correspond to 0.04 to 0.15 GJ/t liquid steel for a venturi scrubber and <0.005 GJ/t steel for a dry ESP.

Operational data

No data submitted.

Applicability

Primary dedusting can be applied at both new and existing plants. Some plants apply dry ESPs.

Economics

The investment costs for primary dedusting are between EUR 24 million and 40 million for a 1 Mt/yr steelmaking plant. The operational costs are from EUR 2 – 4/t LS.

For the examples the currency was converted into ECU in 1996 and for the review into EUR.

Driving force for implementation

In order to recover BOF gas by suppressed combustion, highly efficient purification is necessary. In the case of non-recovery or recovery by the combustion of BOF gas, the BOF gas should be treated in order to meet existing emission limit values.

Example plants

Example plants for the different dedusting systems are:

- dry ESP and suppressed combustion:
 - ThyssenKrupp Steel AG, Duisburg, Germany
 - LD Melt Shop 3, Voestalpine Stahl GmbH, Linz, Austria
 - Voestalpine Stahl GmbH, Donawitz, Austria

- Salzgitter AG, Salzgitter, Germany
- dry ESP and open combustion:
 - ArcelorMittal Ruhrort GmbH, Duisburg, Germany
- scrubbing and suppressed combustion:
 - oxygen steel plants; many European steel plants, e.g. Corus, IJmuiden, the Netherlands
 - ArcelorMittal
 - ArcelorMittal Bremen, Germany
 - ArcelorMittal, Dunkirk, France
 - ArcelorMittal, Fos sur Mer, France
 - ArcelorMittal, Florange, France
 - ArcelorMittal, Ghent, Belgium
 - ArcelorMittal, Avilès, Spain
 - Riva Group, Taranto, Italy.

Reference literature

[19, EC BOF 1995] [65, InfoMil 1997] [66, Joksch 1995] [76, Koeller 1995] [140, Eurofer 2009] [241, Poland 2007] [244, Plickert 2007] [363, Eurofer 2007]

7.3.2 Secondary dedusting

Dedusting of secondary emissions takes place at the following operations:

- reladling of hot metal from the torpedo ladle (or hot metal mixer) to the charging ladle
- collection and abatement of secondary emissions from BOF charging and tapping of liquid steel and slag from BOF (converters) and ladles and secondary metallurgy (see Section 7.3.2.1)
- hot metal pretreatment such as reladling, deslagging and desulphurisation of hot metals (see Section 7.3.2.2)
- handling of additives
- ingot and continuous casting (see Section 7.3.2.3).

7.3.2.1 Collection and abatement of secondary emissions

Description

Up until the early 1970s, oxygen steelmaking plants were built without secondary dust collection equipment. As a result, most secondary and subordinate primary source dust collecting installations are retrofits. The efficiency of such systems is highly dependent on local conditions. These play a particularly important role when it comes to the choice and design of the recovery system (enclosures, hoods, etc.). Determination of the waste gas flow rates often depend on local conditions and on the available space for installing piping systems, together with the possible size of the pipe cross-sections. For both new and existing installations, it is virtually impossible to determine recovery efficiency in advance with any degree of certainty. Any evaluation attempt is further complicated by the extreme difficulty in measuring the results. Even an optimum design and high waste gas flow rates for a complete technical waste gas collection will not guarantee that a 100 % capture rate can be consistently achieved on a long-term basis throughout the oxygen steelmaking process. Changing or atypical operating conditions and environmental factors, such as unusual airflows in plant buildings, may lead to the release of unrecoverable dust streams which will escape as unavoidable secondary emissions through the roof monitors.

The emissions from these sources related to the aforementioned BOF steelmaking processes are usually referred to as secondary off-gases and are dedusted by the central secondary ventilation and dedusting system. Sometimes the emissions from the hot metal pretreatment, the BOF charging and tapping and the secondary metallurgy are extracted and treated separately; usually

they are part of the secondary dedusting system [114, Remus, Rainer 2008] [182, Infomil 2009] [211, Remus, Rainer 2008].

Estimates of the quantity of secondary emissions vary between 2 and 200 g/t LS where the capture ratio of the secondary dedusting system is between 93 and 99.6 % [363, Eurofer 2007]. BOF charging and tapping operations contribute the most to these dust emissions. The given range differs from the figures given in Table 7.3. The data in Table 7.3 is based upon seven BOF plants whereas the aforementioned data reflect an estimation for the whole BOF sector. Another explanation for this and for the broad scatter range may be found in the fact that secondary emissions are difficult to delimit with any degree of certainty and the recovery measures employed are often not adequately known. This results in a grey zone of overlap between data on substances released and data on actual emissions following the implementation of appropriate off-gas capture and cleaning steps.

Hot metal pretreatment such as the reladling of hot metal and deslagging of hot metal

The transfer of hot metal from the torpedo ladle to the charging ladles takes place in enclosed stands. An integrated control room arrangement permits direct monitoring of the transfer process. The hot metal ladle travels below the mill floor level on a transfer car. This car carries a front sealing shield which seals off the vault at the hot metal pouring point, thereby forming an enclosed chamber. Where full enclosure is not feasible, it is possible to mount a fume hood over the ladle.

For the deslagging process, the ladle carrying the hot metal is tilted into its deslagging position while supported by a crane or a tilting cradle. The free cross-section of the hoods is restricted by suitable interior members to achieve higher intake velocities. The hoods can be of a travelling type so that they can serve several deslagging positions. The deslagging stands are normally separated by partitions which permit just enough travel for this operation. The openings are closed by sealing shields fitted on the car.

BOF charging and tapping of liquid steel and slag from BOF (converters) and ladles

During the charging of hot metal and scrap and the tapping of the BOF (converter), emissions of dust occur. Depending on the quality of the scrap used, various organic pollutants such as PAH, PCB and PCDD/F may occur resulting from the thermal degradation of organic materials (oils, paints, lubricants or plastics) may be present in the emissions from charging.

The primary ventilation system is in full operation only during oxygen blowing when the BOF converter is in a vertical position. The generated emissions during charging and tapping are captured by the secondary extraction system. Charging and tapping take only a few minutes which makes up about 10 % of the tap to-tap-time.

The secondary ventilation that forms the BOF operations usually consists of a canopy hood just above the converter mouth in a tilted position and a doghouse around the remaining 3/4 of the converter (see Figure 7.16). The canopy hood is preferably placed as close to the BOF as possible. In some existing plants, the construction does not enable a canopy hood close to the BOF. In this case, the canopy hood may be installed near the roof, resulting in lower efficiency, depending on conditions such as the size of the hood and the extracted volume or local flow conditions in the hall.

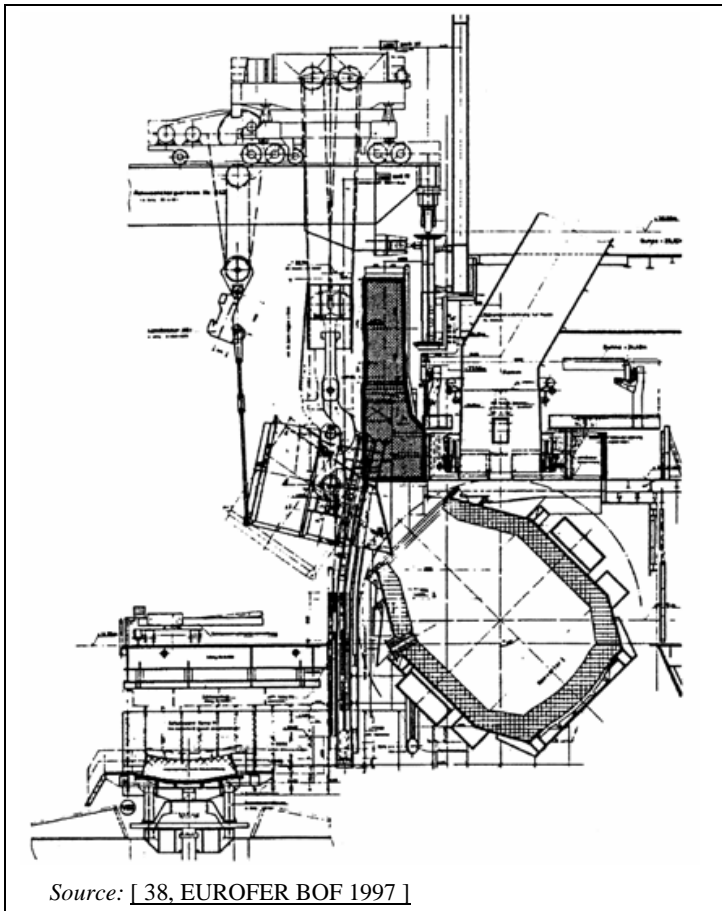

Figure 7.16: Collection of secondary emissions during the charging of hot metal and scrap to the BOF

The flue-gas flow from secondary dedusting is in the range of 300 000 – 3 441 000 Nm³/h and cleaning is usually performed by means of a bag filter, although dry ESP are also used. Some data from applied secondary dedusting systems and characteristics for the charging and tapping of emissions are summarised in Table 7.19.

Table 7.19: Data from applied secondary dedusting systems and characteristics for the charging and tapping of emissions

Plant	Capacity of vessel	BOF number	No of heat per month	Waste gas volume (Nm ³ /h)
1	112	2	1658	1250000
2	125	3	1983	372000
3	156	3	2179	3441000 ⁽¹⁾
4	240	2	866	300000
5	295	2	2322	1300000
6	330	2	974	1000000
7	264	3	1885	2119457
8	325	3	1698	720000
9	330	3	1125	393500

⁽¹⁾ This plant has two independent secondary dedusting systems and the given value is the addition of the two systems.
 NB: Table sorted by total vessel capacity (Capacity of vessel × BOF number).
 Source: [363, Eurofer 2007] [365, Eurofer 2007].

Secondary metallurgy

Emissions from secondary metallurgy can occur during the following processes:

- tapping operations (i.e. ladles, ladle furnaces, converters and other equipment used in secondary metallurgy)
- degassing
- refractory preheating (ladle, tundish, degasser)
- handling of additives

For two plants where the emissions from the secondary metallurgy processes are extracted separately and abated by bag filters the measured dust emissions concentrations are below 10 mg/Nm³/h [182, Infomil 2009] [211, Remus, Rainer 2008].

Achieved environmental benefits

Emissions are mainly influenced by the efficiency with which the dust generated during charging and tapping is evacuated.

The achievable degree of dust collection from secondary off-gases in basic oxygen steelmaking plants as shown in Table 7.20 are derived from shop floor and model tests, calculations and empirical observations and may vary according to the emission source considered and the specific process technique. The given ranges indicate that for hot metal pretreatment procedures like reladling and desulphurisation, and during converter blowing, the efficiency can be very high, up to an almost complete extraction. In contrast, the collection of emissions during the scrap and hot metal charging and the tapping of LS and slag is much less efficient.

In some plants (e.g. Japan), the entire roof is enclosed and the emissions are evacuated, achieving a total efficiency of 100 %.

Table 7.20: Achievable degree of dust collection from secondary off-gases in basic oxygen steelmaking plants

Hot metal pretreatment		BOF operation (converter)			
Reladling station	Hot metal pretreatment	Scrap charging	Hot metal charging	Blowing	Tapping of LS and slag
94 – 99 %	94 – 99 %	24 – 64 %	89 – 94 %	89 – 99 %	49 – 55 %
NB: Presuming that 100 % represents the total dust released during the BOF processing (equates what is technically achievable) than the lower value refers to what is the generally achievable percentage and the higher value to what is the maximum achievable percentage.					
Source: [38, EUROFER BOF 1997].					

With ESPs and bag filters point source emissions of below 5 g/t LS can be achieved for each of the aforementioned single emissions to air. As shown in Table 7.21 this corresponds to emission concentrations of 2 – 13 mg dust/Nm³.

Table 7.21: Achieved emission levels with secondary dedusting in basic oxygen steelmaking plants

Parameter	ESP	Bag filter
Dust	6	<2 – 13
Pb, Cr, Cu, Mn, V	0.1	
PCDD/F	0.03	
NB: Values are in mg/Nm ³ except for PCDD/F that are in ng I-TEQ/m ³ . Values are annual averages.		
Source: [182, Infomil 2009] [244, Plickert 2007].		

Cross-media effects

During secondary dedusting, 0.5 kg of solid waste per tonne of liquid steel is generated (up to 1.2 kg/t LS). Reuse of this iron-rich solid waste depends largely on the zinc content. Some plants may be able to reuse it and others have to dispose of it.

The operation of a ventilation and dust cleaning device requires energy. Secondary ventilation requires an evacuation capacity of approximately 300 000 – 3 441 000 Nm³/h. In one example, effective energy consumption is reported to be 13 MJ/t LS when a bag filter is applied. Other values reported are 0.72 – 7.2 MJ per 1000 Nm³ treated. The energy consumption mainly depends on the pressure drop and the capacity of the associated fan. Figure 7.17 gives the specific energy consumption for different dedusting operations in integrated steelworks. What can be seen is that the specific energy consumption for secondary dedusting is relatively high compared to other dedusting operations.

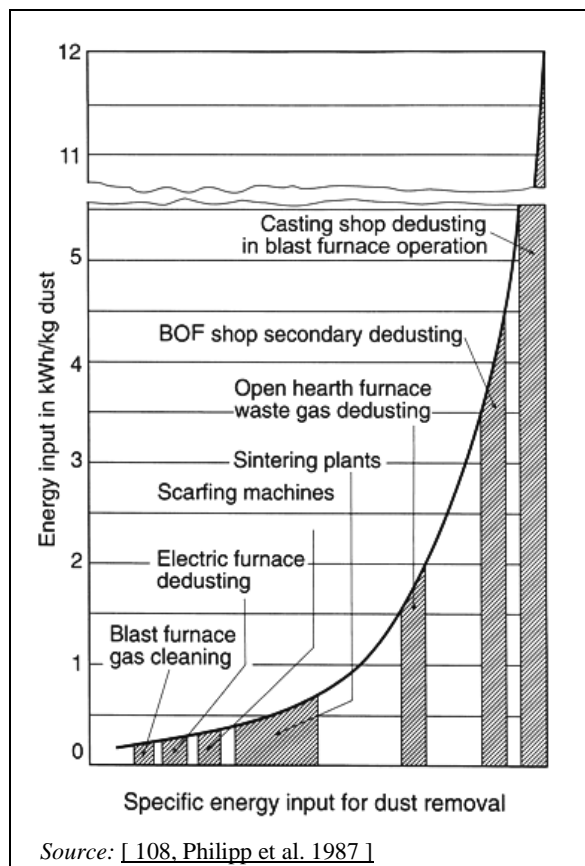

Figure 7.17: Specific energy consumption for different dedusting operations in integrated steelworks

Because of high evacuation rates, secondary dedusting systems can significantly contribute to noise emissions. Therefore, additional measures for noise protection such as concrete housing for the fans, extra insulation in the filter and damper in the stack may be necessary.

Operational data

Both bag filters and ESPs can be operated without problems. The most difficult aspects of secondary dedusting are evacuation efficiency, prevention of explosion in the ducts and the recycling of the solid wastes generated.

Applicability

Secondary dedusting can be applied at new and existing plants. In existing plants, the design of the plant may restrict the possibilities for proper evacuation.

Economics

Total investment for the collection and abatement of secondary emissions techniques was EUR 29 million in 2004, including noise protection measures.

The electricity consumption is approximately 13 MJ/t LS when a bag filter is applied. Thus, the operational costs, which depends highly on the electricity price, should be considered. Additional costs for maintenance, e.g. of the filter, are necessary. The costs were estimated in 1996 to be in the range of EUR 0.8 – 4/t LS.

Capital costs for the dedusting of secondary off-gases: EUR 10 million – 30 million. Implementing the complete dedusting of secondary off-gases costs up to EUR 30 million in an existing steelmaking plant with a production of 5 Mt liquid steel (reference plant: ArcelorMittal, Ghent, Belgium).

Driving force for implementation

The main driving force has been the prevention of visual emission during tapping and charging and better working conditions in the converter bay with an additional driving force being the need to contribute to an increased reliability of the charging cranes.

Example plants

Most European and worldwide IS plants apply secondary dedusting.

The BOF plant of Voestalpine Stahl GmbH, Linz, Austria consists of three BOF converters, each with a capacity of 158 tonnes of liquid steel. The total capacity of the BOF plant is 5.2 million tonnes of liquid steel per year. At the beginning of 2006, the existing secondary dedusting Units 1 and 2.1 (extraction volume of 1 million Nm³/h) were extended by the installation of Unit 2.2 (extraction volume of maximum 1 million Nm³/h). The secondary dedusting therefore consists of three separate blowers and filters handling the air extracted from a variety of extraction points including the hot metal relading, pretreatment, deslagging, charging and tapping of converters, the converter aisle and the charging hall (see Figure 7.18). The system ensures that even in the event that one dedusting system fails, the cleaning of the off-gases is assured. In this way, in the event of a system failure, the relevant emissions can be captured by the other secondary dedusting system. Consequently, a reduction of about 370 t/yr in dust emissions or about 300 t/yr in PM₁₀ emissions can be achieved.

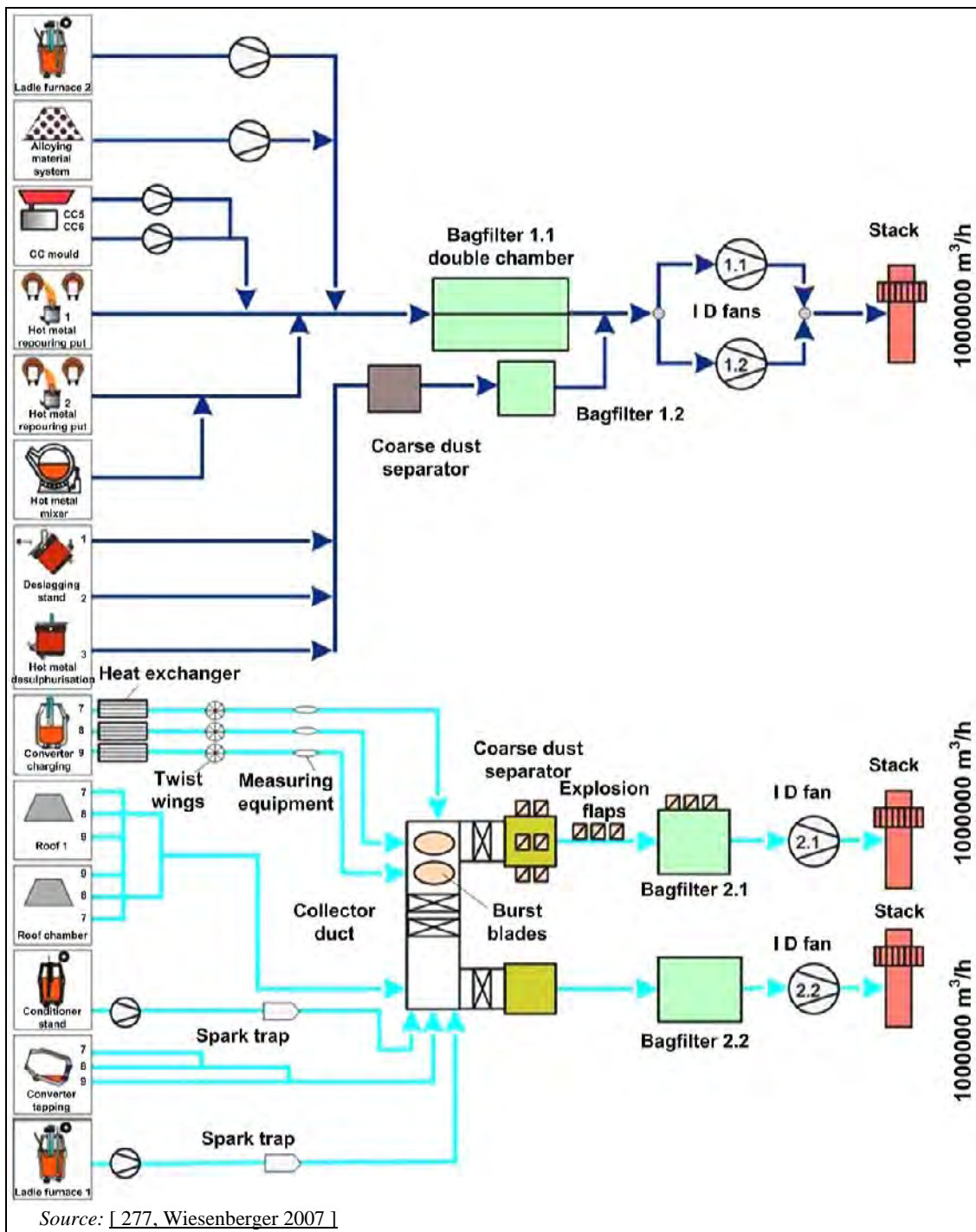

Figure 7.18: Example of a secondary dedusting system consisting of three separate blowers and filters handling the air extracted from a variety of extraction points

Table 7.22 gives the technical key figures for the above described secondary dedusting system.

Table 7.22: Technical key figures of a secondary dedusting system for Units 1 and 2 at the basic oxygen furnace of Voestalpine Stahl GmbH, Linz, Austria

Filter Units 2.1	Flow (million Nm ³ /h)	Filter Unit 2.2	Flow (million Nm ³ /h)
Total flow amount	1	Total flow amount	1
Hot metal charging	1	Tapping	0.2
Scrap charging	0.3	Ladle furnace	0.12
Oxygen blowing	0.18	Conditioning stand	0.06
Discharge	0.35	Roof fume exhaust system	0.6
Slag splashing	0.15		
Fan power	2680 kW		2680
Filter unit characteristics	9 chambers 9770 m ²		10 chambers 10850 m ²

Source: [277, Wiesenberger 2007] [361, Sigmund 2007].

Dust emissions of secondary dedusting Units 1, 2.1 and 2.2 are measured continuously. The annual average emission value for Unit 1 was 7.1 and for 2.1 was 3.7 mg/Nm³ in 2004, but for Unit 2.2, the annual average values were not available.

Recent daily average emission values are in the range of 0.3 – 10 mg/Nm³ for Unit 2.1 and about 0.5 mg/Nm³ for Unit 2.2, with single values of up to 4 mg/Nm³. Emissions of heavy metals and PCDD/F are measured discontinuously.

Figure 7.19 shows daily average emission values of the secondary dedusting Unit 2 at the basic oxygen furnace of Voestalpine Stahl GmbH, Linz, Austria over a period of three months.

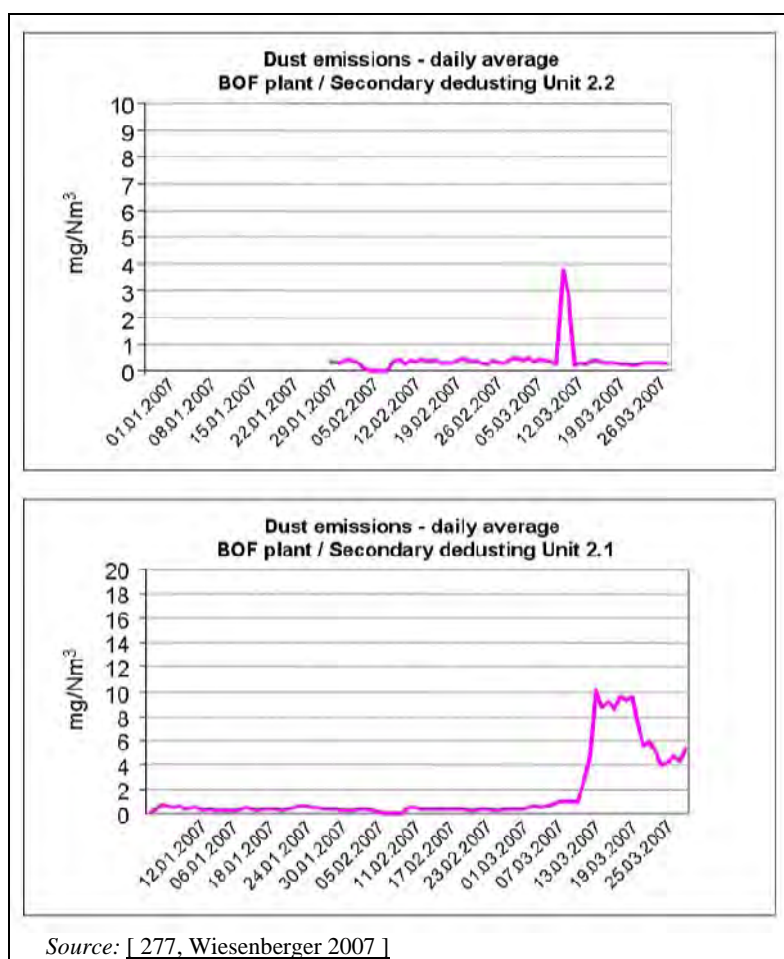

Figure 7.19: Daily average emission values of the secondary dedusting Unit 2 at the basic oxygen furnace of Voestalpine Stahl GmbH, Linz, Austria

Reference literature

[19, EC BOF 1995] [38, EUROFER BOF 1997] [65, InfoMil 1997] [244, Plickert 2007]
 [247, Netherlands 2007] [252, France 2007] [277, Wiesenberger 2007] [363, Eurofer 2007]
 [365, Eurofer 2007]

7.3.2.2 Dust abatement from hot metal pretreatment**Description**

During the three stages of hot metal pretreatment (desulphurisation, slag separation, and hot metal transfer and weighing), dust emissions occur. The specific dust emission factor (before abatement) varies from 110 – 830 g/t LS [38, EUROFER BOF 1997]. These emissions are captured (see Figure 7.20) and are usually treated by means of bag filters. The desulphurisation stands are largely of the enclosed type. Key dust recovery measures include the use of ladle lids, controlled introduction of desulphurising agents, integrated deslagging operations, use of an enclosure with an extraction system and the installation of a door moving in the process (see Figure 7.20).

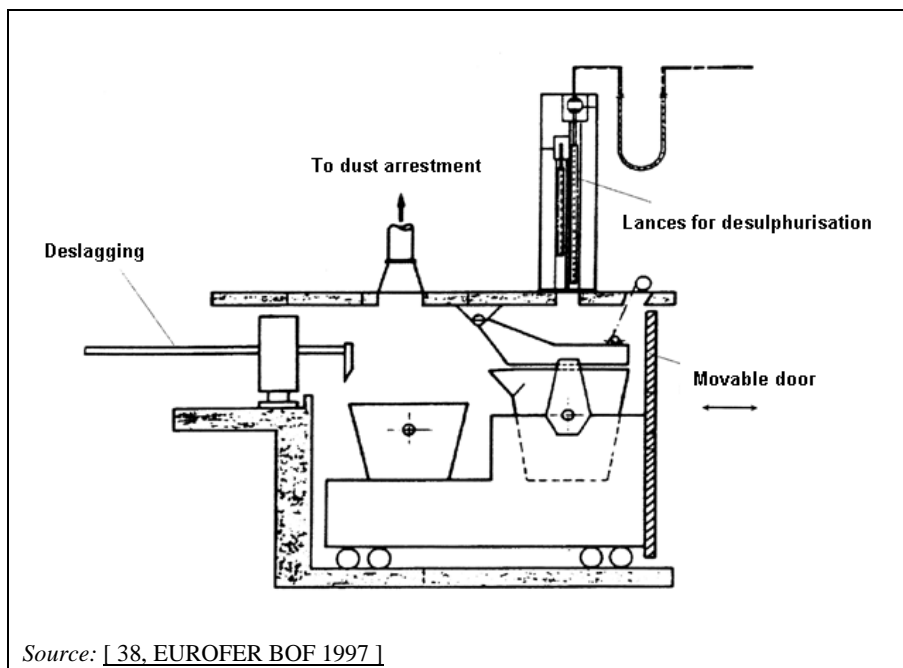

Figure 7.20: Dust arrestment at a hot metal desulphurisation stand

Extracted gases are loaded with up to 10 000 mg/Nm³ of dust. In some cases, dry electrostatic precipitators are applied.

An important feature is the evacuation efficiency of the ventilation system. The position of the suction hoods should be optimised in order to achieve a good extraction efficiency. Flue-gas flow for standalone dedusting is in the range of 30 000 – 1 million Nm³/h. With standalone dedusting systems, one may better control dedusting capacities and reuse different types of collected dusts. Today, in some plants, the dedusting of a desulphurisation device is part of a centralised secondary dedusting system and cannot be separately characterised. These systems have a flow capacity of between 300 000 and 2 200 000 Nm³/h. In some cases, the necessary extraction capacity can be adjusted based on different process conditions.

Achieved environmental benefits

When the dust is efficiently extracted and subsequently led through a bag filter (or an ESP), emissions of less than 1 – 10 mg/Nm³ (around 1 g/t LS) can be achieved.

At Corus, IJmuiden, the Netherlands deslagging and desulphurisation is carried out in an enclosed room which is extracted. The emissions are lead to a bag filter. Spot measurement results for dust emissions were 2 mg/Nm^3 in 2001 and 1 mg/Nm^3 in 2004.

A dedusting unit in Voestalpine Stahl GmbH, Linz, Austria has an extraction volume of about 1 million Nm^3/h and handles extraction points from hot metal pretreatment, hot metal desulphurisation, slag separation, hot metal handling and one ladle furnace. Emissions of dust are measured continuously. The annual average dust emissions level in 2004 was 7.1 mg/Nm^3 . Recent daily average dust emission values are in the range of $0.2 - 1 \text{ mg/Nm}^3$. Since 2006 SO_2 emissions are monitored continuously, too. Daily average emission values of SO_2 measured over a period of 3 months in 2007 are in the range of $20 - 100 \text{ mg/Nm}^3$. Monitoring data for both dust and SO_2 emissions over a period of three months are shown in Figure 7.21. However, single half-hourly mean emission values are up to 340 mg/Nm^3 .

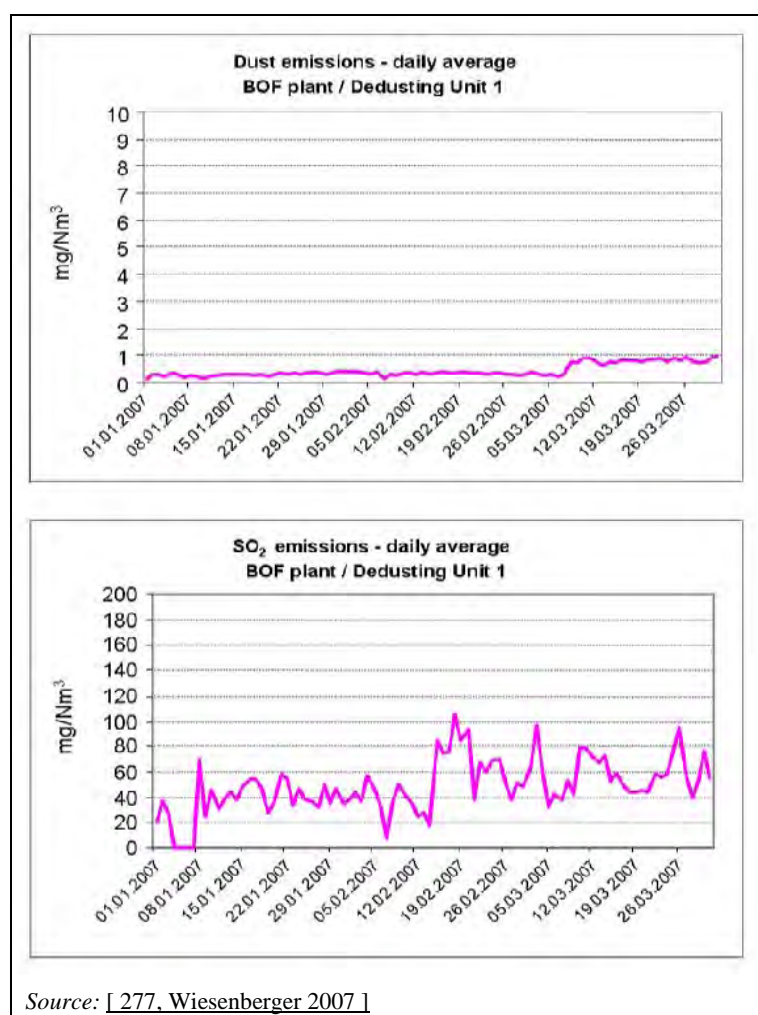

Figure 7.21: Daily average emission values of the secondary dedusting Unit 1 at the basic oxygen furnace of Voestalpine Stahl GmbH, Linz, Austria

Cross-media effects

The suction pumps consume energy and solid waste is generated which can be recycled into the sintering process (with a high Fe content). However, this will generate higher sulphur emissions in the sintering process. The composition of the dust from the hot metal desulphurisation unit is dependent heavily on the desulphurisation agent used. Alternatively the collected dusts can be recycled back to the BOF after cold briquetting (see Section 2.5.4.4) or being used in the cement making industry.

Operational data

Both bag filters and ESPs can be operated without problems.

Applicability

Dust abatement from hot metal pretreatment can be applied at both new and existing plants.

Economics

The investment for the application of this technique is approximately EUR 10 million. For the example, the currency was converted into ECU in 1996 and for the review into EUR.

Driving force for implementation

The main driving forces for the implementation of dust abatement from hot metal pretreatment have been the emission limit values or other legal requirements.

Example plants

Dust abatement during hot metal pretreatment is practised at many plants around the world.

Reference literature

[19, EC BOF 1995] [65, InfoMil 1997] [247, Netherlands 2007] [277, Wiesenberger 2007]
[363, Eurofer 2007]

7.3.2.3 Dust abatement for ingot and continuous casting

Description

Ingot casting shrouds should be used to protect the molten stream from oxygen contamination and reduce fume production to an insignificant level. If significant fume generation cannot be avoided, then fume collection and abatement should be used. As in the case of continuous casting, dedicated fume extraction equipment and cleaning is essential for leaded steels.

The oxy-gas cutting equipment used when cutting stainless steel is fed with iron powder. This produces sufficient brown fume to justify fitting fume extraction and abatement equipment, such as bag filters.

When casting leaded steels or when making lead additions, the top of the ladle and tundish can be covered. Careful consideration of injection plant design is required to minimise the risk of releasing lead fume. Fume collection should be provided around the mould area and for the secondary steelmaking unit itself, with extraction to a bag filter dedicated to treating lead-bearing fume.

If oxygen lancing is used to clear the nozzle, the fume should be confined and extracted, together with the other lead-bearing fumes. All dusts from leaded steel casting should be captured by dedicated bag filter systems.

Achieved environmental benefits

Table 7.23 shows the achieved emission levels for two casting installations with the application of bag filters.

Table 7.23: Achieved emission levels for two casting installations with bag filter application

Parameter	Ingot and continuous casting	Continuous casting
Dust	0.5	0.5
Ni	<0.002 ⁽¹⁾	0.014
Cr, Mn, V	<0.004 ⁽¹⁾	0.016
Ni, Cr, Mn, V	<0.006 ⁽¹⁾	0.03
Cr(VI)	<1 ⁽¹⁾	0.014
⁽¹⁾ Maximum values are based on half-hourly average values. NB: — Units are in mg/Nm ³ and are annual averages. — Data are for stainless steel production only. <i>Source: [244, Plickert 2007].</i>		

Cross-media effects

No data submitted.

Operational data

No data submitted.

Applicability

The given achieved emission values are taken from a casting installation in an EAF plant with stainless steel production only and with the application of bag filters. In principle, this technique is applicable to BOF plants for stainless steel production which have comparable conditions.

Economics

No data submitted.

Driving force for implementation

No data submitted.

Example plants

Bag filters at casting installations are applied in two German EAF plants for stainless steel production.

This technique is used in the UK.

Reference literature

[240, UKEA 2004] [244, Plickert 2007]

7.3.2.4 General techniques to prevent or control diffuse and fugitive secondary emissions

Description

General techniques to prevent diffuse and fugitive emissions from the relevant BOF process secondary sources include:

1. independent capture and use of dedusting devices for each subprocess in the BOF shop
2. correct management of the desulphurisation installation to prevent air emissions
3. total enclosure of the desulphurisation installation
4. maintaining the lid on when the hot metal ladle is not in use and hot metal ladles should be cleaned and undone of skulls on a regular basis
5. maintaining the hot metal ladle in front of the converter for approximately two minutes after putting the hot metal into the converter if a roof extraction system is not applied

6. computer control and optimisation of the steelmaking process, e.g. so that slopping (i.e. when the slag foams to such an extent that it flows out of the vessel) is prevented or reduced
7. slopping during tapping can be reduced by limiting elements that cause slopping and the use of anti-slopping agents
8. closure of doors from the room around the converter during oxygen blowing
9. continuous camera observation of the roof for visible emission
10. the use of a roof extraction system.

Achieved environmental benefits

Technique 1: This technique may help to optimise capture efficiency and encourage reuse possibilities. On the other hand combined secondary dedusting systems which most steel plants operate have an identical environmental performance like separate systems which is a single solution in one of the countries. In the case of energy consumption, combined systems have advantages.

Technique 2: Use of reagents, calcium oxide instead of calcium carbide in the desulphurisation process that leads to a decrease in PM and odour emissions and a different (more useful) composition of the generated slag (see Section 7.2.2.1.1).

Technique 3: This measure allows for a complete evacuation of the air through a dust collection system.

Technique 4: In using this technique, the ladles cool less and therefore form fewer bears occur; smoking ladles are prevented, leading to lower emissions of PM.

Technique 5: This measure allows extracting the smoke that may be emitted, if a roof extraction system is not applied.

Techniques 4, 5, 6 and 8: In one specific case by application of these techniques and an adequate control of emissions that could appear from the millstone (see Section 7.3.1) roof emissions from torpedo tapping below 0.14 kg/HM and for the whole BOF converter process below 10 g/t LS can be achieved [[359, Netherlands 2007](#)].

Technique 9: When the roof is continuously observed for visible emissions, changing of or not normal operating conditions that can occur and lead to an increase of the visible emissions are observed and recorded by the camera.

Cross-media effects

No data submitted.

Operational data

No data submitted.

Applicability

Technique 1: No data submitted.

Technique 4: This measure is applicable, if no roof extraction system is applied.

Economics

No data submitted.

Driving force for implementation

Continuous monitoring provides the option for early corrective action which can also have economic benefits.

Example plants

Techniques 4, 5, 6 and 8: Corus, IJmuiden, the Netherlands

Reference literature

[208, Lindfors et al. 2006] [241, Poland 2007] [247, Netherlands 2007] [249, Netherlands 2007] [359, Netherlands 2007] [360, Sick-Maihak 2006] [361, Sigmund 2007]

7.3.3 Treatment of waste water from wet dedusting**Description**

In most oxygen steelmaking plants, scrubbers are used to reduce emissions to air from the primary gas flow (BOF gas) (see Section 7.3.7). This potentially transfers pollution from air to water so the waste water generated is usually recycled and treated before discharge.

The water from the scrubbers mainly contains suspended solids; zinc and lead being the main heavy metals present.

A large part of the suspended solids in the scrubbing water circuit can be removed by means of hydrocyclonage and/or precipitation. After pH correction, most of the water can be recycled.

The bleed can be treated by means of precipitation and/or filtration prior to discharge.

Achieved environmental benefits

In Table 7.24, examples are given for the specific emissions to water from wet dedusting systems at oxygen steelmaking plants.

Table 7.24: Examples for the specific emissions to water from wet dedusting facilities at oxygen steelmaking plants

Parameter	Units	Suppressed combustion systems		
		Corus IJmuiden, NL ⁽¹⁾	Stelco LEW, Ontario, Canada	LTV Steel Cleveland Works, US
Discharge flow	m ³ /t LS	0.52	1.1	0.002
Suspended solid	g/t LS	20	5.5	0.0083
Zinc (Zn)	mg/t LS	73	210	0.36
Lead (Pb)	mg/t LS	31	110	0.057
⁽¹⁾ Emissions at Corus IJmuiden, the Netherlands relate to 1994 values. Source: [65, InfoMil 1997].				

The most effective measures for minimising waste water discharge are:

1. Increasing the recirculation rate of the scrubbing water. A high recirculation can be achieved by means of a two-stage sedimentation process in the scrubbing water flow with carbon dioxide (CO₂) injection prior to the second sedimentation step, in order to enhance the precipitation of carbonates. Note that the injection of CO₂ is only possible in systems operating suppressed combustion.
2. Treating the bleed. Although efficient recirculation can be achieved, a bleed is necessary to avoid the accumulation of certain minerals/salts. The bleed contains suspended solids (including zinc, lead, etc.) as the most important pollutant. The bleed is treated by sedimentation and filtration.

Cross-media effects

Sludge is generated during hydrocyclonage and/or the sedimentation of the suspended solids in the scrubbing water circuit. This sludge can be 100 % recycled within the iron and steel making process if the zinc input via the scrap is strictly limited, i.e. back to the sintering plant or the

BOF after cold briquetting (see Section 2.5.4.4.4). At many other steelmaking plants in the world, the sludge cannot be used and is either externally used in the cement making industry or stored or disposed of.

Operational data

No data submitted.

Applicability

A high recirculation efficiency and further treatment can be applied at both new and existing plants.

Economics

No data submitted.

Driving force for implementation

No data submitted.

Example plants

Examples for plants with a high degree of recirculation and treatment of bleed are:

Corus, IJmuiden, the Netherlands; ArcelorMittal, Ghent, Belgium; AlcelorMittal, Cleveland, United States.

Reference literature

[65, InfoMil 1997] [138, Theobald 1997] [363, Eurofer 2007]

7.3.4 Treatment of waste water from continuous casting

Description

Water is used in continuous casting machines for direct cooling of the slabs, blooms and billets. A contaminated process water flow is therefore generated. In many cases, this waste water is treated together with waste water streams from the hot rolling mills. After treatment, the water is recirculated.

The casting mould and the inner part of the rollers are usually cooled with water in a closed circuit and are not considered here.

The main pollutants are suspended solids and oil. The main measures to reduce discharges to water are a high rate of recirculation along with sedimentation and/or filtration of the bleed. Skimming tanks can be used to remove oil.

The spray water is commonly precipitated by sand filtration prior to or after cooling in an evaporative cooling tower. Sand filtration helps to ensure low levels of particulate and oil contamination to achieve satisfactorily prolonged operation of the secondary spray nozzles of the casting machine. The bleed from the open circuit to control the level of dissolved solids should be taken from downstream of the sand filtration plant to minimise the discharge of suspended solids and any oil/grease contamination. To prevent the clogging of the sand filter, oil skimming should be installed before the sand filters.

Achieved environmental benefits

In Table 7.25 examples are given for specific emissions to water from continuous casting.

Table 7.25: Overview of specific emissions to water from direct cooling systems at continuous casting

Parameter		Corus IJmuiden, NL ⁽¹⁾	Stelco LEW, Ontario, Canada	ArcelorMittal, Indiana Harbour Works, IN, US
Discharge flow	m ³ /t cast steel	0.04	1.4	0.076
Recirculation rate	%	98	78	99
Suspended solid	g/t cast steel	0.8 0.2 ⁽²⁾	26	1.4
Zinc (Zn)	mg/t cast steel	<1	–	8.0
Lead (Pb)	mg/t cast steel	<1	–	8.7
Oil	mg/t cast steel	20	2000	160
⁽¹⁾ Data refer to 2004.				
⁽²⁾ Data for 2007 indicate a trend downwards.				
Source: [65, InfoMil 1997] [135, Busink, R. 2009].				

Example of the concentration of pollutants in waste water from continuous casting after treatment at the basic oxygen furnace at ArcelorMittal, Bremen, Germany are given in Table 7.26 [362, Germany 2007] [363, Eurofer 2007]

Table 7.26: Example of the concentration of pollutants in waste water from continuous casting after treatment at the basic oxygen furnace at ArcelorMittal, Bremen, Germany

Parameter	Number of measurements	Mean value	Median	Max	Min	Standard deviation
Pb (µg/l)	33	3.03	2.00	16.00	<2.00	3.11
Cr (µg/l)	33	2.99	2.00	13.00	<2.00	2.17
Cu (µg/l)	33	6.03	5.70	15.00	0.50	2.74
Zn (µg/l)	33	87.12	62.00	340.00	<20.00	73.89
Cd (µg/l)	33	0.20	0.20	0.27	<0.20	0.01
Fe (mg/l)	33	0.59	0.14	8.50	0.05	1.63
Ni (µg/l)	33	21.88	22.00	37.00	11.00	6.15
N _{mineral} (mg/l)	31	5.09	5.07	7.16	3.29	1.21
AOX (µg/l)	33	41.06	40.00	66.00	21.00	11.00
Suspended solids (mg/l)	33	2.77	1.00	19.00	0.80	4.37
DOC (mg/l)	33	5.31	5.00	10.00	4.30	1.11
TOC (mg/l)	33	5.68	5.40	10.70	4.60	1.22
Mineral oil hydrocarbons (mg/l)	31	0.16	0.18	0.40	<0.10	0.07
Fish egg toxicity	8	1.25	1.00	2.00	1.00	0.43
NB: Random sample measurement data from Feb. 2000 to Nov. 2006. Figures in italics indicate that measurement values below the detection limit have been computed as the detection limit.						
Source: [260, Germany 2007] [362, Germany 2007].						

Cross-media effects

The sedimentation steps generate a sludge which contains iron which can be recycled into the sinter plant or by direct injection via tuyères in the blast furnace.

Operational data

No data submitted.

Applicability

A high recirculation rate and a treatment of the bleed can be applied at both new and existing plants.

Economics

No data submitted.

Driving force for implementation

No data submitted.

Example plants

ArcelorMittal, Indiana Harbour Works, Indiana, United States

Corus, IJmuiden, the Netherlands

ArcelorMittal, Ghent, Belgium

Voestalpine Stahl GmbH, Linz, Austria.

Reference literature

[65, InfoMil 1997] [240, UKEA 2004] [362, Germany 2007] [363, Eurofer 2007]

7.3.5 Dust hot briquetting and recycling with recovery of high zinc concentrated pellets for external reuse

Description

Whenever a dry ESP is applied as a means of cleaning BOF gas resulting from oxygen blowing, solid dust is generated. This dust has a high iron content (40 – 65 %) and can be used as a valuable raw material when the dusts are pressed to briquettes. Although coarse dust and fine dust are briquetted in the same plants, they are charged separately on account of their different properties (see Table 7.15). Briquettes from coarse dust contain about 70 % metallic iron and can be used as a substitute for scrap in the BOF. Briquettes from fine dust have about 7 % – 20 % metallic iron and can be used as a supplement for cooling ore [2, Auth et al. 1988]. Hot briquetting is performed in a hot briquetting plant (see Figure 7.22). First the dusts are heated up to 750 °C in a moving bed reactor by hot air and autothermic reactions. In the second step, briquettes are formed in a cylindrical press.

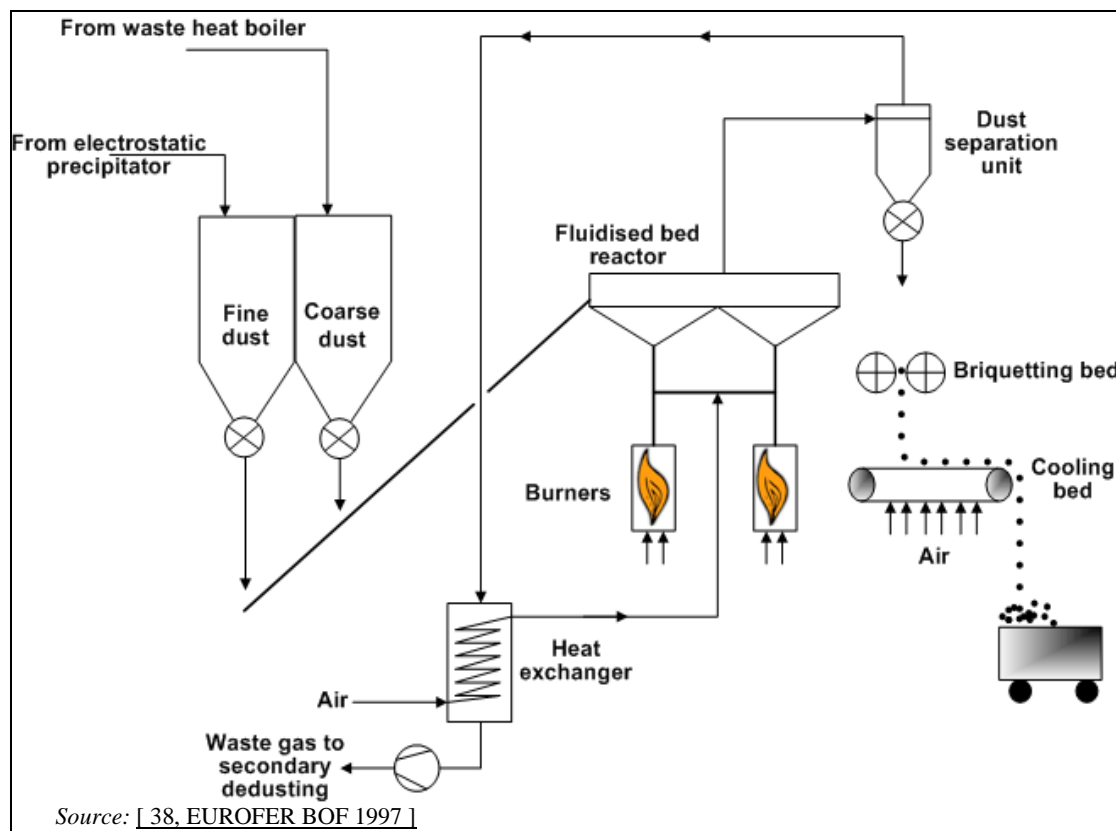

Figure 7.22: Facility for hot briquetting of dust from basic oxygen steelmaking plants

Recycling dust progressively enriches the zinc concentration. When the dust briquettes have reached an average zinc content of at least 17 % by weight, they are transported to external reprocessors for zinc recovery. For technical and economic feasibility, a zinc content of 20 to 24 % should be realised for zinc recovery, i.e. by mixing input materials.

As the zinc in the dust within this closed system is very unevenly distributed, dusts with zinc contents significantly above 17 % by weight also find their way into the cycle outlined here. This leads to considerable quantities of zinc being carried in the cycle unnecessarily, and being repeatedly reduced, vaporised, oxidised and briquetted in every successive cycle.

This sawtooth pattern of successive enriching and elimination of the dusts leads to a greatly fluctuating briquette charge in the BOF. This, in turn, not only influences the metallurgical work (slagging, build-up of dust accretions in the waste gas duct) but also has a significant impact on the thermal balance (hot metal/scrap). Regular analytic control is needed in order to ensure that the quality of the steel and slag produced is not impaired by any undue increase in the Zn content.

In order to optimise the process, an online technique for determining the level of zinc in dust in real time has been developed. This technology is referred to as LIBS (laser-induced breakdown spectroscopy). The device continuously measures the zinc content of the dust on the conveyor. Knowing the zinc content of the dust means it can be selected – where appropriate – for removal, pelletising and transporting it to the reprocessor.

Figure 7.23 gives a schematic overview of measures to optimise the recycling of dust from the basic oxygen furnace.

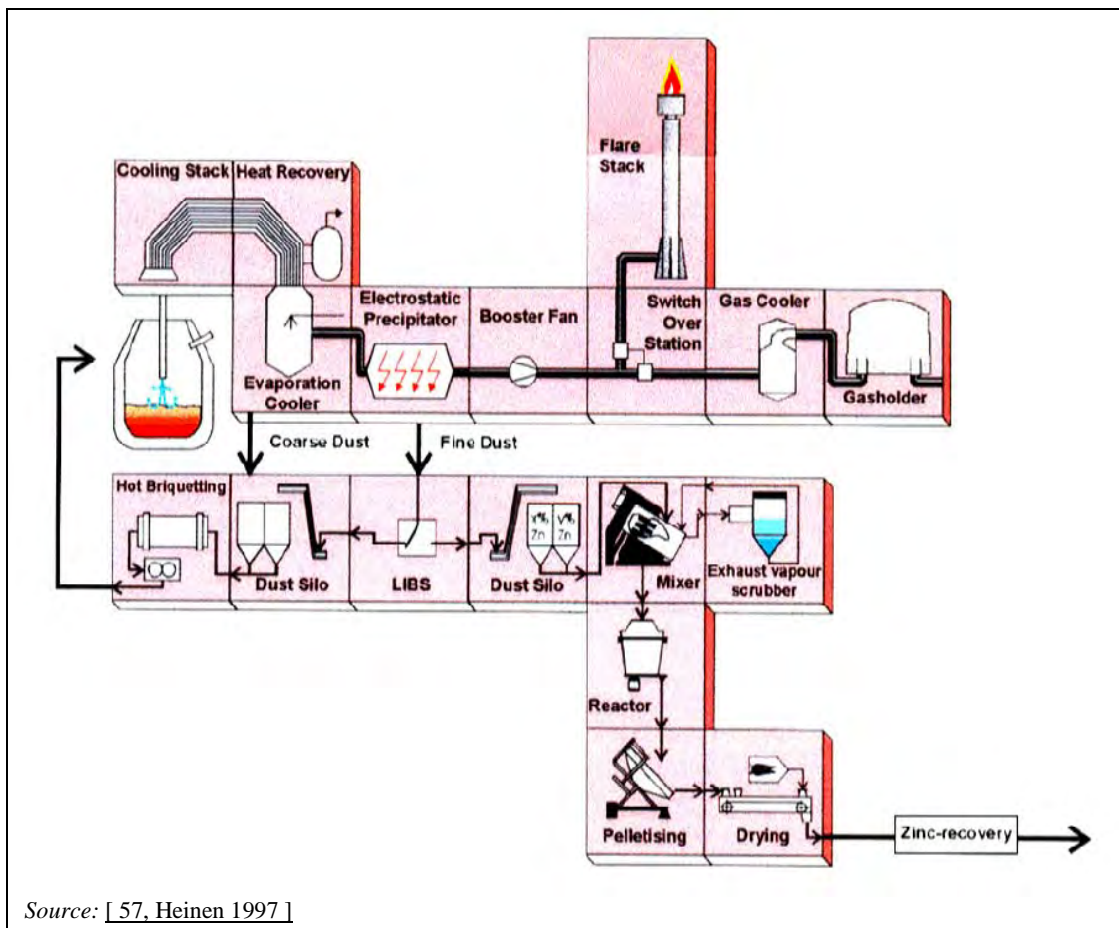

Figure 7.23: Schematic overview of measures to optimise the recycling of dusts from the basic oxygen furnace

The reason for pelletising fine dust is that even by employing bonding agents it cannot be briquetted. Moreover, pellets generally better meet customer requirements such as analysis, storage stability, freedom from dust, transportability and ease of handling. Additionally, the dust pellets can be optimised for further processing by adding reducing agents, other additives, etc.

Hot briquetting and the generation of pellets with a high zinc content for external reuse are described. Technically it is possible to extract the non-ferrous metals from this sludge and dust, after which the valuable cleaned solids which contain iron can be recycled into the ironmaking process. The non-ferrous metals extracted can be further processed by the non-ferrous metals industry.

The following methods have been applied:

- rotating hearth furnace processes
- fluidised bed processes
- circulating fluidised bed reactors
- high turbulence mixer processes
- plasma processes
- multi-role oxygen cupola furnaces.

External processes for zinc-rich sludge/dust exist on a commercial scale. This technique has become more and more common.

Achieved environmental benefits

When applying dust hot briquetting and recycling, the landfilling of solid wastes is avoided and valuable raw materials are saved. The amount of dust processed is approximately 10 – 20 kg per tonne of liquid steel produced. The overall iron yield is increased by approximately 1 %. A recycling rate of dusts of 100 % can be achieved.

Cross-media effects

The hot-briquetting plant requires energy but saves raw materials.

Operational data

No data submitted.

Applicability

This method is applicable when a dry electrostatic precipitation is used to clean the BOF gas. Some experiences have shown that the recovery of zinc by briquetting is not a solution in wet dedusting systems because of unstable sedimentation in the settling tanks caused by the formation of hydrogen (from a reaction of metallic zinc and water). Due to these safety reasons, the zinc content in the sludge should be limited to 8 – 10 %.

In the future it may be possible to treat sludges from venturi scrubbers as well, but this would require extra energy for the evaporation of water.

Economics

No data submitted.

Driving force for implementation

The main driving forces for the implementation of this technique are limited possibilities and high costs of dust disposal.

Example plants

- LD 3 Steelmaking plant, Voestalpine Stahl GmbH, Linz, Austria (at this plant the recovery of zinc in the form of pellets for external reuse is practised)
- Steel Plant Gwangyang Works, POSCO Iron and Steel Company, Republic of Korea
- Steel Plant Baoshan Iron and Steel Company, People's Republic of China;
- Dneprovsky Metallurgical Combine (DK), Ukraine
- LD 1, LD 2 steelmaking plants, Thyssen Krupp Stahl AG, Duisburg, Germany
- BHP, Newcastle, Australia.

Reference literature

[2, Auth et al. 1988] [57, Heinen 1997] [116, Rentz et al. 1996] [154, UN-ECE 1996] [363, Eurofer 2007]

7.3.6 Lowering the zinc content of scrap**Description**

A high zinc content in the blast furnace has an adverse effect on correct operation. Therefore, the recycling of material with a high zinc content is restricted. The dusts and sludges collected from the BOF gas dedusting device may contain relatively high concentrations of heavy metals, especially zinc (Zn) (see Table 7.15). This zinc mainly originates from the scrap charged into the BOF. The release of zinc can fluctuate strongly from one cast to another, according to the type of external scrap loaded and the blowing conditions. The same problem, but to a lesser extent, applies to lead (Pb), cadmium (Cd).

In order to meet dust recycling requirements, scrap with a low zinc content may be used. This excludes scrap which contains galvanised products.

Achieved environmental benefits

At some plants a strict policy on the use of scrap with a low zinc content is practised. The sludge from BOF gas dedusting has a zinc content of approximately 0.1 – 0.3 %, which allows 100 % recycling of the dust in the sinter plant.

Cross-media effects

This solution should be seen as a local solution. The overall effect on zinc emissions is probably zero, because large amounts of galvanised steel are produced worldwide which will lead to the generation of sludges with a relatively high zinc content when the steel becomes available as scrap in the steelmaking process. At most BOFs, zinc is mainly emitted from the converter in the first few minutes of oxygen blowing.

Operational data

This technique operates without problems.

Applicability

Application is possible at both new and existing plants. However, this measure strongly depends on the availability of scrap which is low in Zn, Pb and Cd and the economics of using this type of scrap. It is therefore not applicable in all cases and strongly depends on the scrap market. In the aforementioned example plant of Corus, IJmuiden, the Netherlands, the process is based on a low zinc content of the scrap. Zinc-coated scrap is not used because of the recycling of dust from the BOF in the BF. It should be applied preferably in plants without dust recycling systems as described under Section 7.3.5.

Economics

Scrap with a low zinc content is more expensive and increases the cost price per tonne LS produced. It is expected that scrap with a low zinc content will become increasingly hard to obtain. On the other hand, the use of low zinc scrap enables the recycling of the BOF gas cleaning sludges and dusts.

Driving force for implementation

No data submitted.

Example plants

Corus, IJmuiden, the Netherlands; British Steel, Scunthorpe, United Kingdom.

Reference literature

[13, Deckers et al. 1995] [65, InfoMil 1997] [105, Pazdej et al. 1995] [247, Netherlands 2007] [363, Eurofer 2007]

7.3.7 Energy recovery from the BOF gas

Description

Recovering energy from the BOF gas measure involves making efficient use of both the sensible heat and the chemical energy in the BOF gas. Previously, most of the chemical energy was dissipated by flaring.

BOF gas produced during oxygen blowing leaves the BOF through the converter mouth and is subsequently caught by the primary ventilation. This gas has a temperature of approximately 1200 °C and a flow rate of approximately 50 – 100 Nm³/t steel. The gas contains approximately 70 – 80 % carbon monoxide (CO) when leaving the BOF and has a heating value of approximately 8.8 MJ/Nm³.

Generally, two systems can be used to recover energy from the BOF gas:

1. *Combustion of BOF gas in the converter gas duct and subsequent recovery of the sensible heat in a waste heat boiler to produce steam*

This BOF gas can be fully or partially combusted by allowing ambient air into the gas duct of the primary ventilation system. Thus, the sensible heat and the total gas flow in the primary ventilation system increases and more steam can be generated in the waste heat boiler. The amount of air admixed with the BOF gas determines the amount of steam generated.

In a complete steelmaking cycle (approximately 30 – 40 minutes), oxygen blowing lasts for approximately 15 minutes. Steam generation, which is directly related to oxygen blowing, is therefore discontinuous.

2. *Suppression of BOF gas combustion and buffering of the BOF gas in a gasholder for subsequent use*

BOF gas combustion in the primary ventilation system can be suppressed by preventing the supply of ambient air from going into the system. This is usually done by lowering a water-cooled retractable skirt over the mouth of the converter. In this way, the carbon monoxide is retained and the BOF gas can be used as an energy source at other locations. The gas is cleaned to meet grid gas requirements and can be buffered in a gasholder. A waste heat boiler may be installed to recover the sensible heat which is present in the non-combusted BOF gas. It should be noted that BOF gas is not collected during the start and the end of blowing on account of its low CO content. During these periods, which last a few minutes, it is flared instead (see Figure 7.11).

There is a trend toward suppressed combustion followed by BOF gas recovery. There are two main reasons for this:

- suppressed combustion reduces the quantity of flue-gas and thus reduces the cost of fans and dust removal. The reduced waste gas flow rate typical of suppressed combustion results in a raw gas with a higher mass concentration. Thus for an identical clean gas dust concentration, a more efficient dust recovery system must be used (see also Section 7.3.1)
- large volumes of steam are obtained from full combustion systems. However, as the steam is produced discontinuously, it cannot always be fully utilised. The use of recovered BOF gas with suppressed combustion is much more flexible. The use of BOF gas in conjunction with blast furnace gas and coke oven gas as a third gas phase furnace product brings substantial advantages if it allows for the replacement of considerable amounts of primary energy resources, such as natural gas. At some plants, the BOF gas is primarily used in upgrading the blast furnace gas [66, Joksch 1995]. Coke oven gas and natural gas are only admixed in the mixing stations as a second and third priority (cascade control) [66, Joksch 1995].

Table 7.27 shows advantages and disadvantages of suppressed combustion with particular consideration for BOF gas utilisation.

Table 7.27: Advantages and disadvantages of suppressed combustion with particular consideration for BOF gas utilisation

Advantages	<ul style="list-style-type: none"> • Reduced volumetric waste gas flow rate • Larger dimensions of gas-carrying components to achieve more uniform velocities in the hoods • Reduced energy consumption of the waste gas fan • Reduced water requirement for off-gas cooling • Design of dust recovery systems for smaller volumetric off-gas flow rates • Off-gas utilisation possibility • Reduced gas release from effervescent melt conditions due to the arrangement of sealing skirts of different designs
Disadvantages	<ul style="list-style-type: none"> • Complex equipment technology with regard to safety engineering standards • Need for additional components • Additional safety engineering measures needed
<i>Source: [38, EUROFER BOF 1997].</i>	

The BOF gas composition in the case of suppressed combustion is shown in Table 7.6. When full combustion is applied, the CO content is much lower and CO₂ content is correspondingly higher.

Achieved environmental benefits

In Table 7.28, examples are given for steam generation in waste heat boilers at the basic oxygen steelmaking plants of Thyssen Stahl AG, Germany.

Table 7.28: Steam generation at basic oxygen steelmaking plants of Thyssen Stahl AG

Parameter	Unit	Ruhrort	Beeckerwerth	Bruckhausen
Capacity	(t LS/cast)	4 × 140	3 × 250	2 × 380
Air introduction factor (*)	–	>2.0	0.4	0.15
Flue-gas flow	(Nm ³ /t LS)	250	115	87
Steam generation	(kg steam/t LS)	380	130	80
(*) The air introduction factor indicates how much air is introduced in the flue-gas duct, i.e. a factor of 2 means that the amount of introduced air is two times the amount of the original BOF gas.				
<i>Source: [66, Joksch 1995].</i>				

Energy recovery from a full combustion system with a waste heat boiler is reported to be 80 % of the total outgoing heat. When suppressed combustion is applied, only 10 – 30 % (0.1 – 0.3 GJ/t LS) of the total energy output is recovered in the waste heat boiler [66, Joksch 1995]. Another 50 – 80 % is recovered as chemical energy (CO) in the BOF gas, depending on the air introduction factor. When the gas is flared and thus not recovered, this energy is lost.

In total energy recovery when applying suppressed combustion, BOF gas recovery and a waste heat boiler for the use of sensible heat can be as high as 90 % [1, Arimitsu 1995] [66, Joksch 1995].

When BOF gas is recovered, energy savings amount to 0.35 – 0.7 GJ/t LS, compared to flaring. A leak-free system, which was developed by Nippon Steel Corporation, leads to an energy savings of 0.98 – 1.08 GJ/t LS and an increased molten steel production of 0.4 % compared to flaring.

Cross-media effects

Recovering BOF gas requires proper cleaning of the crude gas in order to meet the grid gas requirements. When full combustion is applied, the flue-gas is directly emitted to the atmosphere. Overall emissions to air are reduced when suppressed combustion is applied. In addition, the (much) larger flue-gas flow from full combustion systems implies more expensive and relatively less efficient dust abatement.

The energy recovery may result in savings primarily of energy sources.

Recovery of BOF gas is potentially hazardous and requires strict safety precautions (explosions, carbon monoxide leakage, etc.).

Operational data

No data submitted.

Applicability

Both waste heat recovery and BOF gas recovery by suppressed combustion can be applied at new and existing plants. In some cases it may not be economically feasible or, with regard to appropriate energy management, not feasible to recover the BOF gas by suppressed combustion. In these cases, the BOF gas may be combusted with the generation of steam. The kind of combustion depends on the local energy management.

Economics

The investment required in 2007 was EUR 30.5 million for an ongoing project consisting of a gasholder of 80000 m³, blower fans, gas ducts, three way valves in the off-gas systems, security measures, erection and engineering, etc. About 80 % of the BOF gas will be recovered resulting in an annual energy savings of 2600 TJ/yr = approximately EUR 12/GJ investment. Payback is about five years taking into account the savings in the purchase of natural gas, exploitation costs, CO₂ emission credits, reduced flare losses, sales of gas to the electricity producer and reduced steam production.

Driving force for implementation

No data submitted.

Example plants

Energy recovery by means of full combustion systems or suppressed combustion systems is widely applied at oxygen steel plants around the world. There is a tendency towards suppressed combustion systems, mainly because of logistic advantages compared to full combustion systems.

Reference literature

[1, Arimitsu 1995] [65, InfoMil 1997] [66, Joksich 1995] [363, Eurofer 2007]

7.3.8 Online sampling and steel analysis**Description**

Oxygen steelmaking is a batch process. Every charge of hot metal should be refined until the required steel quality is achieved. In order to monitor progress, samples are taken from the steel bath for analysis. The results of the analysis are used to determine the additional time of oxygen blowing needed to achieve the required steel quality.

The latest dynamic modelling and monitoring systems reach a precision that makes sampling during blowing unnecessary. A control sample is then taken during the pouring period. This technique eliminates the emissions due to sampling.

It used to be necessary to interrupt oxygen blowing and tilt the BOF in order to take the sample. This was a time-consuming process and it increased emissions from the BOF. In a modern plant, samples are taken online during oxygen blowing by means of a sub-lance or a similar device. This enables the refining process to continue while the samples are being analysed. This shortens production cycle times and so increases productivity. Emissions are lower compared to the previous sampling method as the position of the BOF is not changed.

Achieved environmental benefits

Production time per batch is reduced so productivity is increased. Emissions to air are reduced as it is not necessary to tilt the BOF.

Cross-media effects

No cross-media effects are known.

Operational data

No data submitted.

Applicability

This technique can be applied at all new plants. Existing plants need a retrofit in order to install this sampling system.

Economics

Costs are probably reduced as a result of higher productivity.

Driving force for implementation

No data submitted.

Example plants

Most European plants apply online sampling and dynamic modelling.

Reference literature

[65, InfoMil 1997] [363, Eurofer 2007]

7.3.9 Increased energy efficiency in the steel shop by automatisation

Description

Two options for steel shop automatisation are included in this section:

- a) the automatic ladle lid system
- b) automated BOF tapping practice.

Technique a) The automatic ladle lid system

Steel ladles are used for secondary treatments and the transporting of liquid steel from the BOF converters to continuous casting. In normal practice, the ladles are not covered during ladle treatment and transportation, but a lid is commonly used to prevent extra heat losses during continuous casting. After casting and ladle maintenance, the ladles in operation are heated with burners, typically with coke oven gas or natural gas to keep them hot for the next heat.

At Raahe Steel Works, eight to nine ladles are in operation simultaneously. The ladles are equipped with lids which are removed only during the tapping of the BOF and during ladle treatments. No burners are needed to keep the ladles hot after ladle maintenance. BOF converters and secondary metallurgy stations are equipped with lid stands where the lid is automatically placed or removed on/off the ladle depending on the process stage. The system is a 'hinged lid' system, which also enables slag tapping after casting without removing the lid.



Source: [208, Lindfors et al. 2006]

Figure 7.24: Automatic ladle lid system

Technique b) Automated BOF tapping practice

By utilising the available sub-lance system, steel temperature and a carbon content estimate can be obtained without having to tilt the converter into a horizontal position. Hence, tapping can be commenced within 2 – 3 minutes after the end of blow, depending on the time for post-stirring. In 2004 approximately 75 % of the heats were tapped within three minutes. The tapping sequence, initiated by the operator, consists of the following automated steps:

- steel tapping
- slag coating, and if necessary also slag splashing
- slag tapping.

An infrared camera, which can be used to distinguish between steel and slag, shows when slag enters the tap stream and when to automatically terminate steel tapping.

Figure 7.25 shows a schematic of an automatic tapping system.

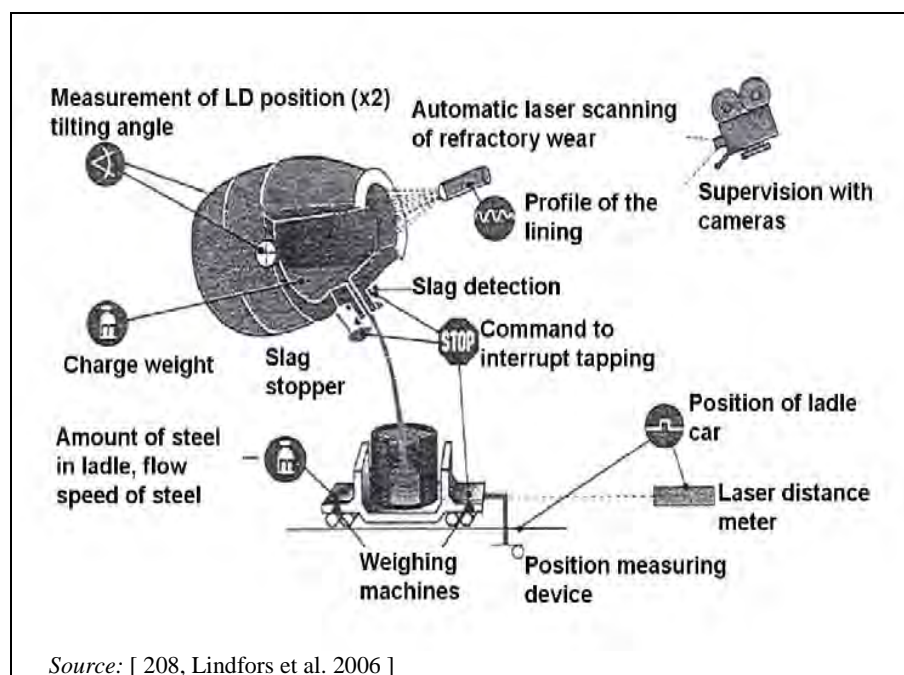

Source: [208, Lindfors et al. 2006]

Figure 7.25: Schematic of an automatic tapping system

Achieved environmental benefits

Energy efficiency is improved (improved temperature control) and there is less dust formation.

Technique a) The automatic ladle lid system

Because less heat is lost during ladle cycle time, the average tapping temperature has decreased by 10 °C. Lower tapping temperatures enable an 8 kg/t higher scrap rate at the BOF with no extra fuel added and thus higher productivity. Another possibility is to produce steel with 8 kg/t less hot metal which is equivalent to 15 kg/t reduction in CO₂ emissions. The deviation of tapping temperatures is 4 °C lower, which is significant for stable process control. Steel temperatures are more stable during the whole steelmaking process, which reduces interrupted casts at continuous casting. The ladles are practically free of steel and slag sculls. No extra energy is needed at ladle maintenance areas, which allows the use of coke oven gas at other applications in the steelworks. The lids reduce dust emissions and direct heat radiation from steel ladles during transportation. Refractory wear of converters and ladles is slightly improved.

Technique b) Automated BOF tapping practice

This technique shows several major environmental benefits:

- it lowers the aimed tapping temperature for steel by some 15 °C. This allows for an increased scrap ratio, hence a decreased hot metal ratio in the charge. With a 15 °C lower tapping temperature, it is possible to reduce the hot metal ratio by some 9 kg per tonne of crude steel, equivalent to a possible total reduction in CO₂ production at the plant of around 16 kg CO₂ per tonne of crude steel.
- by avoiding tilting the converter into a horizontal position for sampling after the end of blow, the emission of hot gases and dust are reduced.
- with accurate timing of the termination of the steel tap, less steel is left in the converter and tapped together with slag into the slag pot. Less steel in the slag pot results not only in a stabilised process yield, but also in fewer dust emissions when the pots are emptied.
- a higher degree of slag coating leads to a longer lining life and reduces the need for ceramic materials. A rough estimate is that automated tapping, in itself, has led to a 20 % increase in lining life.

The energy efficiency is not only improved by an overall increase in productivity due to shorter times between steel tapping, but also by a reduced tapping temperature, which can be utilised for an increase in scrap recirculation, as well as by an improved steel yield.

Cross-media effects

No negative cross-media effects have been recorded with this new practice.

Operational data

No data submitted.

Applicability

Technique a)

The automatic ladle lid system is in principle applicable to all steel plants, taking into account the specific characteristics of existing plants. The lids can be very heavy because they are made out of refractory bricks. The capacity of the cranes and the design of the whole building constrict the applicability in existing plants. There are different technical designs for implementing the system into the particular conditions of a steel plant.

Technique b)

Automated BOF tapping practice can be applied at any BOF plant which is equipped with systems for the fast and accurate recording of the temperature and carbon content of the steel at the end of blow, as well as for slag detection during tapping.

Economics*Technique a)*

The automatic ladle lid system gives the steel maker a significant reduction in production costs.

Technique b)

The automated BOF tapping practice is mainly related to increased productivity, decreased maintenance costs and reduced refractory wear.

Driving force for implementation*Technique a)*

The driving forces for the implementation of this technique are increased production, better process control with improved yield, increased energy efficiency and cost savings.

Technique b)

Increased productivity and increased scrap consumption result in the case of the automated BOF tapping practice. The driving forces for an increased degree of automation of the tapping practice include:

- stabilising and increasing steel production and increased time utilisation
- improved process control
- improved working environment
- increased lining life.

Example plants

An example plant for technique a) and b) is Ruuki, Finland.

Technique b) automated BOF tapping practice at SSAB Tunnpå AB's steel plant in Luleå, Sweden was gradually introduced during the late 1990s. The first step was the implementation of quick and direct tapping (QDT), followed by automation of the whole tapping sequence, including the tapping of slag.

Reference literature

[208, Lindfors et al. 2006]

7.3.10 Direct tapping from BOF**Description**

Normally, expensive facilities like sub-lance or DROP IN sensor-systems are used to tap without waiting for a chemical analysis of the samples taken (direct tapping). Ovako, Koverhar, Finland has developed a practice to achieve direct tapping without such facilities. In practice, the carbon is directly blown down to 0.04 % and simultaneously the bath temperature to a reasonably low target. Before tapping, both the temperature and oxygen activity are measured for further actions.

The reblow rate at the Ovako, Koverhar, Finland plant is today approximately 5 %.

Achieved environmental benefits

Through direct tapping, increased energy efficiency is achieved and positive environmental impacts are seen.

The advantage of direct tapping practice is mainly to increase energy efficiency. The bath cooling after blowing has reduced by 20 °C. At the same time, the tap-to-tap time is shortened by 20 %. That means a significant increase in productivity. Because of an improved thermal economy, the volume of scrap has increased by 5 % compared to non-direct tapping practices. This means a reduction of CO₂ emission by approximately 15 kg/t.

The lining life is increased by about 10 %. Because of the increased lining life and larger amount of recirculated material (scrap), a reduced environmental impact is also achieved.

Cross-media effects

No data submitted.

Operational data

No data submitted.

Applicability

The practice is principally applicable in BOF plants with certain preconditions. The realisation of the practice without extra facilities means several years of developmental work.

For succeeded direct tapping, some preconditions are needed, like a suitable hot metal analyser and slag stopping facilities. The availability of a ladle furnace makes the practice easier to realise.

Economics

The economic benefits are connected with increased productivity, reduced energy consumption and reduced refractory ware.

Driving force for implementation

Increased energy efficiency is the driving force for implementation of this technique. Other drivers are increased productivity, cost savings and a reduced environmental impact.

Example plants

Direct tapping has been in use at Ovako, Koverhar, Finland since 2001 for almost all steel grades and concerns nearly all steel qualities except some special steels. The share of direct tapping is today 99 % of all melts.

Reference literature

[208, Lindfors et al. 2006]

7.3.11 Near net shape strip casting

Description

Near net shape strip casting means the continuous casting of steel to strips with a thicknesses of less than 15 mm. The casting process is combined with the direct hot rolling, cooling and coiling of the strips without an intermediate reheating furnace used for conventional casting techniques, e.g. continuous casting of slabs or thin slabs. Therefore, strip casting represents a technique for producing flat steel strips of different widths and thicknesses of less than 2 mm.

The casting process can be divided into different techniques. All of them are characterised by moving moulds without the use of casting powder. Twin roll strip casting as a vertical casting technique and direct horizontal strip casting (which used to be called direct strip casting) are the ones with the greatest industrial interest.

An overview of twin roll and direct horizontal strip casting processes and further techniques is given in [141, Ferry, M. 2006] (see Figure 7.26).

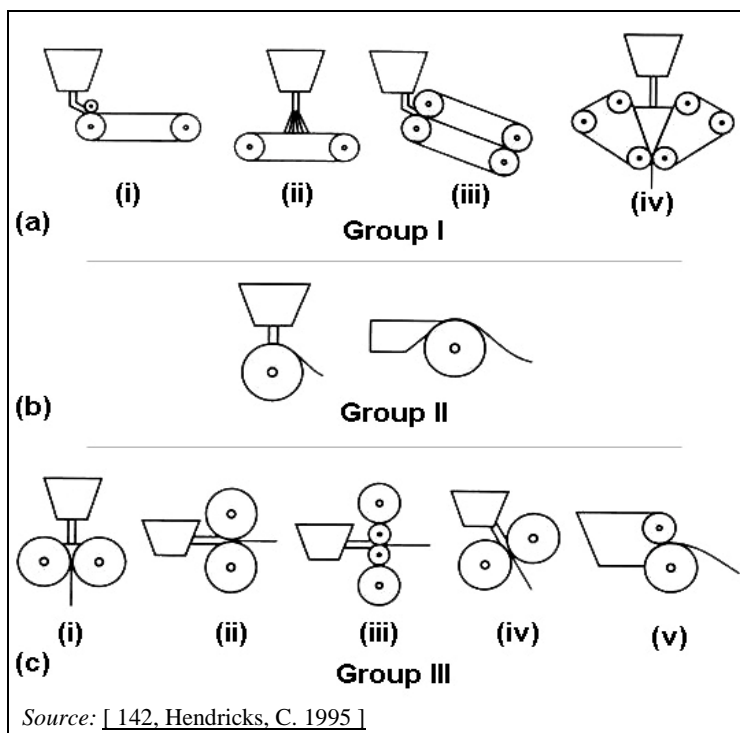

Figure 7.26: Possible classification scheme for the strip casting processes

Achieved environmental benefits

The achievable benefit for energy savings is essentially based on the fact that reheating is not necessary as well as on the reduced work for hot rolling. In comparison to conventional slab casting, additional energy for reaching the temperature necessary for hot rolling is not needed. Calculations with respect to energy consumption have already been done in the past. The relationship between primary energy consumption and CO₂ emissions for the different casting techniques is given in Figure 7.27 [141, Ferry, M. 2006] along with the main process steps. A reevaluation of the energy demand for strip casting is part of a running BMBF (Federal Ministry of Education and Research) project [146, Schäperkötter, M. et al 2009].

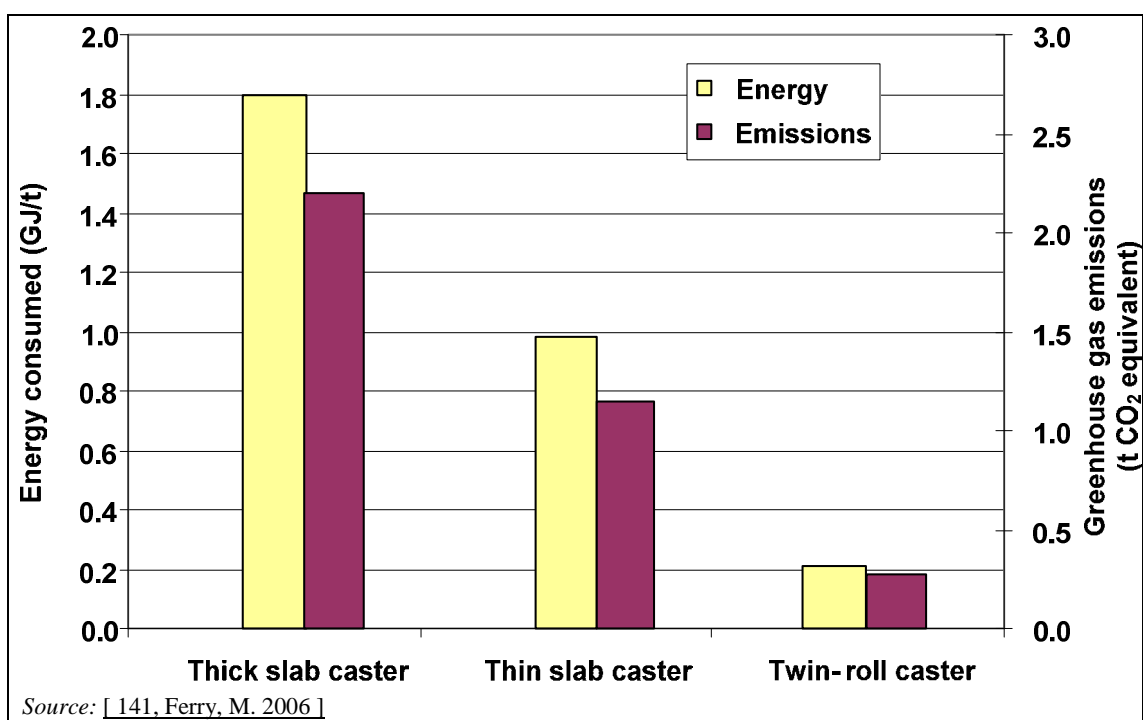

Figure 7.27: Relationship between primary energy consumption and CO₂ emissions (comparison of industrial scale plants) for different casting techniques

Cross-media effects

No cross-media effects were reported.

Operational data

Data on consumption levels are not available.

Applicability

The strip casting technique is applicable both at new and existing steel plants. The relatively small space needed (approximately 100 m in length) offers the potential to integrate a strip caster when retrofitting.

The casting process can be applied at both types of steel plants, BOF and EAF. Further metallurgical techniques are related to the steel grades, but not to the strip casting process.

The applicability depends also on the produced steel grades (for example: you cannot produce heavy plates with this process) and on the product portfolio (product mix) of the individual steelplant.

Economics

There are three main economic incentives for establishing the strip casting technique: the capital costs, the energy savings and the required area. Additionally, the technique is useful for a wide range of steel grades and the production capacity of a one line casting rolling machine is approximately 1.5 million tonnes/yr.

Driving force for implementation

The driving forces for the implementation of this technique are multifaceted:

- material forces: horizontal strip casting prevents impact due to the bending and straightening of the product. In particular, it is advantageous to produce grades with critical ductility properties at a high temperature by applying this technique. High alloyed steel grades (specifically those with a high Al content) can be produced because no interaction with casting powder occurs
- economic and environmental forces: the main economic reasons are hot charging of strips without reheating and reduced hot rolling work. Both items lead to decreased emissions.

Example plants

Strip casters (twin-roll caster) are operational at ThyssenKrupp Nirosta, Bochum, Germany (400000 t/yr); Nucor Crawfordsville, Indiana, US (400000 t/yr) and Nippon Steel, Japan. Upcoming projects are at Nucor Castrip Blytheville, Arkansas, US (500000 t/yr) and Posco Postrip Pohang, Korea (600000 t/yr) [149, Kemper, G. 2008].

The scheduled start-up for an industrial horizontal strip caster with a capacity of 500000 t/yr is 2010.

Reference literature

[141, Ferry, M. 2006] [142, Hendricks, C. 1995] [146, Schäperkötter, M. et al 2009] [149, Kemper, G. 2008]

8 ELECTRIC ARC FURNACE STEELMAKING AND CASTING

8.1 Applied processes and techniques

The direct smelting of materials which contain iron, such as scrap is usually performed in electric arc furnaces (EAF) which play an increasingly important role in modern steelworks concepts (see Figure 1.2). Today the percentage of electric arc furnace steel of the overall steel production in the EU-27 is 41.8 % [286, Stahl 2008]. With 61 % in Italy and 77 % in Spain, the production of EAF steel is significantly higher than steel production via the blast furnace/basic oxygen furnace route (not considering Member States having exclusively EAF steel production).

The major feedstock for the EAF is ferrous scrap, which may be comprised of scrap from inside the steelworks, cut-offs from steel product manufacturers (e.g. vehicle builders) and capital or post-consumer scrap (e.g. end-of-life products). Direct reduced iron (DRI) is also increasingly being used as a feedstock due to its low gangue content, variable scrap prices and lower content of undesirable metals (e.g. Cu). Ferroalloys may be used as additional feedstock in greater or lesser quantities to adjust the desired concentrations of non-ferrous metals in the finished steel.

As in the BOF, a slag is formed from lime to collect undesirable components in the steel [260, Germany 2007] [373, Eurofer 2007]. In the EAF slag from carbon steel production is produced during a process of melting steel scrap by the addition of limestone and/or dolomite as fluxes at temperatures around 1600 °C. The production of high alloy steel comprises various processes during which several slags are produced as by-products [177, Eurofer 2009].

Figure 8.1 shows an EAF plant. In this case the building containing a twin shell EAF is totally enclosed in order to minimise dust, gaseous and noise emissions.



Figure 8.1: Electric arc furnace plant

An EAF is usually charged with scrap by metal baskets (charging boxes) hanging over the open kiln vessel as can be seen in Figure 8.2.



Source: [200, Commission 2001] [260, Germany 2007]

Figure 8.2: Electric arc furnace charging

An overview of the electric steelmaking process is given in Figure 8.3.

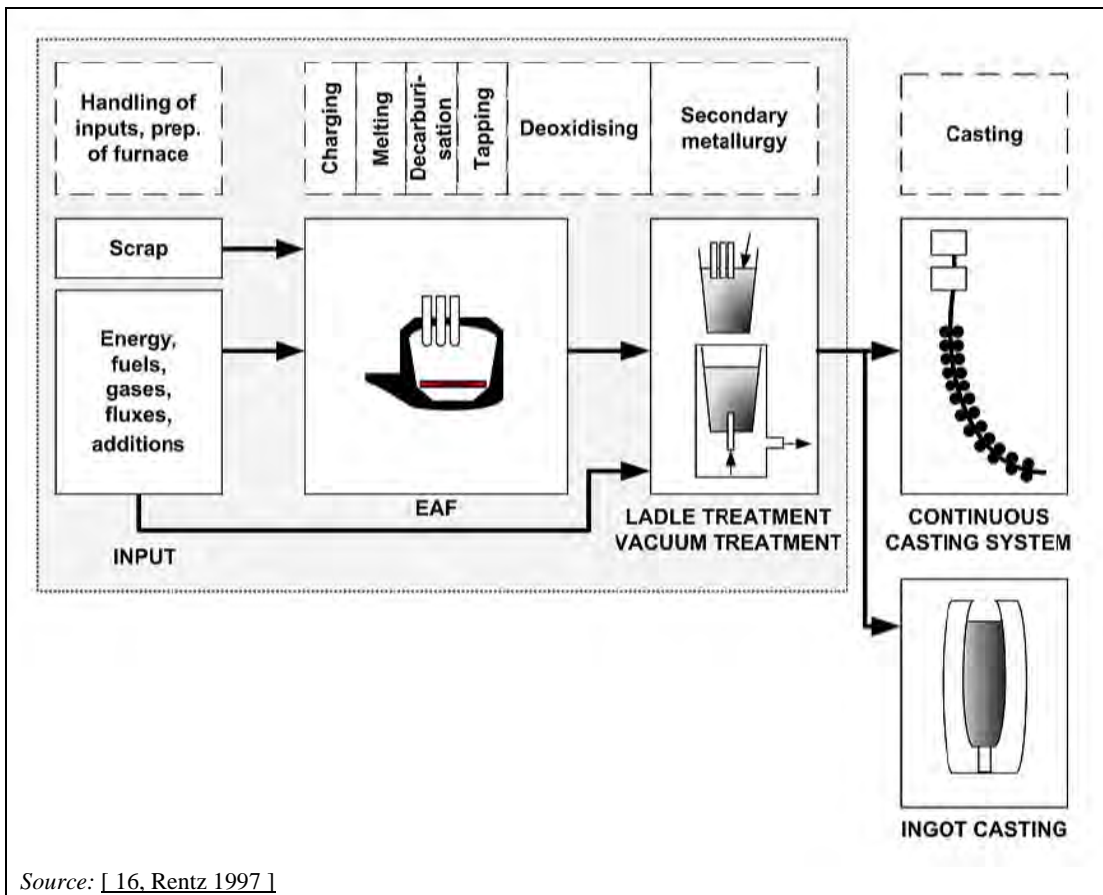

Source: [16, Rentz 1997]

Figure 8.3: Overview of the processes related to electric arc furnace steelmaking

With respect to the end-products, a distinction should be made between the production of ordinary carbon steel as well as low alloyed steel and high alloyed steels/stainless steels. In the EU, about 88 % of steel production is carbon or low alloyed steel [373, Eurofer 2007].

For the production of carbon steel and low alloyed steels, the following main operations are performed:

- raw materials handling, pretreatment (if any) and storage [373, Eurofer 2007]
- furnace charging
- EAF scrap melting
- steel and slag tapping
- ladle furnace treatments for quality adjustment
- slag handling
- casting.

For high alloyed and special steels, the operation sequence is more complex and tailor made for the end-products. The process is split in two steps: melting in an EAF and decarburisation in an AOD or VOD process.

The decarburisation is followed by various ladle treatments (secondary metallurgy) such as:

- desulphurisation
- degassing for the elimination of dissolved gases like nitrogen and hydrogen.

8.1.1 Raw materials handling and storage

Scrap metal is stored normally outside on large, uncovered and often unpaved ground. The ferrous scrap metal is loaded into baskets by magnets or grabs. Scrap is purchased based on specific international specifications which minimise non-metallic inclusions. The handling minimises any rogue non-magnetic material like stones, wood or non-ferrous metals from entering the process. Some types and quality of scrap during metal storage and handling operations may lead to the deposit of residual materials on the ground, as well as to the deposition of heavy metals and hydrocarbons.

Depending upon the types and qualities of scrap being processed, handling operations may also lead to inorganic (dust) and organic emissions under certain weather conditions. Some types of scrap may also give rise to noise emissions during handling [220, Eurofer 2008].

Some scrap sorting is carried out to reduce the risk of including hazardous contaminants. In-house generated scrap can be cut into manageable sizes using oxygen lancing. The scrap may be loaded into charging baskets in the scrapyards or may be transferred to temporary scrap bays inside the melting shop. In some cases, the scrap is preheated in a shaft or on a conveyor (see scrap preheating). Radioactivity present in the incoming scrap may be an issue in some cases. Please refer to Section 2.3.1 [260, Germany 2007].

Other raw materials including fluxes in lump and powder, powdered lime and carbon, alloying additions, deoxidants and refractories are normally stored under cover. Following delivery, handling is kept to a minimum and, where appropriate, dust extraction equipment may be used. Powdered materials can be stored in sealed silos (lime should be kept dry) and conveyed pneumatically or kept and handled in sealed bags.

8.1.2 Scrap preheating

Over the past several years more and more new and existing EAFs have been equipped with a system for preheating the scrap by the off-gas in order to recover energy. Scrap preheating has been used successfully for over 40 years in countries with high electricity costs, such as Japan. Such preheating is performed either in the scrap charging baskets or in a charging shaft (shaft furnace) added to the EAF or in a specially designed scrap conveying system allowing continuous charging during the melting process (e.g. the CONSTEEL and ESC process). In some cases even additional fossil energy is added in the preheating process [373, Eurofer 2007].

The shaft technology has been developed in steps. In 1988 Fuchs System Technik GmbH, now SIMETAL, started a development to overcome the shortfalls of the scrap bucket preheaters and opted for direct charging of the scrap into a shaft that was positioned on the roof of the EAF. With the single shaft furnace, at least 50 % of the scrap can be preheated [125, Smith 1992].

A further modification is the double shaft furnace which consists of two identical shaft furnaces (a twin shell arrangement) which are positioned next to each other and are serviced by a single set of electrode arms. The scrap is partly preheated by off-gas and partly by side wall burners.

A very efficient shaft furnace design is the finger shaft furnace. The finger shaft design uses a unique scrap retaining system with fingers which allow the preheating of 100 % of the scrap amount [162, Voss-Spilker et al. 1996]. The first basket is preheated during the refining of the previous heat and the second during meltdown of the first one. In 1994 the first finger shaft furnace started up at Hylsa in Monterrey, Mexico. Through the utilisation of the furnace off-gas during the heat cycle, scrap can be preheated to a temperature of approximately 800 °C prior to the final melting in the furnace vessel. This means considerable energy and cost savings with a substantial reduction in tap-to-tap times.

A recent development of the scrap preheating process is the COSS technology which combines the benefits of the SHAFT Systems – high scrap preheating – with those of the CONSTEEL process – the continuous scrap feeding.
[364, Fuchs, G. 2008]

8.1.3 Charging

The scrap is usually loaded into baskets together with lime or dolomitic lime which is used as a flux for the slag formation. Carbon-bearing materials are also charged for the needs of the metallurgical work to be performed in the furnace. At some plants, lump coal is also charged in order to adjust the carbon content. Even though this has not been confirmed up to now by emissions measurements, this may result in relevant emissions of benzene (as well as toluene and xylenes). The furnace electrodes are raised into top position, the roof is then swung away from the furnace for charging. It is normal to charge about 50 – 60 % of the scrap initially with the first scrap basket; the roof is then closed and the electrodes lowered to the scrap. Within 200 – 300 mm above the scrap, they strike an electric arc. After the first charge has been melted, the remainder of the scrap is added from a second or third basket [260, Germany 2007] [273, Eurofer 2007] [373, Eurofer 2007].

The amount of scrap charging into the EAF is directly proportional to the size of the furnace. For example, one EAF of 6.7 metres diameter charges around 60 tonnes of scrap [260, Germany 2007] [273, Eurofer 2007].

A commercially available system is known as the shaft furnace which allows part of the scrap to be charged into a vertical shaft integrated into the furnace roof and thus prevents the opening of the furnace roof halfway through the melting process. The scrap present in the shaft is preheated by the hot gases coming from the furnace [373, Eurofer 2007].

Another new charging system that has been adopted by some operators is the CONSTEEL process where the scrap is continuously fed via a horizontal conveyor system into the arc furnace. This also allows the scrap to be preheated by the furnace off-gas flowing in countercurrent.

8.1.4 Electric arc furnace melting and refining

During the initial period of melting, the applied power is kept low to prevent damage from radiation to the furnace walls and the roof whilst allowing the electrodes to bore into the scrap. Once the arcs have become shielded by the surrounding scrap, the power can be increased to complete the melting. Oxygen lances and/or oxy-fuel burners are used more and more to assist in the early stages of melting. Fuels include natural gas and oil. Furthermore, oxygen may be brought to the liquid steel by specific nozzles in the bottom or side wall of the EAF.

Oxygen in electric furnace steelmaking has become increasingly considered over the last 30 years not only for metallurgical reasons but also for increasing productivity requirements. The purpose of using oxygen is manifold:

- the combined injection of oxygen and granular carbon allows for the generation of a foamy slag thanks to the generation of CO bubbles. The 'foamy slag' technique, which is now in wide use in carbon steelmaking, improves the shielding of the furnace walls from the radiation of the arc and allows for an improved energy transfer from the arc into the steel bath [260, Germany 2007]
- for metallurgical reasons, oxygen is used for decarburisation of the melt and removal of other undesired elements such as phosphorus and silicon
- oxygen is also injected into the top of the furnace for 'post-combustion' in order to react with CO and hydrocarbons before the fumes leave the furnace with the aim of keeping as much of the heat as possible of the heat generated by the exothermic reactions within the furnace [373, Eurofer 2007].

Oxygen injection results in an increase in gas and fume generation from the furnace. CO and CO₂ gases, extremely fine iron oxide particles and other product fume are formed. In the case of post-combustion, the CO content is below 0.5 vol-% [373, Eurofer 2007].

Argon or other inert gases may be injected into the melt to provide bath agitation and temperature balancing. The slag-metal equilibrium is also improved by this technique.

Fumes and gases generated from the melting operation are processed in a flue-gas treatment plant which includes the collection and treatment devices aimed at reducing pollutant emissions.

8.1.5 Steel and slag tapping

Slag may need to be removed during heating and oxidising at the end of the heat prior to tapping. The furnace is tilted backwards towards the slagging door and the slag runs off or is raked into a pot or on the ground below the furnace resulting in dust and fume generation. For special steels, mainly alloyed steel, for metallurgic reason, the slag is tapped with the liquid steel into the ladle. Most of the slag is separated from the steel at a deslagging station into a slag pot. The fumes generated there should be captured by an exhaust system.

8.1.6 Secondary metallurgy

Carbon steel

Secondary metallurgy is carried out on the molten steel after the tapping of the primary steelmaking furnace up to the point of casting. It is typically carried out at ladle treatment

stations while the molten steel stays in the ladle. These treatment stations are generally comprised of an arc-heating unit (a ladle furnace) which allows an adjustment of the final temperature of the liquid steel for the casting operation. The treatment includes the addition of deoxidising agents and alloying elements in order to adjust the chemical composition of the finished steel. In some cases, vacuum treatment units are used for achieving special requirements regarding the concentration of elements such as hydrogen, nitrogen and oxygen of finished steel. In order to achieve a good homogenisation, inert gases (Ar or N₂) are injected into the ladle for stirring purpose. Some minor ladle treatment stations are based on inert gas or powder injection equipment. Fig 8.4 shows a block diagram with a multitude of possible secondary metallurgy treatments. Depending on the type of steel produced, one or more of such treatments are applied. Some of those treatments are applied to the steel while it is in the ladle; others need a separate treatment vessel. Some treatments are made under vacuum, others with inert gas rinsing [373, Eurofer 2007].

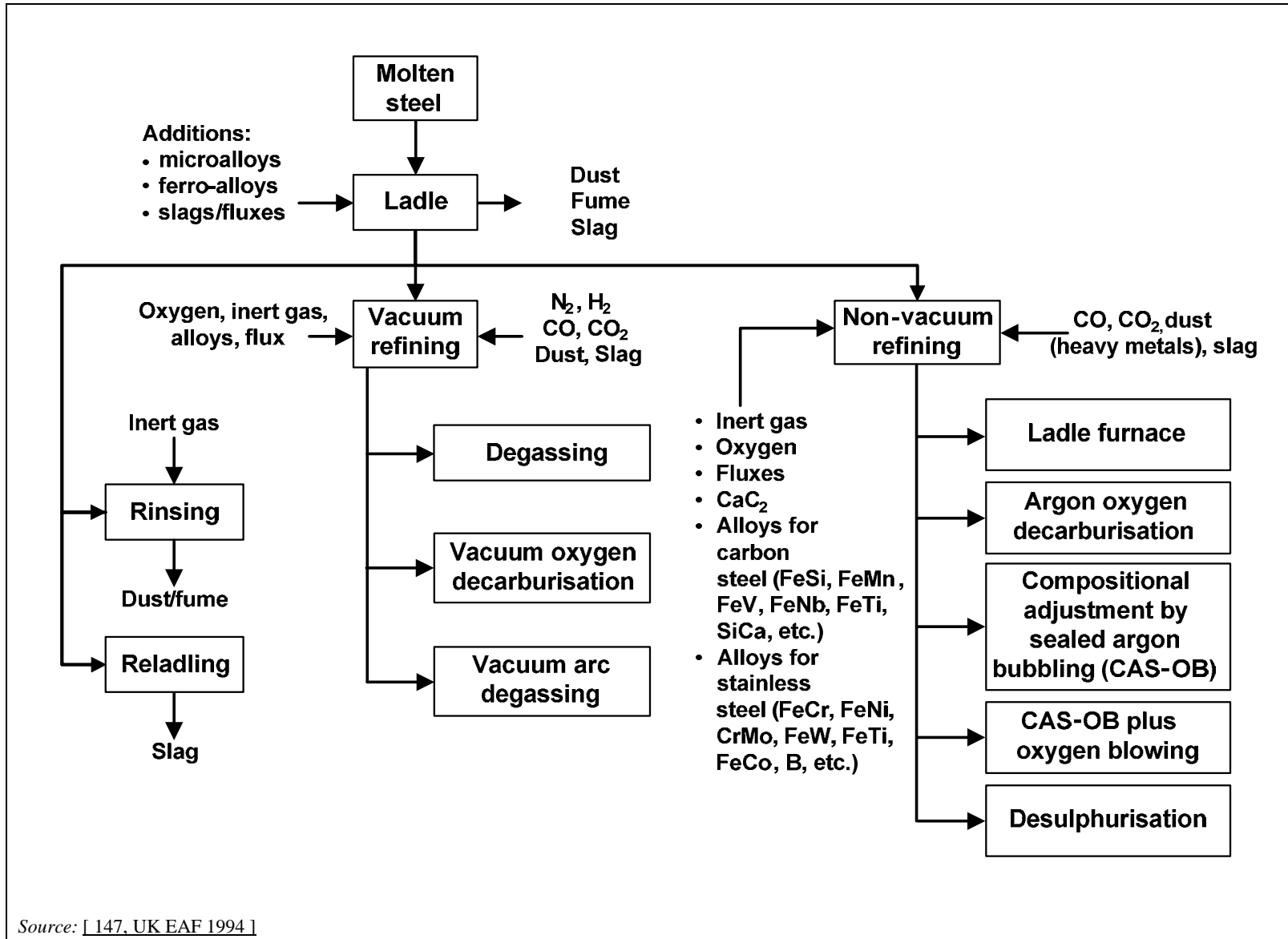

Figure 8.4: Block diagram of possible secondary metallurgy/ladle treatments for different grades of steel (carbon, stainless or high alloyed)

In the case of the production of leaded steel, off-gases which contain lead have to undergo special treatment (see information under secondary metallurgy in basic oxygen steelmaking Section 7.3.2.3).

Stainless steel

The secondary metallurgy of stainless steel may be performed either under vacuum in the ladle (VOD process – vacuum oxygen decarburisation) or in a separate metallurgical vessel called an AOD (argon oxygen decarburisation) converter and a subsequent ladle treatment. Depending on the steel grades to be produced, some operators apply a combination of both AOD and VOD [373, Eurofer 2007].

A flow diagram of a stainless steel melt shop with an AOD converter is shown in Figure 8.5

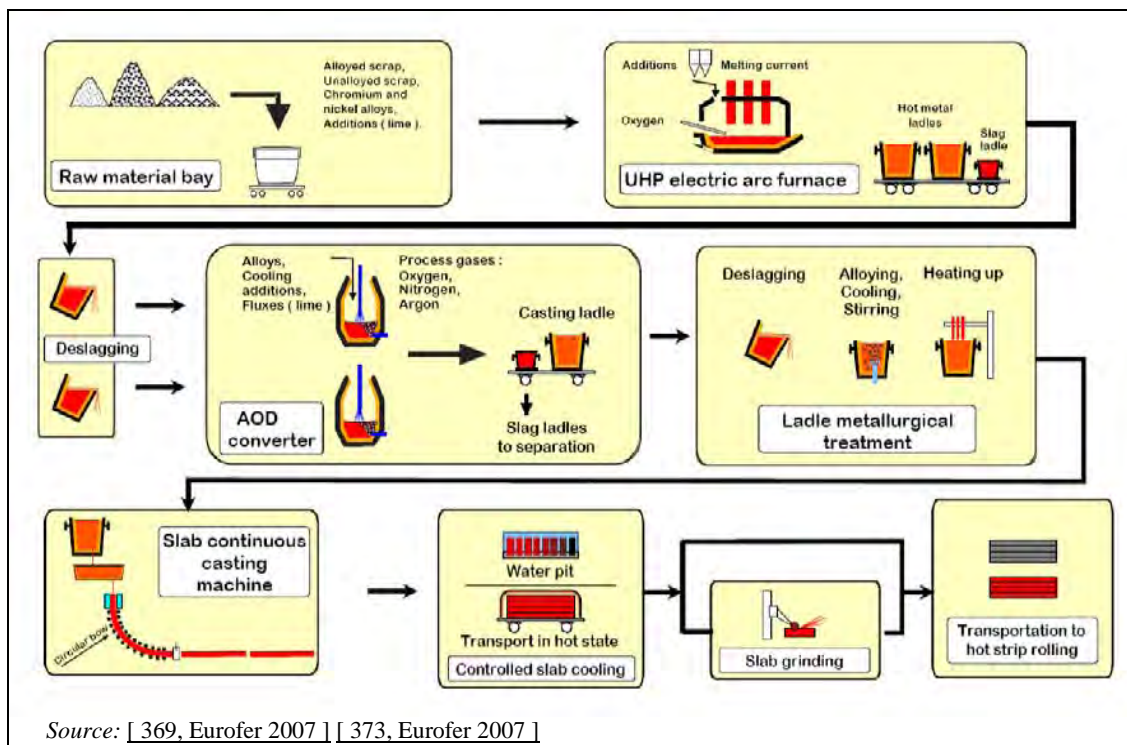

Figure 8.5: Material flow of a stainless steel melt shop with an Argon oxygen decarburisation converter

Alloys steel

The secondary metallurgy of alloy steels which contain (besides carbon) substantial quantities of alloying elements but do not rank in the stainless steel category consist generally of a ladle furnace and, if required, a vacuum treatment, depending on the steel grades produced.

During most of the processes of secondary metallurgy, slags are used to capture the non-metallic compounds generated during the treatment [373, Eurofer 2007].

8.1.7 Slag handling and processing

If slag is collected in a slag pot at the EAF (or at secondary metallurgic plants like AOD or VOD) it needs to be poured into outside slag basins for solidification. The cooling of the slag may be enhanced by water sprays. Some sites operate a slag treatment during the liquid phase to improve the slag final quality and its dimensional stability, by adding silica, alumina, boron (colemanite or sodium borate) and checking the cooling duration. In some plants the slags from

the different processes are mixed in the liquid phase to make them more suitable for further processing.

If the slag is poured on the floor, it is precrushed after solidification using excavators or shovel loaders and brought to an outside storage area.

After a certain period of time, the slag is processed in crushing and screening devices in order to give it the desired consistency for its further use in construction. During this operation, any metallic particles contained in the slag are separated magnetically, manually or using digging, crushing and sieving in order to be recycled into the steelmaking process. Recovering metals from slags is particularly sensitive for metals with a high commercial value. Slag breaking and metal recovery can create dust emissions [373, Eurofer 2007].

Sometimes water is used to cool down the slag during slag tapping which improves the microstructure, achieving better mechanical properties. This 'black electric kiln' slag is processed to street and road building material, while the 'white slag' from open basins can be used, e.g. as a lime fertiliser [260, Germany 2007] [273, Eurofer 2007].

8.1.8 Casting

For the purpose of controlled solidification of EAF steel, basically the same techniques apply as for BOF steel. The descriptions in Section 7.1.5 apply.

While the general trend is to supersede ingot casting by continuous casting, ingot casting will continue to be applied for some types of specialty steels produced in EAF steelmaking facilities.

8.2 Present consumption and emission levels

8.2.1 Mass stream overview and input/output data

Figure 8.6 provides an overview for the input and output of electric arc furnaces. This overview may be used for the collection of data from an electric arc furnace.

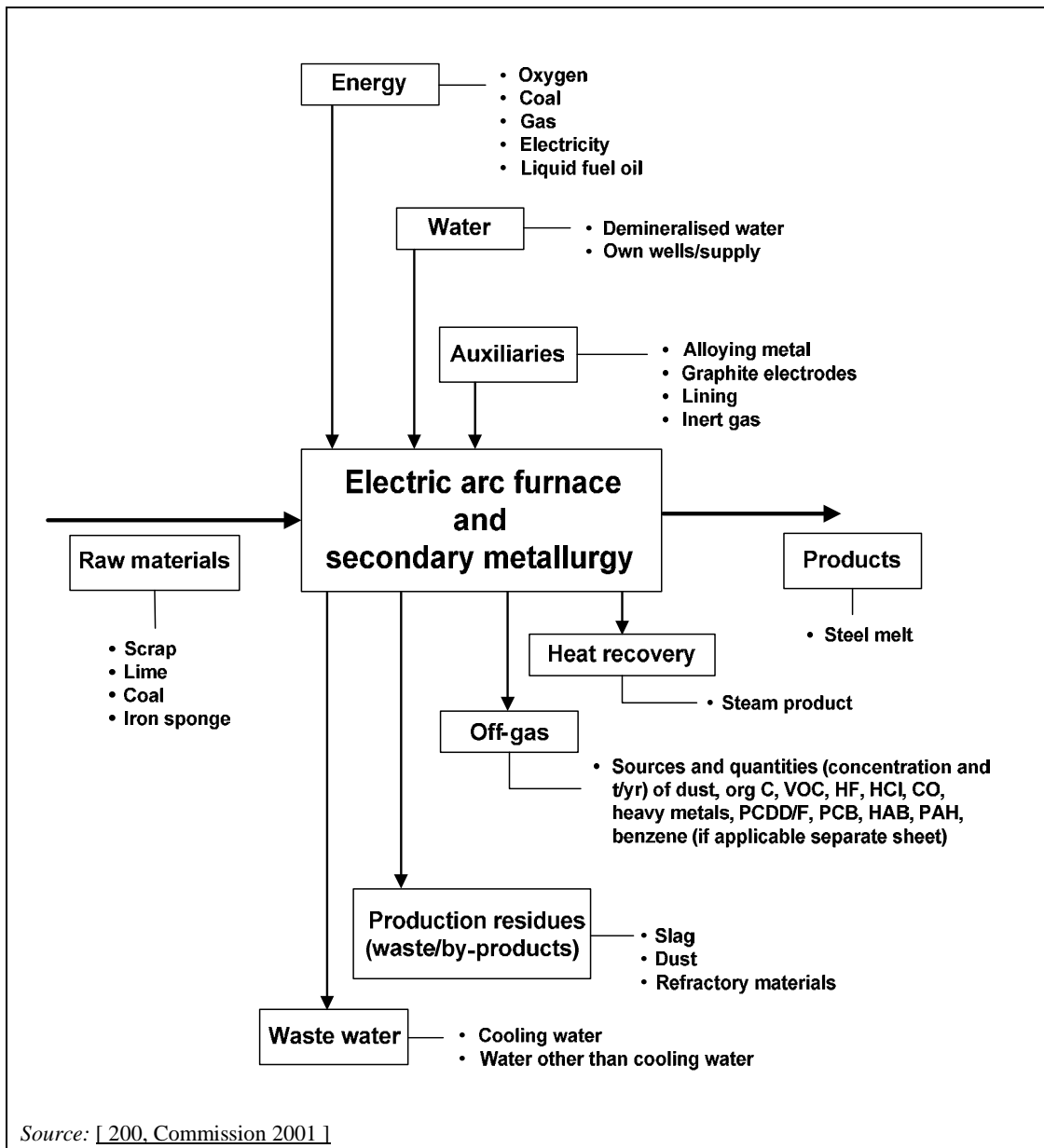

Figure 8.6: Mass stream overview of an electric arc furnace

Specific input factors as well as specific emission factors have been determined for electric arc furnaces. Such factors are presented in Table 8.1. The data are derived from various sources mentioned in the footnotes.

Table 8.1: Input/output data for electric arc furnaces within the EU

Input			Output		
Raw materials			Products		
Metallic input:			Liquid steel (LS)	kg	1000
Scrap	kg/t LS	1039 – 1232			
Pig iron	kg/t LS	0 – 153			
Liquid hot metal ⁽¹⁾	kg/t LS				
DRI (HBI)	kg/t LS	0 – 215			
Lime/dolomite ⁽²⁾	kg/t LS	25 – 140			
Coal (including anthracite and coke)	kg/t LS	3 – 28			
Graphite electrodes	kg/t LS	2 – 6			
Refractory lining	kg/t LS	4 – 60			
Alloys:					
Carbon steel	kg/t LS	11 – 40			
High alloy and stainless steel	kg/t LS	23 – 363			
Gases			Air emissions		
Oxygen	m ³ /t LS	5 – 65	Off-gas flow	Million Nm ³ /h	1 – 2
Argon	m ³ /t LS	0.3 – 1.45		Nm ³ /t LS	8000 – 10000
Nitrogen	m ³ /t LS	0.8 – 12	Dust	g/t LS	4 – 300
Steam ⁽³⁾	kg/t LS	33 – 360		mg/m ³	0.35 – 52
Energy			Hg	mg/t LS	2 – 200
Electricity	kWh/t LS MJ/t LS	404 – 748 1454 – 2693	Pb	mg/t LS	75 – 2850
Fuels (natural gas and liquid fuels)	MJ/t LS	50 – 1500	Cr	mg/t LS	12 – 2800
			Ni	mg/t LS	3 – 2000
			Zn	mg/t LS	200 – 24000
			Cd	mg/t LS	1 – 148
			Cu	mg/t LS	11 – 510
			HF	mg/t LS	0.04 – 15000
			HCl	mg/t LS	800 – 35250
			SO ₂	g/t LS	5 – 210
			NO _x	g/t LS	13 – 460
			CO	g/t LS	50 – 4500
			CO ₂	kg/t LS	72 – 180
			TOC	g C/t LS	35 – 260
			Benzene	mg/t LS	30 – 4400
			Chlorobenzenes	mg/t LS	0.2 – 12
			PAH ⁽⁴⁾	mg/t LS	9 – 970
			PCB ⁽⁵⁾	mg/t LS	0.01 – 5
			PCDD/F	µg I-TEQ/t LS	0.04 – 6
			Production residues (waste/by-products)		
			Slag from furnace	kg/t LS	60 – 270
			Slag from ladle	kg/t LS	10 – 80
			Dusts	kg/t LS	10 – 30
			Waste refractories	kg/t LS	1.6 – 22.8
			Noise	dB (A)	90 – 133

⁽¹⁾ Hot metal is only used in very special cases (about 275 kg/t LS), then the quantity of scrap is lower.
⁽²⁾ Typically lime is used but in a few cases dolomite alone is used or combinations of dolomite and lime (e.g. weight proportion 63/37).
⁽³⁾ Steam is generally not used within EAF steelmaking, except for plants with secondary metallurgy with vacuum treatment
⁽⁴⁾ No consistent database, some results represent the total of 16 EPA PAH, others only a section of them.
⁽⁵⁾ No consistent database, values represent different selections of PCB (2 of them refer to the above-mentioned Ballschmitter PCB, 3 to WHO-TEQ and 2 without further indication).

NB: — Some measuring methodologies might vary significantly from country to country and from plant to plant. Not all the emitted substances are measured at all plants. The measuring programmes vary greatly depending on permit requirements.
— Data has been compiled from information provided by EAF melt shop operators (carbon steel, alloy steel and stainless steel) representing 37.4 Mt of steel produced. This represented close to 50 % of the total EAF steel production in the EU in 2004 in 11 different EU countries.
— LS = Liquid steel.

Source: [140, Eurofer 2009] [200, Commission 2001] [220, Eurofer 2008] [234, Poland 2007] [367, Prüm et al. 2005] [371, Eurofer 2007] [372, Czech TWG member 2008].

By far the main iron source for an EAF is scrap. Hot metal and DRI are used by a rather small number of operators, generally in a rather sporadic fashion. Thus, it is difficult to indicate representative ranges. Hot metal and DRI might be used to adjust composition for some particular steel grades. In some instances, the input of DRI or hot metal might also be due to economic reasons. HBI is basically hot briquetted DRI. It is better suited for handling and transportation and less exposed to atmospheric oxidation.

The emission factors indicated in Table 8.1 are the result of a survey. The wide ranges observed for some of the emission factors may have the following origins:

- differences in the performances of environmental protection equipment
- differences in the emission limit values prescribed by national or local authorities
- differences in the quality of measurements – frequency, precision, sampling, laboratory methodologies, etc.
- differences in the input material
- differences in the plant characteristics
- type of steel produced (metals emissions)
- plant productivity.

[220, Eurofer 2008] [373, Eurofer 2007]

8.2.2 Environmental issues for electric arc furnace steelmaking process

The electric arc furnace steelmaking process is a source of primarily dust and solid wastes/by-products. Energy consumption also plays an important role for EAF steelmaking. When abatement techniques are applied to reduce emissions, cross-media effects occur. Generally, Sections 8.2.2.1 to 8.2.2.6 below describe the most relevant environmental issues in the EAF process.

8.2.2.1 Emissions to air

8.2.2.1.1 Collection of primary emissions

Primary off-gases represent approximately 95 % of total emissions from an EAF [22, EC EAF 1994]. Most of the existing plants extract the primary emissions by the 4th hole (in the case of three electrodes – AC furnaces (see Figure 8.7) or by the 2nd hole (in the case of one electrode – DC furnaces). Thus 85 – 90 % of the total emissions during a complete cycle tap-to-tap can be collected [22, EC EAF 1994]. There are still few plants which do not have a 4th hole but a doghouse; a complete enclosure of the furnace with adequate gas extraction [373, Eurofer 2007].

8.2.2.1.2 Collection of secondary emissions

Off-gases are generated during scrap handling, charging and tapping as well as those escaping from the furnace openings like fumes (i.e. electrode openings and doors) are captured by a canopy hood generally located above the furnace. They may contain all of the pollutants described under primary emissions.

The most recent furnaces are often installed inside buildings with closed upper parts and a powerful extraction at the roof top. Depending on the dimensions of the building and the capacity of the furnace, the flow rate of the extraction system can exceed 1 million m³/h [373, Eurofer 2007].

The following collection configurations are applied:

- EAF with extraction of primary off-gas at the furnace (2nd and 4th hole) and a canopy hood for the collection of the secondary off-gas flow, installed in a building with an open roof section
- EAF with extraction of primary off-gas at the furnace (2nd and 4th hole) and with a doghouse collecting all the fumes from the furnace to one exhaust system, installed in a building with open roof sections

- EAF with extraction of primary off-gas at the furnace (2nd and 4th hole) installed in a building with a totally enclosed roof that collects the secondary off-gas flow
- in some installations a 2nd or 4th hole extraction only.

Figure 8.7 shows the main three types of off-gas collection systems for AC furnaces with 4th hole extraction.

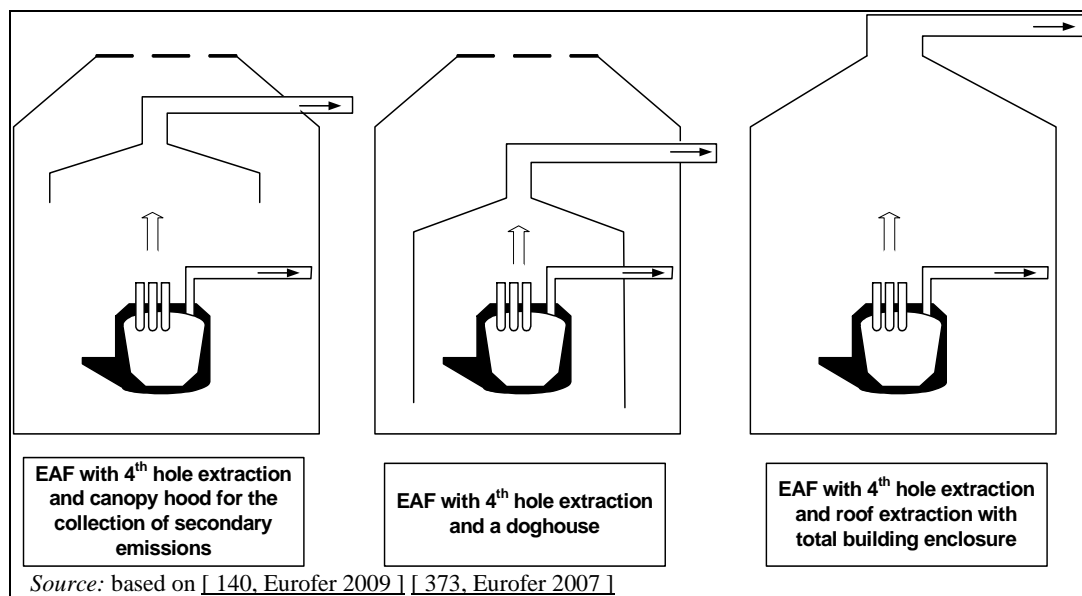

Figure 8.7: Collection systems at EAF

A doghouse can be built in different designs. There are large doghouses, where the charging crane is going into (or nearly into) the upper part of the doghouse, which is kept closed during charging and works as a hood. The other type of doghouse is small and totally open during charging. In this case an additional hood is necessary to capture the charging plumes.

If secondary metallurgy is carried out in the same building as the EAF, these emissions can also be collected by canopy hoods and roof extractions [373, Eurofer 2007].

Table 8.2 summarises the qualitative efficiencies to collect emissions from the main operations of electric arc furnace steelmaking.

Table 8.2: Systems for the collection of emissions from EAF plants

Sources of emissions	Charging	Melting (in EAF)	Tapping	Secondary metallurgy ⁽¹⁾	Continuous casting ⁽¹⁾
4 th hole	No	Yes	No	Yes, if also equipped	NA
Canopy hood	Yes, Partly	Yes	Yes, partly	Yes, if also equipped	Yes, if also equipped
Doghouse	Only if closed ⁽²⁾	Yes	Yes	Yes, if also equipped	NA
Total building evacuation	yes	yes	yes	yes	yes

⁽¹⁾ If located in the same building.
⁽²⁾ Usually the doghouses are not closed during charging as they obstruct the access to the EAF.
 NB: NA = Data not available.
 Source: [22, EC EAF 1994] [373, Eurofer 2007].

Figure 8.8 shows the percentages of the off-gas collection systems used in a sample of 51 EAFs in the EU. 4th hole collection of the primary emissions at the furnace roof is almost generalised. A vast majority of plants have either canopy hoods or total building enclosure. Some plants still operate with only a 4th hole extraction.

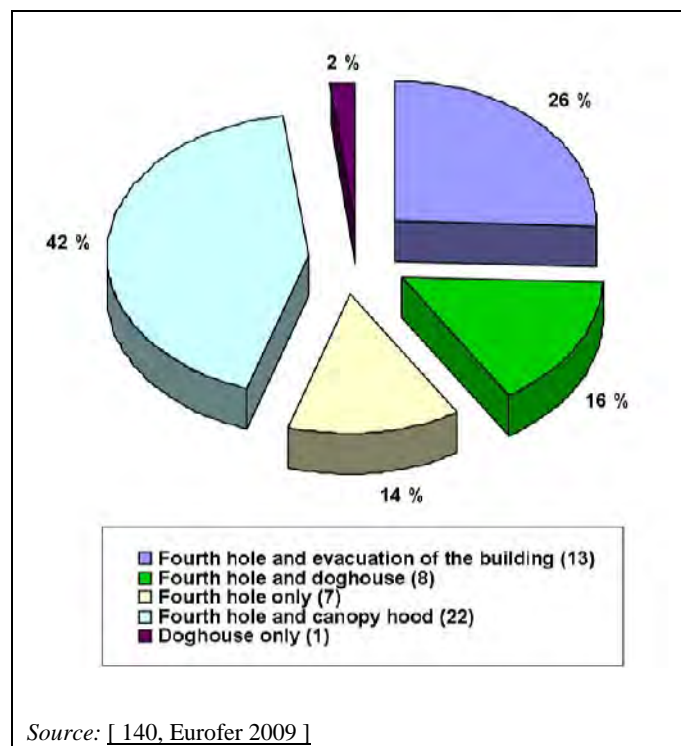

Figure 8.8: Percentage of existing dust collection system in 51 EAF in the EU

With respect to micropollutants like organochlorine compounds, especially PCDD/F, the contamination of secondary off-gases (mainly the leakages from the EAF) contribute to overall emissions. In order to minimise total PCDD/F emissions, secondary emissions should also be taken into account, thus strengthening the need for total building evacuation.

8.2.2.1.3 Primary and secondary emissions and treatment

Off-gas from primary and secondary collection in EAF contains dust, metals, nitrogen and sulphur oxides and organic matter (e.g. VOC, chlorobenzenes, PCB, PAH and PCDD/F). Organic matter emissions mainly depend on the scrap quality. Some scraps contain paints, oils and other organic substances [367, Prüm et al. 2005].

Information about secondary emissions is limited. From charging the EAF, usually 0.3 – 1 kg dust/t LS and from tapping usually 0.2 – 0.3 kg dust/t LS are emitted (emissions before abatement) [22, EC EAF 1994]. For fume leakages during EAF operations, dust emission factors between 0.5 and 2 kg dust/t LS are reported [30, Roederer et al. 1996].

Emission factors as a sum of the aforementioned three sources (charging, tapping, fume leakages) are between 1.4 and 3 kg dust/t LS before abatement [30, Roederer et al. 1996]. This can be considered a confirmation that primary emissions are about ten times higher than secondary emissions.

Generally the treatment of different off-gas flows (i.e. primary and secondary emissions) is performed in the same device, mostly in bag filters [373, Eurofer 2007]. Only in a few cases are ESPs and wet scrubbers applied.

Table 8.3 shows examples for achieved air emissions concentrations from the EAF process after abatement with bag filters or ESP.

Table 8.3: Air emissions concentrations from the EAF process after abatement

Parameter		Bag filter	Electrostatic precipitator ⁽¹⁾	Unit
Dust		0.35 – 3.4	1.8	mg/Nm ³
CO		88 – 256		mg/Nm ³
NO _x		0.97 – 70		mg/Nm ³
SO _x		8 – 17		mg/Nm ³
Metals:	Hg	0.016 – 0.019	<0.0003	mg/Nm ³
	Total (including Sb, Pb, Cr, CN, F, Cu, Mn, V, Se, Te, Ni, Co, Sn)	0.006 – 0.022	0.01 – 0.07	mg/Nm ³
	Cr (except Cr (VI))	0.013		
	Mn	0.036		
	Ni	0.003		
PAH		<0.00001	<0.001	mg/Nm ³
PCDD/F		0.0015 – 0.1 ⁽²⁾		ng/Nm ³
HF		0.085 – 0.2		mg/Nm ³
HCl		3 – 5.4		mg/Nm ³
Cl ₂		<3		mg/Nm ³
⁽¹⁾ Values relate to one German stainless steel plant. ⁽²⁾ Upper end of the range relates to measurements carried out in 1997. NB: — Values are annual averages and relate to the central dedusting system. — PAH contain benzo(a)pyrene and dibenzo-(a,h)-anthracene. Source: [244, Plickert 2007] [277, Wiesenberger 2007].				

Dust

The off-gas contains 10 – 30 kg dust/t liquid carbon steel or low alloyed steel and 10 – 18 kg dust/t in the case of high alloyed steel before abatement. At EAFs for stainless steel, the maximum value for dust production is 30 kg dust/t. With a converter like an AOD, the off-gas (EAF and AOD) contains 10 – 46 kg/t liquid alloyed steel. The composition of the dust can be seen from the analysis of the dust separated from the off-gas in the bag filters or electrostatic precipitators (ESP) (see Table 8.10). Most of the heavy metals are mainly associated with dust and, thus, are removed to a large extent from the off-gas with the dust abatement. Those heavy metals present in the gas phase, e.g. mercury, are not eliminated by filtration or ESP [373, Eurofer 2007].

The range of dust emission factors after abatement can be seen in Table 8.1. About 96 % of the dust belongs to PM₁₀ [83, Ehrlich, C. et al 2007] [288, IA 2006]. The range is quite wide (three orders of magnitude), indicating a huge difference in collection and abatement efficiency. In terms of concentration, the emissions are between 0.5 – 50 mg dust/Nm³ (the majority of the installations are at the lower end of the range). Normally these emission factors or emission concentrations include secondary dust emissions because primary and secondary emissions are very often treated in the same equipment [366, Dornseiffer et al. 2007] [373, Eurofer 2007].

Heavy metals

Some emissions in Table 8.1 show wide ranges. Higher values can be of high environmental relevance. Zinc is the metal with the highest emission factors. Chromium and nickel emissions are, for obvious reasons, generally higher in the manufacturing of stainless steel [373, Eurofer

2007]. A part of the chromium can occur as hexavalent chromium. It is of paramount importance because it is highly carcinogenic by inhalation.

In three EU EAF plants, emissions factors for arsenic between 0.025 and 14 g/t have been measured [288, IA 2006] [234, Poland 2007].

Mercury emissions can strongly vary from charge to charge depending on scrap composition/quality [137, Theobald 1995] [144, UBA-BSW 1996]. Mercury emissions in the sector are expected to decline due to the progressive phasing out of mercury following the full implementation of several directives already in place, such as the 'End-of-life Vehicles' Directive, the 'Waste from Electrical and Electronic Equipment' Directive and the Directive on the Restriction of Hazardous Substances in the Electrical and Electronic Equipment as well as the battery Directive [273, Eurofer 2007]. Nevertheless, relevant exceedings of mercury ELVs have been observed, indicating that mercury-bearing components still occur in the scrap sources, and apparently they are not always removed from the shredder input. Emissions factors for mercury of 170 mg/t LS, despite efforts to reduce mercury in purchased scrap, have been observed on an annual basis and seem to be fairly similar for steel, based on domestic and imported scrap [81, Norwegian TWG member 2008].

Sulphur and nitrogen oxides

The SO₂ emissions mainly depend on the quantity of coal and oil input but are not of high relevance. NO_x emissions also do not need special consideration.

Other inorganic pollutants

[288, IA 2006]

Fluoride, chloride are other relevant inorganic pollutants but no further information was provided.

VOC

VOC emissions may result from organic substances adhering to the raw materials (e.g. solvents, paints) charged to the furnace. In the case of the use of natural coal (anthracite), compounds such as benzene may degas before being burnt off [373, Eurofer 2007].

Polycyclic aromatic hydrocarbons (PAH)

The emission factors for PAH are also relatively high (9 – 970 mg/t LS – see Table 8.1) but there are not many reported measurements. PAH are also already present in the scrap input [120, Schiemann 1995] but may also be formed during EAF operation. The expectation that PAH adsorb to the filter dust to a high extent (also depending on the off-gas temperature) could not be confirmed by investigations in Luxembourg, where PAH emissions remained unchanged before and after abatement in a bag filter which achieved low residual dust contents (<5 mg/Nm³) as a daily mean value [167, Werner 1997]. The PAH profile is dominated by the more volatile two or three ring PAH such as naphthalene, acenaphthene, anthracene and phenanthrene [388, Fisher et al. 2005].

Persistent organic pollutants (POPs)

Since the nineties increasing note has been taken of POPs. Analytical results are only available for a limited number of compounds. Organochlorine compounds, such as chlorobenzenes, PCB and PCDD/F have been measured.

There is a strong correlation between the concentrations of PCDD/F and WHO-12 PCB, with the I-TEQ of PCDD/F being approximately 16.5 times higher than that of WHO-12 PCB. This suggests that the formation mechanisms of PCB and PCDD/F are linked [388, Fisher et al. 2005].

Chlorobenzenes have been determined at several EAF operations (0.2 – 12 mg/t LS – see Table 8.1). From measurements at one EAF plant, it is known that hexachlorobenzene is present in the emitted off-gas [373, Eurofer 2007].

Polychlorinated biphenyls (PCB)

Polychlorinated biphenyls (PCB) are a class of chlorinated semi-volatile organic compounds composed of 209 congeners. A group of 12 PCB, which exhibit 'dioxin-like' behaviour, has been identified by the World Health Organisation (WHO). The main contributor to the WHO-12 I-TEQ was PCB 126.

Other PCB congeners found are PCB 28, 52, 101, 138, 153 and 180 which are known as the six Ballschmitter congeners [388, Fisher et al. 2005]. The toxicological purpose for the determination of the two sets of PCB is not the same. A common approach for an adequate estimate of the 'total PCB'(209) is to multiply the sum of the 6 Ballschmitter/DIN PCB by five.

PCB emissions have been detected and measured at some EAFs. These measurements showed that different congeners have been determined. Values as low as 0.01 mg/t LS and as high as 5 mg/t LS have been reported. In addition, it is not known yet whether PCB can be formed by de novo synthesis during the process and/or within the off-gas devices. These uncertainties show that it is difficult if not impossible to draw general conclusions on the formation and decomposition processes of PCB in EAF off-gases.

PCB may be present in the scrap input which could be the dominant source for the measured emissions [120, Schiemann 1995]. Regulations, for example as end-of-life electric equipment management, have greatly helped to prevent the introduction of items which contains PCB (for instance small capacitors in several technical devices like washing machines, dryers, cooker hoods, oil burners, fluorescent lamps, etc). One investigation has shown that PCB are practically not abated in bag filters [167, Werner 1997]. A recent study performed in Sweden has shown a correlation between dioxin-like PCB and PCDD/F but has also shown that the emission of PCB in terms of WHO-TEQ is far less important than the emission of PCDD/F [373, Eurofer 2007].

In general, it has been concluded that typical off-gas cleaning systems (e.g. filters, ESP, scrubbers) are more efficient at removing PCDD/F emissions than PCB. The compound-specific differences can be explained by differences in volatility between the congeners of the three compound groups. The variability in efficiency may be also due to the differences in the dust separation efficiency, gas temperature and adsorption properties of the dust [370, Öberg 2007].

Polychlorinated dibenzo-p-dioxins and furans (PCDD/F)

During the thermal treatment of scrap which contains paints, oils (e.g. cutting oils), PVC (polyvinyl chloride) or other organic substances, PCDD/F are released or produced during waste gas treatment and emitted into the atmosphere along with the furnace fumes [367, Prüm et al. 2005]. These emissions are especially important during the beginning of the scrap melting phase at the EAF, when the temperatures are still low. Even if downstream process temperatures are sufficiently high to destroy the PCDD/F, the PCDD/F generated during that initial phase will have an influence on its downstream generation [375, IISI 1998] [388, Fisher et al. 2005].

PCDD/F are generated as well by the combustion at low temperatures (250 – 500 °C) of organochlorinated compounds that may be present in the charge as well as by de novo synthesis, catalysed by metals (e.g. Cu and to a lesser extent Fe). Findings indicate that the temperature profile is more important than the mean temperature in determining the PCDD/F concentration in the waste gas [388, Fisher et al. 2005]. Regarding PCDD/F, there are many measurements available showing emission factors between 0.04 – 6 µg I-TEQ/t LS [220, Eurofer 2008] (see Table 8.1). Concentrations between 0.02 and 9.2 ng I-TEQ/Nm³ have been measured [367, Prüm et al. 2005]. Figure 8.9 presents an example of the distribution of PCDD/F homologues in the off-gas of a twin shell EAF with scrap preheating before and after abatement. The PCDD/F homologues with four and five chlorine atoms dominate.

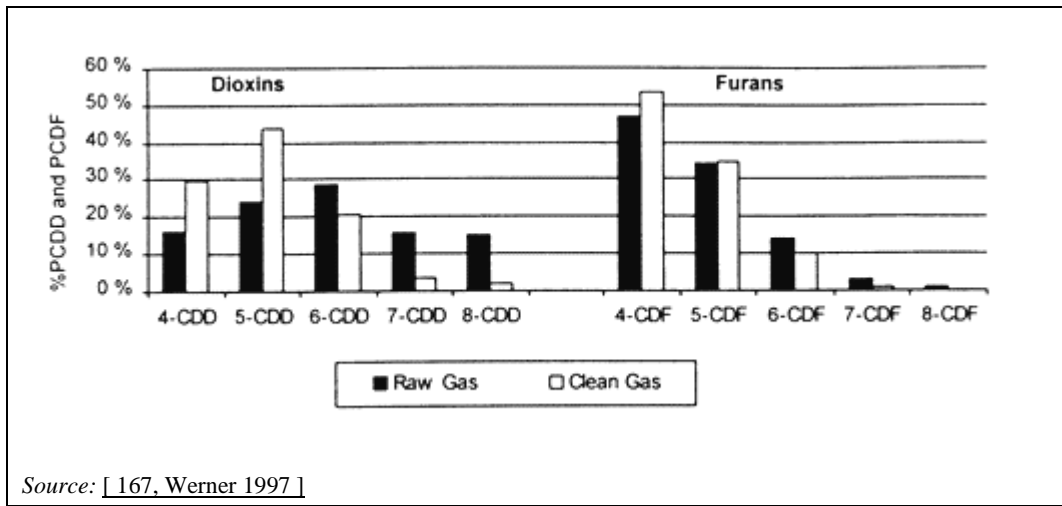

Figure 8.9: Distribution of PCDD/F homologues in the off-gas of a twin shell EAF with scrap preheating before and after abatement

With respect to the absolute PCDD/F emissions, there is a correlation between off-gas temperature (see Figure 8.10) and dust content (see Figure 8.11) [366, Dornseiffer et al. 2007] [375, IISI 1998].

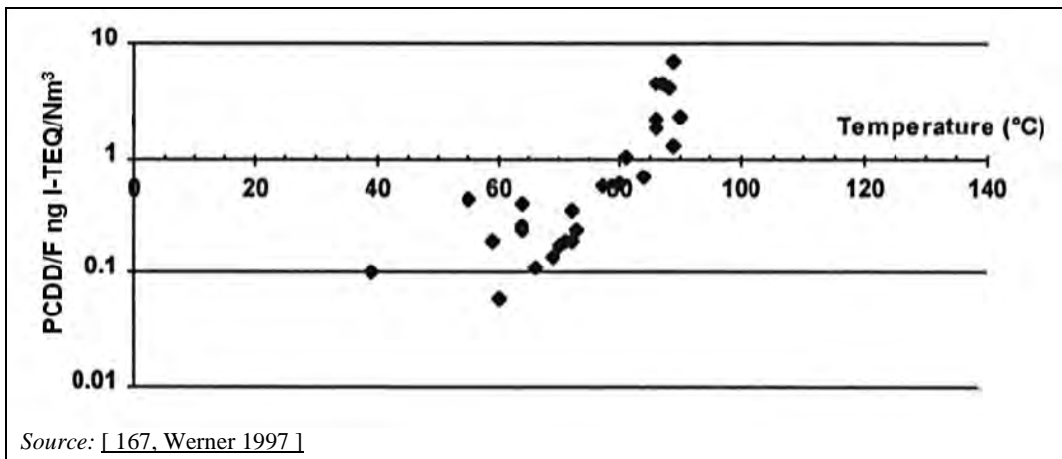

Figure 8.10: Correlation of PCDD/F emissions and temperature of the off-gas after abatement in a bag filter of an EAF

Figure 8.10 indicates that as long as the clean gas temperature is below 75 °C, PCDD/F emissions will stay below 1 ng I-TEQ/Nm³. The physical explanation of this pertains to the decrease of volatility of PCDD/F with decreasing temperature [126, Spencer et al. 1992]. At low temperatures, PCDD/F increasingly tends to adsorb to the filter dust.

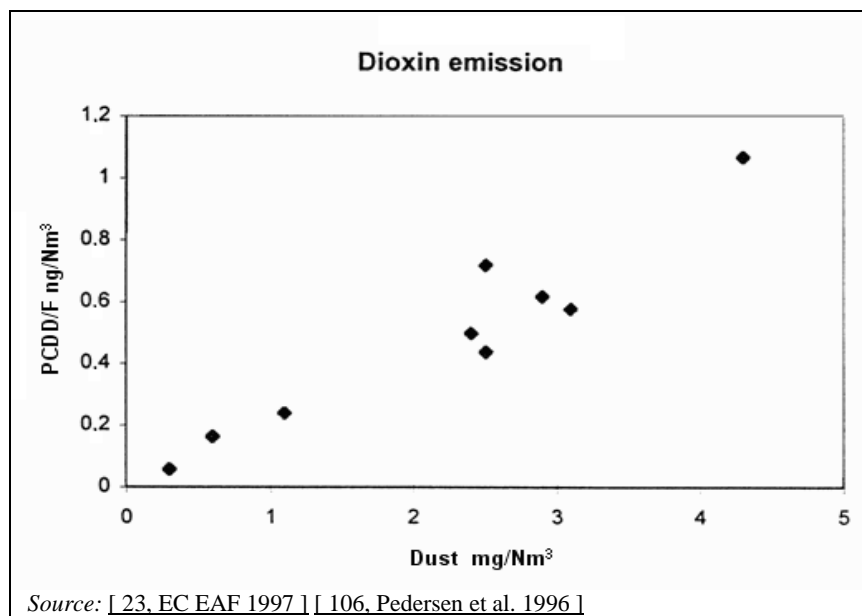

Figure 8.11: Correlation of residual dust content and PCDD/F concentrations after abatement in a bag filter in the off-gas of an EAF at temperatures below 85 °C

The observation that there is a close connection between dust and PCDD/F emissions should be related to off-gas temperature. The dust content itself mainly depends on the dimension and quality of the bag filter but also on the relative humidity in the off-gas which can be high in cases of off-gas quenching or location near the sea (see Figure 8.12).

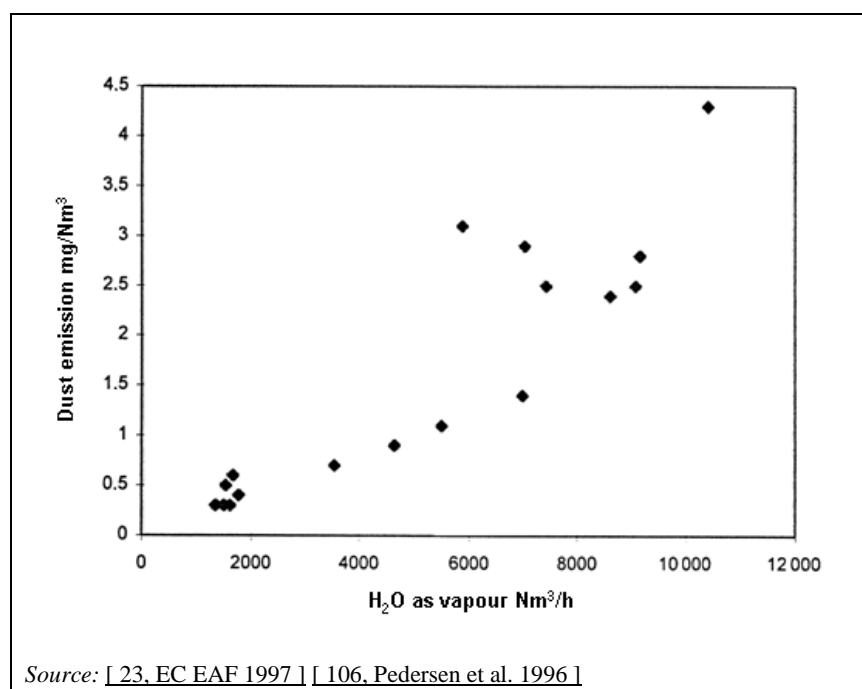

Figure 8.12: Correlation of water vapour and residual dust content after abatement in a bag filter in the off-gas of an EAF

PCDD/F are normally expressed as International Toxicity Equivalents (I-TEQ) according to NATO/CCMS, 1988. This is also the case for the existing legislation and actual permits. The revised IPPC permits for IS plants in the Walloon Region of Belgium are formulated in WHO-

TEQ for PCDD/F and 'dioxin-like' PCB plus a specific limit value for 'total PCB' estimated by $5 \times$ the sum of the 6 Ballschmiter/DIN PCB (in mass concentration).

In 1998, the WHO had developed new toxicity equivalents for PCDD/F (WHO-TEQ). Integrated into this evaluation are 12 dioxin-like PCB [219, Van den Berg et al. 1998].

In 2005, reevaluated toxicity equivalents (WHO 2005-TEQ) have been presented and accepted by the WHO [366, Dornseiffer et al. 2007] [315, Van den Berg., et al, 2006]. Figure 8.13 shows measurement results expressed as I-TEQ in comparison to WHO-TEQ, including dioxin-like PCB.

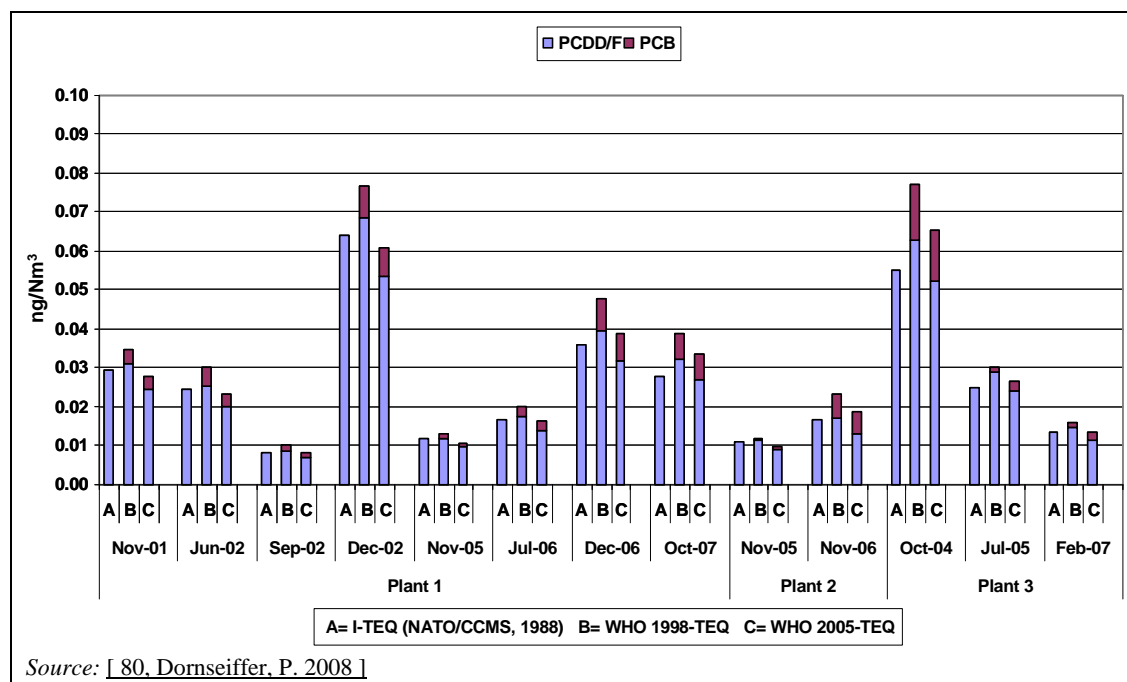

Figure 8.13: PCDD/F emissions from EAF as I-TEQ and WHO-TEQ including dioxin-like PCB

The total level of PCDD/F including PCB expressed as WHO 2005-TEQ varies between 11 % lower and 21 % higher than the PCDD/F expressed as I-TEQ. The average of all presented measurements is 2 % lower for the values of PCDD/F as WHO 2005-TEQ including PCB compared to PCDD/F as I-TEQ.

The total level of PCDD/F including PCB is 12 – 24 % lower when expressed as WHO 2005-TEQ compared to WHO 1998-TEQ [80, Dornseiffer, P. 2008] [315, Van den Berg., et al, 2006].

According to information provided by Eurofer, the dioxin emissions from stainless steel production are lower than in the case of carbon steel. However this affirmation has only been verified in a few plants [209, EC 2005].

Table 8.4 shows specific and annual emissions of PCDD/F and PCB to air from Swedish EAFs steel plants estimated from production in 2005. The reported values are according to the TEQ, using the latest weighting scheme by the WHO [315, Van den Berg., et al, 2006] including both PCDD/PCDF and dioxin-like PCB. The contribution from dioxin-like PCB is mostly in the range of 10 – 20 %. The TEQ is reported as an interval when some toxic congeners are below the limit of detection.

Table 8.4: Specific and annual emissions of PCDD/F and PCB to air from Swedish EAF steel plants

Plant	PCDD/F ($\mu\text{g TEQ/t LS}$)	PCDD/F (g TEQ/yr)	PCB ($\mu\text{g TEQ/t LS}$)	PCB (g TEQ/yr)
A	0.67	0.29	0.22	0.096
B	0.41	0.025	0.04	0.002
C	0.091	0.008	0.015	0.0013
D	0.080	0.015	0.02	0.0034
E	3.7	1.8	0.42	0.21
F	0.056	0.015	0.012	0.0032
G	2.4	1.0	0.28	0.12
H	0.17	0.003	0.56	0.01

NB: LS = Liquid steel.
Source: [370, Öberg 2007].

8.2.2.1.4 Emissions from secondary metallurgy processes and continuous casting

Information about emissions from secondary metallurgy (mainly dust emissions) and from continuous casting is very limited. [30, Roederer et al. 1996] reports dust emission factors before abatement from seven AOD/VOD refining installations between 6 and 15 kg dust/t LS and a single low figure of 1.35 kg dust/t LS. These seven installations have a dedusting device independent from the dedusting of EAFs. The emission factors reported in Table 8.1 include the emissions from secondary steelmaking.

The treatment of the collected off-gas flows from secondary metallurgy is performed in the same type of device, mostly in bag filters as primary and secondary emissions. Table 8.5 shows some emissions concentration values for different parts of the secondary metallurgy after abatement.

Table 8.5: Emissions from different parts of the secondary metallurgy after abatement

Parameter	Primary dedusting of ladle metallurgy units	Ingot casting and continuous casting ⁽¹⁾	Vacuum treatment and oxygen blow unit
PM	0.6 – 1	0.5	4.1 – 13.2
Pb, Co, Ni, Se, Te	0.006		
Sb, Cr, CN, F, Cu, Mn, V, Sn	0.01	0.01 – 0.03	

⁽¹⁾ For stainless steel production only.
NB: Values are annual averages and in mg/Nm³.
Source: [244, Plickert 2007].

8.2.2.1.5 Emissions from scrap preheating

The scrap preheating may lead to an important generation of organic pollutants due to the possible presence of organic substances on the scrap which are combusted during preheating under very unfavourable conditions. This can result in increased emissions of VOC and PCDD/F emissions. In this case, the off-gases need further aftertreatment, i.e. post-combustion.

8.2.2.1.6 Emissions from slag processing

If the slag is collected in a slag pot at the EAF, it needs to be poured into outside slag basins for solidification. The cooling of the slag may be enhanced by water sprays resulting in fumes. These fumes can be highly alkaline if the slag contains free CaO (see Table 8.7). This is very often the case. Alkaline depositions from the fumes may cause problems in the neighbourhood.

If the slag is poured on the floor it is precrushed after solidification using excavators or shovel loaders and subsequently brought to an outside storage area.

After a certain period of time, the slag is processed in crushing and screening devices in order to give it the desired consistency for separating metals from the slag and for its further use in construction. Slag breaking and metal recovery can create dust emissions. The emission from crushing and screening should be extracted and subsequently cleaned. Water spraying can be applied at the conveyor belts transfer points. If the processed slag is stored, heaps can be wetted. During loading of broken slag, water fogs can be used to minimise dust emissions [85, VDI/DIN 2006] [260, Germany 2007] [273, Eurofer 2007] [373, Eurofer 2007].

8.2.2.2 Waste water

Water is used for the following purposes:

- cooling of the EAF
- rapid quenching of the hot off-gases
- scrubbing water if wet dedusting is applied
- vacuum generation
- direct cooling in continuous or ingot casting.

According to the water management seeking optimal treatment of all waste waters, information on the flow and treated waste water of single production steps is often not available because the mixture of different waste water streams are treated together (see Section 2.4) [363, Eurofer 2007].

Cooling water

Water is used in the EAF unit for cooling the wall panels and the roof and for spraying the electrodes. The water used for the cooling of the EAF is about $5 - 12 \text{ m}^3/(\text{m}^2\text{h})$. For an EAF of a production capacity of 70 t/h the cooling water demand is 1000 m^3/h . Since the water is led in a closed cooling cycle, no waste water occurs. Also cooling system without circulation can be used if there is no lack of good quality cooling water. This saves energy on pumping and recooling.

Waste water from off-gas scrubbing

In some cases in the EU, the off-gases are treated in a wet scrubber. There is no information available on applied treatment techniques and discharged quantities and their pollution.

Waste water from continuous and ingot casting

Continuous casting in the EAF process is similar to the basic oxygen furnace process. For more information, see Sections 7.2.2.2 and 7.3.4. Specific information about input/output quantities is not available. Usually this waste water is treated together with other streams from the rolling mill(s).

Waste water from vacuum generation

For vacuum treatment, the usual specific process water flow from vacuum generation ranges from $5 - 8 \text{ m}^3/\text{t LS}$ vacuum treated. In a few cases the specific process water demand is higher, in one case $42.8 \text{ m}^3/\text{t LS}$ (see Table 8.1). This water is nearly fully recycled. It should be mentioned that not all of the liquid steel should be vacuum treated. Information on composition and treatment or recycling is not available [140, Eurofer 2009] [363, Eurofer 2007] [365, Eurofer 2007].

Waste water from quenching

Water is used for rapid quenching. From one plant it is reported that $25 \text{ m}^3/\text{h}$ are used to quench approximately $870\,000 \text{ m}^3/\text{h}$. No waste water occurs since the used water is mostly evaporated

and leaves the process with the exhaust airflow. A minor part leaves the process with the residual moisture of the dust.

Drainage water from the scrapyards

The main raw material of EAF, the different kinds of scrap are often stored on unpaved scrapyards. Drainage water can be contaminated, especially in the case of scrap which contains oil/emulsions like turnings. There is no information available on quantities and pollution of drainage water. Usually it is at least treated in an oil separator prior to being discharged.

8.2.2.3 Process residues such as wastes and by-products

The various solid residues such as wastes or by-products from EAF steelmaking are compiled together with their specific quantities in Table 8.6.

Table 8.6: Kind and specific quantity of solid wastes/by-products from electric arc furnace steelmaking

Solid waste/by-product		Specific quantity (range) (kg/t LS)
Slags from carbon steel/low alloyed steel production:	Slag from EAF	100 – 150
	Slag from ladle	10 – 30
Slags from high alloyed steel production:	Slag from EAF	100 – 135
	Slag from ladle	30 – 40
	AOD slag	Approximately 160
Dusts from carbon steel/low alloyed/high alloyed steel production		10 – 46
Refractory bricks		2 – 25
NB: LS = Liquid steel.		
Source: [46, Geiseler 1991] [116, Rentz et al. 1996].		

More recent data for European EAF plants can be found in Table 8.1.

8.2.2.3.1 Slags from production of carbon steel/low alloyed steel/high alloyed steel

First a slag is produced during a process of melting steel scrap in an EAF by the addition of slag formers. During one or several ensuing processes the raw steel produced in the EAF will pass subsequent treatments in converters and/or ladles. In this (these) process(es) ferroalloys are added to the liquid metal, and together with some additives (e.g. lime) basic slags are formed. In contrast to EAF slag from carbon steel production, EAF slags from stainless steel production can have higher contents of heavy metals, which are, e.g. used as an alloying addition.

The chemical composition of EAF slags from the production of carbon/low alloyed steel and stainless/high alloyed steel can be seen in Table 8.7.

Table 8.7: Chemical composition of EAF slag from the production of carbon/low alloy steel and stainless/high alloy steel

Component (wt-%)	Carbon/low alloyed steel ⁽¹⁾			Stainless/high alloyed Steel ⁽²⁾		
	Typical concentration	Lower limit	Upper limit	Typical concentration	Lower limit	Upper limit
CaO	28	15	64	50	17	68
SiO ₂	19	4	26	23	2	42
MgO	7	0.5	15.5	6	1.5	25
Al ₂ O ₃	7	1	16.5	2.5	<0.1	30
FeO	32	10	63	2	<0.1	39
Cr ₂ O ₃	1.8	<0.1	11	2	<0.1	22
F				2	<0.1	9
MnO	5	0.5	19.5	1	<0.1	21
TiO ₂				0.8	<0.1	3.5
Zn				<0.1	<0.1	2
P ₂ O ₅	0.4	<0.01	2			
Na ₂ O	0.2	<0.01	2			
K ₂ O	0.14	<0.01	2.5			

⁽¹⁾ Carbon/low alloyed steel: EAF C EINECS No: 294-410-9 CAS No: 91722-10-0.
⁽²⁾ Stainless/high alloyed steel: EAF S EINECS No: 294-410-9 CAS No: 91722-10-0.
NB: — The analytical information on ferrous slags is usually given in the form of oxides although components may occur in different mineral phases and different oxidation states.
— Components which usually have maximum concentrations <1 wt-% are not specified.
— The analysis relates not to aqua regia dissolution but to total digestion (see e.g. EPA 3052 or EN 13211:2001).
— In traces, other elements such as Pb, As, Sb, Hg, Cl, F and hexavalent chromium may also be present.
Source: [37, Motz 2009].

The rate of landfilling or recycling varies in the different Member States depending on legal requirements, availability of landfills, taxes, market situation, costs and possibilities to reuse processed slags. In the EU, a growing amount of slags from carbon and low alloyed steelmaking are used as secondary raw materials, mainly for road construction and for infrastructural measures in several applications. Slags from stainless steel production are generally less suitable for such uses and need to be landfilled. The percentage of the on-site recycling of slags from the production of high alloyed steels is significantly higher than for slags from carbon and low alloyed steelmaking. But still one third is landfilled and stored (see Table 8.8) [373, Eurofer 2007].

Table 8.8: Fate of EAF slags in the EU

Kind of steel	Total slag quantity (kt/yr)	On-site recycling		External use		Sold		Landfilled and stored	
		(kt/yr)	(%)	(kt/yr)	(%)	(kt/yr)	(%)	(kt/yr)	(%)
Carbon steels ⁽¹⁾	958	–	–	164	17.1	362	37.8	432	45.1
Carbon steels ⁽²⁾	1796	45.1	2.5	494.8	27.6	13.7	0.8	1242	69.2
Low alloyed steels ⁽²⁾	444	–	–	61.6	13.9	108.0	24.4	261	58.9
High alloyed steels ⁽²⁾	461	81.4	17.7	68.0	14.8	160.0	34.7	156	33.9
Total EAF slags ⁽²⁾	2701	126.5	4.7	624.4	23.1	281.7	10.4	1659	61.4
Total EAF slags ⁽³⁾	4408								

⁽¹⁾ Data from 11 plants producing 958 kt/yr of slags (131.7 kg/t LS) in 2008.
⁽²⁾ Data from 57 plants producing 2.7 million t/yr of slags (133 kg/t LS) in 1996.
⁽³⁾ Data from 2004 and related to the following EU countries: AT, BE, DE, DK, ES, FR, FI, LU, NL, UK, SE, SK.
Source: [30, Roederer et al. 1996] [195, Werner 2010] [365, Eurofer 2007].

Slags from four EAF plants were analysed for PCDD/F and PCB. Table 8.9 shows concentrations and annual mass flows of PCDD/F and PCB in slag for these steel plants in which scrap was used as a raw material. The concentrations found are below the limit value of 15 µg TEQ/kg specified in the regulation for persistent organic pollutants.

Table 8.9: Concentrations and annual mass flows of PCDD/F and PCB in slag from steel plants using scrap as a raw material

Plant	PCDD/F (µg TEQ/kg)	PCDD/F (g TEQ/yr)	PCB (µg TEQ/kg)	PCB (g TEQ/yr)
A	<0.004	<0.56	0.0002	0.029
B	0.014 – 0.015	0.053 – 0.058	0.0014	0.0069
I	0.002	0.14	0.0004	0.027
J	0.002	0.09	0.00005	0.002

Source: [370, Öberg 2007].

8.2.2.3.2 Dusts from off-gas treatment

As already mentioned, the treatment of off-gases (mostly primary off-gases together with secondary off-gases) is very often performed in bag filters. The chemical composition of dusts from the production of carbon, low alloyed and high alloyed steel can be seen in Table 8.10.

Table 8.10: Chemical composition of EAF dusts from the production of carbon steel/low alloyed steel and high alloyed steel/stainless steel

Component	Dust from carbon/low alloyed steel production (wt-%)	Dust from alloy steel production (wt-%)	Dust from stainless steel production (wt-%)
Fe _{tot}	10 – 45	17 – 37	20 – 65
SiO ₂	0.6 – 5.1	1.7 – 5	3 – 9
CaO	3 – 17	2 – 16	8 – 20
Al ₂ O ₃	0.3 – 3	1 – 4	0.4 – 2
MgO	0.5 – 6	1.2 – 3	1 – 5
P ₂ O ₅	0.1 – 0.37	0.01 – 0.1	0.03 – 0.1
MnO	1.1 – 6	1.5 – 6.9	2.2 – 6.3
Cr ₂ O ₃	0.13 – 2	0.12 – 6	9 – 20
Na ₂ O	0.3 – 3	NA	0.6 – 2
K ₂ O	0.5 – 2.3	NA	0.7 – 3
Zn	21 – 43	2 – 15	2 – 25
Pb	0.4 – 10	0.05 – 3.6	0.2 – 4.5
Cd	0.02 – 0.18	0.01 – 0.04	0.01 – 0.08
Cu	0.08 – 0.5	0.01 – 0.8	0.015 – 0.5
Ni	0.01 – 0.8	0.01 – 0.5	1 – 8
V	0.01 – 0.09	0.01 – 0.2	0.05 – 0.12
W	NA	0.5 – 1.5	NA
Co	0.001 – 0.01	0.01 – 0.2	0.02 – 0.04
As	0.001 – 0.02	0.001 – 0.01	0.01
Hg	0.0001 – 0.005	0.05 – 0.7	0.0002 – 0.015
Cl	0.8 – 5	0.7 – 1.7	0.8 – 1
F	0.02 – 0.9	0.01 – 0.65	0.3 – 2.4
S	0.1 – 3	0.25 – 1.42	0.2 – 0.5
C	0.4 – 3.3	0.5 – 3.1	0.05 – 1.3
Basicity	2.0 – 6.5	NA	NA
Moisture	6 – 16	NA	NA

NB: NA = Data not available.
Source: [39, EUROFER EAF 1997] [62, Hoffmann 1997] [134, Strohmeier et al. 1996] [277, Wiesenberger 2007] [376, Eurofer 2007] [391, Tavernier et al. 2004].

Dust from six plants were analysed for PCDD/F and PCB. Table 8.13 shows concentrations and annual mass flows of PCDD/F and PCB in dust for four of these plants in which iron scrap was used as a raw material.

Table 8.11: Concentrations and annual mass flows of PCDD/F and PCB in dust from four steel plants using scrap as a raw material

Plant	PCDD/F ($\mu\text{g TEQ/kg}$)	PCDD/F (g TEQ/yr)	PCB ($\mu\text{g TEQ/kg}$)	PCB (g TEQ/yr)
A	0.16	1.0	0.014	0.089
B	0.21	0.11	0.015	0.0075
I	0.035	0.20	0.0020	0.011
J	0.16	1.0	0.0042	0.026

Source: [370, Öberg 2007].

In recent years, following regulation on waste management, the percentage of dust put into landfills has been dramatically reduced. A vast majority of dust is at the time of writing (2010) brought to recovery operations for non-ferrous metals (Zn and Pb mainly in the case of carbon steel dusts and Cr and Ni in the case of stainless steel dusts) [373, Eurofer 2007].

Different technologies exist for treating EAF dust which contains from 18 – 35 % zinc. These are well-established processes in use in the non-ferrous metals production industries. However, the zinc industry normally uses raw materials which have a higher zinc concentration. As a result, EAF dust undergoes a further process before the zinc can be recovered from it. These processes raise the zinc content to 55 – 65 % [274, Eurofer et al. 1999] [284, EC 2001].

According to a survey carried out in 2006 covering 36 EAF plants and 34 2949 tonnes of dust, EAF dust is mainly used in three different ways as shown in Figure 8.14.

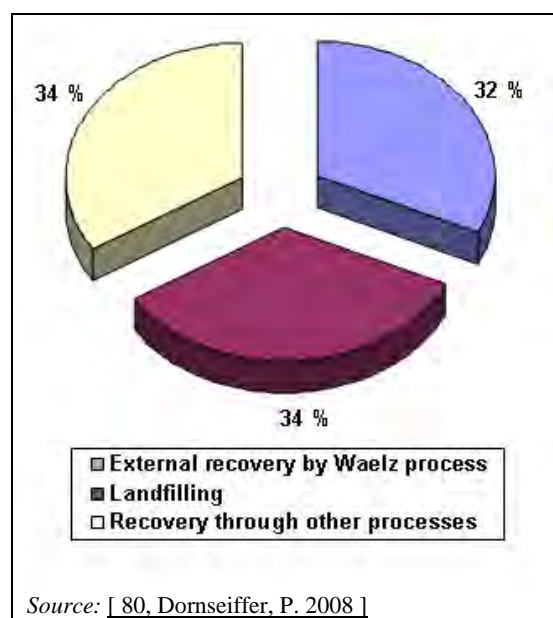

Figure 8.14: Utilisation of EAF dust

8.2.2.3.3 Refractory bricks

Refractory bricks are used for lining in the different vessels. According to [30, Roederer et al. 1996], spent refractory bricks were put to landfill. In recent years, the recovery of usable

magnesia, dolomite and alumina bricks has been introduced and landfilling has been used only for fractions that are not suitable for recovery [373, Eurofer 2007]. Bricks are mostly reused in steel production for the same purpose or another purpose not requiring such a high quality brick. In an EAF plant with a capacity of approximately 400 000 tonnes of stainless steel per year, the spent refractory amounts up to about 9000 tonnes per year [386, Cores et al. 2005]. Table 8.12 shows the annual amount relating to different process steps.

Table 8.12: Example of annual amount of spent refractory material in one installation

Refractory used	EAF	Steel ladle	Ladle furnace RH degaser	Strand caster	Ingot casting
Magnesite	1200	3800	600 ⁽¹⁾	2400	
Dolomite		600			
Mullite (clay)					500
⁽¹⁾ Chromium magnesite. NB: Values in tonnes per year. Source: [386, Cores et al. 2005].					

8.2.2.4 Energy consumption

Electricity and natural gas are the most important energy sources in EAF operations.

During the melting process some the following types of energy concur:

- thermal energy from the electrical arc
- thermal energy from the combustion of natural gas or other gaseous or liquid fuels
- chemical energy from the exothermic reactions occurring in the furnace by metal oxidation.

The energy consumption of the furnace is the balance of the three aforementioned inputs. In [364, Fuchs, G. 2008] an example is shown for an EAF with a comparably low input of 380 kWh/t electrical energy, 210 kWh/t through fuel combustion and 100 kWh/t through metal oxidation which corresponds to a total of 690 kWh/t of LS. From this input, 370 kWh/t are needed to melt and superheat the scrap to tap temperature, 37 kWh/t to liquefy and superheat the slag, 100 kWh/t are furnace losses and 140 kWh/t are as sensible heat in the off-gas.

The utilisation of the 140 kWh/t of sensible heat in the off-gas has developed over the last 40 years and is today a proven tool to reduce the total energy requirements in the EAF operations. One option is to use the sensible heat for scrap preheating. The scrap can be preheated to approximately 800 °C prior to the melting process in the furnace vessel which reduces the total energy consumption by up to 100 kWh/t LS.

8.2.2.5 Noise emissions

[260, Germany 2007] [273, Eurofer 2007]

The following are the main noise sources in EAF steelworks:

- the melting shop including the EAF
- the scrapyard
- the primary dedusting
- the roof hood dedusting
- water management equipment
- the transport of slag pots

- the transport of products, e.g. with wheel loaders
- slag processing in crushers, magnetic separators and screening devices.

Conventional EAFs show average sound levels (melting and treating) of $L_{WA} = 118 - 133$ dB(A) for furnaces >10 t and $L_{WA} = 108 - 115$ dB(A) for furnaces <10 t; the specific transformer power determines the level of noise emissions. In electric steelworks, sound levels of up to $L_{WA} = 127$ dB(A) can appear (measurement includes melting and treating). The main share of noise emissions are contributed by the melting shop including EAF, the scrapyard and primary dedusting.

8.2.2.6 Soil contamination

In many cases the scrapyard is unpaved and uncovered (see Section 8.1.1). Contamination of soil may arise from the storage of scrap contaminated by mineral oil/emulsions or other compounds. There is no information available about the extent and the impact of such soil contamination [260, Germany 2007].

If the yard for slag processing is unpaved and the raw slag contains free CaO, alkaline water may enter the soil.

8.3 Techniques to consider in the determination of BAT

This section describes techniques (or combinations thereof), and associated monitoring, considered to have the potential for achieving a high level of environmental protection in the activities within the scope of this document.

It covers process-integrated techniques and end-of-pipe measures. Waste prevention and management, including waste minimisation and recycling procedures are also considered. Furthermore, techniques for reducing the consumption of raw materials, water and energy are covered.

Annex III to the Directive lists a number of criteria for determining BAT, and the information within this chapter will address these considerations. As far as possible, a standard structure as shown in Table 8.13 is used to outline the information gathered concerning each technique, to enable a comparison of techniques and the assessment against the definition of BAT given in the Directive.

This section does not necessarily provide an exhaustive list of techniques which could be applied in the sector and other techniques may exist or may be developed, which could be considered for the determination of BAT for an individual installation.

Table 8.13: Information breakdown for each technique described in this section

Type of information considered	Type of information included
Description	Brief technical description using, as appropriate, pictures, diagrams and flow sheets.
Achieved environmental benefits	Main potential environmental benefits to be gained through implementing the technique (including energy, water, raw material savings, as well as production yield increases, energy efficiency, etc.).
Cross-media effects	<p>Potential environmental side effects and disadvantages to other media due to implementing the technique, including details of the environmental effects of the technique in comparison with others (advantages and disadvantages supported by data if available) in order to assess the impact of the technique on the environment as a whole. This may include issues such as:</p> <ul style="list-style-type: none"> • consumption of raw materials and water • energy consumption and contribution to climate change • stratospheric ozone depletion potential • photochemical ozone creation potential • acidification resulting from emissions to air • particulate matter in ambient air (including microparticles and metals) • eutrophication of land and waters resulting from emissions to air or water • oxygen depletion potential in water • persistent/toxic/bioaccumulable components in water or to land (including metals) • creation or reduction of (waste) residues • ability to reuse or recycle (waste) residues • noise and/or odour • risk of accidents.
Operational data	Actual performance data (including reference conditions, monitoring periods and monitoring methods) on emission levels, consumption levels (raw materials, water, energy) and amounts of waste generated. Any other useful information on how to operate, maintain and control the technique.
Applicability	Indication of the type of plants or processes in which the technique may or cannot be applied as well as constraints to implementation in certain cases, considering, e.g. plant age (new or existing), factors involved in retrofitting (e.g. space availability), plant size (large or small), techniques already installed and type or quality of product.
Economics	Information on costs (investment and operating) and any possible savings (e.g. reduced raw material or energy consumption, waste charges) or revenues including details on how these have been calculated/estimated. Economic information relevant to new build and retrofit to existing installations will be included. This should allow for identifying, where possible, the overall economic impact of the technique.
Driving force for implementation	Specific local conditions, requirements (e.g. legislation, safety measures) or non-environmental triggers (e.g. increased yield, improved product quality) which have driven or stimulated the implementation of the technique to date.
Example plants	Reference to the plant(s) where the technique has been implemented and from which information has been collected and used in writing the section. Indication of the degree to which the technique is in use in Europe or worldwide.
Reference literature	Literature or other reference material (e.g. books, reports, studies, websites) that was used in writing the section and that contains more detailed information on the technique.

8.3.1 EAF process optimisation

Description

The EAF process has been steadily improved in order to become optimised and to increase productivity which correlates to the decrease of specific energy consumption. The most important measures/techniques which are briefly described in this section are [312, Dr. Michael Degner et al. 2008]:

- (ultra) high power operation (UHP)
- Water-cooled side walls and roofs
- oxy-fuel burners and oxygen lancing
- bottom tapping system
- foaming slag practice
- ladle or secondary metallurgy
- automated sampling and the addition of alloying elements
- increased energy efficiency
- computer-based process control and automation.

(Ultra) high power operation

Efforts to reduce tap-to-tap times have led to the installation of more powerful furnace transformers. Decisive features for UHP furnaces are the specific power supply installed, mean power efficiency (≥ 0.7), and timely use of the transformer (≥ 0.7). UHP operation may result in higher productivity, reduced specific electrode consumption, and reduced specific waste gas volume, but also in increased wear of the furnace lining [57, Heinen 1997].

Water-cooled side walls and roofs

Since 1980, furnace walls and roofs have been lined with water cooled panels, providing the opportunity to save refractory material, to use the UHP furnace technology, and also to reuse waste heat by the application of measures for energy recovery. However, the economic viability of energy recovery should be checked on a plant by plant basis. In principle, two cooling systems can be distinguished. ‘Cold or warm cooling’ draws off power losses by an increase of the cooling water temperature flowing through the pipe coils. Evaporation cooling works through the evaporation of cooling water to draw off radiation heat caused by the electric arc process. To protect water-cooled side panels from thermal strain, especially when foaming slag operation (see below) is not possible, a computer controlled regulation of the meltdown process helps to prevent tears in the panels caused by mechanical tension and also saves refractory material [75, Knoop et al. 1997].

Oxy-fuel burners and oxygen lancing

Oxy-fuel burners promote a uniform melting of the scrap. It also partially offsets the effect of maximum demand control on electricity supply. Usually, additional energy input by oxy-fuel burners and oxygen lancing results in a decrease in total energy input required.

Bottom tapping system

The practice of bottom tapping has been used since 1983 and is widely adopted nowadays, as it makes minimising the amount of oxidic slag (carryover) to the ladle during tapping possible. It also allows cost savings for the lowering of refractory material needed, for a more rapid tapping, and for reduced energy losses. Furthermore, it simplifies the capturing of fumes.

Usually most new EAFs for carbon steel are equipped with bottom tapping systems. However, some older furnaces as well as most furnaces for stainless steel are still equipped with spouts. The reasons for this are multiple. Spouts allow the tapping of the whole melt and partial tapping. The tapping procedure is well controlled and the maintenance of the spout is easy due to its simple construction. With stainless steel and a high degree of reduction of the slag some Cr is recovered by the steel from the slag after tapping and prior to deslagging at a deslagging station [77, Austrian TWG member 2008] [177, Eurofer 2009].

Foaming slag practice

Creating a foamy slag within the furnace improves the heat transfer to the charged inputs, and also protects the refractory material inside the furnace. Because of better arc stability and fewer radiation effects, foaming slag practice leads to reductions in energy consumption, electrode consumption, noise level, and an increase in productivity. It also causes positive effects on several metallurgical reactions (e.g. between slag and melt). The density of foaming slag is lower than common EAF slag which contains FeO (1.15 – 1.5 t/m³ compared to 2.3 t/m³). For this reason, the volume of slag arising during steelmaking increases and may require larger slag buckets. After tapping, the slag partly degases again. Information on adverse impacts of the foamy slag practice on the possibilities of using the slag have not been encountered. It should be noted that the use of the foaming slag practice is not possible for some steel grades such as stainless steel and other high alloyed steels.

Ladle or secondary metallurgy

Some production steps need not be carried out in the EAF itself and can be performed more efficiently in other vessels (like desulphurisation, alloying, temperature and chemistry homogenisation). The technique of shifting specific activities to ladles, ladle furnaces, or other vessels was introduced c. 1985 [36, EPRI 1992] [57, Heinen 1997]. The reported benefits of this development are energy savings (net savings of 10 – 30 kWh/t), a reduction of tap-to-tap times of about 5 – 20 minutes, increased productivity, a better control of the steel temperature of the heat delivered to the continuous casting, a possible reduction of electrode consumption (up to 0.1 – 0.74 kg/t), alloy savings, and a decrease in the emissions from the EAF itself [36, EPRI 1992]. A possible drawback of using ladles or other vessels with respect to air pollution control is the increase in the number of emission sources, requiring higher investments for air pollution control equipment as additional fume capturing devices like hoods.

Increased energy efficiency

The EAF power demand (electrical voltage) has been significantly increased since 1995, resulting in electric networks being more and more disturbed, which implies electric energy losses. Electric energy inputs are an important lever for action. Improving power supply by means of efficient power electronics allows for increasing productivity and a reduction in the overall energy demand. Specific electricity consumption of 360 kWh/t has been achieved with a 100 MW DC EAF at ArcelorMittal, Esch-Belval, Luxembourg. For AC EAFs, one study has shown that improved power supply can lead to a productivity gain of approximately 7 % and associated gains in energy efficiency [252, France 2007].

Computer-based process control and automation

Computer-based control in EAFs has become necessary and has been commonly used approximately since 1982, as the high throughputs require efficient control systems to manage the material and data flows arising in the raw material selection, EAF, ladle furnace, and continuous caster. Efficient control systems in particular enable optimisation of the energy input in the furnace and permit an increase in productivity and also a decrease in dust emissions [86, Linninger et al. 1995] [312, Dr. Michael Degner et al. 2008].

Achieved environmental benefits

The achieved environmental benefits are mentioned above under the description heading.

Cross-media effects

Oxy-fuel burners increase the off-gas flow but on the other hand they decrease the overall energy demand.

Water-cooled side walls and roofs need an additional energy consumption of about 10 – 20 kWh/t but may be compensated for by advantages in the field of plant availability and maintenance. Water-cooled side walls and roofs have inter alia provided the opportunity to apply modern technology like high power or UHP furnaces.

Operational data

No data submitted.

Applicability

The described techniques are applicable to both new and existing plants but should be checked on a plant by plant basis.

Economics

No data submitted.

Driving force for implementation

The high market competition and the need to increase productivity/to reduce costs pushed the introduction of the described techniques.

Example plants

Many plants in the EU are equipped with the described techniques and are operated with optimised conditions.

Reference literature

[16, Rentz 1997] [252, France 2007] [260, Germany 2007] [273, Eurofer 2007] [312, Dr. Michael Degner et al. 2008]

8.3.2 Scrap preheating**Description**

The utilisation of the sensible heat in the off-gas (approximately 140 kWh/t LS) has developed in the last 40 years and is today a proven tool in reducing the total energy requirements in the EAF operations. One option is to use the sensible heat for scrap preheating. The scrap can be preheated to approximately 800 – 1000 °C with discontinuous systems and to 300 – 400 °C with continuous systems prior to the EAF melting process which reduces the total energy consumption by up to 100 kWh/t LS.

Such preheating is performed either in the scrap charging baskets or in a charging shaft (shaft furnace) added to the EAF or in a specially designed scrap conveying system allowing continuous charging during the melting process. In some cases, even additional fossil energy is added in the preheating process [373, Eurofer 2007].

The shaft technology has been developed in steps. In 1988, Fuchs Systemtechnik GmbH, now SIEMENS VAI Metals Technologies, started a development to overcome the shortfalls of the scrap bucket preheaters and opted for direct charging of the scrap into a shaft that was positioned on the roof of the EAF. With the single shaft furnace 100 % of the scrap can be preheated [125, Smith 1992].

A further modification is the double shaft furnace which consists of two identical shaft furnaces (twin shell arrangement) which are positioned next to each other and are serviced by a single set of electrode arms. The scrap is partly preheated by off-gas and partly by side wall burners.

A very efficient shaft furnace design is the finger shaft furnace. The finger shaft design uses a unique scrap retaining system with fingers which allows the preheating of 100 % of the scrap amount [162, Voss-Spilker et al. 1996]. The first basket is preheated during the refining of the previous heat and the second during the melting down of the first one. In 1994, the first finger shaft furnace started up at Hylsa in Monterrey, Mexico. Through the utilisation of the furnace off-gas during the heat cycle, scrap can be preheated to a temperature of approximately 1000 °C prior to the final melting in the furnace vessel. This means considerable energy and cost savings with a substantial reduction in tap-to-tap times. The 4th generation of Siemens VAI preheating Shaft technology were installed in January 2008 in Stahl Gerlafingen with an more efficient

charging system into the shaft in addition to improved scrap preheating. The average additional energy savings for this system are in the range of 10 kWh per tonne of LS.

All occurring emissions from the scrap preheating systems can be combusted in a separate downstream combustion chamber.

Since the year 2000, continuous scrap preheating and feeding became very popular, e.g. CONSTEEL (see Figure 8.15) [84, Grasselli, A. and Raggio, C. 2008]. The scrap is charged by cranes on a special conveyor belt. In the preheating section the charge receives heat from the off-gases leaving the furnace. The scrap flow is adjusted to the power input of the EAF. The charge is melted by immersion in a molten pool, heated by the energy coming from the electric arcs and from the chemical reactions taking place in the melt, in contrast to conventional top-charge EAF where the melting is provided by direct heat transfer from the electric arc. The bath is always covered by a foaming slag which is constantly promoted by controlled carbon and oxygen injection.

Another recently developed continuous feeding scrap preheating process is the COSS technology (see Table 8.15) [364, Fuchs, G. 2008].

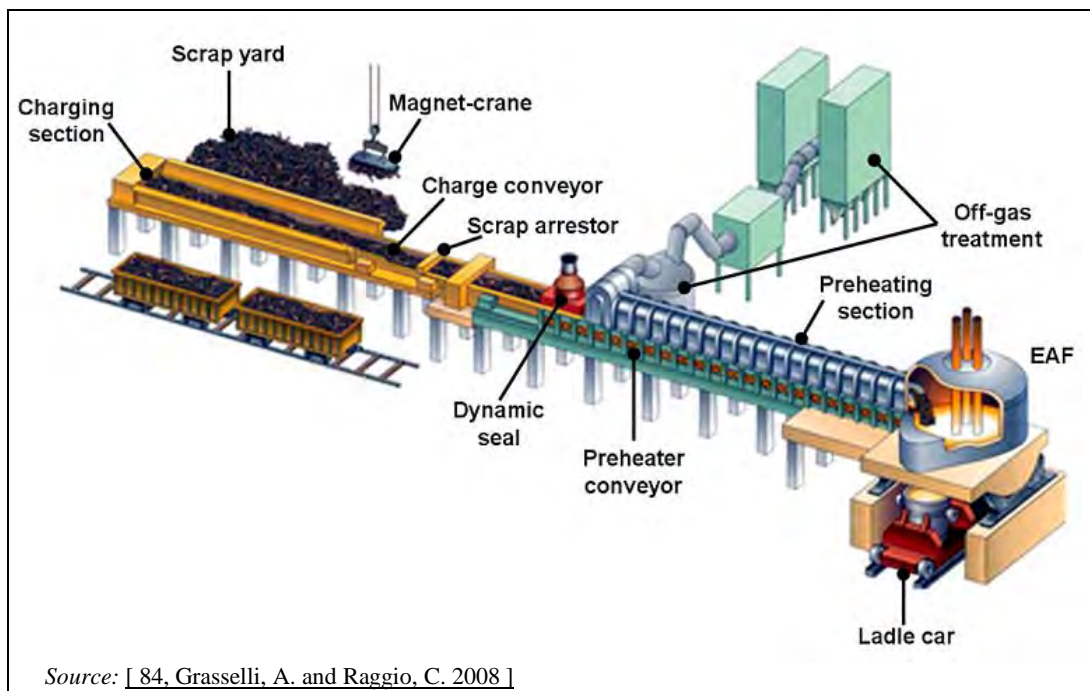

Figure 8.15: Schematic of the CONSTEEL process

Achieved environmental benefits

With shaft furnaces, very high scrap preheating temperatures of up to 800 – 1000 °C can be achieved. With the described techniques for scrap preheating 70 – 100 kWh/t LS energy can be saved which is about 10 – 25 % of the overall electricity input. Calculated on the basis of primary energy, the savings might be higher considering the efficiency of energy supply. In addition, the two scrap preheating solutions reduce the tap-to-tap time since less electric energy needs to be put into the charge and downtime for batch charging is reduced.

In combination with an advanced off-gas treatment, scrap preheating plays a significant role in the optimisation of EAF steelmaking, not only related to productivity but also to the minimisation of emissions.

As a side effect, scrap preheating reduces raw dust emissions by about 20 % because the off-gas has to pass through the scrap which acts as a filter. This reduction correlates with an increase in the zinc content in the dust which supports its recycling.

With the continuous feeding systems, the scrap can be heated up to an average temperature of 300 °C, thus the efficiency of the furnace is increased and energy consumption is reduced. But the continuous feeding has some additional advantages including lower noise emissions.

All CO and H₂ are considered to have evolved from the melting process and are burnt to CO₂ and H₂O inside the preheater. The continuity of the process allows for achieving a stable off-gas exit temperature between 800 and 1100 °C, with an oxygen excess of 8 – 10 %, which allows for the complete destruction of PCDD/F. Provided that the off-gases are rapidly cooled below 200 to 250 °C, the risk of PCDD/F formation by de novo synthesis is considerably reduced.

Nevertheless, experiences from at least two continuous charging installations showed a high emissions concentrations for PCDD/F exceeding the value of 0.1 ng I-TEQ/Nm³ significantly [67, TSW GmbH 2005]. That means that additional measures for reducing PCDD/F to ensure emissions concentrations for PCDD/F below 0.1 ng I-TEQ/Nm³ may be necessary also for continuous charging techniques from case to case. Table 8.14 shows the measurement results of a continuous pollution measurement from one installation for an eight year operating period.

Table 8.14: Pollution measurements from one installation for an eight year operating period

Parameter	Units	1999 – 2007
Off-gas flow	Nm ³ /h	750000 – 800000
CO	mg/Nm ³	142 – 400
NO _x	mg/Nm ³	5 – 50
PCDD/F	ng I-TEQ/Nm ³	0.05 – 0.20
Dust (PM ₁₀)	mg/Nm ³	0.40 – 0.86
<i>Source: [84, Grasselli, A. and Raggio, C. 2008].</i>		

At the EAF Mo i Rana in 2008, a CONSTEEL furnace has been realised. To reduce the emissions of dust, dioxins and mercury downstream of the bag filter, a carbon filter has been installed. Measurements carried out both before and after the application of the Consteel furnace show that the dioxins and mercury have been reduced by more than 90 %.

Cross-media effects

Scrap preheating looks very attractive from the point of view of energy management. But the scrap preheating may lead to an important generation of organic pollutants due to the possible presence of organic substances on the scrap. Due to the process-specific low temperatures in the scrap column, the organic constituents adhering to the scrap, such as oils and greases, are only evaporated off but not thermally destroyed; one result here being the formation of volatile organic chlorinated hydrocarbon compounds and the precursor of PCDD/F [367, Prüm et al. 2005].

As mentioned before, high emissions of aromatic organohalogen compounds such as polychlorinated dibenzo-p-dioxins and -furans (PCDD/F), chlorobenzenes, polychlorinated biphenyls (PCB) as well as polycyclic aromatic hydrocarbons (PAH) and other partial combustion products may occur from scrap contaminated with paints, plastics, lubricants or other organic compounds. In one EAF with conventional scrap preheating, up to 9.2 ng I-TEQ/Nm³ have been measured.

These emissions can be minimised by post-combustion of the off-gas in a specially designed post-combustion chamber equipped with fossil fuel burners. Due to the high temperature to be reached in order to destroy the POPs (persistent organic pollutants) that are present in the off-

gas, the amount of energy required is considerable and of the order of magnitude of the energy savings provided by scrap preheating.

Operational data

Since its start-up, no CONSTEEL furnace has been stopped. The following table shows some operational data for selected scrap preheating systems applied to EAF furnaces.

Table 8.15: Process data from selected scrap preheating systems applied to EAF furnaces

Features	Unit	Consteel Plant 1	Consteel Plant 2	Consteel Plant 3		Fuchs-Coss Plant	SIMETAL Finger Shaft Plant 1		SIMETAL Finger Shaft Plant 2
Furnace type		DC	AC	AC			AC		DC
Heat size	t LS	109	187	73		120	126.5		80
Transformer power	MVA	90	130	50		100	85		56
Metallic charge mix		100 % scrap	80 % scrap 15 % pig iron	80 % scrap 20 % pig iron	80 % scrap 20 % hot metal	100 % scrap (¹)	100 % scrap	80 % scrap 20 % pig iron	100 % scrap
Tapping temperature	°C	1650	1630	1600		NA	1620	1673	1630
Average power	MW	55	82	37	33	NA	57	63	35
Additives	kg/t LS	26	32	41	60	58	50	48	NA
Power on time	min	41	50	43	35	40	40	30	38
Power off time	min	8	15	7	7	NA	10	17	12
Electrical consumption	kWh/t LS	343	365	362	265	300	300	248	278
Oxygen consumption	Nm ³ /t LS	35.5	33	34	35	38	34	37	44
Electrode consumption	kg/t LS	0.8	0.9	1.4	1.2	1.2	1.3	1.1	0.8
Scrap preheating efficiency									
Scrap temperature after preheating	°C	200 – 300				300 – 400	800 – 1000		
Scrap preheating efficiency	kWh/t LS	15				NA	80 – 100		
(¹) Can be theoretically achieved. The Coss plant in operation is applying 60 % scrap and 40 % hot metal. NB: NA = Data not available. Source: [58, Kaestli, P. 2009] [84, Grasselli, A. and Raggio, C. 2008] [364, Fuchs, G. 2008].									

Applicability

The CONSTEEL process is applicable to both new and existing plants. In existing plants, the local conditions related to the space availability and limitations for the conveyor installation and the scrapyard positioning have to be considered which may sometimes prevent the installation of such a technique. Scrap preheating systems do not require specially sized scrap more than the conventional EAF. The scrapyard groundwork is equivalent compared to the buckets-operating furnaces.

Economics

With finger shaft EAFs, tap-to-tap times of about 35 minutes are achieved which is about 10 – 15 minutes shorter compared with EAF without efficient scrap preheating. This allows for a very short payback time which is in the order of one year.

As an example, for a new steelmaking plant, producing about one million tonnes per year, the Consteel implementation usually represents about 10 –15 % of the total investment.

The cost of a revamping is in a range of EUR 5 million – 10 million and varies a lot according to the size of the furnace, layout and to the extent of the required modifications.

The overall cost savings achievable with the CONSTEEL process for a melt shop of one million tonnes per year productivity is around EUR 9.5 per tonne LS.

Driving force for implementation

The main driving force is to increase productivity, to reach a higher charge yield and lower conversion costs combined with a lower environmental impact. In some cases, scrap preheating by means of a finger shaft furnace has been installed in combination with advanced off-gas treatment.

Another main driver is the reduction in electrical disturbances in plants where the electrical power supply network is an issue.

Example plants

- Twin-shell shaft furnace with integrated preheating in a shaft: ASW, Montereau, France
- Two-finger shaft furnaces and one shaft furnace, Zhangjiagang, P. R. China
- Three-finger shaft furnaces Severstal AG, Russia
- Two-finger shaft furnaces Habas, Aliaga, Turkey
- Finger shaft furnace, Stahl Gerlafingen, Switzerland
- Finger shaft furnace, SUEZ Steel, Egypt
- CONSTEEL at TSW, Trier, Germany
- CONSTEEL at Celsa Mo i Rana, Norway
- CONSTEEL at ORI Martin, Brescia, Italy
- CONSTEEL at Acciaierie Arvedi, Cremona, Italy
- CONSTEEL at Sovel Hellenic Steel Company, Greece.

In January 2009, 31 shaft furnaces and 35 continuously operating CONSTEEL systems were installed worldwide, including those installations under construction.

Figure 8.16 shows the numbers of installed shaft, CONSTEEL and ESC furnaces between 1988 and 2009.

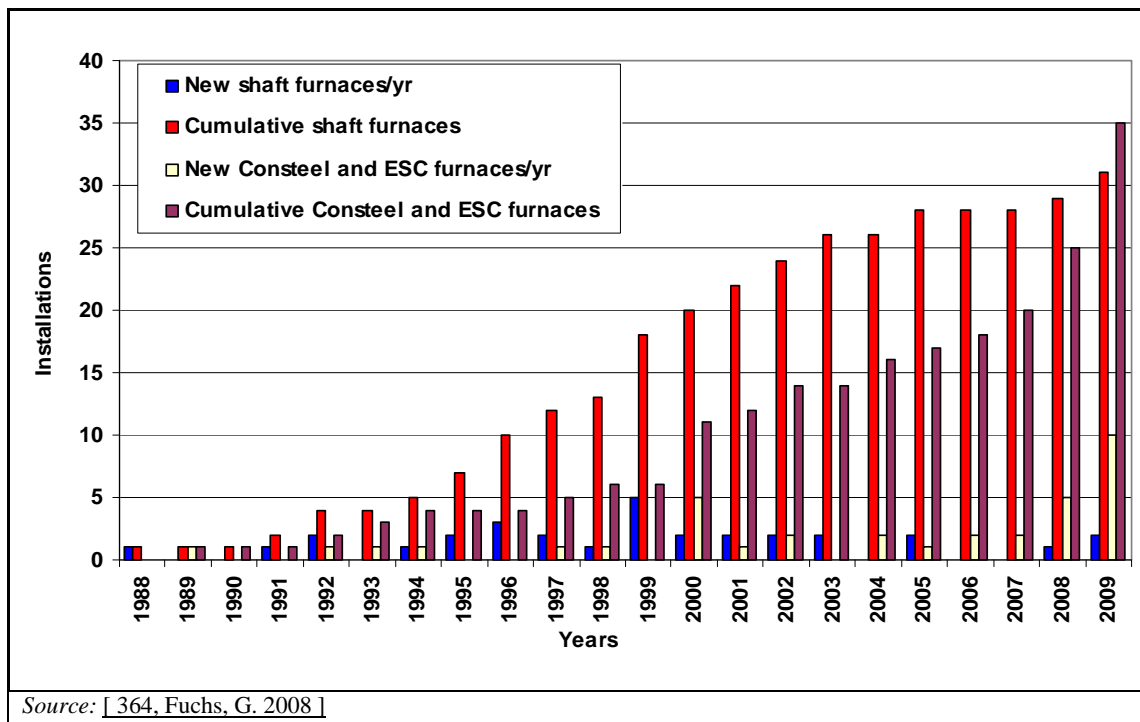

Figure 8.16: Number of preheating installations at EAF

Reference literature

[54, Haissig 1997] [84, Grasselli, A. and Raggio, C. 2008] [91, Memoli, F. and Ferri, M. 2007] [94, Mc Manus 1995] [125, Smith 1992] [162, Voss-Spilker et al. 1996] [208, Lindfors et al. 2006] [260, Germany 2007] [273, Eurofer 2007] [287, MVAE 2005] [364, Fuchs, G. 2008] [367, Prüm et al. 2005] [373, Eurofer 2007] [388, Fisher et al. 2005]

8.3.3 Reducing of dust emissions from slag processing

Description

If the slag is collected in a slag pot at the EAF, it needs to be poured into outside slag basins for solidification. The cooling of the slag may be enhanced by water sprays resulting in fumes.

If the slag is poured onto the floor, it is precrushed after solidification using excavators or shovel loaders and is subsequently brought to an outside storage area.

After a certain period of time, the slag is processed in crushing and screening devices in order to give it the desired consistency for separating metals from the slag and for its further use in construction. Slag breaking and metal recovery can create dust emissions.

In order to minimise dust emissions, the crushing and screening devices can be enclosed and extracted. The emission from crushing and screening are subsequently cleaned by means of a bag filter. The conveyor belts should be enclosed; transfer points can be wetted. If the processed slag is stored, heaps should be wetted. During the loading of broken slag, water fogs can be used to minimise dust emissions [85, VDI/DIN 2006] [260, Germany 2007] [273, Eurofer 2007] [373, Eurofer 2007].

Achieved environmental benefits

With this technique a residual dust concentration of $<10 - 20 \text{ mg/m}^3$ can be reached.

Cross-media effects

No data submitted.

Operational data

No data submitted.

Applicability

The technique is applicable to both new and existing plants.

Economics

No data submitted.

Driving force for implementation

The main driving force is to reduce particulate emissions.

Example plants

BSW, Kehl, Germany

Georgsmarienhütte, Osnabrück, Germany

Lech-Stahlwerke (LSW), Meitingen, Germany

Reference literature

[85, VDI/DIN 2006]

8.3.4 Advanced emission collection systems

Description

The primary and secondary emissions to air are of high relevance (see Section 8.2.2.1). Both primary and secondary emissions should be collected as much as possible, preferably at the source of origin and then abated. The combination of 4th hole (in case of three electrodes, e.g. AC) or 2nd hole (in the case of one electrode, e.g. DC), the direct extraction with canopy hood systems (or furnace enclosures) or total building evacuation are the preferred systems.

With a 4th or 2nd hole (see Figure 8.7), the primary emissions generated during the melting and refining periods can be collected almost completely. This type of direct extraction technology is state of the art in modern EAF steelmaking for the collection of primary emissions. It can also be applied to secondary metallurgy vessels.

In a canopy hood system (see Figure 8.7), one or more hoods over the furnace indirectly collect fumes escaping from the furnace during charging, melting, slag-off, and tapping steps (up to 90 % of primary emissions and also secondary emissions [22, EC EAF 1994]). Hood systems are commonly used within the electric EAF industry. Combined with direct extraction systems, the collection efficiency of primary emissions and also secondary emissions improves by up to 98 %. Hoods are also installed to collect emissions arising at secondary metallurgy vessels, hoppers and conveyor belts.

Furnace enclosures, also called doghouses (see Figure 8.7), usually encapsulate the furnace, its swinging roof, and also leave some working space in front of the furnace door. Typically, waste gases are extracted near the top of one of the walls of the enclosure, and make-up air enters through openings in the operating floor [36, EPRI 1992]. More complex handling steps, causing time losses and possibly higher investments (e.g. the need for additional door opening and closing mechanisms and procedures in order to charge and empty the furnace) are drawbacks of this type of collection technology. Collection rates of doghouses are similar to or usually slightly higher than those of hood-complementary hole combinations. A positive effect of furnace enclosures is a reduction in the noise level if they are constructed in a suitable manner. Noise abatement at an EAF plant by sound protecting enclosures can reduce the average sound pressure level between 10 and 20 dB(A) [79, Kuhner et al. 1996]. Furnace enclosures may also be applied at secondary metallurgy processes [22, EC EAF 1994] but a treatment of the shop walls is needed to eliminate reverberation.

Another way to collect secondary emissions from the furnace and other installations is a complete enclosure of all plants in one sealed building.

The erection of such buildings and the additionally required large dedusting installations in order to achieve complete dedusting impose considerable costs on the operators. For this reason, the costs and benefits need to be weighed carefully for every special plant before this option is considered. A positive effect of this measure is a reduction in the noise level penetrating the outside. Usually, the pressure in the enclosing building is below atmospheric pressure to prevent the escape of fumes through occasional door openings.

For a high collection rate, a sufficient extraction volume should be ensured. Depending on the collection system, exhausting volumes are often in the range of 600 000 – 1.2 million m³/h.

Achieved environmental benefits

The combination of direct fume extraction and a hood system is often used. This combination achieves a collection of about 98 % of the primary emissions. In addition, a significant share of charging and tapping (secondary) emissions can be collected, too, though this depends on the type and the number of hoods [22, EC EAF 1994]. A combination of a direct extraction device and a furnace enclosure can even achieve collection rates from 97 % – 100 % of the total dust emissions [57, Heinen 1997]. Total building evacuation also achieves practically 100 % emission collection.

In one case, the emission collection system was newly designed and optimised. This included the increase of the exhaust gas volume from 630 000 to 1 250 000 Nm³/h, a new lining of the roofs of the steelwork and the melt shop, renewal of the primary waste gas duct from the EAF and the addition of a bag filter, three fans and a new stack.

A comparison of dust emissions from the steelwork stacks before and after retrofitting is shown in Table 8.16.

Table 8.16: Comparison of dust emissions from the steelwork stacks before and after retrofitting (one steel work in Germany)

Parameter	Measured values	
	Concentration	Mass flow
Dust emissions from the steelwork stacks, daily average values until August 2006	4.5 – 5 mg/m ³	3.25 kg/h
Dust emissions from the steelwork stacks, daily average values from September 2006	0.35 mg/m ³	0.44 kg/h
Achieved improvement by the retrofitting	- 93 %	- 87 %
<i>Source: [355, Plickert 2007].</i>		

This measure has also improved the working environment significantly and reduced the diffuse dust emissions via roof fans from 6.35 mg/m³ to 2.5 mg/m³ which corresponds to a reduction of approximately 60 % [355, Plickert 2007].

Cross-media effects

The emission collection systems need energy, especially the fans.

Operational data

No data submitted.

Applicability

This technique is applicable both to new and existing plants.

Economics

No data submitted.

Driving force for implementation

The main driving force is to reduce particulate emissions.

Example plants

Many plants in Europe have a combination of direct off-gas extraction and hoods.

The following German plants are equipped with only doghouses or with a combination of doghouse and direct hole extraction: Benteler AG, Lingen; ThyssenKrupp Nirosta, Bochum; ThyssenKrupp Nirosta, Krefeld; Mannesmannrohr GmbH, Bous/Saar; TSW, Trier; Stahlwerke Thüringen GmbH, Unterwellenborn, Elbe and Stahlwerke Feralpi, Riesa.

Total building evacuation: ArcelorMittal, Schifflange; Differdange and Belval, all in Luxembourg.

Reference literature

[16, Rentz 1997] [22, EC EAF 1994] [57, Heinen 1997]. [208, Lindfors et al. 2006] [366, Dornseiffer et al. 2007] [373, Eurofer 2007]

8.3.5 Abatement techniques for primary and secondary emissions to air from electric arc furnaces

Abatement techniques for primary and secondary emissions to air from EAFs (for example PCDD/F concentrations in air emission) refer to the total primary and secondary emissions.

Therefore if primary and secondary emissions are treated separately, the concentration indicated as achievable performance should be compared with the weighted average of concentrations in primary and secondary emissions, both measured downstream of the dust collection system.

8.3.5.1 Dust abatement by means of a bag filter and an electrostatic precipitator

Description

By far the most common dust abatement technique in electric arc furnace (EAF) operations is the bag filter (also called bag house) which is particularly suited to the type of dust generated in the EAF. Bag filters are very effective in capturing all particle-bound pollutants, e.g. heavy metals as well as organochlorine pollutants such as PCDD/F particularly if adsorption agents are used (see Section 8.3.5.3).

The off-gas flow from primary and secondary exhausting depends on the collection system. Exhausting volumes are often in the range of 600 000 – 1.4 million m³/h. For large bag filters as generally required in EAF steelmaking plants, a design with tubular fabric bags of around 6 m long and about 200 mm in diameter is chosen. A very important design parameter for bag filters is the air-to-cloth ratio which is, in the case of the EAF process, often between 1 and 1.3 (m³/min/m²).

A typical filter material for the application in EAF is a spark-resistant polyester or a PTFE-coated needle felt. However, an important issue for a sound bag filter operation is to prevent incandescent particles from reaching the filtering medium and thus burning holes into it. For this purpose, spark arresting devices, such as cyclones are often installed in the raw gas ducts.

Cleaning of the fabric, i.e. removing the dust periodically that has accumulated on the fabric surface is performed either by mechanical shaking or with a continuous, fully-automated online pulse jet (compressed air) cleaning system which means that the process flow continues during

cleaning. The dust cakes falling from the bags are collected in dustbins below the bags and are carried outside the filter by a conveying system.

In some rare EAF plants, ESPs are used but with a slightly less performance abatement efficiency.

Achieved environmental benefits

Figure 8.17 shows the dust emissions profile from one EAF plant for three years (2004 – 2006). The data show that with well designed and well operated bag filters, annual dust emission values of 1 mg/Nm^3 are achievable. A well designed and well maintained bag filter has a residual emission of less than 5 mg/Nm^3 (daily average).

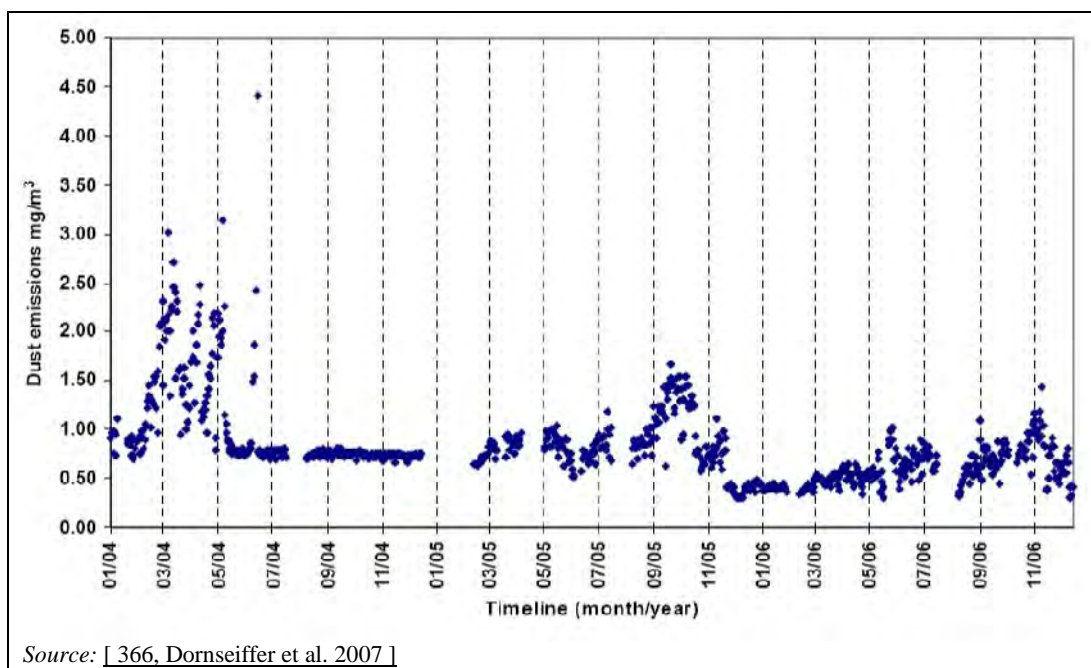

Figure 8.17: Daily average dust emissions from an EAF plant over three years

The detailed results from the continuous dust measurements in the aforementioned three EAF plants over three years are shown in the Table 8.17.

Table 8.17: Daily average dust emissions from three EAF installations (2004 – 2006)

Measurement result	EAF A	EAF B	EAF C	Unit
Mean	0.84	0.85	0.53	mg/Nm^3
Standard deviation	0.47	0.40	0.58	mg/Nm^3
Minimum	0.30	0.05	0.01	mg/Nm^3
Maximum	7.82	4.35	7.36	mg/Nm^3
Number of values	902	716	1054	

Source: [366, Dornseiffer et al. 2007].

Table 8.18 shows the results from seven dust and heavy metals measurements carried out in Germany and Austria and two in the Netherlands.

Table 8.18: Residual dust and heavy metals concentrations from nine EAF installations after abatement

Parameter		Bag filter	Electrostatic precipitator ⁽¹⁾	Unit
Dust		0.35 – 3.4	1.8	mg/Nm ³
Metals:	Hg	0.001 – 0.019		mg/Nm ³
	Sum of Sb, Pb, Cr, CN, F, Cu, Mn, V, Se, Te, Ni, Co, Sn	0.006 – 0.022	<0.0003	mg/Nm ³
	Cr (except Cr (VI))	0.013	0.01 – 0.07	mg/Nm ³
	Mn	0.036		mg/Nm ³
	Ni	0.003		mg/Nm ³
⁽¹⁾ ESP applied in stainless steel production. NB: — Values are annual averages and relate to the central dedusting system. — PAH contains benzo(a)pyrene and dibenzo(a,h)anthracene. Source: [191, Infomil 2010] [244, Plickert 2007] [277, Wiesenberger 2007] [355, Plickert 2007].				

Cross-media effects

Bag filters capture essentially dust including all of the heavy metals that are present as particulates at the filtering temperature as well as the organic substances that are adsorbed to the dusts, among them PCDDs and PCDFs. Bag filters play an essential role in PCDD/F abatement as described in Sections 8.3.5.2 and 8.3.5.3.

Operational data

Higher emissions may occur when, for instance, parts of the bag filters are destroyed. This can be avoided by good operation which consists of the continuous monitoring of dust emissions and consequent replacement of all destroyed bag filters. Good design consists of well dimensioned bag chambers thus minimising mechanical wear, spark arrestors and temperature control and the detection of excessive dust accumulations.

There are different types of fabric used for the manufacturing of filter bags. Some allow maximum temperatures of 125 – 130 °C, others may be used at temperatures up to 250 °C. The fabrics suited for low-temperature filtration tend to have higher abatement efficiencies. The off-gas flow should be cooled down to the suitable temperature. This is often done by mixing the primary and secondary flows. If the resulting temperature is still too high, and in case of separate filtering of the primary and the secondary flow, additional cooling devices need to be installed in the primary off-gas flow.

Electricity consumption is approximately 20 – 28 kWh/t liquid steel for bag filters and whole building evacuation.

Applicability

Waste gas treatment with a bag filter is applicable for new and existing plants.

Economics

No data submitted.

Driving force for implementation

No data submitted.

Example plants

Most European EAF steelmaking plants use fabric filters for dust abatement.

Examples of the aforementioned technique are given in Table 8.19.

Table 8.19: Example plants using dust abatement techniques

Example plants	Description
Luxembourg	Three EAFs plants
Böhler Edelstahl, Kapfenberg Austria	The EAF plant produces high alloyed steel with a total capacity of 180000 tonnes per year. The steelwork includes an EAF with 50 tonnes per charge, ladle metallurgy with an AOD converter and a special steelwork with vacuum treatment and remelting units. For primary dedusting, main emission sources (EAF and AOD converter) are enclosed. The waste gas extracted from both emission sources is treated by a bag filter. Waste gas volume is about 900000 Nm ³ /h
Marienhütte, Graz, Austria	EAF plant producing about 365000 t/yr carbon steel, which is processed into steel bars and reinforcing steel. The EAF has a capacity of 35 t. During the melting process, primary emissions are extracted from the 4 th hole of the EAF. Secondary emissions are collected by a roof hood extraction. Primary and secondary emissions are conducted through a mixing chamber and treated together in a bag house filter. Total waste gas volume is about 1 million Nm ³ /h
Elbe Stahlwerke Feralpi, Riesa, Germany	The off-gas volume is about 1 250000 Nm ³ /h; the filter area is 19270 m ²
BSW, Kehl, Germany	The off-gas volume is approximately 1 800000 Nm ³ /h; the filter area is 38000 m ²
Ovako Imatra, Finland	The off-gas volume is approximately 620000 Nm ³ /h, the filter area is 9400 m ² . Filter material is PTFE-coated needle felt, filter cleaning with a pulse-jet system, and continuous monitoring by two systems: the tribumetric measuring system by SINTROL [®] and the optical measuring system SICK [®]
<i>Source:</i> [208, Lindfors et al. 2006] [277, Wiesenberger 2007] [360, Sick-Maihak 2006] [366, Dornseiffer et al. 2007] [355, Plickert 2007] [REFERENCE_BOOKMARK_8669.	

Reference literature

[140, Eurofer 2009] [208, Lindfors et al. 2006] [244, Plickert 2007] [277, Wiesenberger 2007] [355, Plickert 2007] [366, Dornseiffer et al. 2007] [367, Prüm et al. 2005] [375, IISI 1998] [388, Fisher et al. 2005]

8.3.5.2 Reduction of PCDD/F by means of post-combustion and quenching in combination with a bag filter

Description

Post-combustion in a combustion chamber aims primarily at the full combustion of CO and H₂ remaining in the off-gas in order to avoid uncontrollable reactions in the gas cleaning equipment.

Secondarily, this post-combustion, when it is well optimised (i.e. when the temperature and the residual time are adequate) reduces the emission of organic and organochlorine compounds such as PAH, PCB or PCDD/F. Post-combustion with the additional aim of minimising organic micropollutants needs an adequate retention time, turbulence and temperature (the three Ts).

The heat produced by this combustion is generally not recovered unless recovery from cooling water is possible.

To prevent the de novo synthesis of PCDD/F, it is essential to have a rapid cooling (quenching) of the fumes as soon as possible after post-combustion to a temperature of below 250 °C at which all risk of de novo synthesis is excluded. In some cases, this might be obtained by dilution of the secondary circuit; mostly, however this cooling is obtained by water injection in a quenching tower. Figure 8.18 shows the post-combustion of the primary off-gas from an EAF with subsequent rapid cooling.

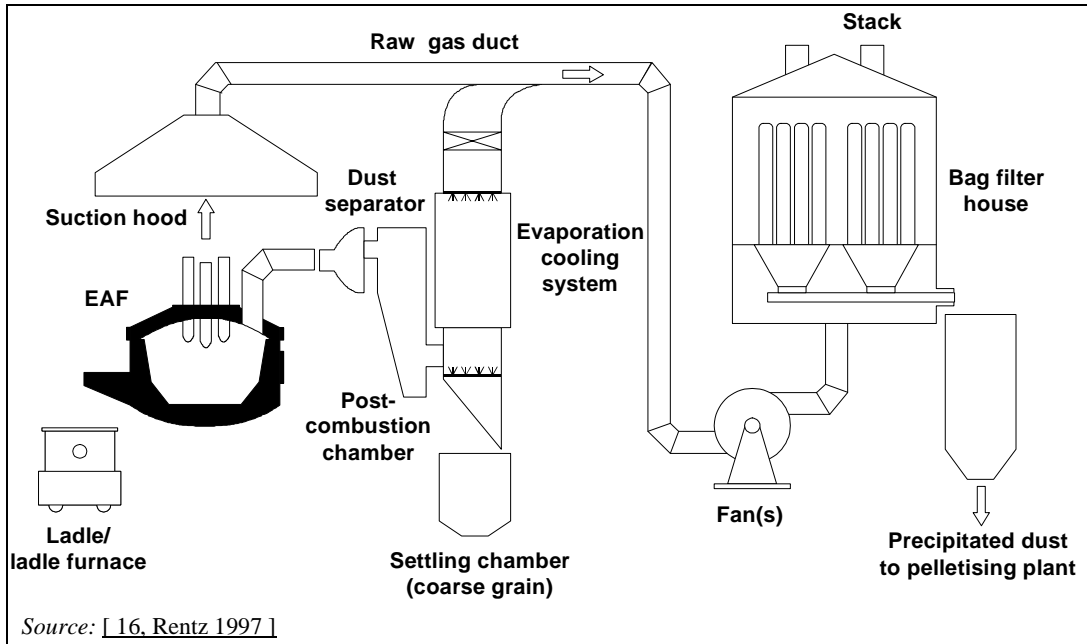

Figure 8.18: Post-combustion of the primary off-gas from an EAF with subsequent rapid cooling

Achieved environmental benefits

Figure 8.19 shows the PCDD/F concentrations measured at two EAFs with post-combustion and rapid quenching were between 0.102 and 0.7 ng I-TEQ/Nm³. The main reasons for the observed lack of reliability of this technique are considered to be:

- insufficient temperature level reached in the post-combustion chamber during the first few minutes of the EAF melting process, exactly the time when probably the highest load of organic pollution is carried from the furnace
- the distance between the post-combustion chamber and the quenching tower, in this specific case due to the retrofitting situation, was long and thus there was a permanent potential for the de novo synthesis. A quenching system right next to the post-combustion chamber would most likely have given much better results.

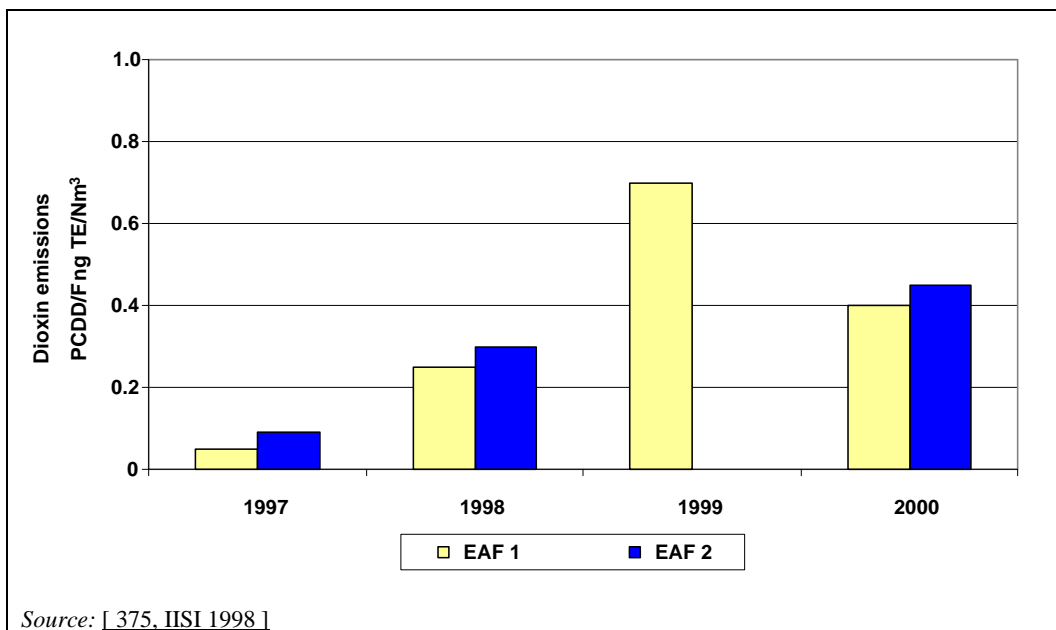

Figure 8.19: Average annual dioxin emission concentrations from two EAFs with post-combustion and rapid cooling (1997 – 2000)

Table 8.20 shows the results from seven dust, PAH and PCDD/F measurements put through in Germany and Austria.

Table 8.20: Dust, PAH and PCDD/F emissions concentrations after abatement

Parameter	Bag filter	Unit
Dust	0.35 – 3.4	mg/Nm ³
PAH	<0.00001	mg/Nm ³
PCDD/F	0.0015 – 0.1 ⁽¹⁾	ng I-TEQ/Nm ³
⁽¹⁾ Upper end of the range relates to measurements carried out in 1997. NB: — Values are annual averages and relate to the central dedusting system. — PAH contains benzo(a)pyrene and dibenzo(a,h)anthracene. <i>Source:</i> [244, Plickert 2007] REFERENCE BOOKMARK 8669[277, Wiesenberger 2007] [355, Plickert 2007].		

In general with proper post-combustion followed by rapid cooling (by dilution with air or water quenching) emission concentrations of PCDD/F of lower than <0.1 ng I-TEQ/Nm³ can be achieved. In some cases, for the aforementioned reasons higher PCDD/F concentrations can occur.

The following Table 8.21 shows additional results for dust and PCDD/F measurements from four EAFs with post-combustion and rapid quenching in Germany.

Table 8.21: Performance of post-combustion and rapid cooling at four German EAF

PLANT													
	EAF 1		EAF 2			EAF 3		EAF 4 ⁽¹⁾					
Features													
Tapping weight (t)	105		138			85/85		150					
Power supply (MVA)	105		96			57/68		135					
Collection of emissions	4 th hole, hood		4 th hole, hood			4 th hole, hood		4 th hole, (prim.) doghouse with two exhausts (sec. 1 and 2)					
Post-combustion (PC)	PC chamber (air)		PC in duct			PC chamber (air)		PC in duct					
Waste gas cooling	Injection of water		Water conditioning of waste gas			Spray cooling system (quenching)		Air-cooled heat exchanger					
Off-gas cleaning system	Bag filter		Electrostatic precipitator			Bag filter (1 for both)		Bag filters					
Number of measurements at the plant	1	2	1	2	3	1	2	1	2	3	4	5	6
Gas concentrations: ⁽²⁾													
Dust in crude gas (prim.)	3398	14246	4200	12500	3600	–	–	–	–	–			
Dust in crude gas (sec.)	148	273	Prim. and sec. together										
Dust in clean gas (prim.)	0.76	1.05	15	15	18	1.45	1.1	<1.1					
Dust in clean gas (sec.)	Average ⁽³⁾		Average ⁽³⁾			Average ⁽³⁾		0.54 ⁽⁴⁾ 1.8 ⁽⁴⁾					
PCDD/F (prim.)	–	–	–	–	–	–	–	0.09	0.047	0.084	0.022	0.02	0.08
PCDD/F (sec.)	–	–	–	–	–	–	–	–	0.025 0.015	0.043 0.024	0.009 0.08	0.013 0.04	0.013 0.08
PCDD/F (Mix, prim. and sec.)	0.016	0.021	0.01	0.02	0.01	0.13	0.1	–	–	–	–	–	–
⁽¹⁾ Measurements were carried out in 2008. ⁽²⁾ Crude and clean gas dust concentrations in mg/Nm ³ ; PCDD/F concentration in ng I-TEQ/Nm ³ . ⁽³⁾ Average of two measurement spots. ⁽⁴⁾ Two values refer to secondary 1 and secondary 2. NB: – = Not relevant or no information available. (prim.) = Concentrations after dedusting device for primary off-gases. (sec.) = Concentrations after dedusting device for secondary off-gases. Source: [16, Rentz 1997] [137, Theobald 1995] [177, Eurofer 2009] [189, N.N. 2008].													

Cross-media effects

Post-combustion with additional burners consumes considerable quantities of energy (in the order of 30 kWh/t). Since the hot off-gases need to be quenched to prevent de novo synthesis of PCDD/F, the energy cannot be recovered.

Operational data

The water consumption for quenching can be up to 40 tonnes per hour.

The thermal combustion before quenching can be obtained with natural gas burners in post-combustion chambers.

Applicability

The post-combustion unit at BSW, Kehl, Germany operates without significant problems.

In principle, post-combustion can be applied to both new and existing plants but in existing ones the local circumstances and possibilities (like available space, given off-gas duct system, etc.) should be checked on a plant by plant basis.

Economics

The investment costs for a quenching tower were about EUR 1.2 millions in 1997. More economic data are not available. This represents a higher investment compared to an adsorption process (see Section 8.3.5.3)

Driving force for implementation

The main driving force for the implementation of post-combustion and subsequent rapid cooling are the environmental and health concerns for reducing PCDD/F emissions.

Example plants

BSW, Kehl, Germany; Salzgitter AG, Peine, Germany; B.E.S., Brandenburg, Germany; HSE. Henningsdorfer Stahl Engineering GmbH, Henningsdorf, Germany; DEW, Witten, Germany; ArcelorMittal, Hamburg, Germany; Gerlafingen Stahl AG, Gerlafingen, Switzerland; ArcelorMittal, Differdange and Esch-Belval, both in Luxembourg.

Reference literature

[68, Karcher et al. 1996] [73, Knapp 1996] [167, Werner 1997] [366, Dornseiffer et al. 2007] [367, Prüm et al. 2005] [373, Eurofer 2007] [375, IISI 1998]

8.3.5.3 Reduction of PCDD/F by means of adsorbent materials in combination with bag filters**Description**

In order to reduce persistent organic pollutants, especially PCDD/F, in the total off-gas (primary and secondary emissions), adsorbents (e. g. activated carbon, pulverised activated lignite coke or mixtures of these with lime) can be dosed to the exhaust duct before the dust abatement device. The necessary amount depends on the type and size of the adsorbent. Usually it is between 20 and 150 mg/Nm³ off-gas. The size of pulverised activated lignite coke is typically between 0 and 0.4 mm, on average 0.63 µm. Being milled, the average size is about 24 µm which leads to lower dosing rates. Carbonaceous adsorbents used have an average grain size of around 25 µm.

Adsorption takes place in three steps; first, when the stream of adsorption agent hits the raw gas flow, secondly as the adsorbent-enriched raw gas travels to the filtering device, and thirdly, (especially with the use of bag filters) as the gas phase crosses the adsorbent-enriched dust coating layer on the filter medium [63, Wirling, J. 2007].

The carbon to which the PCDD/F molecules are adsorbed is separated from the gas phase together with the EAF dust contained in the raw gas in the subsequent bag filters.

Figure 8.20 shows a schematic of an adsorbent injection system.

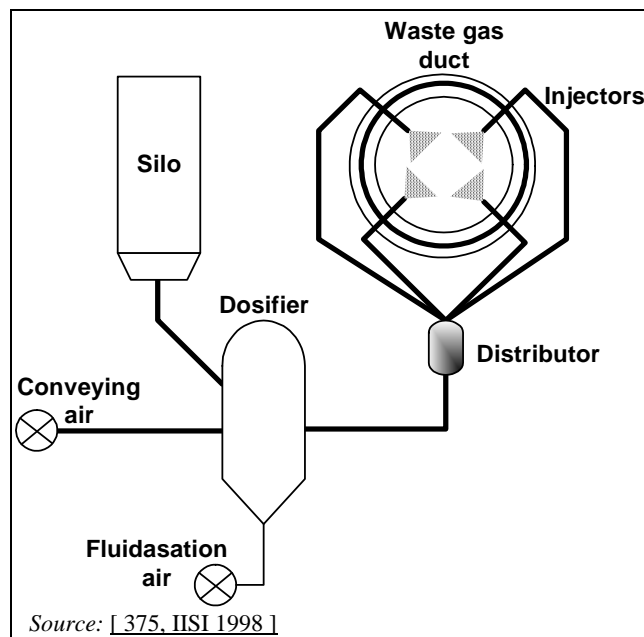

Figure 8.20: Schematic of an adsorbent injection system

Achieved environmental benefits

Residual PCDD/F emission concentrations of 0.01 – 0.1 ng I-TEQ/Nm³ are achievable in practice. Some calculations, using the factors given in Section 8.2.2.1.3 show these emissions values to correspond to 0.01 – 0.14 ng WHO-TEQ PCDD/F (including dioxin-like PCB). The removal efficiency is quite stable and reliable.

Besides PCDD/F adsorption, activated carbon and pulverised activated lignite coke have shown a high efficiency of separation of heavy metals and a certain efficiency in removing mercury from the gas phase. Table 8.22 shows the PCDD/F reduction as a result of pulverised activated lignite coke injection.

Table 8.22: PCDD/F reduction as a result of pulverised activated lignite coke injection

EAF plant	Gas flow (1000 Nm ³ /h)	Addition of lignite coke adsorbent (kg/h)	PCDD/F Emission concentration without adsorbent injection (ng I-TEQ/Nm ³)	PCDD/F Emission concentration with adsorbent injection (ng I-TEQ/Nm ³)
A	750	100 ⁽¹⁾	0.178 – 1.44	0.085 – 0.226
		35 ⁽²⁾		0.003 – 0.008
		25 ⁽²⁾		0.023 – 0.092
B	850	40 ⁽²⁾	0.072 – 0.722	0.007 – 0.032
C	770	50 ⁽²⁾	0.040 – 0.714	0.005 – 0.075
D	690	15 ⁽²⁾	<2.0	<0.05
E	840	20 ⁽²⁾		0.002 – 0.007
F	1250			0.015 – 0.04

⁽¹⁾ Standard quality lignite coke; particulate size 63 µm (300 m²/g).
⁽²⁾ Supermilled activated lignite coke; particulate size 24 µm (1200 m²/g); considered to have a high pyrophoric index.
 NB: Data from 1999 – 2004.
 Source: [260, Germany 2007] [277, Wiesenberger 2007] [367, Prüm et al. 2005] [368, Prüm et al. 2004] [375, IISI 1998].

Table 8.23 shows the results of the dioxin measurements according to the progress after gradual retrofitting and optimisation of the abatement system of an EAF plant by installation of a second injection systems for activated coal in the collection ducts prior to the bag filter. The volume of the exhausted waste gas is approximately 1250000 Nm³/h.

Table 8.23: Progress in PCDD/F abatement after installation of a second carbon injection system

	PCDD/F Emission concentration
After start-up of first injection system for activated coal	
Average concentration from three measurements in September, October and November 2006	0.04 ng I-TEQ/Nm ³
After start-up of second injection system for activated coal	
Measurement 06 – 08 March 2007	0.015 ng I-TEQ/Nm ³
<i>Source: [355, Plickert 2007].</i>	

Investigations show that the persistent organic pollutants, such as PCDD/F, adsorbed on activated lignite coke are bonded irreversibly due to the high bonding forces and are reliably destroyed or catalytically decomposed during the thermal treatment of dust.

Cross-media effects

The amount of energy needed for pulverised activated lignite coke dosage is not considerable. The filter dust contains the lignite coke powder and slightly increased PCDD/F amounts but this does not interfere with dust treatments for the recovery of non-ferrous metals.

Operational data

Attention should be paid to the final carbon content of the dust mixture abated at the bag filter. In order to prevent the risk of ignition, the carbon content of the EAF dust should stay below 4 %.

The use of activated carbon or lignite coke differs in grain size and in the effective adsorption surface area and consequently in the amount of injection required. Activated coal has the highest specific free surface and shows a very good adsorptive effect. Activated lignite coke is a

more economic alternative than activated coke and the supermilled lignite coke with a diameter of 0.024 mm also shows a very good adsorptive efficiency and leads to half the dosing rates necessary compared to standard lignite coke [367, Prüm et al. 2005]. Sometime inerts have to be added to the injected carbon-based materials to prevent ignition. Table 8.24 shows the characteristics of different adsorbents and absorbent materials.

Table 8.24: Characteristics of different adsorbent and absorption materials

Adsorption and absorption materials		Grain size (mm)	Surface area BET ⁽¹⁾ (m ² /g)	Precipitative pollutants
Standard powdered activated lignite coke	Carbon	0.063	300 – 400	Organics, heavy metals
Supermilled powdered activated lignite coke	Carbon	0.024	1200	
Powdered activated (charcoal) carbon	Carbon		500 – 1600	
Zeolite	Z		4 – 90	

⁽¹⁾ BET: Abbreviation created from the initials of the family names of the people who developed this theory as a rule for the physical adsorption of gas molecules on a solid surface.

Comprehensive investigations have shown that only a very short contact time is required to have PCDD/F adsorbed on activated lignite coke. However, the separation efficiency depends on the probability of contact between the sorbent and the pollutant molecule. The distribution of the adsorbent in the waste gas flow plays a major role here. An important precondition for achieving optimum separation efficiency is the presence of a homogeneous and, at the same time, turbulent mixture already at the injection point where the first pollutant separation step takes place. A significant factor in selecting the adsorbents is an optimum pore radius distribution for pollutant molecule adsorption.

Provisions should be taken to prevent sparks from reaching the bag filters in order to prevent possible glow fires, since the increased carbon content of the separated dust may increase its ignitability. The explosion risk has been assessed to be low. Fire and explosion protection is achieved through a combination of prevention measures (e.g. adsorbent inertisation, avoidance of entry of sparks, limiting the amount of adsorbent in the filter dust). Some techniques applied are the use of spark detectors, nitrogen flooding systems, temperature surveillance in the bag house, and detection of dust accumulations in the bag house collecting bins. Spontaneous ignition reactions of the filter dust are reliably prevented through consistent avoidance of large volume deposits in the plant section subjected to hot gas flows.

The low PCDD/F emissions in the clean gas attainable with dosing rates of 25 – 35 mg/Nm³ illustrate the high adsorptive effect of lignite coke adsorber.

Applicability

This technique is applicable to both new and existing plants.

Economics

Investment for the total off-gas flow (primary and secondary off-gases) from an EAF plant producing about 1 Mt steel/yr is about EUR 500000.

Driving force for implementation

The main driving forces for the implementation of this technique for reducing PCDD/F are environmental and health concerns and, in the case of Feralpi in Riesa, Germany, the increase in production capacity.

Example plants

The technique has been implemented in several European EAF plants since 1997.

ArcelorMittal, Esch-Belval, Differdange and Schifflange, all in Luxembourg; Swiss Steel, Gerlafingen, Switzerland; Stahlwerk Thüringen, Unterwellenborn, Germany; Elbe Stahlwerke Feralpi, Riesa, Germany; ArcelorMittal, Genk, Belgium.

Reference literature

[260, Germany 2007] [277, Wiesenberger 2007] [355, Plickert 2007] [366, Dornseiffer et al. 2007] [367, Prüm et al. 2005] [368, Prüm et al. 2004] [373, Eurofer 2007] [375, IISI 1998]

8.3.6 Treatment of waste water from continuous casting**Description**

Water is used in continuous casting machines for direct cooling of the slabs, blooms and billets. A contaminated process water flow is therefore generated. In many cases, this waste water is treated together with waste water streams from the hot rolling mills. After treatment, the water is recirculated.

The casting mould and the inner part of the rollers are usually cooled with water in a closed circuit and are not considered here.

The main pollutants are suspended solids and oil. The main measures to reduce discharges to water are a high rate of recirculation along with sedimentation and/or filtration of the bleed. Skimming tanks can be used to remove oil.

The spray water is commonly precipitated by sand filtration prior to or after cooling in an evaporative cooling tower. Sand filtration helps to ensure low levels of particulate and oil contamination to achieve satisfactorily prolonged operation of the secondary spray nozzles of the casting machine. The bleed from the open circuit to control the level of dissolved solids should be taken from downstream of the sand filtration plant to minimise the discharge of suspended solids and any oil/grease contamination. To prevent the clogging of the sand filter, oil skimming should be installed before the sand filters.

The techniques for the treatment of waste water from continuous casting can be considered to be similar to those described in Section 7.3.4.

Achieved environmental benefits

In Table 8.25: Composition of the waste water flows from direct cooling at BSW, Kehl, Germany after waste water treatment (2008) an example of the composition of waste water from direct cooling in the continuous casting process and hot rolling mill process is given.

Table 8.25: Composition of the waste water flows from direct cooling at BSW, Kehl, Germany after waste water treatment (2008)

	Units	Continuous casting after sand filtration ⁽¹⁾	Hot rolling mill after sand filtration ⁽¹⁾
Flow	m ³ /h	421	802
Temperature	°C	39	30
Suspended solids	mg/l	30.8	4.8
TOC	mg/l	1.33	1.85
AOX	mg/l	<0.01	<0.01
Fe	mg/l	0.053	<0.1
Zinc	mg/l	<0.05	<0.05
Ni	mg/l	<0.02	<0.02
Copper	mg/l	<0.02	<0.02
Mineral oil hydrocarbons (mg/l)	mg/l	<0.1	<0.1
⁽¹⁾ 24-hour random sample.			
Source: [178, N.N. 2008].			

Cross-media effects

No data submitted.

Operational data

No data submitted.

Applicability

A high recirculation rate and a treatment of the bleed can be applied at both new and existing plants.

Economics

No data submitted.

Driving force for implementation

No data submitted.

Example plants

BSW, Kehl, Germany

TSW, Trier, Germany.

Reference literature

[178, N.N. 2008]

8.3.7 Closed loop water cooling system**Description**

Generally, water is only used in the EAF steelmaking processes in connection with non-contact cooling, and only if a wet scrubbing technique for off-gas cleaning is used. As wet scrubbing is only applied in few cases, this topic is not further investigated in this section. The most relevant use of water considered here is the water used for the cooling of the elements of the furnace. Additionally, some water may be used for the cooling of waste gas or in the secondary metallurgy step. The water needed for the cooling elements amounts to 5 – 12 m³/m²h [16, Rentz 1997].

Achieved environmental benefits

By application of this technique no discharge of waste water occurs.

Cross-media effects

The closed loop system requires additional energy for water pumping and water recooling.

Operational data

No data submitted.

Applicability

This technique can be applied at both new and existing plants.

Economics

No data submitted.

Driving force for implementation

Legal requirements and limited availability of cooling water are the driving forces for the implementation of this technique.

Example plants

Preussag Stahl AG, Peine, Germany; BSW, Kehl, Germany and many other plants in the EU.

Almost all EU EAF plants use closed loop water cooling.

Reference literature

[16, Rentz 1997]

8.3.8 EAF dust processing for the recovery of heavy metals**Description**

Depending on the type of steel produced, about 10 – 30 kg/t steel of dust are separated from the off-gas (see Table 8.1).

Separated dusts obtained by the gas cleaning facilities usually contain a significant share of heavy metals. In the case of carbon steel, essentially zinc and, to a lesser extent, lead are present (see Table 8.10) and in the case of stainless steel, substantial amounts of chromium and nickel are present apart from zinc.

Processes for zinc recovery and recovery or removal of other heavy metals are suitable options for reclaiming valuable resources that have already been mined and treated at least once. Pyrometallurgical and hydrometallurgical options exist for the recovery of zinc, in principle. For dusts from the production of carbon/low alloyed steel, different techniques exist and are operated mostly by companies that have close links to the non-ferrous metals production sector.

For the recovery of EAF dusts it is desirable to have high concentration levels of heavy metals to operate economically. In order to increase the zinc content of their dust, some EAF operators recycle part of the generated dust back into the furnace.

Achieved environmental benefits

These heavy metals are toxic and might be leachable, necessitating special care for further processing and possibly the landfilling of the dusts.

Quantitative recovery of dust and the recycling of heavy metals can be achieved. The options described are desirable to different degrees according to their potential to satisfy the aim of prevention and control of environmental pollution. The use of the iron and heavy metal content of the dust is preferred compared to landfilling.

Cross-media effects

The recycling of precipitated EAF dusts for zinc enrichment by returning them to the EAF results in certain impacts on the steelmaking process, such as increased energy consumption. Also the method of dust addition to the furnace might affect the performance of the furnace.

In the case of pelletisation of the dust before transport/recycling, additional energy is needed since pelletisation and additional dust emissions may occur.

Operational data

No data submitted.

Applicability

This technique is applicable to both new and existing plants.

Economics

No data submitted.

Driving force for implementation

The main driving forces for the implementation of this technique are limited space for landfilling, stringent standards for landfilling and cost aspects like taxes on landfilled wastes.

Example plants

There are many plants in the EU that have examples of dust recovery to external plants.

One example is the EAF Marienhütte, Graz, Austria where about 6.9 tonnes of dust per year arise from waste gas treatment of the EAF. The dust with a zinc content of about 38 % is treated externally in order to recover the zinc.

Reference literature

[16, Rentz 1997] [69, Kemeny 1994] [116, Rentz et al. 1996] [373, Eurofer 2007] [391, Tavernier et al. 2004] [394, Colletta et al. 2002]

8.3.9 EAF slag processing

Description

In an EAF operation, some 60 – 270 kg of slag per tonne of steel are generated according to a tight specification, with the aim of performing metallurgical work (see Table 8.1). Solidified EAF slag from carbon steel production can be regarded as an artificial rock, similar to natural rock, consisting of iron oxides (FeO), lime (CaO), silicon dioxide (SiO₂), and other oxides (MgO, Al₂O₃, MnO) (see Table 8.7). EAF slags are characterised by high strength, good weathering resistance, and also high resistance against abrasion. They also have properties that make them suitable for use in hydraulic engineering [57, Heinen 1997]. An important criterion for the use of EAF slag in general is the consistency in volume, which depends on the presence of free lime.

Most of the slags from low carbon steel grades are relatively low in free lime (see Table 8.7) and are suitable for various applications like road construction, earthfill and hydraulic engineering. EAF slags from carbon steel production typically meet the specifications of aggregates used in construction. The deciding factors with respect to these uses are environmental acceptability and structural suitability. If the required legal conditions for use in construction are met, the EAF slag should be crushed, screened, and sized for use. Ferrous slag components are separated via magnetic separators. The treated slag is used in various construction purposes, also dependent on the grain size. Figure 8.21 shows a processing scheme for a German plant for slag preparation. In 1994, about 90 % of EAF slags generated by the production of non-alloyed and medium-alloyed steel in certain EAFs were used [57, Heinen 1997].

Slags arising at high grade steel production are only used to a limited extent, so far. Possible uses may be also in road construction, after a preparation treatment.

E.g., at Böhler Edelstahl, Kapfenberg, Austria about 270 kg slag arise per tonne steel produced. This EAF slag is not considered suitable for the construction industry due to the slag composition and properties (e.g. expansion of the slag). Most of the slag arises from the EAF (approximately 70 %) and the AOD converter (approximately 30 %). The EAF and AOD slags are disposed of at the internal landfill site.

Nevertheless, there are also examples where parts or even the total amount of stainless steel slag is used as a construction material in particular in cases of lower structurally engineered requirements (e.g. noise protection berm).

Recyclability of slags from high alloy steel or stainless steel production should either require better assessment or some special treatment depending on the properties of such slag (e.g. expansivity) (see also Section 8.3.10).

Options for using the wide spectrum of secondary metallurgy slags are limited. Grain size and expansion coefficients are decisive factors for the use of secondary metallurgy slags. They sometimes may be used in the construction area. But a significant share of the arising slags has to be landfilled, as hardly any options for prevention, reduction, or utilisation exist.

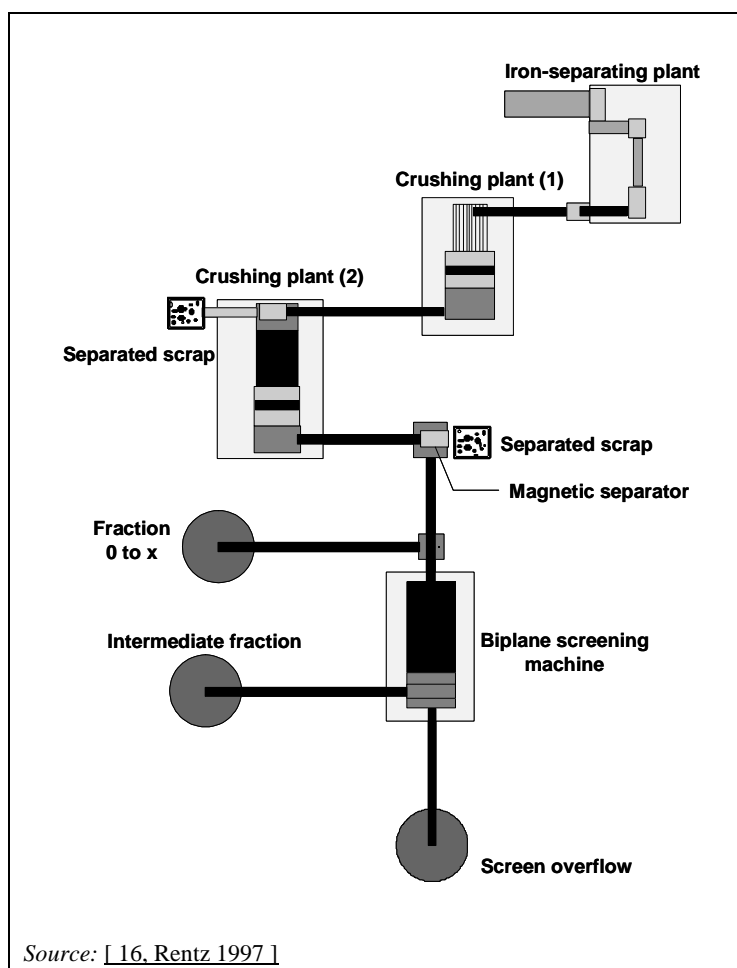

Figure 8.21: Processing scheme of a plant for slag preparation

Achieved environmental benefits

Slags from EAF that produce carbon or low alloyed steel can be treated with subsequent recycling in road construction.

Cross-media effects

The treatment of slags requires energy. Attention should be paid to alkaline fumes when the slag contains free CaO (see Section 8.2.2.1.6).

Operational data

No data submitted.

Applicability

This technique is applicable both to new and existing carbon steel plants. Further processing may procure a better suitability for use as construction material.

Economics

No data submitted.

Driving force for implementation

The main driving forces are limited space for landfilling and cost aspects like taxes on landfilled wastes.

Example plants

BSW, Kehl, Germany (treatment of slag with subsequent use for construction purposes).

Georgsmarienhütte GmbH, Georgsmarienhütte, Germany (selling of slag for external preparation with subsequent use in road construction; slag from EAF and secondary metallurgy are mixed); Salzgitter Stahl AG, Peine, Germany (treatment and use in the construction sector)

ArcelorMittal in Schiffflange, Differdange and Belval, all in Luxembourg (high-performance road surfacing, hydraulic engineering and other applications).

Reference literature

[16, Rentz 1997] [277, Wiesenberger 2007] [373, Eurofer 2007]

8.3.10 Treatment of high alloyed and stainless steel EAF slags

Description

Some techniques for slag treatment are given below:

- a) the treatment of liquid slag during tapping with residues which contain Al_2O_3 .
- b) the reduction of the slag during tapping with aluminium
- c) optimisation of oxygen blowing and use of some reduction agents
- d) prevention of dust formation when emptying slag pots. The highly basic slag from stainless steel plants contains Ca_2S , which undergoes a phase transformation during cooling. The transformation includes a certain increase in volume. By quenching the slag, the phase transformation can be suppressed and no dusting will occur. At Sandvik Materials Technology, Sandviken, Sweden, the problem with dust formation has been solved by emptying slag pots filled with hot and partially liquid slag into a box surrounded by a retaining dike. Then 12 m^3 of water is flooded over the slag. The quick drop in temperature together with the binding of small particles with water has proven to eliminate the spreading of dust over large areas. The water itself is recirculated via a basin.
- e) techniques for stainless steel slag are:
 - the stabilisation of the slag by the use of a stabilising agent to prevent pulverisation
 - the control of the slag composition

- the minimisation of the leaching of chromium from slag materials, nearly no Cr occurs in the eluate (Cr below the detection limit value of 0.01 mg/l)
- control of the slag cooling
- metal separation by crushing, screening, gravity and magnetic separation.

Achieved environmental benefits

These techniques can improve the properties of EAF slags by fixing the chromium in a stable slag lattice and can reduce the content of Cr in the eluate.

For technique d) according to estimations from the early implementation of the technique, the dusting was reduced by more than 90 %. Since only the slag from the pot from the teeming ladle is not processed in an optimal way, the reduction in dusting is probably close to 100 %.

As a measuring index of the dusting problem, the numbers of cars or boats around the plant that have to be cleaned have been used. In 2002, 80 cars and boats had to be cleaned in total. With the new technique of 2004, no cars or boats were affected by dust from the emptying of slag pots. The results so far have been outstanding in terms of environmental and goodwill aspects.

For technique e) the dusting efforts at the dumping station and slag yard can be reduced, the amount of waste is significantly reduced and natural resource can be saved.

Cross-media effects

For technique d) the amount of recirculated water is increased.

For technique e) additional stabilisation agents are needed in the process.

Operational data

No data submitted.

Applicability

For technique d) the described technique can be used whenever the slag is hot enough to not yet have undergone the dust forming phase transformation (i.e. it is used for all slag pots, EAF and AOD, except for the one in which the remaining ladle slag from the continuous caster is emptied). All in all, 90 % of the produced slag is processed using the described technique.

Pots with slag from the teeming ladle are put into watering equipment, i.e. the pots are filled with water and are then left until they are cooled down and the slag is soaking wet.

Technique e) can be applied at both new and existing plants.

Economics

No data submitted.

Driving force for implementation

With technique e) the energy consumption and the whole environmental impact can be reduced. Due to an efficient material flow there is a low bloom stock level and an increased productivity.

Example plants

Technique d): Sandvik Materials Technology, Sandviken, Sweden

Technique e): Outokumpu Stainless Tornio Works, Tornio, Finland.

Reference literature

[208, Lindfors et al. 2006] [245, Kuhn et al. 2004]

8.3.11 Near net shape strip casting

The techniques for continuous near net shape strip casting for electric arc steelmaking are similar to those described in Section 7.3.11 for basic oxygen steelmaking.

8.3.12 Techniques to prevent noise emissions

Description

Some constructional and operational techniques applied to prevent noise emissions include the following:

- to restrict some noisy activities at night (e.g. scrap yard, scrap transport to the installations)
- to organise special noise reducing information and training for the crane operators
- to continuously monitor the noise in the scrap yard
- to construct the EAF building in such a way as to absorb noise from mechanical shocks resulting from the operation of the furnace
- to construct and install cranes destined to transport the charging baskets to prevent mechanical shocks
- to create special acoustical insulation of the inside walls and roofs to prevent the airborne noise of the EAF building
- to separate the furnace and the outside wall to reduce the structure-borne noise from the EAF building
- to construct physical barriers
- to reduce the free fall height of the scrap in order to reduce noise and dust emissions at the discharge of scrap metal
- to enclose the scrap stock piles
- to continuously scrap feed and melt.

Noise reduction measures at the dedusting system

The new dedusting system had to fulfil high noise reduction requirements. Examples of this technique include the following:

- installation of fans with noise-insulation
- additional capture of fans in reinforced concrete chambers
- installation of noise absorbing sandwich elements at the new filter house
- exchange of the profiled sheeting of the existing filter house by sandwich elements
- definition of maximum noise levels for the individual plant units.
- noise-reducing measures at the existing dust filter.

Achieved environmental benefits

With the techniques described above, values between 37 and 50 dB(A) $Leq_{(1h)}$ can be achieved. Measurements at 150 m from the EAF building are below 34 dB(A) $Leq_{(1h)}$.

With continuous scrap feeding and melting systems such as CONSTEEL, the noise level can be reduced.

Cross-media effects

No data submitted.

Operational data

Some examples of insulation parameters used in the EAF building are materials with an R'_w of 56 dB for the walls and 55 dB for the roof (values according to DIN 55210 Part 3).

Applicability

These techniques are applicable to all EAF type plants.

Economics

No data submitted.

Driving force for implementation

The driving force for implementation is the prevention of noise emissions in the neighbouring area of the plant. Plants located close to residential areas tend to have implemented techniques to prevent noise.

Example plants

Arbed Esch-Belval, Luxembourg

Feralpi, Riesa, Germany.

Reference literature

[83, Ehrlich, C. et al 2007] [260, Germany 2007] [280, Aguado-Monsonet 2007] [355, Plickert 2007] [364, Fuchs, G. 2008] [366, Dornseiffer et al. 2007]

9 BAT CONCLUSIONS FOR IRON AND STEEL PRODUCTION

SCOPE

These BAT conclusions apply to the following activities specified in Annex I to Directive 2010/75/EU, namely:

- activity 1.3: coke production
- activity 2.1: metal ore (including sulphide ore) roasting and sintering
- activity 2.2: production of pig iron or steel (primary or secondary fusion) including continuous casting, with a capacity exceeding 2.5 tonnes per hour.

In particular, the BAT conclusions cover the following processes:

- the loading, unloading and handling of bulk raw materials
- the blending and mixing of raw materials
- the sintering and pelletisation of iron ore
- the production of coke from coking coal
- the production of hot metal by the blast furnace route, including slag processing
- the production and refining of steel using the basic oxygen process, including upstream ladle desulphurisation, downstream ladle metallurgy and slag processing
- the production of steel by electric arc furnaces, including downstream ladle metallurgy and slag processing
- continuous casting (thin slab/thin strip and direct sheet casting (near-shape))

These BAT conclusions do not address the following activities:

- production of lime in kilns, covered by the Cement, Lime and Magnesium Oxide Manufacturing Industries BREF (CLM)
- the treatment of dusts to recover non-ferrous metals (e.g. electric arc furnace dust) and the production of ferroalloys, covered by the Non Ferrous Metals Industries BREF (NFM)
- sulphuric acid plants in coke ovens, covered by the Large Volume Inorganic Chemicals-Ammonia, Acids and Fertilisers Industries (LVIC-AAF BREF).

Other reference documents which are of relevance for the activities covered by these BAT conclusions are the following:

Reference documents	Activity
Large Combustion Plants BREF (LCP)	Combustion plants with a rated thermal input of 50 MW or more
Ferrous Metals Processing Industry BREF (FMP)	Downstream processes like rolling, pickling, coating, etc.
	Continuous casting to the thin slab/thin strip and direct sheet casting (near-shape)
Emissions from Storage BREF (EFS)	Storage and handling
Industrial Cooling Systems BREF (ICS)	Cooling systems
General Principles of Monitoring (MON)	Emissions and consumptions monitoring
Energy Efficiency BREF (ENE)	General energy efficiency
Economic and Cross-Media Effects (ECM)	Economic and cross-media effects of techniques

The techniques listed and described in these BAT conclusions are neither prescriptive nor exhaustive. Other techniques may be used that ensure at least an equivalent level of environmental protection.

GENERAL CONSIDERATIONS

The environmental performance levels associated with BAT are expressed as ranges, rather than as single values. A range may reflect the differences within a given type of installation (e.g. differences in the grade/purity and quality of the final product, differences in design, construction, size and capacity of the installation) that result in variations in the environmental performances achieved when applying BAT.

EXPRESSION OF EMISSION LEVELS ASSOCIATED WITH THE BEST AVAILABLE TECHNIQUES (BAT-AELs)

In these BAT conclusions, BAT-AELs to air are expressed as either:

- mass of emitted substances per volume of waste gas under standard conditions (273.15 K, 101.3 kPa), after deduction of water vapour content, expressed in the units g/Nm^3 , mg/Nm^3 , $\mu\text{g/Nm}^3$ or ng/Nm^3 or
- mass of emitted substances per unit of mass of products generated or processed (consumption or emission factors), expressed in the units kg/t , g/t , mg/t or $\mu\text{g/t}$.

and BAT-AELs to water are expressed as:

- mass of emitted substances per volume of waste water, expressed in the units g/l , mg/l or $\mu\text{g/l}$.

DEFINITIONS

For the purposes of these BAT conclusions:

- 'new plant' means: a plant introduced on the site of the installation following the publication of these BAT conclusions or a complete replacement of a plant on the existing foundations of the installation following the publication of these BAT conclusions.
- 'existing plant' means: a plant which is not a new plant.
- ' NO_x ' means: the sum of nitrogen oxide (NO) and nitrogen dioxide (NO_2) expressed as NO_2
- ' SO_x ' means: the sum of sulphur dioxide (SO_2) and sulphur trioxide (SO_3) expressed as SO_2
- 'HCl' means: all gaseous chlorides expressed as HCl
- 'HF' means: all gaseous fluorides expressed as HF

9.1 General BAT Conclusions

Unless otherwise stated, the BAT conclusions presented in this section are generally applicable.

The process specific BAT included in the Sections 9.2 – 9.7 apply in addition to the general BAT mentioned in this Section.

9.1.1 Environmental management systems

1. BAT is to implement and adhere to an environmental management system (EMS) that incorporates the following features:

- I. commitment of management, including senior management;
- II. definition of an environmental policy that includes continuous improvement for the installation by the management;
- III. planning and establishing the necessary procedures, objectives and targets, in conjunction with financial planning and investment;
- IV. implementation of the procedures paying particular attention to:
 - i. structure and responsibility
 - ii. training, awareness and competence
 - iii. communication
 - iv. employee involvement
 - v. documentation
 - vi. efficient process control
 - vii. maintenance programmes
 - viii. emergency preparedness and response
 - ix. safeguarding compliance with environmental legislation;
- V. checking performance and taking corrective action, paying particular attention to:
 - i. monitoring and measurement (see also the Reference Document on the General Principles of Monitoring)
 - ii. corrective and preventive action
 - iii. maintenance of records
 - iv. independent (where practicable) internal and external auditing in order to determine whether or not the EMS conforms to planned arrangements and has been properly implemented and maintained;
- VI. review of the EMS and its continuing suitability, adequacy and effectiveness by senior management;
- VII. following the development of cleaner technologies;
- VIII. consideration for the environmental impacts from the eventual decommissioning of the installation at the stage of designing a new plant, and throughout its operating life;
- IX. application of sectoral benchmarking on a regular basis.

Applicability

The scope (e.g. level of details) and nature of the EMS (e.g. standardised or non-standardised) will generally be related to the nature, scale and complexity of the installation, and the range of environmental impacts it may have.

9.1.2 Energy management

2. BAT is to reduce thermal energy consumption by using a combination of the following techniques:

- I. improved and optimised systems to achieve smooth and stable processing, operating close to the process parameter set points by using
 - i. process control optimisation including computer-based automatic control systems
 - ii. modern, gravimetric solid fuel feed systems
 - iii. preheating, to the greatest extent possible, considering the existing process configuration.
- II. recovering excess heat from processes, especially from their cooling zones
- III. an optimised steam and heat management
- IV. applying process integrated reuse of sensible heat as much as possible.

In the context of energy management, see the Energy Efficiency BREF (ENE).

Description of BAT I.i

The following items are important for integrated steelworks in order to improve the overall energy efficiency:

- optimising energy consumption
- online monitoring for the most important energy flows and combustion processes at the site including the monitoring of all gas flares in order to prevent energy losses, enabling instant maintenance and achieving an undisrupted production process
- reporting and analysing tools to check the average energy consumption of each process
- defining specific energy consumption levels for relevant processes and comparing them on a long-term basis
- carrying out energy audits as defined in the Energy Efficiency BREF, e.g. to identify cost-effective energy savings opportunities.

Description of BAT II – IV

Process integrated techniques used to improve energy efficiency in steel manufacturing by improved heat recovery include:

- combined heat and power production with recovery of waste heat by heat exchangers and distribution either to other parts of the steelworks or to a district heating network
- the installation of steam boilers or adequate systems in large reheating furnaces (furnaces can cover a part of the steam demand)
- preheating of the combustion air in furnaces and other burning systems to save fuel, taking into consideration adverse effects, i.e. an increase of nitrogen oxides in the off-gas
- the insulation of steam pipes and hot water pipes
- recovery of heat from products, e.g. sinter
- where steel needs to be cooled, the use of both heat pumps and solar panels
- the use of flue-gas boilers in furnaces with high temperatures
- the oxygen evaporation and compressor cooling to exchange energy across standard heat exchangers
- the use of top recovery turbines to convert the kinetic energy of the gas produced in the blast furnace into electric power.

Applicability of BAT II – IV

Combined heat and power generation is applicable for all iron and steel plants close to urban areas with a suitable heat demand. The specific energy consumption depends on the scope of the process, the product quality and the type of installation (e.g. the amount of vacuum treatment at the basic oxygen furnace (BOF), annealing temperature, thickness of products, etc.).

3. **BAT is to reduce primary energy consumption by optimisation of energy flows and optimised utilisation of the extracted process gases such as coke oven gas, blast furnace gas and basic oxygen gas.**

Description

Process integrated techniques to improve energy efficiency in an integrated steelworks by optimising process gas utilisation include:

- the use of gas holders for all by-product gases or other adequate systems for short-term storage and pressure holding facilities
- increasing pressure in the gas grid if there are energy losses in the flares – in order to utilise more process gases with the resulting increase in the utilisation rate
- gas enrichment with process gases and different calorific values for different consumers
- heating fire furnaces with process gas
- use of a computer-controlled calorific value control system
- recording and using coke and flue-gas temperatures
- adequate dimensioning of the capacity of the energy recovery installations for the process gases, in particular with regard to the variability of process gases.

Applicability

The specific energy consumption depends on the scope of the process, the product quality and the type of installation (e.g. the amount of vacuum treatment at the BOF, annealing temperature, thickness of products, etc.).

4. **BAT is to use desulphurised and dedusted surplus coke oven gas and dedusted blast furnace gas and basic oxygen gas (mixed or separate) in boilers or in combined heat and power plants to generate steam, electricity and/or heat using surplus waste heat for internal or external heating networks, if there is a demand from a third party.**

Applicability

The cooperation and agreement of a third party may not be within the control of the operator, and therefore may not be within the scope of the permit.

5. **BAT is to minimise electrical energy consumption by using one or a combination of the following techniques:**
- I. power management systems
 - II. grinding, pumping, ventilation and conveying equipment and other electricity-based equipment with high energy efficiency.

Applicability

Frequency controlled pumps cannot be used where the reliability of the pumps is of essential importance for the safety of the process.

9.1.3 Material management

6. **BAT is to optimise the management and control of internal material flows in order to prevent pollution, prevent deterioration, provide adequate input quality, allow reuse and recycling and to improve the process efficiency and optimisation of the metal yield.**

Description

Appropriate storage and handling of input materials and production residues can help to minimise the airborne dust emissions from stockyards and conveyor belts, including transfer points, and to avoid soil, groundwater and runoff water pollution (see also BAT 11).

The application of an adequate management of integrated steelworks and residues, including wastes, from other installations and sectors allows for a maximised internal and/or external use as raw materials (see also BAT 8, 9 and 10).

Material management includes the controlled disposal of small parts of the overall quantity of residues from an integrated steelworks which have no economic use.

7. **In order to achieve low emission levels for relevant pollutants, BAT is to select appropriate scrap qualities and other raw materials. Regarding scrap, BAT is to undertake an appropriate inspection for visible contaminants which might contain heavy metals, in particular mercury, or might lead to the formation of polychlorinated dibenzodioxins/furans (PCDD/F) and polychlorinated biphenyls (PCB).**

To improve the use of scrap, the following techniques can be used individually or in combination:

- specification of acceptance criteria suited to the production profile in purchase orders of scrap
- having a good knowledge of scrap composition by closely monitoring the origin of the scrap; in exceptional cases, a melt test might help characterise the composition of the scrap
- having adequate reception facilities and check deliveries
- having procedures to exclude scrap that is not suitable for use in the installation
- storing the scrap according to different criteria (e.g. size, alloys, degree of cleanliness); storing of scrap with potential release of contaminants to the soil on impermeable surfaces with a drainage and collection system; using a roof which can reduce the need for such a system
- putting together the scrap load for the different melts taking into account the knowledge of composition in order to use the most suitable scrap for the steel grade to be produced (this is essential in some cases to avoid the presence of undesired elements and in other cases to take advantage of alloy elements which are present in the scrap and needed for the steel grade to be produced)
- prompt return of all internally-generated scrap to the scrapyard for recycling
- having an operation and management plan
- scrap sorting to minimise the risk of including hazardous or non-ferrous contaminants, particularly polychlorinated biphenyls (PCB) and oil or grease. This is normally done by the scrap supplier but the operator inspects all scrap loads in sealed containers for safety reasons. Therefore, at the same time, it is possible to check, as far as practicable, for contaminants. Evaluation of the small quantities of plastic (e.g. as plastic coated components) may be required
- radioactivity control according to the United Nations Economic Commission for Europe (UNECE) Expert Group framework of recommendations

- implementation of the mandatory removal of components which contain mercury from End-of-Life Vehicles and Waste Electrical and Electronic Equipment (WEEE) by the scrap processors can be improved by:
 - fixing the absence of mercury in scrap purchase contracts
 - refusal of scrap which contains visible electronic components and assemblies.

Applicability

The selection and sorting of scrap might not be entirely within the control of the operator.

9.1.4 Management of process residues such as by-products and waste

- 8. BAT for solid residues is to use integrated techniques and operational techniques for waste minimisation by internal use or by application of specialised recycling processes (internally or externally).**

Description

Techniques for the recycling of iron-rich residues include specialised recycling techniques such as the OxyCup® shaft furnace, the DK process, smelting reduction processes or cold bonded pelleting/briquetting as well as techniques for production residues mentioned in Sections 9.2 – 9.7.

Applicability

As the mentioned processes may be carried out by a third party, the recycling itself may not be within the control of the operator of the iron and steel plant, and therefore may not be within the scope of the permit.

- 9. BAT is to maximise external use or recycling for solid residues which cannot be used or recycled according to BAT 8, wherever this is possible and in line with waste regulations. BAT is to manage in a controlled manner residues which can neither be avoided nor recycled.**
- 10. BAT is to use the best operational and maintenance practices for the collection, handling, storage and transport of all solid residues and for the hooding of transfer points to avoid emissions to air and water.**

9.1.5 Diffuse dust emissions from materials storage, handling and transport of raw materials and (intermediate) products

- 11. BAT is to prevent or reduce diffuse dust emissions from materials storage, handling and transport by using one or a combination of the techniques mentioned below.**

If abatement techniques are used, BAT is to optimise the capture efficiency and subsequent cleaning through appropriate techniques such as those mentioned below. Preference is given to the collection of the dust emissions nearest to the source.

I. General techniques include:

- the setting up within the EMS of the steelworks of an associated diffuse dust action plan;
- consideration of temporary cessation of certain operations where they are identified as a source of PM₁₀ causing a high ambient reading; in order to do this, it will be

necessary to have sufficient PM₁₀ monitors, with associated wind direction and strength monitoring, to be able to triangulate and identify key sources of fine dust.

II. Techniques for the prevention of dust releases during the handling and transport of bulk raw materials include:

- orientation of long stockpiles in the direction of the prevailing wind
- installing wind barriers or using natural terrain to provide shelter
- controlling the moisture content of the material delivered
- careful attention to procedures to avoid the unnecessary handling of materials and long unenclosed drops
- adequate containment on conveyors and in hoppers, etc.
- the use of dust-suppressing water sprays, with additives such as latex, where appropriate
- rigorous maintenance standards for equipment
- high standards of housekeeping, in particular the cleaning and damping of roads
- the use of mobile and stationary vacuum cleaning equipment
- dust suppression or dust extraction and the use of a bag filter cleaning plant to abate sources of significant dust generation
- the application of emissions-reduced sweeping cars for carrying out the routine cleaning of hard surfaced roads.

III. Techniques for materials delivery, storage and reclamation activities include:

- total enclosure of unloading hoppers in a building equipped with filtered air extraction for dusty materials, or hoppers should be fitted with dust baffles and the unloading grids coupled to a dust extraction and cleaning system
- limiting the drop heights if possible to a maximum of 0.5 m
- the use of water sprays (preferably using recycled water) for dust suppression
- where necessary, the fitting of storage bins with filter units to control dust
- the use of totally enclosed devices for reclamation from bins
- where necessary, the storage of scrap in covered, and hard surfaced areas to reduce the risk of ground contamination (using just in time delivery to minimise the size of the yard and hence emissions)
- minimisation of the disturbance of stockpiles
- restriction of the height and a controlling of the general shape of stockpiles
- the use of in-building or in-vessel storage, rather than external stockpiles, if the scale of storage is appropriate
- the creation of windbreaks by natural terrain, banks of earth or the planting of long grass and evergreen trees in open areas to capture and absorb dust without suffering long-term harm
- hydro-seeding of waste tips and slag heaps
- implementation of a greening of the site by covering unused areas with top soil and planting grass, shrubs and other ground covering vegetation
- the moistening of the surface using durable dust-binding substances
- the covering of the surface with tarpaulins or coating (e.g. latex) stockpiles
- the application of storage with retaining walls to reduce the exposed surface
- when necessary, a measure could be to include impermeable surfaces with concrete and drainage.

IV. Where fuel and raw materials are delivered by sea and dust releases could be significant, some techniques include:

- use by operators of self-discharge vessels or enclosed continuous unloaders. Otherwise, dust generated by grab-type ship unloaders should be minimised through a combination of ensuring adequate moisture content of the material is delivered, by

minimising drop heights and by using water sprays or fine water fogs at the mouth of the ship unloader hopper

- avoiding seawater in spraying ores or fluxes as this results in a fouling of sinter plant electrostatic precipitators with sodium chloride. Additional chlorine input in the raw materials may also lead to rising emissions (e.g. of polychlorinated dibenzodioxins/furans (PCDD/F)) and hamper filter dust recirculation
 - storage of powdered carbon, lime and calcium carbide in sealed silos and conveying them pneumatically or storing and transferring them in sealed bags.
- V. Train or truck unloading techniques include:
- if necessary due to dust emission formation, use of dedicated unloading equipment with a generally enclosed design.
- VI. For highly drift-sensitive materials which may lead to significant dust release, some techniques include:
- use of transfer points, vibrating screens, crushers, hoppers and the like, which may be totally enclosed and extracted to a bag filter plant
 - use of central or local vacuum cleaning systems rather than washing down for the removal of spillage, since the effects are restricted to one medium and the recycling of spilt material is simplified.
- VII. Techniques for the handling and processing of slag include:
- keeping stockpiles of slag granulate damp for slag handling and processing since dried blast furnace slag and steel slag can give rise to dust
 - use of enclosed slag-crushing equipment fitted with efficient extraction and bag filters to reduce dust emissions.
- VIII. Techniques for handling scrap include:
- providing scrap storage under cover and/or on concrete floors to minimise dust lift-off caused by vehicle movements
- IX. Techniques to consider during material transport include:
- the minimisation of points of access from public highways
 - the employment of wheel-cleaning equipment to prevent the carryover of mud and dust onto public roads
 - the application of hard surfaces to the transport roads (concrete or asphalt) to minimise the generation of dust clouds during materials transport and the cleaning of roads
 - the restriction of vehicles to designated routes by fences, ditches or banks of recycled slag
 - the damping of dusty routes by water sprays, e.g. at slag-handling operations
 - ensuring that transport vehicles are not overfull, so as to prevent any spillage
 - ensuring that transport vehicles are sheeted to cover the material carried
 - the minimisation of numbers of transfers
 - use of closed or enclosed conveyors
 - use of tubular conveyors, where possible, to minimise material losses by changes of direction across sites usually provided by the discharge of materials from one belt onto another
 - good practice techniques for molten metal transfer and ladle handling
 - dedusting of conveyor transfer points.

9.1.6 Water and waste water management

12. **BAT for waste water management is to prevent, collect and separate waste water types, maximising internal recycling and using an adequate treatment for each final flow. This includes techniques utilising, e.g. oil interceptors, filtration or sedimentation. In this context, the following techniques can be used where the prerequisites mentioned are present:**

- avoiding the use of potable water for production lines
- increasing the number and/or capacity of water circulating systems when building new plants or modernising/revamping existing plants
- centralising the distribution of incoming fresh water
- using the water in cascades until single parameters reach their legal or technical limits
- using the water in other plants if only single parameters of the water are affected and further usage is possible
- keeping treated and untreated waste water separated; by this measure it is possible to dispose of waste water in different ways at a reasonable cost
- using rainwater whenever possible.

Applicability

The water management in an integrated steelworks will primarily be constrained by the availability and quality of fresh water and local legal requirements. In existing plants the existing configuration of the water circuits may limit applicability.

9.1.7 Monitoring

13. **BAT is to measure or assess all relevant parameters necessary to steer the processes from control rooms by means of modern computer-based systems in order to adjust continuously and to optimise the processes online, to ensure stable and smooth processing, thus increasing energy efficiency and maximising the yield and improving maintenance practices.**

14. **BAT is to measure the stack emissions of pollutants from the main emission sources from all processes included in the Sections 1.2 – 1.7 whenever BAT-AELs are given and in process gas-fired power plants in iron and steel works.**

BAT is to use continuous measurements at least for:

- primary emissions of dust, nitrogen oxides (NO_x) and sulphur dioxide (SO₂) from sinter strands
- nitrogen oxides (NO_x) and sulphur dioxide (SO₂) emissions from induration strands of pelletisation plants
- dust emissions from blast furnace cast houses
- secondary emissions of dust from basic oxygen furnaces
- emissions of nitrogen oxides (NO_x) from power plants
- dust emissions from large electric arc furnaces.

For other emissions, BAT is to consider using continuous emission monitoring depending on the mass flow and emission characteristics.

15. **For relevant emission sources not mentioned in BAT 14, BAT is to measure the emissions of pollutants from all processes included in the Sections 1.2 – 1.7 and from process gas-fired power plants within iron and steel works as well as all relevant process gas components/pollutants periodically and discontinuously. This includes the discontinuous monitoring of process gases, stack emissions, polychlorinated**

dibenzodioxins/furans (PCDD/F) and monitoring the discharge of waste water, but excludes diffuse emissions (see BAT 16).

Description (relevant for BAT 14 and 15)

The monitoring of process gases provides information about the composition of process gases and about indirect emissions from the combustion of process gases, such as emissions of dust, heavy metals and SO_x.

Stack emissions can be measured by regular, periodic discontinuous measurements at relevant channelled emission sources over a sufficiently long period, to obtain representative emission values.

For monitoring the discharge of waste water a great variety of standardised procedures exist for sampling and analyzing water and waste water, including:

- a random sample which refers to a single sample taken from a waste water flow
- a composite sample, which refers to a sample taken continuously over a given period, or a sample consisting of several samples taken either continuously or discontinuously over a given period and blended
- a qualified random sample shall refer to a composite sample of at least five random samples taken over a maximum period of two hours at intervals of no less than two minutes, and blended.

Monitoring should be done according to the relevant EN or ISO standards. If EN or ISO standards are not available, national or other international standards should be used that ensure the provision of data of an equivalent scientific quality.

16. BAT is to determine the order of magnitude of diffuse emissions from relevant sources by the methods mentioned below. Whenever possible, direct measurement methods are preferred over indirect methods or evaluations based on calculations with emission factors.

- Direct measurement methods where the emissions are measured at the source itself. In this case, concentrations and mass streams can be measured or determined.
- Indirect measurement methods where the emission determination takes place at a certain distance from the source; a direct measurement of concentrations and mass stream is not possible.
- Calculation with emission factors.

Description

Direct or quasi-direct measurement

Examples for direct measurements are measurements in wind tunnels, with hoods or other methods like quasi-emissions measurements on the roof of an industrial installation. For the latter case, the wind velocity and the area of the roofline vent are measured and a flow rate is calculated. The cross-section of the measurement plane of the roofline vent is subdivided into sectors of identical surface area (grid measurement).

Indirect measurements

Examples of indirect measurements include the use of tracer gases, reverse dispersion modelling (RDM) methods and the mass balance method applying light detection and ranging (LIDAR).

Calculation of emissions with emission factors

Guidelines using emission factors for the estimation of diffuse dust emissions from storage and handling of bulk materials and for the suspension of dust from roadways due to traffic movements are:

- VDI 3790 Part 3
- US EPA AP 42

9.1.8 Decommissioning

17. BAT is to prevent pollution upon decommissioning by using necessary techniques as listed below.

Design considerations for end-of-life plant decommissioning:

- I. giving consideration to the environmental impact from the eventual decommissioning of the installation at the stage of designing a new plant, as forethought makes decommissioning easier, cleaner and cheaper
- II. decommissioning poses environmental risks for the contamination of land (and groundwater) and generates large quantities of solid waste; preventive techniques are process-specific but general considerations may include:
 - i. avoiding underground structures
 - ii. incorporating features that facilitate dismantling
 - iii. choosing surface finishes that are easily decontaminated
 - iv. using an equipment configuration that minimises trapped chemicals and facilitates drain-down or cleaning
 - v. designing flexible, self-contained units that enable phased closure
 - vi. using biodegradable and recyclable materials where possible.

9.1.9 Noise

18. BAT is to reduce noise emissions from relevant sources in the iron and steel manufacturing processes by using one or more of the following techniques depending on and according to local conditions:

- implementation of a noise-reduction strategy
- enclosure of the noisy operations/units
- vibration insulation of operations/units
- internal and external lining made of impact-absorbent material
- soundproofing buildings to shelter any noisy operations involving material transformation equipment
- building noise protection walls, e.g. the construction of buildings or natural barriers, such as growing trees and bushes between the protected area and the noisy activity
- outlet silencers on exhaust stacks
- lagging ducts and final blowers which are situated in soundproof buildings
- closing doors and windows of covered areas.

9.2 BAT Conclusions For Sinter Plants

Unless otherwise stated, the BAT conclusions presented in this section can be applied to all sinter plants.

Air emissions

19. **BAT for blending/mixing is to prevent or reduce diffuse dust emissions by agglomerating fine materials by adjusting the moisture content (see also BAT 11).**
20. **BAT for primary emissions from sinter plants is to reduce dust emissions from the sinter strand waste gas by means of a bag filter.**

BAT for primary emissions for existing plants is to reduce dust emissions from the sinter strand waste gas by using advanced electrostatic precipitators when bag filters are not applicable.

The **BAT-associated emission level** for dust is $<1 - 15 \text{ mg/Nm}^3$ for the bag filter and $<20 - 40 \text{ mg/Nm}^3$ for the advanced electrostatic precipitator (which should be designed and operated to achieve these values), both determined as a daily mean value.

Bag Filter

Description

Bag filters used in sinter plants are usually applied downstream of an existing electrostatic precipitator or cyclone but can also be operated as a standalone device.

Applicability

For existing plants requirements such as space for a downstream installation to the electrostatic precipitator can be relevant. Special regard should be given to the age and the performance of the existing electrostatic precipitator.

Advanced electrostatic precipitator

Description

Advanced electrostatic precipitators are characterised by one or a combination of the following features:

- good process control
- additional electrical fields
- adapted strength of the electric field
- adapted moisture content
- conditioning with additives
- higher or variably pulsed voltages
- rapid reaction voltage
- high energy pulse superimposition
- moving electrodes
- enlarging the electrode plate distance or other features which improves the abatement efficiency.

21. **BAT for primary emissions from sinter strands is to prevent or reduce mercury emissions by selecting raw materials with a low mercury content (see BAT 7) or to treat waste gases in combination with activated carbon or activated lignite coke injection.**

The **BAT-associated emissions level** for mercury is $<0.03 - 0.05 \text{ mg/Nm}^3$, as the average over the sampling period (discontinuous measurement, spot samples for at least half an hour).

22. **BAT for primary emissions from sinter strands is to reduce sulphur oxide (SO_x) emissions by using one or a combination of the following techniques:**

- I. lowering the sulphur input by using coke breeze with a low sulphur content
- II. lowering the sulphur input by minimisation of coke breeze consumption
- III. lowering the sulphur input by using iron ore with a low sulphur content
- IV. injection of adequate adsorption agents into the waste gas duct of the sinter strand before dedusting by bag filter (**see BAT 20**)
- V. wet desulphurisation or regenerative activated carbon (RAC) process (with particular consideration for the prerequisites for application).

The **BAT-associated emission level** for sulphur oxides (SO_x) using BAT I – IV is $<350 - 500 \text{ mg/Nm}^3$, expressed as sulphur dioxide (SO_2) and determined as a daily mean value, the lower value being associated with BAT IV.

The **BAT-associated emission level** for sulphur oxides (SO_x) using BAT V is $<100 \text{ mg/Nm}^3$, expressed as sulphur dioxide (SO_2) and determined as a daily mean value.

Description of the RAC process mentioned under BAT V

Dry desulphurisation techniques are based on an adsorption of SO_2 by activated carbon. When the SO_2 -laden activated carbon is regenerated, the process is called regenerated activated carbon (RAC). In this case, a high quality, expensive activated carbon type may be used and sulphuric acid (H_2SO_4) is yielded as a by-product. The bed is regenerated either with water or thermally. In some cases, for ‘fine-tuning’ downstream of an existing desulphurisation unit, lignite-based activated carbon is used. In this case, the SO_2 -laden activated carbon is usually incinerated under controlled conditions.

The RAC system can be developed as a single-stage or a two-stage process.

In the single-stage process, the waste gases are led through a bed of activated carbon and pollutants are adsorbed by the activated carbon. Additionally, NO_x removal occurs when ammonia (NH_3) is injected into the gas stream before the catalyst bed.

In the two-stage process, the waste gases are led through two beds of activated carbon. Ammonia can be injected before the bed to reduce NO_x emissions.

Applicability of techniques mentioned under BAT V

Wet desulphurisation: The requirements of space may be of significance and may restrict the applicability. High investment and operational costs and significant cross-media effects such as slurry generation and disposal and additional waste water treatment measures, have to be taken into account. This technique is not used in Europe at the time of writing, but might be an option where environmental quality standards are unlikely to be met through the application of other techniques.

RAC: Dust abatement should be installed prior to the RAC process to reduce the inlet dust concentration. Generally the layout of the plant and space requirements are important factors when considering this technique, but especially for a site with more than one sinter strand.

High investment and operational costs, in particular when high quality, expensive, activated carbon types may be used and a sulphuric acid plant is needed, have to be taken into account. This technique is not used in Europe at the time of writing, but might be an option in new plants targeting SO_x, NO_x, dust and PCDD/F simultaneously and in circumstances where environmental quality standards are unlikely to be met through the application of other techniques.

23. BAT for primary emissions from sinter strands is to reduce total nitrogen oxides (NO_x) emissions by using one or a combination of the following techniques:

I. process integrated measures which can include:

- i. waste gas recirculation
- ii. other primary measures, such as the use of anthracite or the use of low-NOX burners for ignition

II. end-of-pipe techniques which can include

- i. the regenerative activated carbon (RAC) process
- ii. selective catalytic reduction (SCR).

The **BAT-associated emission level** for nitrogen oxides (NO_x) using process integrated measures is <500 mg/Nm³, expressed as nitrogen dioxide (NO₂) and determined as a daily mean value.

The **BAT-associated emission level** for nitrogen oxides (NO_x) using RAC is <250 mg/Nm³ and using SCR it is <120 mg/Nm³, expressed as nitrogen dioxide (NO₂), related to an oxygen content of 15 % and determined as daily mean values.

Description of waste gas recirculation under BAT I.i

In the partial recycling of waste gas, some portions of the sinter waste gas are recirculated to the sintering process. Partial recycling of waste gas from the whole strand was primarily developed to reduce waste gas flow and thus the mass emissions of major pollutants. Additionally it can lead to a decrease in energy consumption. The application of waste gas recirculation requires special efforts to ensure that the sinter quality and productivity are not affected negatively. Special attention needs to be paid to carbon monoxide (CO) in the recirculated waste gas in order to prevent carbon monoxide poisoning of employees. Various processes have been developed such as:

- partial recycling of waste gas from the whole strand
- recycling of waste gas from the end sinter strand combined with heat exchange
 - recycling of waste gas from part of the end sinter strand and use of waste gas from the sinter cooler
 - recycling of parts of waste gas to other parts of the sinter strand.

Applicability of BAT I.i

The applicability of this technique is site specific. Accompanying measures to ensure that sinter quality (cold mechanical strength) and strand productivity are not negatively affected must be considered. Depending on local conditions, these can be relatively minor and easy to implement or, on the contrary, they can be of a more fundamental nature and may be costly and difficult to introduce. In any case, the operating conditions of the strand should be reviewed when this technique is introduced.

In existing plants, it may not be possible to install a partial recycling of waste gas due to space restrictions.

Important considerations in determining the applicability of this technique include:

- initial configuration of the strand (e.g. dual or single wind-box ducts, space available for new equipment and, when required, lengthening of the strand)
- initial design of the existing equipment (e.g. fans, gas cleaning and sinter screening and cooling devices)
- initial operating conditions (e.g. raw materials, layer height, suction pressure, percentage of quick lime in the mix, specific flow rate, percentage of in-plant reverts returned in the feed)
- existing performance in terms of productivity and solid fuel consumption
- basicity index of the sinter and composition of the burden at the blast furnace (e.g. percentage of sinter versus pellet in the burden, iron content of these components).

Applicability of other primary measures under BAT I.ii

The use of anthracite depends on the availability of anthracites with a lower nitrogen content compared to coke breeze.

Description and applicability of the RAC process under BAT II.i see BAT 22.

Applicability of the SCR process under BAT II.ii

SCR can be applied within a high dust system, a low dust system and as a clean gas system. Until now, only clean gas systems (after dedusting and desulphurisation) have been applied at sinter plants. It is essential that the gas is low in dust (<40 mg dust/Nm³) and heavy metals, because they can make the surface of the catalyst ineffective. Additionally, desulphurisation prior to the catalyst might be required. Another prerequisite is a minimum off-gas temperature of about 300 °C. This requires an energy input.

The high investment and operational costs, the need for catalyst revitalisation, NH₃ consumption and slip, the accumulation of explosive ammonium nitrate (NH₄NO₃), the formation of corrosive SO₃ and the additional energy required for reheating which can reduce the possibilities for recovery of sensible heat from the sinter process, all may constrain the applicability. This technique might be an option where environmental quality standards are unlikely to be met through the application of other techniques.

24. BAT for primary emissions from sinter strands is to prevent and/or reduce emissions of polychlorinated dibenzodioxins/furans (PCDD/F) and polychlorinated biphenyls (PCB) by using one or a combination of the following techniques:

- I. avoidance of raw materials which contain polychlorinated dibenzodioxins/furans (PCDD/F) and polychlorinated biphenyls (PCB) or their precursors as much as possible (see BAT 7)
- II. suppression of polychlorinated dibenzodioxins/furans (PCDD/F) formation by addition of nitrogen compounds
- III. waste gas recirculation (see BAT 23 for description and applicability).

25. BAT for primary emissions from sinter strands is to reduce emissions of polychlorinated dibenzodioxins/furans (PCDD/F) and polychlorinated biphenyls (PCB) by the injection of adequate adsorption agents into the waste gas duct of the sinter strand before dedusting with a bag filter or advanced electrostatic precipitators when bag filters are not applicable (see BAT 20).

The BAT- associated emission level for polychlorinated dibenzodioxins/furans (PCDD/F) is <0.05 – 0.2 ng I-TEQ/Nm³ for the bag filter and <0.2 – 0.4 ng-I-TEQ/Nm³ for the advanced electrostatic precipitator, both determined for a 6 – 8 hour random sample under steady-state conditions.

26. **BAT for secondary emissions from sinter strand discharge, sinter crushing, cooling, screening and conveyor transfer points is to prevent dust emissions and/or to achieve an efficient extraction and subsequently to reduce dust emissions by using a combination of the following techniques:**

- I. hooding and/or enclosure
- II. an electrostatic precipitator or a bag filter.

The **BAT-associated emission level** for dust is $<10 \text{ mg/Nm}^3$ for the bag filter and $<30 \text{ mg/Nm}^3$ for the electrostatic precipitator, both determined as a daily mean value.

Water and waste water

27. **BAT is to minimise water consumption in sinter plants by recycling cooling water as much as possible unless once-through cooling systems are used.**
28. **BAT is to treat the effluent water from sinter plants where rinsing water is used or where a wet waste gas treatment system is applied, with the exception of cooling water prior to discharge by using a combination of the following techniques:**

- I. heavy metal precipitation
- II. neutralisation
- III. sand filtration.

The **BAT-associated emission levels**, based on a qualified random sample or a 24-hour composite sample, are:

- suspended solids $<30 \text{ mg/l}$
- chemical oxygen demand (COD⁽¹⁾) $<100 \text{ mg/l}$
- heavy metals $<0.1 \text{ mg/l}$
(sum of arsenic (As), cadmium (Cd), chromium (Cr), copper (Cu), mercury (Hg), nickel (Ni), lead (Pb), and zinc (Zn)).

⁽¹⁾ In some cases, TOC is measured instead of COD (in order to avoid HgCl_2 used in the analysis for COD). The correlation between COD and TOC should be elaborated for each sinter plant case by case. The COD/TOC ratio may vary approximately between two and four.

Production residues

29. **BAT is to prevent waste generation within sinter plants by using one or a combination of the following techniques (see BAT 8):**

- I. selective on-site recycling of residues back to the sinter process by excluding heavy metals, alkali or chloride-enriched fine dust fractions (e.g. the dust from the last electrostatic precipitator field)
- II. external recycling whenever on-site recycling is hampered.

BAT is to manage in a controlled manner sinter plant process residues which can neither be avoided nor recycled.

30. **BAT is to recycle residues that may contain oil, such as dust, sludge and mill scale which contain iron and carbon from the sinter strand and other processes in the integrated steelworks, as much as possible back to the sinter strand, taking into account the respective oil content.**

- 31. BAT is to lower the hydrocarbon content of the sinter feed by appropriate selection and pretreatment of the recycled process residues.**

In all cases, the oil content of the recycled process residues should be <0.5 % and the content of the sinter feed <0.1 %.

Description

The input of hydrocarbons can be minimised, especially by the reduction of the oil input. Oil enters the sinter feed mainly by addition of mill scale. The oil content of mill scales can vary significantly, depending on their origin.

Techniques to minimise oil input via dusts and mill scale include the following:

- limiting input of oil by segregating and then selecting only those dusts and mill scale with a low oil content
- the use of ‘good housekeeping’ techniques in the rolling mills can result in a substantial reduction in the contaminant oil content of mill scale
- de-oiling of mill scale by:
 - heating the mill scale to approximately 800 °C, the oil hydrocarbons are volatilised and clean mill scale is yielded; the volatilised hydrocarbons can be combusted.
 - extracting oil from the mill scale using a solvent.

Energy

- 32. BAT is to reduce thermal energy consumption within sinter plants by using one or a combination of the following techniques:**

- I. recovering sensible heat from the sinter cooler waste gas
- II. recovering sensible heat, if feasible, from the sintering grate waste gas
- III. maximising the recirculation of waste gases to use sensible heat (**see BAT 23** for description and applicability).

Description

Two kinds of potentially reusable waste energies are discharged from the sinter plants:

- the sensible heat from the waste gases from the sintering machines
- the sensible heat of the cooling air from the sinter cooler.

Partial waste gas recirculation is a special case of heat recovery from waste gases from sintering machines and is dealt with in BAT 23. The sensible heat is transferred directly back to the sinter bed by the hot recirculated gases. At the time of writing (2010), this is the only practical method of recovering heat from the waste gases.

The sensible heat in the hot air from the sinter cooler can be recovered by one or more of the following ways:

- steam generation in a waste heat boiler for use in the iron and steel works
- hot water generation for district heating
- preheating combustion air in the ignition hood of the sinter plant
- preheating the sinter raw mix
- use of the sinter cooler gases in a waste gas recirculation system.

Applicability

At some plants, the existing configuration may make costs of heat recovery from the sinter waste gases or sinter cooler waste gas very high.

The recovery of heat from the waste gases by means of a heat exchanger would lead to unacceptable condensation and corrosion problems.

9.3 BAT Conclusions For Pelletisation Plants

Unless otherwise stated, the BAT conclusions presented in this section can be applied to all pelletisation plants.

Air emissions

- 33. BAT is to reduce the dust emissions in the waste gases from**
- **the raw materials pre-treatment, drying, grinding, wetting, mixing and the balling;**
 - **from the induration strand; and**
 - **from the pellet handling and screening**
- by using one or a combination of the following techniques:**
- I. an electrostatic precipitator
 - II. a bag filter
 - III. a wet scrubber

The **BAT-associated emission level** for dust is $<20 \text{ mg/Nm}^3$ for the crushing, grinding and drying and $<10 - 15 \text{ mg/Nm}^3$ for all other process steps or in cases where all waste gases are treated together, all determined as daily mean values.

- 34. BAT is to reduce the sulphur oxides (SO_x), hydrogen chloride (HCl) and hydrogen fluoride (HF) emissions from the induration strand waste gas by using one of the following techniques:**
- I. a wet scrubber
 - II. semi-dry absorption with a subsequent dedusting system

The **BAT-associated emission levels**, determined as daily mean values, for these compounds are:

- sulphur oxides (SO_x), expressed as sulphur dioxide (SO₂) $<30 - 50 \text{ mg/Nm}^3$
- hydrogen fluoride (HF) $<1 - 3 \text{ mg/Nm}^3$
- hydrogen chloride (HCl) $<1 - 3 \text{ mg/Nm}^3$.

- 35. BAT is to reduce NO_x emissions from the drying and grinding section and induration strand waste gases by applying process-integrated techniques.**

Description

Plant design through tailor-made solutions should be optimised for low nitrogen oxides (NO_x) emissions from all firing sections. The reduction of the formation of thermal NO_x can be achieved by lowering the (peak) temperature in the burners and reducing the excess oxygen in the combustion air. Additionally, lower NO_x emissions can be achieved by a combination of low energy use and low nitrogen content in the fuel (coal and oil).

- 36. BAT for existing plants is to reduce NO_x emissions from the drying and grinding section and induration strand waste gases by applying one of the following techniques:**
- I. selective catalytic reduction (SCR) as an end-of-pipe technique
 - II. any other technique with a NO_x reduction efficiency of at least 80 %.

Applicability

For existing plants, both straight grate and grate kiln systems, it is difficult to obtain the operating conditions necessary to suit an SCR reactor. Due to high costs, these end-of-pipe techniques should only be considered in circumstances where environmental quality standards are otherwise not likely to be met.

37. **BAT for new plants is to reduce NO_x emissions from the drying and grinding section and induration strand waste gases by applying selective catalytic reduction (SCR) as an end-of-pipe technique.**

Water and waste water

38. **BAT for pelletisation plants is to minimise the water consumption and discharge of scrubbing, wet rinsing and cooling water and reuse it as much as possible.**
39. **BAT for pelletisation plants is to treat the effluent water prior to discharge by using a combination of the following techniques:**
- I. neutralisation
 - II. flocculation
 - III. sedimentation
 - IV. sand filtration
 - V. heavy metal precipitation.

The **BAT-associated emission levels**, based on a qualified random sample or a 24-hour composite sample, are:

- suspended solids <50 mg/l
- chemical oxygen demand (COD⁽¹⁾) <160 mg/l
- Kjeldahl nitrogen <45 mg/l
- heavy metals <0.55 mg/l
(sum of arsenic (As), cadmium (Cd), chromium (Cr), copper (Cu), mercury (Hg), nickel (Ni), lead (Pb), zinc (Zn)).

⁽¹⁾ In some cases, TOC is measured instead of COD (in order to avoid HgCl₂ used in the analysis for COD). The correlation between COD and TOC should be elaborated for each pelletisation plant case by case. The COD/TOC ratio may vary approximately between two and four.

Production residues

40. **BAT is to prevent waste generation from pelletisation plants by effective on-site recycling or the reuse of residues (i.e. undersized green and heat-treated pellets)**

BAT is to manage in a controlled manner pellet plant process residues, i.e. sludge from waste water treatment, which can neither be avoided nor recycled.

Energy

41. **BAT is to reduce/minimise thermal energy consumption in pelletisation plants by using one or a combination of the following techniques:**
- I. process integrated reuse of sensible heat as far as possible from the different sections of the induration strand

- II. using surplus waste heat for internal or external heating networks if there is demand from a third party.

Description

Hot air from the primary cooling section can be used as secondary combustion air in the firing section. In turn, the heat from the firing section can be used in the drying section of the induration strand. Heat from the secondary cooling section can also be used in the drying section.

Excess heat from the cooling section can be used in the drying chambers of the drying and grinding unit. The hot air is transported through an insulated pipeline called a 'hot air recirculation duct'.

Applicability

Recovery of sensible heat is a process integrated part of pelletisation plants. The 'hot air recirculation duct' can be applied at existing plants with a comparable design and a sufficient supply of sensible heat.

The cooperation and agreement of a third party may not be within the control of the operator, and therefore may not be within the scope of the permit.

9.4 BAT Conclusions For Coke Oven Plants

Unless otherwise stated, the BAT conclusions presented in this section can be applied to all coke oven plants.

Air emissions

42. BAT for coal grinding plants (coal preparation including crushing, grinding, pulverising and screening) is to prevent or reduce dust emissions by using one or a combination of the following techniques:

- I. building and/or device enclosure (crusher, pulveriser, sieves) and
- II. efficient extraction and use of a subsequent dry dedusting systems.

The **BAT-associated emission level** for dust is $<10 - 20 \text{ mg/Nm}^3$, as the average over the sampling period (discontinuous measurement, spot samples for at least half an hour).

43. BAT for storage and handling of pulverised coal is to prevent or reduce diffuse dust emissions by using one or a combination of the following techniques:

- I. storing pulverised materials in bunkers and warehouses
- II. using closed or enclosed conveyors
- III. minimising the drop heights depending on the plant size and construction
- IV. reducing emissions from charging of the coal tower and the charging car
- V. using efficient extraction and subsequent dedusting.

When using BAT V, the **BAT-associated emission level** for dust is $<10 - 20 \text{ mg/Nm}^3$, as the average over the sampling period (discontinuous measurement, spot samples for at least half an hour).

44. BAT is to charge coke oven chambers with emission-reduced charging systems.

Description

From an integrated point of view, 'smokeless' charging or sequential charging with double ascension pipes or jumper pipes are the preferred types, because all gases and dust are treated as part of the coke oven gas treatment.

If, however, the gases are extracted and treated outside the coke oven, charging with a land-based treatment of the extracted gases is the preferred method. Treatment should consist of an efficient extraction of the emissions with subsequent combustion to reduce organic compounds and the use of a bag filter to reduce particulates.

The **BAT-associated emission level** for dust from coal charging systems with land-based treatment of extracted gases is $<5 \text{ g/t coke equivalent to } <50 \text{ mg/Nm}^3$, as the average over the sampling period (discontinuous measurement, spot samples for at least half an hour).

The duration associated with BAT of visible emissions from charging is <30 seconds per charge as a monthly average using a monitoring method described in BAT 46.

45. BAT for coking is to extract the coke oven gas (COG) during coking as much as possible.

46. BAT for coke plants is to reduce the emissions through achieving continuous undisturbed coke production by using the following techniques:

- I. extensive maintenance of oven chambers, oven doors and frame seals, ascension pipes, charging holes and other equipment (a systematic programme should be carried out by specially-trained detection and maintenance personnel)
- II. avoiding strong temperature fluctuations
- III. comprehensive observation and monitoring of the coke oven
- IV. cleaning of doors, frame seals, charging holes, lids and ascension pipes after handling (applicable at new and, in some cases, existing plants)
- V. maintaining a free gas-flow in the coke ovens
- VI. adequate pressure regulation during coking and application of spring-loaded flexible sealing doors or knife-edged doors (in cases of ovens ≤ 5 m high and in good working order)
- VII. using water-sealed ascension pipes to reduce visible emissions from the whole apparatus which provides a passage from the coke oven battery to the collecting main, gooseneck and stationary jumper pipes
- VIII. luting charging hole lids with a clay suspension (or other suitable sealing material), to reduce visible emissions from all holes
- IX. ensuring complete coking (avoiding green coke pushes) by application of adequate techniques
- X. installing larger coke oven chambers (applicable to new plants or in some cases of a complete replacement of the plant on the old foundations)
- XI. where possible, using variable pressure regulation to oven chambers during coking (applicable to new plants and can be an option for existing plants; the possibility of installing this technique in existing plants should be assessed carefully and is subject to the individual situation of every plant).

The percentage of visible emissions from all doors associated with **BAT** is $< 5 - 10$ %.

The percentage of visible emissions for all source types associated with **BAT VII** and **BAT VIII** is < 1 %.

The percentages are related to the frequency of any leaks compared to the total number of doors, ascension pipes or charging hole lids as a monthly average using a monitoring method as described below.

For the estimation of diffuse emissions from coke ovens the following methods are in use:

- the EPA 303 method
- the DMT (Deutsche Montan Technologie GmbH) methodology
- the methodology developed by BCRA (British Carbonisation Research Association).
- the methodology applied in the Netherlands, based on counting visible leaks of the ascension pipes and charging holes, while excluding visible emissions due to normal operations (coal charging, coke pushing).

47. BAT for the gas treatment plant is to minimise fugitive gaseous emissions by using the following techniques:

- I. minimising the number of flanges by welding piping connections wherever possible
- II. using appropriate sealings for flanges and valves
- III. using gas-tight pumps (e.g. magnetic pumps)
- IV. avoiding emissions from pressure valves in storage tanks by:
 - connecting the valve outlet to the coke oven gas (COG) collecting main or
 - collecting the gases and subsequent combustion.

Applicability

The techniques can be applied to both new and existing plants. In new plants, a gas tight design might be easier to achieve than in existing plants.

48. BAT is to reduce the sulphur content of the coke oven gas (COG) by using one of the following techniques:

- I. desulphurisation by absorption systems
- II. wet oxidative desulphurisation.

The residual hydrogen sulphide (H₂S) concentrations associated with BAT, determined as daily mean averages, are <300 – 1000 mg/Nm³ in the case of using BAT I (the higher values being associated with higher ambient temperature and the lower values being associated with lower ambient temperature) and <10 mg/Nm³ in the case of using BAT II.

49. BAT for the coke oven under firing is to reduce the emissions by using the following techniques:

- I. preventing leakage between the oven chamber and the heating chamber by means of regular coke oven operation
- II. repairing leakage between the oven chamber and the heating chamber (only applicable to existing plants)
- III. incorporating low-nitrogen oxides (NO_x) techniques in the construction of new batteries, such as staged combustion and the use of thinner bricks and refractory with a better thermal conductivity (only applicable to new plants)
- IV. using desulphurised coke oven gas (COG) process gases.

The **BAT-associated emission levels**, determined as daily mean values and relating to an oxygen content of 5 % are:

- sulphur oxides (SO_x), expressed as sulphur dioxide (SO₂) <200 – 500 mg/Nm³
- dust <1 – 20 mg/Nm³ ⁽¹⁾
- nitrogen oxides (NO_x), expressed as nitrogen dioxide (NO₂) <350 – 500 mg/Nm³ for new or substantially revamped plants (less than 10 years old) and 500 – 650 mg/Nm³ for older plants with well maintained batteries and incorporated low-nitrogen oxides (NO_x) techniques.

⁽¹⁾ The lower end of the range has been defined based on the performance of one specific plant achieved under real operating conditions by the BAT obtaining the best environmental performance.

50. BAT for coke pushing is to reduce dust emissions by using the following techniques:

- I. extraction by means of an integrated coke transfer machine equipped with a hood
- II. using land-based extraction gas treatment with a bag filter or other abatement systems
- III. using a one point or a mobile quenching car.

The **BAT-associated emission level** for dust from coke pushing is <10 mg/Nm³ in the case of bag filters and of <20 mg/Nm³ in other cases, determined as the average over the sampling period (discontinuous measurement, spot samples for at least half an hour).

Applicability

At existing plants, lack of space may constrain the applicability.

51. BAT for coke quenching is to reduce dust emissions by using one of the following techniques:

- I. using coke dry quenching (CDQ) with the recovery of sensible heat and the removal of dust from charging, handling and screening operations by means of a bag filter
- II. using emission-minimised conventional wet quenching
- III. using coke stabilisation quenching (CSQ).

The **BAT-associated emission levels** for dust, determined as the average over the sampling period, are:

- <20 mg/Nm³ in case of coke dry quenching
- <25 g/t coke in case of emission minimised conventional wet quenching ⁽¹⁾
- <10 g/t coke in case of coke stabilisation quenching ⁽²⁾.

⁽¹⁾ This level is based on the use of the non-isokinetic Mohrhauer method (former VDI 2303)

⁽²⁾ This level is based on the use of an isokinetic sampling method according to VDI 2066

Description of BAT I

For the continuous operation of coke dry quenching plants, there are two options. In one case, the coke dry quenching unit comprises two to up to four chambers. One unit is always on stand by. Hence no wet quenching is necessary but the coke dry quenching unit needs an excess capacity against the coke oven plant with high costs. In the other case, an additional wet quenching system is necessary.

In case of modifying a wet quenching plant to a dry quenching plant, the existing wet quenching system can be retained for this purpose. Such a coke dry quenching unit has no excess processing capacity against the coke oven plant.

Applicability of BAT II

Existing quenching towers can be equipped with emissions reduction baffles. A minimum tower height of at least 30 m is necessary in order to ensure sufficient draught conditions.

Applicability of BAT III

As the system is larger than that necessary for conventional quenching, lack of space at the plant may be a constraint.

52. BAT for coke grading and handling is to prevent or reduce dust emissions by using the following techniques in combination:

- I. use of building or device enclosures
- II. efficient extraction and subsequent dry dedusting.

The **BAT-associated emission level** for dust is <10 mg/Nm³, determined as the average over the sampling period (discontinuous measurement, spot samples for at least half an hour).

Water and waste water

53. **BAT is to minimise and reuse quenching water as much as possible.**
54. **BAT is to avoid the reuse of process water with a significant organic load (like raw coke oven waste water, waste water with a high content of hydrocarbons, etc.) as quenching water.**
55. **BAT is to pretreat waste water from the coking process and coke oven gas (COG) cleaning prior to discharge to a waste water treatment plant by using one or a combination of the following techniques:**
- I. using efficient tar and polycyclic aromatic hydrocarbons (PAH) removal by using flocculation and subsequent flotation, sedimentation and filtration individually or in combination
 - II. using efficient ammonia stripping by using alkaline and steam.
56. **BAT for pretreated waste water from the coking process and coke oven gas (COG) cleaning is to use biological waste water treatment with integrated denitrification/nitrification stages.**

The **BAT-associated emission levels**, based on a qualified random sample or a 24-hour composite sample and referring only to single coke oven water treatment plants, are:

• chemical oxygen demand (COD) ⁽¹⁾	<220 mg/l
• biological oxygen demand for 5 days (BOD ₅)	<20 mg/l
• sulphides, easily released ⁽²⁾	<0.1 mg/l
• thiocyanate (SCN ⁻)	<4 mg/l
• cyanide (CN ⁻), easily released ⁽³⁾	<0.1 mg/l
• polycyclic aromatic hydrocarbons (PAH) (sum of Fluoranthene, Benzo[b]fluoranthene, Benzo[k]fluoranthene, Benzo[a]pyrene, Indeno[1,2,3-cd]pyrene and Benzo[g,h,i]perylene)	<0.05 mg/l
• phenols	<0.5 mg/l
• sum of ammonia-nitrogen (NH ₄ ⁺ -N), nitrate-nitrogen (NO ₃ ⁻ -N) and nitrite-nitrogen (NO ₂ ⁻ -N)	<15 – 50 mg/l.

Regarding the sum of ammonia-nitrogen (NH₄⁺-N), nitrate-nitrogen (NO₃⁻-N) and nitrite-nitrogen (NO₂⁻-N), values of <35 mg/l are usually associated with the application of advanced biological waste water treatment plants with predenitrification/nitrification and post-denitrification.

- ⁽¹⁾ In some cases, TOC is measured instead of COD (in order to avoid HgCl₂ used in the analysis for COD). The correlation between COD and TOC should be elaborated for each coke oven plant case by case. The COD/TOC ratio may vary approximately between two and four.
- ⁽²⁾ This level is based on the use of the DIN 38405 D 27 or any other national or international standard that ensures the provision of data of an equivalent scientific quality.
- ⁽³⁾ This level is based on the use of the DIN 38405 D 13-2 or any other national or international standard that ensures the provision of data of an equivalent scientific quality.

Production residues

57. BAT is to recycle production residues such as tar from the coal water and still effluent, and surplus activated sludge from the waste water treatment plant back to the coal feed of the coke oven plant.

Energy

58. BAT is to use the extracted coke oven gas (COG) as a fuel or reducing agent or for the production of chemicals.

9.5 BAT Conclusions For Blast Furnaces

Unless otherwise stated, the BAT conclusions presented in this section can be applied to all blast furnaces.

Air emissions

- 59. BAT for displaced air during loading from the storage bunkers of the coal injection unit is to capture dust emissions and perform subsequent dry dedusting.**

The **BAT-associated emission level** for dust is $<20 \text{ mg/Nm}^3$, determined as the average over the sampling period (discontinuous measurement, spot samples for at least half an hour).

- 60. BAT for burden preparation (mixing, blending) and conveying is to minimise dust emissions and, where relevant, extraction with subsequent dedusting by means of an electrostatic precipitator or bag filter.**

- 61. BAT for casting house (tap holes, runners, torpedo ladles charging points, skimmers) is to prevent or reduce diffuse dust emissions by using the following techniques:**

- I. covering the runners
- II. optimising the capture efficiency for diffuse dust emissions and fumes with subsequent off-gas cleaning by means of an electrostatic precipitator or bag filter
- III. fume suppression using nitrogen while tapping, where applicable and where no collecting and dedusting system for tapping emissions is installed.

When using BAT II, the **BAT-associated emission level** for dust is $<1 - 15 \text{ mg/Nm}^3$, determined as a daily mean value.

- 62. BAT is to use tar-free runner linings.**
- 63. BAT is to minimise the release of blast furnace gas during charging by using one or a combination of the following techniques:**
- I. bell-less top with primary and secondary equalising
 - II. gas or ventilation recovery system
 - III. use of blast furnace gas to pressurise the top bunkers.

Applicability of BAT II

Applicable for new plants. Applicable for existing plants only where the furnace has a bell-less charging system. It is not applicable to plants where gases other than blast furnace gas (e.g. nitrogen) are used to pressurise the furnace top bunkers.

- 64. BAT is to reduce dust emissions from the blast furnace gas by using one or a combination of the following techniques:**
- I. using dry prededusting devices such as:
 - i. deflectors
 - ii. dust catchers
 - iii. cyclones
 - iv. electrostatic precipitators.
 - II. subsequent dust abatement such as:
 - i. hurdle-type scrubbers
 - ii. venturi scrubbers

- iii. annular gap scrubbers
- iv. wet electrostatic precipitators
- v. disintegrators.

For cleaned blast furnace (BF) gas, the residual dust concentration associated with **BAT** is $<10 \text{ mg/Nm}^3$, determined as the average over the sampling period (discontinuous measurement, spot samples for at least half an hour).

- 65. BAT for hot blast stoves is to reduce emissions by using desulphurised and dedusted surplus coke oven gas, dedusted blast furnace gas, dedusted basic oxygen furnace gas and natural gas, individually or in combination.**

The **BAT-associated emission levels**, determined as daily mean values related to an oxygen content of 3 %, are:

- sulphur oxides (SO_x) expressed as sulphur dioxide (SO_2) $<200 \text{ mg/Nm}^3$
- dust $<10 \text{ mg/Nm}^3$
- nitrogen oxides (NO_x), expressed as nitrogen dioxide (NO_2) $<100 \text{ mg/Nm}^3$.

Water and waste water

- 66. BAT for water consumption and discharge from blast furnace gas treatment is to minimise and to reuse scrubbing water as much as possible, e.g. for slag granulation, if necessary after treatment with a gravel-bed filter.**
- 67. BAT for treating waste water from blast furnace gas treatment is to use flocculation (coagulation) and sedimentation and the reduction of easily released cyanide, if necessary.**

The **BAT-associated emission levels**, based on a qualified random sample or a 24-hour composite sample, are:

- suspended solids $<30 \text{ mg/l}$
- iron $<5 \text{ mg/l}$
- lead $<0.5 \text{ mg/l}$
- zinc $<2 \text{ mg/l}$
- cyanide (CN^-), easily released ⁽¹⁾ $<0.4 \text{ mg/l}$.

⁽¹⁾ This level is based on the use of the DIN 38405 D 13-2 or any other national or international standard that ensures the provision of data of an equivalent scientific quality.

Production residues

- 68. BAT is to prevent waste generation from blast furnaces by using one or a combination of the following techniques:**
- I. appropriate collection and storage to facilitate a specific treatment
 - II on-site recycling of coarse dust from the blast furnace (BF) gas treatment and dust from the cast house dedusting, with due regard for the effect of emissions from the plant where it is recycled
 - III. hydrocyclonage of sludge with subsequent on-site recycling of the coarse fraction (applicable whenever wet dedusting is applied and where the zinc content distribution in the different grain sizes allows a reasonable separation)

- IV. slag treatment, preferably by means of granulation (where market conditions allow for it), for the external use of slag (e.g. in the cement industry or for road construction).

BAT is to manage in a controlled manner blast furnace process residues which can neither be avoided nor recycled.

69. **BAT for minimising slag treatment emissions is to condense fume if odour reduction is required.**

Resource management

70. **BAT for resource management of blast furnaces is to reduce coke consumption by directly injected reducing agents, such as pulverised coal, oil, heavy oil, tar, oil residues, coke oven gas (COG), natural gas and wastes such as metallic residues, used oils and emulsions, oily residues, fats and waste plastics individually or in combination.**

Applicability

Coal injection: The method is applicable to all blast furnaces equipped with pulverised coal injection and oxygen enrichment.

Gas injection: Tuyère injection of coke oven gas (COG) is highly dependent upon the availability of the gas that may be effectively used elsewhere in the integrated steelworks.

Plastic injection: It should be noted that this technique is highly dependent on the local circumstances and market conditions. Plastics can contain Cl and heavy metals like Hg, Cd, Pb and Zn. Depending on the composition of the wastes used (e.g. shredder light fraction), the amount of Hg, Cr, Cu, Ni and Mo in the BF gas may increase.

Direct injection of used oils, fats and emulsions as reducing agents and of solid iron residues: The continuous operation of this system is reliant on the logistical concept of delivery and the storage of residues. Also, the conveying technology applied is of particular importance for a successful operation.

Energy

71. **BAT is to maintain a smooth, continuous operation of the blast furnace at a steady state to minimise releases and to reduce the likelihood of burden slips.**
72. **BAT is to use the extracted blast furnace gas as a fuel.**
73. **BAT is to recover the energy of top blast furnace gas pressure where sufficient top gas pressure and low alkali concentrations are present.**

Applicability

Top gas pressure recovery can be applied at new plants and in some circumstances at existing plants, albeit with more difficulties and additional costs. Fundamental to the application of this technique is an adequate top gas pressure in excess of 1.5 bar gauge.

At new plants, the top gas turbine and the blast furnace (BF) gas cleaning facility can be adapted to each other in order to achieve a high efficiency of both scrubbing and energy recovery.

- 74. BAT is to preheat the hot blast stove fuel gases or combustion air using the waste gas of the hot blast stove and to optimise the hot blast stove combustion process.**

Description

For optimisation of the energy efficiency of the hot stove, one or a combination of the following techniques can be applied:

- the use of a computer-aided hot stove operation
- preheating of the fuel or combustion air in conjunction with insulation of the cold blast line and waste gas flue
- use of more suitable burners to improve combustion
- rapid oxygen measurement and subsequent adaptation of combustion conditions.

Applicability

The applicability of fuel preheating depends on the efficiency of the stoves as this determines the waste gas temperature (e.g. at waste gas temperatures below 250 °C, heat recovery may not be a technically or economically viable option).

The implementation of computer-aided control could require the construction of a fourth stove in the case of blast furnaces with three stoves (if possible) in order to maximise benefits.

9.6 BAT Conclusions For Basic Oxygen Steelmaking And Casting

Unless otherwise stated, the BAT conclusions presented in this section can be applied to all basic oxygen steelmaking and casting.

Air emissions

75. BAT for basic oxygen furnace (BOF) gas recovery by suppressed combustion is to extract the BOF gas during blowing as much as possible and to clean it by using the following techniques in combination:

- I use of a suppressed combustion process
- II. prededusting to remove coarse dust by means of dry separation techniques (e.g. deflector, cyclone) or wet separators
- III. dust abatement by means of:
 - i. dry dedusting (e.g. electrostatic precipitator) for new and existing plants
 - ii. wet dedusting (e.g. wet electrostatic precipitator or scrubber) for existing plants.

The residual dust concentrations associated with **BAT**, after buffering the BOF gas, are:

- 10 – 30 mg/Nm³ for BAT III.i
- <50 mg/Nm³ for BAT III.ii.

76. BAT for basic oxygen furnace (BOF) gas recovery during oxygen blowing in the case of full combustion is to reduce dust emissions by using one of the following techniques:

- I. dry dedusting (e.g. ESP or bag filter) for new and existing plants
- II. wet dedusting (e.g. wet ESP or scrubber) for existing plants.

The **BAT-associated emission levels** for dust, determined as the average over the sampling period (discontinuous measurement, spot samples for at least half an hour), are:

- 10 – 30 mg/Nm³ for BAT I
- <50 mg/Nm³ for BAT II.

77. BAT is to minimise dust emissions from the oxygen lance hole by using one or a combination of the following techniques:

- I. covering the lance hole during oxygen blowing
- II. inert gas or steam injection into the lance hole to dissipate the dust
- III. use of other alternative sealing designs combined with lance cleaning devices.

78. BAT for secondary dedusting, including the emissions from the following processes:

- reladling of hot metal from the torpedo ladle (or hot metal mixer) to the charging ladle
- hot metal pretreatment (i.e. the preheating of vessels, desulphurisation, dephosphorisation, deslagging, hot metal transfer processes and weighing)
- BOF-related processes like the preheating of vessels, slopping during oxygen blowing, hot metal and scrap charging, tapping of liquid steel and slag from BOF and
- secondary metallurgy and continuous casting,

is to minimise dust emissions by means of process integrated techniques, such as general techniques to prevent or control diffuse or fugitive emissions, and by using appropriate enclosures and hoods with efficient extraction and a subsequent off-gas cleaning by means of a bag filter or an ESP.

The overall average dust collection efficiency associated with **BAT** is >90 %

The **BAT-associated emission level** for dust, as a daily mean value, for all dedusted off-gases is <1 – 15 mg/Nm³ in the case of bag filters and <20 mg/Nm³ in the case of electrostatic precipitators.

If the emissions from hot metal pretreatment and the secondary metallurgy are treated separately, the **BAT-associated emission level** for dust, as a daily mean value, is <1 – 10 mg/Nm³ for bag filters and <20 mg/Nm³ for electrostatic precipitators.

Description

General techniques to prevent diffuse and fugitive emissions from the relevant BOF process secondary sources include:

- independent capture and use of dedusting devices for each subprocess in the BOF shop
- correct management of the desulphurisation installation to prevent air emissions
- total enclosure of the desulphurisation installation
- maintaining the lid on when the hot metal ladle is not in use and the cleaning of hot metal ladles and removal of skulls on a regular basis or alternatively apply a roof extraction system
- maintaining the hot metal ladle in front of the converter for approximately two minutes after putting the hot metal into the converter if a roof extraction system is not applied
- computer control and optimisation of the steelmaking process, e.g. so that slopping (i.e. when the slag foams to such an extent that it flows out of the vessel) is prevented or reduced
- reduction of slopping during tapping by limiting elements that cause slopping and the use of anti-slopping agents
- closure of doors from the room around the converter during oxygen blowing
- continuous camera observation of the roof for visible emission
- the use of a roof extraction system.

Applicability

In existing plants, the design of the plant may restrict the possibilities for proper evacuation.

79. **BAT for on-site slag processing is to reduce dust emissions by using one or a combination of the following techniques:**

- I. efficient extraction of the slag crusher and screening devices with subsequent off-gas cleaning, if relevant
- II transport of untreated slag by shovel loaders
- III. extraction or wetting of conveyor transfer points for broken material
- IV. wetting of slag storage heaps
- V. use of water fogs when broken slag is loaded.

The **BAT-associated emission level** for dust in the case of using BAT I is <10 – 20 mg/Nm³, determined as the average over the sampling period (discontinuous measurement, spot samples for at least half an hour).

Water and waste water

80. BAT is to prevent or reduce water use and waste water emissions from primary dedusting of basic oxygen furnace (BOF) gas by using one of the following techniques as set out in BAT 75 and BAT 76:

- dry dedusting of basic oxygen furnace (BOF) gas;
- minimising scrubbing water and reusing it as much as possible (e.g. for slag granulation) in case wet dedusting is applied.

81. BAT is to minimise the waste water discharge from continuous casting by using the following techniques in combination:

- I. the removal of solids by flocculation, sedimentation and/or filtration
- II. the removal of oil in skimming tanks or any other effective device
- III. the recirculation of cooling water and water from vacuum generation as much as possible.

The **BAT-associated emission levels**, based on a qualified random sample or a 24-hour composite sample, for waste water from continuous casting machines are:

• suspended solids	<20 mg/l
• iron	<5 mg/l
• zinc	<2 mg/l
• nickel	<0.5 mg/l
• total chromium	<0.5 mg/l
• total hydrocarbons	<5 mg/l.

Production residues

82. BAT is to prevent waste generation by using one or a combination of the following techniques (see BAT 8):

- I. appropriate collection and storage to facilitate a specific treatment
- II. on-site recycling of dust from basic oxygen furnace (BOF) gas treatment, dust from secondary dedusting and mill scale from continuous casting back to the steelmaking processes with due regard for the effect of emissions from the plant where they are recycled
- III. on-site recycling of BOF slag and BOF slag fines in various applications
- IV. slag treatment where market conditions allow for the external use of slag (e.g. as an aggregate in materials or for construction)
- V. use of filter dusts and sludge for external recovery of iron and non-ferrous metals such as zinc in the non-ferrous metals industry
- VI. use of a settling tank for sludge with the subsequent recycling of the coarse fraction in the sinter/blast furnace or cement industry when grain size distribution allows for a reasonable separation.

Applicability of BAT V

Dust hot briquetting and recycling with recovery of high zinc concentrated pellets for external reuse is applicable when a dry electrostatic precipitation is used to clean the BOF gas. Recovery of zinc by briquetting is not applicable in wet dedusting systems because of unstable sedimentation in the settling tanks caused by the formation of hydrogen (from a reaction of metallic zinc and water). Due to these safety reasons, the zinc content in the sludge should be limited to 8 – 10 %.

BAT is to manage in a controlled manner basic oxygen furnace process residues which can neither be avoided nor recycled.

Energy

- 83. BAT is to collect, clean and buffer BOF gas for subsequent use as a fuel.**

Applicability

In some cases, it may not be economically feasible or, with regard to appropriate energy management, not feasible to recover the BOF gas by suppressed combustion. In these cases, the BOF gas may be combusted with the generation of steam. The kind of combustion (full or suppressed combustion) depends on local energy management.

- 84. BAT is to reduce energy consumption by using ladle-lid systems.**

Applicability

The lids can be very heavy as they are made out of refractory bricks and therefore the capacity of the cranes and the design of the whole building may constrain the applicability in existing plants. There are different technical designs for implementing the system into the particular conditions of a steel plant.

- 85. BAT is to optimise the process and reduce energy consumption by using a direct tapping process after blowing.**

Description

Direct tapping normally requires expensive facilities like sub-lance or DROP IN sensor-systems to tap without waiting for a chemical analysis of the samples taken (direct tapping). Alternatively, a new technique has been developed to achieve direct tapping without such facilities. This technique requires a lot of experience and developmental work. In practice, the carbon is directly blown down to 0.04 % and simultaneously the bath temperature decreases to a reasonably low target. Before tapping, both the temperature and oxygen activity are measured for further actions.

Applicability

A suitable hot metal analyser and slag stopping facilities are required and the availability of a ladle furnace facilitates implementation of the technique.

- 86. BAT is to reduce energy consumption by using continuous near net shape strip casting, if the quality and the product mix of the produced steel grades justify it.**

Description

Near net shape strip casting means the continuous casting of steel to strips with thicknesses of less than 15 mm. The casting process is combined with the direct hot rolling, cooling and coiling of the strips without an intermediate reheating furnace used for conventional casting techniques, e.g. continuous casting of slabs or thin slabs. Therefore, strip casting represents a technique for producing flat steel strips of different widths and thicknesses of less than 2 mm.

Applicability

The applicability depends on the produced steel grades (e.g. heavy plates cannot be produced with this process) and on the product portfolio (product mix) of the individual steel plant. In existing plants, the applicability may be constrained by the layout and the available space as e.g. retrofitting with a strip caster requires approximately 100 m in length.

9.7 BAT Conclusions For Electric Arc Furnace Steelmaking And Casting

Unless otherwise stated, the BAT conclusions presented in this section can be applied to all electric arc furnace steelmaking and casting.

Air emissions

87. **BAT for the electric arc furnace (EAF) process is to prevent mercury emissions by avoiding, as much as possible, raw materials and auxiliaries which contain mercury (see BAT 6 and 7).**
88. **BAT for the electric arc furnace (EAF) primary and secondary dedusting (including scrap preheating, charging, melting, tapping, ladle furnace and secondary metallurgy) is to achieve an efficient extraction of all emission sources by using one of the techniques listed below and to use subsequent dedusting by means of a bag filter:**
- I. a combination of direct off-gas extraction (4th or 2nd hole) and hood systems
 - II. direct gas extraction and doghouse systems
 - III. direct gas extraction and total building evacuation (low-capacity electric arc furnaces (EAF) may not require direct gas extraction to achieve the same extraction efficiency).

The overall average collection efficiency associated with **BAT** is >98 %.

The **BAT-associated emission level** for dust is <5 mg/Nm³, determined as a daily mean value.

The **BAT-associated emission level** for mercury is <0.05 mg/Nm³, determined as the average over the sampling period (discontinuous measurement, spot samples for at least four hours).

89. **BAT for the electric arc furnace (EAF) primary and secondary dedusting (including scrap preheating, charging, melting, tapping, ladle furnace and secondary metallurgy) is to prevent and reduce polychlorinated dibenzodioxins/furans (PCDD/F) and polychlorinated biphenyls (PCB) emissions by avoiding, as much as possible, raw materials which contain PCDD/F and PCB or their precursors (see BAT 6 and 7) and using one or a combination of the following techniques, in conjunction with an appropriate dust removal system:**
- I. appropriate post-combustion
 - II. appropriate rapid quenching
 - III. injection of adequate adsorption agents into the duct before dedusting.

The **BAT-associated emission level** for polychlorinated dibenzodioxins/furans (PCDD/F) is <0.1 ng I-TEQ/Nm³, based on a 6–8 hour random sample during steady-state conditions. In some cases, the BAT-associated emission level can be achieved with primary measures only.

Applicability of BAT I

In existing plants, circumstances like available space, given off-gas duct system, etc. need to be taken into consideration for assessing the applicability.

90. BAT for on-site slag processing is to reduce dust emissions by using one or a combination of the following techniques:

- I. efficient extraction of the slag crusher and screening devices with subsequent off-gas cleaning, if relevant
- II. transport of untreated slag by shovel loaders
- III. extraction or wetting of conveyor transfer points for broken material
- IV. wetting of slag storage heaps
- V. use of water fogs when broken slag is loaded.

In the case of using BAT I, the **BAT-associated emission level** for dust is $<10 - 20$ mg/Nm³, determined as the average over the sampling period (discontinuous measurement, spot samples for at least half an hour).

Water and waste water

91. BAT is to minimise the water consumption from the electric arc furnace (EAF) process by the use of closed loop water cooling systems for the cooling of furnace devices as much as possible unless once-through cooling systems are used.

92. BAT is to minimise the waste water discharge from continuous casting by using the following techniques in combination:

- I. the removal of solids by flocculation, sedimentation and/or filtration
- II. the removal of oil in skimming tanks or in any other effective device
- III. the recirculation of cooling water and water from vacuum generation as much as possible.

The **BAT-associated emission levels**, for waste water from continuous casting machines, based on a qualified random sample or a 24-hour composite sample, are:

- | | |
|----------------------|-----------|
| • suspended solids | <20 mg/l |
| • iron | <5 mg/l |
| • zinc | <2 mg/l |
| • nickel | <0.5 mg/l |
| • total chromium | <0.5 mg/l |
| • total hydrocarbons | <5 mg/l |

Production residues

93. BAT is to prevent waste generation by using one or a combination of the following techniques:

- I. appropriate collection and storage to facilitate a specific treatment
- II. recovery and on-site recycling of refractory materials from the different processes and use internally, i.e. for the substitution of dolomite, magnesite and lime
- III. use of filter dusts for the external recovery of non-ferrous metals such as zinc in the non-ferrous metals industry, if necessary, after the enrichment of filter dusts by recirculation to the electric arc furnace (EAF)
- IV. separation of scale from continuous casting in the water treatment process and recovery with subsequent recycling, e.g. in the sinter/blast furnace or cement industry
- V. external use of refractory materials and slag from the electric arc furnace (EAF) process as a secondary raw material where market conditions allow for it.

BAT is to manage in a controlled manner EAF process residues which can neither be avoided nor recycled.

Applicability

The external use or recycling of production residues as mentioned under BAT III – V depend on the cooperation and agreement of a third party which may not be within the control of the operator, and therefore may not be within the scope of the permit.

Energy

- 94. BAT is to reduce energy consumption by using continuous near net shape strip casting, if the quality and the product mix of the produced steel grades justify it.**

Description

Near net shape strip casting means the continuous casting of steel to strips with thicknesses of less than 15 mm. The casting process is combined with the direct hot rolling, cooling and coiling of the strips without an intermediate reheating furnace used for conventional casting techniques, e.g. continuous casting of slabs or thin slabs. Therefore, strip casting represents a technique for producing flat steel strips of different widths and thicknesses of less than 2 mm.

Applicability

The applicability depends on the produced steel grades (e.g. heavy plates cannot be produced with this process) and on the product portfolio (product mix) of the individual steel plant. In existing plants, the applicability may be constrained by the layout and the available space as e.g. retrofitting with a strip caster requires approximately 100 m in length.

Noise

- 95. BAT is to reduce noise emissions from electric arc furnace (EAF) installations and processes generating high sound energies by using a combination of the following constructional and operational techniques depending on and according to local conditions (in addition to using the techniques listed in BAT 18):**

- I. construct the electric arc furnace (EAF) building in such a way as to absorb noise from mechanical shocks resulting from the operation of the furnace
- II. construct and install cranes destined to transport the charging baskets to prevent mechanical shocks
- III. special use of acoustical insulation of the inside walls and roofs to prevent the airborne noise of the electric arc furnace (EAF) building
- IV. separation of the furnace and the outside wall to reduce the structure-borne noise from the electric arc furnace (EAF) building
- V. housing of processes generating high sound energies (i.e. electric arc furnace (EAF) and decarburisation units) within the main building.

10 ALTERNATIVE IRONMAKING TECHNIQUES

[383, EIPPCB 2006]

This chapter is not as detailed as previous chapters as there is only one alternative ironmaking installation in the EU, which is a DRI plant in Germany.

Although the blast furnace (BF) route is the main process for iron production, several other production routes for hot metal are being developed and are applied commercially. These 'smelting reduction' techniques invariably use coal instead of coke as the main reducing agent. Some of the new techniques also replace pellets and sinter with pulverised iron ore fines. These alternative technologies are described in more detail below.

Iron has been made in blast furnaces for more than 500 years. During that time, the blast furnaces have evolved into highly efficient reactors. However, other techniques are now available which present a challenge to the blast furnace route for hot metal production.

Blast furnaces require coke, and coke plants are expensive and have many environmental problems associated with their operation. Thus, it would be beneficial from an economic and environmental point of view to produce hot metal without the use of coke. At the time of writing (2010), nearly all blast furnaces reduce their coke consumption significantly by means of reductant injection at tuyères. However, coke can never be fully replaced in a blast furnace because of its burden supporting function. The minimum blast furnace coke rate is approximately 260 kg/t hot metal.

There is an increasing production of steel from scrap in electric arc furnaces (EAFs). Production of steel from scrap consumes considerably less energy compared to the production of steel from iron ores. The problems with the quality of scrap-based steel introduce restraints and the use of direct reduced iron (DRI) as feedstock enlarges the possibilities of the EAF steelmaking route.

In summary, the following aspects put pressure on the blast furnace production route of steel:

- the environmental aspects of sinter plants
- the environmental and economic aspects of the coke oven plant
- the relative inflexibility and scale of the hot metal production
- the increasing competition by the scrap-based and DRI EAF steelmaking route.

But the advantages of the BF route as regards recycling capability and economical investment should be recognised.

The aforementioned has triggered the improved environmental and economic operations of the blast furnace route and the development of alternative routes for ironmaking.

Two main types of alternative ironmaking which can be considered as proven types of alternative ironmaking are the following: direct reduction (DR) and smelting reduction (SR).

Figure 10.1 gives an overview of past, present and future routes for iron and steelmaking.

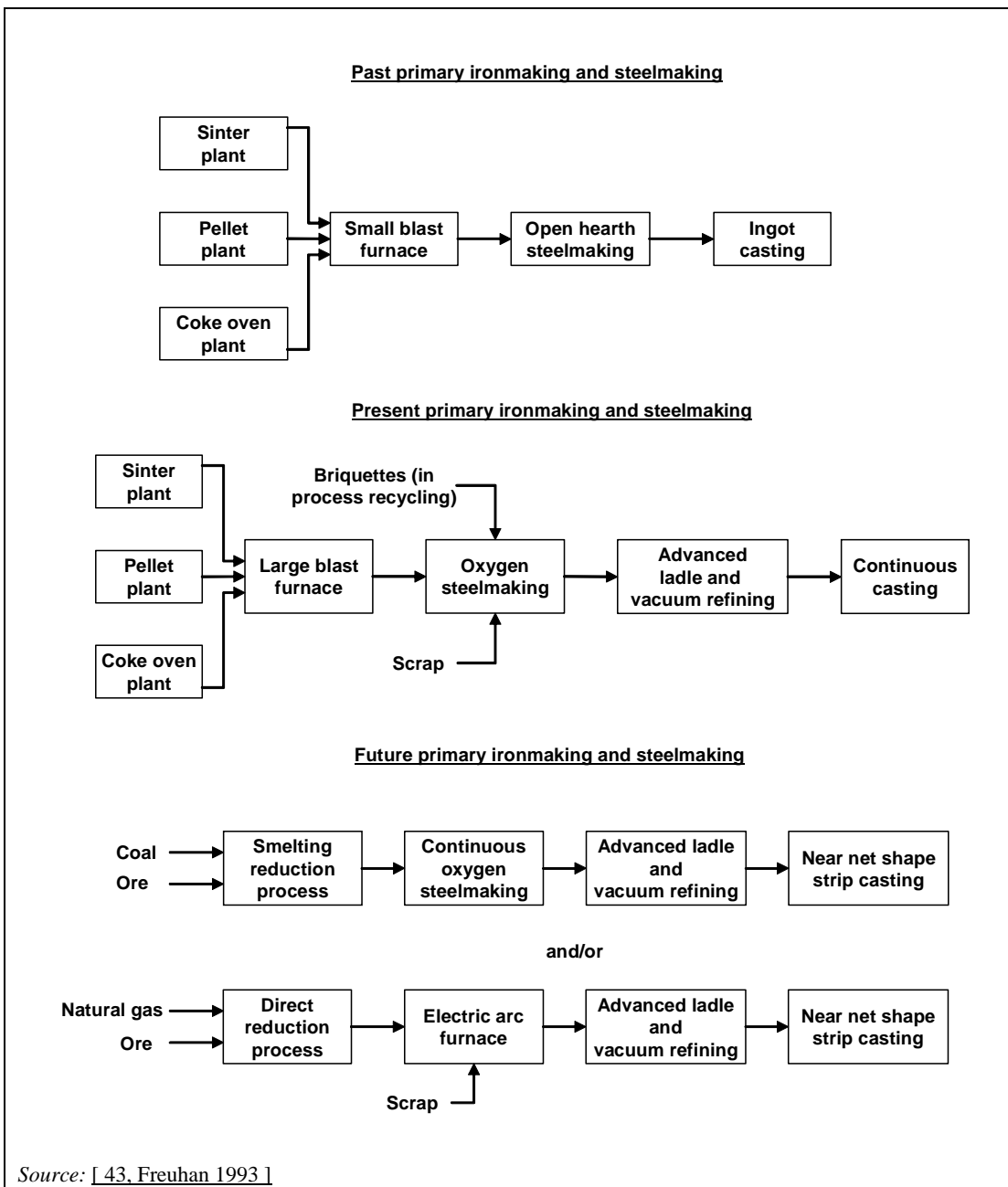

Figure 10.1: Past, present and future routes for alternative ironmaking and steelmaking processes

10.1 Direct reduction (DR)

Direct reduction involves the production of solid primary iron from iron ores and a reducing agent (e.g. natural gas). The solid product is called direct reduced iron (DRI) and is mainly applied as feedstock in electric arc furnaces (EAF). The direct reduction process has been commercialised since the 1970s and a variety of processes have been developed.

Because there is no separation of iron from gangue in the reduction facility, high-grade ores or concentrates (68 % Fe and a gangue content 27 %) must be used for the reduction to metallic iron in the solid state. The process temperatures are less than 1000 °C. DRI has a metallisation rate of >92 % and a carbon content of <2 %. The direct reduced iron is normally used as feedstock for EAFs.

DRI may have a high gangue content, and this reduces its value in EAF steelmaking, particularly in areas with high electrical power costs.

A drawback of DRI is that it can pose a fire hazard. Therefore, DRI can be melted into briquettes, as hot briquetted iron (HBI), when the product should be stored or transported over some distance.

The first commercial plants were built in the late 1960s. Because the leading direct reduction processes require a cheap source of natural gas, most of the plants are situated in the oil and gas-rich belt around the equator.

Table 10.1 shows the percentage of DRI production related to the world hot metal production for 1996 and 2006.

Table 10.1: World production of DRI

Year	World annual production (Mt)	Percentage related to the world hot metal production (%)
1996/97	36.5	4.4 %
2006	59.8	6.8 %

Source: [200, Commission 2001] [260, Germany 2007].

Two thirds of the world production of DRI in 2006 was concentrated in five countries: India (15.0 Mt – 4 Mt more than in 2005), Venezuela (8.6 Mt), Iran (6.9 Mt), Mexico (6.2 Mt) and Saudi Arabia (3.6 Mt). New plants were commissioned in India, Nigeria, Trinidad, Saudi Arabia, Qatar and Russia [260, Germany 2007]. The DR method has been successful, especially in producing powders.

Available processes

DRI processes can be divided up by the type of reactor employed, namely:

- shaft furnaces (Midrex[®], HyL)
- rotary kilns (SL/RN process)
- rotary hearth furnaces (Fastmet[®]/Fastmelt[®], Inmetco[®]/RedIron[®], and ITmk3[®])
- fluidised bed reactors (Circofer[®]).

Many of these solid-state processes use natural gas as the fuel and as the reducing agent (carbon monoxide and hydrogen). Approximately 92 % of the DRI is produced by using (reformed) natural gas as a fuel. In a limited number of sites, coal is used as a fuel.

As feedstock, iron ore pellets and lump ore are used in processes with a shaft furnace (Midrex, HyL) and fines and concentrates are used in processes with a fluidised bed (Circored, Finmet, Iron carbide) or a rotary hearth furnace (Fastmet[®], Inmetco[®]).

An alternative to DRI is iron carbide (Fe_3C). Iron carbide is produced by means of direct reduction also, but the product contains approximately 90 wt-% Fe_3C . The carbon content is relatively high: 6 wt-%, which provides enough energy to reduce electricity consumption in the EAF. Iron carbide can be used in the same applications as DRI. The first commercial iron carbide plant, of a capacity of 300 000 metric tonnes per year was commissioned in 1995 in Trinidad (actual production in 1998 was 150000 t/yr).

In Table 10.2, the characteristics of the commercially available types of DRI making are summarised.

Table 10.2: Characteristics of commercially available direct reduction processes

Parameter	Process			
	Midrex	HyL III	Fastmet/ Inmetco	Finmet
Status	Industrial	Industrial	Industrial	Industrial
Type of reactor	Shaft	Shaft	Rotary hearth	Fluid bed
Iron source	Pellet/ lump ore	Pellet/ lump ore	Fines/ concentrates	Fines 0.1 – 12 mm
Type of fuel	Natural gas	Natural gas	Coal/natural gas	Natural gas
Utilities	–	Steam	–	Steam
Peripheral facilities	Reformer	Reformer CO ₂ removal	–	Reformer CO ₂ removal
Typical plant capacity (kt/yr)	1000	1000	450	500
Energy input (GJ/t product)	10.5	11.3	12.6	12.5
Product	DRI/HBI	DRI	DRI/HBI	HBI
Product metallisation (%)	>92	>92	>92	>92
Product carbon content (%)	1 – 2	1 – 2	<0.2	0.5 – 1.5
<i>Source: [98, Nagai 1995] [177, Eurofer 2009].</i>				

During the steelmaking process, DRI is superior to scrap in purity and uniformity of composition, but these benefits come at a higher cost.

DRI utilisation is reasonable in the following situations:

- when good quality scrap runs short, thus causing the quality of the steel products to deteriorate, and making it necessary to add reduced iron to raise the quality of the raw material
- in mini-mills built in regions where the delivery of iron sources such as scrap is difficult, or where the construction of an integrated steel plant with a blast furnace is not necessary from the viewpoint of the size of the demand, in which case reduced iron can be used as the main raw material [98, Nagai 1995]
- in blast furnaces where increased capacity of hot metal output is required.

Environmental aspects of DRI

The main benefit of a direct reduction unit compared to a blast furnace is that the direct reduction unit uses natural gas or coal as a fuel. Therefore, a coke oven plant is no longer needed, significantly reducing emissions. The impact on the environment of a direct reduction unit itself is very limited. There is little dust emission, which is easy to collect. The water need is low and water can be recycled to a large extent. Furthermore, a methane-based direct reduction unit produces much less CO₂ than a coal-based unit.

However, DRI contains some gangue (3–6 %) and this leads to an increased power consumption of the EAF with increasing DRI input. This can partly be compensated for by the direct hot charge of DRI. ITmk3 technology providers claim that because part of the sensible heat of the off-gas is recovered and recycled to the heat input as a preheated air, the estimated CO₂ emissions of this route + EAF is 20–25 % lower than the BF+BOF route [208, Lindfors et al. 2006].

10.2 Smelting reduction (SR)

Smelting reduction (SR) is associated with the production of hot metal from iron ore without coke. SR employs two units: in the first, iron ore is heated and reduced by gases generated from the second unit, which is a smelter-gasifier supplied with coal and oxygen. The partially reduced ore is then smelted in the second unit, and liquid hot metal or (in some cases) liquid steel is produced. Smelting-reduction technology enables a wide range of coals to be used for ironmaking.

Examples of this technology include the Corex[®] and Finex[®] processes which are operating on a commercial basis.

10.2.1 Corex and Finex processes

Description

The Corex process is a two-stage process: in the first step, iron ore is reduced to sponge iron in a shaft furnace by means of reducing gas; in the second step, the reduced iron is melted in the melter-gasifier vessel. Reducing gas (CO and H₂) which is used in the reduction shaft is supplied by the gasification of coal by means of oxygen, forming a fixed/fluidised bed in the melter-gasifier. The partial combustion of the coal in the melter-gasifier generates the heat to melt the reduced iron. Liquid iron and slag are discharged at the bottom by a conventional tapping procedure similar to that used in blast furnace operations.

Because of the separation of iron reduction and iron melting/coal gasifying in two steps, a high degree of flexibility is achieved and a wide variety of coals can be used. The process is designed to perform at an elevated pressure, up to 5 bar. The charging of coal and iron ore is performed through a lock hopper system.

The reducing gas contains some 65 – 70 % CO, 20 – 25 % H₂ and 2 – 4 % CO₂. After leaving the melter-gasifier, the hot gas is mixed with cooling gas to adjust the temperature to approximately 850 °C. The gas is then cleaned in hot cyclones and fed into the shaft furnace as a reducing gas. When the gas leaves the shaft furnace, it still has a relatively high calorific value and may be used as an export gas where the opportunity exists. The calorific value of the gas is estimated at 7.5 MJ/Nm³ in the case of the use of a typical steam coal (28.5 % volatile matter), but other coal types may result in other heating values of the export gas.

A further development of Corex is the Finex process, jointly developed by Siemens VAI and the Korean steel producer Posco. The main difference between Corex and Finex is that Finex can directly use fine ore [260, Germany 2007]. In the Finex process a four-stage fluidised bed system is located upstream of a melter gasifier. After the reduction of the fine ores in the fluidised beds, the outcome gets hot-compacted prior to charging into the melter gasifier.

Achieved environmental benefits

The Corex process uses coal as an energy source. Therefore, emissions from the coke oven are prevented. All the higher hydrocarbons that are liberated from the coal are cracked into CO and H₂ in the melter-gasifier. Therefore, no by-products like tar, phenol, BTX, PAH, etc. are generated.

The sulphur charged with the coal into the process is, to a large extent, picked up in the shaft furnace by DRI and calcined additives and is subsequently fed to the melter-gasifier. Here, most of the sulphur is transferred to the liquid slag as in the BF route and becomes harmless to the environment. The amount of sulphur discharged from the Corex process by gas and water (2 – 3 % of the total sulphur input) is much lower than from the traditional coke oven/sinter plant/blast furnace route (20 – 30 %). The export gas contains 10 – 70 ppmv H₂S, depending on the type of coal used and the operational conditions. As oxygen (O₂) instead of air is used for

the gasification of char, no significant NO_x and cyanide (CN) formation occurs. The required use of oxygen results in significant additional overall energy demands.

Dust emissions from the Corex plant are significantly lower than in the traditional production route. All dust emissions at the coke oven are prevented. The dust content of the export gas is less than 5 mg/Nm³. Most of the dust which is captured in the gas cleaning system is recycled to the process.

Some performance data of the Iscor, South Africa plant are given in Table 10.3.

Table 10.3: Relevant performance data of the Corex plant at Iscor's Pretoria Works, South Africa (shutdown and dismantled in 1998)

Parameter		Units	Using lump ore	Using pellets	
Melting capacity		t HM/hour	45	53	
Specific melting capacity		t HM/m ³ per day	3.0	3.4	
Coal consumption		kg/t HM	1080	1000	
C _{fix} consumption		kg/t HM	615	570	
O ₂ consumption		Nm ³ /t HM	540	500	
Slag quantity		kg/t HM	450	300	
Hot metal composition	Carbon	%	4.5	4.5	
	Silicon	%	0.3	0.3	
	Sulphur	%	0.05	0.05	
	Phosphorus	%	0.15	0.15	
Export gas	Quantity	Nm ³ /t HM	1750	1710	
	Lower calorific value	MJ/t HM	7.5	7.5	
	Composition	CO	%	45	45
		CO ₂	%	32	32
		H ₂	%	16	16
Dust		mg/Nm ³	<5	<5	
Emission	Dust	g/t HM	39 – 139	39 – 139	
	SO ₂	g/t HM	26 – 333	26 – 333	
	NO _x	g/t HM	21 – 33	21 – 33	
Energy consumption		GJ/t HM	17	17	
NB: HM = Hot metal.					
Source: [78, Kreulitsch et al. 1994] [82, Lemperle et al. 1993].					

Cross-media effects

The reduction gas from the melter-gasifier is cleaned in cyclones. The dust from these cyclones can be recycled to the melter-gasifier. The top gas from the shaft furnace and the cooling gas (to cool the reduction gas) are cleaned in scrubbers and thus a sludge is generated. The sludge can largely be recycled into the melter-gasifier after granulation or supplied to the cement industry. A small (not quantified) part may be disposed of.

The Corex process has a high specific coal consumption and a relatively large off-gas flow, with a medium-high calorific value. The use of this off-gas as an energy source largely determines the energetic efficiency of the process. Cooling water is supplied in a closed circuit.

Operational data

No data submitted.

Applicability

No data submitted.

Economics

Reported capital costs were EUR 195 per tonne hot metal. For the example, the currency was converted into ECU in 1996 and for the review into EUR.

Driving force for implementation

No data submitted.

Example plants

After a Corex plant was successfully commissioned in 1995 by Posco, Pohang Works, South Korea, the plant was converted to the Finex configuration with a production capacity of 600 000 tonnes per year in 2003. In this plant, a four-stage fluidised bed system is located upstream of a melter gasifier. After the reduction of the fine ores in the fluidised beds, the outcome gets hot-compacted prior to charging into the melter gasifier. A second plant with an annual capacity of 1.5 million tonnes went into operation at the Pohang site in April 2007.

By the end of 2007, a total of six Corex plants and two Finex plants have been in operation, representing an aggregate capacity of 7.45 million tonnes hot metal.

Table 10.4: Overview of Corex and Finex sites

Corex/ Finex plant	Number	Commissioned	Charge/burden	Capacity in million t/yr
Posco, Pohang Works, South Korea	1	1995/2003 (Corex/Finex)	Lump ores/fines	0.60
	1	2007 (Finex)	Fines	1.5
Jindal South West Steel, Torangallu, India	2	1997/2001	Lump ores, pellets	1.60 (2 × 0.8)
Mittal Steel, Saldanha South Africa	1	1999	Lump ores, pellets	0.65
Baosteel, Shanghai, China	1	2007	Lump ores,	1.50
	1	Start-up in 2010	pellets	1.5
Essar Steel, Hazira, India	2	2007	Pellets	1.60 (2 × 0.8)
<i>Source:</i> [260, Germany 2007] [312, Dr. Michael Degner et al. 2008].				

Another example for smelting reduction is the Primus[®] technique using a two-step process. This technique consists of the combination of a multiple hearth furnace (MHF) aiming to dry, heat up and initiate reduction followed by an electric arc furnace (EAF) leading to complete iron reduction and thus providing hot metal, forming the slag and finalising the zinc reduction. This technique permits the treatment of all typical iron and steelmaking residues which cannot normally be recycled within the existing plant, such as EAF dust, BF sludge, steelworks sludge and oily mill sludge scale (see Section 2.5.4.4.3).

Reference literature

[44, Freuhan 1994] [78, Kreulitsch et al. 1994] [82, Lemperle et al. 1993] [312, Dr. Michael Degner et al. 2008]

10.2.2 Processes under development

The following smelting reduction processes are in an advanced stage of development and are briefly described in this paragraph:

- HIs melt
- Direct Iron Ore Smelting (DIOS)
- AISI-DOE/CCF
- ROMELT

In Table 10.5, the characteristics of these processes are summarised. Short descriptions of the individual processes will be given in the following pages.

Table 10.5: Characteristics of the smelting reduction processes under development

	Process			
	HIs melt (Australia)	DIOS (Japan)	AISI-DOE/CCF (US/Netherlands)	ROMELT (Russia)
Main components	<ul style="list-style-type: none"> • Vertical smelt reduction 	<ul style="list-style-type: none"> • Prereduction in fluidised bed • Gas-reforming furnace • Smelting reduction furnace • Oxygen plant 	<ul style="list-style-type: none"> • Cyclone converter furnace • In-bath melting vessel • Oxygen plant 	<ul style="list-style-type: none"> • Bath smelter
Feedstock	Fines	Fines	Fines	Fines/waste oxides
Fuel	Pulverised coal	Coal-fines /granular coal	Coal fines	Coal fines
Metal product	Liquid iron	Liquid iron	Liquid iron	Liquid iron
Oxygen consumption (Nm ³ /t HM)	Uses hot blast	500	430 – 680	750 – 850
Coal consumption (kg/t HM)	630 – 700	950	700 – 750	900 – 1200
Off-gas quantity (Nm ³ /t HM)	1850	2080	NA	NA
Calorific value (MJ/Nm ³)	1.44	3.74	NA	NA
Net energy consumption (GJ/t HM)	NA	NA	NA	NA
Energy output (GJ/t HM)	2.7	7.8	4.0	NA
Status	Pilot	Pilot	Pilot	Pilot
NB: — HM = Hot metal. — NA = Data not available. Source: [44, Freuhan 1994] [98, Nagai 1995].				

HIs melt

Description

In this process, ores, coal and fluxes are injected into an iron bath by a total of eight lances of which four tend to be used for the cold coal and lime and four serve to inject ore and dolomite (5 %) in their hot condition 600 – 700 °C. The ores are quickly reduced and melt directly in the

bath. Hot blast (1200 – 1250 °C) with a 35 % O₂ content is injected via a central lance through the slag causing the CO and H₂ fractions to be post-combusted in the off-gas. A hot metal sump is usually required in order to start up the plant. Hot metal tapping is performed continuously via a forehearth, while slag tapping is performed by batch tapping every two to three hours via the slag tap hole [312, Dr. Michael Degner et al. 2008].

Operational data

SR in the HIs melt process leads to lower silicone contents amounting to less than 0.01 % and also lower phosphorus contents of less than 0.02 % in the hot metal [312, Dr. Michael Degner et al. 2008].

Status

A HIs melt plant was commissioned at Kwinana, Western Australia by the HIs melt Corporation. This plant is designed for an annual production of 800 000 tonnes hot metal [312, Dr. Michael Degner et al. 2008].

Environmental implications

Compared to blast furnace ironmaking, fuel savings of 10 % is predicted. Furthermore, operation of an iron ore pretreatment plant (pellet plant, sinter plant) and a coke oven plant is no longer necessary. In contrast to the other smelting reduction processes, a hot blast is needed. This will probably influence the NO_x emissions of this process in a negative way.

DIOS

Description

The Direct Iron Ore Smelting (DIOS) process consists of three sub-processes: a fluidised bed prereduction furnace (PRF) to prereduce the iron ore, a gas-reforming furnace (GRF) to mix coal powder into the gas, and a smelting reduction furnace (SRF) to further reduce and smelt the iron ore.

Combustion oxygen is injected from the top of the SRF. The generated carbon monoxide (CO) is used to prereduce the iron ore in the PRF. Nitrogen is injected in the bottom of the SRF to agitate the slag in the furnace.

Status

At NKK's Keihin Works, Japan, a pilot plant has been in operation since 1994, producing approximately 500 tonnes of iron per day.

Environmental implications

It is expected that the energy consumption of DIOS will be 5 – 10 % lower compared to the blast furnace route. Furthermore, the iron pretreatment plant (pellet plant, sinter plant) and the coke oven plant are no longer needed.

Reference literature

[78, Kreulitsch et al. 1994]

AISI-DOE/CCF

Description

The AISI-DOE project and the Cyclone Converter Furnace (CCF) project have started out as two separate development projects.

The AISI-DOE project was a cooperative R&D project for direct ironmaking (smelting reduction) by a number of universities and American and Canadian steelmaking companies. The project was coordinated by the American Iron and Steel Institute and sponsored by the US

Department of Energy. The aim of the project is to produce steel from prereduced iron ore and coal in a vertical bath smelter. The development of the vertical bath smelter has formed the most important part of the project.

The CCF project was a joint initiative of Corus, IJmuiden, the Netherlands and Ilva, Italy. The most important part of the project is the development of the cyclone reactor. In the cyclone, the iron ore is prereduced and melted. The molten mixture falls into the lower part of the vessel where reduction is completed. The fuel consists of granular coal which is injected together with oxygen in the lower part of the vessel.

The high operating temperature of the cyclone reactor and the fact that it can handle a high level of entrained materials from the iron bath make a direct connection of the prereduction and the final reduction stages possible. Combining the two stages means that the heat transfer efficiency is not critical since there is no inter-stage cooling. The fact that both prereduction and final reduction take place in one vessel marks an important difference between the CCF and the other existing units for bath smelting reduction.

The CCF project had focused mainly on the development of the cyclone reactor.

In 1995, both parties recognised the possibility of combining their technology. With the combined techniques, a smelting reduction pilot plant can be realised.

Status

The AISI-DOE project has been operated in a number of trials, but no pilot plant has been commissioned. The CCF project has been operated on a pilot plant scale, with a capacity of 20 tonnes per hour.

Environmental aspects

Since no coke oven plant, sinter plant or pellet plant is required, a marked reduction of emissions can be achieved. Energy consumption per tonne steel will also be lower. Furthermore, power can be generated from the flue-gases which exit the cyclone at about 1800 °C.

Reference literature

[43, Freuhan 1993] [65, InfoMil 1997] [78, Kreulitsch et al. 1994]

ROMELT

Description

The ROMELT process has been under development in Russia for over 10 years. It is similar to other bath smelting processes, but does not use a prereducer. The process uses ore or waste oxides. Its coal consumption has been reported to be 900 – 1200 kg/metric tonne.

Status

A 500 – 1000 metric tonnes/day pilot plant at Novolipetsk, Russia has produced over 300 000 metric tonnes hot metal. Detailed plans for a 350 000 metric tonnes/yr have been made.

Environmental aspects

Since no coke oven plant, sinter plant or pellet plant is required, a significant reduction of emissions compared to conventional primary ironmaking can be expected. Energy consumption per tonne steel will be lower as well.

Reference literature

[44, Freuhan 1994] [65, InfoMil 1997]

Two other smelting reduction processes which should be briefly described are the

- PLASMAMELT process
- AUSMELT process

PLASMASMELT process

In plasma-based smelting reduction processes, the reactions take place in a coke-filled shaft furnace with tuyères spaced symmetrically around the lower part of the furnace. The shaft is completely filled with coke. Plasma generators and equipment for injection of metal oxides mixed with slag-forming material and possibly reductants are attached to the tuyères. In front of each tuyère, a cavity is formed inside the coke column where reduction and smelting take place. At regular intervals, the produced slag and metal are tapped from the bottom of the shaft furnace. In the case of iron ore smelting, the off-gas from the furnace, consisting mainly of carbon monoxide and hydrogen, can be used for the prereduction of the ore. In other applications of the process, such as the reclaiming of alloying metals from the bag house dust, the produced gas is utilised as a fuel gas. If the raw material contains metals with high vapour pressures, for example zinc and lead, these metals leave the furnace with the off-gas which is then passed through a condenser where the metals are recovered from the gas [383, EIPPCB 2006].

AUSMELT process

The Ausmelt process was developed by Ausmelt Ltd. Australia. Lump ore or ore fines are fed continuously into a converter along with lump coal and flux. Fine coal, oxygen and air are injected to allow submerged combustion. The degree of oxidation and reduction is controlled by adjusting fuel to air and coal ratios as well as the proportion of fine coal injected down the lance. All reactions are completed in a single reactor.

10.3 Comparison of the conventional blast furnace route with the direct reduction and smelting reduction route

The primary environmental benefit claimed for direct reduction (DR) and smelting reduction (SR) processes is that they can operate without coke or sinter. This prospect might prevent the necessity for coking plants and sinter machines that potentially have a significant environmental impact.

Emissions from reduction plants are generally low, with particulate releases to air after abatement of the order of 10 mg/Nm^3 . Abatement tends to be based on wet technology leading to an aqueous waste stream, although this may be capable of being addressed by recycling the water or by dry cleaning. If DR or SR processes use iron pellets or sinter, then the emissions associated with the processing of these materials must be considered when comparing environmental performances of the various ironmaking routes.

In Table 10.6 a comparison of the conventional blast furnace route with the DR and SR route for ironmaking is given.

Table 10.6: Comparison of the conventional blast furnace route with the direct reduction and smelting routes for ironmaking

Features	Traditional BF Route (1)	Direct Reduction (DR)	Smelting Reduction (SR)
Scale of production	Long established and energy and resource efficient with unit plant throughputs of hot metal of 2 to 4.77 Mt/yr and greater. Still the principle route for ironmaking, accounting for 95 % of world iron ore based production	Gas-based processes account for the vast majority of installed DR capacity worldwide, with 63 % of that capacity being via the MIDREX route. Such processes currently have a maximum unit plant capacity of 1.76 Mt/yr. DRI as produced is normally used as a replacement for scrap in the EAF steelmaking route. DRI processes have relatively low throughputs compared to the blast furnace and have generally been installed to take advantage of local factors such as very low cost energy and/or iron ore feed.	SR is less diffused. Only the Corex/Finex process is commercialised. Currently, the installed operating capacity is about 7.45 Mt/yr (8 sites)
Feedstocks	<p>Coal</p> <ul style="list-style-type: none"> • Coking coals required for coke making • Coke breeze & anthracite required (where used) for sinter plants • Coal for BF injection (can be non-coking coal specification) <p>BF Injectants Besides coal, oil (inc. waste oil), natural gas and plastics are injected into BF</p> <p>Metallics A wide range of feedstock of variable quality and specification can be used</p>	<p>Coal (where used-minority of processes).</p> <ul style="list-style-type: none"> • A wide range of solid fuels from anthracite to lignite including charcoal (rotary kilns) <p>Gas</p> <ul style="list-style-type: none"> • Sulphur content of gas must be low to avoid poisoning of the reformer catalyst and effecting product quality. <p>Metallics</p> <ul style="list-style-type: none"> • As no physical change of state takes place in the process, high-quality pellets and lump ore are required 	<p>Coal</p> <ul style="list-style-type: none"> • Non-coking coals, specification requirements more flexible than for BF route <p>Metallics</p> <ul style="list-style-type: none"> • Lump and fine ore, sinter or pellets <p>Oxygen</p> <ul style="list-style-type: none"> • Large quantities of oxygen are required for the Corex process (with associated energy implications)
Energy requirements	Typically around 17 – 18 GJ/t of liquid iron (less gas, steam and heating credits from carbon in iron)	Typically 10.5 – 14.5 GJ/t solid DRI (gas-based) assuming 100 % lump ore operation (extra energy required for melting and pellets, if used)	Difficult to quantify as process efficiency is dependent on the credit given for exported power or production of more DRI by gas-based DR processes
Product quality	Stable and of dependable quality	Product prone to reoxidation unless passivated or briquetted. Quality highly dependent on feed quality	Identical to BF iron

Features	Traditional BF Route (1)	Direct Reduction (DR)	Smelting Reduction (SR)
Environmental performance	<p>Releases to the environment include dusts, VOC, PAH and a variety of organic chemicals from the coke ovens. Sinter plants release SO₂, NO_x, dust, VOC, PCB, PCDD/F and PAH (see Table 4.1) while BFs discharge dust and SO₂ from cast houses (see Table 6.4 to Table 6.6). The process route also uses large quantities of water. However, the route provides for the recycling of various solid wastes/by-products which would not be available in many DRI processes. The desulphurising capability of the blast furnace also allows for higher sulphur-containing fuels and reductants to be used in an environmentally friendly manner. BF slag can be used for road construction or pelletised to make slag cement. Both by-products have the environmental advantage that they reduce the demand for primary aggregates.</p> <p>It is important to remember that the traditional ironmaking route provides for many recycling and disposal opportunities for ferruginous arisings, filter cakes and oils from downstream steel production that may not be available in many reduction processes. The traditional route also has the ability to use a wide range of feedstocks and reductants of varying quality.</p>	<p>As most DR processes make use of iron pellets, the environmental impact of releases from the pelletisation process should be taken into account.</p> <p>The DRI product typically contains 2 – 4 % gangue requiring further energy for processing and additional environmental releases to be considered. Dust releases are similar to the BF route as raw material fines are screened before processing. There is a need to provide an environmentally satisfactory route for utilisation of fines if DR is to replace traditional ironmaking. NO_x is released at the gas reforming stage. The most successful DR processes use natural gas although coal remains the largest energy source available to man. In terms of sustainable development, it may be considered that gas should be reserved for the production of high value products.</p> <p>Dispensing with coking plants prevents emissions to air of dust and VOCs from the ovens and a variety of organic chemicals to air and water from by-products plants. Emissions from refiners processing the residual coke making oils and tars from the coke ovens will also be eliminated. In addition, the large quantities of water used in the process will be saved. Removing sinter plants reduces releases to atmosphere of metallic/non-metallic dust and gaseous pollutants such as sulphur dioxide. The majority of blast furnaces now have cast house fume arrestment and bell-less charging systems installed and their environmental performance will therefore be comparable to releases from reduction plants with equivalent systems</p>	<p>In some SR processes, large quantities of waste gas are required to be utilised.</p> <p>In addition, the SR energy requirements and CO₂ emissions are higher than at the BF route. There is a need to provide an environmentally satisfactory route for utilisation of fines if SR is to replace traditional ironmaking</p>

Features	Traditional BF Route ⁽¹⁾	Direct Reduction (DR)	Smelting Reduction (SR)
Cross-media effects		As DR produces no physical change of state or separation of chemical impurities, product quality is wholly dependent on the quality of feedstocks. The DRI produced may not be of equivalent quality to that of iron from blast furnaces if low quality feedstocks are used. For environmental accounting purposes, DRI needs to be in molten form to be directly comparable to blast furnace iron. The additional energy requirements and emissions connected with this physical change of state need to be considered	Considering smelting reduction processes, large volumes of top gases are produced by Corex and energy efficiency will be poor unless the gases are utilised for power generation or used to produce more sponge iron. Coal consumption and oxygen requirements are higher than the BF route and carbon dioxide emissions are significantly greater. Oxides of nitrogen from gas reforming should be taken into consideration in both SR and DR operations
Installation costs (indicative)	EUR 1150 million for 3.5 Mt/yr (including cost of sinter plant and coke ovens)	EUR 210 million for 1.36 Mt/yr (assuming availability of suitable pellets or lump ore)	EUR 240 million for 0.60 Mt/yr (including the cost for the oxygen plant and assuming lump ore operation)
⁽¹⁾ Coke oven, sinter plant and blast furnace. Source: [200, Commission 2001] [260, Germany 2007] [312, Dr. Michael Degner et al. 2008].			

11 EMERGING TECHNIQUES

The term ‘emerging technique’ is understood in this document as an innovative technique that has not yet been applied in any industrial sector on a commercial basis. This chapter contains those techniques that may appear in the near future and that may be applicable to the iron and steel production sector. For example, this chapter:

- identifies any novel pollution prevention and control techniques that are reported to be under development and may provide future economic or environmental benefits
- includes techniques to address environmental issues that have only recently gained interest in relation to the sector at hand
- does not include established techniques in other sectors that may be emerging in practice within this sector.

Applied to this particular sector, the European Union has had (for more than 50 years) and continues to have a strong R&D programme to develop the steel sector. Some of the projects in this chapter have been financed by these programmes.

11.1 General emerging techniques

11.1.1 Carbon dioxide mitigation strategies (ULCOS project)

[378, Eurofer 2007], [250, EC 2006]

Specifically, because the CO₂ which is generated when energy is consumed is a greenhouse gas (GHG), energy saving has undergone a major change in purpose, and is now considered part of the solution to the problem of global warming, which is a global scale environmental issue.

As mentioned in the IPCC report, there is no unique option for mitigating climate change. The solution is rather a portfolio of mitigating actions for the stabilisation of atmospheric greenhouse gas concentrations.

Indeed, progress in the past has been great and simply extrapolating current technologies leaves little leeway for drastic new reductions in emissions.

To overcome this true difficulty, one should examine breakthrough technologies, which have received little attention in the past, because they did not belong to the economic technological episteme of the time. When considering changes, the goal should be to reduce GHG emissions and not simply to save energy; when most energy savings have been collected, as is the case in the most advanced steel companies, carbon and energy have to be decoupled to continue mitigating emissions.

ULCOS stands for ultra-low carbon dioxide (CO₂) steelmaking. It is a consortium of 48 European companies and organisations from 15 European countries that have launched a co-operative R&D initiative to enable a drastic reduction in carbon dioxide (CO₂) emissions from steel production. The consortium consists of all major EU steel companies, energy and engineering partners, research institutes and universities and is supported by the European Commission. The aim of the ULCOS project is to reduce carbon dioxide (CO₂) emissions with the most advanced techniques by at least 50 percent. The total budget of the project is EUR 47 million (2004 – 2009). The project is targeted to run beyond 2015 with some full size implementation in industrial production lines.

There are three areas to be explored under this rationale:

- capturing and sequestering CO₂ with optional transportation and storage
- use of energy and reducing agents not based on carbon, which means hydrogen and electricity and to a lesser extent natural gas
- use of sustainable biomass as grown in eucalyptus plantations, for example.

All of these issues are being extensively explored in the European ULCOS project and more generally in other programmes in the world.

11.1.1.1 Top gas recycling blast furnace

The concept of the top gas-recycling blast furnace (TGR-BF) is based on the separation of the off-gases so that the useful components can be recycled back into the furnace and used as a reducing agent. This would reduce the amount of coke needed in the furnace (see the concept of blast furnace with top gas recycling, under optimisation within the ULCOS project, in Figure 11.1). In addition, the concept of injecting oxygen (O₂) into the furnace instead of preheated air, is based on the removal of unwanted nitrogen (N₂) from the gas, facilitating carbon dioxide (CO₂) capture and storage (CCS, see Section 10.1.2).

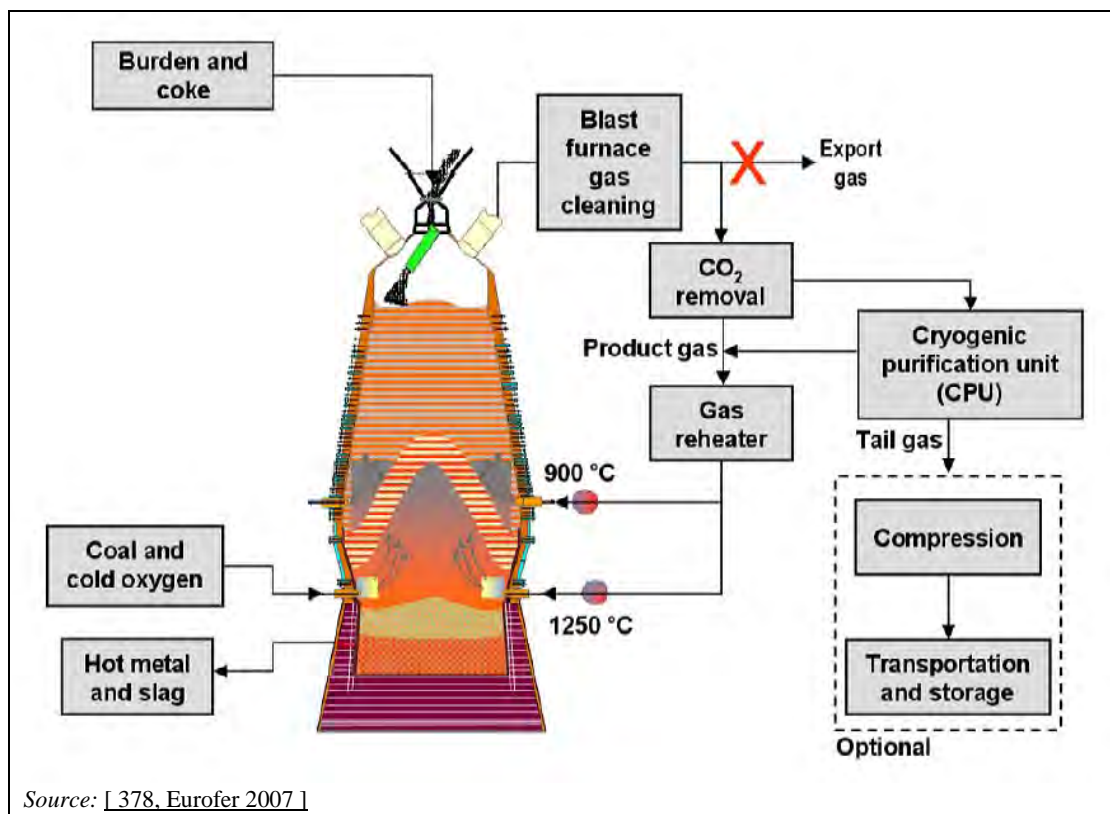

Figure 11.1: Schematic of the top gas recycling blast furnace to minimise GHG emissions with capture and the optional storage of CO₂

To experimentally test this concept, a gas separation plant was constructed next to the experimental blast furnace at the MEFOS research institute in Sweden. On the experimental blast furnace, equipment was installed to operate with pure oxygen (O₂) and with the reinjection of carbon monoxide (CO) gas. The combination of the modified blast furnace and the gas separation plant was successfully tested in 2007.

Even without CCS, the TGR-BF concept leads to a substantial mitigation of CO₂ emissions, mostly related to the lowered coke consumption (approximately 25 % lowered per tonne of hot metal). As the top gas recycling reduces the surplus of top gas that is available for energy production, and thus this amount of energy must be produced from other sources, the total CO₂ savings is lower than 25 %, but it is still in the range of 10 % – 20 % (depending on the fuel mix used).

At the time of writing (2010) plans are being developed to test this technique on a commercial scale blast furnace. This will take place in the next phase of the ULCOS project requiring an initial R&D investment of several hundred million euros.

In a second stage, the captured CO₂ will be compressed and transported for storage in geological formations such as oil and gas fields, unminable coal beds and deep saline formations (CO₂-sequestration), in mineral carbonates, or for use in industrial processes.

11.1.1.2 Carbon-lean fuels and reducing agents

Replacing carbon with hydrogen or electricity is a challenge of a greater scale, as both hydrogen and electricity are energy carriers that need to be produced from other fuels.

Until today, this is the reason why electricity has been more expensive than coal, gas or oil. This is also why little work has been carried out on a subject like the production of iron by electrolysis of iron ore in mainstream steel R&D.

The picture may change completely in the future. Indeed, the carbon constraint brought about by Kyoto and post-Kyoto policies would change the price structure of fuels. For example, carbon will have an extra price tag due to the need for capturing and sequestering CO₂. As a consequence, for every kWh produced by generating 1000 g/kWh EUR 20 to 80 would be added to the cost of one MWh, which should be seen in respect to the price of industrial electricity today, which varies between EUR 5 and 80/MWh throughout the world. Non-carbon-based electricity would not have to carry this extra burden and would thus, *mutatis mutandis*, replace the direct utilisation of carbon. This would probably change the price structure of energy in a drastic way. Similar orders of magnitude calculations would show that the steel industry could use large amounts of hydrogen, if it were available in large quantities at the right price, on par with what the transportation industry would use if it were to change over to fuel cell cars.

Under such novel economic conditions, hydrogen prereduction of iron ore would become a reasonable proposition, especially since the change from natural gas to hydrogen is a rather simple one from a process engineering point of view. Similarly, electrolysis of iron ore is a distinct possibility from the standpoint of physics. It has even been argued that it would be an 'easier' technology, from a thermodynamic standpoint, than the electrolysis of alumina.

Electrolysis of iron ore would conservatively call for 4.5 MWh/t of iron or 16.2 GJ/t, a figure that is of the same order of magnitude as the energy intensity of a modern, hot phase steel mill today. To produce 1 million tonnes per year, 0.514 GW of electrical power would be necessary so that a production equivalent to an integrated mill (4 Mt/yr) would probably call for a dedicated power plant. If a standard coal-fired power plant (1000 g of CO₂ per kWh) were used, this would generate 4.5 t of CO₂ per tonne of steel, about 3 times the figure of the baseline blast furnace of today, or the ratio of efficiency between a power plant and a blast furnace. However, if electricity were CO₂ free, it would only generate 27 kg CO₂ per tonne of steel. Since the technology of power plants will change in the post-Kyoto future, these figures, at least those related to coal-fired plants will decrease with the implementation of cogeneration and CCS concepts, such as the integrated gasification combined cycle technology. From a long-term perspective, electricity is potentially a powerful player, provided that low CO₂ intensity can be guaranteed and that prices stay commensurable with steel prices.

Electrolysis of water is a state-of-the-art technology where the electrolysis is carried out in the liquid state. Units typically produce 200 Nm³/h of hydrogen, and, therefore, 600 such units would be needed to feed a 1 Mt/yr DRI plant (at the level of 1050 Nm³ of H₂/t of DRI). The electricity requirement would be 4.85 MWh/t steel (including melting in an EAF) and 4800 GWh/yr for 1 Mt of steel.

11.1.1.3 Biomass

Finally, sustainable biomass needs to also be seriously considered as an alternative for CO₂ mitigation. This would be an interesting historical twist, as steel was produced for millennia from biomass but this was not sustainable after the onset of industrialisation and coal became a formidable competitor to wood and charcoal. Sustainable forestry has, however, become a reality today, attested by international certification bodies, such as the Forest Stewardship Council (FSC). Moreover, forest biologists and ecologists have started to demonstrate that, under sustainable growing conditions, carbon plantations can indeed be neutral to the accumulation of GHG in the atmosphere.

Last but not least, inventories of land that could be made available for growing energy crops seem to show that there are distinct possibilities of setting up more plantations that could have a clear contribution to the production of steel in the world. The matter needs very careful attention and is clearly not settled, but the necessary work will be carried out within the ULCOS project.

11.1.2 CO₂ capture and storage

Description

One option to reduce CO₂ emissions is Carbon Capture and Storage (CCS), which is regarded as a bridging technology with a certain potential to mitigate climate change for some decades. It is currently being developed for application in power production and in CO₂ intensive industrial plants such as e.g. iron and steel production.

CCS is a process chain consisting of three consecutive steps:

- a) capture: CO₂ separation from a flue gas or industrial gas stream
- b) transport: the separated CO₂ is compressed to the liquid or supercritical state and transported to a storage site
- c) storage (sequestration) in geological formations.

Regarding step a) capture, several capture processes are still in the phase of research and development. Other processes have been applied for some decades, but currently there is no large scale reference plant that gives proof of their applicability. Up to now, chemical and physical absorption processes have been applied predominantly for CO₂ removal in natural gas production. Different to that, there are other species present in flue gases derived from oxidation processes, such as NO_x, SO_x, O₂, etc., which lead to technological problems such as high solvent consumption due to oxidative degradation. There is still a need to further develop capture processes, especially to reduce the significant energy demand of capture processes.

Regarding step b) transport: CO₂ transport takes place in the compressed (liquid or supercritical) state, e.g. in pipelines or, in single applications by ship. Lorry transport shall not be applied due to its high specific energy demand as well as because of safety considerations.

Regarding step c) storage (sequestration): supercritical CO₂ is stored in on-shore or off-shore geological formations, e.g. oil and gas fields, depleted coal mines or saline aquifers. Storage in the marine water column or on the seabed is prohibited by the OSPAR Convention. Directive 2009/31/EC also enables injection in still producing natural gas or oil fields (EHR, Enhanced Hydrocarbon Recovery), but in this case a significant amount of the injected CO₂ is being transported out of the geological storage site in the course of ongoing hydrocarbon production.

CCS in the Iron and Steel Industry

A possible solution for CO₂ capture in iron and steel making could be the use of oxygen instead of air for carbon gasification in the blast furnace process, PSA/VPSA technology to separate CO and CO₂ from the blast furnace off-gas and injection of the generated CO. This process is called top gas recycling blast furnace (TGR-BF) and is currently investigated by the European steel industry in the ULCOS project (see IEA report [180, N.N. 2008])

Achieved environmental benefits

The emissions of CO₂ decrease to a large extent when the separated CO₂ can be stored in on-shore or off-shore geological formations

Cross-media effects

CO₂ capture and storage significantly increases energy demands (especially for capture and compression), which normally increases CO₂ and air pollutants (e.g. NO_x) emissions. The amount of avoided or net captured CO₂ represents the difference between emissions with and emissions without implementing the technique.

CO₂ storage has been carried out for several decades predominantly in course of enhanced oil recovery (EOR) in the United States and on-shore and off-shore storage, e.g. in the Sleipner

gasfield in Norway. In these projects CO₂ and other species derived from natural gas/oil clean-up are reinjected in a gas/oil field, so that chemical interaction with the cap-rock is not expected. CO₂ derived from other processes could contain a wider range of species which have not been in contact with the cap-rock before. Possible interaction of these contaminants of the CO₂ stream with the cap rock should be subject to further investigation.

CO₂ storage in saline aquifers is a new and unknown application, and its long-term influence on ground water quality, etc. still should be investigated.

Quality requirements with regard to CO₂ purity and tolerable amounts of other species present in the CO₂ stream have been specified, e.g. by the DYNAMIS project [181, Vangkilde-Pedersen et al. 2007], their applicability in practice has yet to be proved.

Monitoring techniques for surveying storage site integrity and leakage/seepage of CO₂ from the storage site need to be upgraded in terms of accuracy and detection limits.

CO₂ transport is a major issue in terms of safety for human health and nature.

Operational data

According to international energy agency (IEA) and results from the experimental blast furnace trials, CO₂ capture and storage, when applied to the core process blast furnace, could amount to a reduction up to 75 % of the total emissions.

Capturing the remaining CO₂ emitted from non-core processes such as coke ovens, sinter plants, basic oxygen furnaces and rolling mills, could only be achieved at considerably higher costs.

Applicability

Based on the first trials with the experimental blast furnace CO₂ from blast furnaces could be removed by redesigning the blast furnace to use oxygen and removing the CO₂ with physical absorbents. Further trials for proving this technology and the applicability of this process for an upscaling to an operational blast furnace are necessary.

Economics

The IPCC gives a range of capture costs between USD 25 and 115 (2002)/t CO₂ net captured for the industrial sector. This wide range reflects on the one hand the variety of technologies used and on the other hand it reflects the missing experience with that technology. These published figures should therefore only be considered as a rough estimate and presenting one scenario among many other possible ones. Because of R&D efforts, those current costs could be reduced by at least 20 – 30 % over the next ten years. However many uncertainties remain for costs in an industrial sector such as iron and steel due to its lack of capture experience. Additional costs for capture are transportation costs (USD 1 – 8 (2002)/t CO₂ transported over 250 km) and geological storage costs (USD 0.5 – 29 (2002)/t CO₂).

Driving force for implementation

No data submitted.

Example plants

No data submitted.

Reference literature

[179, Metz et al. 2005] [180, N.N. 2008] [181, Vangkilde-Pedersen et al. 2007]

11.1.3 Ceramic filters for the abatement of both particles and nitrogen oxides from gas streams

Description

This dry flue-gas cleaning uses ceramic filters. They are designed to combine filtration and SCR reaction in one unit using a catalytic filter. These filters allow for the use of the high energy content of the gas as well as preventing the plugging of the catalyst (oxides of Ti, V and W). Furthermore, the combination of two units into one unit reduces processing costs as well as investment and maintenance costs.

Ceramic hot gas filter elements with a fine filtering outer membrane and a catalyst integrated into the support structure of the filter elements can be used to achieve an efficient particle removal as well as an efficient NO_x removal. The use of these filter elements enables the combination of a filter and an SCR reactor into one unit. Moreover, the function of the integrated catalytic layer can be tailored in such a way as to allow not only catalytic NO_x removal but also the catalytic oxidation of volatile organic compounds (VOC).

The pollutants SO₂ and HCl are removed by using, for example, sodium bicarbonate (NaHCO₃) or calcium hydroxide (Ca(OH)₂) as sorbents, whereas NO_x is catalytically converted with NH₃ and O₂ to N₂ and H₂O by passing through the catalytic filter elements.

Achieved environmental benefits

Preliminary results reduced NO content by 83 – 98 % (NO inlet at levels of 500 – 1720 ppmv and temperatures between 140 – 360 °C). By injecting sodium bicarbonate, the removal of SO_x can be up to 99 %. Filtration efficiencies are typically higher than 99.99 %

Cross-media effects

N₂O formation was not detected.

Operational data

This system has a simpler plant set-up compared to a wet cleaning process and tends to be smaller. This system can work at high temperatures (up to 500 °C).

Applicability

Especially applicable for small and medium scale plants.

Economics

The capital investment, maintenance and running costs are lower than for a conventional multi-step wet flue-gas cleaning system. Moreover, the dry cleaning system prevents waste water generation in the gas cleaning process.

Driving force for implementation

No data submitted.

Example plants

The technique has been tested in Spain at a biomass power plant of 3.5 MW_{th}.

Reference literature

[377, Heidenreich et al. 2007] [381, Pall 2006]

11.1.4 Burning and recycling of dry waste dust

Description

This technique aims at treating dry dusts from integrated steelworks, e.g. BOF and BF dusts pyrometallurgically in a special reactor. By doing so, volatile and hazardous metals and compounds can be eliminated and an iron-rich fraction can be produced.

In this case, the reactor is of circular oval shape with 4.5 m length, 2.8 m width and 3.1 m height. The dusts are carried into the reactor by nitrogen. Upon entering the reactor, the carbon in the dust (up to 30 %) and additional propane are used as fuels for the oxy-fuel burner which creates an adiabatic flame temperature of 2200 – 2350 °C. At this temperature, the dust gets melted and forms slag droplets of liquid slag which are tapped every 2 – 3 hours. This iron oxide slag amounts for approximately 80 % of the input which can be recycled back to the BF process to utilise the iron value. The off-gas is led into an afterburner in order to further oxidise the metals and organics. The dust is separated in cassette filter and amounts for approximately 20 % of the input.

The main parts of the equipment are:

- the transport system for the dusts
- the stock station for the dusts
- the weighing device for the dusts
- the pneumatic transporting system for the dusts to the reactor
- the reactor equipped with an oxy-fuel burner and with a tapping hole
- the post-combustion and cooling system for the exhaust gas
- the cassette filter
- an additional device for instrumentation and for process control.

The capacity of the pilot plant is 20 000 tonnes of handled dusts as a maximum. In the case of Ovako Koverhar, the main dusts are BF dust and BOF dust. The total yearly dust amount is 20 000 tonnes, which corresponds to the maximum capacity of the plant.

The product coming out of the reactor consists of approximately 50 % Fe in the form FeO/Fe₃O₄. The zinc content is typically 0.1 – 0.2 % and the K₂O content is 0.5 – 1.0 %. The product is suitable for recycling in the blast furnace.

The amount of cassette filter dust is 15 – 20 % of the dust input. The zinc content in this dust is approximately 10 % and the alkali (K₂O+Na₂O) content is 20 – 30 %. An external company handles this dust.

Achieved environmental benefits

The BF dust is classified as problematic dust. BOF dust is a serious environmental hazard, but it is possible to put it into the corresponding stocking yard.

After scale up, the whole of the dusts of the integrated steelwork can be treated in this plant. The amount of dusts to be landfilled is reduced by approximately 80 %. By the pyrometallurgical treatment and by afterburning, the dusts to be landfilled can be regarded as less hazardous.

The emissions after the cassette filter are less than 5 mg/Nm³.

The energy efficiency of the process is high, because the need for external energy is minimal. (C-content in the BF dust is 20 – 30 %).

Cross-media effects

No data submitted.

Operational data

The metallurgy of the process is working well in principle, but the equipment needs some further developmental work.

Applicability

The applicability of the process for the handling of dry dusts is expected to be good. The main purpose for developing this technique was to treat BF and BOF dusts from steelworks, but it can

be assumed that it is suitable for the treatment of a wide range of metallurgical production residues.

Economics

The handling of the dusts by an external company is more expensive compared to handling the dusts on-site, especially when the whole capacity of the plant is in use.

Driving forces for implementation

The driving forces for implementation include:

- a significant improvement in environmental performance
- savings in the total costs
- potential for engineering activities.

Example plants

Ovako, Koverhar, Finland.

Reference literature

[208, Lindfors et al. 2006]

11.2 Emerging techniques for sinter plants

11.2.1 Use of carbon impregnated plastics for PCDD/F adsorption

Description

Plastics are widely used in the construction of flue-gas cleaning equipment due to their excellent corrosion resistance. PCDD/F are adsorbed on to plastics (polymers which contain carbon particulates) and they are typically implemented after other waste treatments (e.g. wet scrubbers).

Achieved environmental benefits

For the waste incineration sector, the following results are reported: with inlet concentrations of 6 – 10 ng I-TEQ/Nm³ gas phase removal efficiencies in the range of 60 – 75 % are reported across a wet scrubber. This compares with 0 – 4 % without the impregnated packing material. Absorption efficiency is reported not to have declined over the test period (one year). Using a dry system instead of a wet scrubber, the removal efficiency is higher (over 97 % in one test of nine months of operation) since the water film in a wet scrubber poses a mass transfer limitation for the PCDD/F.

Cross-media effects

The adsorption material becomes saturated after a certain period of time. Therefore the charged material can periodically be removed for disposal or, if permitted, be burned in the furnace.

Operational data

No data submitted.

Applicability

The use of carbon-impregnated plastics is applied in the waste incineration sector but not yet applied in the iron and steel sector. The technique can also be used in a more extensive tower packing installation and/or in combination with subsequent upstream or downstream dioxin flue-gas treatment. Working temperatures are between 60 – 80 °C.

Economics

No data submitted.

Driving force for implementation

The driving force for the implementation of this technique is the abatement of PCDD/F emissions to meet permit requirements.

Example plants

No data submitted.

Reference literature

[239, Setterstig 2006] [285, EC 2006]

11.2.2 Suppression of PCDD/F formation by addition of nitrogen compounds to the flue-gas

Description

Assuming that a considerable part of the PCDD/F are formed by de novo synthesis in the windboxes downstream of the sinter strand, nitrogen compounds such as triethanolamine (TEA) or monoethanolamine (MEA) are countercurrent injected to the flue-gas in the windboxes to inhibit the formation of PCDD/F. The amines can be dissolved in water and sprayed by nozzles placed in the windboxes.

Achieved environmental benefits

The injection of MEA into the sintering fumes at ArcelorMittal, Ghent, Belgium (2 – 4 % of the flying dust) has not reduced the pollutant emissions: the dust and micropollutant emissions actually increased, due to a combination of several factors:

- MEA accumulation due to ESP dust recycling into the sinter mix, resulting in active coal saturation
- the formation of ammonium salts
- sticky dust (less favourable conditions for ESP dust removal during rapping of the collection plates)
- low reactivity of MEA towards micropollutants at around 150 °C.

As far as the researchers know (based on their own long experience and on a review of the available literature), there is not any credible proof of any beneficial effect of MEA on emissions from the sinter plant. The positive results obtained with MEA by Centre de Recherches Metallurgiques (CRM) at ArcelorMittal, Ghent, Belgium during the period between 1999 and 2001 were only preliminary results obtained over very short periods of time (spot tests) which have never been confirmed on a full scale for a longer period. The laboratory tests carried out at the University of Liège by Xhrouet C. do effectively show that one can expect some PCDD/F reduction when subjecting dust which contains PCDD/F to high temperatures (325 – 400 °C) for several hours, but it is difficult to know if such an approach could be applied to the sinter plant.

Cross-media effects

During the trials, most of the MEA was adsorbed on flue dust, abated together with the dust by the ESP and finally recycled into the sinter mix. For this reason, it is possible to assume that the same thing would have happened had MEA been added directly to the sinter mix.

Operational data

To achieve the aforementioned inhibition rates for a sinter plant with a production of 230 tonnes of sinter per hour, 46 kg MEA/h are needed. This equates to 0.2 kg/t of graded sinter.

Applicability

The technique can be applied to existing plants and could be equally incorporated into the designs of a new plant.

Economics

An estimation was made that for a full application of the MEA inhibition process to a sinter plant with 230 tonnes of sinter per hour, the costs for the reagents would be EUR 0.149/t sinter and the investment costs would be about EUR 0.008/t sinter which equates to a total cost of EUR 0.157/t sinter.

Driving force for implementation

The driving force for the implementation of this technique is the reduction of dioxin emissions.

Example plants

Tests using MEA and TEA diluted in water were carried out from 1999 – 2001 in ArcelorMittal, Ghent, Belgium.

Reference literature

[224, Xhrouet 2002] [230, Brouhon et al. 2001] [231, Xhrouet et al. 2002]

11.2.3 Quenching

Another method to suppress PCDD/F formation in the windboxes may be rapid quenching of the hot off-gas by injecting cold water mist into the windboxes. The injection should again take

place as close as possible to the bottom of the sinter bed in order to suppress the PCDD/F formation ($T < 260$ °C) [265, Tan et al. 2004].

11.3 Emerging techniques for coke ovens

11.3.1 Super coke oven

[253, ICSTI' 06 2006] [320, Eurofer 2007] [343, Eurofer 2007]

An example of a super coke oven is the project SCOPE 21 in Japan from which a description of a pilot unit in Nagoya is given here. SCOPE 21 stands for super coke oven for productivity and environment enhancement toward the 21st century.

A national Japanese project was launched by the Japan iron and steel federation (JISF) in the nineties to develop a next-generation coke oven. The aim of this project was to develop an innovative coke production process that features environmental friendliness, energy efficiency, and high productivity.

SCOPE 21 was finished in 2003. Studies were supported by all of the major Japanese steelmakers (NSC, KSC, NKK, Sumitomo Metals, etc.) in cooperation with the universities. At the moment, several activities are under way with a view toward applying this process with actual equipment.

An industrial SCOPE 21 coke oven battery was built and commissioned in 2008 in Oita works for Nippon Steel Corporation, Japan. The plant has a capacity of 1 million tonnes coke per year. Coal blend is preheated to 250 °C, flue temperature is 1270 °C and coking time 13 hours.

Description

The idea of the project SCOPE 21 is to combine and associate well known coke plant techniques such as:

- preheating of the coal blend to 350 – 400 °C in a fluidised bed with the possibility of partial briquetting
- transporting and charging the blend by gravity without emissions by means of feeders
- carbonising the charge in a classical oven built with super-dense silica bricks showing a very high thermal conductivity and equipped with tightly sealed doors. The total coking time is between 6 – 8 hours and the final temperature of the coke is 850 °C
- discharging the coke in a dry quenching facility where the temperature of the coke is first increased to 1000 °C in the prechamber, then dry cooled for transportation.

All material movements are executed in a closed transport system. The dimensions of the pilot oven are at half the industrial scale (height: 7.5 m; length: 8 m; width: 450 mm). Figure 11.2 gives the flow sheet of the process.

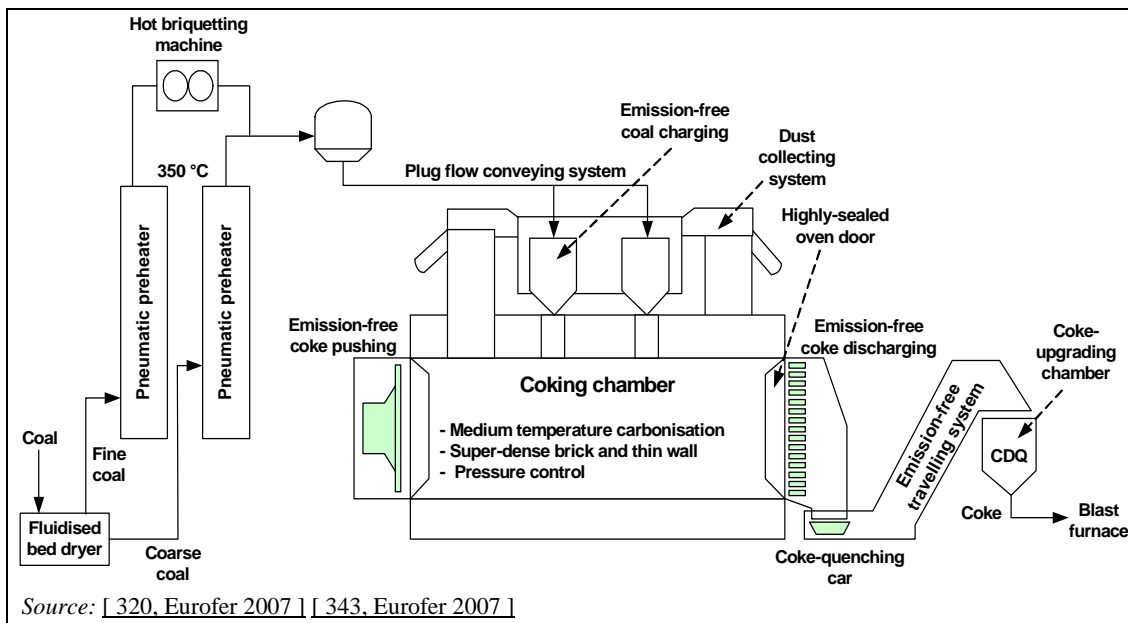

Figure 11.2: Process flow of a SCOPE 21 super coke oven

Results

Studies on the economic optimisation of the overall system have found that a SCOPE 21 coking plant could lead to the following reported advantages:

- higher productivity, increased by 2.4 times compared to a conventional coke oven
- better coke quality
- increase in the rate of non-caking or slightly caking coal to 50 %
- savings of 20 % in the energy consumed in the coke-making process
- reduction in NO_x emissions by 30 %
- prevention of smoke and dust.

11.3.2 Single oven pressure control technique

At the time of writing (2010), in conventional coke plants, the distillation gas flow from a single oven to the collecting main is controlled by an on/off valve or by a variable pressure regulation technique called PROven (see Section. 5.3.10).

This single oven pressure control (SOPRECO[®]) technique described in this section is based on a modification of this valve, optimised by experience and CFD simulations.

The system is based on a special valve driven by a hydraulic or pneumatic actuator and controlled by the pressure in the ascension pipe. The valve is properly shaped to operate in the full range of flow rate conditions over the whole coking cycle.

A continuous control of the oven pressure during the distillation time can prevent overpressure during the first phase of the process, by maintaining a negative pressure in the collecting main; this permits a full reduction of the emissions from doors, charging holes, etc.

Moreover, a continuous oven pressure control prevents negative relative pressure at the oven bottom during the last phase of distillation when the coke gas flow rate is low. Due to the possible air infiltration with consequent coke combustion and material damage at the hearth level, it is necessary to prevent a pressure lower than atmospheric. Therefore, the advantages of a coke oven pressure control concerns both emission reduction (during the first part of distillation) and prevention of oven air infiltration (during the last part of distillation).

This system was originally designed to be installed in existing operating batteries without significant modifications, and without affecting the plant operation. In the case of failure, the system can be easily and immediately converted to the conventional operational mode. These are the main advantages compared with other existing systems. However, for new plants, a new valve design, suggested by CFD simulations, has been designed in order to obtain an even better pressure control.

Figure 11.3 shows the simple geometry of the SOPRECO valve to be installed in existing operating coke ovens.

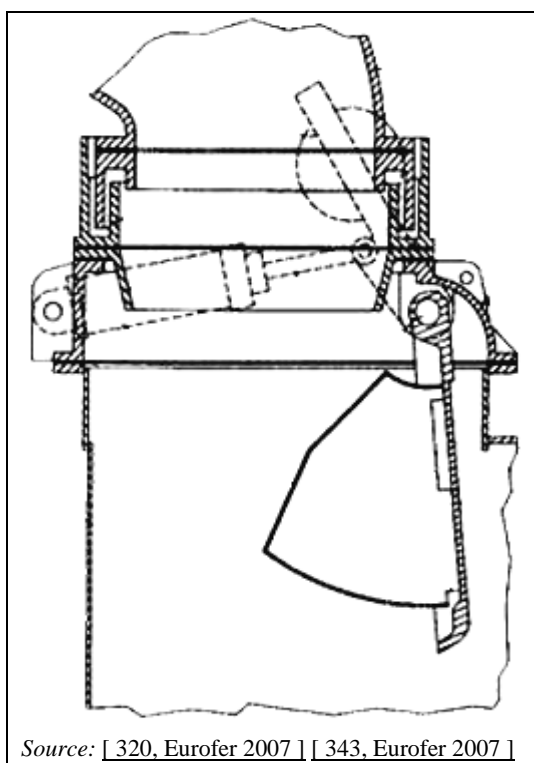

Figure 11.3: SOPRECO valve

In Figure 11.4, the general SOPRECO system scheme is shown.

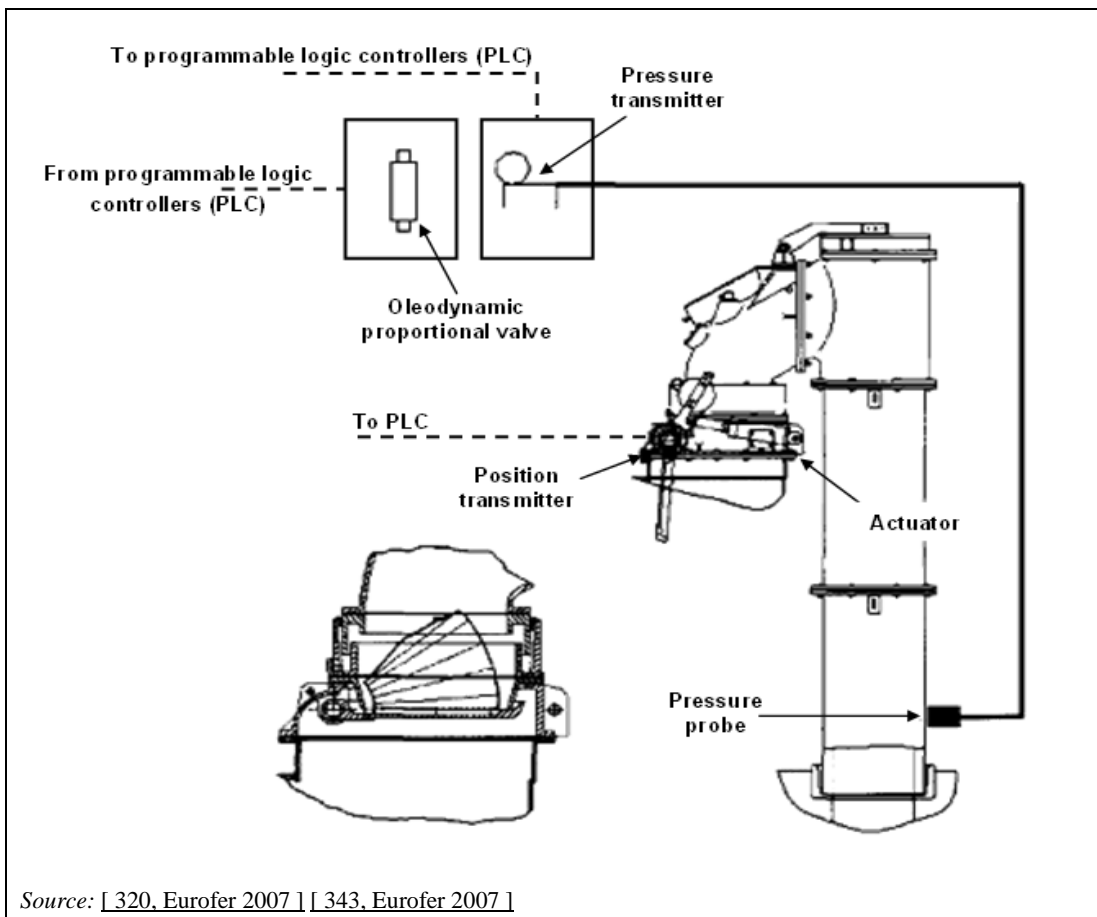

Figure 11.4: SOPRECO system scheme

The system has been tested in oven number 45 in the Lucchini, Piombino, Italy coke plant, showing full reliability and good operation. In March 2006, Sollac Méditerranée decided to install this system in the new coke oven battery at ArcelorMittal, Fos sur Mèr, France. This plant is now in the commissioning phase.

A second generation of the SOPRECO system named Model 2 has been developed to comply with higher demands from the battery side. This valve is added to the collecting main valve between the collecting main flap and elbow and an extension for the ascension pipe is made.

SOPRECO allows for controlling the oven pressure during different operating states like 'opening/closing' separately. It is reported that a very high accuracy in pressure regulation in the oven chamber can be achieved which is in particular needed in case of a stamped charged chamber. There the required suction is maintained by an pressure of 6 hPa (- 60 mm w.c.) in the collecting main, whereas the pressure in the chamber should be kept between 0 – 1 hPa (0 – 10 mm w.c.). In total a pressure difference of up to 7 hPa (70 mm w.c.) has to be regulated exactly which is executed by PLC individually for each valve.

The SOPRECO system can be applied to new and existing coke plants. Since the collecting main flaps remain, the SOPRECO system can be installed and taken into operation oven by oven.

The system has been tested successfully at three ovens of a stamped charged battery over a period of 6 months. The system has been installed at the new battery No 3 of ZKS Dillingen and went into operation in January 2010.

Figure 11.5 shows the 50 SOPRECO Model 2 valves installed on a stamped charged battery with a chamber height of 6.30. The start-up of this battery was January 2010.



Figure 11.5: SOPRECO Model 2 valves on a stamped charged battery

11.3.3 Alternatives in coke oven gas utilisation

[206, Diemer et al. 2004]

For some coke oven plants for different reasons, it is reasonable to deviate from the conventional utilisation of coke oven gas (COG). Alternative utilisation possibilities require different methods and processing steps of COG pretreatment. The options investigated for COG utilisation focus on hydrogen recovery, methanol synthesis, steam generation for electrical power generation and the use as a reducing agent in the blast furnace (BF) or direct reduction (DR) plant operation. These alternative potentials for the utilisation of COG are subject to an overall assessment giving consideration to the relevant steelworks infrastructure. The benefits from direct and indirect coke oven products are dependent on the specific local and operational works requirements.

For the energetic utilisation of COG, an alternative option to the classical heat recovery is to discharge the approximately 800 °C hot raw gas from the coke oven uncooled and lead it directly to a combustion or partial oxidation system. This technique has not reached industrial application because a promising technical solution for pressure control of the individual oven chambers under high temperature conditions does not yet exist.

Other options for alternative COG utilisation include:

- the injection of COG and tar as auxiliary reducing agents into the BF. This technique has already been put into practice
- Use of COG as a reducing agent for the production of direct reduced iron (DRI) or hot briquetted iron (HBI). For the DRI production, when utilising COG as a reducing agent, an additional production process is needed. In this case, the COG is partially cleaned.

11.4 Emerging techniques for blast furnaces

[233, Poos et al. 1993] [356, Eurofer 2007]

11.4.1 Reduction of CO emissions from hot stoves with an internal combustion chamber

Description

In Section 6.1.4, the two basic designs of hot stoves (with internal or with external combustion chambers) are described. In the case of internal combustion chambers, high emissions of CO occur as a result of leaks from cracks in the refractory mass. This leakage seems to be inevitable and leads to emissions of unburned gas. It is, however, possible to reduce leakage by inserting steel sheets of an appropriate grade into the refractory wall during relining.

Achieved environmental benefits

The impact of cracks (high CO emissions) can be significantly reduced. Results from measurement before and after inserting steel sheets are yet not available.

Status

This measure has already been introduced at one integrated steelworks in the EU-27.

11.4.2 Slag heat recovery

Description

Liquid slag from the blast furnace contains a large amount of sensible heat. Its temperature is approximately 1450 °C and around 250 – 300 kg/t hot metal is produced in modern blast furnaces. None of the commercially applied systems in the world utilise this potential energy source. This is mainly caused by the technical difficulties in developing a safe, reliable, and energy efficient system, which in addition does not influence the slag quality.

Achieved environmental benefits

The estimated energy savings are approximately 0.35 GJ/t hot metal.

Status

Tests were carried out at the end of 1990s. No commercial application is yet known.

Reference literature

[65, InfoMil 1997]

11.4.3 Injection of waste in blast furnaces

Investigations have been carried out for the use of oil-contaminated mill scale together with fly ash. Injection rates up to 100 kg/t hot metal were tested [238, Janke et al. 1997].

11.5 Emerging techniques for BOF and casting

11.5.1 Improvement of BOF slag stability for extended use

Description

The use of BOF slag in civil engineering is limited due to its content of free lime that influences the volume stability. Recently, a treatment process for liquid slag has been developed to overcome this problem. After tapping the slag into the slag pot, the liquid slag is treated by injection oxygen and sand (SiO_2). By doing this, the free lime is bound into stable phases and the resulting slag aggregates are volume stable. Furthermore the environmental behaviour of the slag can be improved.

Status

This processing step was developed in a research project finished in 1998. At the time of writing (2010) it is used in two European basic oxygen steelmaking plants. Realisation strongly depends on the market demand of civil engineering and the political conditions on the broader use of this by-product.

The process is much more difficult to control than expected; the viscosity can create problems for reactivity and homogeneity. The technical problems are solved globally. The predictability of batch suitability to be treated to obtain the desired quality has improved. The current trial steps are the process optimisation and the cost reduction. Example plants are ThyssenKrupp Steel Beeckerwerth, Duisburg, Germany and ArcelorMittal, Ghent, Belgium.

Main achievements

With stability improvement, the requirements of slag use in civil engineering can be fulfilled. In road construction, slag replaces natural resources and prevents emissions in the production process of the natural material. The saving by the use of slag can be twice the volume of slag because of better load bearing and thermal insulation properties. This is the base for better resource efficiency of the input raw material in steelmaking and a reduction in necessary landfill.

Reference literature

[363, Eurofer 2007]

11.5.2 Improving clean gas dust content in wet scrubber-based BOF plants by upgrading to Hydro Hybrid Filters

Description

Most BOF plants worldwide are equipped with a wet scrubber-based gas cleaning plant. These plants can usually achieve residual dust contents of between 30 and 50 mg/Nm^3 .

Upgrading the existing plant with a downstream installation of a small wet electrostatic precipitator (wet ESP) can further reduce the clean gas dust emissions. The combined system is a 'Hydro Hybrid Filter'.

The idea is that the cleaning of the BOF gas is no longer based only on the existing scrubber. The scrubber acts as a pre-dusting device to precipitate coarse dust and as a cooling and conditioning tower for the downstream ESP. The pressure loss of the wet scrubber can be reduced significantly and hence, power consumption of the fan can be reduced.

The downstream wet ESP is a small unit consisting of one or more fields only as the dust content of the gas is already significantly reduced by the scrubber. Furthermore, the gas volume decreases due to low temperature.

Already existing equipment such as the fan or water treatment devices, etc. can be further used with few or no modifications. Existing BOF gas recovery is not affected by this modification.

Status

The technique is under development.

Achieved environmental benefits

Hydro Hybrid Filter systems can achieve clean gas dust emissions of $\leq 10 \text{ mg/Nm}^3$. Additional energy consumption of the ESP will be overcompensated for by reduced energy consumption of the fan.

Cross-media effects

No data submitted.

Applicability

The technique is under development.

Installation is possible in all existing BOF plants with a wet scrubber gas cleaning plant. New plants would preferably be equipped with dry ESP techniques.

Economics

Due to the small size of the additional ESP and further use of existing equipment, investment costs are low.

Operating costs can be reduced due to a decreased differential pressure of the scrubber which consequently reduces electric power consumption of the fan.

Driving force for implementation

The relatively low investment for upgrading existing wet scrubber-based gas cleaning systems to meet local emission standards may lead to the implementation of the Hydro Hybrid Filter where a complete replacement of wet scrubbers is not feasible.

Example plants

The technique is currently under development.

Reference literature

Patent application [[192, Schlüter 2009](#)].

11.5.3 Whirl hood for secondary dedusting

Description

Dust emissions caused by tapping the converter or by charging scrap into the converter are difficult to capture because the converter is tilted out of its upright position and the fume escapes diffuse to the production hall. The production steps need some free space above the lids of the converter for the crane and the scrap basket. Therefore, the suction hood should have some distance to the dust source. To get a good capture ratio in the secondary dedusting system in spite of the construction conditions, there are different suction hood designs. A new development is the 'whirl hood' or 'hurricane hood'. There is an air roll produced in the hood by evacuating the air at both sides on the axes of the roll. These flow conditions move the particles in the axial area of the air roll by the pressure distribution in the roll and they are evacuated through the opening of the two opposite suction pipes to the dedusting system. It is important that the evacuation pressure in the roll suction hood be strong enough to ensure stability.

Status

The engineering of this type of suction hood was developed some years ago. There are some first experiences with charging in some steelworks and a new system will be built in the near future.

Achieved environmental benefits

If the system is well designed, it should be able to reach a better capture rate of fugitive sources which cannot be evacuated directly at the source itself. It is not possible to quantify this effect because the capture cannot be measured and must be estimated by judgement of visible dust emissions. There are no results in operation facilities to compare this design with because any change in the suction system is also accompanied by an improvement of the compliance of the whole suction system.

Reference literature

[363, Eurofer 2007]

11.5.4 Recycling of BOF and EAF ladle slags as a flux agent in electric steelmaking

Description

Several techniques have been tested to recycle BOF and EAF ladle slags:

- a) recycling of liquid ladle slag into the EAF. A recycling rate of 80 % has been achieved
- b) recycling of solid ladle slag into the EAF. Around 15 % of lime has been substituted by ladle slag in with ratio of 1:2. About 50 % of the generated ladle slag can be recycled
- c) recycling of spent refractory materials from EAF, BOF and secondary metallurgy. Careful processing and quality controls are a prerequisite in recycling.

Achieved environmental benefits

For technique a) no processing of the slag is necessary.

For technique b) no processing of the slag is necessary.

For technique c) spent magnesite is a suitable substitute for olivine and of soft-burnt dolomite.

Cross-media effects

For technique a) some increases in the total energy consumption can be seen due to the additional opening of the furnace.

Operational data

For technique a) no detrimental impact has been observed on the quality of steel in the EAF.

For technique b) the handling of solid materials has the advantage that a selection of favoured slag composition is possible. Some minor effects with respect to metallurgy and steel quality are induced.

Applicability

For technique c) a recycling test has been carried out at a sinter plant, a blast furnace burden and a BOF converter.

Economics

For technique b) the operational costs are counterbalanced by savings in lime. Economic benefits are due to the reduced amount of dumped ladle slag.

Driving force for implementation

A step towards steelmaking without residues is the driving force for implementation.

Example plants

RIVA Acciaio, Verona Works, Italy; Krupp Edelstahlprofile (KEP), Siegen, Germany; EKO Stahl, Eisenhüttenstadt, Germany.

Reference literature

[386, Cores et al. 2005]

11.6 Emerging techniques for EAF

11.6.1 Contiarc furnace

Description

The Contiarc furnace is a direct current arc furnace with an annular shaft formed by an outer and inner vessel. The furnace operates continuously with raw material being charged into the top of the annular shaft. The submerged, continuous nature of the furnace makes it more energy-efficient than the cupola. In addition, it is now possible to both melt and smelt iron in the same furnace system producing 80 tonnes/hr while melting and smelting. The furnace can take low-grade scrap (automobile shreddings), direct reduced iron (DRI) and/or hot briquetted iron (HBI) and combine it with coal and silica rock to produce quality ductile base iron with 3.5 % carbon (C) and 2.5 % silicon (Si).

The furnace is charged automatically through a hopper system that feeds a conveyor to the top of the furnace. Once the charge reaches the top of the furnace, it is deposited into one of eight hoppers that are positioned in a rotating carousel around the top of the furnace. The computerised charging system works in unison with the computerised furnace control system to determine where within the annular shaft a charge is required.

By maintaining a full stack of charge material, the heat content of the furnace gases acts as a preheater for the charge material. Due to the volume of gas, stack permeability is not an issue; however, the charge material must be sized properly to prevent bridging in the stack.

The continuous arc melting concept is driven by the central cathode (graphite electrode) inside the inner vessel and the corresponding conductive bottom anode. In a traditional arc furnace, when a charge is added, the electrode rises to the top of the charge. In the continuous arc furnace, the inner vessel keeps the electrode submerged. The central graphite electrode is protected against damage from falling scrap by the inner vessel. Its tip operates at a distance below the bottom of this vessel so that the long direct current arc burns between the electrode and the molten metal bath. The shell is shielded from the radiation of the direct current arc by charge materials.

The completely encapsulated melter ensures a reducing atmosphere in the lower part of the furnace and a slightly oxidising condition in the shaft to achieve the desired process metallurgy and a utilisation of gases. In addition, this design results in low losses of oxidised iron or silicon. A bag house system captures emissions.

Main achievements

The Contiarc furnace is designed to perform both melting and smelting operations. This provides the following advantages:

- the ability to melt low-cost and abundant shredded scrap, borings, HBI and/or DRI (thus maintaining tramp element control)
- quartz (SiO₂), through gravel used in the construction industry, can be substituted for high-cost ferrosilicon as a means of developing the necessary silicon level in the melt
- coal can be used instead of coke during melting to carburise the base metal and reduce the quartz because the carbon product is not required for heat generation
- without the use of coke, the sulphur level of the molten metal is reduced
- there is less slag with the Contiarc than that associated with the cupola since it is a reduction furnace which means that many oxides that normally act as slag are reduced back into the metal
- during melting, the temperature control in the Contiarc furnace is flexible meaning it can be adjusted by a simple variation of the current/voltage ratio. This allows the iron to be superheated before tapping.

Example plants

In July 2001, the first continuous submerged direct current electric arc (Contiarc) furnace went into operation at ACIPCO, Birmingham, US.

11.6.2 Intermetallic bag filter to minimise emissions of dust, PCDD/F and heavy metals

Description

An intermetallic bag filter with high-temperature resistance combines filtering and catalytic operations and allows for a drastic decrease in dust and associated pollutant emissions.

Achieved environmental benefits

In pilot tests at LME Trith-Saint-Léger, France, a dust reduction efficiency of 99.9 %, a PCDD/F reduction efficiency of more than 95 % and a heavy metal reduction efficiency of 95 – 100 % (except for heavy metals present in the gas phase like mercury) were achieved. Moreover, energy can be saved as a consequence of moderate waste gas cooling. This technique should be operated at 350 – 550 °C, whereas traditional cleaning is operated at 150 – 200 °C.

Cross-media effects

No data submitted.

Operational data

No data submitted.

Applicability

No data submitted.

Economics

No data submitted.

Driving force for implementation

No data submitted.

Example plants

No data submitted.

Reference literature

[252, France 2007]

11.6.3 Recovery of old tyres in EAF

Description

As has been applied in cement plants, old tyres (which represented 2.2 Mt/yr in Europe in 1999) can be recovered and can replace coal (anthracite) in electric steelmaking. An optimised recovery process in EAF requires an adapted addition of tyres, charged at the right place, neither on top nor at the bath bottom, and oxygen lances should be operated in such a way as to prevent post-combustion anywhere else than in the arc furnace.

Achieved environmental benefits

This technique allows for both the recovery of old tyres and a decrease in the demand of coal mining.

Cross-media effects

Recovery of old tyres does not give extra emissions in terms of PCDD/F, heavy metals, PAH, SO₂, and VOC and does not demand extra energy.

Operational data

No data submitted.

Applicability

No data submitted.

Economics

No data submitted.

Driving force for implementation

No data submitted.

Example plants

In pilot tests at Ascometal Hagondange, SAM Neuves-Maisons and LME Trith-Saint-Léger, all three in France, a substitution rate of 1.7 kg old tyres for 1 kg anthracite was achieved. An addition of 5 – 12 kg old tyres/t LS is achievable if tyres are cut into small pieces at a length of no more than 10 – 15 cm. In 2006, LME Trith-Saint-Léger, France had a treatment capacity of 7000 tonnes old tyres/yr.

Also ArcelorMittal, Belval and Differdange, both in Luxembourg have carried out some trials.

Reference literature

[252, France 2007]

11.6.4 Recycling of (BOF and EAF) slags as a flux agent in electric steelmaking

For details of this technique, see Section 11.5.4.

12 CONCLUDING REMARKS AND RECOMMENDATIONS FOR FUTURE WORK

Timing of the review process

The kick-off meeting for the review of the Iron and Steel Production BAT reference document was held in September 2006. The TWG agreed to include a general chapter (Chapter 2) which comprises general information on the management of the environment, material, water, energy and on monitoring and noise. These issues can be considered horizontal for the activities within the iron and steel industry. Chapters 3 to 8 provide information on particular processes (sinter plants, pelletisation, coke ovens, blast furnaces, basic oxygen steelmaking and casting, electric arc steelmaking and casting).

The revision of the Iron and Steel Production BAT reference document did not entail a complete redrafting of the first document adopted by the Commission in December 2001 but entailed updating the existing BREF, including additional information which was reviewed (for instance regarding techniques) which could have an impact on the conclusions regarding BAT. The information exchange and data gathering was based on the wishes provided by the TWG.

The period for collecting information and data ended in June 2007. The guidance document on data collection agreed upon at the IEF meeting in April 2008 was not used for this process. The first formal draft of the revised Iron and Steel Production BAT reference document covering all sections but the BAT conclusions and the Concluding Remarks was issued in February 2008, with the consultation period for TWG members ending in May 2008. At that time, the work was taken over by a new author. After assessing the draft document, a substantial redraft of some chapters as well as an additional information collection period were deemed necessary. The data collection finished in February 2009. Based on the additional information, the second draft of the BREF including draft conclusions on BAT was issued in July 2009, with a 10-week consultation period for TWG members ending in September 2009.

The final TWG meeting was held in February 2010. At the time of the final plenary meeting, there were more than 70 TWG members.

Sources of information and information gaps

For the revised Iron and Steel Production BREF more than 200 documents and submissions from Member States, industry and environmental NGOs have been taken into consideration. The Commission's BAT information system (BATIS) served as a space where TWG members could upload documents and information to be shared amongst themselves thus achieving a high level of transparency. Relevant submissions have been included in the BREF references. Major contributors of information were EUROFER, the industry association representing the majority of European steel manufacturers and the following EU Member States: Austria, Belgium, the Czech Republic, Denmark, Finland, France, Germany, Italy, Luxembourg, the Netherlands, Poland, Sweden, the United Kingdom, as well as Norway. Furthermore, information was provided by Ökopol representing the environmental NGOs and by some suppliers from Germany, Italy and Switzerland. These documents can be considered the building blocks of the revised parts of this BREF document.

Additional useful information was obtained by visits of the EIPPCB to iron and steel plants in Austria, Finland, Germany, Luxembourg, the Netherlands, Spain and the United Kingdom. Based on the information and data provided and the comments received after the consultation periods, this BREF document was revised by updating information and data on the production figures, energy demand, costs and achieved emissions values. Furthermore, new sections were included, e.g. about monitoring, management tools, power plants in iron and steel works, the handling of materials, the prevention and monitoring of diffuse emissions, near net shape casting, the preheating of scrap, the recovery of iron-rich residues and the developments made concerning mitigation of CO₂ emissions. Additionally many sections have been substantially

restructured and redrafted, e.g. the abatement techniques for air emissions, the collection and abatement of secondary emissions to air, waste water treatment and the internal or external utilisation of residues and process gases.

Despite all of the very useful information and comments submitted, some data collection problems should be pointed out.

- A major part of the provided emissions data were reported as emission factors (i.e. g/t product) over several installations. These emissions factors were calculated based on measured emissions concentration values and specific off-gas flows, which were not provided as such. It would have been useful to have this valuable information for assessing the performance of certain techniques on a plant level and for determining the BAT-AELs.
- There were some uncertainties about which congeners of PCB and PAH were reported which made it difficult to compare the reported emissions values.

During the final TWG meeting, detailed discussion took place concerning bypass operations, process gas-fired power plants and degree of dust collection. These items are described below.

Bypass operations

During start-up or shutdown operations or other special operations which could affect the proper functioning of the system (e.g. extraordinary maintenance work and cleaning operations) or safety, emission reduction systems may have to be bypassed. Particular regard has to be given to the emissions during bypassing, in the sense that bypassing or partial bypassing operations should be minimised to achieve a high level of availability of the emission reduction system. Little information with respect to this issue is available, therefore in the future, bypass operations should be well documented. The TWG decided that from the available information about how to deal with these specific operating conditions, it was not possible to conclude on BAT concerning bypass operations.

Process gas-fired power plants in iron and steel works

The TWG considered the information submitted concerning emissions to air from process gas-fired power plants to be insufficient. From the given information in Sections 2.2.1.2 and 2.5.3, it was not possible to determine BAT-AELs for dust, SO₂, NO_x and CO. This issue should be dealt with during the review of the Large Combustion Plants BREF (LCP) [282, EC 2006] and be covered in a specific chapter of that BREF together with other relevant issues of process gas-fired power plants.

Degree of consensus reached during the information exchange

At the final TWG meeting in February 2010, a high level of consensus was achieved on the conclusions on BAT and only three split views were recorded. Table 12.1 shows the split views expressed by TWG members.

Table 12.1: Split views

BAT conclusion	View expressed by	Split view
No 20	Austria and one NGO	BAT for sinter plants should be to reduce dust emissions from the sinter strand waste gas by means of a bag filter only and the BAT-AEL for dust should be $<10 \text{ mg/Nm}^3$, determined as a daily mean value. Several installations in the EU have installed bag filters and achieve dust emission levels below 10 mg/Nm^3 on a daily average basis (see Section 3.3.2.2). There are no technical, economical or cross-media issues which limit the applicability of a bag filter. Based on the information given in Section 3.3.2.1, consistently low emission levels cannot be achieved with an ESP on a daily average basis, in particular when residues and dusts are recycled to the sinter strand.
No 25	Austria and one NGO	BAT should be to reduce PCDD/F and PCB by applying injection of adequate adsorption agents into the waste gas duct of the sinter strand before dedusting with a bag filter. Based on the information of this document, the BAT-AEL for PCDD/F should be $<0.05 - 0.2 \text{ ng I-TEQ/Nm}^3$ for a 6 – 8 hour random sample with steady-state conditions. Several installations in the EU have installed bag filters and achieve emission levels below $0.2 \text{ ng I-TEQ/Nm}^3$ (see Section 3.3.2.2). Furthermore there are no technical, economic or cross-media issues which limit the applicability of a bag filter in combination with the injection of adequate adsorption agents into the waste gas duct.
No 49	Germany and one NGO	A dust emission level of $<10 \text{ mg/Nm}^3$ should be considered BAT-AEL for coke oven under firing based on the information provided in Sections 5.2.2.1 and 5.3.12.1. The high number and the size of cracks in the oven walls of very old coking plants (up to >40 years) should not be used as a basis for the higher BAT-AEL.

Consultation of the Forum and subsequent formal adoption procedure of the BAT conclusions

The forum for the exchange of information pursuant to Article 13 of the Directive 2010/75/EU on industrial emissions (IED) (generally referred to as the IED Article 13 forum) was consulted on the proposed content of this BAT reference document on 24 June 2012 and provided its opinion during its meeting of 12-13 September 2011.

The opinion of the IED Article 13 forum distinguishes between two different sets of comments. Firstly, the opinion lists those comments on which the forum gave its consensus to include them in the final BAT reference document. Secondly, the opinion lists those comments representing the views of certain forum members but on which there was no consensus to include them in the final BAT reference document.

The full opinion is available here:

http://circa.europa.eu/Public/irc/env/ied/library?l=/ied_art_13_forum/opinions_article

Subsequently, the Commission has taken the opinion of the IED Article 13 forum into account when preparing the draft Commission Implementing Decision establishing the BAT conclusions for iron and steel production.

The Industrial Emissions Directive (IED) Article 75 Committee gave a positive opinion on the draft Implementing Decision during its meeting of 21 November 2011.

No substantive modifications were made to the document during this process.

Recommendations for future work

The information exchange for the revision of the Iron and Steel Production BREF presents an important step forward in achieving the integrated prevention and control of pollution for the iron and steel production processes. Further work on the issues described below could continue and further develop this process.

- In general, it would be useful to gather more concrete examples of the applied techniques and their performance.
- The collection of information, in particular emission data, was conducted prior to the establishment of Commission guidance on this issue (IEF document of June 2008 and guidance developed under the IED). Future data collection and submission will be improved by taking into account that guidance.
- More information should be collected regarding monitoring methods and monitoring frequencies, in particular for mercury and POPs (e.g. PCDD/F and dioxin-like PCB) in relation to sinter and EAF process.
- The information on water utilisation should be improved by clearly defining terms like water demand, water consumption, water intake and waste water and by standardizing their use. For waste water, additional information about emissions is needed and related sampling periods during monitoring should be expressed.
- Additional information should be gathered on the monitoring of emissions from relevant diffuse emissions sources, in particular for emissions from the transport and handling of dusty materials such as raw materials, some intermediate products and residues should be improved.
- Information gathering on the monitoring of emissions from raw material preparation processes like crushing, grinding, mixing, screening, e.g. drying and pulverisation of coal for the blast furnace should be improved.
- For volatile organic compounds (VOC), it should be more clearly indicated if methane is included or not
- For PAH, it should be more clearly indicated which congeners are included (e.g. Borneff PAH, PAH expressed as EPA 16, or just a section of EPA 16 or others).
- Concerning PCB, it should be more clearly indicated which congeners are included (e.g. Ballschmiter PCB, WHO (12) or a sum of certain PCB congeners or other).
- Emissions data from coke oven gas treatment plants should be collected, in particular for BTX and PAH.
- For sinter plants more information and data should be collected from secondary dedusting (blending, mixing, sinter room, sinter cooling).
- More cost data (e.g. investment, operational costs) should be collected regarding all measures/techniques.
- Information and data regarding options for minimising energy consumption and increasing energy efficiency should be collected.
- Information regarding continuous mercury emissions monitoring measures/techniques which can be applied in iron and steel plants should be collected.
- The development in near net shape casting should be followed.

Suggested topics for future R&D work

For sinter plants (see Section 3.2.2.1.2.7 and 3.2.2.1.2.8.), HCN, Benzene and PAH emissions have been reported to be relevant in some cases. Since the occurrence remains unclear, exploratory analysis and research is recommended. In this context, the impact of the use of anthracite should be clarified.

For coke ovens, the measurement of particulate emissions from quench towers should be based on an official sampling method. Another issue is to establish an agreed upon method for the measurement or estimation of diffuse/fugitive emissions, e.g. BTX and PAH from coking plant operations, including quench towers.

For BOFs, the monitoring and abatement of diffuse core process emissions from relevant sources, e.g. BOF secondary emissions, should be carried out.

In particular, regarding the techniques described in the Emerging Techniques Chapter (Section 10.1.1 concerning CO₂ mitigation strategies and Section 10.3.1 on super coke ovens), future R&D should be followed. Maybe these techniques can be considered in the future in the determination of BAT for the iron and steel industry.

The Commission is launching and supporting, through its RTD programmes, a series of projects dealing with clean technologies, emerging effluent treatment and recycling technologies and management strategies. Potentially, these projects could provide a useful contribution to future BREF reviews. Readers are therefore invited to inform the European IPPC Bureau of any research results which are relevant to the scope of this document (see also the fifth section of the Preface of this document).

All comments and suggestions should be made to the European IPPC Bureau at the Institute for Prospective Technological Studies at the following address:

European Commission
Institute for Prospective Technological Studies
European IPPC Bureau
Edificio Expo
c/ Inca Garcilaso, 3
E-41092 Seville, Spain
Telephone: +34 95 4488 284
Fax: +34 95 4488 426
E-mail: JRC-IPTS-EIPPCB@ec.europa.eu
Internet: <http://eippcb.jrc.ec.europa.eu>

REFERENCES

- [1] Arimitsu, 'Energy Saving in the Japanese Steel Industry', *European Symposium on Environmental Control in Steel Industry*, 1995, pp. 105-136.
- [2] Auth et al., 'Die Entwicklung des Thyssen-Heißbrikettier-Verfahrens und die betriebliche Anwendung (The Development of the Thyssen-Hot-Briquetting Process and its Practical Application)', *Dritte Duisburger Recycling-Tage*, 1988.
- [3] Remus, R., 'Minutes from the Expert meeting Emissions from storage and handling of bulk materials', *Expert meeting Emissions from storage and handling of bulk materials*, 1998, Umweltbundesamt, Berlin, Germany.
- [4] Beer et al., 'Auswirkungen unterschiedlicher Koksgruskoernungen bei der Eisenerzsinterung (Impacts of Different Coke Breeze Grain Size Distribution on the Sintering Process)', *Stahl und Eisen* 111, Vol. No. 8, 57-64, 1991.
- [5] Beer et al., 'Verfahrenstechnische und metallurgische Maßnahmen zur Verminderung des Energieeinsatzes in Sinteranlagen (Process-integrated and Metallurgical Measures to Reduce Energy Consumption of Sinter Plants)', *Stahl und Eisen*, Vol. No. 11, 25-37, 1991.
- [6] Volkhausen, W., 'Description of the Oxycup Process', Personal Communication, 2008.
- [7] Bothe, *Umweltproblematik bei der Eisenerzsinterung (Environmental Problems of the Iron Ores Sintering Process)*, 1993.
- [8] Endemann, G., 'Description of the DK-Process', Personal Communication, 2008.
- [9] Fisher et al., 'Investigation of the Formation of Dioxins in the Sintering Process', *2nd International Congress on the Science and Technology of Ironmaking Conjunction with the 57th Ironmaking Conference of Iron and Steel Society*, 1998, C-Toronto.
- [10] Kessler, K., 'Zero Waste Production bei der Stahlverwertung', *Metall*, Vol. Vol. 59 3, No 2005, 2005.
- [11] Campell et al., *Oxy-coal Injection at Cleveland Iron Works*, 1992, pp. 120-125.
- [12] VDEh, Technical Background Paper om Recycling of FE-containing Material, 2006.
- [13] Deckers et al., 'Development of Environmental Control Technologies', *European Symposium on Environmental Control in Steel Industry*, 1995, Praha.
- [14] Dietrich, *Reaktionskinetische Betrachtungen des Sintervorganges und Moeglichkeiten zur Leistungssteigerung (About the Reaction Kinetics of the Sintering Process and Possibilities for Productivity Increase)*, 1961.
- [15] Both, I. et al, *Technologies for the optimum recycling of steelmaking residues*, Stahl und Eisen, 2008.
- [16] Rentz, *Report on Best Available Techniques in the Electric Steelmaking Industry*, French-German Institute for Environmental Research, 1997.
- [17] Hillman, C. and Sassen, K.-J., 'Solutions for dusts and sludges from the BOF process', *Stahl und Eisen*, Vol. Vol 128 Nr. 5, 2006.
- [18] VDI/DIN, VDI 3790 part 1 Environmental meteorology - Emissions of gases, odours and dusts form diffuse sources - Fundamentals, 2005.
- [19] EC BOF, *Technical Note on the Best Available Techniques to Reduce Emissions of Pollutants into the Air from the Basic Oxygen Steel Making*, 1995.
- [20] VDI/DIN, VDI 4210 part 1 Remote sensing - Atmospheric measurements with LIDAR - Measuring gaseous air pollution with DAS LIDAR, 1999.
- [21] EC Coke, *Study on the Technical and Economical Aspects of Measures to Reduce (on the Basis of the Best Available Technologies) the Pollution (of Water and Other Environmental Areas) from the Industrial Emissions of Cokeries*, 1996.
- [22] EC EAF, *Technical Note on the Best Available Technologies to Reduce Emissions of Pollutants into the Air from Electric Arc Steel Production Plants*, 1994.

References

- [23] EC EAF, *Optimisation of Environment and Related Energy Utilisation in Scrap-based Steelmaking (Phase I)*, 1997.
- [24] EC Haskoning, *Techno-economic Study on the Reduction Measures, Based on Best Available Technologies, of Water Discharges and Waste Generation from the Primary and Secondary Iron & Steel Industry*, 1993.
- [25] VDI/DIN, VDI 4285 part 1 Determination of diffuse emissions by measurements - Basic concepts, 2005.
- [26] Oberösterreichische Landesregierung, UVP Linz 2010: Permit of the Environmental Impact Assessment 'Linz 2010', 2004.
- [27] EC Panorama, 'Iron and Steel', *Panorama of EU Industry 97*, Vol. Vol.1 10-8 - 10-14, 1997.
- [28] ECSC, Treaty on the foundation of the European Union for Coal and Steel on April 18th (1951), 1951.
- [29] EC Sinter/BF, *Technical Note on Best Available Techniques to Reduce Emissions of Pollutants into the Air from Sinter Plants, Pelletisation and Blast Furnaces*, 1995.
- [30] Roederer et al., *Coordinated Study 'Steel-Environment'*, 1996.
- [31] Caughlin, R., 'Note on fugitive and diffuse sources of particulate matter at steelworks', Personal Communication, 2009.
- [32] Voestalpine Linz, Environmental statement 2008, 2008.
- [33] Eisenhut et al., 'New Findings and Developments in Environmental Protection and Health Safety at Work on Coke Oven Plants', *Ironmaking Conference Proceedings*, 1988, Bergbau-Forschung GmbH, D-Essen.
- [34] dena, Successful Record for Pump Systems: Energy Efficiency Pays Off, 2007.
- [35] Dr. Luengen, H.B., 'Technische Entwicklungen in der Stahlindustrie verringern CO₂-Emissionen', *Rheinklima - die Zukunftsfähigkeit eines europäeischen Wirtschaftsraums im Wandel des Klimas*, 2005, Bonn.
- [36] EPRI, *Proceedings of the CMP Electric Arc Furnace Dust Treatment Symposium*, EPRI Center for Materials Production, 1992.
- [37] Motz, *Annex I: Substance Identity - from the ferrous slag consortium agreement*, 2009.
- [38] EUROFER BOF, *Document on "Oxygen Steelmaking and Casting"*, – Environmental Committee – Task Group Oxygen Steelmaking, 1997.
- [39] EUROFER EAF, *Document on "Electric Arc Furnace Steelmaking"*, – Environmental Committee – Task Group Electric Arc Furnace Steelmaking, 1997.
- [40] IPCC, *Fourth Assessment Report on Climate Change 2007, Synthesis Report*, IPCC, 2007.
- [41] European Commission, *BREF on Industrial Cooling Systems*, European Commission, 2001.
- [42] EC, *Reference Document on General Principles of Monitoring (MON)*, 2003.
- [43] Freuhan, 'Challenges and Opportunities in the Steel Industry', *Iron and Steel Magazine*, Vol. No. 3, 1993, pp. 59-64.
- [44] Freuhan, 'Effect of Emerging Technologies on Competitiveness in the Steel Industry', *Iron and Steel Magazine*, Vol. No. 2, 1994, pp. 17-22.
- [45] Gebert, *Abgasreinigungssysteme fuer Sinteranlagen (Off Gas Purification Systems for Sinter Plants)*, 1995.
- [46] Geiseler, 'Verwertung der Stahlwerksschlacken (Re-use of Slags from Basic Oxygen Steelmaking)', *Stahl und Eisen 111*, Vol. No. 1, 1991, pp. 133-138.
- [47] Geiseler, *Verwertung von Hochofen- und Stahlwerksschlacken (Re-use of Blast Furnace and BOF Slag)*, 1992, pp. 1-32.
- [48] EC, *Reference Document on Energy Efficiency (ENE)*, 2008.

- [49] Goverde et al., *Milieuvoorzieningen bij Hoogovens Ijmuiden*, 1995.
- [50] Grützmacher et al., *Staubunterdrueckung in Hochofengießhallen (Dust Supression in Cast Houses)*, 1991, pp. 51-56.
- [51] UN ECE, *Recommendations on Monitoring and Response Procedures for Radioactive Scrap Metal*, UN, 2006.
- [52] de Haas et al., *Vermeidung der Staubbildung in Hochofengießhallen (Dust Supression in Blast Furnace Cast Houses)*, 1997.
- [53] BDSV, *European Steel Scrap Specification*, 2009.
- [54] Haissig, '21st Century Electric Steelmaking: The Integrated Meltshop', *Iron & Steel Society's 25th Advanced Technology Symposium in St. Petersburg Beach*, 1997, US-Florida on May 11-14.
- [55] Harp et al., *Untersuchung und Bewertung der Einsatzmöglichkeiten verschiedener Verfahren zur Aufbereitung von Huettenwerksrest- und -abfallstoffen (Investigation and Assessment of the Applicability of Different Techniques to Treat Residues and By-products from Integrated Steelworks)*, Betirebsforschungsinstitut (BFI), 1990.
- [56] Dr. Gaertner, A., 'Messung diffuser Emissionen', *Workshop on "Diffuse Emissionen"*, 2004, Duesseldorf.
- [57] Heinen, *Elektrostahl-Erzeugung, 4. Aufl. (Electric Arc Furnace Steel Production, 4. ed.)*, Verlag Stahleisen GmbH, D-Duesseldorf, 1997.
- [58] Kaestli, P., 'Comparison of conversion costs of continuous scrap preheating systems', Personal Communication, 2009.
- [59] Nethe, *Der Einsatz von Sorbentien im gesamten System von Abgasreinigungsanlagen*, 2005.
- [60] Hille et al., *Wirtschaftliche Betrachtungen zur Entwicklung der Hochofenkapazitaeten in der Welt (Economical Considerations of the Development of Blast Furnace Production Capacities in the World)*, 1997, pp. 93-101.
- [61] Hodges, 'Pollution Prevention and the Sinter Plant', *European Symposium on Environmental Control in Steel Industry*, 1995, Praha.
- [62] Hoffmann, *Die Rueckgewinnung von Zink und Blei aus Staeuben der Elektrostahlerzeugung (The Recovery of Zinc and Lead from Dusts from Electric Arc Furnace Steelmaking)*, 1997.
- [63] Wirling, J., 'Safety aspects in the use of carbonaceous sorbents during waste gas treatment', *MT International*, Vol. Vol. 3, 2007, pp. 144-152.
- [64] IISI, *The Management of Steel Industry By-products and Wastes*, IISI-Committee on Environmental Affairs, 1985.
- [65] InfoMil, *Dutch Notes on BAT for the Production of Primary Iron and Steel*, Spatial Planning and the Environment, Directorate for Air and Energy, Department of Industry, 1997.
- [66] Joksch, 'Development of Energy Conservation Technology at Thyssen Stahl AG in Germany', *European Symposium on Environmental Control in Steel Industry*, 1995, Praha.
- [67] TSW GmbH, 'Anlagen- und Betriebsbeschreibung zur Modernisierung und umwelttechnischen Sanierung des Stahlwerks der TSW', Personal Communication, 2005.
- [68] Karcher et al., *Ermittlung und Verminderung der Emissionen von Dioxinen und Furanen aus thermischen Prozessen: Untersuchung der Zusammenhaenge der Dioxin-/Furanemissionen in Abhaengigkeit von Einsatzstoffen und Minderungstechniken bei Elektrolichtbogenofen (Investigation and Reduction of PCDD/F Emissions from Thermal Processes: Investigation of Connections of PCDD/F Emissions Depending on Input and Minimisation Techniques at Electric Arc Furnaces)*, 1996.
- [69] Kemeny, 'Technical Look at EAF Dust Treatment. Proceedings of the CMP Report', *CMP Electric Arc Furnace Dust Treatment Symposium*, Vol. No. 94-2, 1994.
- [70] Kersting et al., 'Countermeasures for Organic Emissions from Sinter Plants (1997)', *ENCOSTEEL – Steel for Sustainable Development*, 1997, on June 16-17, 1997 in S-Stockholm.

References

- [71] Kim et al., 'Improvement of Sinter Plant Stack Emissions at Kwangyang Works, Posco', *2nd International Congress on the Science and Technology of Ironmaking Conjunction with the 57th Ironmaking Conference of Iron and Steel Society*, 1998, C-Toronto on March 22-25.
- [72] N.N., Eisen und Stahlerzeugung, Hinweise und Erläuterungen zu Anhang 29 der Abwasserverordnung, 2005.
- [73] Knapp, 'Quality and Improvements of the Shaft Furnace with Post-combustion', *Monterrey Symposium*, 1996, Monterrey.
- [74] Knoerzer et al., 'The Design and Operation of Jewell's New Nonrecovery Coke Oven Batteries', *50th Ironmaking Conference*, 1991, US-Washington on April 14-17.
- [75] Knoop et al., 'Steuerung des Einschmelzens im Drehstrom-Lichtbogenofen zum Schutz der Wandkuehlelemente (Control of Melting in the Three-Phase-Current Arc Furnace to Protect the Water-cooled Side Walls)', *Stahl und Eisen* 117, Vol. No. 2, 1997, pp. 91-96.
- [76] Koeller, 'Environmental Protection - A Challenge to Management in the Austrian Steel Industry', *European Symposium on Environmental Control in Steel Industry*, 1995, Praha.
- [77] Austrian TWG member, Austrian comments on the first draft of the reviewed IS BREF, 2008.
- [78] Kreulitsch et al., *Iron and Steelmaking of the Future*, Iron and Steelmaking International, 1994, pp. 4-8.
- [79] Kuhner et al., 'Noise Abatement for Electric Arc Furnaces', *Iron and Steel Engineer* 73, Vol. No. 4, 1996, pp. 83-86.
- [80] Dornseiffer, P., Luxembourg comments on the first draft of the reviewed IS BREF, 2008.
- [81] Norwegian TWG member, Norwegian comments on the first draft of the reviewed IS BREF, 2008.
- [82] Lemperle et al., *Corex Today and Tomorrow*, Metallurgical Plant and Technology International, 1993.
- [83] Ehrlich, C. et al, 'PM 10, PM 2.5, PM 1,0-Emissions from industrial plants-Results from measurement programmes in Germany', *Atmospheric Environment*, Vol. Vol. 41, 2007, pp. 6236 - 6254.
- [84] Grasselli, A. and Raggio, C., 'Consteel EAF Technology', Personal Communication, 2008.
- [85] VDI/DIN, VDI 2584 - Naturstein Aufbereitungsanlagen in Steinbrüchen, 2006.
- [86] Linninger et al., 'Modernes Technologie- und Informationsmanagement am Beispiel der Auslegung von Elektrolichtbogenofen (Modern Technology and Information Management by Hand of the Design of Electric Arc Furnaces)', *Stahl und Eisen* 115, Vol. No. 3, 1995, pp. 93-101.
- [87] Medinger et al., *Bilanz der Quecksilbermissionen aus Quellen im Linzer Stadtgebiet (Balancing the emissions of mercury in the area of the city of Linz)*, City of Linz – Office for Environmental Protection, 1996.
- [88] Löhr et al., 'State of the Art in Biological Waste water Treatment in European Coking Plants', 1996, B-Gent.
- [89] Löhr et al., *Process for Waste water Treatment of Coking Plants*, 1997, pp. 54-60.
- [90] Köhler et al., 'Introduction to PW Bell less top charging system', Personal Communication, 2009.
- [91] Memoli, F. and Ferri, M., 'New track record for Consteel due to new environment-friendly features', *MPT International*, Vol. No. 5 2007, 2007, pp. 58 - 65.
- [92] Lungen, 'Roheisenerzeugung im Jahr 2000 (Pig Iron Production in 2000)', *Stahl und Eisen* 115, 1995, pp. 45-55.
- [93] Matzke, *Blei-, Zink- und Alkalientfernung beim Sintern von Reicherzmischungen (Lead, Zinc and Alkali Removal During Sintering of Rich Ore Mixtures)*, 1987.
- [94] Mc Manus, *Scrap Preheating: A Trend Gains Momentum*, 1995, pp. 60-61.

- [95] Mertins, 'Die Aufbereitung von Hochofengichtgasschlaemmen – ein Beitrag zur Entsorgung eines Abfallstoffes (The Treatment of Blast Furnace Top Gas Sludges – A Contribution for the Disposal of a Solid Waste)', *VCH, Verlag Erzmetal* 39, Vol. No. 7, No 8, 1986, pp. 399-404.
- [96] VDI/DIN, VDI 4211 part 1 Remote sensing - Atmospheric measurements near ground with FTIR spectroscopy - Fundamentals, 2000.
- [97] Murphy et al., 'High Pressure Water Jet Coke-oven Door Cleaning and Mass-flow Charging of Ovens', *Iron and Steel Engineer*, Vol. No. 3, 1991, pp. 23-30.
- [98] Nagai, *Sources of Iron Beyond 2000*, EAF Supplement, 1995.
- [99] DK Recycling, 'DK recycling operational data', Personal Communication, 2009.
- [100] Nathaus et al., *Wet Quenching Towers with De-dusting Equipment – Brochure and Reference List*, 1997.
- [101] Neuschütz et al., 'Comparison on Thermochemically Calculated and Measured Dioxin Contents in the Off-gas of a Sinter Plant - Part 1', *9th Japan-Germany Seminar on Fundamentals of Iron and Steelmaking*, 1996, on September 8-9.
- [102] Eurofer, Eurofer comments on the first draft of the reviewed IS BREF, 2008.
- [103] OECD, *Environmental Implications of Energy Use in Industry*, Organisation for Economic Co-operation and Development, 1988.
- [104] te Lindert et al., *Demonstration Plant for Sintering with Reduced Volume of Flue-gases*, 1997.
- [105] Pazdej et al., 'Treatment of BF and BOF Dust and Sludges', *European Symposium on Environmental Control in Steel Industry*, 1995, CZ-Praha.
- [106] Pedersen et al., 'Environmental Aspects of Steel Mill Gas Cleaning', *Steel and the Environment in the 21st Century*, 1996, UK-London on April 2-3.
- [107] N.N., 'Rogesa: Neue Abgasreinigung an Sinteranlage', *Stahl und Eisen*, Vol. 129 Nr.2, 2009, p. 1.
- [108] Philipp et al., 'Umweltschutz in der Stahlindustrie – Entwicklungsstand – Anforderungen – Grenzen (Environmental Protection in the Steel Industry - State of Developments – Requirements – Limits)', *Stahl und Eisen* 107, Vol. No. 11, 1987, pp. 507-514.
- [109] Hein, M. et al, 'Umweltaspekte beim Nasslöschen', *Fachtagung Kokereitechnik*, 2000, Essen.
- [110] Brouhon, Belgium comments on the first draft of the reviewed IS BREF, 2008.
- [111] Poth, 'Die Schlackengranulation des Hochofens Schwelgern mit einer OCP-Entwaesserung (The Slag Granulation of the Blast Furnace Schwelgern with OCP Dewatering)', *Stahl und Eisen* 105, 1985, pp. 386-389.
- [112] Pütz, 'Uebersicht ueber Dioxinmissionsquellen der Stahlindustrie unter besonderer Beruecksichtigung ihrer Sinteranlagen (Survey about the PCDD/F Sources in the Steel Industry with Special Consideration of Sinter Plants)', *12. Aachener Stahlkolloquium*, 1997.
- [113] Gidlund et al., Information about Swedish pelletisation plants, 2008.
- [114] Remus, Rainer, 'Mission report (Corus Ijmuiden, the Netherlands)', Personal Communication, 2008.
- [115] Walker, D.; Barkdoll, M., 'Cokemaking', *Cokemaking International*, Vol. 14 No.1, 2002.
- [116] Rentz et al., *Stoffstrommanagement in der Eisen- und Stahlindustrie (Material Flow Management in the Iron and Steel Industry)*, E. Schmidt Verlag, 1996.
- [117] Hoffmann, A. et al, 'Cokemaking', *Cokemaking International*, Vol. 13 No.2, 2001.
- [118] Rothery, *Desulphurisation of Coke Oven Gas by HSR Process*, 1987.
- [119] Sakuragi et al., *Operation Results of the Exhaust Gas Recirculation System in Tobata No. 3 Sinter Plant*, La Revue de Métallurgie – CIT, 1995.

References

- [120] Schiemann, *Untersuchungen des Sammelschrotts auf PCB-Quellen und Entwicklung geeigneter Vorbehandlungsmaßnahmen (Investigations of Collected Scrap on PCB Sources and Development of an Appropriate Pretreatment)*, 1995.
- [121] Hein, M., 'Cokemaking', *Cokemaking International*, Vol. 14 No.1, 2002.
- [122] Scholz et al., 'The Formation of PCB on Fly Ash and Conversion to PCDD/PCDF', *Organohalogen Compounds* 31, 1997, pp. 538-541.
- [123] SHI, *A System for Waste Heat Recovery in Sintering Plant*, 1987.
- [124] Arendt, P. et al, 'Konventioneller Horizontalkammerofen', *Stahl und Eisen* 126 Nr. 1, 2006.
- [125] Smith, *New Concept in EAF Energy Saving Commissioned at Sheerness Steel*, I&SM, 1992, pp. 57-59.
- [126] Spencer et al., *Chem. and Eng. Technology* 15, 1992.
- [127] Dr. Fleischanderl, Alexander, 'Improved dry-type gas cleaning process for the treatment of sinter offgas', *MPT International*, Vol. No. 3 2006, 2006.
- [128] Sporenberg, *Messprotokolle und Berichte über die Durchführung von Emissionsmessungen im Kamin der Sinteranlage sowie Nebenanlagen der EKO Stahl GmbH Eisenhüttenstadt*, Umweltschutz Messtechnik GmbH, 2006.
- [129] Stalherm et al., *Design and Start-up of the Third Wide Chamber Coke-oven Battery at Prosper, West-Germany*, 1990, pp. 9-15.
- [130] Stalherm et al., *Cokemaking and the Environment*, Steel Times International, 1995, pp. 19-22.
- [131] Stat Stahl, *Statistisches Jahrbuch der Stahlindustrie 1996 (Statistical Yearbook of the Steel Industry 1996)*, 1997.
- [132] Steeghs et al., *High Injection Rates of Coal into the Blast Furnace*, 1994.
- [133] Stieglitz et al., *Investigation of Precursors Reaction in the De-Novo Synthesis of PCDD/PCDF on Fly Ash*, 1997, pp. 1083-1090.
- [134] Strohmeier et al., *Steelworks Residues and the Waelz Kiln Treatment of Electric Arc Furnace Dust*, 1996, pp. 87-90.
- [135] Busink, R., 'Specific emissions to water from direct cooling at continuous casting', Personal Communication, 2009.
- [136] Theobald, *Kreislauffuehrung von Hochofenwaschwasser (Recycling of Blast Furnace Gas Scrubbing Water)*, 1988.
- [137] Theobald, *Ermittlung und Verminderung der Emissionen von halogenierten Dioxinen und Furanen aus thermischen Prozessen (Study of the Emissions of Polychlorinated Dibenzodioxins and -furans and Heavy Metals from Iron and Steel Plants)*, 1995.
- [138] Theobald, *Hintergrundpapier zum Anhang 24 (Anforderungen an die Eisen- und Stahlindustrie) zur Rahmen-Abwasserverordnung nach § 7a Wasserhaushaltsgesetz (Background Paper for the Requirements in annex 24 (Requirements for Iron and Steel Industry) of the Waste water Rule According to Section 7a of the German Water Management Act)*, 1997.
- [139] GfA Münster-Roxel, *Emissionen der Primorec S.A.in Differdange, Luxembourg*, 2008.
- [140] Eurofer, *Compilation of open issues according to the Member state comments and gaps of information on the review of the IS BREF draft*, 2009.
- [141] Ferry, M., *Direct strip casting of metals and alloys*, 2006.
- [142] Hendricks, C., 'Strip casting technology - A revolution in the steel industry?', *MPT International*, Vol. Vol. 18 No. 3, 1995.
- [143] UA-OÖ, 'Quecksilberemissionen aus Sinteranlagen (Mercury Emissions from a Sinter Plant)', Personal Communication, 1998.
- [144] UBA-BSW, *Ermittlung und Verminderung der Emissionen von Dioxinen und Furanen aus thermischen Prozessen; Untersuchung der Zusammenhaenge der Dioxin-/Furanemissionen in Abhaengigkeit von Einsatzstoffen und Minderungstechniken bei*

- Elektro-Lichtbogenöfen (Determination and Minimisation of PCDD/F Emissions from Thermal Processes, Investigation of the Effect of Electric Arc Furnace Input and Emission Control Techniques on the Formation of PCDD/F Emissions)*, sponsored by the Federal Environmental Protection Agency of Germany, Berlin, 1996.
- [145] UBA Comments, *Comments on the draft 'Dutch Notes on Best Available Techniques for Pollution Prevention and Control in the Production of Primary Iron and Steel'*, Environmental Protection Agency of Germany (UBA), Berlin, 1997.
- [146] Schäperkötter, M. et al, *Energieeinsparung, CO₂-Emissionsminderung und Ressourcenschonung bei der Herstellung und Anwendung von (hochfesten und duktilen) HSD-Stählen*, BMBF, 2009.
- [147] UK EAF, *Chief Inspector's Guidance to Inspectors - Process Guidance Note IPR 2/3*, 1994.
- [148] UK Coke, *Chief Inspector's Guidance Note, Series 2 (S2) - Processes Subject to Integrated Pollution Control*, 1995.
- [149] Kemper, G., 'State of the Art in Continuous Casting Technology', *Stahl 2008*, 2008, Düsseldorf.
- [150] Bakker, Wim, Dutch comments on the first draft of the reviewed IS BREF, 2008.
- [151] TÜV Süd Industrie Service GmbH, *Emissionsmessungen an diffusen Quellen im Oxygenstahlwerk 1; hier: Dachreitern der Mischerhalle und über den Konvertern bei Thyssen Krupp Stahl AG Duisburg-Bruckhausen*, 2005.
- [152] Ullmann's, *Ullmann's Encyclopedia of Industrial Chemistry, 5. edition Steel*, VCH Verlagsgesellschaft, Weinheim, 1994.
- [153] UN-ECE, *The Recuperation and Economic Utilization of By-products of the Iron and Steel Industry*, United Nations, Economic Commission for Europe CH-Geneve, 1990.
- [154] UN-ECE, "By-Product Utilization from Stationary Installations" – *Status Report*, Austrian Federal Ministry of the Environment, A-Vienna, 1996.
- [155] UN-ECE Pops, *Long-range Transboundary Air Pollution*, United Nations/Economic Commission for Europe, 1997.
- [156] Coke oven manager association, *List of UK and European Coal and Coke Works*, 2008.
- [157] Thompson, P. et al, *Process related pattern in dioxin emissions: a simplified eassessment procedure applied to coke combustion in sinter plant*, sciencedirect, 2003.
- [158] Dr. Ameling, D., 'Steel - Innovative solutions for energy and ressource challenges', *8th International Arab Iron and Steel Confernece*, 2008, Doha-Qatar.
- [159] VAI, 'Successful Application of the Top-layer-sintering Process for Recycling of Ferrous Residuals Contaminated with Organic Substances', *56th Ironmaking Conference*, 1997, US-Chicago on April 13-16.
- [160] IEA Clean Coal Centre, *Use of PCI in blast furnaces*, 2006.
- [161] Vos, 'Environmental Control at Hoogovens IJmuiden Coke Oven Plant', *European Symposium on Environmental Control in Steel Industry*, 1995, Praha.
- [162] Voss-Spilker et al., 'Emission Prevention and Energy Saving in Electric Arc Furnaces by the Fuchs Shaft Furnace Technology', *Steel and the Environment in the 21st Century*, 1996, UK-London on April 2-3.
- [163] Infomil, *Range of achieved emission concentrations applying Arsenic removal in a pelletisation plant*, 2009.
- [164] Weiss, 'Minderung der PCDD/PCDF-Emissionen an einer Eisenerzsinteranlage (Reduction of PCDD/F Emissions from a Iron Ore Sinter Plant)', *VDI-Colloquium "Dioxins – Occurrence, Reduction, Monitoring"*, 1996, D-Fulda on October 29-30.
- [165] VDI/DIN, *VDI 3790 part 3 Environmental meteorology - Emission of gases, odours and dusts from diffuse sources - Storage, transshipment and transportation of bulk materials*, 1999.

References

- [166]Lundqvist, A., 'Operational data from the plants located in Malmberget and Kiruna, Sweden', Personal Communication, 2009.
- [167]Werner, *Control of Organic Micropollutants from the EAF*, International Iron and Steel Institute, 1997, pp. 247-255.
- [168]EC, *BREF on Large Volume Inorganic Chemicals - Solids and Others (LVIC-S)*, 2007.
- [169]LKAB, *Ökad pelletskapacitet i Karuna - Teknisk beskrivning*, 2004.
- [170]N.N., 'Chimie industrielle: Proposition de facteurs d'émission por la sidérurgie wallonne; chargement du haut fourneau (SNAP 040202)', Personal Communication, 1997.
- [171]N.N., *EIE relative á une demande de permis d'environnement. Redémarrage du haut fourneau No.6 de Seraing. ArcelorMittal, SGA Belgium S.A.*, 2007.
- [172]Fandrich et al., 'Actual review on secondary metallurgy', *La Revue de Métallurgie - CIT*, 2008, pp. 364 - 374.
- [173]UBA-Germany, Data for waste water treatment in a coking plant, 2005.
- [174]Euroslag, *Legal Staus of Slags - Position Paper*, The European Slag Association, 2006.
- [175]Eurofer, Contribution to the second revised IS BREF draft July 2009, 2009.
- [176]EPA, Miscellaneous Sources, AP 42, 2009.
- [177]Eurofer, Comments on the second revised IS BREF draft from July 2009, 2009.
- [178]N.N., *Untersuchung einer Abwasserprobe der BSW Kehl*, 2008.
- [179]Metz et al., *IPCC Special Report on Carbon Dioxide Capture and Storage. Prpared by Working Group III of the Intergovernmental Panel on Climate Change*, Cambridge University Press, 2005.
- [180]N.N., *CO₂ Capture and Storage - A key carbon abatement option*, IEA International Energy Agency, 2008.
- [181]Vangkilde-Pedersen et al., *Towards Hydrogen and Electricity Production with Carbon Capture and Storage*, 2007.
- [182]Infomil, 'Infomil contribution on BOF emissions at Corus IJmuiden', Personal Communication, 2009.
- [183]Weiss, *Massnahmen zur Verbesserung der Entstaubung einer Eisenerzsinteranlage mit nach folgenden Untersuchungen zur Minderung der PCDD/PCDF-Emissionen*, Stahlwerke Bremen, 1998.
- [184]European Union, *Commission staff working document - updated sectoral overview*, 2009.
- [185]EC, *Reference Document on Economics and Cross-Media Effects (ECM)*, 2006.
- [186]Sowa et al., 'Advanced Technologies for Desulphurisation of Coke Oven Gas', *COG Desulphurisation ICC 2009 Ranchi*, 2009, Ranchi, India.
- [187]TÜV SÜD, *Bericht über die Durchführung von Emissionsmessungen zur Ermittlung der Konzentrationen an polychlorierten Dibenzo-Dioxinen und Furanen (PCDD/F) im gereinigten Abgas der Sinterbänder 2, 3 und 4 einer Sinteranlage der ThyssenKrupp Steel AG*, 2007.
- [188]European Commission, *BREF on Ferrous Metals Processing Industry*, 2001.
- [189]N.N., 'Data from the Emission register', Personal Communication, 2008.
- [190]Eurofer, 'Sinter plant ArcelorMittal Bremen, Dust Emission 1999 to 2009', Personal Communication, 2010.
- [191]Infomil, 'Infomil Contribution on EAF emissions in the Netherlands', Personal Communication, 2010.
- [192]Schlüter, 'Hydro-Hybrid Filter for BOF gas cleaning', Personal Communication, 2009.
- [193]Voestalpine Linz, *Emissionsmessungen Sinterband 5 - Reingas Quecksilber -*, 2010.
- [194]Leroy et al, *New abatement techniques of the atmospheric emissions of large sinter plant*, 2007.

- [195]Werner, 'Data about the utilisation of EAF slags in 2008', Personal Communication, 2010.
- [196]Josis, 'New data for the biological waste water treatment plant at Sidmar and Seremange', Personal Communication, 2010.
- [197]Jost, 'New data for the biological waste water treatment plant at Dillingen', Personal Communication, 2010.
- [198]Mensink, C. et al, 'Source Analysis and Emission Abatement Measures for PM10 Hot spot Regions in Flanders', *11th conference on Harmonisation within Atmospheric Dispersion Modelling for Regulatory Purposes*, 2007, Cambridge.
- [199]Mark et al., 'Port Talbot PM 10: A Study into industrial source identification, reductionj and improvement', *IUAPPA- 17th EFCA conference*, 2006, Lille, France.
- [200]Commission, *BREF on the Production of Iron and Steel*, European Commission, Sevilla, 2001.
- [201]Colin et al., *Amélioration de la stabilité de fonctionnement et des performances des stations d'épuration biologique d'effluents de cokerie*, Cinquieme Programme de Recherches, CECA, 2003, p. 8.
- [202]USEPA, *Development Document for Final Effluent Limitations Guidelines and Standards for the Iron and Steel Manufacturing Point Source Category*, USA Environmental Protection Agency, 2002, p. 12.
- [203]Liszlo et al., 'Design and first operational experience of the Pressure Regulated Oven System (Proven) at the coke plant 'Schwelgern'', *2nd International Meeting on Ironmaking - 1st International Symposium on Iron ore*, 2004, Vitória, Espírito Santo, Brazil.
- [204]Neuwirth et al., 'State-of-the-art plant technology for cokemaking', *MPT International*, Vol. 5, No 2003, 2003, pp. 38-48.
- [205]Cleary et al., 'Coke production and demand today and tomorrow - face up to the reality?', *Stahl und eisen*, Vol. 125 (2005) Nr.1, 2005, pp. 17-27.
- [206]Diemer et al., 'Potentials for utilisation of coke oven gas in integrated iron and steel works', *Stahl und eisen*, Vol. 124 (2004) Nr. 7, 2004, pp. 21-30.
- [207]Ameling et al., 'The coke scenario of the German and EU15 steel industry', *Stahl und eisen*, Vol. 124 Nr.9, 2004, pp. 25-34.
- [208]Lindfors et al., *BAT examples from the Nordic iron and steel industry*, Nordic Council of Ministers. Norden, 2006, p. 156.
- [209]EC, *Preparatory work for new dioxin measurement requirements for the European metal industry. Final report*, EC, 2005, p. 151.
- [210]Brouhon, 'Comments of EUROFER to the Stockholm Convention on POPs', Personal Communication, 2006.
- [211]Remus, Rainer, *Mission report Voestalpine Linz and Donawitz*, 2008.
- [212]EC CLM BREF, *Reference Document on Best Available Techniques in the Cement, Lime and Magnesium Oxide Manufacturing Industries (CLM BREF)*, 2009.
- [213]Bittner et al., 'Chemistry of intermediate species in the rich combustion of benzene', 1983, pp. 95-125.
- [214]Richter et al., 'Formation of Polycyclic Aromatic Hydrocarbons and their radicals in a nearly sooting premixed benzene flame', *Proceedings of the Combustion Institute*, Vol. 28, 2000, pp. 2609-2617.
- [215]BSS, *Air Quality. Several case studies*, 2007, pp. 26-32.
- [216]sniffers et al., *Technical description of fugitive emission monitoring & management*, The Sniffers nv/sa, 2006, p. 18.
- [217]Siemens-vai, *Sinter solutions*, Siemens-vai, 2006, p. 14.
- [218]Dong et al., 'A multistage approach to the cohort analysis of lifetime lung cancer risk among steelworkers exposed to coke oven emissions', *American Journal of Epidemiology*, Vol. Vol. 128, No. 4, 1988, pp. 860-873.

References

- [219]Van den Berg et al., 'Toxic equivalency factors (TEFs) for PCBs, PCDDs, PCDFs for Humans and Wildlife', *Environmental Health Perspectives*, Vol. 106, No 12, 1998, p. 21.
- [220]Eurofer, 'Comments from Eurofer on the Iron and Steel BREF first draft', Personal Communication, 2008.
- [221]Thomas et al., *Blast furnace tuyere injection of iron and steelmaking by-products*, 2002, p. 116.
- [222]Janhsen et al., *Coke quality for blast furnace operation with high levels of coal/oil injection*, 2002, p. 205.
- [223]USEPA, *Emission Factor Documentation for AP-42. Section 12.2. Coke production. Draft July 2001*, U.S. Environmental Protection Agency, 2001, p. 313.
- [224]Xhrouet, *Contribution à l'étude d'une technique de réduction de la formation des dioxines dans le procédé d'agglomération des minerais de fer*, Université de Liège. Faculté des Sciences Appliquées, 2002.
- [225]Brouhon, *Emissions from French coke ovens. Focus on PAH and Dioxins*, 2006.
- [226]EEA, *Emission Inventory Guidebook. CORINAIR. Solid Fuel Transformation Plants. Emission Factors of sub-processes of coke production*, US Environmental Protection Agency, 1999, p. 1.
- [227]WB, *Coke Manufacturing. Pollution Prevention and Abatement Handbook*, The World Bank Group and UNEP, 1998, pp. 286-290.
- [228]UNEP, *Standardized toolkit for identification and quantification of Dioxin and Furan releases*, United Nations Environmental Programme, 2001, pp. 51-52.
- [229]Green, 'Emission report for an Australian Iron and Steel installation', Personal Communication, 2004.
- [230]Brouhon et al., *Control of the PCDD/Fs generation at the Sinter plant*, CRM, Collective Research Programme 1999-2000, 2001, p. 23.
- [231]Xhrouet et al., 'Amines compounds as inhibitors of PCDD/Fs de Novo Formation on Sintering Process fly ash', *Environmental Science Technology*, Vol. 36, 2002, pp. 2760-2765.
- [232]Brouhon et al., *Traitement Chimique de Destruction spécifique des cyanures*, CEBEDEAU-CRM, 1990, p. 50.
- [233]Poos et al., *Etude des émissions de cyanures au haut-fourneau en marche journalière et en descente des charges*, CCE, 1993, p. 50.
- [234]Poland, *Emission data from Polish iron and steel plants*, 2007, p. 18.
- [235]Ailor, *Principal environmental issues facing the U.S. coke industry in 1999 and beyond*, 1999, p. 40.
- [236]Germany, *TA Luft 2002*, 2002, p. 6.
- [237]USEPA, *Risk Assessment Document for Coke Oven MACT Residual Risk*, USEPA, 2003, p. 269.
- [238]Janke et al., *Verwertung von ölkontaminierten Walzunderschlämmen und Shreddermüll über Hochöfen*, DBU, 1997, p. 119.
- [239]Setterstig, *Dioxin removal by the ADIOX technology*, Götaverken Miljö AB, 2006, p. 22.
- [240]UKEA, *IPPC. Guidance for the Production of Coke, Iron and Steel*, UK environmental agency, 2004, p. 185.
- [241]Poland, *Technical information on Polish iron and steel plants*, 2007, p. 8.
- [242]Caughlin, *UK comments to the I&S BREF*, UK Environmental Agency, 2007, p. 8.
- [243]Eurofer, *Revision of solid residues/by-products of the I&S BREF*, 2007, p. 3.
- [244]Plickert, *Performance values of iron and steel plants in Germany*, UBA, 2007, p. 6.
- [245]Kuhn et al., *Chrome immobilisation in EAF slags from high-alloy steelmaking: development of a slag treatment process*, 2004, p. 97.

- [246]EC, *Iron and Steel - a materials system analysis*, European Environment Agency, 2005, p. 90.
- [247]Netherlands, *Comments from the Netherlands to some information provided by Eurofer*, 2007, p. 2.
- [248]Eurofer, *Response from Eurofer to the comments from the Netherlands*, Eurofer, 2007.
- [249]Netherlands, *Contribution from the Netherlands to the revision of the I&S BREF*, 2007, p. 8.
- [250]EC, European Steel Technology Platform, ESTEP, 2006.
- [251]Eurofer, *Comments from Eurofer to the contribution from the Netherlands*, 2007, p. 3.
- [252]France, *Contribution from France to the revision of the I&S BREF*, 2007, p. 5.
- [253]ICSTI' 06, 'The 4th International Congress on the Science and Technology of Ironmaking', *The 4th International Congress on the Science and Technology of Ironmaking*, 2006, Osaka, Japan.
- [254]Eurofer, *Comments from Eurofer to the contribution from France*, 2007, p. 2.
- [255]Kasai et al., 'Effect of additives on the dioxins emissions in the iron ore sintering process', *ISIJ international*, Vol. Vol 41, No 1, 2001, pp. 93-97.
- [256]Kasai et al., 'Behavior of dioxins in the sintering process of iron ores', *Tetsu-to-Hagané*, Vol. Vol. 87, No. 5, 2001, pp. 24-33.
- [257]Kawaguchi et al., 'Behaviour of trace chlorine in sintering bet and its effect on dioxins concentration in exhaust gas of iron ore sintering', *Tetsu-to-Hagané*, Vol. Vol. 88, No.2, 2002, pp. 9-15.
- [258]Kuzuhara et al., 'Formation of PCDD/Fs during oxidation of carbonaceous materials at low temperatures', *Tetsu-to-Hagané*, Vol. Vol. 89, No. 8, 2003, pp. 1-8.
- [259]Kasama et al., 'Investigation on the dioxin emission from a commercial sintering plant', *ISIJ International*, Vol. Vol. 46, No. 7, 2006, pp. 1014-1019.
- [260]Germany, *Contribution from Germany to the revision of the I&S BREF*, 2007, p. 10.
- [261]Kasama et al., 'Analysis of exhaust gas visibility in iron ore sintering plant', *ISIJ international*, Vol. Vol. 46, No. 7, 2006, pp. 1027-1032.
- [262]Pütz et al., *Untersuchungsergebnisse über Möglichkeiten zur primärseitigen Dioxinminderung bei der Eisenerzsinterung*, VDI Berichte, 1996, pp. 249-268.
- [263]Kasai et al., 'Macroscopic behaviours of dioxins in the iron ore sintering plants', *ISIJ international*, Vol. Vol. 41, No. 1, 2001, pp. 86-92.
- [264]Germany, *Dust emission from CSQ wet quenching tower*, 2007, p. 1.
- [265]Tan et al., 'Study on polychlorinated dibenzo-p-dioxin/furan formation in iron ore sintering process', *Metallurgical and materials transactions B*, Vol. Vol 35B, 2004, pp. 983-991.
- [266]Kawaguchi et al., 'Promoter material and inhibitor material for dioxins formation in sintering process', *Tetsu-to-Hagané*, Vol. Vol. 88, No. 7, 2002, pp. 12-19.
- [267]Kawaguchi et al., *Effect of properties of solid fuel on dioxin concentration of the exhaust gas in the iron ore sintering process*, *Tetsu-to-Hagané*, 2002, pp. 20-27.
- [268]SHI, *Gas cleaning system using activated char*, 2006, p. 15.
- [269]Germany, *Coke transport by pipe conveyors*, 2007, p. 1.
- [270]Reynard, *Slags from iron and steel production*, End-of-Waste Project. Aggregates case study, 2007, p. 20.
- [271]Luo, *The end of waste criteria. A case study on scrap metal*, End of Waste criteria. 23/3/07, 2007, p. 24.
- [272]Germany, *Nitrification-denitrification concept in the biological treatment plant for coke oven waste water*, 2007, p. 5.
- [273]Eurofer, *Comments from Eurofer to the information provided by Germany*, 2007, p. 5.

References

- [274]Eurofer et al., *Zinc coated steel*, Association of Eurofer, IZA-Europe and EGGA association, 1999, p. 24.
- [275]Kobelco, Environmental sustainability report 2005, 2005.
- [276]Italy, *Contribution from Italy to the revision of the I&S BREF*, 2007, p. 14.
- [277]Wiesenberger, *Review of the BREF Iron and Steel Production - Austrian Comments*, UBA, 2007, p. 35.
- [278]J-P.Birat et al., *Quality of heavy market scrap:development of new and simple methods for quality assessment and quality improvement*, 2002, p. 139.
- [279]IISI, *The Steel Industry. Industry sector report for the United Nations World Summit on Sustainable Development*, IISI, 2002, p. 55.
- [280]Aguado-Monsonet, 'Visits to Iron and Steel plants', Personal Communication, 2007.
- [281]Eurofer, *Contribution to the Energy Management section*, 2007, p. 11.
- [282]EC, *BREF on Large Combustion Plants (LCP)*, 2006.
- [283]EC, *BREF on Emissions from Storage (EFS)*, 2006.
- [284]EC, *BREF on Non-Ferrous Metal processes*, 2001.
- [285]EC, *BREF on Waste Incineration (WI)*, 2006.
- [286]Stahl, *Statistisches Jahrbuch der Stahlindustrie 2009-2010*, Stahleisen-Verlag, 2008.
- [287]MVAE, 'International conference on Clean Technologies in the Steel industry', *International conference on Clean Technologies in the Steel industry*, Tardy, 2005, Balatonfured (Hungary).
- [288]IA, *Projecto "Emissões para a atmosfera no sector da transformação de metais com processos metalúrgicos, e sua aplicação ao contexto nacional" (Air emissions from metal industry in Portugal)*, Ministério do Ambiente, do Ordenamento do Território e do Desenvolvimento Regional, 2006, p. 177.
- [289]EC, *Community implementation plan for the Stockholm Convention on Persistent Organic Pollutants*, EC, 2007, p. 92.
- [290]Nippon Steel Engineering Co., 'Comments on Coke Dry Quenching', Personal Communication, 2008.
- [291]EC, *Panorama of the European Union*, Eurostat, 2006, p. 162.
- [292]DGENTR, *Possible developments in the structure of the EU and World steel industries*, Commission, 2007, p. 11.
- [293]DGENTR, *Overview of the EU Steel sector*, DGENTR, 2007, p. 16.
- [294]Fleischanderl, *MEROS - An improved dry-type gas-cleaning process for the treatment of sinter offgas*, The Revue de Métallurgie - CIT, 2006, pp. 481-486.
- [295]Hartig et al., *Cleaning of sinter waste gases. State of the art*, La Revue de la Métallurgie-CIT, 2006, pp. 258-265.
- [296]Leroy et al., 'Treatment of sinter plant flue gas', *DustConf 2007*, 2007.
- [297]Hekkema et al., *H2S-noodwasinstallatie*, Corus and Tebodin, 2004, p. 20.
- [298]Fleischanderl, *Scrubbed clean. Meros*, Metals & mining, 2006, pp. 38-39.
- [299]Eurofer, *Contemporary data across all European plants*, Eurofer, 2007, p. 4.
- [300]Eurofer, *General review of Sintering section of BREF*, Eurofer, 2007, p. 22.
- [301]Eurofer, *Update technique continuous and undisturbed sinter plant operation to minimise emissions*, Eurofer, 2007, p. 2.
- [302]Eurofer, *Update technique Use of residues in the sinter plant*, Eurofer, 2007, p. 2.
- [303]Eurofer, *Update technique lowering the content of volatile hydrocarbons in the sinter feed*, Eurofer, 2007, p. 3.

- [304]Eurofer, *Update technique lowering the sulphur content of the sinter feed*, Eurofer, 2007, p. 2.
- [305]Eurofer, *Update technique Heat recovery from sintering and sinter cooling*, Eurofer, 2007, p. 4.
- [306]Eurofer, *Update technique suppression of dioxin formation by addition of urea*, Eurofer, 2007, p. 3.
- [307]Eurofer, *Update technique partial waste gas recycling*, Eurofer, 2007, p. 10.
- [308]Eurofer, *Update electrostatic precipitator*, Eurofer, 2007, p. 5.
- [309]Eurofer, *Update technique on fabric filters*, Eurofer, 2007, p. 6.
- [310]Eurofer, *Update information on cyclones*, Eurofer, 2007, p. 2.
- [311]Eurofer, *Update fine wet scrubber*, Eurofer, 2007, p. 5.
- [312]Dr. Michael Degner et al., *Steel Manual*, Steel Institute VDEh, Düsseldorf, 2008.
- [313]Eurofer, *Update wet desulphurisation*, Eurofer, 2007, p. 4.
- [314]Eurofer, *Update technique regenerative activated carbon*, Eurofer, 2007.
- [315]Van den Berg., et al, *Project for the re-evaluation of human and mammalian toxic equivalency factors for dioxins and dioxin-like compounds*, 2006.
- [316]Eurofer, 'Water and Waste Water Management in Integrated Steelworks', Personal Communication, 2009.
- [317]Endemann, G. et al, 'Dust, scale and sludge generation and utilisation in German steelworks', *Stahl und Eisen*, Vol. 126 Nr. 9, 2006.
- [318]Eurofer, *Review of the pelletisation chapter*, Eurofer, 2007, p. 21.
- [319]Eurofer, *Cold briquetting in pelletisation plants*, Eurofer, 2007, p. 2.
- [320]Eurofer, *Review of coke oven plants chapter*, 2007, p. 62.
- [321]Eurofer, *Review of coke handling and screening*, 2007, p. 1.
- [322]Eurofer, *Review of collection and treatment of COG with recovery of by-products*, 2007.
- [323]Eurofer, *Review of Mass stream overview of coke ovens*, 2007.
- [324]Eurofer, *Review of input/output data from coke oven plants in EU*, 2007, p. 1.
- [325]Eurofer, *Review of quantities of emissions to water from coke ovens*, 2007, p. 1.
- [326]Buchwalder, J. et al, 'Verminderung der Staubemissionen an der Sinteranlage von ArcelorMittal Eisenhüttenstadt', *Stahl und Eisen*, Vol. 126 Nr. 9, 2008.
- [327]Eurofer, *Review of waste water from wet oxidation desulphurisation process from coke ovens*, 2007, p. 1.
- [328]Eurofer, *Review of energy demand in coke ovens*, 2007, p. 1.
- [329]Eurofer, *New information on Pressure regulation in coke ovens*, 2007, p. 2.
- [330]Eurofer, *Review of maintenance of coke ovens*, 2007, p. 1.
- [331]Eurofer, *Review of improvement of oven door and frame seals*, 2007, p. 1.
- [332]Eurofer, *Review of cleaning of oven doors and frame seals*, 2007, p. 1.
- [333]Eurofer, *Review of emission reduction at coke oven firing*, 2007, p. 2.
- [334]Eurofer, *Review of quenching techniques for coke*, 2007, p. 3.
- [335]Eurofer, *Review of section on larger coke oven chambers*, 2007, p. 2.
- [336]Eurofer, *Review of non-recovery coking*, 2007, p. 3.
- [337]Eurofer, *Review of minimising oven charging emissions*, 2007, p. 2.
- [338]Eurofer, *Review section on minimising leakage between coke oven chamber and heating chamber*, 2007, p. 1.
- [339]Eurofer, *Review DeNOx of waste gas from coke oven firing*, 2007, p. 1.

References

- [340]Eurofer, *Review of removing tar from the coal water in coke ovens*, 2007, p. 1.
- [341]Eurofer, *Review of waste water treatment plant*, 2007, p. 4.
- [342]GWAA Bremen, *Messberichte: Emissionsmessungen im Abgas vor und nach Eisenerzsinteranlage*, 2005.
- [343]Eurofer, *Review of emerging techniques in the coke ovens*, 2007, p. 4.
- [344]Eurofer, *Review blast furnace chapter*, 2007, p. 20.
- [345]n.n., 'Euroslag Proceedings of the 3rd European Slag Conference', *Euroslag Proceedings of the 3rd European Slag Conference*, 2002, Nottingham.
- [346]Eurofer, *Review input/output tables of blast furnace chapter*, 2007.
- [347]Eurofer, *Review blast furnace slag processing*, 2007, p. 5.
- [348]Eurofer, *Review of technique direct injection of reducing agents in blast furnaces*, 2007, p. 5.
- [349]Eurofer, *New technique on direct injection in blast furnaces of used oils, fats and emulsions as reducing agents and of solid iron residues*, 2007, p. 3.
- [350]Eurofer, *Review of top gas pressure energy recovery in blast furnaces*, 2007, p. 2.
- [351]Eurofer, *Review technique on use of tar-free runner linings in blast furnaces*, 2007, p. 2.
- [352]Eurofer, *Review technique on blast furnace gas treatment*, 2007, p. 3.
- [353]Eurofer, *Review of technique on de-dusting of tapholes and runners and fume suppression during casting in blast furnaces*, 2007, p. 3.
- [354]Eurofer, *Review technique condensation of fume slag processing in blast furnaces*, 2007, p. 2.
- [355]Plickert, *Retrofitting the Waste Gas exhaustion system (2005-2007). First measurement results on dust and PCDD/PCDF emission*, 2007, p. 12.
- [356]Eurofer, *Review of the emerging technique section of the blast furnace chapter*, 2007, p. 3.
- [357]Germany, *Data for the review of table on pollutants load of waste water from blast furnace slag granulation*, 2007, p. 1.
- [358]Germany, *Review of the table on pollutant load of waste water discharged from blast furnace gas scrubbing water*, 2007, p. 1.
- [359]Netherlands, *Permit rule for an oxygen steel plant for roof emissions*, 2007, p. 1.
- [360]Sick-Maihak, 'FW300 Laser transmissiometer. Precise and instant measurement in harsh conditions', 2006, p. 2.
- [361]Sigmund, 'Fine dust - a challenge for Voestalpine', 2007, p. 13.
- [362]Germany, *Wastewater from continuous casting*, 2007, p. 1.
- [363]Eurofer, *Review of the Chapter on Basic oxygen steel making and casting (1)*, 2007, p. 73.
- [364]Fuchs, G., 'New Energy Saving Electric Arc Furnace Design', 2008.
- [365]Eurofer, *Eurofer comments on tables and figures of Chapter 8. BOF and continuous casting*, 2007, p. 12.
- [366]Dornseiffer et al., *Air and Noise Protection in Steelmaking Electric Arc Furnace in Luxembourg*, Ministere de l'environnement in Luxembourg, 2007, p. 10.
- [367]Prüm et al., 'Reducing dioxin emissions in electric steel mills', *MPT international*, Vol. 1, No 2005, 2005, pp. 36-42.
- [368]Prüm et al., 'Verringerung der dioxinmission bei elektrostahlwerken (Reducing dioxin emissions in electric steel mills)', *stahl und eisen*, Vol. 124 (2004) Nr. 10, 2004, pp. 61-67.
- [369]Eurofer, *Material flow stainless steel meltshop*, 2007, p. 1.
- [370]Öberg, 'Emissions of persistant organic pollutants from Swedish steel mills', 2007, p. 6.
- [371]Eurofer, *Update input/output data for electric arc furnaces*, Eurofer, 2007, p. 1.

- [372]Czech TWG member, Czech Republik comments on the first draft of the reviewed IS BREF, 2008.
- [373]Eurofer, *Review of the EAF chapter of the current BREF*, Eurofer, 2007, p. 42.
- [374]Eisen, H.-P. et al, 'Construction of the exhaust recycling facilities at a sintering plant', *Stahl und Eisen*, Vol. 124 Nr. 5, 2004.
- [375]IISI, *Energy Use in the Steel industry*, 1998, p. 120.
- [376]Eurofer, *Review of dust composition from EAF*, 2007, p. 1.
- [377]Heidenreich et al., 'Catalytic filter elements for combined particle separation and nitrogen oxides removal from gas streams', 2007, p. 9.
- [378]Eurofer, *ULCOS project. CO₂ and air emissions*, Eurofer, 2007, p. 5.
- [379]Corus IJmuiden, *Biological Treatment Plant - Corus IJmuiden*, 2010.
- [380]Voestalpine Linz, *Emission measurement pure gas sinter belt 5 - hydrogen cyanide content*, Voestalpine Linz, 2008.
- [381]Pall, 'Pall gas solid separation systems', 2006, p. 16.
- [382]Linz, 'Emission data for the sinter plant provided for the Voestalpine steelworks in Linz for the year 2008 and 2009', Personal Communication, 2008.
- [383]EIPPCB, *Alternative techniques for Iron and steel production*, 2006, p. 6.
- [384]Max-Planck-Institut et al., *The formation and prevention of scale during twin roller strip casting*, 2002, p. 131.
- [385]Malmberg et al., *Online slag analysis utilising contact-free microwave technology*, 2005, p. 71.
- [386]Cores et al., *Efficient utilisation of raw materials used in secondary steelmaking as flux in steelmaking furnaces*, 2005, p. 89.
- [387]Fisher et al., *Influence of sinter mix materials on the environmental impact of high productivity iron ore sintering*, 2005, p. 101.
- [388]Fisher et al., *Effects of operational factors on the formation of toxic organic micropollutants in EAF steelmaking*, 2005, p. 154.
- [389]Briggs et al., *Reductions in dust and gaseous emissions from sinter strands*, 2004, p. 166.
- [390]Atkinson et al., *Injectant coal gasification, char formation and char utilisation at high injection rates*, 2004, p. 193.
- [391]Tavernier et al., *Foaming of the slag and recycling of stainless steel dusts by injection into the electric arc furnace for stainless steels*, 2004, p. 92.
- [392]Schmidt et al., *Optimised blast furnace slag water quenching with sulphur compounds control*, 2003, p. 149.
- [393]Turpin et al., 'Effects of flattening the stockpile crest and of the presence of buildings on dust emissions from industrial open storage systems', *XVIIth International Conference of Modelling, Monitoring and Management of Air Pollution*, 2009.
- [394]Colletta et al., *High-purity zinc and ferroalloy recovery from EAF dusts through a combined pyro-metallurgical treatment*, 2002, p. 76.
- [395]Badr et al., 'Effect of aggregate storage piles configuration on dust emissions', *Atmospheric Environment*, Vol. Vol. 41, 2007, pp. p. 360 - 368.
- [396]Reg. 1221/, REGULATION (EC) No 1221/2009 of the European Parliament and the Council of 25 November 2009 on the voluntary participation by organisations in a Community eco-management and audit scheme (EMAS), repealing Regulation (EC) No 761/2001 and Commission Decisions 2001/681/EC and 2006/193/EC., 2009.
- [397]DG Environment, What is EMAS? http://ec.europa.eu/environment/emas/index_en.htm, 2010.
- [398]ISO, ISO 14001: 2004 http://www.iso.org/iso/iso_14000_essentials.htm, 2004.

GLOSSARY

This glossary is meant to facilitate the understanding of the information contained in this BREF. The definitions of terms in this glossary are not legal definitions (even if some of them may coincide with definitions given in European legislations), they are meant to help the reader understand some key terms in the context of their use in the specific sector covered by this BREF.

This glossary is divided up into the following sections:

- I. General considerations
- II. Monetary units
- III. ISO country codes
- IV. Unit prefixes
- V. Units
- VI. Chemical elements
- VII. Acronyms and technical definitions

I. General considerations

EXPRESSION OF EMISSIONS

In this BREF emissions to air are expressed as either:

- mass of emitted substances per volume of waste gas under standard conditions (273.15 K, 101.3 kPa), after deduction of water vapour content, expressed in the units g/Nm³, mg/Nm³, µg/Nm³ or ng/Nm³ or
- mass of emitted substances related to time, expressed in the units kg/h and g/h or
- mass of emitted substances per unit of mass of products generated or processed (consumption or emission factors), expressed in the units kg/t, g/t, mg/t, µg/t or ng/t.

and emissions to water are expressed as:

- mass of emitted substances per volume of waste water, expressed in the units g/l, mg/l or µg/l.

II. Monetary units

Code ⁽¹⁾	Country/territory	Currency
Member State currencies		
EUR	Euro area ⁽²⁾	euro (pl. euros)
ECU	European currency unit	ECU (replaced by EUR)
GBP	United Kingdom	pound sterling (inv.)
Other currencies		
USD	United States ⁽³⁾	US dollar
⁽¹⁾ ISO 4217 codes. ⁽²⁾ Includes Austria, Belgium, Cyprus, Estonia, Finland, France, Germany, Greece, Ireland, Italy, Luxembourg, Malta, the Netherlands, Portugal, Slovakia, Slovenia, Spain. ⁽³⁾ Also American Samoa, British Virgin Islands, East Timor, Ecuador, Guam, Marshall Islands, Micronesia, Northern Marianas, Palau, Puerto Rico, Turks and Caicos Islands, United States Minor Outlying Islands, and the US Virgin Islands.		

III. ISO country codes

ISO code	Country
<i>Member States</i> (°)	
BE	Belgium
DK	Denmark
DE	Germany
ES	Spain
FR	France
LU	Luxembourg
NL	Netherlands
AT	Austria
SE	Slovenia
SK	Slovakia
FI	Finland
UK	United Kingdom
<i>Non-member countries</i>	
US	United States
(°) The protocol order of the Member States is based on the alphabetical order of their geographical names in the original language(s).	

IV. Unit prefixes

Symbol	Prefix	Term	Number
T	tera	10^{12}	1 000 000 000 000
G	giga	10^9	1 000 000 000
M	mega	10^6	1 000 000
k	kilo	10^3	1000
h	hecto	10^2	100
da	deca	10^1	10
-----	-----	1 unit	1
d	deci	10^{-1}	0.1
c	centi	10^{-2}	0.01
m	milli	10^{-3}	0.001
μ	micro	10^{-6}	0.000 001
n	nano	10^{-9}	0.000 000 001

V. Units

Term	Meaning
kWh	kilowatt-hours
billion	thousand million (10^9)
°C	degree Celsius
cm	centimetre
d	day
g	gram
GWh	gigawatt hours
h	hour
hPa	hectopascals
J	joule
K	kelvin ($0\text{ °C} = 273.15\text{ K}$)
kcal	kilocalorie ($1\text{ kcal} = 4.19\text{ kJ}$)
k	kilowatt
kWh	kilowatt-hour ($1\text{ kWh} = 3.6\text{ MJ}$)
l	litre

Term	Meaning
m	metre
Mt	megatonne
MW _e	megawatts electric (energy)
MW	megawatt
Nm ³	normal cubic metre (at 101.325 kPa, 273 K)
ppb	parts per billion (1 ppb = 10 ⁻⁹)
ppm	parts per million (1 ppm = 10 ⁻⁶)
ppmv	parts per million (by volume)
s	second
t	metric tonne (1000 kg or 10 ⁶ g)
t/d	tonnes per day
trillion	million million (10 ¹²)
t/yr	tonnes per year
vol-%	percentage by volume
wt-%	percentage by weight
W	watt (1 W = 1 J/s)
yr	year
µg	microgram
µm	micrometre (1 µm = 10 ⁻⁶ m)
µs	microsiemens
Ω	ohm, unit of electrical resistance

VI. Chemical elements

Symbol	Name	Symbol	Name
Al	Aluminium	N	Nitrogen
As	Arsenic	Na	Sodium
C	Carbon	Ni	Nickel
Ca	Calcium	O	Oxygen
Cd	Cadmium	P	Phosphorus
Cl	Chlorine	Pb	Lead
Cm	Curium	Pt	Platinum
Co	Cobalt	S	Sulphur
Cr	Chromium	Sb	Antimony
Cu	Copper	Se	Selenium
F	Fluorine	Si	Silicon
Fe	Iron	Sn	Tin
H	Hydrogen	Te	Tellurium
Hg	Mercury	Ti	Titanium
K	Potassium	V	Vanadium
Mg	Magnesium	W	Tungsten
Mn	Manganese	Zn	Zinc
Mo	Molybdenum		

VII. Acronyms and definitions

Acronym	Definition
AC	Alternating current
AISI	American Iron and Steel Institute
AOD	Argon oxygen decarburisation
AOX	Absorbable organically bound halogens in water
AS	Activated sludge
ASK	Ammoniumsulphide Kreislaufwäscher
BaP	Benzo(a)pyrene
BF	Blast furnace
BOD	Biochemical oxygen demand
BOF	Basic oxygen furnace
Borneff 6	Sum of six PAH (Fluoranthene, Benzo[b]fluoranthene, Benzo[k]fluoranthene, Benzo[a]pyrene, Indeno[1,2,3-cd]pyrene and Benzo[g,h,i]perylene)
Bq	Bequerel
BTX	Benzene, Toluene, Xylene
c.	circa
CAS	Chemical abstracts service
CAS-OB	Composition adjustment by sealed argon bubbling
CCF	Cyclone converter furnace
CCGT	Combined cycle gas turbine
CCM	Continuous casting machine
CCPP	Combined cycle power plant
CCS	Carbon capture and storage
CDQ	Coke dry quenching
CEN	European committee for standardisation
CFD	Computational fluid dynamics
CHP	Combined heat and power
COD	Chemical oxygen demand
COG	Coke oven gas
COS	Carbon oxysulphide
CRI	Coke reactivity index
CSQ	Coke stabilisation quenching
CSR	Coke strength after reaction
CV	Calorific value
DAV	Daily average
dBA	A-weighted decibels
DC	Direct current
DCI	Direct carbon injection
DH	Dortmund-Hörder
Diffuse emission	Diffuse emissions occur during regular operation such as coal and coke handling, transport of coal and coke, coal blending beds, ascension pipes, coke pushing, coke quenching; if not captured they can be released by the roof, roof-hatch, window or from stored material. Minimisation is possible only by prevention and/or further treatment after transferring them into ducted emissions (i.e. by capturing them)
DIOS	Direct iron ore smelting reduction
DOC	Dissolved organic carbon
DR	Direct reduction
DRI	Direct reduced iron
DSC	Direct strip casting
DSI	Direct sample induction
EAF	Electric arc furnace
ECO	Economiser
ECSC	European Union for Coal and Steel
ECU	European Currency Unit
EINECS	European inventory of existing commercial chemical substances
ELPI	Electrical low pressure impactor
ELV	Emission limit value

Acronym	Definition
EMS	Environmental management system
EMAS	Eco-Management and Audit Scheme
EN ISO 14001	European norm (EN) published by the International Organisation for Standardisation (ISO) concerning environmental management standards.
EOF	Energy optimised furnace
EOS	Emission optimised sintering
EPA	Environmental Protection Agency (US)
ESP	Electrostatic precipitator
ESCS	Electrostatic space cleaner super
ETP	Electrostatic tar precipitator
EU-10	Cyprus, Czech Republic, Estonia, Hungary, Latvia, Lithuania, Malta, Poland, Slovakia and Slovenia
EU-15	Austria, Belgium, Denmark, Finland, France, Germany, Greece, Ireland, Italy, Luxembourg, the Netherlands, Portugal, Spain, Sweden and the United Kingdom
EU-25	EU-10 + EU-15: Austria, Belgium, Cyprus, Czech Republic, Denmark, Estonia, Finland, France, Germany, Greece, Hungary, Ireland, Italy, Latvia, Lithuania, Luxembourg, Malta, the Netherlands, Poland, Portugal, Slovakia, Slovenia, Spain, Sweden and the United Kingdom
EU-27	Austria, Belgium, Bulgaria, Cyprus, Czech Republic, Denmark, Estonia, Finland, France, Germany, Greece, Hungary, Ireland, Italy, Latvia, Lithuania, Luxembourg, Malta, the Netherlands, Poland, Portugal, Romania, Slovakia, Slovenia, Spain, Sweden and the United Kingdom
FF	Fabric filter
Fine dust	Fine dust in the sense of this BREF shall mean fine particulate matter smaller than 10 micrometer
Fugitive emissions	Fugitive emissions happen during irregular operation from leakages at the battery, e.g. because of leakage of vessels, oven doors, flanges etc. or at the by-product plant. For minimisation the first option is prevention by good maintenance. PAH compounds, like benzo(a)pyrene (BaP), and benzene play an important role with regard to fugitive emissions
FTIR	Fourier transform infrared spectroscopy
GSA	Gas suspension absorber
HBI	Hot briquetted Iron
HCB	Hexachlorobenzene
HHAV	Half-hourly average
HM	Hot metal
hPa	Hectopascals
IISI	International Iron and Steel Institute
I-TEQ	International Toxicity Equivalents
IUPAC	International Union of Pure and Applied Chemistry
KOBM	Klöckner Oxygen Blowing Maximillanshuette
kW	Kilowatt
LD	Linz-Donawitz
LD-AC	Linz-Donawitz-Arbed-CRM process
LEEP	Low emission and energy optimised sintering process
Leq	Equivalent Continuous Sound Level
LIBS	Laser-induced breakdown spectroscopy
LIDAR	Light detection and ranging
LPG	Liquefied petroleum gas
LS	Liquid steel
LTE	lance tuyère equilibrium
L_{WA}	weighted sound power level
LWS	Loire-Wendel-Sprunck process
MEA	Monoethanolamine
MEEP	Moving electrodes Electrostatic Precipitator
MEROS	Maximised emission reduction of sintering
MHF	Multiple hearth furnace
MLSS	Mixed liquor suspended solids

Acronym	Definition
NG	Natural gas
NM VOC	Non-methane volatile organic compounds
OBM	Oxygen-bottom Maxhuette process
OCP	Open circuit process
PAH	Polycyclic aromatic hydrocarbons
PCB	Polychlorinated biphenyls
PCDD/F	Polychlorinated dibenzo-p-dioxins/dibenofurans
PCI	Pulverised coal injection
PLC	Programmable Logic Controllers
PM ₁₀ , PM _{2.5}	Particulate matter smaller than 10 or 2.5 micrometer according to the definition of the Directive 2008/50/EC on air quality
POM	Polycyclic organic matter
POPs	Persistent organic pollutants
PTFE	Polytetrafluoroethylene
Q-BOP	Oxygen-bottom Maxhuette process
RAC	Regenerative activated carbon
RAFT	Raceway adiabatic flame temperature
RDM	Reverse dispersion modelling
RH	Ruhrstahl-Heraeus
RHF	Rotary hearth furnace
SCN	Thiocyanate
SCOPE 21	Super coke oven for productivity and environment enhancement in the 21 st century
SCR	Selective catalytic reduction
SI	Shatter index
SR	Smelting reduction
SRF	Smelting reduction furnace
SS	Suspended solids
STP	Standard temperature and pressure
TEA	Triethanolamine
TEQ	Toxic equivalent quantity
TEF	Toxic equivalent factor
TBM	Thyssen blowing metallurgy process
TOC	Total organic carbon
TWG	Technical working group
UHP	Ultra high power operation
ULCOS	Ultra Low CO ₂ Steelmaking. EC funding research programme to reduce CO ₂ emissions from steelmaking.
VDI	Verein Deutscher Ingenieure
VOC	Volatile organic compounds
VOD	Vacuum oxygen decarburisation
w.c.	Water column
Wobbe index	The Wobbe Index (WI) is an indicator of the interchangeability of fuel gases such as natural gas, liquefied petroleum gas (LPG), and Town Gas and is frequently defined in the specifications of gas supply and transport utilities. If V_C is the higher heating value, or calorific value, and G_S is the specific gravity, the Wobbe Index, I_W , is defined as: $I_W = V_C/(G_S)^{1/2}$
WWT	Waste water Treatment Plant
WHO TEFs	World Health Organisation toxic equivalent factors. This toxic equivalency factor (TEF) value is the only one for currently taking into account not only PCDD and PCDF values but 'dioxin-like' PCB [219, Van den Berg et al. 1998]

13 ANNEXES

13.1 Annex I. Determination of some environmentally sensitive elements in waste water

[208, Lindfors et al. 2006]

Description

The waste water sample is preserved with nitric acid and digested in a microwave oven to dissolve residues. The solution is preconcentrated in an ultrasonic nebuliser and nebulised into an inductively coupled plasma optical emission spectroscopy (ICP-OES) where the intensities of the emitted light of the elements are measured. As an internal standard Sc and Te are used. The calibration is performed on a matrix which contains Milli-Q water with the addition of reference solutions. The following elements are determined simultaneously:

Al, Cd, Co, Cr, Cu, Fe, Mn, Mo, Ni, P, Pb, V, Zn.

Achieved environmental benefits

The procedure is capable of determining levels below the legislation requirements of today. The detection limits for some environmentally sensitive elements in waste water

Table 13.1: Detection limits for some environmentally sensitive elements in waste water

Parameter	Detection limit (µg/l)
Al	2
Cd	0.03
Co	0.2
Cr	0.1
Cu	0.6
Fe	0.1
Mn	0.03
Mo	0.2
Ni	0.2
P	1.8
Pb	0.6
V	0.6
Zn	0.06

This technique can be considered a quick and efficient technique using standard equipment. The time from observation of increased levels to corrective actions is relatively short.

Cross-media effects

No data submitted.

Operational data

No data submitted.

Applicability

Water from different sources can be monitored, e.g. waste water, drinking water.

Driving force for implementation

The driving force for implementation is to comply with national and European legislation.

Economics

No data submitted.

Reference plant

Sandvik Materials Technology, Sandviken, Sweden.

13.2 Annex II. Dioxin emissions

[209, EC 2005]

Major factors influencing dioxin formation are:

- the process feed (raw materials)
- the type of metallurgical process
- the process operating conditions, in particular combustion quality
- the off-gas cooling conditions, in particular the presence of a boiler or other heat exchangers
- the type of off-gas treatment systems
- memory effects. Pipes and heat exchangers may store extensive deposits, enhancing emissions and also the evolution of dioxin with time.

PCDD/F and other POPs

It is important to take into consideration that both PCDD/F are always accompanied by a host of other compounds surviving combustion, e.g. benzene, alkylbenzenes, naphthalene, phenanthrene, anthracene, furan, benzofuran, dibenzofuran, and many other aliphatic and cyclic compounds. Their sheer number is a complicating factor in analytical procedures. In [209, EC 2005], only limited attention is devoted to these compounds, but their potential role as surrogates and precursors is highlighted. It has adequately been shown that the dibenzo-p-dioxin (DD) structure is easily synthesised from two molecules of phenol. The same holds for their chlorinated congeners. Similarly, the polychlorinated dibenzofuran (DF) structure is easily created by a mild oxidation of PCB. Thus, both chlorophenols and PCB are potential precursors for PCDD/F formation. Some of these compounds are relevant as POPs in their own right, such as:

- hexachlorobenzene
- PCB
- polychlorinated naphthalenes.

Pathways of emissions of PCDD/F

PCDD/F, or indeed almost any pollutant, may either occur as emissions to air, water, and soil, or arise as waste streams to be eliminated or recycled.

Emissions of PCDD/F from the metallurgical industry may assume different forms, such as:

- off-gases, occurring in guided stack emissions
- off-gases, occurring as diffuse emissions
- waste water and sludge
- residues
- commercial products.

Monitoring

Modes of PCDD/F monitoring found in the EU are given in Table 13.2.

Table 13.2: Monitoring modes of PCDD/F

Type	Monitoring frequencies	Period for measurement	Units
Regular	1 per month	1 day 3 days 1 week	TEQ values I-TEQ values (17 congeners) 5 PCDD + 5 PCDF Fingerprint
Occasional (monitoring only at some installations of the sector)	6 per year		
	3 per year		
Voluntary (e.g. sector agreement)	2 per year		
	1 per year		
	1 every 3 – 6 years		

Source: [209, EC 2005].

Measurement methods

Some measurement method examples can be found in the report [209, EC 2005].

13.3 Annex III. WHO-12 PCB

Polychlorinated biphenyls (PCB) are a class of chlorinated semi-volatile organic compounds composed of 209 congeners. Numbering of congeners in the EUROFER data request follows the convention adopted by the International Union of Pure and Applied Chemists (IUPAC). Figure 13.1 illustrates the IUPAC numbering system as well as the nomenclature of positional chlorinated substitution. A group of 12 PCB, which exhibit 'dioxin-like' behaviour, has been identified by the World Health Organisation (WHO) and the individual members of the group have been assigned toxic equivalency factors (TEFs) relative to that of 2,3,7,8-tetrachlorodibenzo-p-dioxin. The TEFs allow these 'WHO-12 PCB' to be included as part of the overall dioxin WHO-TEQ concentration in process emissions and other environmental samples. In the data collected by EUROFER, the PCDD/F data were requested in the more usual I-TEQ unit so do not include PCB data and a clear distinction can be made between the two groups of compounds and comparisons made with past PCDD/F data. It is anticipated that the use of the WHO-TEQ will increase in the future.

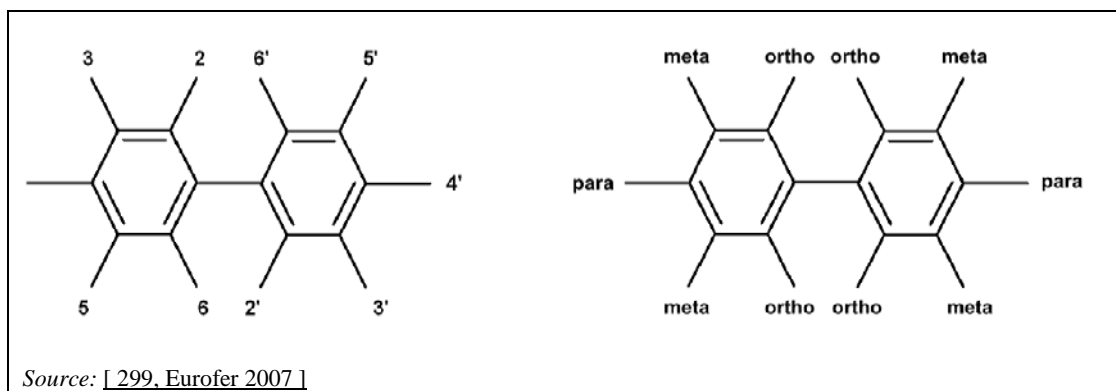

Figure 13.1: IUPAC numbering system and positional nomenclature of PCB

A list of the TEFs for the WHO-12 PCB is provided in Table 13.3.

Table 13.3: Table of toxic equivalency factors for WHO-12 PCB congeners

IUPAC No	Type	Structure	WHO-TEF
77	Non-ortho	3,3',4,4' TeCB	0.0001
81		3,4,4',5TeCB	0.0001
126		3,3',4,4',5PeB	0.1
169		3,3',4,4',5,5'HxCB	0.01
105	Mono-ortho	2,3,4,4',5 PeCB	0.0005
114		2,3,4,4',5PeCB	0.0005
118		2,3',4,4',5PeCB	0.0001
123		2',3,4,4',5PeCB	0.0001
156		2,3,3',4,4',5HxCB	0.0005
157		2,3,3',4,4',5'HxCB	0.0005
167		2,3',4,4',5,5'HpCB	0.00001
189		2,3,3',4,4',5,5'HpCB	0.0001

Source: [299, Eurofer 2007].

13.4 Annex IV. Example of mass flow thresholds for continuous monitoring

[236, Germany 2002]

Facilities with particles mass flows of 1 to 3 kg/h shall be equipped with measuring instruments at their relevant sources which are capable of continuously monitoring the functioning of the waste gas purification facility and the established emission limits (qualitative measuring instruments).

Facilities with particles mass flows of over 3 kg/h shall be equipped with measuring instruments at their relevant sources which continuously determine dust emission mass concentrations.

Facilities with dust emissions of substances under Sections 5.2.2 or 5.2.5 Class I or 5.2.7 of the Technical Instructions on Air (TA Luft) [236, Germany 2002] shall be equipped with measuring instruments at their relevant sources which continuously determine the total particles concentrations if the emission mass flow is more than five times greater than one of the relevant mass flows.

At facilities emitting gaseous substances in excess of the following mass flows, relevant sources shall be equipped with measuring instruments which continuously determine the mass concentrations of the respective substances:

- sulphur dioxide: 30 kg/h
- nitrogen monoxide and nitrogen dioxide, to be indicated as nitrogen dioxide: 30 kg/h
- carbon monoxide as lead substance for evaluating the efficiency of combustion processes: 5 kg/h
- carbon monoxide, all other cases: 100 kg/h
- fluorine and gaseous inorganic fluorine compounds, to be indicated as hydrogen fluoride: 0.3 kg/h
- gaseous inorganic chlorine compounds, to be indicated as hydrogen chloride: 1.5 kg/h
- chlorine: 0.3 kg/h
- hydrogen sulphide: 0.3 kg/h.

If sulphur dioxide mass concentrations are measured continuously, sulphur trioxide mass concentrations shall be determined during calibration and included in the calculation. If individual measurements show that nitrogen dioxide proportions in the nitrogen oxide emissions account for less than 10 per cent, the continuous measuring of nitrogen dioxide shall be waived and its proportion be calculated.

Facilities with mass flows of organic substances, to be indicated as total carbon, exceeding for:

- substances under Section 5.2.5 Class I: 1 kg/h
- substances under Section 5.2.5: 2.5 kg/h

shall be equipped with measuring instruments at their relevant sources which continuously determine the total carbon.

Facilities with mass flows of mercury and its compounds of over 2.5 g/h, to be indicated as Hg, shall be equipped with measuring instruments at their relevant sources which continuously determine mercury mass concentrations, unless it has been reliably proven that the mass concentrations are less than 20 per cent of those specified in Section 5.2.2 Class I.

The competent authority shall require facilities emitting substances listed under Section 5.2.2 Classes I and II or substances listed under Section 5.2.7 to be equipped with continuous measuring instruments to determine the mass concentrations if the mass flow exceeds one of the respective mass flows over five times and if suitable measuring instruments are available.

13.5 Annex V. Example of template for compiling environmental data in the iron and steel sector

Table 13.4: Example of template for compiling environmental data in the IS sector

Company											
Unit/Location											
Type of installation											
Build date									Last modernisation date		
Resources/Energy			Products/By-products			Emission/Wastes					
Name	Units	Usage	Name	Units	Quantity	Name	Units	Quantity	Name	Units	Quantity
Raw materials			Products			Emission			Dust		
Coal/Anthracite			Coke			Dust (total)			Fe (total)	wt-%	
Coke			Sinter			SO ₂			SiO ₂	wt-%	
Iron ore			Hot metal			NO _x			CaO	wt-%	
Pellets			Liquid steel			CO			Al ₂ O ₃	wt-%	
Lime			Ingots			CO ₂			MgO	wt-%	
Dolomite			Production residues			Benzene			P ₂ O ₅	wt-%	
Sinter			By-products			Benzo(a)pyrene			MnO	wt-%	
Pig iron			Benzene			Pyridine			Cr ₂ O ₃	wt-%	
Scrap			Tar			Toluene			Na ₂ O	wt-%	
Liquid steel			Sodium phenolate			Xylene			K ₂ O	wt-%	
Metallic charge			Ammonium sulphate			Tar			Zn	wt-%	
Alloys			Granulated/air-cooled slag			F (HF)			Pb	wt-%	
Non-metallic compounds						Cl (HCl)			Cd	wt-%	
Others			Iron sulphate			Phenol			Cu	wt-%	
Energy			Iron oxide			Methane			Ni	wt-%	
Natural gas			Solid wastes			HCN			V	wt-%	
Electricity			BF slag			H ₂ S			Co	wt-%	
Water			BOF slag			Ammonium			As	wt-%	
Technological steam			Energetic ash & slag			CS ₂			Hg	wt-%	
Coke gas			Ferrous sludge			NaOH			Cl	wt-%	
BF gas			Refractories			H ₂ SO ₄			F	wt-%	
Oxygen			Sulphur			PCDD/F			S	wt-%	
Oxygen (liquid)			Dust			Non-channelled emission			C	wt-%	
Argon									Basicity	pH	
Nitrogen									Moisture	wt-%	
Nitrogen (in bottles)											
Hydrogen											
Compressed air											
BF blast											
Acetylene											
Other technical gases											

European Commission

EUR 25521 – Joint Research Centre – Institute for Prospective Technological Studies

Title: Best Available Techniques (BAT) Reference Document for Iron and Steel Production

Author(s): Rainer Remus, Miguel A. Aguado-Monsonet, Serge Roudier, Luis Delgado Sancho

Luxembourg: Publications Office of the European Union

2013 – 621 pp. – 21.0 x 29.7 cm

EUR – Scientific and Technical Research series – ISSN 1831-9424 (online), ISSN 1018-5593 (print),

ISBN 978-92-79-26475-7 (pdf)

ISBN 978-92-79-26476-4 (print)

doi:10.2791/97469

Abstract

The BREF entitled 'Iron and Steel Production' forms part of a series presenting the results of an exchange of information between EU Member States, the industries concerned, nongovernmental organisations promoting environmental protection and the Commission, to draw up, review, and where necessary, update BAT reference documents as required by Article 13(1) of the Directive. This document is published by the European Commission pursuant to Article 13(6) of the Directive. This BREF for the iron and steel production industry covers the following specified in Annex I to Directive 2010/75/EU, namely:

- activity 1.3: coke production
- activity 2.1: metal ore (including sulphide ore) roasting and sintering
- activity 2.2: production of pig iron or steel (primary or secondary fusion) including continuous casting, with a capacity exceeding 2.5 tonnes per hour.

The document also covers some activities that may be directly associated to these activities on the same site. Important issues for the implementation of Directive 2010/75/EU in the production of iron and steel are the reduction of emissions to air; efficient energy and raw material usage; minimisation, recovery and the recycling of process residues; as well as effective environmental and energy management systems.

The BREF document contains 13 chapters. Chapter 1 provides general information on the iron and steel sector. Chapter 2 provides information and data on general industrial processes used within this sector. Chapters 3 to 8 provide information on particular iron and steel processes (sinter plants, pelletisation, coke ovens, blast furnaces, basic oxygen steelmaking and casting electric arc steelmaking and casting). In Chapter 9 the BAT conclusions, as defined in Article 3(12) of the Directive, are presented for the sectors described in Chapters 2 to 8.

As the Commission's in-house science service, the Joint Research Centre's mission is to provide EU policies with independent, evidence-based scientific and technical support throughout the whole policy cycle.

Working in close cooperation with policy Directorates-General, the JRC addresses key societal challenges while stimulating innovation through developing new standards, methods and tools, and sharing and transferring its know-how to the Member States and international community.

Key policy areas include: environment and climate change; energy and transport; agriculture and food security; health and consumer protection; information society and digital agenda; safety and security including nuclear; all supported through a cross-cutting and multi-disciplinary approach.