



EUROPEAN COMMISSION

Reference Document on
Best Available Techniques for

Management of Tailings and Waste-Rock in Mining Activities

January 2009

This document is one from the series of documents as listed below, which have to be reviewed:

Reference Document on Best Available Techniques . . .	Code
Large Combustion Plants	LCP
Mineral Oil and Gas Refineries	REF
Production of Iron and Steel	I&S
Ferrous Metals Processing Industry	FMP
Non Ferrous Metals Industries	NFM
Smitheries and Foundries Industry	SF
Surface Treatment of Metals and Plastics	STM
Cement, Lime and Magnesium Oxide Manufacturing Industries	CLM
Glass Manufacturing Industry	GLS
Ceramic Manufacturing Industry	CER
Large Volume Organic Chemical Industry	LVOC
Manufacture of Organic Fine Chemicals	OFC
Production of Polymers	POL
Chlor - Alkali Manufacturing Industry	CAK
Large Volume Inorganic Chemicals – Ammonia, Acids and Fertilisers Industries	LVIC-AAF
Large Volume Inorganic Chemicals – Solid and Others industry	LVIC-S
Production of Speciality Inorganic Chemicals	SIC
Common Waste Water and Waste Gas Treatment/Management Systems in the Chemical Sector	CWW
Waste Treatments Industries	WT
Waste Incineration	WI
<i>Management of Tailings and Waste-Rock in Mining Activities</i>	<i>MTWR</i>
Pulp and Paper Industry	PP
Textiles Industry	TXT
Tanning of Hides and Skins	TAN
Slaughterhouses and Animals By-products Industries	SA
Food, Drink and Milk Industries	FDM
Intensive Rearing of Poultry and Pigs	IRPP
Surface Treatment Using Organic Solvents	STS
Industrial Cooling Systems	ICS
Emissions from Storage	EFS
Energy Efficiency	ENE
Reference Document . . .	
General Principles of Monitoring	MON
Economics and Cross-Media Effects	ECM

Electronic versions of draft and finalised documents are publicly available and can be downloaded from <http://eippcb.jrc.ec.europa.eu>.

EXECUTIVE SUMMARY

Scope of this work

This work covers activities related to tailings and waste-rock management of ores that have the potential for a significant environmental impact. In particular the work sought out activities that can be considered as examples of “good practice”. Mining techniques and mineral processing are only covered as relevant to tailings and waste-rock management. The intention is to raise awareness of such practices and promote their use across all activities in this sector.

The starting point for the work and the actual development of this document is the Communication from the European Commission COM(2000) 664 on the ‘Safe Operation of Mining Activities’. As a follow-up to the tailings dam bursts in Aznalcollar and Baia Mare this Communication proposed a follow-up action plan to be taken, which includes the elaboration of a BAT Reference Document based on an exchange of information between the European Union’s Member States and the mining industry. This document is the result of this information exchange. It has been developed as a Commission initiative and in anticipation of the proposed Directive on the management of waste from extractive industries¹.

The above-mentioned failures have brought public attention to the management of tailings ponds and tailings dams. However, it should not be forgotten that the collapse of tailings and waste-rock heaps can also cause severe environmental damage. The dimensions of either type of facility can be enormous. Dams can be tens of metres high, heaps even more than 100 m high and several kilometres long possibly containing hundreds of millions of cubic metres of tailings or waste-rock. According to the Eurostat yearbook 2003² more than 300 million tonnes of mining and quarrying waste is estimated to be generated annually in the EU-15.

The following metals are covered in this document on the basis that they are mined and/or processed in the European Union (EU-15), the acceding countries, the candidate countries and Turkey, i.e.:

- aluminium
- cadmium
- chromium
- copper
- gold
- iron
- lead
- manganese
- mercury
- nickel
- silver
- tin
- tungsten
- zinc.

These metals are all covered in this document, irrespective of the amounts produced or the mineral processing method used (e.g. whether mechanical methods, flotation, chemical, or hydrometallurgical methods such as leaching).

¹) COM(2003) 319 final, 2.6.2003. The proposed Directive includes references to BAT in its articles 4(2), 19(2) and 19(3)

²) Eurostat yearbook 2003, A statistical guide to Europe, 8th Edition, Eurostat, the Statistical Office of the European Communities, Luxembourg

Coal and selected industrial minerals, are also covered in this document.i.e.:

- barytes
- borate
- feldspar (if recovered by flotation)
- fluorspar
- kaolin (if recovered by flotation)
- limestone (if processed)
- phosphate
- potash
- strontium
- talc (if recovered by flotation).

Coal is only included when it is processed and there are tailings produced (thereby following the above-mentioned theme). Generally, this means that hard coal (or rock coal or black coal) is covered, whereas lignite (or brown coal), which is usually not processed, is not covered.

Oil shale is processed in Estonia and large amounts of tailings result and need to be managed. Therefore, it was also decided to include this in the document. However, as no relevant information was provided on this subject, oil shale issues are not addressed in this document.

Also this document does not address:

- abandoned sites, although, some examples of recently closed sites are discussed
- mining, processing and tailings management associated with the mining of gas and liquids (e.g. oil and salt from brine).

For all minerals defined in the previously mentioned scope, the document:

- looks at waste-rock management
- includes mineral processing relevant to tailings management (e.g. when the mineral processing influences the characteristics and behaviour of the tailings)
- focuses on tailings management, e.g. in ponds/dams, heaps or as backfill
- includes topsoil and overburden if they are used in the management of tailings.

The mining industry

The purpose of mining is to meet the demand for metals and minerals resources to develop infrastructure, etc. and to improve the quality of life of the population, as the extracted substances are in many cases the raw materials for the manufacture of many goods and materials. These include, for example, metalliferous minerals or metals, coal, or industrial minerals used in the chemical sector or for construction purposes, etc.

The products of the mining industry are sometimes used directly, but often are further refined, e.g. in smelters.

Typical process steps at any mining operation are extraction, followed by mineral processing and finally shipment of the products and management of the residues.

For most metalliferous ores, European mining production is small compared to the overall world production (e.g. gold: 1 %, copper: 7 %), and similarly for coal mining (6 %). In contrast to the mostly declining production figures in the metal and coal mining sectors, the production of many industrial minerals has been expanding steadily on a European scale. In the case of most industrial minerals, the European production presents a major fraction of the world production (e.g. feldspar: 64 %, potash: 20 %).

Some parts of the mining industry, such as metal and coal mining within Europe, operate under severe economic conditions, mainly because the deposits can no longer compete on an international level. The EU metal sector is also struggling from the difficulty of trying to find new profitable ores in known geological regions. However, despite the reduced mine production in these areas, consumption is steadily increasing. Therefore, to meet this demand imports into Europe are on the increase.

The size of the companies involved in this sector varies significantly, from a handful of employees to several thousand per site. Ownership varies between international companies, industrial holding groups, stand-alone public companies and private companies.

The management of tailings and waste-rock

The management of the residues generated at mining operations, and, of special concern in this document, the tailings and waste-rock, typically presents an undesired financial burden on operators. Typically the mine and the mineral processing plant are designed to extract as much marketable product(s) as possible, and the residue and overall environmental management is then designed as a consequence of the applied process steps.

There are many options for managing tailings and waste-rock. The most common methods are:

- discarding slurried tailings into ponds
- backfilling tailings or waste-rock into underground mines or open pits or using them for the construction of tailings dams
- dumping more or less dry tailings or waste-rock onto heaps or hill sides
- using the tailings and waste-rock as a product for land use, e.g. as aggregates, or for restoration
- dry-stacking of thickened tailings
- discarding tailings into surface water (e.g. sea, lake, river) or groundwater.

Tailings and waste-rock management facilities vary vastly in size, e.g. from swimming-pool-sized tailings ponds to ponds of over 1000 hectares, and from small tailings or waste-rock piles to waste-rock areas of several hundred hectares or tailings heaps over 200 m high.

The choice of the applied tailings and/or waste-rock management method depends mainly on an evaluation of three factors, namely:

- cost
- environmental performance
- risk of failure.

Key environmental issues

The main environmental impacts from tailings and waste-rock management facilities are impacts associated with the site location and relative land take as well as the potential emissions of dust and effluents during operation or in the after-care phase. Furthermore, bursts or collapses of tailings and/or waste-rock management facilities can cause severe environmental damage – and even loss of human life.

The bases for the successful management of tailings and waste-rock are a proper material characterisation, including an accurate prediction of their long-term behaviour, and a good choice of site location.

Emissions:

Effluents and dust emitted from tailings and waste-rock management facilities, controlled or uncontrolled, may be toxic in varying degrees to humans, animals and plants. The effluents can be acidic or alkaline, and may contain dissolved metals and/or soluble and entrained insoluble complex organic constituents from mineral processing, as well as possibly natural occurring organic substances such as humic and long-chain carboxylic acids from mining operations. The substances in the emissions, together with their pH level, dissolved oxygen content, temperature and hardness may all be important aspects affecting their toxicity to the receiving environment.

The past two decades have increased the widespread awareness of an environmental problem in mining known as 'acid rock drainage' or ARD. ARD is associated with sulphide ore bodies mined for Pb, Zn, Cu, Au, and other minerals, including coal. While ARD can be generated from sulphide-bearing pit walls, and underground mines, only tailings and waste-rock management are considered in this document.

The key issues that are the root of these environmental problems are:

- tailings and/or waste-rock often contain metal sulphides
- sulphides oxidise when exposed to oxygen and water
- sulphide oxidation creates an acidic metal-laden leachate
- leachate generation over long periods of time
- where there is deficiency of acid buffering minerals.

Accidental bursts and collapses:

The collapse of any type of tailings or waste-rock management facility can have short-term and long-term effects. Typical short-term consequences include:

- flooding
- blanketing/suffocating
- crushing and destruction
- cut-off of infrastructure
- poisoning.

Potential long-term effects include:

- metal accumulation in plants and animals
- contamination of soil
- loss of human and/or animal life.

Site rehabilitation and aftercare:

When an operation comes to an end, the site needs to be prepared for its subsequent use. Usually, at least for the past few decades, plans for closure and site clean-up will have been part of the permitting of the site, right from the planning stage onwards, and should therefore have undergone regular updating with every change in the operation and in negotiations with the permittees and other stakeholders. In some cases, the aim will be to leave as little a footprint as possible, whereas in other cases a complete change of landscape may be aimed for. The concept of 'design for closure' implies that the closure of the site is taken into account in the feasibility study of a new mine site and is then continuously monitored and updated during the life cycle of the mine. In every case, adverse environmental impacts need to be kept to a minimum.

Common processes and techniques

Mining techniques:

The extraction of an ore (a process called mining), subsequent mineral processing and the management of tailings and waste-rock are in most cases considered to be a single operation. The ore extraction, the subsequent mineral processing techniques and the tailings and waste-rock management applied depend on the mining technique. Hence, it is important to have an understanding of the most important mining methods.

For the mining of solids, there are four basic mining concepts:

- (1) open pit
- (2) underground mine
- (3) quarry and
- (4) solution mining.

The choice between these four alternatives depends on many factors, such as:

- value of the desired mineral(s)
- grade of the ore
- size, form and depth of the orebody
- environmental conditions of the surrounding area
- geological, hydrogeological and geomechanical conditions of the rock mass
- seismic conditions of the area
- site location of the orebody
- solubility of the orebody
- environmental impact of the operation
- surface constraints
- land availability.

Mineralogy:

Basically it is possible to differentiate between the major mineral types such as oxide, sulphide, silicate and carbonate minerals, which, through weathering and other alterations, can undergo fundamental chemical changes (e.g. weathering of sulphides to oxides). The mineralogy is set by nature and determines, in many ways, the subsequent recovery of the desired minerals and the subsequent tailings and waste-rock management.

Having a good knowledge of the mineralogy is an important precursor for:

- environmentally sound management (e.g. separate management of acid-generating and non-acid-generating tailings or waste-rock)
- a reduced need for end-of-pipe treatments (such as the lime treatment of acidified seepage water from a TMF)
- more possibilities for utilising tailings and/or waste-rock as aggregates.

Mineral processing techniques:

The purpose of mineral processing is to turn the raw ore from the mine into a marketable product. This is usually carried out on the mine site, the plant being referred to as a mineral processing plant (mill or concentrator). The essential purpose of the processing is to reduce the bulk of the ore, which must be transported to and processed by subsequent processes (e.g. smelting), by using methods to separate the valuable (desired) mineral(s) from the gangue. The marketable product of this is called concentrate, and the remaining material is called tailings. Mineral processing includes various procedures that rely on the mineral's own physical characteristics (i.e. particle size, density, magnetic properties, colour) or physico-chemical properties (surface tension, hydrophobicity, wettability).

Typical techniques applied in mineral processing are:

- comminution
- screening and hydro-cycloning
- gravity concentration
- flotation
- sorting
- magnetic separation
- electrostatic separation
- leaching
- thickening
- filtration.

Some of these techniques require the use of reagents. In the case of flotation frothers, collectors and modifiers are necessary to achieve the desired separation.

The techniques used in mineral processing have an effect on the characteristics of the tailings.

Tailings and waste-rock management:

Some of the most important characteristics of materials in tailings and waste-rock management facilities are:

- shear strength
- particle size distribution
- density
- plasticity
- moisture content
- permeability
- porosity.

Tailings dams are surface structures in which slurried tailings are managed. This type of tailings management facility (TMF) is typically used for tailings from wet processing. For each tailings impoundment, several activities need to be considered, including:

- dams to confine the tailings
- diversion systems for natural run-off around or through the dam
- tailings delivery from the mineral processing plant to the tailings dam
- deposition of the tailings within the dam
- removal of excess free water
- protection of the adverse surrounding area from environmental impacts
- instrumentation and monitoring systems to enable inspection of the dam
- long-term aspects (i.e. closure and after-care).

Some other techniques to manage tailings and waste-rock are backfilling, management on heaps, thickened tailings, underwater management and finding other uses.

Usually a mine, together with the mineral processing plant and the tailings and waste-rock facilities, will only remain in operation for a few decades. Mine voids (not part of the scope of this work), tailings and waste-rock however, may remain behind long after the mining activity has ceased. Therefore, special attention needs to be given to the proper closure, rehabilitation and after-care of these facilities.

The most important aspects in management of tailings and waste-rock, despite the choice of the site locations, are the consideration of failure modes of heaps and dams, the relationship between tailings characteristics and tailings behaviour and the acid rock drainage (ARD) potential.

Applied processes and techniques, emission and consumption levels

In the following list some examples of the most important issues in tailings management are highlighted, including:

- slurried tailings, called 'red mud' from the refining of alumina have an elevated pH and are either stored in conventional tailings pond/dam systems, are thickened to a degree that they can be 'dry-stacked', or discharged into the sea
- tailings from base metal operations are mostly managed as slurries in large tailings ponds. Often base metals ores contain sulphides (in a quantity higher than the contained buffering minerals), so that the tailings have an acid-rock-drainage (ARD) potential. At one operation the tailings are discharged subaqueously to prevent ARD generation right from the start. Some operations backfill part of the tailings underground. In several cases, the chosen closure method for the tailings pond is the 'wet' cover technique, in other cases dry covers are applied
- coarse tailings from iron ore operations are managed in heaps. The slurried tailings are managed in ponds
- some of the gold mines operated in Europe have a net ARD potential. When cyanide leaching is used to extract the gold, the cyanide is destroyed prior to discharge into the tailings pond.
- For industrial minerals, several sites do not generate tailings at all or sell the tailings as aggregates
- borates operations first store the coarse tailings on heaps before they are backfilled
- one fluorspar operation described in this document discharges the tailings into the sea
- one kaolin operation described in this document first dewateres the fine tailings before they are transferred to heaps, this is also done in some limestone/calcium carbonate operations
- one limestone operation described in this document discards the slurried tailings into a former quarry
- potash sites manage the solid tailings on heaps or backfilled. The liquid tailings are partially pumped into deep wells and partially led into surface waters. In one case described in this document there is marine discharge of the tailings
- in coal operations, the coarse tailings are usually managed on heaps or in former open pit operations. The slurried fines are either discarded into ponds or filtered. In some cases the filtered tailings as well as the coarse tailings are sold. In other cases they are put on heaps. Backfilling is often not viable
- some of the measures applied to prevent accidents include: monitoring routines, operation, supervision and maintenance (OSM) manuals, independent audits, water balances, subsidence measurements, review of planning by external experts, the use of piezometers and inclinometers and seismic monitoring.

In the following list some examples of the most important issues in waste-rock management are highlighted, including:

- in underground operation the waste-rock usually remains underground
- as in the case with tailings, waste-rock in base metals operations sometimes has an ARD potential. Some operations manage ARD and non-ARD waste-rock separately. Non-ARD generating waste-rock is either used as aggregate, used for construction of dams or roads at the site or managed on heaps. Upon closure ARD generating waste-rock heaps are covered with engineered dry covers that aim at preventing ARD generation
- waste-rock from one iron operation is managed on heaps with the coarse tailings
- waste-rock from gold operations is managed on heaps, used for dam construction or backfilled into the open pit
- some industrial minerals operations backfill the waste-rock or sell it as aggregate
- in many coal operations the waste-rock is managed in heaps with the filtered fine tailings. The final heap design is agreed on with the authorities and the communities with the aim of creating landscape integrated structures.

Emission and Consumption levels

Most of the process water is returned from the tailings management facility to the mineral processing plant, but reagent built-up is an issue to be aware of.

Due to the large variations in mineralogy, mining and mineral processing methods and in site conditions, it is impossible to further summarise the emission and consumption levels. However many sites provided this information, which is included in Chapter 3. Typically the information includes data on the water consumption and the amount of process water re-use, the water balance, the reagent consumption, the dust emissions and information on the emissions to water.

Costs

In Chapter 3, some examples of costs for tailings and waste-rock management for operation and closure have been included.

Techniques to consider in the determination of BAT

Chapter 4 contains the detailed information used to determine BAT for the management of tailings and waste-rock in mining activities.

The aim was to include enough information to assess the applicability of the techniques in general or in specific cases. The information in this chapter is essential to the determination of BAT.

Those techniques which are judged to be BAT, are also cross-referenced from chapter 5. Users of the document are thus directed to the discussion of the relevant techniques associated with the BAT conclusions, which can assist them when they are determining the BAT-based conditions of permits.

Some of the techniques in Chapter 4 are of a technical nature whilst others are good operating practices, including management techniques. The techniques are grouped in the following order:

- general principles: Good management principles, management strategies and risk assessment, all aimed at providing the general background for successfully managing tailings and waste-rock
- life-cycle management: A reduction of the risk of any failures can be assisted by a commitment of the operator to the adequate and rigorous application of appropriate available engineering techniques for the design, operation and closure of tailings and waste-rock management facilities over the entire period of their operating life. Some tools elemental to good engineering are the establishment of an environmental baseline, the characterisation of tailings and waste-rock, the use of dam safety manuals and audits, as well as applying planning for closure from the outset
- emission prevention and control:
 - ARD management: There are a number of prevention, control and treatment options (e.g. covers, addition of buffering minerals, active/passive treatment) developed for potentially ARD generating tailings and waste-rock, applicable for the operational as well as the closure phases of the mine life
 - techniques to reduce reagent consumption: Several approaches are available to reduce the use of reagents, i.e. computer-based monitoring of feed quality, operational strategies to minimise cyanide addition and pre-sorting of the feed to the mineral processing plant
 - prevention of water erosion: Water erosion of tailings or waste-rock management facilities can be avoided by covering the slopes or encouraging particle binding
 - dust prevention: The main sources for dust emissions are the beaches of tailings ponds, the outer slopes of dams and heaps and the transport of tailings and waste-rock. One technique to prevent dusting is to keep beaches in tailings ponds and other slopes wet

- techniques to reduce noise emissions: The most common sources for noise emissions are transport, dumping and spreading, when trucks and conveyor belts are used. Noise nuisance from trucks can be reduced by shielding the dumping operation from housing areas with noise barriers
- progressive restoration/revegetation: Heaps and dams are often restored/revegetated during operation. Amongst other advantages, this allows a shorter closure period
- water balances: Completing a detailed water balance is of importance for the design of any tailings pond, the mine site and for the post mining scenario. The water balance can determine the discharge capacity of the pond and the required freeboard (if the water from the pond cannot be directly released into the recipient watercourse). Upon closure, the water balance is evaluated in order to implement the closure plans
- drainage of ponds: In impermeable ponds a drainage systems may be required to allow the re-use of process water and to reduce the required ponds size
- free water management: If the free water in the pond is not discharged directly into the natural watercourses, it is necessary to arrange the deposition such that all free water is returned to the plant or, in arid, hot climates, evaporated
- seepage management: A prerequisite for the design of seepage management systems is a thorough understanding of the hydrogeological background of the site. In some cases, seepage is prevented. In other scenarios, the seepage water is collected or, if of a good quality, allowed to seep into the groundwater
- techniques to reduce emissions to water: Emissions to water can be prevented by re-using the process water. If this is not possible the effluents may turn out to be acidic or alkaline, they may contain suspended solids, dissolved components or metals (e.g. arsenic) or process chemicals (e.g. cyanide). The treatment techniques that can be applied will differ for each compound
- groundwater monitoring: Groundwater is usually monitored around all tailings and waste-rock areas. This includes the level of the water table and the water quality
- accident prevention:
 - tailings or waste-rock management in a pit: In order to prevent the collapse of dams or heaps, the best possible place to construct a tailings or waste-rock management facility is a suitable nearby pit, since in this case dam/heap stability is not an issue
 - diversion of natural run-off: A diversion system is critical to the safety of a tailings dam. Failure of any part can lead to the impoundment receiving floods for which it was not designed with the possibility of overtopping, leading to a total failure of the dam
 - preparation of the natural ground below the dam: The natural ground below the retaining dam is usually stripped of all vegetation and huminous soils, in order to provide an adequate 'foundation' for the structure
 - dam construction material: The prime consideration for choosing the dam construction material is that the materials should be fit for the purpose and must not weaken under operational or climatic conditions
 - tailings deposition: Proper deposition of tailings, particularly in a wet state, will always be critical to the stability of the structure. Typically, the wet tailings are discharged off the crest of the dam in as even a distribution as possible around the dam, in order to create a "beach" of tailings against the inner face of the retaining dam
 - techniques to construct and raise dams: Tailings dams used to be constructed of the coarse tailings fraction and indeed this can still be a very appropriate way of retaining the tailings slurry. However, over the life of the mine the qualities of the ore can change and the processing method can change and therefore the characteristics of the tailings may also change. Hence quality management is a tricky issue over the entire lifespan of an operation. Therefore there is a trend to construct the initial starter dam, and often also the raises, with borrow material, whose quality can be more easily monitored during the construction of the dam. However not only is the type of material used to construct tailings dams important but so is the placing and compaction of suitable construction material, to ensure long-term stability. The basic dam types used are conventional dams or dams constructed using the upstream, downstream or centreline method

- free water management, freeboard, emergency discharge and design flood determination: Techniques for the removal of free water include spillways, open channels, decant towers and decant wells. Together with maintaining an adequate freeboard and emergency discharge systems, this is an essential tool for the prevention of accidents, such as dam overflows
- drainage of dams: Permeable dams are based on the principle that seepage through the dam should be drawn down well below the toe of the outer slope. This can be achieved by an internal drainage system, with the drainage zone being located in the inner section of the dam. Non-permeable dams have similar drainage systems, with the aim being to stop the seepage flow through the core from eroding the core and the outer slope of the dam
- monitoring of seepage: Controlled seepage occurs through the dam and ensures the stability by lowering the pore pressure over the dam. However, it is essential that the seepage is well controlled and managed both with respect to the day to day environmental performance, as well as from an accident prevention point of view
- dam and heap stability: An important measure of the stability of heaps and dams is the safety factor, i.e. the ratio of the available shear strength to the shear stress
- techniques to monitor stability of dams and heaps: The basis for all monitoring is the development of a monitoring plan. The monitoring consists of a list of measurements carried out in certain intervals. The overall monitoring plan typically also includes the plans for inspections and audits/reviews. A further factor influencing the stability of dams and heaps is the stability of the supporting strata, i.e. the ground on which the dams and heaps are built
- cyanide management: In addition to the treatment of tailings from cyanide leaching, the management of CN in general also involves a large number of security measures taken to prevent accidents. The design of the plant also includes several technical solutions aimed at the prevention of accidents
- dewatering of tailings: The main disadvantage of dealing with slurried tailings is their mobility. If the containment structure (i.e. the dam) were to collapse, they could liquefy and then cause considerable damage due to their physical and chemical characteristics. To avoid this problem two alternatives have been developed: dry tailings and thickened tailings management
- reduction of footprint: An efficient way to reduce the footprint of tailings and waste-rock management facilities is to backfill all or part of these materials. Other options include the underwater management of tailings, i.e. discharge into the sea, or finding other uses of the tailings and waste-rock
- mitigation of accidents: Two tools for the mitigation of accidents are emergency planning and the evaluation and follow-up of incidents
- environmental management tools: Environmental management systems are a useful tool to aid the prevention of pollution from industrial activities in general.

BAT for the management of tailings and waste-rock in mining activities

The BAT chapter (Chapter 5) identifies those techniques that are considered to be BAT, based upon the information in Chapter 4 and taking into account the definition of “best available techniques” and the considerations listed in Annex IV of the IPPC Directive (see Preface).

The BAT chapter is divided into a generic part, applicable to all sites managing tailings and waste-rock, and a specific part for specific minerals.

Tailings and waste-rock management decisions are based on environmental performance, risk and economic viability, with risk being a site specific factor.

For completeness, all BAT conclusions are shown here.

Generic BAT

BAT is to:

- apply the general principles set out in Section 4.1
- apply a life cycle management approach as described in Section 4.2.

Life cycle management covers all the phases of a site's life, including:

- the design phase (Section 4.2.1):
 - environmental baseline (Section 4.2.1.1)
 - characterisation of tailings and waste-rock (Section 4.2.1.2)
 - TMF studies and plans (Section 4.2.1.3), which cover the following aspects:
 - site selection documentation
 - environmental impact assessment
 - risk assessment
 - emergency preparedness plan
 - deposition plan
 - water balance and management plan and
 - decommissioning and closure plan
 - TMF and associated structures design (Section 4.2.1.4)
 - control and monitoring (Section 4.2.1.5)
- the construction phase (Section 4.2.2)
- the operational phase (Section 4.2.3), with the elements:
 - OSM manuals (Section 4.2.3.1)
 - auditing (Section 4.2.3.2)
- the closure and after-care phase (Section 4.2.4), with the elements:
 - long-term closure objectives (Section 4.2.4.1)
 - specific closure issues (Section 4.2.4.2) for
 - heaps
 - ponds, including
 - water covered ponds
 - dewatered ponds
 - water management facilities

Furthermore, BAT is to:

- reduce reagent consumption (Section 4.3.2)
- prevent water erosion (Section 4.3.3)
- prevent dusting (Section 4.3.4)
- carry out a water balance (Section 4.3.7) and to use the results to develop a water management plan (Section 4.2.1.3)
- apply free water management (Section 4.3.9)
- monitor groundwater around all tailings and waste-rock areas (Section 4.3.12).

ARD management

The characterisation of tailings and waste-rock (Section 4.2.1.2 in combination with Annex 4) includes the determination of the acid-forming potential of tailings and/or waste-rock. If an acid-forming potential exists it is BAT to firstly prevent the generation of ARD (Section 4.3.1.2), and if the generation of ARD cannot be prevented, to control ARD impact (Section 4.3.1.3) or to apply treatment options (Section 4.3.1.4). Often a combination is used (Section 4.3.1.6).

All prevention, control and treatment options can be applied to existing and new installations. However, the best closure results will be obtained when plans are developed for the site closure right at the outset (design stage) of the operation (cradle-to-grave philosophy).

Executive summary

The applicability of the options depends mainly on the conditions present at the site. Factors such as:

- water balance
- availability of possible cover material
- groundwater level.

influence the options applicable at a given site. Section 4.3.1.5 provides a tool for deciding on the most suitable closure option.

Seepage management (Section 4.3.10)

Preferably the location of a tailings or waste-rock management facility will be chosen in a way that a liner is not necessary. However, if this is not possible and the seepage quality is detrimental and/or the seepage flowrate is high, then seepage needs to be prevented, reduced (Section 4.3.10.1) or controlled (Section 4.3.10.2) (listed in order of preference). Often a combination of these measures is applied.

Emissions to water

BAT is to:

- re-use process water (see Section 4.3.11.1)
- mix process water with other effluents containing dissolved metals (see Section 4.3.11.3)
- install sedimentation ponds to capture eroded fines (see Section 4.3.11.4.1).
- remove suspended solids and dissolved metals prior to discharge of the effluent to receiving watercourses (Section 4.3.11.4)
- neutralise alkaline effluents with sulphuric acid or carbon dioxide (Section 4.3.11.6)
- remove arsenic from mining effluents by the addition of ferric salts (Section 4.3.11.7).

The respective sections in Chapter 3 on emissions and consumption levels provide examples of achieved levels. No correlation could be developed between the applied techniques and the available emission data. Therefore in this document it was not possible to draw BAT conclusions with associated emission levels.

The following techniques are BAT for treating acid effluents (Section 4.3.11.5):

- active treatments:
 - addition of limestone (calcium carbonate), hydrated lime or quicklime
 - addition of caustic soda for ARD with a high manganese content
- passive treatment:
 - constructed wetlands
 - open limestone channels/anoxic limestone drains
 - diversion wells.

Passive treatment systems are a long-term solution after the decommissioning of a site, but only when used as a polishing step combined with other (preventive) measures.

Noise emissions (Section 4.3.5)

BAT is to:

- use continuous working systems (e.g. conveyor belts, pipelines)
- encapsulate belt drives in areas where noise is a local issue
- first create the outer slope of a heap, and then transfer ramps and working benches into the heap's inner area as far as possible.

Dam design

In addition to the measures described in Section 4.1 and Section 4.2, during the **design** phase (Section 4.2.1) of a **tailings dam**, BAT is to:

- use the once in a 100-year flood event as the design flood for the sizing of the emergency discharge capacity of a low hazard dam
- use the once in a 5000 – 10000-year flood event as the design flood for the sizing of the emergency discharge capacity of a high hazard dam.

Dam construction

In addition to the measures described in Section 4.1 and Section 4.2, during the **construction** phase (Section 4.2.2) of a **tailings dam**, BAT is to:

- strip the natural ground below the retaining dam of all vegetation and huminous soils (Section 4.4.3)
- choose a dam construction material that is fit for the purpose and which will not weaken under operational or climatic conditions (Section 4.4.4).

Raising dams

In addition to the measures described in Section 4.1 and Section 4.2, during the **constructional** and **operational** phases (Sections 4.2.2 and 4.2.3) of a **tailings dam**, BAT is to:

- evaluate the risk of a too high pore pressure and monitor the pore pressure before and during each raise. The evaluation should be done by an independent expert.
- use conventional type dams (Section 4.4.6.1), under the following conditions, when:
 - the tailings are not suitable for dam construction
 - the impoundment is required for the storage of water
 - the tailings management site is in a remote and inaccessible location
 - retention of the tailings water is needed over an extended period for the degradation of a toxic element (e.g. cyanide)
 - the natural inflow into the impoundment is large or subject to high variations and water storage is needed for its control
- use the upstream method of construction (Section 4.4.6.2), under the following conditions, when:
 - there is very low seismic risk
 - tailings are used for the construction of the dam: at least 40 – 60 % material with a particle size between 0.075 and 4 mm in whole tailings (does not apply for thickened tailings)
- use the downstream method of construction (Section 4.4.6.3), under the following conditions, when:
 - sufficient amounts of dam construction material are available (e.g. tailings or waste-rock)
- use the centreline method of construction (Section 4.4.6.4), under the following conditions, when:
 - the seismic risk is low.

Dam operation

In addition to the measures described in Section 4.1 and Section 4.2, during the **operational** phase (Section 4.2.3) of a **tailings pond**, BAT is to:

- monitor stability as further specified below
- provide for diversion of any discharge into the pond away from the pond in the event of difficulties
- provide alternative discharge facilities, possibly into another impoundment

Executive summary

- provide second decant facilities (e.g. emergency overflow, Section 4.4.9) and/or standby pump barges for emergencies, if the level of the free water in the pond reaches the pre-determined minimum freeboard (Section 4.4.8)
- measure ground movements with deep inclinometers and have a knowledge of the pore pressure conditions
- provide adequate drainage (Section 4.4.10)
- maintain records of design and construction and any updates/changes in the design/construction
- maintain a dam safety manual as described in Section 4.2.3.1 in combination with independent audits as mentioned in Section 4.2.3.2
- educate staff and provide adequate training for staff.

Removal of free water from the pond (Section 4.4.7.1)

BAT is to:

- use a spillway in natural ground for valley site and off valley site ponds
- use a decant tower:
 - in cold climates with a positive water balance
 - for paddock-style ponds
- use a decant well:
 - in warm climates with a negative water balance
 - for paddock-style ponds
 - if a high operating freeboard is maintained.

Dewatering of tailings (Section 4.4.16)

The choice of method (slurried, thickened or dry tailings) depends mainly on an evaluation of three factors, namely:

- cost
- environmental performance
- risk of failure.

BAT is to apply:

- dry tailings (Section 4.4.16.1)
- thickened tailings (Section 4.4.16.2) or
- slurried tailings (Section 4.4.16.3) management.

There are many factors that influence the choice of the appropriate techniques for a given site. Some of these factors are:

- mineralogy of the ore
- ore value
- particle size distribution
- availability of process water
- climatic conditions
- available space of tailings management.

Tailings and waste-rock management facility operation

In addition to the measures described in Section 4.1 and Section 4.2, during the **operational phase** (Section 4.2.3) of **any tailings and waste-rock management facility**, BAT is to:

- divert natural external run-off (Section 4.4.1)
- manage tailings or waste-rock in pits (Section 4.4.1). In this case heap/dam slope stability is not an issue
- apply a safety factor of at least 1.3 to all heaps and dams during operation (Section 4.4.13.1)
- carry out progressive restoration/revegetation (Section 4.3.6).

Monitoring stability

BAT is to:

- monitor in a tailings pond/dam (Section 4.4.14.2):
 - the water level
 - the quality and quantity of seepage flow through the dam (also Section 4.4.12)
 - position of phreatic surface
 - pore pressure
 - movement of dam crest and tailings
 - seismicity, to ensure stability of the dam and the supporting strata (also Section 4.4.14.4)
 - dynamic pore pressure and liquefaction
 - soil mechanics
 - tailings placement procedures
- monitor in a heap (Section 4.4.14.2):
 - bench/slope geometry
 - sub-tip drainage
 - pore pressure
- also carry out:
 - in the case of a tailings pond/dam:
 - visual inspections (Section 4.4.14.3)
 - annual reviews (Section 4.4.14.3)
 - independent audits (Section 4.2.3.2 and Section 4.4.14.3)
 - safety evaluations of existing dams (SEED) (Section 4.4.14.3)
 - in the case of a heap:
 - visual inspections (Section 4.4.14.3)
 - geotechnical reviews (Section 4.4.14.3)
 - independent geotechnical audits (Section 4.4.14.3).

Mitigation of accidents

BAT is to:

- carry out emergency planning (Section 4.6.1)
- evaluate and follow-up incidents (Section 4.6.2)
- monitor the pipelines (Section 4.6.3).

Reduction of footprint

BAT is to:

- if possible, prevent and/or reduce the generation of tailings/waste-rock (Section 4.1)
- backfill tailings (Section 4.5.1), under the following conditions, when:
 - backfill is required as part of the mining method (Section 4.5.1.1)
 - the additional cost for backfilling is at least compensated for by the higher ore recovery
 - in open pit mining, if the tailings easily dewater (i.e. evaporation and drainage, filtration) and thereby a TMF can be avoided or reduced in size (Sections 4.5.1.2, 4.5.1.3, 4.5.1.4, 4.4.1)
 - use nearby mined-out open pits if available for backfilling (Section 4.5.1.5)
 - backfilling of large stopes in underground mines (Section 4.5.1.6). Stopes backfilled with slurried tailings will require drainage (Section 4.5.1.9). Binders may also need to be added to increase the stability (Section 4.5.1.8)
- backfill tailings in the form of paste fill (Section 4.5.1.10), if the conditions to apply backfill are met and if:
 - there is a need for a competent backfill
 - the tailings are very fine, so that little material would be available for hydraulic backfill. In this case, the large amount of fines sent to the pond would dewater very slowly

Executive summary

- it is desirable to keep water out of the mine or where it is costly to pump the water draining from the tailings (i.e. over a large distance)
- backfill waste-rock, under the following conditions (Section 4.5.2), when:
 - it can be backfilled within an underground mine
 - one or more mined-out open pits are nearby (this is sometimes referred to as ‘transfer mining’)
 - the open pit operation is carried out in such a way that it is possible to backfill the waste-rock without inhibiting the mining operation
- investigate possible uses of tailings and waste-rock (Section 4.5.3).

Closure and after-care

In addition to the measures described in Section 4.1 and Section 4.2, during the **closure and after-care phase** (Section 4.2.4) of **any tailings and waste-rock management facility**, BAT is to:

- develop closure and after-care plans during the planning phase of an operation, including cost estimates, and then to update them over time (Section 4.2.4). However, the requirements for rehabilitation develop throughout the lifetime of an operation and can first be considered in precise detail in the closure phase of a TMF
- apply a safety factor of at least 1.3 for dams and heaps after closure (Section 4.2.4 and 4.4.13.1), although a split view concerning water covers exists (see Chapter 7).

For the closure and after-care phase of tailings ponds BAT is to construct the dams so that they stay stable in the long term if a water cover solution is chosen for the closure (Section 4.2.4.2).

Gold leaching using cyanide

In addition to the generic measures for all sites applying gold leaching using cyanide, BAT is to do the following:

- reduce the use of CN by applying:
 - operational strategies to minimise cyanide addition (Section 4.3.2.2)
 - automatic cyanide control (Section 4.3.2.2.1)
 - if applicable, peroxide pretreatment (Section 4.3.2.2.2)
- destroy the remaining free CN prior to discharge in the pond (Section 4.3.11.8). Table 4.13 shows examples of CN levels achieved at some European sites
- apply the following safety measures (Section 4.4.15):
 - size the cyanide destruction circuit with a capacity twice the actual requirement
 - install a backup system for lime addition
 - install backup power generators.

Aluminium

In addition to the generic measures for all alumina refineries, BAT is to do the following:

- during operation:
 - avoid discharging effluents into surface waters. This is achieved by re-using process water in the refinery (Section 4.3.11.1) or, in dry climates, by evaporation
- in the after-care phase (Section 4.3.13.1):
 - treat the surface run-off from TMFs prior to discharge, until the chemical conditions have reached acceptable concentrations for discharge into surface waters
 - maintain access roads, drainage systems and the vegetative cover (including re-vegetation if necessary)
 - continue groundwater quality sampling.

Potash

In addition to the generic measures for all potash sites, BAT is to do the following:

- if the natural soil is not impermeable, make the ground under the TMF impermeable (Section 4.3.10.3)
- reduce dust emissions from conveyor belt transport (Section 4.3.4.3.1)
- seal/line the toe of the heaps outside the impermeable core zone and collect the run-off (Section 4.3.11.4.1)
- backfill large stopes with dry and/or slurried tailings (Section 4.5.1.6).

Coal

In addition to the generic measures for all coal sites, BAT is to do the following:

- prevent seepage (Section 4.3.10.4)
- dewater fine tailings <0.5 mm from flotation (Section 4.4.16.3).

Environmental management

A number of environmental management techniques are determined as BAT. The scope (e.g. level of detail) and nature of the EMS (e.g. standardised or non-standardised) will generally be related to the nature, scale and complexity of the installation, and the range of environmental impacts it may have.

BAT is to implement and adhere to an Environmental Management System (EMS) that incorporates, as appropriate to individual circumstances, the following features: (see Chapter 4)

- definition of an environmental policy for the installation by top management (commitment of the top management is regarded as a precondition for a successful application of other features of the EMS)
- planning and establishing the necessary procedures
- implementation of the procedures, paying particular attention to
 - structure and responsibility
 - training, awareness and competence
 - communication
 - employee involvement
 - documentation
 - efficient process control
 - maintenance programme
 - emergency preparedness and response
 - safeguarding compliance with environmental legislation
- checking performance and taking corrective action, paying particular attention to
 - monitoring and measurement (see also the Reference document on Monitoring of Emissions)
 - corrective and preventive action
 - maintenance of records
 - independent (where practicable) internal auditing in order to determine whether or not the environmental management system conforms to planned arrangements and has been properly implemented and maintained
- review by top management.

Executive summary

Three further features, which can complement the above stepwise, are considered as supporting measures. However, their absence is generally not inconsistent with BAT. These three additional steps are:

- having the management system and audit procedure examined and validated by an accredited certification body or an external EMS verifier
- preparation and publication (and possibly external validation) of a regular environmental statement describing all the significant environmental aspects of the installation, allowing for year-by-year comparison against environmental objectives and targets as well as with sector benchmarks as appropriate
- implementation and adherence to an internationally accepted voluntary system such as EMAS and EN ISO 14001:1996. This voluntary step could give higher credibility to the EMS. In particular EMAS, which embodies all the above-mentioned features, gives higher credibility. However, non-standardised systems can in principle be equally effective provided that they are properly designed and implemented.

Specifically for the management of tailings and waste-rock, it is BAT to apply an integrated risk/safety and environmental management system. Therefore environmental management has to be developed and carried out jointly with the risk assessment/management described in Section 4.2.1 and the operation, supervision and maintenance management described in Section 4.2.3.1.

Emerging techniques

Chapter 6 includes six ‘emerging’ techniques that have not yet been commercially applied and that are still in the research or development phase. They are:

- co-disposal of iron ore tailings and waste-rock
- inhibiting progress of ARD
- recycling of cyanide using membrane technology
- lines cells
- utilisation of red mud to remediate problems of ARD and metals pollution
- combination of SO₂/air and hydrogen peroxide to destroy cyanide.

They have been included here to raise awareness for any future revision of this document.

Concluding remarks

Information exchange

Many documents were provided by industry and by permitting authorities as a basis for the information to be included in this document. Bulletins from the ‘International Commission on Large Dams’ (ICOLD) concerning tailings management, the Canadian ‘Guide to the management of tailings facilities’ document and the Finnish ‘Dam safety code of practice’ may be considered as the cornerstone documents for this BAT document.

The amount and quality of the data in this document shows an imbalance, in that little information was provided on actual consumption and emission levels of industrial minerals tailings and waste-rock management facilities.

Emission data for metal operations is based on single facilities. No correlation could be developed between the applied techniques and the available emission data. Therefore BAT conclusions with an associated emissions level were not possible.

Degree of consensus reached

The conclusions of the work were agreed at the final plenary meeting in November 2003, with a high level of consensus being achieved. There is one split view concerning the safety factor for long-term stable dams having a 'wet' cover.

Recommendations for future work

The result of this information exchange, i.e. this document, presents an important step forward in reducing everyday pollution and preventing accidents from tailings and waste-rock management facilities. On a few topics, however, the information is incomplete and did not allow BAT conclusions to be reached. Future work could usefully focus on collecting information on the following topics:

- expansion of the scope to address all types of mining waste and to include examples and techniques from other minerals
- more detailed information on the generation of tailings and waste-rock
- BAT associated emission levels for effluent treatment and for cyanide destruction
- underwater tailings management in seawater
- economic data for many of the techniques presented in Chapter 4
- characterisation of tailings and waste-rock:
 - to include more international and national standards in Annex 4
 - to develop a standard methodology for the characterisation waste-rock and tailings
- more performance data for the thickened tailings technique
- new cyanide remediation techniques.

Furthermore future work may also be required in order to adapt the BAT document to the final scope of the Directive on the management of waste from the extractive industries after its adoption.

Suggested topics for future research and development projects

The information exchange has also exposed some areas where additional useful knowledge could be gained from Research and Development projects. These relate to the following subjects:

- life-cycle management: Applying full life-cycle management is essential for a site to achieve a high level of safety and environmental performance. However, economic data showing that it is economically effective to manage a mining operation with the entire life-cycle model is currently missing. Research in this area is needed to investigate any existing case studies, to determine the economics of applying integrated life-cycle management for assessing short-term projects (e. g. to assess the maximum profit during operation)
- cyanide decomposition products toxicity: The toxicity of cyanide itself is a well investigated subject. However, it seems that some decomposition products may also be of toxicological importance. In view of the impact of spills from sites using cyanide to leach gold, there is a need for research on the toxicity of cyanide decomposition products.

The EC is launching and supporting, through its RTD programmes, a series of projects dealing with clean technologies, emerging effluent treatment and recycling technologies and management strategies. Potentially these projects could provide a useful contribution to future reviews of this document. Readers are therefore invited to inform the EIPPCB of any research results which are relevant to the scope of this document (see also the preface of this document).

PREFACE

1. Status of this document

This document forms part of a series presenting the results of an exchange of information between EU Member States and industries concerned on best available techniques (BAT), associated monitoring, and developments in them. It is published by the European Commission pursuant Article 21(3) of the Directive 2006/21/EC on the management of waste from the extractive industries³. It must therefore be taken into account when determining “best available techniques”.

1.1. Background

The starting point for this document is the Communication from the European Commission COM(2000) 664 on the Safe Operation of Mining Activities (hereafter: the Communication). As outlined under Section 5.5 of this Communication, core extraction activities are not covered by Council Directive 96/61/EC (IPPC Directive). However, activities of the kind undertaken at the Baia Mare site (production of metal by leaching of gold) are already inside the scope of the IPPC Directive. Paragraph 2.5 (b) of Annex I of the IPPC Directive lists “installations for the production of non-ferrous crude metals from ore, concentrates or secondary raw materials by metallurgical, chemical or electrolytic processes”.

The Communication further recognises that the IPPC Directive does not cover *all* sites in the European Union, and in fact it does not cover *most* sites, where tailings management facilities are used.

Section 6 of the Communication proposes a follow-up action plan, which includes three key actions:

- amendment of Council Directive 96/82/EC of 9 December 1996 on the control of major-accident hazards involving dangerous substances (Seveso II Directive)
- an initiative on the management of waste from the extractive industry
- a BAT reference document.

The decision to prepare a Technical Reference document describing BAT for the Management of mining waste in the sense of Article 2(6) of the IPPC Directive was a voluntary agreement between the Commission, the Member States and the Mining Industry.

2. The definition of BAT

In order to help the reader understand the context in which this document has been drafted, some of the most relevant definitions of the IPPC Directive including the definition of the term “best available techniques”, and the provisions of the Proposal for a Directive on the management of waste from the extractive industries, are described in this preface. This description is inevitably incomplete and is given for information only. It has no legal value and does not in any way alter or prejudice the actual provisions of these Directives.

The Proposal for a Directive on the management of waste from the extractive industries provides for measures, procedures and guidance to prevent or reduce as far as possible any adverse effects on the environment, and any resultant risks to human health, brought about as a result of the management of waste from the extractive industries. This document aims at introducing this approach to the management of tailings and waste-rock in mining activities. Central to this approach is the general principle that operators should take all appropriate preventative measures against pollution, in particular through the application of best available techniques enabling them to improve their environmental performance.

³ [OJL 201/15](#) (11/04/2006)

The following definitions have been applied:

The term “best available techniques” as defined in Article 2(11) of the IPPC Directive as “the most effective and advanced stage in the development of activities and their methods of operation which indicate the practical suitability of particular techniques for providing in principle the basis for emission limit values designed to prevent and, where that is not practicable, generally to reduce emissions and the impact on the environment as a whole.” The proposed Directive on the management of waste from the extractive industries follows the same definition of BAT.

“techniques” includes both the technology used and the way in which the installation/facility is designed, built, maintained, operated and decommissioned;

“available” techniques are those developed on a scale which allows implementation in the relevant industrial sector, under economically and technically viable conditions, taking into consideration the costs and advantages, whether or not the techniques are used or produced inside the Member State in question, as long as they are reasonably accessible to the operator;

“best” means most effective in achieving a high general level of protection of the environment as a whole.

Furthermore, Annex IV of the IPPC Directive contains a list of “considerations to be taken into account generally or in specific cases when determining best available techniques bearing in mind the likely costs and benefits of a measure and the principles of precaution and prevention:

1. the use of low-waste technology
2. the use of less hazardous substances
3. the furthering of recovery and recycling of substances generated and used in the process and of waste, where appropriate
4. comparable processes, facilities or methods of operation which have been tried with success on an industrial scale;
5. technological advances and changes in scientific knowledge and understanding;
6. the nature, effects and volume of the emissions concerned;
7. the commissioning dates for new or existing installations;
8. the length of time needed to introduce the best available technique;
9. the consumption and nature of raw materials (including water) used in the process and their energy efficiency;
10. the need to prevent or reduce to a minimum the overall impact of the emissions on the environment and the risks to it;
11. the need to prevent accidents and to minimise the consequences for the environment;
12. the information published by the Commission pursuant to Article 16 (2) or by international organisations.”

Article 21(2) of the Directive 2006/21/EC on the management of waste from the extractive industries, provide for an obligation on Member States to ensure that competent authorities follow or are informed of developments in best available techniques.

3. Objective of this Document

Under Section 6.3 the Communication says that the BAT document should deal with techniques to:

- reduce everyday pollution and
- prevent or mitigate accidents.

Furthermore it states that the BAT document will contribute to the knowledge about the measures that are available to prevent similar accidents (e.g. to Baia Mare) in the future. With this information at their disposal, the licensing authorities and Member States would be in a position to require that, in the European Union, installations using tailings management facilities meet high environmental standards while retaining economic and technical viability of the sector.

The Commission (Environment DG) established an information exchange forum (IEF) and a number of technical working groups have been established under the umbrella of the IEF. IEF and the technical working groups include representation from Member States and industry.

The aim of this series of documents is to reflect accurately the exchange of information which has taken place and to provide reference information for the competent authority to take into account when determining BAT-based measures. By providing relevant information concerning best available techniques, these documents should act as valuable tools to drive environmental performance.

4. Information Sources

This document represents a summary of information collected from a number of sources, including in particular the expertise of the groups established to assist the Commission in its work, and verified by the Commission services. All contributions are gratefully acknowledged.

5. How to understand and use this document

The information provided in this document is intended to be used as an input to the determination of BAT in specific cases. When determining BAT and setting BAT based measures, account should always be taken of the overall goal to achieve a high level of protection for the environment as a whole. The document addresses a certain number of minerals/commodities. However, the techniques applied here are applicable for many other facilities. Hence this document may be used beyond this list of minerals, where the issues are similar.

The rest of this section describes the type of information that is provided in each section of the document.

Chapters 1 and 2 provide general information on the tailings and waste-rock management facilities of the industrial sector concerned and on the industrial processes used within the sector where relevant for the tailings and waste-rock management. Chapter 3 provides data and information concerning applied techniques and current emission and consumption levels, reflecting the situation in existing tailings and waste-rock management facilities in the extractive industry at the time of writing.

Chapter 4 describes in more detail the emission and risk reduction and other techniques that are considered to be most relevant for determining BAT and BAT based measures. This information includes the consumption and emission levels considered achievable by using the technique, some idea of the costs and the cross-media issues associated with the technique, and the extent to which the technique is applicable to the range tailings and waste-rock management facilities requiring permits, for example new, existing, large or small facilities. Techniques that are generally seen as obsolete are not included.

Chapter 5 presents the techniques and the emission and consumption levels that are considered to be compatible with BAT in a general sense. The purpose is thus to provide general indications regarding the emission and consumption levels that can be considered as an appropriate reference point to assist in the determination of BAT based measures. It should be stressed, however, that this document does not propose emission limit values. The determination of appropriate BAT based measures will involve taking account of local, site-specific factors such as the technical characteristics of the facility concerned, its geographical location and the local environmental conditions. In the case of existing facilities, the economical and technical viability of upgrading them also needs to be taken into account. Even the single objective of ensuring a high level of protection for the environment as a whole will often involve making trade-off judgements between different types of environmental impact, and these judgements will often be influenced by local considerations.

Although an attempt is made to address some of these issues, it is not possible for them to be considered fully in this document. The techniques and levels presented in Chapter 5 will therefore not necessarily be appropriate for all facilities. On the other hand, the obligation to ensure a high level of environmental protection implies that BAT based measures cannot be set on the basis of purely local considerations. It is therefore of the utmost importance that the information contained in this document is fully taken into account by competent authorities.

Since the best available techniques change over time, this document will be reviewed and updated as appropriate. Also the document may be reviewed in the light of the final wording of the proposed Directive on the management of waste from the extractive industries once adopted. All comments and suggestions should be made to the European IPPC Bureau at the Institute for Prospective Technological Studies at the following address:

Edificio Expo, c/ Inca Garcilaso, 3, E-41092 Seville, Spain

Telephone: +34 95 4488 284

Fax: +34 95 4488 426

e-mail: JRC-IPTS-EIPPCB@ec.europa.eu

Internet: <http://eippcb.jrc.ec.europa.eu>

Best Available Techniques Reference Document on Management of Tailings and Waste-Rock in Mining Activities

EXECUTIVE SUMMARY	I
PREFACE	XXI
SCOPE	XLI
1 GENERAL INFORMATION	1
1.1 Industry overview: metals	2
1.1.1 Aluminium	3
1.1.2 Base Metals (Cadmium, Copper, Lead, Nickel, Tin, Zinc)	4
1.1.3 Chromium	9
1.1.4 Iron	10
1.1.5 Manganese	11
1.1.6 Mercury	12
1.1.7 Precious Metals (Gold, Silver)	13
1.1.8 Tungsten	17
1.2 Industry overview industrial minerals	17
1.2.1 Barytes	18
1.2.2 Borates	19
1.2.3 Feldspar	20
1.2.4 Fluorspar	21
1.2.5 Kaolin	22
1.2.6 Limestone	22
1.2.7 Phosphate	23
1.2.8 Strontium	23
1.2.9 Talc	23
1.3 Industry overview: potash	25
1.4 Industry overview: coal	26
1.5 European mine and mine waste production	28
1.6 Key environmental issues	31
1.6.1 Site location	32
1.6.2 Material characterisation including prediction of long-term behaviour	33
1.6.3 Environmentally relevant parameters	34
1.6.3.1 Typical emissions and management of water and reagent	34
1.6.3.2 The environmental impact of emissions	35
1.6.3.3 Acid rock drainage	36
1.6.3.4 Accidental bursts or collapses	38
1.6.4 Site rehabilitation and after-care	40
2 COMMON PROCESSES AND TECHNIQUES	41
2.1 Mining techniques	41
2.1.1 Types of orebodies	44
2.1.2 Underground mining methods	44
2.2 Mineralogy	45
2.3 Mineral processing techniques	46
2.3.1 Equipment	46
2.3.1.1 Comminution	46
2.3.1.1.1 Crushing	46
2.3.1.1.2 Grinding	47
2.3.1.2 Screening	48
2.3.1.3 Classification	49
2.3.1.3.1 Settling cones and hydraulic classifiers	49
2.3.1.3.2 Hydrocyclones	50
2.3.1.3.3 Mechanical classifiers	50
2.3.1.4 Gravity concentration	51
2.3.1.4.1 Dense medium separation	51
2.3.1.4.2 Jigging	53
2.3.1.4.3 Shaking tables	54
2.3.1.4.4 Spirals	54

2.3.1.4.5	Cones	55
2.3.1.5	Flotation	56
2.3.1.6	Magnetic separation	58
2.3.1.7	Electrostatic separation	58
2.3.1.8	Sorting	59
2.3.1.9	Leaching	59
2.3.1.10	Dewatering	60
2.3.2	Reagents	63
2.3.3	Effects on tailings characteristics	64
2.3.4	Techniques and processes	65
2.3.4.1	Alumina refining	65
2.3.4.2	Gold leaching with cyanide	66
2.4	Tailings and waste-rock management	70
2.4.1	Characteristics of materials in tailings and waste-rock management facilities	70
2.4.1.1	Shear strength	70
2.4.1.2	Other characteristics	70
2.4.2	Tailings dams	71
2.4.2.1	Delivery systems for slurried tailings	74
2.4.2.2	Confining dams	74
2.4.2.3	Deposition in the impoundment	80
2.4.2.4	Removal of free water	81
2.4.2.5	Seepage flow	83
2.4.2.6	Design flood	85
2.4.3	Thickened tailings	85
2.4.4	Tailings and waste-rock heaps	85
2.4.5	Backfilling	86
2.4.6	Underwater tailings management	88
2.4.7	Failure modes of dams and heaps	88
2.5	Tailings characteristics and tailings behaviour	89
2.6	Closure, rehabilitation and after-care of facility	90
2.7	Acid Rock Drainage (ARD)	91
3	APPLIED PROCESSES AND TECHNIQUES	93
3.1	Metals	96
3.1.1	Aluminium	96
3.1.1.1	Mineralogy and mining techniques	97
3.1.1.2	Mineral processing	97
3.1.1.3	Tailings management	98
3.1.1.3.1	Characteristics of tailings	98
3.1.1.3.2	Applied management methods	103
3.1.1.3.3	Safety of the TMF and accident prevention	107
3.1.1.3.4	Closure and after-care	107
3.1.1.4	Current emission and consumption levels	108
3.1.1.4.1	Management of water and reagents	108
3.1.1.4.2	Emissions to air	109
3.1.1.4.3	Emissions to water	110
3.1.1.4.4	Soil contamination	110
3.1.1.4.5	Energy consumption	110
3.1.2	Base metals	110
3.1.2.1	Mineralogy and mining techniques	111
3.1.2.2	Mineral processing	114
3.1.2.2.1	Comminution	116
3.1.2.2.2	Separation	119
3.1.2.3	Tailings management	121
3.1.2.3.1	Characteristics of tailings	122
3.1.2.3.2	Applied management methods	128
3.1.2.3.3	Safety of the TMF and accident prevention	143
3.1.2.3.4	Closure and after-care	149
3.1.2.4	Waste-rock management	152
3.1.2.4.1	Characteristics of waste-rock	152
3.1.2.4.2	Applied management methods	154
3.1.2.5	Current emissions and consumption levels	157
3.1.2.5.1	Management of water and reagents	157

3.1.2.5.2	Emissions to air	162
3.1.2.5.3	Emissions to water	165
3.1.2.5.4	Soil contamination.....	167
3.1.2.5.5	Energy consumption.....	168
3.1.3	Chromium	168
3.1.3.1	Mineralogy and mining techniques	168
3.1.3.2	Mineral processing	169
3.1.3.3	Tailings management	171
3.1.3.3.1	Characteristics of tailings	171
3.1.3.3.2	Applied management methods	171
3.1.3.3.3	Safety of the TMF and accident prevention	172
3.1.3.4	Waste-rock management.....	172
3.1.3.4.1	Site closure and after-care	172
3.1.3.5	Current emissions and consumption levels	173
3.1.3.5.1	Management of water and reagents	173
3.1.3.5.2	Emissions to air	173
3.1.3.5.3	Emissions to water	173
3.1.3.5.4	Soil contamination.....	174
3.1.3.5.5	Energy consumption.....	174
3.1.4	Iron.....	174
3.1.4.1	Mineralogy and mining techniques	174
3.1.4.2	Mineral processing	177
3.1.4.2.1	Comminution.....	177
3.1.4.2.2	Separation.....	177
3.1.4.3	Tailings management	178
3.1.4.3.1	Characteristics of tailings	178
3.1.4.3.2	Applied management methods	180
3.1.4.3.3	Development of new deposition methods	186
3.1.4.3.4	Safety of the TMF and accident prevention	187
3.1.4.3.5	Closure and after-care	189
3.1.4.4	Waste-rock management.....	189
3.1.4.4.1	Characteristics of waste-rock	190
3.1.4.4.2	Applied management methods	190
3.1.4.4.3	Safety of waste-rock facility and accident prevention.....	193
3.1.4.4.4	Site closure and after-care	193
3.1.4.5	Current emissions and consumption levels	194
3.1.4.5.1	Management of water and reagents	194
3.1.4.5.2	Emissions to air	195
3.1.4.5.3	Emissions to water	195
3.1.4.5.4	Soil contamination.....	197
3.1.4.5.5	Energy consumption.....	197
3.1.5	Manganese	198
3.1.5.1	Mineralogy and mining techniques	198
3.1.5.2	Tailings management	198
3.1.6	Precious metals (gold and silver)	198
3.1.6.1	Mineralogy and mining techniques	198
3.1.6.2	Mineral processing	199
3.1.6.2.1	Comminution.....	199
3.1.6.2.2	Separation.....	200
3.1.6.3	Tailings management	203
3.1.6.3.1	Characteristics of tailings	203
3.1.6.3.2	Applied management methods	205
3.1.6.3.3	Safety of the TMF and accident prevention	209
3.1.6.3.4	Closure and after-care	210
3.1.6.4	Waste-rock management.....	211
3.1.6.5	Current emissions and consumption levels	212
3.1.6.5.1	Management of water and reagents	213
3.1.6.5.2	Emissions to air	217
3.1.6.5.3	Emissions to water	218
3.1.6.5.4	Energy consumption.....	219
3.1.7	Tungsten.....	219
3.1.7.1	Mineralogy and mining techniques	219
3.1.7.2	Mineral processing	220

3.1.7.2.1	Comminution	221
3.1.7.2.2	Separation	221
3.1.7.3	Tailings management	222
3.1.7.3.1	Characteristics of tailings	223
3.1.7.3.2	Applied management methods	224
3.1.7.3.3	Safety of the TMF and accident prevention	225
3.1.7.3.4	Closure and after-care	225
3.1.7.4	Waste-rock management	225
3.1.7.5	Current emissions and consumption levels	226
3.1.7.5.1	Management of water and reagents	226
3.1.7.5.2	Emissions to air	226
3.1.7.5.3	Emissions to water	226
3.1.8	Costs	227
3.1.8.1	Operation	227
3.1.8.2	Closure	231
3.2	Industrial minerals	232
3.2.1	Barytes	232
3.2.1.1	Mineralogy and mining techniques	233
3.2.1.2	Mineral processing	233
3.2.1.3	Tailings management	235
3.2.1.4	Waste-rock management	236
3.2.2	Borates	236
3.2.2.1	Mineralogy and mining techniques	237
3.2.2.2	Mineral processing	237
3.2.2.3	Tailings management	238
3.2.3	Feldspar	239
3.2.3.1	Mineralogy and mining techniques	239
3.2.3.2	Mineral processing	239
3.2.3.3	Tailings management	244
3.2.3.3.1	Characteristics of tailings	244
3.2.3.3.2	Applied management methods	245
3.2.3.3.3	Safety of the TMF and accident prevention	245
3.2.3.4	Current emissions and consumption levels	245
3.2.3.4.1	Management of water and reagents	245
3.2.3.4.2	Energy consumption	246
3.2.4	Fluorspar	246
3.2.4.1	Mineralogy and mining techniques	246
3.2.4.2	Mineral processing	247
3.2.4.2.1	Gravity concentration	247
3.2.4.2.2	Flotation	247
3.2.4.2.3	The fluorspar/lead sulphide process	247
3.2.4.3	Tailings management	248
3.2.4.3.1	Applied management methods	248
3.2.4.3.2	Safety of the TMF and accident prevention	249
3.2.4.3.3	Closure and after-care	249
3.2.4.4	Waste-rock management	249
3.2.4.5	Current emissions and consumption levels	249
3.2.4.5.1	Management of water and reagents	249
3.2.4.5.2	Soil contamination	249
3.2.5	Kaolin	250
3.2.5.1	Mineralogy and mining techniques	250
3.2.5.2	Mineral processing	250
3.2.5.3	Tailings management	254
3.2.5.3.1	Characteristics of tailings	254
3.2.5.3.2	Applied management methods	254
3.2.5.3.3	Safety of the TMF and accident prevention	256
3.2.5.4	Waste-rock management	256
3.2.5.5	Current emissions and consumption levels	256
3.2.5.5.1	Management of water and reagents	256
3.2.5.5.2	Energy consumption	256
3.2.6	Limestone	257
3.2.6.1	Mineralogy and mining techniques	257
3.2.6.2	Mineral processing	257

3.2.6.3	Tailings management	260
3.2.6.3.1	Characteristics of tailings	260
3.2.6.3.2	Applied management methods	260
3.2.6.3.3	Safety of the TMF and accident prevention	261
3.2.6.3.4	Closure and after-care	262
3.2.6.4	Waste-rock management	262
3.2.6.5	Current emissions and consumption levels	262
3.2.6.5.1	Management of water and reagents	262
3.2.7	Phosphate	262
3.2.7.1	Mineralogy and mining techniques:	262
3.2.7.2	Mineral processing	263
3.2.7.3	Tailings management	264
3.2.7.4	Waste-rock management	265
3.2.7.5	Current emission and consumption levels	265
3.2.8	Strontium.....	265
3.2.8.1	Mineralogy and mining techniques	265
3.2.8.2	Mineral processing	265
3.2.8.3	Tailings management	265
3.2.9	Talc	267
3.2.9.1	Mineralogy and mining techniques	267
3.2.9.2	Mineral processing	267
3.2.9.3	Tailings management	268
3.2.9.4	Waste-rock management	269
3.2.10	Costs.....	269
3.3	Potash	270
3.3.1	Mineralogy and mining techniques	270
3.3.2	Mineral processing	273
3.3.2.1	Comminution	273
3.3.2.2	Separation.....	274
3.3.2.2.1	Hot leaching process	274
3.3.2.2.2	Flotation	276
3.3.2.2.3	Electrostatic separation.....	276
3.3.2.2.4	Heavy-media separation	277
3.3.2.3	De-brining	277
3.3.3	Tailings management	278
3.3.3.1	Characteristics of tailings	278
3.3.3.2	Applied management methods	279
3.3.3.2.1	Tailings heaps.....	279
3.3.3.2.2	Tailings piles	283
3.3.3.2.3	Backfill	283
3.3.3.2.4	Surface water discharge.....	284
3.3.3.2.5	Deep well discharge	285
3.3.3.2.6	Marine tailings management	286
3.3.3.3	Safety of the TMF and accident prevention	286
3.3.3.4	Closure and after-care	286
3.3.4	Waste-rock management.....	287
3.3.5	Current emission and consumption levels.....	287
3.3.5.1	Management of water and reagents.....	287
3.3.5.2	Emissions to water	287
3.4	Coal	288
3.4.1	Mineralogy and mining techniques	288
3.4.2	Mineral processing.....	289
3.4.3	Tailings management	291
3.4.3.1	Characteristics of tailings	291
3.4.3.2	Applied management methods	291
3.4.3.2.1	Tailings heaps.....	293
3.4.3.2.2	Tailings basins/ponds	296
3.4.3.3	Safety of the TMF and accident prevention	298
3.4.3.4	Site closure and after-care	298
3.4.4	Waste-rock management.....	299
3.4.5	Current emission and consumption levels.....	299
3.4.5.1	Management of water and reagents.....	299
3.4.5.2	Emissions to air	300

3.4.5.3	Emissions to water.....	300
4	TECHNIQUES TO CONSIDER IN THE DETERMINATION OF BAT	303
4.1	General principles.....	303
4.2	Life-cycle management	304
4.2.1	Design phase.....	304
4.2.1.1	Environmental baseline	305
4.2.1.2	Characterisation of tailings and waste-rock.....	306
4.2.1.3	TMF/WRMF studies and plans.....	307
4.2.1.4	TMF/WRMF and associated structures design.....	316
4.2.1.5	Control and monitoring.....	319
4.2.2	Construction phase	321
4.2.3	Operational phase	321
4.2.3.1	Operation, supervision and maintenance (OSM) manuals.....	323
4.2.3.2	Auditing	327
4.2.4	Closure and after-care phase.....	328
4.2.4.1	Long-term closure objectives.....	329
4.2.4.2	Specific closure issues	333
4.3	Emission prevention and control	340
4.3.1	ARD management	340
4.3.1.1	Prediction of ARD potential	340
4.3.1.2	Prevention options	341
4.3.1.2.1	Water covers	342
4.3.1.2.2	Dry cover	344
4.3.1.2.3	Subaqueous tailings disposal of reactive tailings.....	349
4.3.1.2.4	Oxygen consuming cover	351
4.3.1.2.5	Wetland establishment.....	352
4.3.1.2.6	Raised groundwater table.....	352
4.3.1.2.7	Depyritisation	353
4.3.1.2.8	Selective material handling.....	353
4.3.1.3	Control options	354
4.3.1.3.1	Addition of buffering material	355
4.3.1.4	Treatment options	355
4.3.1.5	Decision making for closure of ARD generating sites.....	355
4.3.1.6	ARD management at a talc operation.....	356
4.3.2	Techniques to reduce reagent consumption.....	357
4.3.2.1	Computer-based process control.....	357
4.3.2.2	Operational strategies to minimise cyanide addition	358
4.3.2.2.1	Automatic cyanide control.....	358
4.3.2.2.2	Peroxide pretreatment	359
4.3.2.3	Pre-sorting	359
4.3.3	Prevention of water erosion.....	360
4.3.4	Dust prevention	360
4.3.4.1	Beaches.....	360
4.3.4.2	Slopes	362
4.3.4.3	Transport.....	362
4.3.4.3.1	Conveyor belt.....	362
4.3.4.3.2	Trucks	363
4.3.5	Techniques to reduce noise emissions	363
4.3.6	Progressive restoration/revegetation.....	364
4.3.7	Water balances.....	366
4.3.8	Drainage of ponds.....	367
4.3.9	Free water management.....	367
4.3.10	Seepage management	368
4.3.10.1	Seepage prevention and reduction	368
4.3.10.2	Seepage control.....	371
4.3.10.3	Potash tailings heaps.....	371
4.3.10.4	Coal tailings heaps.....	372
4.3.11	Techniques to reduce emissions to water	376
4.3.11.1	Re-use of process water	376
4.3.11.2	Washing of tailings	376
4.3.11.3	Dissolved metals treatment.....	376
4.3.11.4	Suspended solids and dissolved components.....	377

4.3.11.4.1	Sedimentation ponds	377
4.3.11.5	Acid water treatment	378
4.3.11.6	Alkaline water treatment	381
4.3.11.7	Arsenic treatment	382
4.3.11.8	Cyanide treatment	383
4.3.11.9	Permeable reactive barriers	386
4.3.12	Groundwater monitoring	387
4.3.13	After-care	387
4.3.13.1	Alumina red mud TMF	387
4.4	Accident prevention	387
4.4.1	Tailings or waste-rock management in a pit	387
4.4.2	Diversion of natural run-off	388
4.4.2.1	Ponds	388
4.4.2.2	Heaps	388
4.4.3	Preparation of the natural ground below the dam	389
4.4.4	Dam construction material	389
4.4.5	Tailings deposition	389
4.4.6	Techniques to construct and raise dams	389
4.4.6.1	Conventional dams	391
4.4.6.2	The upstream method	392
4.4.6.3	The downstream method	393
4.4.6.4	The centreline method	394
4.4.7	Free water management	394
4.4.7.1	Removal of free water	394
4.4.8	Freeboard	395
4.4.9	Emergency discharge	395
4.4.10	Design flood determination for tailings ponds	396
4.4.11	Drainage of dams	396
4.4.11.1	Permeable dams	396
4.4.11.2	Impermeable dams	397
4.4.12	Monitoring of seepage	397
4.4.13	Dam and heap stability	398
4.4.13.1	Safety factor	398
4.4.13.2	Kaolin tailings heap stability	399
4.4.13.3	Limestone tailings dam stability	399
4.4.14	Techniques to monitor the stability of dams and heaps	400
4.4.14.1	Development of a monitoring plan	400
4.4.14.2	Measurements, instrumentation and frequency for tailings dams monitoring	400
4.4.14.3	Inspection and audits/reviews	401
4.4.14.4	Stability of the supporting strata	403
4.4.15	Cyanide management	403
4.4.16	Dewatering of tailings	403
4.4.16.1	'Dry tailings'	404
4.4.16.2	Thickened tailings	405
4.4.16.3	Dewatering of fine coal tailings	408
4.5	Reduction of footprint	408
4.5.1	Backfilling of tailings	408
4.5.1.1	Backfilling as part of the mining method	409
4.5.1.2	Backfilling in small-scale open pit mining	410
4.5.1.3	Backfilling of filtered tailings	410
4.5.1.4	Partial backfilling in open pits	411
4.5.1.5	Backfilling in a mined-out pit	411
4.5.1.6	Backfilling underground stopes	411
4.5.1.7	Backfilling in underground coal mining	411
4.5.1.8	Addition of binders	412
4.5.1.9	Drainage of backfilled stopes	412
4.5.1.10	Paste fill	413
4.5.2	Backfilling of waste-rock	414
4.5.3	Underwater tailings management	414
4.5.4	Other uses of tailings and waste-rock	416
4.6	Mitigation of accidents	417
4.6.1	Emergency planning	417
4.6.2	Evaluation and follow-up of incidents	417

4.6.3	Tailings pipeline burst	418
4.7	Environmental management tools	418
5	BEST AVAILABLE TECHNIQUES FOR THE MANAGEMENT OF TAILINGS AND WASTE-ROCK IN MINING ACTIVITIES.....	427
5.1	Introduction	427
5.2	Generic	428
5.3	Gold leaching using cyanide.....	434
5.4	Aluminium.....	434
5.5	Potash	434
5.6	Coal.....	434
5.7	Environmental management	435
6	EMERGING TECHNIQUES FOR THE MANAGEMENT OF TAILINGS AND WASTE-ROCK IN MINING ACTIVITIES	437
6.1	Co-disposal of iron ore tailings and waste-rock.....	437
6.2	Inhibiting progress of ARD	437
6.3	Recycling of cyanide using membrane technology	438
6.4	Lined cells.....	439
6.5	Utilisation of treated red mud to remediate problems of ARD and metals pollution.....	439
6.6	Combination of SO ₂ /air and hydrogen peroxide technique to destroy cyanide	439
7	CONCLUDING REMARKS.....	441
	GLOSSARY	451
	ANNEXES	469
	Annex 1	469
	Annex 2	477
	Annex 3	483
	Annex 4	486
	Annex 5	508
	Annex 6	509

List of figures

Figure 1.1:	Primary cadmium production in Europe in 1999.....	5
Figure 1.2:	Copper mining production in Europe in 1999	5
Figure 1.3:	Lead mine production in Europe in 1999	6
Figure 1.4:	World nickel mine production in 2001	7
Figure 1.5:	World tin mining production in 1999	8
Figure 1.6:	Zinc mining production in Europe in 1999.....	9
Figure 1.7:	Iron mining production in Europe in 1999	10
Figure 1.8:	Manganese mining production in Europe in 1999	12
Figure 1.9:	World manganese mine production in 1999	12
Figure 1.10:	Gold mining production in Europe in 1999	14
Figure 1.11:	Silver mining production in Europe in 1999.....	15
Figure 1.12:	World gold mining production in 2001	15
Figure 1.13:	World distribution of gold or gold and silver mines using cyanidation in 2000.....	16
Figure 1.14:	Barytes mining production in Europe in 2000.....	18
Figure 1.15:	World barytes production (production figures) in 2000	19
Figure 1.16:	Feldspar mining production in Europe in 1999	20
Figure 1.17:	Fluorspar mining production in Europe (1999)	21
Figure 1.18:	Kaolin production in Europe in 1999.....	22
Figure 1.19:	Talc mine production in Europe (1999).....	24
Figure 1.20:	Potash mining production (K ₂ O) in Europe in 1999.....	25
Figure 1.21:	Schematic illustration of some of the most important geochemical and physical processes and their interaction and contribution to the possible release of heavy metals from mining waste	37
Figure 1.22:	Schematic illustration of the drainage water generation as a function of the interaction between the tailings or waste-rock in the facility and the atmosphere.....	38
Figure 1.23:	Example of a large tailings pond (330 Mm ³).....	38
Figure 1.24:	Example of a small tailings settling basin.....	39
Figure 2.1:	Transition from open pit to underground mining.....	42
Figure 2.2:	Schematic drawing of an open pit.....	43
Figure 2.3:	Schematic drawing of an underground mine	43
Figure 2.4:	Ball mill	47
Figure 2.5:	Grinding circuit with AG mills (primary grinding, right side) and ball mills (secondary grinding, left side).....	48
Figure 2.6:	Hydraulic classifier	49
Figure 2.7:	Hydrocyclone.....	50
Figure 2.8:	Rake and spiral classifiers.....	51
Figure 2.9:	Drewboy bath	52
Figure 2.10:	Denver mineral jig	53
Figure 2.11:	Shaking table	54
Figure 2.12:	Spiral bank	55
Figure 2.13:	Reichert cone	56
Figure 2.14:	Flotation process.....	56
Figure 2.15:	Mechanical flotation cell	57
Figure 2.16:	Pneumatic flotation cell	57
Figure 2.17:	Low-intensity drum separators	58
Figure 2.18:	Heap leaching	60
Figure 2.19:	Leaching tank	60
Figure 2.20:	Continuous thickener	61
Figure 2.21:	Plate-and-frame filter press.....	62
Figure 2.22:	Drum filter	62
Figure 2.23:	Disk filter	63
Figure 2.24:	Typical flow sheet of Bayer-process.....	65
Figure 2.25:	The principles of gold recovery by leaching.....	67
Figure 2.26:	Dam water cycle changed from	71
Figure 2.27:	Illustration of a tailings pond in an existing pit	72
Figure 2.28:	Picture of a tailings pond in an existing pit.....	72
Figure 2.29:	Illustration of tailings pond on a valley site.....	72
Figure 2.30:	Illustration of an off-valley site tailings pond.....	73
Figure 2.31:	Tailings pond on flat land (Courtesy of AngloGold, South African Division).....	73

Figure 2.32: Example of a beach at an alumina refinery's red mud pond	75
Figure 2.33: Conventional dam	75
Figure 2.34: Staged conventional dam	76
Figure 2.35: Staged dam with upstream low permeability zone	76
Figure 2.36: Dam with tailings low permeability core zone	77
Figure 2.37: Row of hydrocyclones on the crest of a dam	77
Figure 2.38: Types of sequentially raised dams with tailings in the structural zone	78
Figure 2.39: Upstream method using cycloned tailings	78
Figure 2.40: Dams raised using the upstream method at the Aughinish site	79
Figure 2.41: Downstream construction of a dam using hydrocyclones	79
Figure 2.42: Centreline method	80
Figure 2.43: Tower decanting system	82
Figure 2.44: Chute decanting system	82
Figure 2.45: Pump barge	83
Figure 2.46: Simplified seepage flow scenarios for different types of tailings ponds	84
Figure 2.47: Schematic drawing of thickened tailings management operation	85
Figure 3.1: Typical mass flow from Bauxite to Aluminium (dry basis)	98
Figure 3.2: Size distribution (particle size vs. cumulative % passing) of red mud at the Sardinian (EA) and Aughinish sites	99
Figure 3.3: Solids content (in % solids by weight) of tailings for thickened and conventional management schemes	100
Figure 3.4: Size distribution (particle size vs. cumulative % passing) of process sand at the Sardinian (EA) and Aughinish sites	102
Figure 3.5: Location of TMF at the Sardinian refinery	103
Figure 3.6: Cross-section of tailings dam at Sardinian site	104
Figure 3.7: Cross-section of dam raises using the upstream method	105
Figure 3.8: Cross-sectional view of TMF at Ajka showing the dam, pond, observation wells, separation wall and ground conditions, as well as the soil cover upon closure	106
Figure 3.9: Cross-section of the tailings dam at the Galician refinery showing the upstream and centreline methods of increasing the dam height	106
Figure 3.10: Bulk/selective flotation circuit for Zinkgruvan site	115
Figure 3.11: Possible selective mineral processing circuit for Zinkgruvan site	115
Figure 3.12: Mineral processing flow sheet at Hitura site	116
Figure 3.13: Year 2000 situation of Aitik tailings and clarification ponds	129
Figure 3.14: Cross-section of dam at Aitik	130
Figure 3.15: Cross-section of dam at Garpenberg before latest raise	131
Figure 3.16: TMF set-up at Pyhäsalmi site	135
Figure 3.17: Top view of the Zinkgruvan TMF	137
Figure 3.18: Water balance for the Zinkgruvan operation	138
Figure 3.19: Cross-sectional view of dam at Lisheen TMF. Pond is to the right of the dam	140
Figure 3.20: Tailings distribution system at Lisheen	142
Figure 3.21: Electrically driven winch controlling the tailings distribution pipeline at the Lisheen TMF	142
Figure 3.22: Ditch for collection and flow measuring of seepage water alongside the dam	147
Figure 3.23: Another ditch for collection and flow measuring of seepage water alongside the dam	147
Figure 3.24: Structure of waste-rock dump cover and illustration of the decommissioned waste-rock dump at the Aitik site	155
Figure 3.25: Water balance at Hitura	158
Figure 3.26: Water balance at Pyhäsalmi for the year 2001	159
Figure 3.27: Water balance for the Zinkgruvan operations shown as average annual flows and maximum flow during operation	160
Figure 3.28: Annual average zinc concentration (in mg/l) in excess water from the clearing pond to the recipient and calculated transport (kg/yr) 1984 - 2000	167
Figure 3.29: Flow sheet of the mineral processing plant at Kemi	170
Figure 3.30: Illustration of the Malmberget ore deposit	175
Figure 3.31: Kiruna concentrator	178
Figure 3.32: Cross-section of Malmberget tailing dam	184
Figure 3.33: Steirischer Erzberg	185
Figure 3.34: Schematic flow sheet of an example gold mineral processing circuit	200
Figure 3.35: Schematic drawing of CIL process	202
Figure 3.36: Acid forming potential vs. neutralisation potential graph of samples from Ovacik site	204
Figure 3.37: Cross-sectional drawing of Ovacik tailings pond	206
Figure 3.38: Composite liner set-up at Ovacik site	207

Figure 3.39:	Cross-sectional view of dam at Boliden site.....	208
Figure 3.40:	Schematic illustration of tailings and effluent treatment at Orivesi mine.....	209
Figure 3.41:	Environmental monitoring locations at Ovacik site.....	212
Figure 3.42:	Seasonal variations of water quality in the tailings pond and the recipient at Boliden in 2001	214
Figure 3.43:	Water balance at Boliden site	215
Figure 3.44:	Water cycle at Orivesi site	217
Figure 3.45:	Flow sheet of Mittersill mineral processing plant.....	222
Figure 3.46:	Size distribution of feed to mineral processing plant and tailings at Mittersill site	224
Figure 3.47:	Flow sheet of barytes mineral processing plant using jigs and flotation.....	234
Figure 3.48:	Dewatering of barytes tailings in the pit	236
Figure 3.49:	Dewatering of tailings in concrete basins	236
Figure 3.50:	Simplified flow sheet of the production of refined boron products	237
Figure 3.51:	Feldspar particle vs. recovery graph	240
Figure 3.52:	Flow sheet for Feldspar recovery using flotation.....	241
Figure 3.53:	Dry processing step in the recovery of feldspar.....	242
Figure 3.54:	Typical kaolin process flow sheet.....	251
Figure 3.55:	Kaolin grain size vs. quantity graph	252
Figure 3.56:	Calcium carbonate process flow sheet.....	259
Figure 3.57:	Flow sheet of the Siilinjärvi mineral processing plant.....	263
Figure 3.58:	Old strontium TMF with tailings in structural zone	266
Figure 3.59:	New strontium TMF with a synthetic liner and decant towers	266
Figure 3.60:	Talc process flow sheet using flotation.....	268
Figure 3.61:	Sub-horizontal potash deposit.....	271
Figure 3.62:	Steeply dipping potash deposit	271
Figure 3.63:	Sublevel stoping with backfill in steep potash deposits.....	272
Figure 3.64:	Dry grinding and screening (schematic) of potash ore	274
Figure 3.65:	Flow diagram of the hot leaching-crystallisation process used for the production of KCl from potash minerals (schematic).....	275
Figure 3.66:	Flow diagram of a flotation plant (schematic).....	276
Figure 3.67:	Flow diagram of an electrostatic separation process (schematic).....	277
Figure 3.68:	Distribution of products, solid and liquid tailings after mineral processing	278
Figure 3.69:	Mineral composition of sylvinites and hard salt tailings	278
Figure 3.70:	Aerial view of a salt tailings heap.....	280
Figure 3.71:	Schematic drawing of a tailings heap in German potash mining.....	281
Figure 3.72:	Photo of a conveyor belt with an underlying reverse belt.....	282
Figure 3.73:	Typical cross-section of Canadian tailings piles (schematic)	283
Figure 3.74:	Backfill system of solid tailings (sodium chloride) at the plant Unterbreizbach, Germany	284
Figure 3.75:	Water retention basin of German potash mine.....	285
Figure 3.76:	Management of three potash mines (WI, HA, UB) in the Werra area, Germany	285
Figure 3.77:	Standard flow sheet for coal mineral processing	289
Figure 3.78:	Tailings production and applied management methods in the Ruhr, Saar and Ibbenbüren areas in year 2000	292
Figure 3.79:	Development of tailings heap design in the Ruhr, Saar and Ibbenbüren areas	293
Figure 4.1:	Illustration of the information flow for a 'design for closure'	304
Figure 4.2:	Dams for permanent water covers	336
Figure 4.3:	Dams for dewatered ponds	337
Figure 4.4:	Typical covers for tailings management areas.....	339
Figure 4.5:	Implemented measures at Stekenjokk TMF	342
Figure 4.6:	Ratio between the effective diffusion coefficient in a porous material partially water- saturated and diffusion in air	345
Figure 4.7:	Four different soil-cover designs	346
Figure 4.8:	Collection and discharge channel at closed Apirsa tailings pond	349
Figure 4.9:	Decision tree for closure of a potentially ARD generating tailings and waste-rock management facility.....	356
Figure 4.10:	Example of a hillside dump	365
Figure 4.11:	Example of an alternative construction of a hillside dump.....	365
Figure 4.12:	Dam water cycle	366
Figure 4.13:	Composite liner set-up at Ovacik site	367
Figure 4.14:	Available types of liner systems	369
Figure 4.15:	Schematic drawing of tailings heap construction in the Ruhr, Saar and Ibbenbüren areas	373

Figure 4.16: Tailings heap design – options for avoiding negative effects on ground and surface water system.....	375
Figure 4.17: Flow sheet of a water treatment plant for low pH process water	379
Figure 4.18: Treatment of alkaline water at an aluminium refinery	382
Figure 4.19: Schematic comparison of upstream and downstream method.....	390
Figure 4.20: Simplified comparison of the phreatic surface for upstream and downstream method of tailings dam construction	393
Figure 4.21: Decant well at Ovacik site.....	394
Figure 4.22: Dam without and with drainage system	397
Figure 4.23: Comparison of thickened tailings system and conventional tailings pond in same geological setting	407
Figure 4.24: Cut-and-fill mining using backfill (hydraulic sandfill) as a working platform to extract the ore.....	410
Figure 4.25: Backfill drainage system	413

List of tables

Table 1.1:	Production of metal concentrates within Europe as percentages of world metal concentrate production in 1999.....	2
Table 1.2:	Alumina refineries in Europe alumina production year 1999.....	3
Table 1.3:	Production of some industrial minerals within Europe as a percentage of world production in 1999.....	17
Table 1.4:	Coal production figures in kt, 1980, 1996-2001.....	27
Table 1.5:	European mine production expressed in % of total European production of ferrous, non-ferrous and precious metals in 1999 (unless otherwise indicated).....	29
Table 1.6:	European mine production expressed in percentage of total European production of industrial minerals and coal in 1999 (unless otherwise indicated).....	30
Table 1.7:	European waste generation.....	31
Table 1.8:	Effects of some metals on humans, animals and plants.....	35
Table 2.1:	Most important underground mining methods and their areas of application.....	44
Table 2.2:	Effects of mineral processing steps on tailings characteristics.....	64
Table 2.3:	Effects of tailings characteristics on engineering properties and safety/environmental behaviour of tailings.....	89
Table 3.1:	Summary of applied processes in the management of tailings.....	95
Table 3.2:	Summary of applied processes in the management of waste-rock.....	96
Table 3.3:	Alumina refineries mentioned in this section.....	96
Table 3.4:	Chemical composition of bauxites fed to European refineries.....	97
Table 3.5:	Constituents of red mud.....	100
Table 3.6:	Detailed analysis of red mud, including trace metals.....	101
Table 3.7:	Constituents of tailings sand.....	102
Table 3.8:	Consumption of reagents at Ajka refinery.....	108
Table 3.9:	Base metals sites mentioned in this section.....	110
Table 3.10:	Information on mining technique, ore and waste-rock production of base metal mines ...	113
Table 3.11:	Equipment types used for comminution, number of lines and throughput.....	119
Table 3.12:	Per cent of tailings backfilled at base metal operations.....	122
Table 3.13:	Particle size distribution of tailings at the Boliden site.....	123
Table 3.14:	Average results of tailings analysis at the Garpenberg site (2001).....	125
Table 3.15:	Size distribution of tailings at the Garpenberg site.....	125
Table 3.16:	Typical size distribution of backfilled tailings at Garpenberg site.....	126
Table 3.17:	Chemical analysis of tailings from the Legnica-Glogow copper basin.....	126
Table 3.18:	Particle size distribution of tailings from the Legnica-Glogow copper basin.....	127
Table 3.19:	Mineralogical composition of tailings at the Neves Corvo site.....	127
Table 3.20:	Chemical analysis of tailings at the Zinkgruvan site.....	128
Table 3.21:	Characteristic data for the existing dams X-Y and E-F at Zinkgruvan site.....	137
Table 3.22:	Control parameters and applied monitoring at Legnica-Glogow copper basin.....	145
Table 3.23:	Basic measuring regime to be performed at new dams.....	146
Table 3.24:	Example of monitoring scheme of TMF.....	148
Table 3.25:	Structure for cover of Zinkgruvan TMF.....	152
Table 3.26:	Waste-rock mineralogy at Zinkgruvan.....	153
Table 3.27:	Amounts of waste-rock backfilled and deposited in the Boliden area.....	156
Table 3.28:	Water consumption and water use/re-use of base metal sites.....	157
Table 3.29:	Consumption of reagents of base metal sites.....	161
Table 3.30:	Measurements of total sedimented particles and Cu at Aitik.....	162
Table 3.31:	Dust immissions from tailings pond in the Legnica-Glogow copper basin.....	163
Table 3.32:	Annual medium concentrations of particulate matter (total) and metals content in ambient air within close proximity (60-2250 m) of the tailings pond in the Legnica-Glogow copper basin.....	164
Table 3.33:	Emissions to air at the Lisheen site.....	164
Table 3.34:	Total emissions per year to water from base metals sites.....	165
Table 3.35:	Concentrations in emissions from base metals sites.....	165
Table 3.36:	Energy consumption at base metal sites.....	168
Table 3.37:	Consumption of reagents and steel at the Kemi site.....	173
Table 3.38:	Emissions to surface water at Kemi site.....	173
Table 3.39:	Energy consumption data at Kemi site.....	174
Table 3.40:	Average concentrations in wet-sorting tailings from Kiruna and Svappavaarra.....	179

Table 3.41:	Average trace element concentrations for wet-sorting tailings and other tailings material at Kiruna and Svappavaarra	179
Table 3.42:	Size distribution of tailings from gravity separation	180
Table 3.43:	Size distribution of tailings after separation by screw classifiers	180
Table 3.44:	Characteristics of the Kiruna tailings dam system	181
Table 3.45:	Characteristics of the Svappavaara tailings dam system	182
Table 3.46:	Characteristic data for the Malmberget tailings and clarification ponds and dams	184
Table 3.47:	Average concentrations of an iron ore tailings facility discharge to surface waters for 2001	196
Table 3.48:	List of current European gold producers known/reported to date	198
Table 3.49:	Acid production potential at Ovacik Gold Mine	204
Table 3.50:	Particle size of tailings at Boliden mine	204
Table 3.51:	Discharged water from Boliden TMF from 1997 - 2001	213
Table 3.52:	2001 unit reagent consumption at Orivesi mine	217
Table 3.53:	Emissions to air from Boliden gold leaching plant	218
Table 3.54:	Emissions to surface water from Boliden site	218
Table 3.55:	Emissions to water from Orivesi site	219
Table 3.56:	Leachate test results of tailings at Mittersill site	223
Table 3.57:	Heavy metal contents of tailings at Mittersill site	224
Table 3.58:	1997 averages of parameters measured in discharge from TMF of Mittersill site	226
Table 3.59:	Costs for tailings and waste-rock management at metal sites	227
Table 3.60:	Tailings management costs in the Legnica-Glogow copper basin	228
Table 3.61:	Relevant tailings generated, distance and elevation between mineral processing plants and the tailings pond in the Legnica-Glogow copper basin	228
Table 3.62:	Relevant amounts of water returned to mineral processing plants, distance and elevation between mineral processing plants and the tailings pond in the Legnica-Glogow copper basin	228
Table 3.63:	Cost of other operations relevant to the management of tailings and waste-rock	229
Table 3.64:	Operating cost in USD for CN destruction using the SO ₂ /air method in 2001	230
Table 3.65:	Cost information for closure and after-care of metalliferous mining tailings and waste-rock management	231
Table 3.66:	Barytes mines in Europe	232
Table 3.67:	Tailings management methods applied to Barytes mines in Europe	235
Table 3.68:	Tailings management options at European barytes operations	235
Table 3.69:	Inputs and outputs from the main steps of the borate process	238
Table 3.70:	List of the tailings released from the process and the type of management applied	238
Table 3.71:	Inputs and outputs from feldspar mineral processing steps	243
Table 3.72:	Example of a chemical analysis of feldspar tailings eluate	244
Table 3.73:	Products and tailings from the mineral processing of feldspar	244
Table 3.74:	Inputs and outputs in the processing of Kaolin	253
Table 3.75:	Tailings and products from Kaolin mineral processing	254
Table 3.76:	Reagents used in the flotation of kaolin	256
Table 3.77:	Production figures of calcium carbonate in the EU in 2000	258
Table 3.78:	Most common salt minerals in potash deposits	270
Table 3.79:	Marine salt minerals	270
Table 3.80:	Tailings heaps of the German potash mines	280
Table 3.81:	Tailings heaps at the Prosper Haniel colliery in the Ruhr region	294
Table 3.82:	Effects on TMF resulting from past mining activities	296
Table 3.83:	Tailings ponds influenced by mining-induced ground movements: Catalogue of potential risks and counter measures	297
Table 3.84:	Amount of discharge and concentrations of emissions from tailings ponds/basins in the Ostrava and Karviná area in 2000	301
Table 4.1:	Classification with regards to loss of lives or serious injury	323
Table 4.2:	Classification with regard to damage to infrastructure, environment and property	324
Table 4.3:	Classification of dams according to Norwegian legislation	324
Table 4.4:	Classification of dams according to Spanish legislation	325
Table 4.5:	Summary of criteria for closure	329
Table 4.6:	Acid production potential at Ovacik Gold Mine	340
Table 4.7:	ARD prevention methods and the principle on which they are based on	341
Table 4.8:	ARD control methods and the principle on which their function is based	354
Table 4.9:	Dispersion by wind erosion of solid tailings from tailings and waste-rock management facilities and prevention options	360
Table 4.10:	Dust reduction approaches in transport	362

Table 4.11:	Summary of seepage control measures.....	371
Table 4.12:	Applied CN treatment processes.....	383
Table 4.13:	CN levels at European sites using cyanidation	385
Table 4.14:	Comparison of dam construction techniques	391
Table 4.15:	Typical measurements their frequency and instrumentation for tailings dams monitoring.....	400
Table 4.16:	Typical measurements their frequency and instrumentation for heaps monitoring	401
Table 4.17:	Tailings dam assessment regime during operation and in the after-care phase	401
Table 4.18:	Heaps assessment regime during operation and in the after-care phase	401

SCOPE

The basis for this work is the Communication from the European Commission on the ‘Safe Operation of Mining Activities’ (COM(2000) 664 final). One of the follow-up measures suggested in this Communication is the compilation of a BAT reference document. Under paragraph 6.3, the Communication says that the BAT document should aim to “prevent similar (to Aznalcóllar or Baia Mare) accidents in the future” and that “the processing of certain mining minerals and residues could be included (in the scope of the document)”

Against this background, a stakeholder Technical Working Group (TWG) was established and the group decided on the following scope of the work:

Horizontal Scope

The mining, processing and tailings management associated with the mining of gas and liquid (e.g. oil and salt from brine) will not be covered in this work. This is because the processes are very much different from the processing of dry ores, and the tailings issue is also very different to the other sectors to be covered. However, metals leaching will be covered.

The underlying theme of this work covers mineral processing, tailings and the waste-rock management of ores that have the potential for a strong environmental impact or that can be considered as examples of “good practice”. The intention here is to raise awareness of best practices across all activities in this sector.

The following metals are covered in this document on the basis that they are mined and/or processed in the European Union (EU-15), the acceding countries, the candidate countries and Turkey, i.e.:

- aluminium
- cadmium
- chromium
- copper
- gold
- iron
- lead
- manganese
- mercury
- nickel
- silver
- tin
- tungsten
- zinc.

These metals will be covered, irrespective of the amounts produced or the mineral processing method used (e.g. whether mechanical methods are used, such as flotation, or whether by chemical or hydrometallurgical methods such as leaching, etc.).

The group decided, following the above-mentioned theme to also include selected industrial minerals and coal in this document.

In order to keep the work within a reasonable time frame, it was decided that not all industrial minerals would be covered. A selection was thus made based on two factors:

1. significant production within EU-15, the acceding countries, the candidate countries and Turkey, and
2. the generation of tailings that could have a high environmental impact if not handled properly.

Scope

In addition to this classification though, some further minerals will be addressed if the management of their tailings and waste-rock is considered as examples of “good practice” that may be applicable to other minerals.

On these bases the following industrial minerals are included in this document:

- barytes
- borates
- feldspar (if recovered by flotation)
- fluorspar
- kaolin (if recovered by flotation)
- limestone (if processed)
- phosphate
- potash
- strontium
- talc (if recovered by flotation).

It was noted that tailings only result from the processing of feldspar and kaolin if they are recovered by flotation.

Coal is only included when it is processed and there are tailings produced (thereby following the above-mentioned theme). Generally, this means that hard coal (or rock coal or black coal) is covered, whereas lignite (or brown coal), which is usually not processed, is not covered.

Oil shale is processed in Estonia and large amounts of tailings result, which need to be managed. Therefore, it was decided to include this in the document.

The issue of abandoned sites, with regard to the management of tailings and waste-rock, is not addressed in this work. However, some examples of recently closed sites are discussed.

Vertical Scope

For all minerals defined in the horizontal scope the document will:

- look at waste-rock management
- include topsoil and overburden if they are used in the management of tailings
- include mineral processing relevant to tailings management (e.g. as far as the mineral processing influences the characteristics and behaviour of the tailings)
- focus on tailings management, e.g. in ponds/dams, heaps or as backfill.

The figure below illustrates the vertical scope. The shaded boxes show the process steps covered by this document.

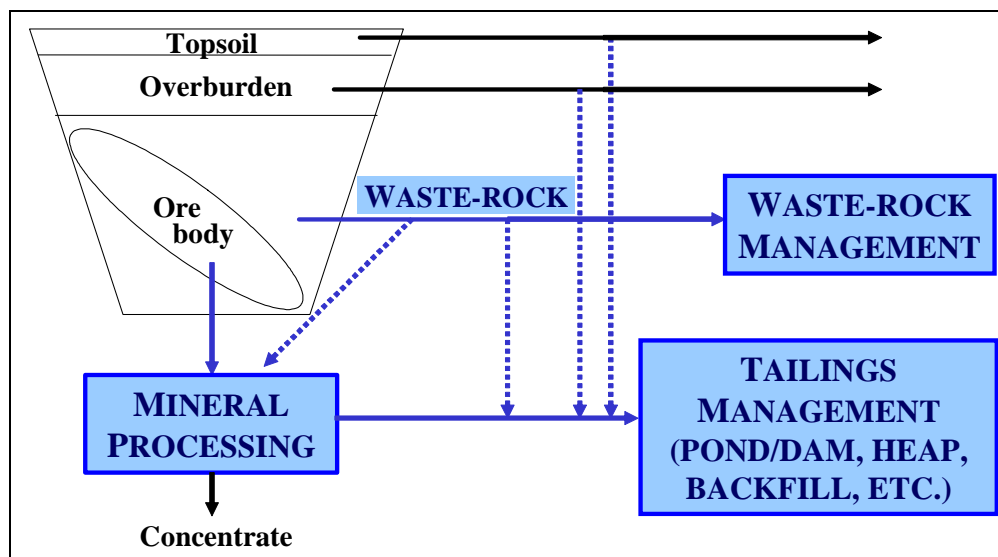

Illustration of vertical scope

In this document:

‘mine production’ means: for metals, the amount of metal in the concentrate after production, and in all other cases, unless stated otherwise, the amount of concentrate by weight after mineral processing;

‘Europe’ means current EU Member States (EU-15), the acceding countries, the candidate countries and Turkey;

‘TMF’ means ‘Tailings Management Facility’, which can be a pond/dam system, backfill, a tailings heap or any other way of managing tailings.

Other explanations of technical terms used in the document can be found in the Glossary.

1 GENERAL INFORMATION

Mining is one of mankind's oldest industries. This industry has a significant history throughout Europe. Archaeological investigations at the Los Frailes mine in southern Spain discovered the body of a worker with a copper collar dated 1500 bc. However, there are older examples of mineral working in Europe, including Neolithic flint working, and metalliferous mining dating back to almost 2000 bc. Mining has been undertaken by many civilisations and has in many areas been a source of wealth and importance. A good example in more recent times is the importance of coal mining (together with other 'heavy industries') in Germany for the 'Wirtschaftswunder' after World War II.

In the last few decades, metals and coal mining on a worldwide scale have moved away from underground operations towards larger bulk mining in open pits. As a consequence now larger amounts of residues result from these operations, mainly because the often unwanted topsoil and overburden have to be removed to gain access to the ore. In many cases, the amount of overburden and waste-rock that have to be transported is many times more than the tonnage of ore that is extracted. The amount of tailings generated depends on the content of the desirable mineral(s) in the ore, its grade, and the efficiency of the mineral processing stage in recovering this/these. Another factor is the duration of an operation. As already stated, the total amount of tailings can be very large in comparison to the amount of product, unless there is a sufficient way to use the residues. Grades vary between several grams per tonne of ore to 100 % (i.e. pure metal or mineral). The increase of bulk mining in open pits has also led to mining becoming a more capital intensive business, where in many cases it can take many years before the invested money is 'returned' through the sold product, i.e. typically the concentrates.

The purpose of mining is to meet the demand for metals and minerals resources to develop infrastructure etc. and to improve the quality of life of the population as the extracted substances are the raw materials for the manufacture of many goods and materials. These can be, for example, metalliferous minerals or metals, coal, or industrial minerals that are used in the chemical sector or for construction purposes. At any rate, the management of the residues produced, the topsoil, overburden, and, of special concern in this document, the tailings and waste-rock, presents an undesired financial burden on operators. Typically the mine and the mineral processing plant are designed to extract as much marketable product(s) as possible. The residue and overall environmental management is then designed as a consequence of these process steps.

Some parts of the mining industry, such as metal and coal mining within Europe, operate under severe economic conditions, mainly because the deposits can no longer compete on an international level. The EU metal sector is also struggling from the difficulty of trying to find new profitable ores in known geological regions. Hence the ability for the metal and coal mining sectors to invest in non-productive expenditures such as tailings and waste-rock management, may be constrained. However, despite the reduced mine production in these areas, consumption is steadily increasing. Therefore, to meet this demand imports into Europe are on the increase.

In contrast to the mostly declining production figures in the metal and coal mining sectors, the production of many industrial minerals has been expanding steadily on a European scale.

The following sections try to give an overview of the metal, potash, coal and oil shale mining sectors. In terms of economics, mines will open when it is economical to do so, be mothballed if short-term low prices persist or may even be closed if there is no prospect of their being viable. However, this chapter tries to provide an overview of the economic situation for each different mineral.

The mining production figures used in the following sections originate from the 'world mining data' book [30, Weber, 2001]. Where appropriate these numbers have been revised by the technical working group members.

1.1 Industry overview: metals

For the detailed discussions, this sector is divided into the following sub-sectors:

- aluminium
- base metals (cadmium, copper, lead, nickel, tin, zinc)
- chromium
- iron
- manganese
- mercury
- precious metals (gold, silver)
- tungsten.

The following table shows that for most of these metalliferous ores, European production is small compared to overall world production.

Commodity	Percentage of world production (%)
Iron	3
Bauxite	3
Cadmium	16
Chromium	12
Copper	7
Lead	11
Manganese	0.5
Mercury	17
Nickel	2
Tin	1
Tungsten	11
Zinc	12
Gold	1
Silver	10

Table 1.1: Production of metal concentrates within Europe as percentages of world metal concentrate production in 1999

Over many years in Europe, ore deposits containing metals in viable concentrations have been progressively depleted and few indigenous resources remain. Also, a decreased interest for exploration and development within Europe due to the relatively high production costs, competitiveness with regard to land use and due to political pressure, together with the discovery of large mineral deposits in other parts of the world, have led to a reduction in European originated concentrates and a subsequent import of concentrates into Europe from a variety of sources worldwide.

Metalliferous ore deposits usually have the minerals finely disseminated within the ore. Also the metalliferous ore minerals within the deposit are mostly irregularly intergrown. To liberate the desired mineral, the ore has to be reduced in size to a fine powder, so that the metalliferous minerals can then be recovered from the ore via different mineral processing techniques, in many cases by froth flotation. Since flotation is a ‘wet’ process the tailings from metal processing are typically in the form of a slurry and are managed in tailings ponds. If the metal(s) is (are) mined in an open pit, large amounts of waste-rock also have to be handled, usually on heaps or dumps.

Most metals are mined as sulphide or oxide minerals. Sulphidic metalliferous minerals often, but not always, contain pyrite, an iron sulphide. Irrespective of the mineral processing method used, some of these metal-sulphide complexes will always be included in the tailings. If air and water have access to the tailings or the waste-rock acids can be formed, that can have a high environmental impact. This phenomenon is called 'Acid Rock Drainage (ARD)' and is explained in detail in Section 2.7. The ARD potential of precious metal ores is often smaller than for massive sulphide ores (usually base metal ores). In general, the sulphur content of bauxite, chromium, iron, manganese and tungsten mineralisations is of minor importance.

1.1.1 Aluminium

In the production of primary aluminium, as a first step the raw material, called bauxite, is refined to alumina. In a second step, the alumina is converted in a smelter to aluminium. The tailings management of the alumina refining is covered in the scope of this work. The smelting part is discussed in the BREF on non-ferrous metals. [35, EIPPCB, 2001]

Bauxite is a naturally occurring, heterogeneous material, primarily composed of one or more aluminium hydroxide minerals, plus various mixtures of silica, iron oxide, titanium oxide, aluminosilicate, and other impurities in minor or trace amounts.

Bauxite is, in most cases, imported from Australia, Brazil, and the equatorial regions of West Africa, principally Guinea and Ghana. The products of alumina refineries are calcined alumina and, in some cases, aluminium hydrate. The alumina is usually shipped to smelters [33, Eurallumina, 2002].

The worldwide demand for aluminium, which directly determines the alumina demand, is currently static after a long period of continuous increase. The annual production of metal aluminium is currently 21 million tonnes, and correspondingly the production of alumina metallurgical grade is around 44 million tonnes. [33, Eurallumina, 2002].

There are six European countries that mine bauxite, which altogether produced 2.2 million tonnes in 2001 [70, EAA, 2002]. However, there are ten alumina plants that refine imported and/or mined bauxite.

The ten alumina refineries in Europe are listed in Table 1.2.

Country	Plant	Production (kt)
France	Pechiney, Gardanne	600
Germany	Aluminium Oxid, Stade	820
Greece	Aluminium de Greece, Distomon	710
Ireland	Aughinish Alumina, Aughinish	1550
Italy	Eurallumina, Sardinia	990
Spain	Alcoa Inespal, San Ciprian	1300
UK	British Alcan, Burntisland	100
Hungary	Ajka	300
Romania	Tulcea	330
	Oradea	200
TOTAL:		6800

Table 1.2: Alumina refineries in Europe alumina production year 1999
[34, EAA, 2002]

The dominant bauxite producer worldwide is Australia, being about 50 million tonnes in 1999. Other producers are Guinea, Brazil, Jamaica, China and India.

The European alumina production of 6.8 million tonnes represents 13 % of the world alumina production. Typically bauxite is refined near the producing mines in order to minimise transport costs, with only high-grade bauxite being shipped to refineries over long distances.

Most of the alumina is sold under long-term contracts, with prices fixed at 11 to 13 % of the metal price fixed for aluminium by the London Metal Exchange (LME). After a period at USD 1500 per tonne, the Al price has now dropped due to recession in the US and Japan. At present, Al is priced at USD 1360 per tonne (average 2002 prices), and is expected to remain little changed for the next two years. Hence, the corresponding alumina price is around USD 164 per tonne [33, Eurallumina, 2002].

The alumina operating cost of the EU producers ranges between USD 160 and 200 per tonne, which is higher than in most non-EU countries [33, Eurallumina, 2002].

The tailings from the refining are a reddish slurry called 'red mud' and a coarser fraction called 'sand'. They have an elevated pH and contain several metal complexes. Of the EU-15 refineries, some apply thickened tailings management of these caustic tailings, some discharge into the Mediterranean, while others utilise conventional tailings ponds and one site manages the red mud in a pond after neutralising the mud with seawater and a flue-gas desulphurisation process. [33, Eurallumina, 2002].

1.1.2 Base Metals (Cadmium, Copper, Lead, Nickel, Tin, Zinc)

Currently base metal prices are low. In many cases, the mineral deposits are relatively complex from a processing point of view. These two factors, combined with the high labour costs in Europe, have led to some temporary and some final closures of mines.

Base metals can often be found jointly, as complex ores, in the same mineral deposit. They are often separated in the mineral processing phase by selective flotation.

There is a big imbalance between European mine production and the European consumption of these metals. A good example is lead, where in 1999 the European consumption was close to 2 million tonnes, which is about 6 times the amount of lead produced from European mines (350000 t) in the same year.

In this section, the subsequent refining, often smelting, will be briefly discussed but, for further details see the BREF on non-ferrous metals industries. [35, EIPPCB, 2001]

Cadmium (Cd)

Cadmium is often found in zinc-concentrate after mineral processing, so the cadmium will be removed at the smelter. In addition, lead and copper ores may contain small amounts of cadmium. [35, EIPPCB, 2001] Cd is always a by-product which is recovered in smelters. There are no cadmium mines that produce a Cd concentrate.

World production in 1999 was about 16500 tonnes of cadmium in concentrates, of which 14.5 % (2400 tonnes) was produced from European mines. The following figure shows the main producers in Europe.

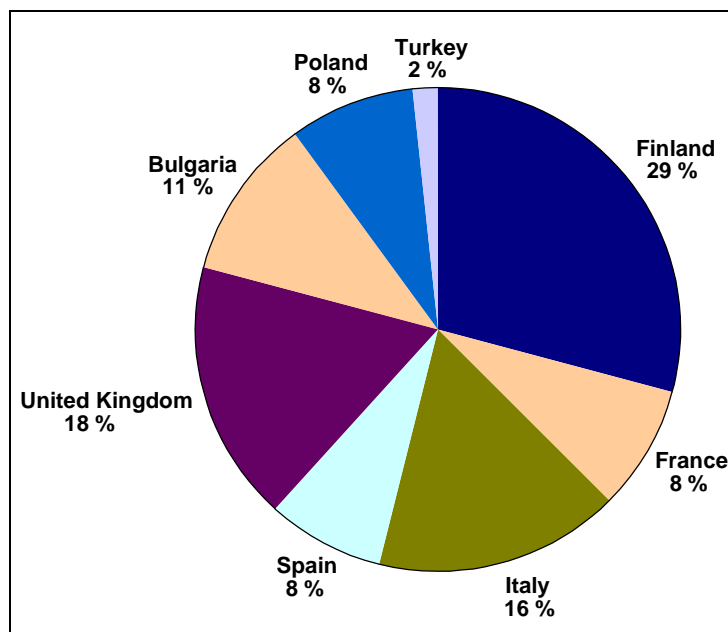

Figure 1.1: Primary cadmium production in Europe in 1999

Copper

Copper is mostly found in nature in association with sulphur. It is recovered from a multistage process, beginning with the mining and concentrating of low-grade ores containing copper sulphide minerals, and followed by smelting and electrolytic refining to produce a pure copper cathode. Worldwide, an increasing amount of copper is produced from the acid leaching of oxidised ores [36, USGS, 2002].

Sulphide minerals are usually recovered using flotation. Oxides, carbonates and silicates are leached.

The world production of copper in 1999 was 12.4 million tonnes. European mine production was 890000 tonnes, which represents 7.2 % of the world production. The following figure shows the main producers in Europe.

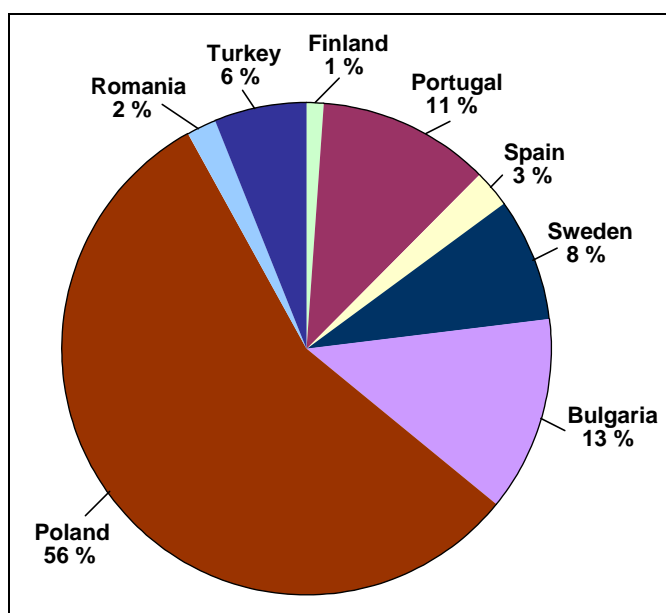

Figure 1.2: Copper mining production in Europe in 1999

While copper prices have begun to recover from their recent lows, they remain at low levels. This provides a challenge for the copper producers, especially the underground mining operations, due to their increased cost for extraction compared to open pit operations. Fortunately, these operations have succeeded over the last decade to significantly reduce their costs to such a point that they are now able to make a profit even at present prices. [113, S.A., 2002]

Lead

Lead ores occur primarily as sulphides or, nowadays, more commonly in complex ores where it is associated with zinc and small amounts of silver and copper. There have been major changes in the pattern of lead use over the years. The battery industry creates up to 70 % of the demand, which is fairly stable, but other uses for lead are in decline.

Usually the lead concentrate is achieved by selective flotation. The metal is recovered from the concentrate by smelting.

The world mining production of lead in 1999 was 3.3 million tonnes, about 10 % of which (about 350000 tonnes) came from European mines. The following figure shows the main producers in Europe.

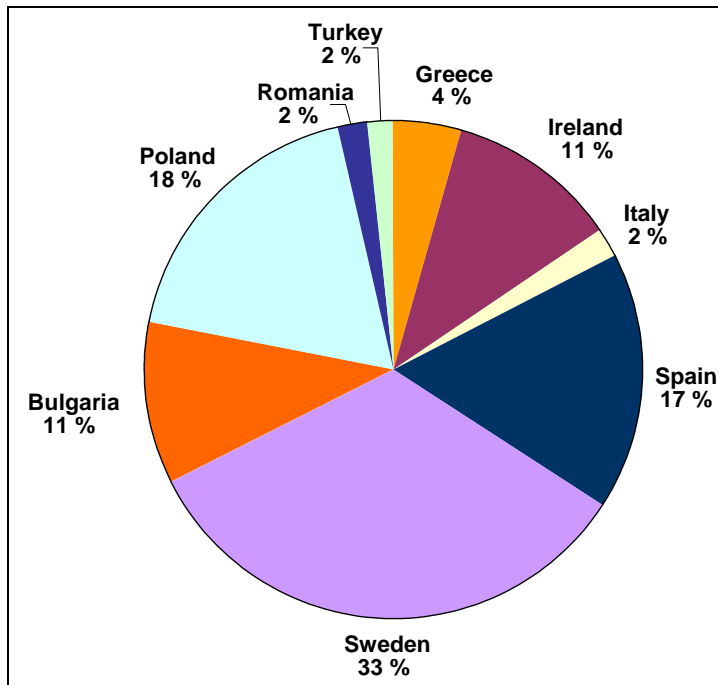

Figure 1.3: Lead mine production in Europe in 1999

Although lead ore is mined in many countries around the world, three quarters of the world output comes from only six countries: China, Australia, US, Peru, Canada and Mexico. Lead extraction in Russia has greatly declined following economic change. Total production has been at a similar level since the 1970s; with new mines being opened or expanded to replace old mines. (Note: all these mines contain at least two metals-lead, zinc, and sometimes silver, gold and copper).

Nickel

Nickel is used in a wide variety of products. Most primary nickel is used in alloys; the most important of which is stainless steel. Other uses include electroplating, foundries, catalysts, batteries, coinage, and other miscellaneous applications. [35, EIPPCB, 2001]

Europe produced only 1.4 % of the world mine production in 1999 (about 1.1 million tonnes). The following figure shows the most important producers in the world.

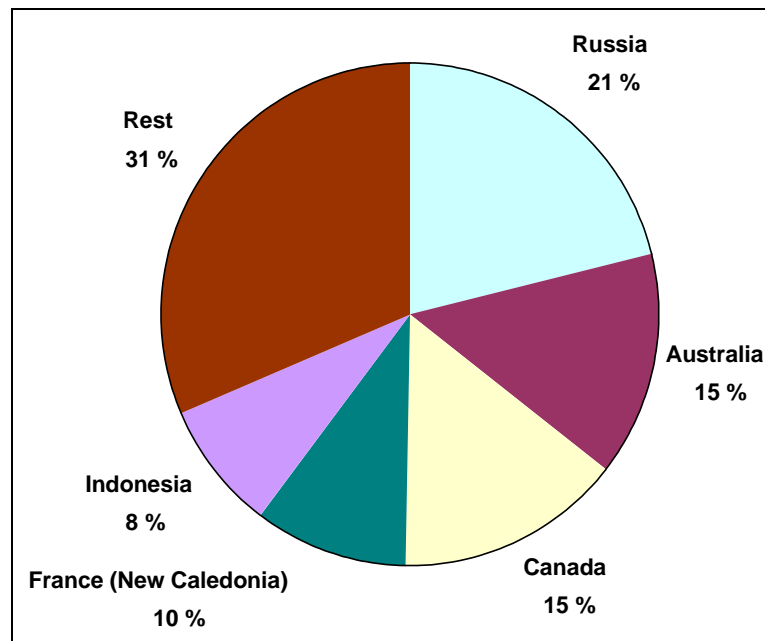

Figure 1.4: World nickel mine production in 2001

There are only two producers in Europe: Greece with 13500 tonnes and Finland with 1000 tonnes in 1999. However, since New Caledonia is part of France, this may also be considered as part of the European production, which would mean that European production provides more than 11 % of the world production.

World production in 2001 was significantly increased due to three new mines being opened in Western Australia. At these sites, nickel is recovered on-site using advanced Pressure Acid Leach (PAL) technology. At least four other Australian PAL projects are in varying stages of development. Competitors are also considering employing PAL technology in Cuba, Indonesia, and the Philippines. In April 2001, a Canadian company launched an innovative PAL project in New Caledonia. If the New Caledonian project is successful, the company will use the technology in Newfoundland to recover nickel and cobalt from sulphide concentrates. The concentrates would come from the Voisey Bay nickel-copper sulphide deposit in north-eastern Labrador. In late 2001, development of the Voisey's Bay deposit was still in limbo, as the Canadian company and the Government of Newfoundland have so far been unable to agree on critical concepts.

[36, USGS, 2002].

Tin

Nearly every continent has an important tin-mining country. Tin is a relatively scarce element, with an abundance in the earth's crust of about 2 ppm, compared with 94 ppm for zinc, 63 ppm for copper, and 12 ppm for lead. Most of the world's tin is produced from placer deposits; at least one-half comes from south-east Asia.

[36, USGS, 2002].

The world tin production in 1999 was about 230000 tonnes. Of this, Europe contributed 1 %. The only European producers are Portugal (2163 tonnes) and the UK (100 tonnes).

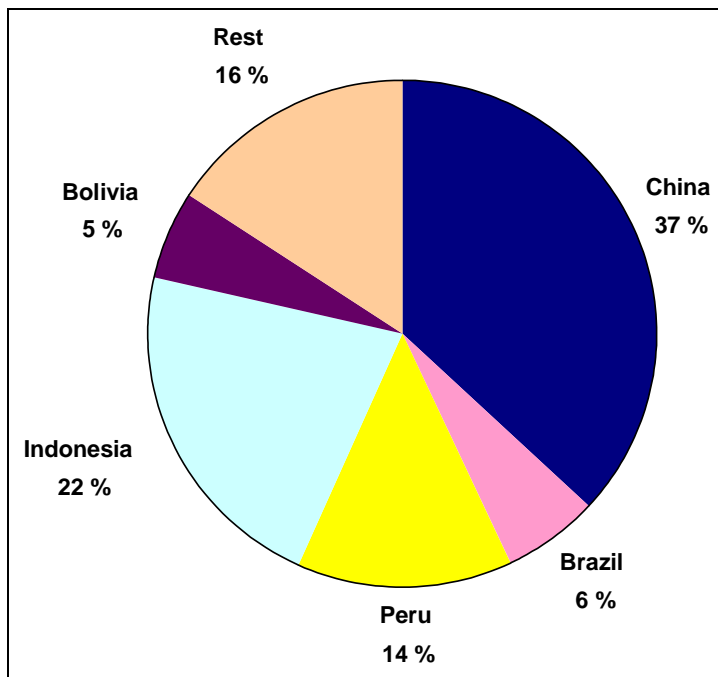

Figure 1.5: World tin mining production in 1999

As can be seen from the figure above, China is by far the largest producer of tin, and also has the largest reserves.

Tin prices continued to decline in 2001. Industry observers attributed lower prices to an oversupply of tin in the market [36, USGS, 2002]. World tin consumption was also believed to have declined somewhat during that year.

Zinc

Sphalerite (zinc iron sulphide, ZnS) is one of the principal ore minerals in the world. Zinc, in terms of tonnage produced, is the fourth most popular metal in world production—being exceeded only by iron, aluminium, and copper.

The zinc is normally recovered from the mined concentrate by leaching and electrowinning.

Europe accounted for 11.8 % of the total world mined production of about 7.5 million tonnes in 1999. The following figure displays the major European zinc producers.

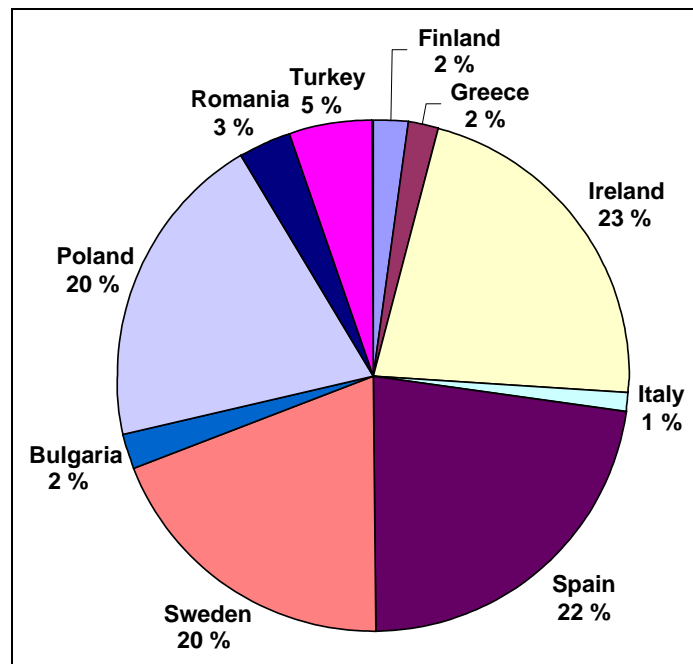

Figure 1.6: Zinc mining production in Europe in 1999

The **tailings from base metal mining activities** can be characterised as follows:

- usually a slurry of 20 - 40 % solids by weight
- containing metals
- containing sulphides
- large amounts produced.

The slurried tailings are managed in ponds. With some underground mines the coarse tailings are used as backfill material.

The sulphide in tailings and waste-rock can oxidise when water and air have access and an acidic leachate is generated. This phenomenon is called Acid Rock Drainage (ARD). Due to ARD, not only is the physical stability of the tailings ponds and dams an issue but so is the chemical stability of the acid generating tailings, both during operation and after the mine closure.

Note, waste-rock is stacked on heaps. The waste-rock from these activities can also have a high environmental impact if it has a net acid generating potential.

1.1.3 Chromium

In Europe, two countries produce significant amounts of ferrochromium; Finland (about 250000 tonnes in 1999 from a single mine) and Turkey (about 430000 tonnes in 1999). Turkey is the fourth largest chromium producer in the world. Greece produces smaller amounts, i.e. 1000 tonnes in 1999. The European mine production represents about 12 % of the world production (5.8 million tonnes in 1999). The three major world producers are South Africa, India and Kazakhstan.

The use of chromium (Cr) to produce stainless steel and non-ferrous alloys are two of its more important applications. Also, chromites, poor in iron and silica, are used for the production of refractory products. Chromite (FeCr_2O_4) is the most important chromium mineral, indeed it is the one from which chromium derives its name.

The concentrate from the Finnish mine is shipped directly to a stainless steel smelter owned by the same company.

The slurried tailings are managed in ponds. Currently, at the Finnish site, the waste-rock is managed on heaps. In the future, the operation will turn from an open pit to underground mining, which will almost eliminate the production of waste-rock. All waste-rock will then be used as backfill.

1.1.4 Iron

Iron ore is a mineral substance which, when heated in the presence of a reductant, will yield metalliferous iron (Fe) [55, Iron group, 2002].

Iron ore is the source of primary iron for the world's iron and steel industries. It is therefore essential for the production of steel. Almost all iron ore (i.e. 98 %) is used in steelmaking [36, USGS, 2002].

In the beginning of the 20th Century the US was the world's largest iron ore producer, accounting for about 60 % of the total yearly world output of approximately 45 million tonnes. By the end of the century the world iron ore production had grown to more than one billion tonnes per year.

In 2000, China was the largest producer in gross weight of ore produced, but because its ore was of such low grade, the country's output ranked well below Australia's and Brazil's output, of 171 and 200 million tonnes respectively. Iron ore is mined in about 50 countries. The seven largest of these producing countries account for about three-quarters of the total world production, which was about 560 million tonnes in 1999. Australia and Brazil together dominate the world's iron ore exports, each providing about one-third of the total exports. The European iron ore mining industry is of little significance on a world scale, only generating 3 % of the yearly world production.

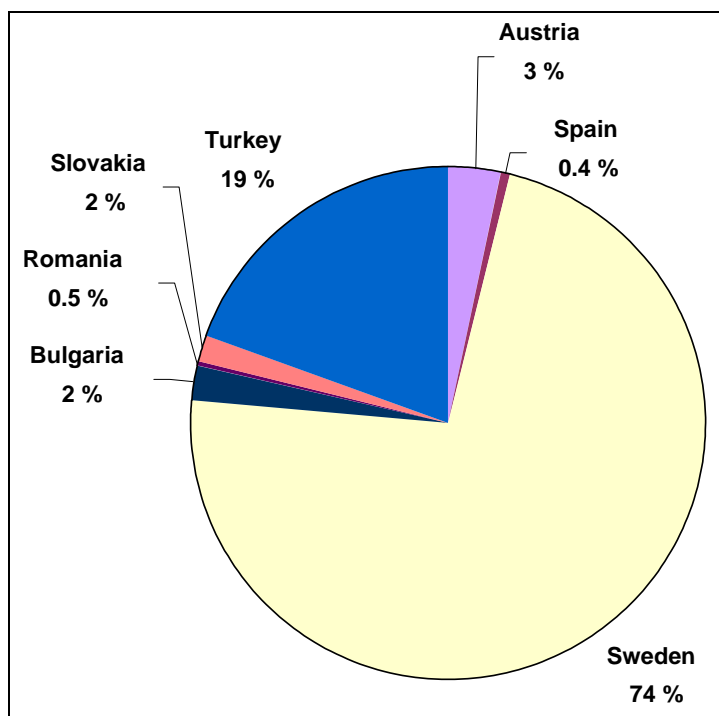

Figure 1.7: Iron mining production in Europe in 1999

The biggest iron ore producing company in the world is CVRD of Brazil. The sales of this group reached a new record of 143.6 million tonnes in 2001. The London-based Rio Tinto group produced 115.8 million tonnes and shipped 110.6 million tonnes in the same year. Corresponding figures for the Australian/South African group BHP Billiton, was 82.6 million tonnes and 84.5 million tonnes respectively in 2001. At present these big three control approximately 70 % of the iron ore market.

Iron ore production in Western Europe is now mainly concentrated in Sweden, as the production of iron ore in the 'minette' regions of France/Luxembourg ceased in the first half of 1990s, as did the iron ore mining in Spain. There are still some small scale operations for domestic use in Turkey, Austria and Norway, the latter also producing some for export. In Eastern Europe, Slovakia, Bulgaria and Romania are represented in the statistics of iron ore producers.

Of the merchant iron ore products, 490 million tonnes in 2000, pellets accounted for about 90 million tonnes. The rest consisted of coarse ores (approximately 70 million tonnes) and fines. Iron ore fines are used as a feed to blast furnaces, after sintering or pelletising processes. Pellets are split up into two types, depending on their use, i.e. for blast furnaces use, or as feed for the expanding Direct Reduced Iron/Hot Briquetted Iron (DRI/HBI) industry. [49, Iron group, 2002]

The end of the 20th Century saw a wave of company amalgamations in the iron ore industry as producers strove to reduce production costs and become more competitive. This period of consolidations is thought to have come close to an end, though there is still some potential for further acquisitions and mergers. [49, Iron group, 2002]

For iron ore mining in Europe, this metal is only mined in the form of oxides and carbonates and the ores either contain little or no sulphide minerals. The tailings and waste-rock from these operations do not have a net ARD potential. Typically, a coarse tailings fraction is generated which is managed on heaps. The fines are discharged into tailings ponds.

1.1.5 Manganese

Steelmaking accounts for most of the manganese (Mn) demand [36, USGS, 2002].

In some cases, manganese is the prime product of a mine (e.g. Hotazel mine in South Africa or Nikopol mine in the Ukraine), but usually, manganese is associated with other minerals (e.g. iron-carbonates). One positive effect of this association with iron is that in steel production less additional manganese needs to be added [38, Weber, 2002]

The European mine production of 43500 tonnes in 1999 represents 0.5 % of the world production in the same year. The following figures show the European and the largest international producers.

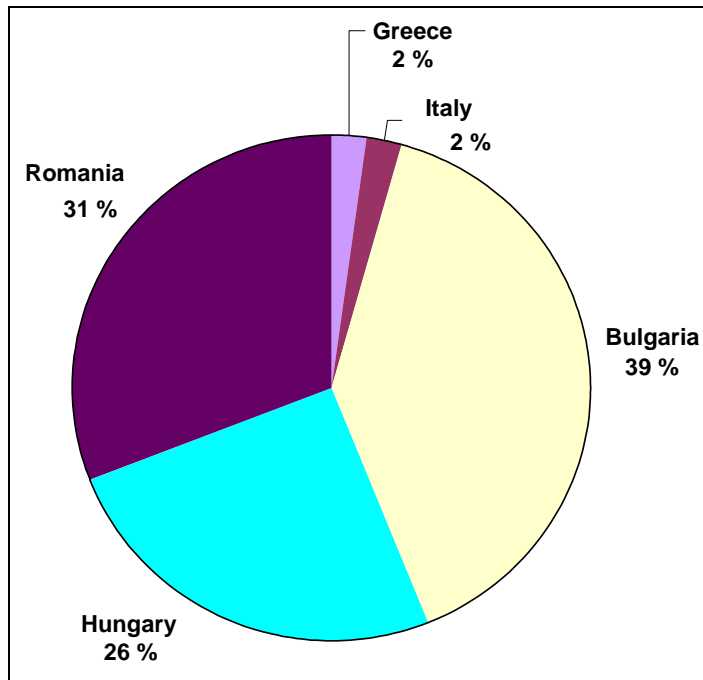

Figure 1.8: Manganese mining production in Europe in 1999

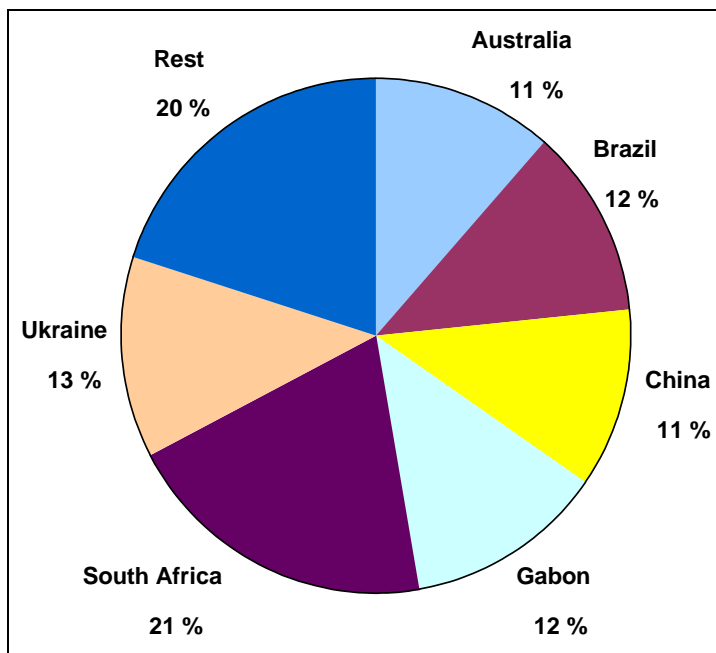

Figure 1.9: World manganese mine production in 1999

The free on board (f.o.b.) price of the manganese ore from the Hungarian operation is USD 42 per tonne.

1.1.6 Mercury

Cinnabar (HgS) is the main ore of mercury. [37, Mineralgallery, 2002]. Mercury is the only common metal that is liquid at room temperature. It occurs either as native metal or in cinnabar, corderoite, livingstonite, and other minerals [36, USGS, 2002].

The only remaining European mercury mine is the Almadén mine in Spain. The mine was subsidised from the Spanish state with a commitment to reduce mining activities. In 1995, EUR 5222 million were paid to the holding company which includes the Almadén mine. In 1999, about 100 persons were directly employed in the mining section of the company. However this mine has now been closed and is unlikely to be recommissioned. Other mines, although mining other metal sulphides, sometimes produce mercury as a by-product. One example is the Pyhäsalmi Oy Mine, which produces Cu-, Zn-, Pyrite concentrates that include Cd, Hg, Au and Ag.

World mercury mining is currently carried out in about ten countries, with the largest quantities coming from Spain and Kyrgyzstan. Over the past ten years the estimated annual world mine production of mercury has averaged about 2500 tonnes, but world production values have a high degree of uncertainty. Annual world mining of mercury is declining and was estimated 1640 tonnes in 2000. In 1999 European production represented 17.4 % of the world production.

Mercury use in Western Europe and North America has declined because of numerous restrictions on the use of mercury-containing products. The chlor-alkali industry will also gradually cease to be one of the major users. At the same time, the supply of secondary and recovered mercury has increased due to environmental regulation.

This leaves most developed countries as net exporters of mercury, which has led to steadily declining mercury prices. The market price since 1990 has been very low: prices in 1997-1999 were around EUR 4 per kg of mercury. The surplus of mercury on the market keeps the price of mercury low, which may encourage additional uses and lead to increased demand on a global scale, in particular outside the OECD. Mercury is exported to developing countries for re-use in gold recovery for use in the production of cosmetics, paints and pesticides, in addition to application types shared with OECD countries, such as in measurement and electrical devices. In this respect, the effects of the continuing exports of mercury by European companies to developing countries, where its use may lead to pollution and adverse health effects, need to be given full consideration. Furthermore, a significant part of the mercury could return to Europe as long-range transboundary air pollution.

[112, Commission, 2002]

Since the tailings contain sulphides, the generation of ARD will be an issue with Hg mines. Older Hg mines, waste-rock heaps and tailings management facilities will also cause problems. ARD and the seepage of heavy metals can be expected for many years if the sites are not properly decommissioned. However Hg in the S form is not water soluble and should therefore remain stable in the tailings and waste-rock.

No information has been provided on the management of tailings and waste-rock at mercury mines.

1.1.7 Precious Metals (Gold, Silver)

Most of the gold and silver produced is used in the manufacture of jewellery but, due to properties such as their high electrical conductivity and resistance to corrosion, they are also increasing by being used as industrial metals.

Of an estimated 140000 tonnes of all gold ever mined, about 15 % is thought to have been lost, used in dissipative industrial uses, or otherwise unrecoverable or unaccounted for. Of the remaining 120000 tonnes, an estimated 33000 tonnes are official stocks held by central banks and about 87000 tonnes is privately held as coin, bullion, and jewellery [36, USGS, 2002].

In some cases gold and silver are directly turned into crude metal at an on-site mineral processing plant as doré, containing typically 75 % gold and 25 % silver. In other cases, gold and silver are found in other metal concentrates and are recovered in the smelting process [36, USGS, 2002], for instance, a considerable amount of silver originates from the desilvering of lead.

Gold occurs in native form (free-gold) or locked in other minerals (pyrite, quartz etc). It can contain a variable amount of silver in solid solution. Gold-silver tellurides can also be a minor addition in commercial gold deposits.

Of approximately 2.5 million kg of gold mined worldwide in 1999, Europe produced only 0.8 %. For silver, European production represented approximately 10 % of the world production.

The following two figures show the main producers of gold and silver in Europe.

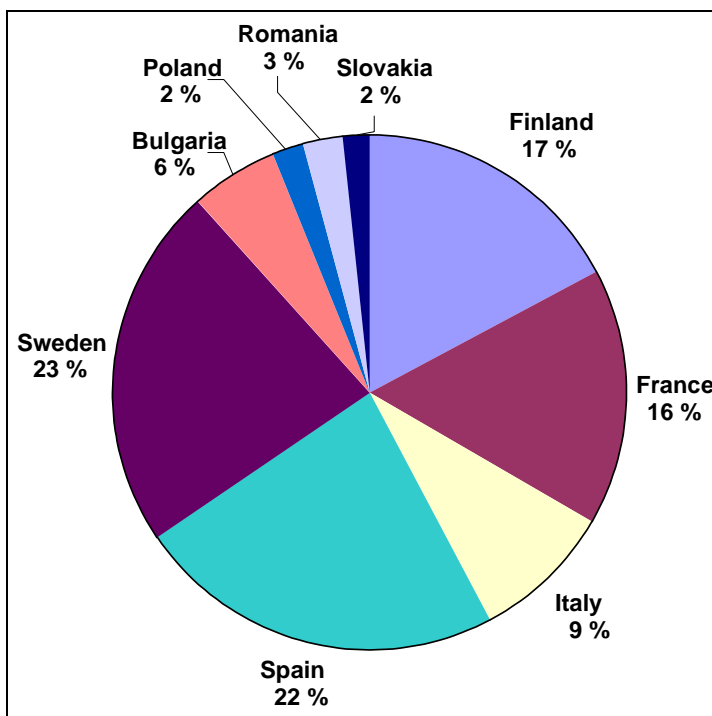

Figure 1.10: Gold mining production in Europe in 1999

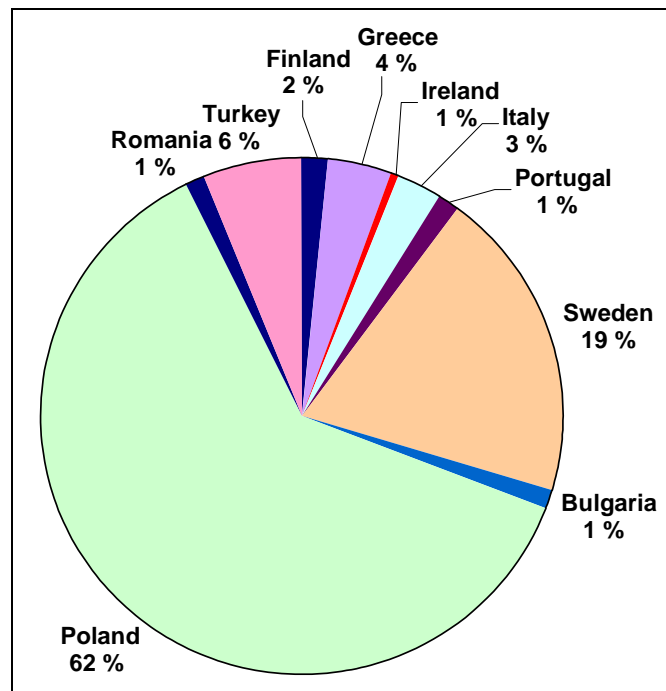

Figure 1.11: Silver mining production in Europe in 1999

Currently there are six gold mines in the EU-15. In Europe, silver is not mined as a main product. Silver is primarily a by-product of lead mining.

A new gold mine in Turkey has been in operation since 2001.

There are several examples of projects where the permitting process has been initiated, e.g. the Svartliden mine in northern Sweden, the Matalikais mine in Greece and the Rosia Montana open pit gold mine project in Romania.

The following figure shows the world gold mining production in 2001.

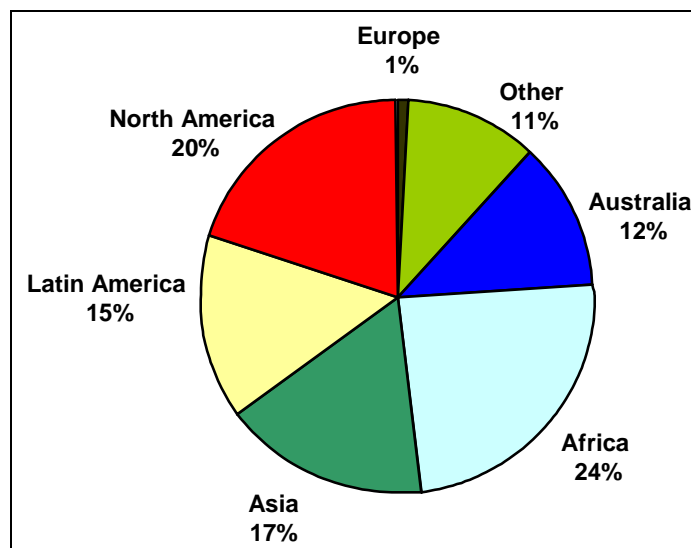

Figure 1.12: World gold mining production in 2001

The use of cyanide (CN) to leach gold has been a much discussed issue in recent years. The Baia Mare accident brought special attention to this technique. In 2000, there were about 875 gold or gold and silver mining operations in the world. This number does not include the contribution from base metal mines where some gold is recovered as a side product at the mine or the smelter. Of those 875 sites, 460 (i.e. 52 %) utilised cyanide, 15 % of them were heap leaches and 37 % used cyanidation in tank leaching. The remaining 48 % used a variety of processes that did not use alternative chemical reagents or lixivants, but instead used primarily gravity separation and flotation to form a concentrate. These concentrates were then sent to a smelter for final processing [26, Mudder, 2000]. The following figure shows the world distribution of gold or gold and silver mines using cyanidation in 2000.

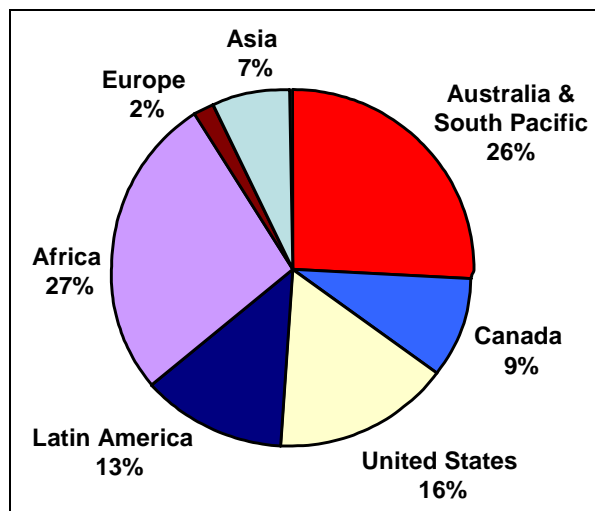

Figure 1.13: World distribution of gold or gold and silver mines using cyanidation in 2000 [26, Mudder, 2000]

During the first nine months of 2001, the Engelhard Corporation’s daily price of gold ranged from a low of about USD 257 per troy ounce in April to a high of almost USD 294 in September. For most of the year, this price range was below USD 270. The traditional role of gold as a store of value was able to lift the price of gold out of its low trading range when terrorists attacked the United States in September 2001. In 2001, the Swiss National Bank continued selling 1300 tonnes of gold (one-half of its reserves), and the United Kingdom government completed its drive to sell 415 tonnes of gold from British gold reserves. Concerns about the true position of central bank gold sales, prospects for more consolidations within the gold mining sector, and a lack of renewed investor interest in gold, kept gold prices depressed until the middle of September 2001. Throughout 2002, gold traded steadily USD 300 per ounce.

Gold is a very valuable natural resource. Therefore, it is still worth mining if the ore grade is in the grams/tonne-range. This results in large amounts of tailings being produced in gold mining relative to the amount of gold produced. For instance, at a gold grade of 5 g/t, 200000 tonnes of ore have to be mined to produce 1 tonne of gold (assuming 100 % recovery of gold).

Coarser gold particles can be recovered using gravity separation. However the finer gold particles can often only be recovered by leaching the ore with a cyanide solution. Due to the high toxicity of cyanide, special attention has to be given to the tailings management where this process is applied.

There is research ongoing with the aim of replacing cyanidation with less hazardous techniques. Also new techniques to destroy cyanide in the tailings or to recycle cyanide from the tailings to the process are currently being investigated.

Gold mining tailings are usually in the form of fine slurry which is managed in ponds. All sites within the EU-15 and the Turkish Ovacik mine destroy the cyanide in the tailings prior to discharge into the tailings pond. Both chemical and physical stability of tailings management facilities are of high importance, since the tailings can also have an ARD potential.

1.1.8 Tungsten

The main tungsten bearing minerals are wolframite (Fe, Mn)WO₄ and scheelite (CaWO₄).

In 1999, a total of 3000 tonnes of tungsten oxide were produced in Europe. 1800 tonnes WO₃ resulted from Austria and 549 tonnes from Portugal. European production accounted for 11.5 % of the world production in 1999.

The average worldwide consumption of tungsten is 40000 t (W) per year. The main producers are China (>80 %), Canada, Russia, Austria, Portugal and Bolivia [52, Tungsten group, 2002].

Due to low prices, many mines throughout the world have had to close during the last two decades [52, Tungsten group, 2002].

The coarse tailings are managed on heaps; fine tailings in ponds. Depending on the deposit, sulphides are present in smaller or larger quantities; therefore ARD may be an issue.

1.2 Industry overview industrial minerals

For the detailed discussions this sector is divided into different sub-sectors. These are:

- barytes
- borates
- feldspar
- fluorspar
- kaolin
- limestone
- phosphate
- strontium
- talc.

The following table shows that, for most of these minerals, European production, other than metalliferous minerals, presents a major fraction of the world production.

Commodity	Percentage of world production (%)
Barytes	11
Borates	30
Feldspar	64
Fluorspar	5
Kaolin	18
Phosphate	1
Talc	26

Table 1.3: Production of some industrial minerals within Europe as a percentage of world production in 1999

Industrial minerals are recovered in many different ways. Some are sold as mined, i.e. without being processed. In other cases all sorts of mineral processing methods have to be applied to achieve a highly concentrated product. The majority of the mines in the ‘Industrial Minerals’ sector use only physical treatments (e.g. crushing, washing, magnetic separation, optical sorting, hand sorting, classification, flotation), with only a minority of mines carrying out a chemical treatment of the mineral (e.g. leaching). Hence, the amounts and characteristics of tailings and waste-rock vary significantly. In general these operations are small compared to most metal mines, and the grade of the mineral is usually higher. Therefore, in most cases the amounts of waste-rock and tailings are also smaller. Acid rock drainage is typically not an issue in the industrial minerals sector.

1.2.1 Barytes

Barytes is the naturally occurring mineral form of barium sulphate ($BaSO_4$). It is a relatively low-value industrial mineral. Filler applications can command higher prices after more intense mineral processing. There are also premiums for colour – whiteness and brightness [29, Barytes, 2002].

The EU-15 consumption of barytes is estimated to be around 700000 tonnes, with EU-15 mined production around 340000 tonnes in 2000 and the balance being imported, mainly from China but also from Morocco and India [29, Barytes, 2002].

The following figure shows the main producing countries Europe. The total annual production in Europe is about 715000 tonnes.

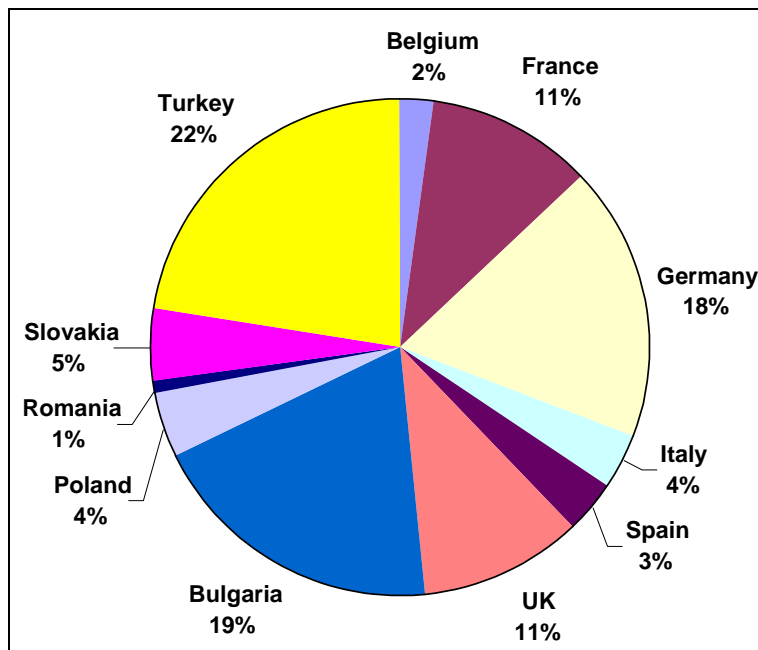

Figure 1.14: Barytes mining production in Europe in 2000

Of the total 6.4 million tonnes production, the US consumed some 2.7 million tonne and EU-15 an estimated 0.7 million tonnes. The following figure shows the main producers in the world.

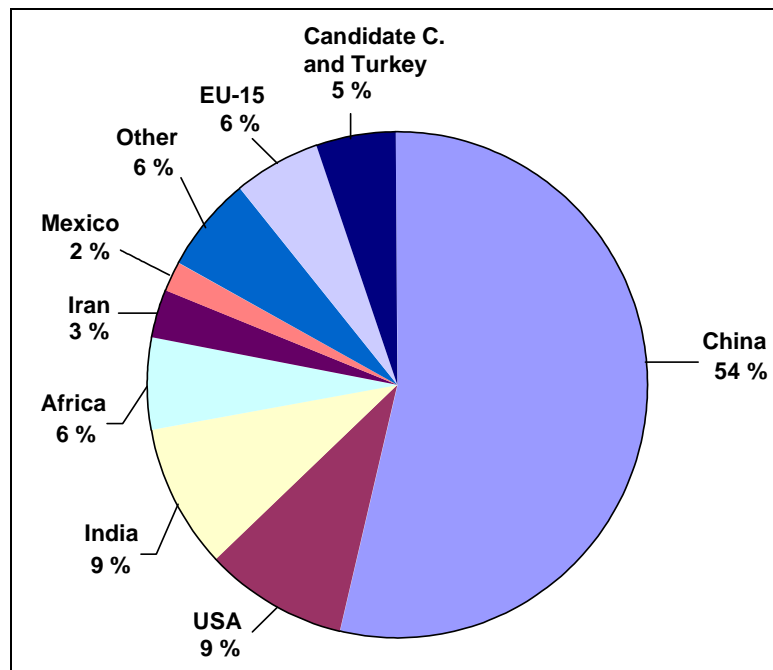

Figure 1.15: World barytes production (production figures) in 2000

Furthermore, imported barytes is processed in the Netherlands.

Quoted prices (*Industrial Minerals* magazine) for oil-well crushed lump are around EUR 55 - 60/tonne rising to EUR 100/tonne for ground material. The mined production output in Europe has remained steady for several years; and provides direct employment for over 400 people and directly contributes over EUR 50 million to the gross domestic product [29, Barytes, 2002].

The average grade of ores mined in the EU-15 is around 50 % BaSO₄. This indicates, that to produce 715000 tonnes of barites, about 1400000 tonnes of ore has to be mined. Some of this ore has been sold as other mineral products [29, Barytes, 2002].

Only a small percentage (2 %) of the tailings produced within the EU-15 is discarded as slurry in ponds. Typically coarse tailings are sold as aggregates. Finer tailings are mostly dewatered and also sold or used as backfill in the mine.

1.2.2 Borates

Borates are a group of over 200 naturally-occurring minerals containing boron. Trace amounts exist in rock, soil and water. Elemental boron does not occur in nature but traces of its salts are present almost everywhere in rocks, soil and water. Nevertheless, borate minerals are comparatively rare and large deposits exist in only a few places in the earth's crust (Turkey, US, China, Russia, and South America).

[92, EBA, 2002]

The global supply market for borates, some 4.2 million tonnes, is largely dominated by Turkey (the only European producer), the US, and South America (Argentina, Bolivia, Chile, and Peru). China and Russia produce significant volumes of borates, but export little on to the world market. The world's two leading producers are Eti Bor, which produces in western Turkey, and US Borax in California, which together command perhaps some 75 – 80 % of the supply market.

The Turkish borate producer has an annual production of about 1.2 million tonnes from nine operations (seven open pits, and two underground mines). This represents about 30 % of the world production [36, USGS, 2002].

The Turkish borates industry provides direct employment for over 2150 people and directly contributes over EUR 225 Million to the country's gross domestic product. Quoted prices (Industrial Minerals magazine) for borates range from EUR 270 to 900 per tonne.

In Turkey, the residues of the mines are the tailings from the minerals processing plants and the boron derivatives plants. The tailings are disposed of either on heaps (for coarse clays and calcareous minerals) or in lined tailings ponds (for fine clay particles) near the mines.

1.2.3 Feldspar

Feldspars are common rock-forming minerals, which can become valuable industrial raw materials when occurring in large, easily extractable and processable quantities. By composition, feldspars are aluminosilicates containing potassium, sodium and/or calcium.

More than 60 % of the feldspars produced in the EU-15 are used in the ceramic industry, with most of the remainder being used in glass production. In the manufacture of ceramics, feldspar is the second most important ingredient after clay, acting functionally as a flux. [39, IMA, 2002].

The feldspar sector is composed of small and medium companies, spread around all EU-15 Members States.

In 1999, a total of 6 million tonnes of feldspar were produced in Europe, which is almost two thirds (64 %) of the total world production. Feldspar recovered by flotation represents about 10 % of the European feldspar production. The following figure shows the major European producers.

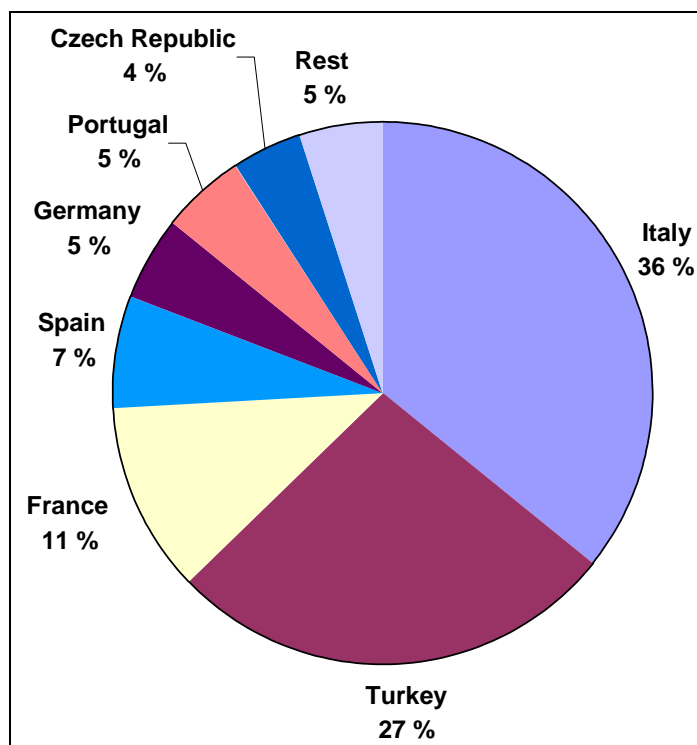

Figure 1.16: Feldspar mining production in Europe in 1999

Minor producers (i.e. <100000 tonnes/yr) include Finland, Greece, Sweden, UK, Poland and Romania.

The feldspar industry in the EU-15 provides direct employment for over 3000 people and directly contributes over EUR 900 million to gross domestic product. The quoted prices (Industrial Minerals magazine) for feldspar are in the range EUR 13 - 205 per tonne. The market for the low-cost sodium-feldspar is mainly local or national because of the proportionally high transport cost. Only a few, higher value feldspars (high grades qualities, i.e. floated feldspar and potassium feldspar) are transported over long distances.

Feldspar production results in tailings heaps made of coarse sand, gravel and rock, as well as tailings ponds for the fine tailings.

1.2.4 Fluorspar

Fluorspar is the industrial name of the mineral fluorite (CaF_2). It is extracted from mines (underground and open pits), with natural concentrations between 20 and 90 % CaF_2 . Ore and concentrated marketable products have the same name, i.e. fluorspar. Fluorspar has long been known for the beauty and variety of its colours. Nowadays it is used for its chemical properties (it is a fluoride, and therefore a source of the element fluor) and for its physical properties (e.g. as a fluxing agent).

[43, Sogerem, 2002]

Worldwide production is between four and five million tonnes per year. The main producers are China (2.5 million tonnes), Mexico (0.5 million tonnes), the EU-15 (0.4 million tonnes), and South Africa (0.3 million tonnes). Around 20 countries declared a substantial production in 2000 [43, Sogerem, 2002]. The European producers are displayed in the following figure.

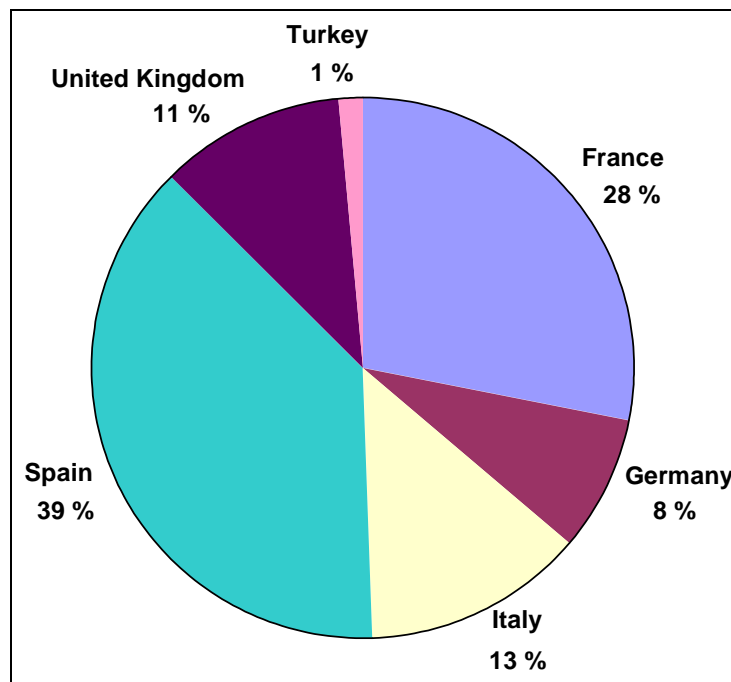

Figure 1.17: Fluorspar mining production in Europe (1999)

At the Sardinian fluorspar/lead sulphide mine the average value of the products are EUR 120 per tonne for fluorspar and USD 190 per tonne for lead sulphide [44, Italy, 2002].

1.2.5 Kaolin

The word kaolin derives from the Chinese "Kao-ling" (High Crest), the name of a hill in central China near where this substance was originally mined for use in ceramics. This is also the origin of the name "China Clay". Since those early days, the use of kaolin has widened to paper, rubber, paints and plastics manufacture [40, IMA, 2002].

In 1999, European kaolin production was about five million tonnes, about 20 % of the world production in the same year. The biggest European producers are listed in the following figure.

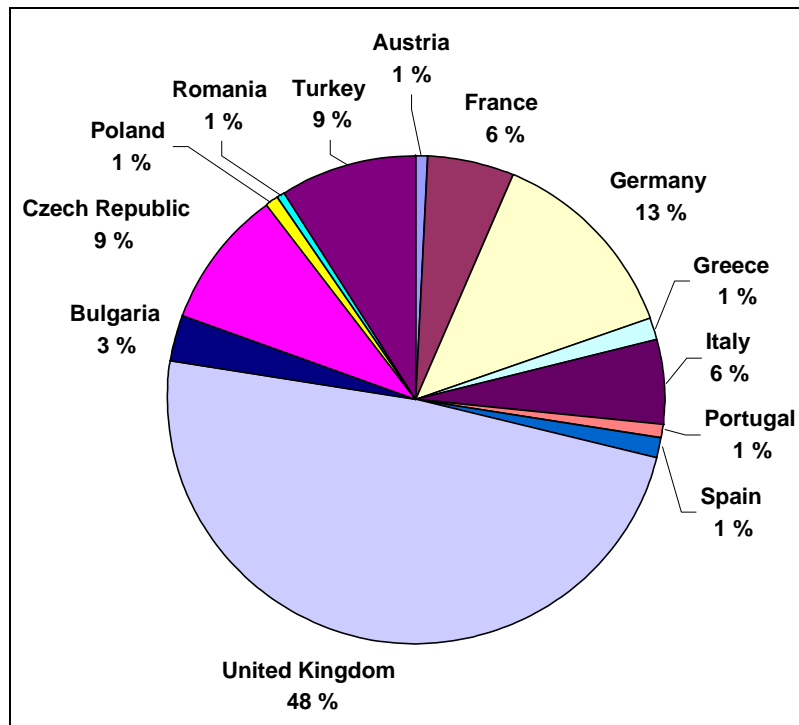

Figure 1.18: Kaolin production in Europe in 1999

In Europe, the kaolin industry provides direct employment for over 6000 people and directly contributes over EUR 1500 million to gross domestic product. The quoted prices (Industrial Minerals magazine) for kaolin are in the range EUR 40 - 375 per tonne.

Kaolin production results in tailings heaps made of coarse sand, gravel and rock, as well as tailings ponds for the fine tailings.

1.2.6 Limestone

Limestone is used in three different ways: as an aggregate, as calcium carbonate and in the cement and lime industry. The aggregates sector will not be discussed, since it does not generate tailings.

The calcium carbonate industry operates mainly with deposits of a grade higher than 96 %. Therefore, there is usually no need for further mineral processing steps. In Europe, only seven plants need to use flotation to separate calcium carbonate from unwanted minerals (mainly graphite and mica). These seven plants account for less than 5 % of the total European calcium carbonate production. Five of these plants do not have tailings ponds, since they use dewatering devices (e.g. thickening and filter press).

[42, IMA, 2002]

The limestone used for the cement and lime sector contains clay impurities that can be washed off. These tailings are stored in ponds.

1.2.7 Phosphate

The only phosphate mine in Europe is the Finnish Siilinjärvi mine. Currently its annual production levels are 800000 tonnes of apatite concentrate ($\text{Ca}_5(\text{PO}_4)_3$ (F), calcium fluoro phosphate). The main product, the apatite concentrate, is mainly used as a raw material for phosphoric acid production.

Furthermore, 100000 tonnes of calcite concentrate, 10000 tonnes of mica concentrate, 70000 tonnes of micaceous products and 200000 - 300000 tonnes of various crushed rock products are produced annually.

Some nine million tonnes of ore and two to three million tonnes of waste rock are extracted annually.

Tailings from the concentrator are pumped to the tailings dam area. Waste-rock is crushed for it to be used as aggregate in road and dam constructions or stockpiled in waste-rock areas. [143, Siirama, 2003]

1.2.8 Strontium

Strontium is commonly mined in the form of two minerals, celestite (strontium sulphate) and strontianite (strontium carbonate). Of the two, celestite occurs much more frequently in sedimentary deposits of sufficient size to make development of mining facilities attractive. Strontianite would be the more useful of the two common minerals because strontium is used most often in the carbonate form, but few deposits have been discovered that are suitable for development.

[36, USGS, 2002]

Celestine (SrSO_4), is mined in two mines in southern Spain, which together produced about 120000 tonnes of final product in 2000. The other European producer of Strontium ore is Turkey with about 25000 tonnes in the same year. World production in 2000 amounted to about 300000 tonnes. All figures are given in metric tonnes of strontium content. Spain is the second largest producer in the world after Mexico.

[36, USGS, 2002]

1.2.9 Talc

Talc is a hydrated magnesium silicate. Although talc deposits are found throughout the world in various geological contexts, economically viable concentrations of talc are not that common.

The largest producer in the world is China with an annual production of about 1.7 million tonnes followed by the US (0.9 million tonnes) and India (0.6 million tonnes). EU talc production stands at 1.4 million tonnes/year, of which France and Finland account for 70 %. The world talc production is estimated to about 5 million tonnes/year.

The following figure shows the producing countries in current Member States and Candidate Countries. It is difficult to obtain sensible talc production data as it is often grouped with steatite and talc-related materials.

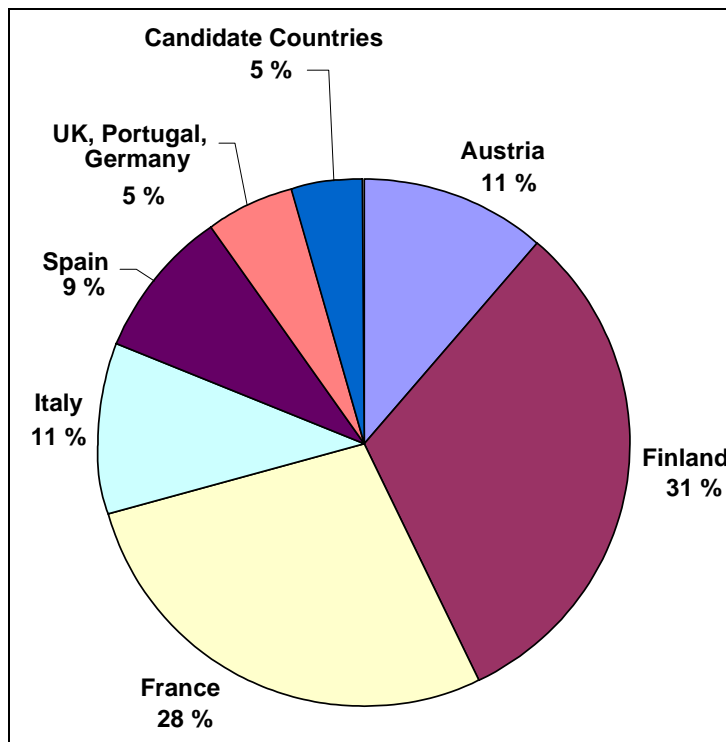

Figure 1.19: Talc mine production in Europe (1999)

Luzenac is the major producer on the European market. The two other main producers are Mondo Minerals and IMI Fabi SpA. Luzenac, which belongs to the group Rio Tinto, is the leading talc producer with sales exceeding 1.4 million tonnes/year. In Europe, Luzenac owns 7 talc deposits and 11 processing plants. Mondo Minerals incorporates the European talc activities of Mondo Minerals Oy (two mines and three processing plants in Finland), Mondo Minerals B.V. in the Netherlands and Norwegian Talc AS. IMI Fabi SpA has its main activities in Italy, with three mines and two comminution plants.

The talc market is undergoing consolidation on both the supply and demand side in response to increasing competition from other minerals and emerging economies, and due to increased market transparency and globalisation pressures. The talc market in Europe is mature with low growth in most sectors, so for many years price increases have been marginal, barely keeping abreast with inflation. Domestic markets are also increasingly subject to pressure from competitively priced imports of high quality grades which can command a price premium, especially from China. Talc's properties (platyness, softness, hydro-phobicity, organophilicity, inertness and mineralogical composition) provide specific functions in many industries. Quoted prices (Industrial minerals magazine) for talc varies from USD 100 - 300 per tonne, depending on the grade, with an average price of USD 210 per tonne. The world market is thus estimated to be USD 1.2 billion per year.

Generally, due to the high purity of the deposit, the talc industry does not generate tailings.

However, in Finnish operations, which actually represent about 33 % of the European talc production, talc is extracted from a talc magnesite rock using flotation. The tailings are managed in ponds.

1.3 Industry overview: potash

Even though potash is an industrial mineral, it was decided by the TWG at the kick-off meeting, that due to the different techniques in the mineral processing and tailings management this mineral would be treated separately in its own section.

The main potash products used as fertilisers (with the nutrients potassium, sulphur and magnesium) are potassium chloride (MOP⁴), potassium sulphate (SOP) and kieserite. These are produced with different values of K_2O^5 (40 - 62 %) and in a fine, standard or coarse grade. Potassium sulphate and sulphates of potash-magnesia are non-chloride potash fertilisers.

About one fifth of the world potash production comes from European mines in France, Germany, Spain and the UK.

The European mine production in 1999 was just over 5 million tonnes K_2O . The following figure shows the production percentages by country.

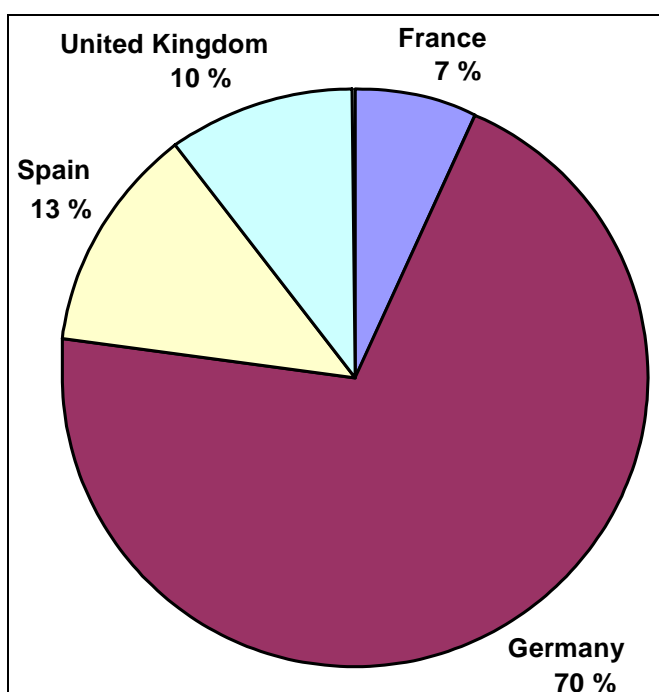

Figure 1.20: Potash mining production (K_2O) in Europe in 1999

The world potash production is dominated by Canada, Russia and Germany, which together account for about 76 % of the total world production. Potassium chloride (KCl), commonly referred to as Muriate of Potash (MOP), is the most common and least expensive source of potash. Potassium chloride accounts for about 95 % of world potash production. [19, K+S, 2002]

⁴ Muriate of potash (MOP) is the common term for the salt potassium chloride (KCl) and is so named because hydrochloric acid was originally called muriatic acid. The name MOP has stuck with the product even though the name of the acid has since changed.

⁵ Potassium oxide is not known to exist owing to its highly reactive properties. However it is used as a convention term for stating the potassium content of a material, e.g. 100 tonnes 95 % KCl (MOP) is the equivalent of 60 tonnes K_2O .

The world potash industry has experienced unstable conditions since the late 1980s (just prior to the economic collapse of the Eastern block countries). Up to that point, average industry operating rates (percentage of production capacity) were exhibiting a slow but steady upward trend that ended abruptly in 1988. The average world operation rate, which had steadily increased to 83 % in 1988, declined gradually to only 56 % of previous levels. During this period, world consumption declined from 31 to 21 million tonnes K_2O .

World potash demand in 2000 was approximately 26 million tonnes of potassium oxide (K_2O) or 42 million tonnes of product (KCl and K_2SO_4). Compared with these figures, the manufacturing capacity was approximately 37 million tonnes of potassium oxide (K_2O) or 59 million tonnes of products. Therefore, a considerable overcapacity exists worldwide.

The economic situation, particularly in developed countries, greatly influences the extent and regional distribution of exports. Both the quantity exported and its distribution among consumers are greatly affected by the state of the importers agriculture, by the demand for (or availability of) convertible currency in the exporting or importing country and by fluctuations in currency exchange rates. Transport costs for potash fertilisers have a considerable bearing on total cost to the consumer. Logistical considerations, therefore, influence the direction and magnitude of imports or exports and contribute to the worldwide overcapacity.

Five methods are used in Europe for managing the tailings, these are:

- storing solid tailings on tailings heaps
- backfilling solid tailings into mined out rooms of underground works
- discharging solid and liquid tailings into the ocean/sea (e.g. marine tailings management)
- discharging liquid tailings into deep wells
- discharging liquid tailings into natural flowing waters (e.g. rivers).

Potash tailings are made up of table salt (sodium chloride) together with a few per cent of other salts (e.g. chlorides and sulphates of potassium, magnesium and calcium) and insoluble materials such as clay and anhydrite. The tailings heaps themselves generate saline solutions when atmospheric precipitation dissolves salt from the tailings material.

1.4 Industry overview: coal

The TWG decided at the kick-off meeting that coal is only included when it is processed and there are tailings produced. Therefore, in this section, only hard coal (or rock coal or black coal) is discussed, whereas lignite (or brown coal), which is usually not processed, is not covered.

Throughout Europe coal is mined under difficult geological conditions, usually underground. The industry is characterised by a high degree of automation. The production from coal mines in the EU-15 has been declining for decades. This is due to the often high cost caused by mining deep-lying and relatively slim deposits, called seams. However, with the accession of new members, overall coal production in the EU will increase. In other parts of the world, large deposits close to the surface can be mined at lower costs. Coal mines in Europe will keep closing. The opening of new underground mines is not foreseeable in the near future. Except for Spain and the UK, where some four million tonnes per year of bituminous coal are mined from open pits, coal is usually extracted by means of underground operations.

As can be seen in the following table, the total hard coal production in Europe in 2001 was 188.2 million tonnes. It can be seen that Poland is the dominant European hard coal producer, providing over 50 % of the total European production in 2001.

Country	1980	1996	1997	1998	1999	2000	2001
France	20194	7314	5779	4739	4033	3166	1971
Germany	94492	53156	51212	45340	43849	37338	30362
Spain	13147	17465	18861	16380	15433	14965	14539
United Kingdom	130096	49307	47123	40045	36356	30465	32512
Total EU-15	257929	127242	122975	106504	99671	85934	79384
Bulgaria	267	186	99	118	108	66	20
Czech Republic	288	301	301	301	300	631	630
Hungary	3065	996	959	914	783	754	570
Poland	193121	136385	137100	116381	110443	103173	103896
Romania	8060	4219	3401	2679	2748	3243	3680
Turkey	3602	3029	2291	3994	2705	3110	3719
Total Cand. Countr. and Turkey	208403	145116	144151	124387	117087	110977	112515
Total Europe	466332	272358	267126	230891	216758	196911	191899
World	2728475	3818221	3833233	3789727	3505000	3447248	3408945
Europe as % of world	17 %	7 %	7 %	6 %	6 %	6 %	6 %

Table 1.4: Coal production figures in kt, 1980, 1996-2001
[111, DSK, 2002]

The table highlights the declining production in most European countries, the most radical examples being Germany, France and the UK. In Germany, by the end of 2000, there were only 12 mines left in production (1990: 27 mines, 1980: 39 mines, 1973: 53 mines, 1957: 173 mines).

In the UK, which is the biggest coal producer in the EU-15, there were an average of 41 open pit and 22 underground mines producing at any one time during the year 2002. 15 million tonnes of the UK production originates from open pit (or opencast) sites.

Hard coal in the Czech Republic mainly occurs in the Upper Silesian Basin. Regarding the coal resources within this region, about 15 % are in the Czech Republic, and the balance are in Poland.

[83, Kribek, 2002]

In many cases European production costs are several times the world average. Some mines, even though they cannot compete in the world market, are still in production only because they receive subsidies. However, in the UK, coal mining is in the main competitor with world coal. In 2001, 15 million tonnes of surface mined coal was produced and purchased by the electrical supply industry in competition with imported coals. No subsidies were paid to produce this coal. 17 million tonnes of deep mined coal was produced, again in the main, without subsidies. 'Selective Operating Aid' of some GBP 65 million was paid in 2001 to specific mines to enable them to achieve long-term viability and to compete long-term with imported coal.

The tailings from coal mining are the coarse tailings, which are managed on heaps, and flotation slurries, which are either discharged into ponds or, after filtering, onto heaps. The ponds may be small settling basins, which need to be dug out periodically. In other cases coal tailings ponds can cover tens of hectares and may be contained by tailings dams. Coal tailings can contain pyrite and flotation reagents.

Efforts have been made to use coal tailings as construction materials. Due to their low permeability dried flotation fines can also be used as liners for landfills.

Waste-rock is produced by open pit mining and is used to restore the site during extraction (by progressively restoring the coaled out areas) and on completion to produce a satisfactory landform. Waste-rock is also produced in underground mining from driveages etc. and then either remains underground or is stored in spoil heaps above ground.

1.5 European mine and mine waste production

The following tables show the production from European countries. The figures are expressed as percentages of total European production. The numbers used in these two tables are the same as used throughout Sections 1.1 to 1.4. However, these tables allow an easier overview of all the sectors. This table also makes it easier to compare the production figures of different countries.

	FERROUS METALS	NON-FERROUS METALS											PRECIOUS METALS	
	<i>Iron</i>	<i>Alumina</i> ¹	<i>Cadmium</i>	<i>Chromium</i>	<i>Copper</i>	<i>Lead</i>	<i>Manganese</i>	<i>Mercury</i>	<i>Nickel</i>	<i>Tin</i>	<i>Tungsten</i>	<i>Zinc</i>	<i>Gold</i>	<i>Silver</i>
	(%)	(%)	(%)	(%)	(%)	(%)	(%)	(%)	(%)	(%)	(%)	(%)	(%)	(%)
Austria	3	-	-	-	-	-	-	-	-	-	63	-	-	-
Belgium	-	-	-	-	-	-	-	-	-	-	-	-	-	-
Finland	-	-	29 ³	36	1	-	-	19 ³	7	-	-	2	17	2
France	-	9	8	-	-	-	-	-	-	-	-	-	16	-
Germany	-	12	-	-	-	-	-	-	-	-	-	-	-	-
Greece	-	10	-	-	-	4	2	-	93	-	-	2	-	4
Ireland	-	23	-	-	-	11	-	-	-	-	-	23	-	1
Italy	-	15	16	-	-	2	2	-	-	-	-	1	9	3
Portugal	-	-	-	-	11	-	-	-	-	96	37	-	-	1
Spain	-	18	8	-	3	17	-	81	-	-	-	22	22	-
Sweden	74	1	-	-	8	33	-	-	-	-	-	20	23	19
United Kingdom	-	-	18	-	-	-	-	-	-	4	-	-	-	-
Total EU-15 (t) ²	12816129	5970000	1900	248149	204749	236646	1972	291	14483	2264	3215	616868	16.27	525.46
Bulgaria	2	-	11	-	13	11	39	-	-	-	-	2	6	1
Cyprus	-	-	-	-	1	-	-	-	-	-	-	-	-	-
Czech Republic	-	-	-	-	-	-	-	-	-	-	-	-	-	-
Estonia	-	-	-	-	-	-	-	-	-	-	-	-	-	-
Hungary	-	4	-	-	-	-	26	-	-	-	-	-	-	-
Latvia	-	-	-	-	-	-	-	-	-	-	-	-	-	-
Lithuania	-	-	-	-	-	-	-	-	-	-	-	-	-	-
Malta	-	-	-	-	-	-	-	-	-	-	-	-	-	-
Poland	-	-	8	-	56	18	-	-	-	-	-	20	2	62
Romania	-	8	-	-	2	2	31	-	-	-	-	3	3	1
Slovakia	2	-	-	-	-	-	-	-	-	-	-	-	2	0
Slovenia	-	-	-	-	-	-	-	-	-	-	-	-	-	-
Turkey	19	-	2	64	6	2	-	-	-	-	-	5	-	6
Total Accessing Countries, Accession Countries and Turkey (t)	3945719	830000	500	433658	684066	114074	41372	-	-	-	-	273995	2.16	1244.09
Total EUROPE (t)	16761848	6800000	2400	681807	888815	350720	43344	291	14483	2264	3215	890863	18.43	1769.54
World (t)	556777376	53000000	16495	5777378	12364823	3340792	9595182	1673	1071425	228767	28015	7533028	2432.46	17293.21
EUROPE as % of world	3.0	12.8	14.5	11.8	7.2	10.5	0.5	17.4	1.4	1.0	11.5	11.8	0.8	10.2

1) year 2001
2) EU-15 Member States not listed do not produce any of these minerals
3) These figures include the Hg and Cd metallurgical production from imported ore. The figures for Finnish mine production are Cd: 2.5 %, Hg: 1 %.

Table 1.5: European mine production expressed in % of total European production of ferrous, non-ferrous and precious metals in 1999 (unless otherwise indicated)

	INDUSTRIAL MINERALS										COAL	
	Barytes (%)	Boron (%)	Feldspar (%)	Fluorspar (%)	Kaolin (%)	Limestone (%)	Phosphate (%)	Potash (%)	Strontianite (%)	Talc (%)	Hard-Coal (%)	
Austria	-	-	-	-	1	-	-	-	-	10	see Table 1.4	
Belgium	2	-	-	-	-	-	-	-	-	-		
Finland	-	-	1	-	-	-	100	-	-	35		
France	11	-	11	28	6	-	-	7	-	28		
Germany	18	-	5	8	13	-	-	70	-	2		
Greece	-	-	1	-	1	-	-	-	-	-		
Ireland	-	-	-	-	-	-	-	-	-	-		
Italy	4	-	36	13	6	-	-	-	-	10		
Portugal	-	-	5	-	1	-	-	-	-	2		
Spain	3	-	7	38	1	100	-	13	83	8		
Sweden	-	-	1	-	-	-	-	-	-	-		
United Kingdom	11	-	-	11	48	-	-	10	-	2		
Total EU-15 ¹	322762	-	3927357	350176	3906168	2000000	734068	5066880	10590	1260000		
Bulgaria	19	-	-	-	3	-	-	-	-	-		Candidate Countries: 4
Cyprus	-	-	-	-	-	-	-	-	-	-		
Czech Republic	-	-	4	-	9	-	-	-	-	-		
Estonia	-	-	-	-	-	-	-	-	-	-		
Hungary	-	-	1	-	-	-	-	-	-	-		
Latvia	-	-	-	-	-	-	-	-	-	-		
Lithuania	-	-	-	-	-	-	-	-	-	-		
Malta	-	-	-	-	-	-	-	-	-	-		
Poland	4	-	1	-	1	-	-	-	-	-		
Romania	1	-	1	-	1	-	-	-	-	-		
Slovakia	5	-	-	-	-	-	-	-	-	-		
Slovenia	-	-	-	-	-	-	-	-	-	-		
Turkey	22	100	28	1	9	-	-	-	17	-		
Total Accessing Countries, Accession Countries and Turkey (t)	344327	1242228	2004473	4812	1152811	-	-	-	-	60000		
Total EUROPE	666999	1242228	5931830	354988	4773774	2000000	734068	5066880	145000	1442000		
World	6326531	4200000	8950309	4612569	25982207	n/a	67040137	24665640	300000	5620000		
EUROPE as % of world	10.5	29.6	66.3	7.7	18.4	n/a	1.1	20.5	48.3	25.7		

1) EU-15 Member States not listed do not produce any of these minerals

Table 1.6: European mine production expressed in percentage of total European production of industrial minerals and coal in 1999 (unless otherwise indicated)

According to the Eurostat yearbook for 2003, in the EU-15 the following amounts of waste are generated.

Country and reference year	Agriculture and forest (kt)	Mining and quarrying (kt)	Manufacturing industry (kt)	Energy production (kt)	Construction (kt)
Austria 99	0	0	14284	0	25392
Belgium 99	0	619	13779	1287	0
Germany 93	0	67813	65119	25310	131645
Denmark 98	0	0	2783	1469	2962
Spain 99	0	22757	29239	0	22000
Greece 97	7781	3900	6682	9320	1800
France 95	377000	0	101000	0	13700
Finland 99	24000	28000	15910	1274	35000
Italy 97	242	350	22993	0	20587
Ireland 98	64578	3510	5113	450	2704
Netherlands 99	0	333	9779	1546	0
Portugal 99	0	4691	12804	487	63
Sweden 98		63818	19780	0	0
United Kingdom 99	84000	118000	50000	13000	71000

Table 1.7: European waste generation
[139, Eurostat, 2003]

It should be noted that any statistics on mining waste always bear a level of uncertainty, since some ‘residues’ from mining are in some states considered waste and in others they are not.

However, looking at the table above it becomes clear that waste from mining and quarrying represents a significant amount of the total waste generated in the EU-15, i.e. about 20 %.

1.6 Key environmental issues

Proper material characterisation is the basis for successful tailings and waste-rock management. The management of tailings and waste-rock is one part of the entire mining operation, which naturally also includes the actual extraction and the mineral processing stage. Not only do these other parts of the operation influence the management of tailings and waste-rock, in reality the methods of mining and mineral processing actually determine the management and not vice versa.

Tailings and waste-rock management sites go through certain phases from design to after care. It is essential to manage these facilities in a way that makes most sense in all phases of that life cycle.

Another important issue to consider is the adaptation to changes in reality. An example here may be that after 10 years of operation, the sulphide content in the waste-rock coming from the mine could increase to such a level that Acid Rock Drainage (ARD) could become an issue. To avoid this becoming a problem in the longer term, care needs to be taken during the operational phase by possibly mixing this waste-rock with other waste-rock containing buffering minerals or by separately depositing material with ARD potential in an adequate way. In the given example, it would be necessary to project any findings during operation to steps much further down the ‘life cycle road’ and to then act accordingly to achieve the best overall long-term environmental and economic benefit.

Within the mining industry environmental awareness has improved considerably over the last decades. Thus historical operations with large environmental impact cannot be regarded as representative for the prevailing modern management of waste-rock and tailings. A significant improvement has also been achieved concerning the legislative framework, permitting requirements and control. In reality, what this all means is that now the entire life cycle of the mine is considered at all times and the closure of the mine is planned and provided for in an environmentally acceptable way, even before the mine is opened.

1.6.1 Site location

Mining is a unique sector in so much as primarily geology determines the location of the mine. This is a major difference to other industries. An ore can only be mined where the deposit is. Of course the choice of mining method and the exact location of shafts and other infrastructure still have to be made.

The degrees of freedom in terms of choice of location increases the further downstream one goes in the process. The location for the extraction itself is predetermined as mentioned above. Typically, the mineral processing though, is undertaken as close to the actual mine site as possible, due to the often low grade of the ore, which implies that the ore value cannot cover high transport costs. However, this is not true in all cases and in some cases the ore is processed many thousands of kilometres away from the mine. For instance, for bauxite the processing into aluminium is very energy demanding and the transport cost of the ore can be recovered by lower energy costs for the processing in a different location (often though some pre-refining will still be done at the site).

For the management of tailings and waste-rock, the degrees of freedom concerning location is in general again increasing, but as with the mineral processing, it is generally preferable to limit or reduce the transportation cost. However, in many cases tailings are pumped or trucked many kilometres to an appropriate site for deposition.

When it comes to the selection of a tailings and/or waste-rock management site many other factors have to be considered, such as:

- preferable use of existing geographic formations (e.g. existing pits or slopes)
- need to respect the hydrogeological setting of the surrounding area (ground- and surface water)
- adaptation of facility to surrounding area (e.g. dust, noise and odour control if there is a residential population nearby)
- meteorology (e.g. rainfall data)
- geotechnical and geological background (e.g. foundation conditions, seismic risk data)
- natural and cultural environment
- relationship of tailings facility to underground operation
- topography of long-term construction
- proximity to surface water
- proximity to the coast (seawater)
- existing land-use
- local communities
- biodiversity.

Underwater deposition, which is often carried out for tailings with an ARD potential, involves a different set of issues, such as secure surface water supply, a natural or constructed basin, post-deposition use of area, etc.

The proximity to surface water is often a complex issue. On the one hand, if a discharge to surface water is required it is preferable to have the river 'next door'. On the other hand, it needs to be assessed if this surface water would act as the ideal transport medium of tailings in the case of an accidental release.

In general, a balance has to be maintained between the proximity of the tailings or waste-rock management site to the mineral processing site for economical reasons and other factors such as those listed above. In reality, often the site investigation will result in several 'candidate locations'. The actual decision is then made in the permitting process, often as a compromise between the operator, the permit writers and public concerns.

1.6.2 Material characterisation including prediction of long-term behaviour

The only way of determining the long-term behaviour of tailings and waste-rock is to characterise them properly. This may sound trivial, but it has often been neglected in the past. Too often the focus has been on the saleable concentrate, which generates revenue and not on the remaining residue. However, operators should not forget the negative economic effect that improper tailings and waste-rock management can incur.

From an environmental point of view, the main difference between the mineral in the original deposit and the same mineral, less as much as possible of the desired mineral, in the tailings and waste-rock is the increased availability for physical, chemical and biological processes to affect the mineral. This means that through the treatment of the ore (mainly comminution) the constituents of the tailings and waste-rock are more accessible. The following two examples may further explain this phenomenon:

Sulphide ore, in its natural location (i.e. underground and bound in rock mass), is not exposed to an oxidising environment. The finely ground tailings of this ore, once discarded in a pond, are much more accessible to water and oxygen. The surface area of accessible sulphides is increased by orders of magnitude through the size reduction. This implies that, if not managed properly, the rate of weathering, and thereby the mobilisation of weathering products, may be significantly increased.

Another example is potash ore. These ores consist of potash minerals and rock salt. The deposits are protected from water by impermeable layers (typically of clay and gypsum). The tailings of this same ore, however, consist mainly of rock salt (>90 %) and are typically piled up on heaps. This salt is accessible for precipitation and is washed-off over a long period of time.

Also, the mineral processing of the ore may change the chemical characteristics of the processed mineral and hence the tailings.

Overall, the characteristics that have to be investigated are, e.g.:

- chemical composition, including the change of chemistry through mineral processing and weathering
- leaching behaviour
- physical stability
- behaviour under pressure
- erosion stability
- settling behaviour
- hard pan behaviour (e.g., crust formation on top of the tailings).

Proper material characterisation is the basis for any planning of the management of tailings and waste-rock. Only if this background work is done properly can the most appropriate management measures be applied.

General issues about closure, rehabilitation and after-cares are discussed in Section 2.6. Applied measures are shown in Section 4.2.4.

Each mining operation will have an irreversible impact on the earth's crust. To qualify this impact, baseline studies are carried out to give a point of reference. Baseline studies are described in more detail in Section 4.2.1.1.

1.6.3 Environmentally relevant parameters

The environmentally relevant parameters of tailings and waste-rock management facilities can be subdivided into two categories: (1) operational, and (2) accidental. Both have to be taken into consideration.

During operation the 'typical' emissions to air, water and land have to be considered and techniques to reduce these emissions will be discussed in this document. However, two very important environmental issues which need to be highlighted are:

- the generation of acid rock drainage and
- the occurrence of accidental bursts or collapses.

1.6.3.1 Typical emissions and management of water and reagent

- **Emissions to air** can be dust, odour and noise. Usually the latter two are of less concern unless the tailings or waste-rock are transported with trucks and there is residential housing nearby. Dust can consist of materials such as quartz or any other components found in rocks and minerals, including metals.
- **Emissions to water** can include reagents from mineral processing, such as
 - cyanide
 - xanthates
 - acids or bases resulting in low or high pH
 - solid or dissolved metals or metalliferous compounds (e.g. iron, zinc, aluminium)
 - dissolved salts e.g. NaCl, Ca(HCO₃)₂, etc,
 - radioactivity (in coal tailings/waste-rock heaps)
 - chloride (coal mines)
 - suspended solids.
- **Emissions to land** can occur via settled dust or via the seepage of liquids from tailings and/or waste-rock management facilities into the ground. The building and removal of temporary storage piles is one often occurring source of land contamination. This is also true for the construction of industrial areas, railway banks, tailings dams, etc., using waste-rock containing, e.g. ARD producing material.
- **Overall management of water and reagents, such as:**
 - Consumption and treatment and/or recycling of
 - reagents (e.g. flotation reagents, cyanide, flocculants) and
 - waterprior to discharge into tailings facility or surface water
 - management of precipitation and surface water (e.g. gathering in ditches).

It should be noted that emissions to land are a highly site-specific issue and that there are very few default emission scenarios currently available to characterise these emissions.

1.6.3.2 The environmental impact of emissions

Effluents and dust emitted from tailings and waste-rock management facilities, controlled or uncontrolled, may be toxic in varying degrees to humans, animals and plants. The effluents can be acidic or alkaline, may contain dissolved metals and/or soluble and entrained insoluble complex organic constituents from mineral processing, as well as possibly natural occurring organic substances such as humic and long-chain carboxylic acids from the mining operations. The substances in the emissions, together with their pH, dissolved oxygen, temperature and hardness, may all be important aspects in the toxicity to the receiving environment.

Certain reagents, such as cyanides, frothers and xanthates require long retention time, oxidation (air, bacteria, sunlight) and, for xanthates, temperatures above 30 °C to decompose. Therefore the planning of the mineral processing circuit and the TMF must consider the environmental impacts of these substances and the potential need for extra ponding or treatment to provide for certain reagents' decomposition.

[21, Ritcey, 1989]

The actual environmental impact of emissions to watercourses always depends on many factors such as concentration, pH, temperature, water hardness etc. However, Ritcey [21, Ritcey, 1989] and many other sources, provide tables listing, e.g.:

- maximum and minimum pH levels for various aquatic life form
- ammonia toxicity data
- acute toxicity data for various flotation agents
- toxicity of specific chemicals
- toxicity data for flocculant and coagulants.

These tables can give an impression of the potential impact of certain reagents, but, as mentioned above, the whole picture has to be taken into consideration.

The following table shows the effects of some metals on humans, animals and plants.

Metal	Effect
Arsenic (As)	Highly poisonous and possibly carcinogenic in humans. Arsenic poisoning can range from chronic to severe and may be cumulative and lethal
Cadmium (Cd)	Cadmium is concentrated in tissue and humans can be poisoned by contaminated food, especially fish. Cd may be linked to renal arterial hypertension and can cause violent nausea. Cd accumulates in liver and kidney tissue. It depresses growth of some crops and is accumulated in plant tissue
Chromium (Cr)	Cr ⁺⁶ is toxic to humans and can induce skin sensitisations. Human tolerance of Cr ⁺³ has not been determined
Lead (Pb)	A cumulative body poison in humans and live-stock. Humans may suffer acute or chronic toxicity. Young children are especially susceptible
Mercury (Hg)	Hg and its compounds are highly toxic, esp. to the developing nervous system. The toxicity to humans and other organisms depends on the chemical form, the amount, the pathways of exposure and the vulnerability of the persons exposed
Copper (Cu)	Small amounts are considered non-toxic and necessary for human metabolism. However, large doses may induce vomiting or liver damage. Toxic to fish and aquatic life at low levels
Iron (Fe)	Essentially non-toxic but causes taste problems in water
Manganese (Mn)	Affects water taste and may stain laundry. Toxic to animals at high concentrations
Zinc (Zn)	May affect water taste at high levels. Toxic to some plants and fish

Table 1.8: Effects of some metals on humans, animals and plants
[53, Vick, 1990]

1.6.3.3 Acid rock drainage

The past two decades have brought widespread awareness of a naturally occurring environmental problem in mining known as 'Acid Rock Drainage' or ARD. Though difficult to reliably predict and quantify, ARD is associated with sulphide ore bodies mined for Pb, Zn, Cu, Au, and other minerals, including coal. While ARD can be generated from sulphide-bearing pit walls, and underground workings [13, Vick,], only tailings and waste-rock are considered in this document.

The key issues that are the root of these environmental problems are:

- tailings and/or waste-rock often contain metal sulphides
- sulphides oxidise when exposed to oxygen and water
- sulphide oxidation creates an acidic metal-laden leachate
- leachate generation over long periods of time.

Unless otherwise mentioned the following information is from [20, Eriksson, 2002].

The basics of ARD

When sulphide minerals come into contact with water and oxygen they start to oxidise. This is a slow heat generating process (kinetically controlled exothermal process) which is promoted by:

- high oxygen concentration
- high temperature
- low pH
- bacterial activity.

The overall reaction rate for a specified quantity of sulphides is also dependant on other parameters such as, for example, the type of sulphides and the particle size, which also governs the exposed surface area. When the sulphides oxidise they produce sulphate, hydrogen ions and dissolved metals.

Tailings and waste-rock consist of the different natural minerals found in the mined rock. In the unmined rock, often situated deep below the ground level, the reactive minerals are protected from oxidation. In oxygen-free environments, such as in deep groundwater, the sulphide minerals are thermodynamically stable and have low chemical solubility. Deep groundwater in mineralised areas, therefore, often has a low metal content. However, when excavated and brought to the surface, the exposure to atmospheric oxygen starts a series of bio-geo-chemical processes that can lead to production of acid mine drainage. Hence, it is not the content of metal sulphides in itself that is the main concern, but the combined effects of the metal sulphide content and the exposure to atmospheric oxygen. The effect of exposure increases with decreasing grain size and, therefore, increased surface area. Hence the sulphides in the finely ground tailings are more prone to oxidation [14, Höglund, 2001].

Tailings and waste-rock are normally composed of a number of minerals, of which the sulphides only constitute one part, if present at all. Therefore, if sulphide oxidation occurs in mining waste, the acid produced may be consumed by acid consuming reactions in varying degrees, depending on the acid consuming minerals available. If carbonates are present in the mining waste, pH is normally maintained as neutral, the dissolved metals precipitate and thus are not transported to the surrounding environment to any significant degree. Other acid consuming minerals include alumino-silicates. The dissolution of alumino-silicates is kinetically controlled and cannot normally maintain a neutral pH in the drainage.

The interaction between the acid producing sulphide oxidation and the acid consuming dissolution of buffering minerals determines the pH in the pore water and drainage, which in turn influences the mobility of metals. If the readily available buffering minerals are consumed, the pH may drop and ARD will then occur.

The release of ARD to surface- and groundwater deteriorates the water quality and may cause a number of impacts, such as depletion of alkalinity, acidification, bioaccumulation of metals, accumulation of metals in sediments, effects on habitats, elimination of sensitive species and unstable ecosystems.

The chemical processes of acid generation and acid consumption are explained in Section 2.7

Weathering at the field scale

ARD may be produced where sulphide minerals are exposed to the atmosphere (oxygen and water) and there are not enough readily-available buffering minerals present. In mining this could be in, e.g., waste-rock deposits, marginal ore deposits, temporary storage piles for the ore, tailings deposits, pit walls, underground workings or in heap leach piles. Historically sulphide-containing material has also been used for construction purposes at mine sites, e.g. in the construction of roads, dams and industrial yards. However, regardless of where ARD production occurs, the fundamental processes behind the generation of ARD are the same.

Figure 1.21 schematically shows some of the most important geochemical and physical processes and their interaction and contribution to the generation of ARD and the possible release of heavy metals from mining waste. As can be concluded from the figure, the ARD and metal release will depend primarily on the sulphide oxidation rate, the potential immobilisation/remobilisation reactions along the flow path and the water flow. However, the sulphide oxidation rate is dependant on redox conditions (Eh), pH, and microbial activity. The pH is, in turn, determined by the sulphide oxidation rate and buffering reactions (carbonate dissolution and silicate weathering). Furthermore, the potentially metal retaining immobilisation reactions that can occur along the flow path are dependant on pH, redox conditions and the sulphide oxidation rate.

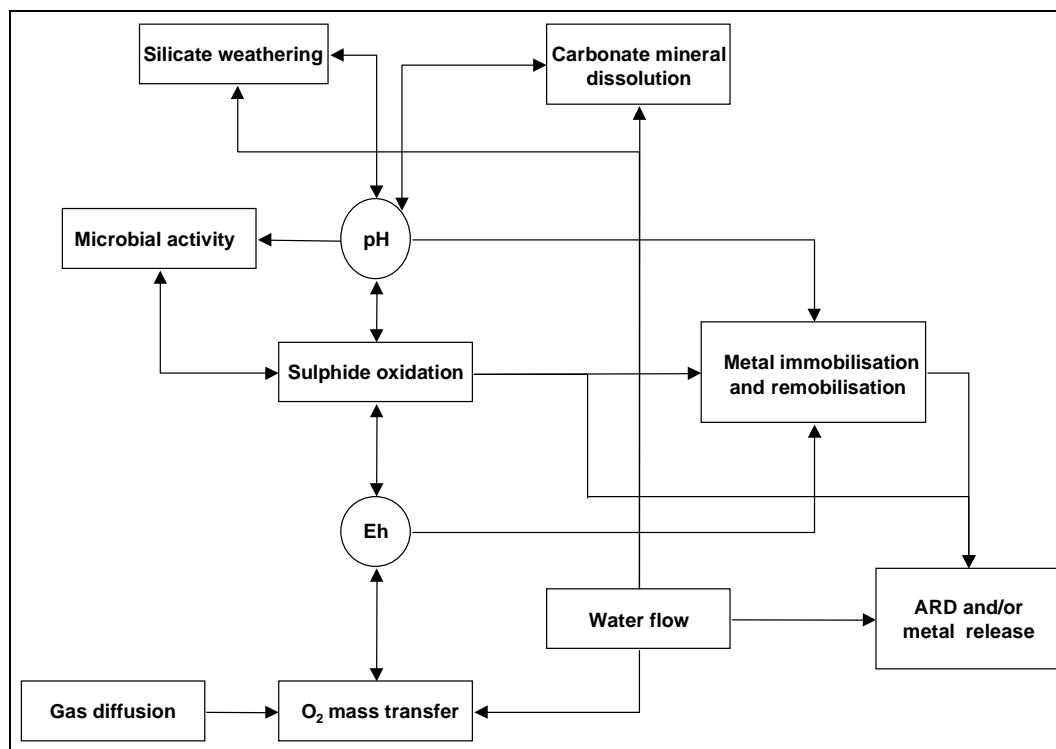

Figure 1.21: Schematic illustration of some of the most important geochemical and physical processes and their interaction and contribution to the possible release of heavy metals from mining waste

[20, Eriksson, 2002]

At the field-scale not only are the temporary variations of material characteristics important for the evolution of the drainage water quality but the spatial variations will also be a factor to take into account. The resulting drainage characteristics depend on a number of additional parameters, such as infiltration rate, evaporation rate, oxygen profile in the deposit, height of the deposit, and the construction of the deposit. Heterogeneities in the material characteristics, such as varying mineralogy and degree of compaction, are other parameters that may affect the drainage water quality. Due to the normally long residence time of the infiltrating water in the deposit, the influence of various immobilisation reactions (precipitation and adsorption) can also be significant. The interaction between the tailings and/or waste-rock and the atmosphere is illustrated schematically in the following figure.

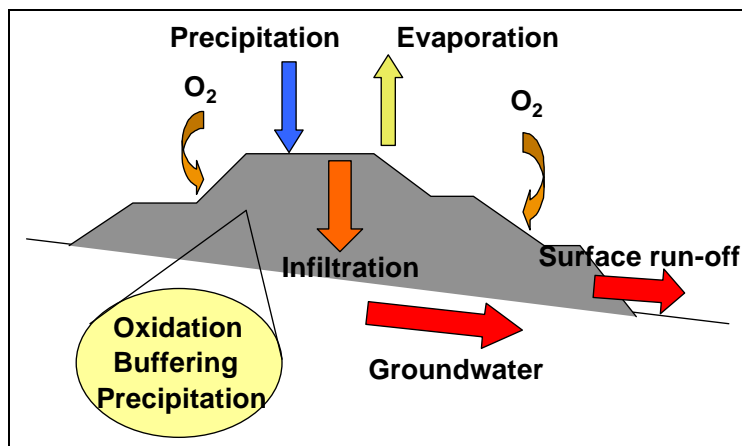

Figure 1.22: Schematic illustration of the drainage water generation as a function of the interaction between the tailings or waste-rock in the facility and the atmosphere [20, Eriksson, 2002]

1.6.3.4 Accidental bursts or collapses

The bursts or collapses of tailings dams at operations in Aznalcollar and Baia Mare have brought public attention to the management of tailings ponds and tailings dams. However, it should not be forgotten that the collapse of tailings and waste-rock heaps can cause severe environmental damage. The dimensions of either type of tailings management facility can be enormous. Dams can be tens of metres high, heaps even more than 100 m and several kilometres long possibly containing hundreds of millions of cubic metres of tailings or waste-rock. At the other extreme are ponds the size of a swimming pool or heaps smaller than a townhouse.

The following two pictures show the two extremes. Figure 1.23 shows a pond containing 330 Mm³ of tailings and Figure 1.24 shows a small settling basin.



Figure 1.23: Example of a large tailings pond (330 Mm³)



Figure 1.24: Example of a small tailings settling basin

Tailings dams are built to retain slurried tailings. In some cases, material extracted from the tailings themselves is used for their construction. Tailings dams have many features in common with water retention dams. Actually, in many cases they are built as water retaining dams, particularly where there is a need for the storage of water over the tailings [9, ICOLD, 2001].

Heaps are used to pile up more or less dry tailings or waste-rock.

The collapse of any type of TMF can have short-term and long-term effects. Typical short-term consequences include:

- flooding
- blanketing/suffocating
- crushing and destruction
- cut-off of infrastructure
- poisoning.

Potential long-term effects include:

- metal accumulation in plants and animals
- contamination of soil
- loss of animal life.

Guidelines for the design, construction and closure of safe TMFs are available in many publications. If the recommendations given in these guidelines were to be closely followed, the risk of a collapse would be greatly reduced. However, major incidents continue to occur at an average of more than one a year (worldwide) [9, ICOLD, 2001]

An investigation of 221 tailings dam incidents has identified the main causes for the reported cases of dam failures. The main causes were found to be lack of control of the water balance, lack of control of construction and a general lack of understanding of the features that control safe operations. It was found that only in very few cases did unpredictable events, such as unexpected climatic conditions or earthquakes, cause the bursts [9, ICOLD, 2001].

1.6.4 Site rehabilitation and after-care

When an operation comes to an end, the site needs to be prepared for subsequent use. Usually, these plans are part of the permitting of the site from the planning stage onwards and should, therefore, have undergone regular updating, depending on changes in the operation and in negotiations with the permittees and other stakeholders. In some cases, the aim is to leave as little a footprint as possible, whereas in other cases, a complete change of landscape may be aimed for. The concept of 'design for closure' implies that the closure of the site is already taken into account in the feasibility study of a new mine site and is then continuously monitored and updated during the life cycle of the mine. In any case, negative environmental impacts need to be kept to a minimum.

Some sites can be handed over to the subsequent user after a relatively simple reclamation, e.g. after reshaping, covering and re-vegetation. In other cases, after-care will need to be undertaken for long periods of time, sometimes even in perpetuity.

It is impossible to restore a site to its original condition. However, the operator, the authorities and the stakeholders involved have to agree on the successive use. It will usually be the operators responsibility to prepare the site for this. In order to receive a permit for the closure, the characteristics of the impounded material should be well determined (e.g. amounts, quality/consistency, possible impacts). As indicated in Section 1.6.3.3 avoiding future ARD is a main concern for the closure design for tailings with a net ARD potential.

2 COMMON PROCESSES AND TECHNIQUES

This chapter aims to provide background information to non-experts in the management of tailings and waste-rock. Together with the specific glossary this chapter should allow the reader to understand the subsequent chapters.

2.1 Mining techniques

The extraction of an ore, (a process called mining), subsequent mineral processing and the management of tailings and waste-rock are, in most cases, considered to be a single operation. Even though this document does not cover the ore extraction, the subsequent mineral processing techniques and tailings and waste-rock management are all highly dependent on the mining technique. Hence, it is important to have an understanding of the most important mining methods.

For the mining of solids, there are four basic mining concepts:

- (1) open pit
- (2) underground mine
- (3) quarry and
- (4) solution mining.

The choice between these four alternatives depends on many factors, such as:

- value of the desired mineral(s)
- grade of the ore
- size, form and depth of the orebody
- environmental conditions of the surrounding area
- geological, hydrogeological and geomechanical conditions of the rock mass
- seismic conditions of the area
- site location of the orebody
- solubility of the orebody
- environmental impact of the operation
- surface constraints
- land availability.

Often the uppermost part of an orebody is mined in an open pit, but over time and with increasing depth, the removal of overburden makes this mining method uneconomical, so deeper parts are sometimes mined underground (see figure below). An alternative to continuing the mining underground, is often to stop production altogether, as the processing plant may have designed for large tonnages only, which are difficult to achieve underground. Mining costs are significantly higher underground, which is another reason for often ruling out this possibility. It also may be rejected if the orebody is not continuous enough to allow economical underground mining. Rock stability may also set limits on any underground mining.

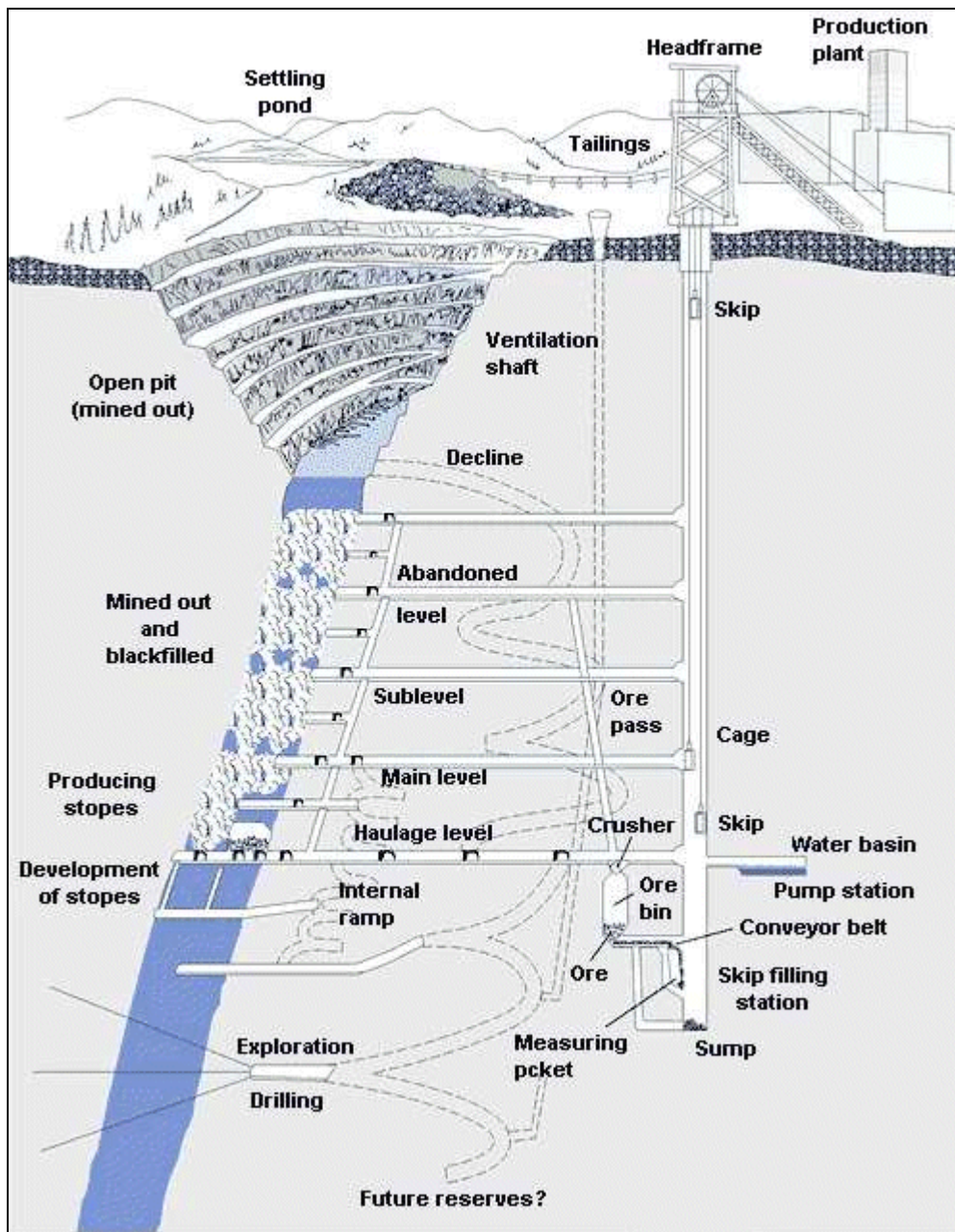

Figure 2.1: Transition from open pit to underground mining [93, Atlas Copco, 2002]

If open pit is the chosen mining method, it will, in most cases, result in larger amounts of waste-rock. This is indicated in the following two figures. The waste-rock may be deposited close to the open pit, backfilled into the current or nearby mined out open pits or crushed and sold if there is a market for the material.

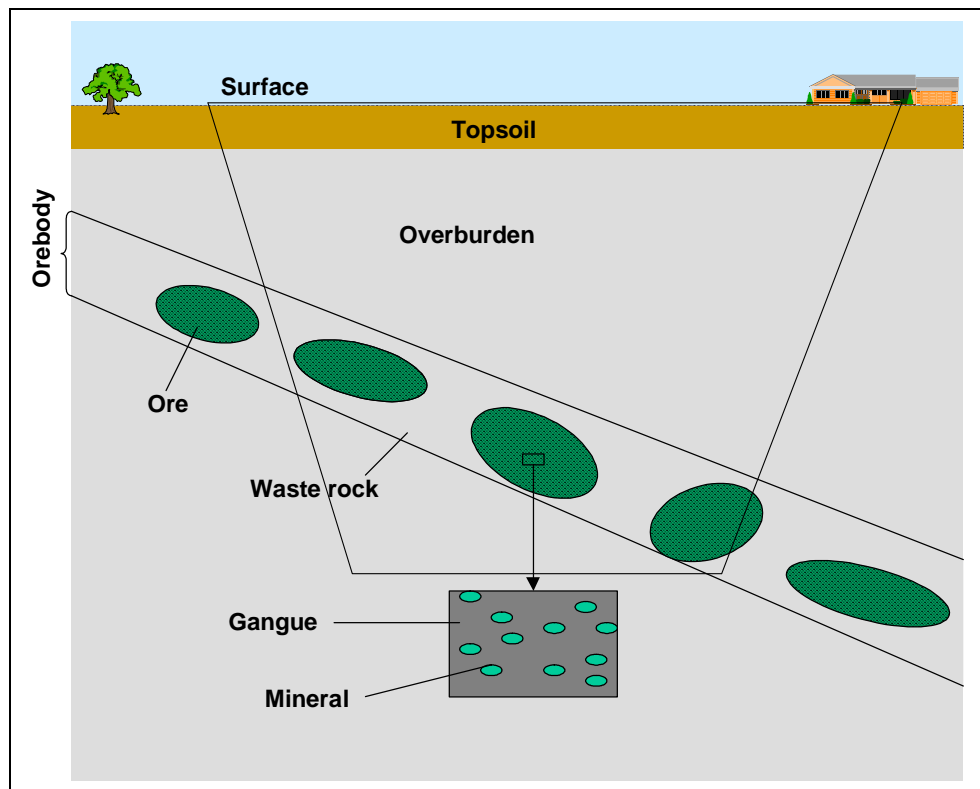

Figure 2.2: Schematic drawing of an open pit

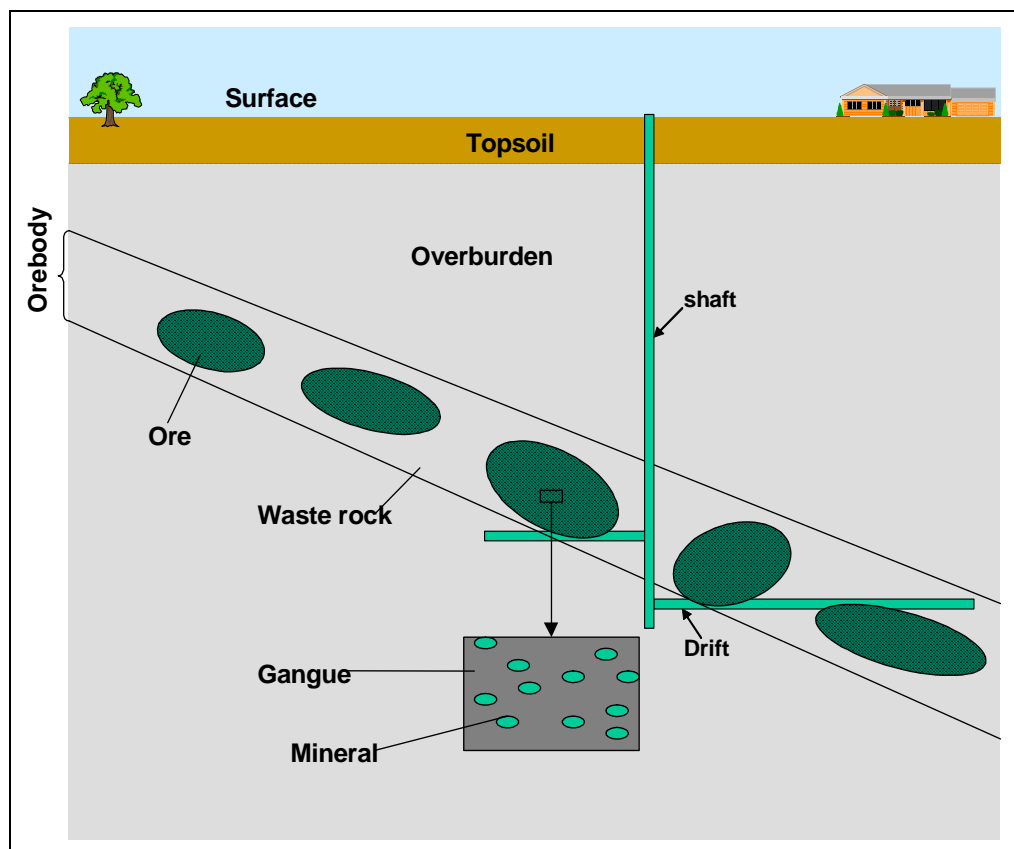

Figure 2.3: Schematic drawing of an underground mine

In the example shown in the above figures the amounts of topsoil, overburden and waste-rock that will have to be moved using the open pit technique are greater than with underground mining. In the latter case, a shaft and drifts are constructed from which the ore can be mined more selectively, meaning areas of waste-rock and/or low grade ore can mostly be left out. The waste-rock that has to be mined is either moved within the mine or hoisted to the surface.

It should be noted that the above drawings only show schematic drawings of one scenario. As will be described in the following section there are many different types of orebodies. Also the grades can vary quite significantly, for example, in most cases, viable industrial minerals deposits have an ore grade of between 50 and 99 %. This is one of the main differences with the metallic ores, where grades are much lower.

For underground mining, it is also possible to backfill mined out areas. This may be difficult to realise in open pit operations that progress vertically while they still being mined, unless the backfill material can be moved to another pit. However open pits that progress horizontally are typically progressively restored.

2.1.1 Types of orebodies

The type of orebody has a big influence on the choice of mining method. The following types of orebodies are known, with classification depending on the form of the orebody or the distribution of the ore:

- seam-type orebody
- vein-type orebody
- massive-type orebody (e.g. massive sulphides with high variations of grade within the orebody; limestone orebodies with very consistent grades)
- disseminated-type orebody (e.g. copper porphyries).

Often the disseminated type has a ‘cap’ of weathered sulphides (hence oxides) on top of a disseminated-type orebody. The ore within this weathered cap is called ‘gossan’.

2.1.2 Underground mining methods

There are many different ways of exploiting an orebody using underground mining methods. The most commonly used underground mining methods are:

Mining method	Application
Longwall mining	Flat, thin seam type ore bodies, soft rock
Room and pillar mining	Inclined massive-type ore bodies and flat seam-type deposits
Sublevel stoping	Steep, large ore bodies (massive- or disseminated-type)
Cut and fill mining	Steep, firm ore bodies, selectivity, mechanisation (seam-, vein-, massive-, disseminated-type)
Sublevel and block caving	Steep, large or massive ore bodies, extensive development effort (mostly massive-, disseminated-type)

Table 2.1: Most important underground mining methods and their areas of application [47, Hustrulid, 1982]

Section 3.1.4.1 provides an example of a highly mechanised underground mining operation using large-scale sublevel caving.

These methods have been widely described in literature (e.g. AIME/SME Underground mining methods handbook, <http://sg01.atlascopco.com>). The basic objective of selecting a method to mine a particular orebody is to design an ore extraction system that is most suitable under the existing circumstances. This means aiming for lowest operational costs. This decision is based upon both technical and non-technical factors (e.g. high productivity, complete extraction of the ore, safe working conditions).

In 'room and pillar' mining, some of the ore remains unmined and serves as support (the pillars) for the mine shafts. In some cases, backfilling is used to allow subsequent mining of these pillars.

A reduction of tailings can be achieved by using the most selective mining method, i.e. by insuring that only undiluted ore is fed to the mineral processing plant, so that the amount of waste-rock that has to be handled, is minimised. Feeding diluted ore to the mineral processing plant results in a decrease in recovery and, therefore, results in larger amounts of the desired mineral being lost in the tailings.

2.2 Mineralogy

Basically it is possible to differentiate between oxide, sulphide, silicate and carbonate minerals, which, through weathering and other alterations, can undergo fundamental changes (e.g. weathering of sulphides to oxides). Mineral paragenesis and intergrowth are important bases for the subsequent mineral processing and, thereby, the tailings and waste-rock management. Therefore, a basic knowledge of the mineralogical composition is of utmost importance.

Mineralogy is set by nature and determines, in many ways, the subsequent recovery of desired minerals and the tailings and waste-rock management. Mineralogy often changes within an orebody and hence during the life of a mine. Sometimes these changes are well known and can be planned for, sometimes they occur unexpectedly. Some examples are listed below:

- oxides on top and sulphides in deeper lying parts of the orebody, which require completely different mineral processing and tailings management methods
- ore type changing from a copper ore to a zinc ore
- ore type changing from a magnetite to a haematite type iron ore (Malmberget).

Mineralogy has a big influence on the mining technique chosen and the sequencing of mining operations. For example, for gold mining the gossan is mined because it is more easily accessible and naturally enriched and is easier to recover. The deeper lying sulphides have to be oxidised before they can be recovered, which makes the process less profitable. For copper, it is also easier to recover the oxide section, which can easily be leached using sulphuric acid, than the sulphides, which have to be recovered using flotation.

The sulphide content, which is determined by mineralogy, influences the tailings and waste-rock management, because of its acid generating potential (see Section 2.7).

Having a good knowledge of mineralogy is an important precursor for:

- environmentally sound management (e.g. separate management of acid-generating and non-acid-generating tailings or waste-rock)
- a reduced need for end-of-pipe treatments (such as the lime treatment of acidified seepage water from a TMF)
- more possibilities for utilising tailings and/or waste-rock as aggregates.

2.3 Mineral processing techniques

The purpose of mineral processing is to turn the raw ore from the mine into a marketable product.

2.3.1 Equipment

The following information is all taken from [105, Wotruba, 2002].

2.3.1.1 Comminution

Comminution is an essential element of mineral processing. It requires a great deal of expenditure in terms of energy consumption and maintenance. In comminution, the particle size of the ore is gradually reduced. This is necessary for many reasons, e.g.:

- to liberate one or more valuable minerals from the gangue in an ore matrix
- to achieve the desired size for later processing or handling
- to expose a large surface area per unit mass of material, thus aiding some specific chemical reaction (e.g. leaching)
- to satisfy market requirements relating to particle size specifications.

Comminution is composed of a sequence of crushing and grinding processes.

After grinding, the ore, often in slurry form, 'contains' the now liberated ore particles and the tailings material which need to be separated in later process steps. The characteristics of the ore, in combination with the equipment used for the crushing and grinding, determine the physical properties of the tailings, such as the particle shape and particle size distribution.

2.3.1.1.1 Crushing

Crushing is the first stage in the comminution process. This is usually a dry operation, which involves breaking down the ore by compressing it against rigid surfaces or by impacting it against hard surfaces in a controlled motion flow.

This process step prepares the ore for further size reduction (grinding) or for feeding directly to the classification and/or concentration separation stages. Tailings are usually not generated in this process step.

Typical types of crushers are:

- jaw crushers
- gyratory crushers
- cone crushers
- roll crushers
- impact crushers.

2.3.1.1.2 Grinding

Grinding is the final stage in the comminution process and requires the most energy of all the mineral processing stages. Because of this, the tendency is to first blast (in the mine) or crush the ore as fine as possible to reduce the amount of larger materials sent to grinding, thereby reducing the overall energy consumption in grinding and, hence, comminution. If possible, grinding is performed 'wet' as this requires less energy, allowing energy savings of up to 30 % compared to dry grinding. In grinding, the particles are usually reduced by a combination of impact and abrasion of the ore by the free motion of grinding bodies such as steel rods, balls or pebbles in the mill.

Tumbling mills

Tumbling mills consist of a rotating cylindrical steel vessel on a horizontal axis, with openings on both ends for feeding and discharging material. The vessel contains tumbling bodies that are free to move as the mill rotates on its horizontal axis (the vessel rotating on hollow trunnions fastened to the end walls). The tumbling bodies include balls, rods, or other shapes and forms, and are made of steel, cast iron, hard rock, ceramic materials or may even consist of the material itself being reduced (pebbles).

The most commonly used **tumbling mills** are:

- rod mills, for product sizes: <1 mm
- ball mills, for product sizes: <100 μm
- autogenous (AG) mills, semi-autogenous (SAG) mills; product size: in combination with ball mills typically <1500 μm ; if only AG or SAG mill:<100 μm possible.

Figure 2.4 and figure 2.5 respectively show a ball mill and a grinding circuit, consisting of AG mills and ball mills used for primary and secondary grinding.

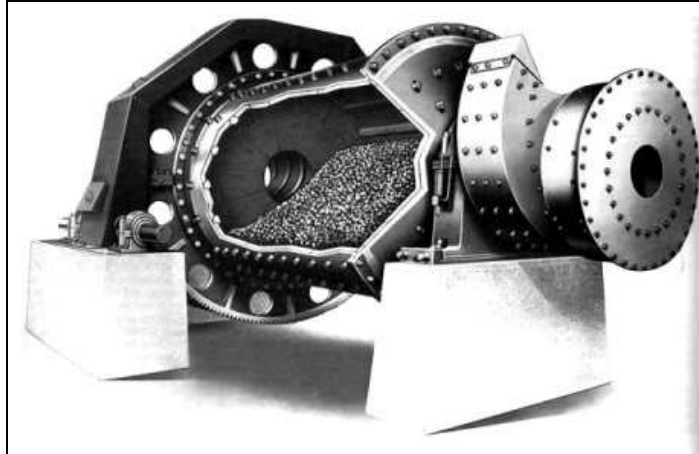

Figure 2.4: Ball mill



Figure 2.5: Grinding circuit with AG mills (primary grinding, right side) and ball mills (secondary grinding, left side)

In rod and ball mills, the grinding media are rods and balls made of steel and sometimes ceramic. Sometimes, conical steel pieces, called cylpeps, are used as a grinding medium in ball mill size mills. As reflected by the name, in AG mills the ore grinds itself. For this purpose, larger ‘pebbles’, i.e. fist size pieces, of the ore are required in the mill. In SAG mills, these pebbles are assisted by a small loading, compared to rod and ball mills, of steel balls.

Tumbling mills are essential for fine grinding of large quantities (e.g. for froth flotation feed or agitation leaching feed).

The degree of grinding is governed by the ore characteristics and the chosen method(s) of extracting the valuable minerals, e.g. flotation requires a fine feed. However, overgrinding will generate ‘slimes’ which can reduce the efficiency of flotation and as a secondary effect could also lead to tailings that take a longer time to dewater and become stable in a pond.

Beside tumbling mills, other important types of grinding equipment are **agitated mills** and **vibrating mills**.

Agitated mills

Agitated mills are used for very fine wet grinding. Agitated mills (or tower mills) are vertical steel cylinders filled with 80 - 90 % grinding media which are agitated by an internal flighted axis. Throughput is a maximum of 100 t/h, feed size <1 mm, and the product size will be 1 - 100 μm .

Vibrating mills

Vibrating mills are used for very fine grinding (dry or wet). Continuous vibrating mills are horizontal steel cylinders filled with 60 – 70 % grinding media, agitated by an eccentric drive. Throughput is a maximum of 15 t/h, for product sizes of <10 μm .

2.3.1.2 Screening

Screening can be defined as a mechanical operation which separates particles according to their sizes and their acceptance or rejection by openings of a screening face. Particles that are bigger than the apertures of the screens are retained, and constitute the oversize. Conversely, those that are smaller pass through the screening surface, forming the undersize. There are many different types of industrial screens, which may be divided into stationary and moving screens. The most important reasons for screening in mineral processing are:

- to avoid undersize material entering the crushers
- to avoid oversize material passing to the later stages in the grinding process or in closed-circuit fine crushing
- to produce material of controlled particle size, e.g. after quarrying.

2.3.1.3 Classification

Classification may be described as the separation of solid particles into two or more products according to their velocities when falling through a medium. The velocity of the particles depends on their size, density and shape. In mineral processing, classification is mostly carried out wet, with water being used as the fluid medium. Dry classification, using air as the medium, is used in several applications (cement, limestone, coal). Classification is normally performed on minerals considered too fine to be separated effectively by screening.

2.3.1.3.1 Settling cones and hydraulic classifiers

Uses: Cones (or settling cones) are mostly used for de-sliming. Hydraulic classifiers in the mineral industry are used either to receive final products (sand industry) or to prepare feed into several particle size ranges for subsequent gravity concentration processes.

Principles and construction: Settling cones are conical vessels, where the pulp is introduced vertically from the top. Coarse particles settle down and leave the vessel through the underflow spigot, fine particles leave the vessel with most of the water over the upper rim (overflow). Hydraulic classifiers use extra water, which is injected into the separating vessel. The direction of water flow is opposite to that of the settling particles. In general, hydraulic classifiers are composed of a sequence of columns, in which a vertical current of water rises inside each column with heavier particles settling out first. A typical hydraulic classifier is the 'Fahrenwald classifier', widely used in the glass and foundry sand industry. New hydraulic classifiers are the 'allflux' or similar models, that combine hydraulic classification with autogenous dense medium thus combining classification with dense medium separation (mostly used to de-coal sands).

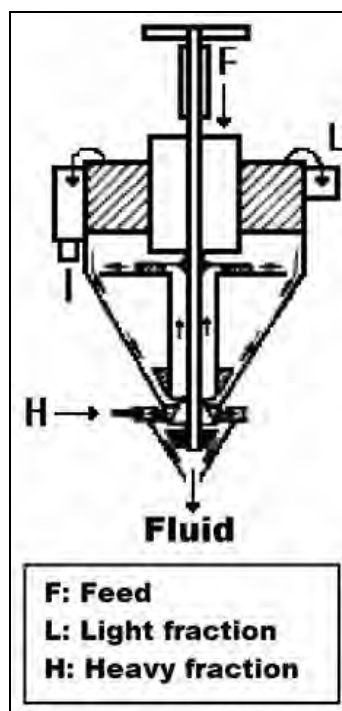

Figure 2.6: Hydraulic classifier

2.3.1.3.2 Hydrocyclones

Uses: Widely applied in mineral processing for fine classification (mostly <math><100\mu\text{m}</math>), often in a closed-circuit with ball mills for flotation or leaching feed preparation and for special fine final products (kaolin). They are particularly efficient for fine separation sizes, such as de-sliming, thickening and de-gritting.

Principle and construction: A hydrocyclone is a vessel composed of a cylindrical section with a tangential feed entrance, joined to a lower conical part. The feed is accelerated and rotates at high speed within the vessel, transporting the coarse particles by centrifugal forces to the inner wall, from where it moves down along the conical part and leaves the vessel through the underflow spigot. The slower settling fine particles stay in the centre of the fluid, which forms an inner upstream current and leaves the vessel through the central upper discharge opening. To avoid short-cuts, the upstream is collected by an adjustable inner piece of pipe, connected to the overflow outlet (vortex finder).

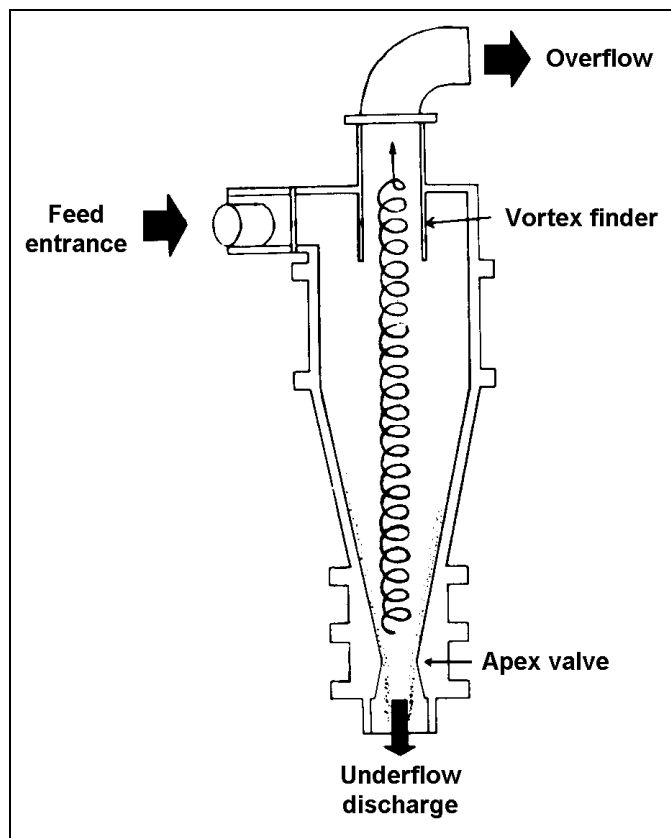

Figure 2.7: Hydrocyclone

The separation size and the throughput depend on the diameter of the hydrocyclone. For larger throughputs hydrocyclones are used in parallel.

2.3.1.3.3 Mechanical classifiers

Uses: Formerly closed-circuit grinding operations, dewatering, washing and de-sliming operations, were frequently used in milling circuits, but they are now gradually being replaced by hydrocyclones. Nowadays, they are mostly used in the sand and gravel industry and in smaller ore processing plants.

Principles and construction: Mechanical classifiers consist of a settling tank with parallel sides and an inclined base, which is equipped with a device that constantly promotes the agitation of the pulp and removal of the settled solids. The feed pulp is fed into the classifier, forming a settling pool in which particles of high falling velocity rapidly fall to the base of the tank. Mechanical rakes or helical screws drag the material deposited on the equipment bottom, upwards. At the same time, the material of lower settling velocity is taken away in a liquid overflow. There are various types of mechanical classifiers available, mainly ‘spiral classifiers’ and ‘rake classifiers’.

General technical data spiral classifiers:

- tank length: 3 – 12 m
- tank width: 0.3 – 6.5 m
- spiral circumferential speed: 10 – 40 m/min
- tank inclination: 14 - 18°
- rate of flow: 10 - 90 m³/h.

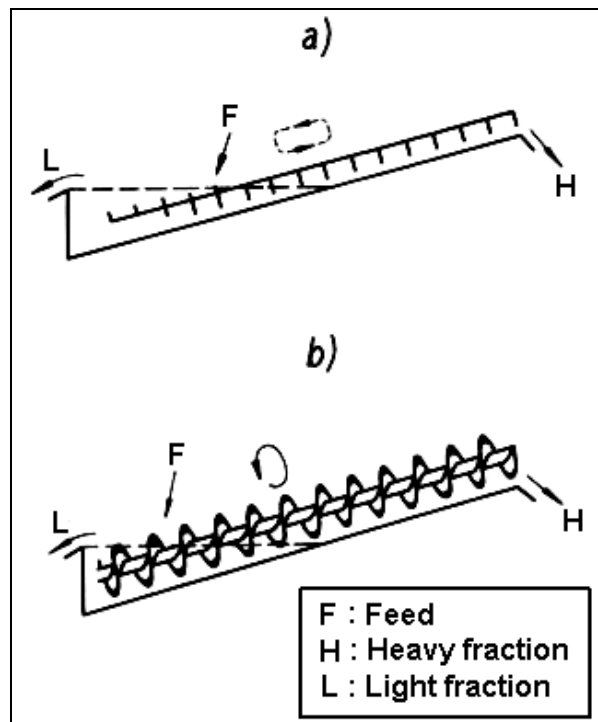

Figure 2.8: Rake and spiral classifiers

2.3.1.4 Gravity concentration

Gravity concentration is a method of separating minerals of different density by the force of gravity or by other forces, such as centrifugal force or the resistance to movement offered by a viscous fluid, such as water or air. The motion of a particle in a fluid is dependent not only on its specific gravity, but also on its size and shape. Advanced gravity concentration has proven itself to be an alternative to flotation and leaching, since, among other reasons, no reagents are required.

2.3.1.4.1 Dense medium separation

Gravitational vessels

Uses: Coal industry, also iron and chromite ore processing.

Principle and construction: Gravitational vessels include containers into which both the feed and dense medium are introduced. The floats are separated by paddles or simply by overflow, while the sinks can be removed by different means according to the separator design. The most complicated part of the separator design is the discharge of the sinks, as the purpose is to remove the sink particles without draining the dense medium by producing disturbing downward currents in the vessel. There are numerous types of gravitational vessels available, such as the 'Wemco cone separator', 'drum separators', or the 'Drewboy bath'.

General technical data:

Drewboy bath:

- feed particle size: up to 1000 mm
- rate of flow: 25 – 150 t/h per m of wheel width.

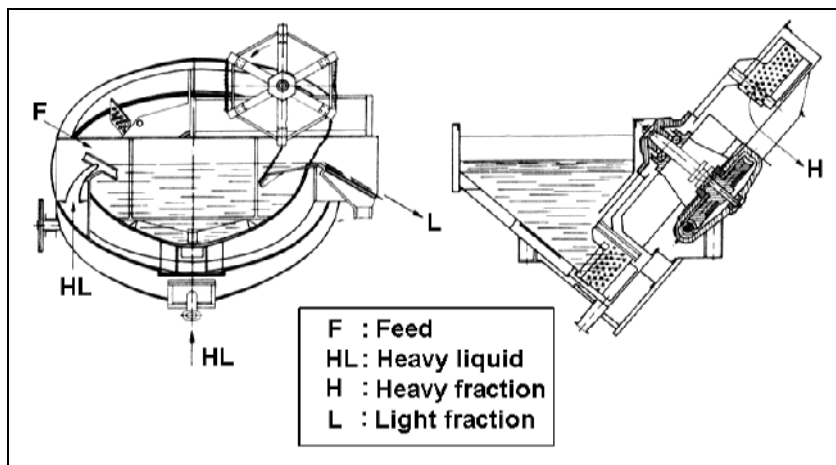

Figure 2.9: Drewboy bath

Centrifugal separators

Uses: Treatment of coal, chromite, baryte, fluorspar, etc. and for the concentration of particles in the intermediate size range, in particular those too small for conventional gravity-type separators but too large for froth flotation.

Principles and construction: In centrifugal separators, centrifugal acceleration aids the gravitational acceleration in separating minerals with low densities from those with high densities. The two most important types of dense medium centrifugal separators are the 'DSM cyclone' commonly called 'dense medium cyclone' and the 'Dyna-Whirlpool (DWP)' and similar types (e.g. the 'Tri-Flow', which is basically a three-product separator consisting of two in-line Dyna-Whirlpools). A similar size to the Dyna-Whirlpool in design but larger in capacity and feed size is the 'Larcodems'-separator.

General technical data:

DSM cyclone (dens media cyclone):

- feed size: metal ores in the size range 0.5 - 10 mm, and coal in the size range 40 - 0.5 mm
- diameter: 250 - 1500 mm
- maximum density: 3 t/m³
- capacity: up to 30 t/h.

Dyna Whirlpool (DWP):

- feed size: coal, diamonds, tin and lead-zinc ores in the size range 0.5 - 30 mm, barytes, feldspar
- cylinder inclination: 30°
- capacity: 30 - 100 t/h
- diameter: 250 - 400 mm.

2.3.1.4.2 Jigging

Uses: Jigging is used today in pre-concentration or in the sorting process of coarse material (mainly coal). Many large jig plants are in operation in the gold, barytes, coal, cassiterite, tungsten, iron-ore, sand and gravel industries.

Principles and construction: In jigging the ore particles are held up on a perforated screen or plate in a layer many times higher than the thickness of the major particle. This layer or 'bed' is exposed to an alternating increasing and decreasing (pulsating) flow of fluid in an attempt to produce stratification, causing all the high density particles to move to the base of the bed while the low specific gravity particles assemble at the top of the bed. The fluid is commonly water. There are various types of jigs such as the 'Denver mineral jig', the 'circular jig', the 'Baum jig' and the 'Batac jig'.

General technical data (examples):

Denver Mineral Jig (mostly used for heavy minerals, in milling circuits):

- high frequency: 280 - 350/min
- fine grains: 100 μm – 5 mm
- application: heavy minerals and sulphides
- maximum setting surface: 2 x (60 x 90 cm)
- maximum throughput: 30 t/h.

Batac jig (mostly used for coal):

- width: up to 7 m
- length: up to 6 m
- throughput: up to 1000 t/h.

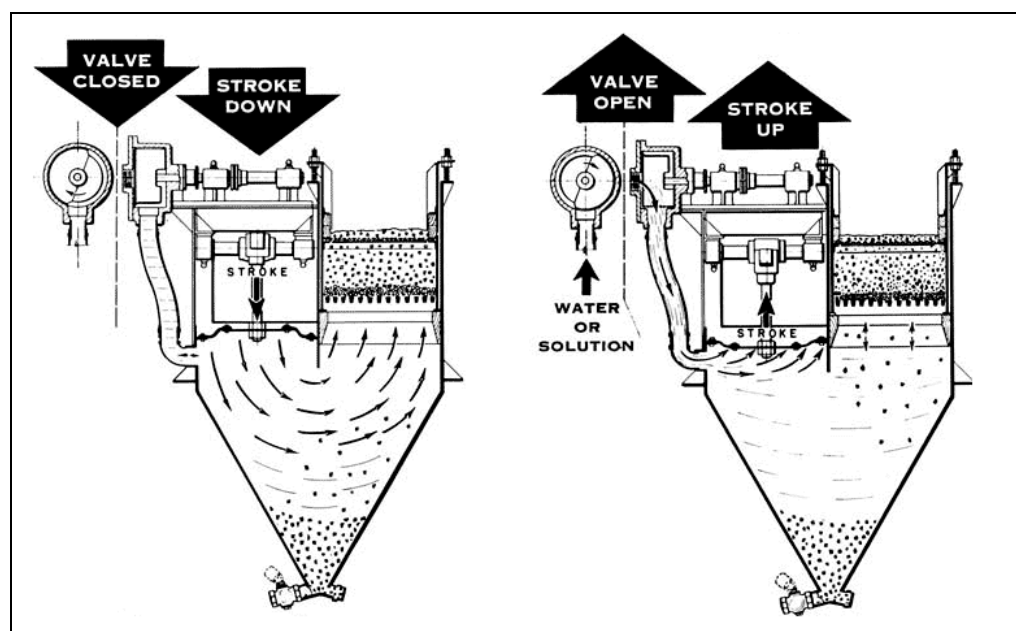

Figure 2.10: Denver mineral jig

2.3.1.4.3 Shaking tables

Uses: Treatment of coal, gold, heavy minerals, tantalum, tin, barite, glass sands, chromite, etc.

Principles and construction: The shaking table can be described as a platform deck with a slight inclination, riffles and a rectangular or rhomboid form. The shaking table is commonly built from wood or fibreglass. Water and solids are fed onto its upper edge. The table vibrates longitudinally as a result of slow forward strokes and quick returns. The minerals move slowly along the table, under exposure to two forces. The first force is caused by the deck movement and the second one by a streaming film of water. The outcome is that the minerals separate on the deck, the lighter, bigger grains being taken to the tailings launder whilst the denser, smaller grains are carried in the direction of the concentrate launder at the far side of the deck. The concentrate can be divided into various products, for example a middling fraction and a high-grade concentrate, by adjustable splitters situated at the concentrate end. The shaking table has various designs and operating variables which regulate the process.



Figure 2.11: Shaking table

2.3.1.4.4 Spirals

Uses: Diverse applications, principally used in the processing of heavy mineral sands, gold, tin, tantalum, glass sands, and fine coal

Principles and construction: Spirals consist of a helical trough with a modified semicircular cross-section. The slurry is fed into the top of the spiral and during its helical course, the grains are stratified as a consequence of different mechanisms such as the differential settling rates of the particles, centrifugal forces and interstitial trickling through the flowing particle layer. Product bands are removed through adjustable splitters along the helix and/or at the lower discharge end of the spiral. Nowadays, several types of spirals are applied for gravity concentration, all developed from the original 'Humphreys spiral'.

General technical data:

- processable particle size: coal: 0.1 – 4 mm, metal ores: 0.02 – 1 mm
- throughput: 1-3 t/h per spiral.

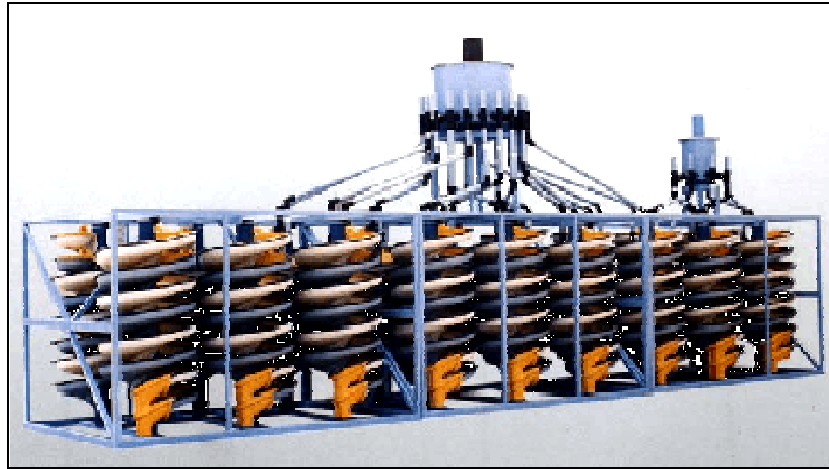

Figure 2.12: Spiral bank

2.3.1.4.5 Cones

Other than the settling cones mentioned in Section 2.3.1.3.1, which classify the feed according to grain size, cones are used for separation according to specific gravity.

Uses: In high-capacity gravity concentration applications for fine material (<1 mm), such as in the treatment of beach sands; pre-concentration of tin, iron and gold, recovery of wolframite and chromite, and in the concentration of magnesite.

Principles and construction: Several stages of upgrading can be carried out in a single unit of equipment, since the equipment consists of several cone sections piled vertically. In the 'Reichert cone', for example, a vertical distributor cone distributes the feed at high pulp density around the periphery of an upturned concentration cone. When the feed flows in the direction of the cone centre the heavy mineral particles separate to the bottom of the film. An annular slot in the base of the concentrating cone withdraws this concentrate while the fraction of the film flowing over the slot, constituting the tailings, falls into the feed box for the second stage.

General technical data:

- cone diameter: 2 m
- solids content: 55 – 65 %
- throughput: 70 – 100 t/h.



Figure 2.13: Reichert cone

2.3.1.5 Flotation

Uses: This is the most important separation technique used in mineral processing for base-metal ores. Originally used to concentrate sulphides, ores of copper, zinc and lead, it is nowadays also used in the treatment of non-metallic ores such as fine coal, fluorite and phosphate, potash, oxides such as cassiterite and haematite; and oxide minerals, such as cerussite and malachite.

Principles and construction: In flotation, the separation of minerals is accomplished by utilising the differences in their physico-chemical surface properties. For instance, after conditioning with reagents, some particles become water repellent or hydrophobic (or aerophilic), while other particles remain hydrophilic. In the selective separation process, the air-bubbles stick to the hydrophobic (or aerophilic) particles, lifting them to the water surface and forming a stable froth, which is removed. The hydrophilic particles remain within the pulp and are discharged. Flotation processes generally consist of several stages to clean the concentrates again and to scavenge the remaining valuable minerals from the tailings.

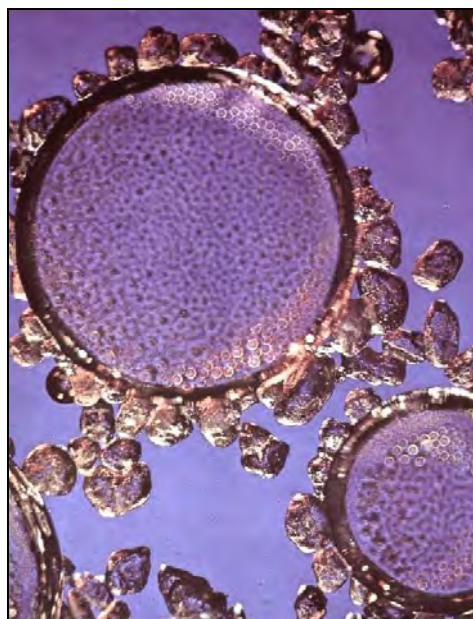

Figure 2.14: Flotation process

Flotation cells

There are two principal types of flotation cells: pneumatic and mechanical.

- mechanical cells are the traditional and most widely used devices applied in flotation plants. They consist of steel vessels which have a mechanically driven impeller that causes the dispersion of the air as small bubbles and agitates the slurry. Several single cells are mounted to a bank. The froth overflows or is removed with mechanical paddles
- there are two main types of pneumatic flotation cells: flotation columns and the short pneumatic flotation cell. Flotation columns consist of a high (up to 15 m) vertical steel cylinder of up to 3 m diameter. The feed pulp enters the cylinder at about three quarters of the way up. Air enters into the vessel through a sparger at the lower end of the cylinder. Charged froth is washed by water sprays before it leaves the cylinder over the upper rim. The tailings with the hydrophilic particles leave the cylinder through the underflow spigot. Short pneumatic flotation machines do the bubble-particle collision outside the separating vessel in the pulp feeding tube, through various mixing devices or 'reactors', where compressed air is pumped into the pulp. The three-phase mixture enters the separating vessel, where the charged bubbles rise to the upper rim, where they then leave the vessel, while the tailings are discharged at the conical bottom.



Figure 2.15: Mechanical flotation cell

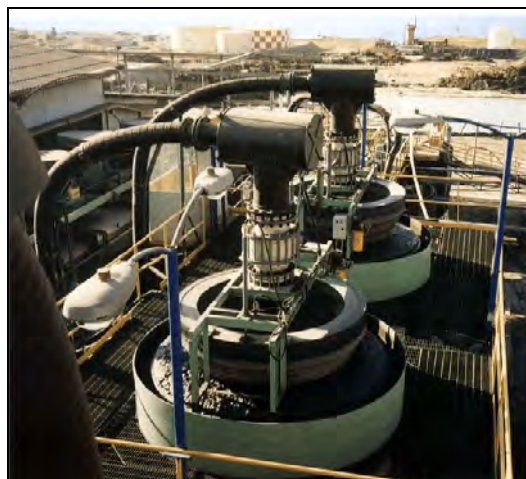

Figure 2.16: Pneumatic flotation cell

2.3.1.6 Magnetic separation

Uses: Tramp iron removal, concentration of ferromagnetic and paramagnetic minerals, cleaning of glass sands

Principles and construction: Magnetic separation is based on the different magnetic properties of minerals. In general, minerals can be divided into three groups according to their magnetic characteristics: diamagnetics, paramagnetics or ferromagnetics. Diamagnetics are materials which are repelled by a magnet and so are not able to be separated magnetically. Paramagnetics are materials that are attracted weakly to a magnet and can be concentrated in 'high-intensity magnetic separators'. Ferromagnetics are also materials attracted to a magnet, but this attraction is much stronger than in paramagnetics. Consequently, 'low-intensity magnetic separators' are applied to concentrate them.

The most commonly used magnetic separators are:

- dry low-intensity separators. These include drum separators principally utilised to concentrate coarse sands (cobbing process); cross-belt separators and disc separators both applied in the processing of sands; and 'magnetic pulleys' used for tramp iron removal
- wet low-intensity separators: drum separators are used to cleanse the magnetic medium in the Dense Medium Separation (DMS) circuits and to treat ferromagnetic sands, bowl traps, magnetising coils and demagnetising coils
- dry high-intensity magnetic separators: induced roll separators are used in the concentration of phosphate ore, glass sands, beach sands, tin ores and wolframite
- wet high-intensity magnetic separators: Jones separator are applied in the treatment of low-grade iron ores containing haematite.



Figure 2.17: Low-intensity drum separators

2.3.1.7 Electrostatic separation

Uses: Concentration of minerals such as ilmenite, rutile, zircon, apatite, asbestos, haematite and potash.

Principles and construction: Electrostatic separation is a method which utilises forces acting on charged or polarised bodies in an electric field to carry out mineral concentration. Different mineral particles, depending on their conductivity, will follow different paths in an electric field, making it possible to separate them. Some significant factors in this process include the mechanical and electrical characteristics of the separator and the size, form, specific gravity, surface condition and purity of the mineral particles. Mineral particles have to be entirely dry and the moisture of the surrounding air must be controlled. Electrostatic separators can be divided into plate electrostatic separators and screen electrostatic separators.

2.3.1.8 Sorting

Uses: Separation of industrial minerals, such as magnesite, barytes, talc, limestone, marble, gypsum, flint; recovery of wolframite and scheelite from quartz; treatment of gold ores, uranium ores and the recovery of diamonds.

Principles and construction: Ore sorting has been carried out since ancient times. Even though 'hand sorting' is nowadays not so common as it once was, mainly because of the large quantities of low-grade ore requiring very fine grinding, it is still applied in remote and underdeveloped countries. The mechanised procedures of sorting can be divided into photometric sorting, radiometric sorting (with uranium ores) and electrical sorting (resistance test, metal detectors).

Photometric sorting is a process, where the ore is separated into different fractions after an optical examination. The feed particles must be coarse enough e.g. (usually greater than about 10 mm) for sorting equipment to effect the desired separation at an acceptable rate. Some detectable characteristics, or combination of properties, must be present to allow a discrimination of the valuable, from the non-valuable, material. The basis of the photometric sorter is a light source and a sensitive photomultiplier, used in a scanning system to detect light reflected from the surfaces of the feed. An electronic circuit analyses the photomultiplier signal, which varies with the intensity of the reflected light, and produces control signals to activate the appropriate valves of an air-blast rejection device to take away certain particles selected by means of the analysing process.

2.3.1.9 Leaching

Uses: Extraction of rock salt, potash, gold (dissolution of native gold in cyanide solutions) and silver, uranium ore (dissolution of uraninite in carbonate solutions), copper and also residual substances.

Principles and construction: Leaching is a method where valuable minerals are selectively dissolved from a material by a lixiviant, normally aqueous solution, resulting in a rich solution (with high concentration of valuable compounds). Afterwards, the valuable mineral needs to be recovered, for instance by precipitation. The valuable mineral or compound can appear in the material being leached in at least three physical forms: as free particle, as multiphase particle in which the valuable mineral is exposed on at least one side to the lixiviant, and as inaccessible material surrounded by gangue material. In the first two cases, the valuable mineral can be directly leached.

There are several techniques of leaching. These can be grouped into fixed bed procedures, such as percolation leaching, heap leaching, and in-situ leaching, as well as leaching in a pulp in movement such as in agitation leaching (tank leaching) and pressure leaching. There is also a 'biological leaching' which uses the bacteria *thiobacillus ferrooxidans* and *thiobacillus thiooxidans*.

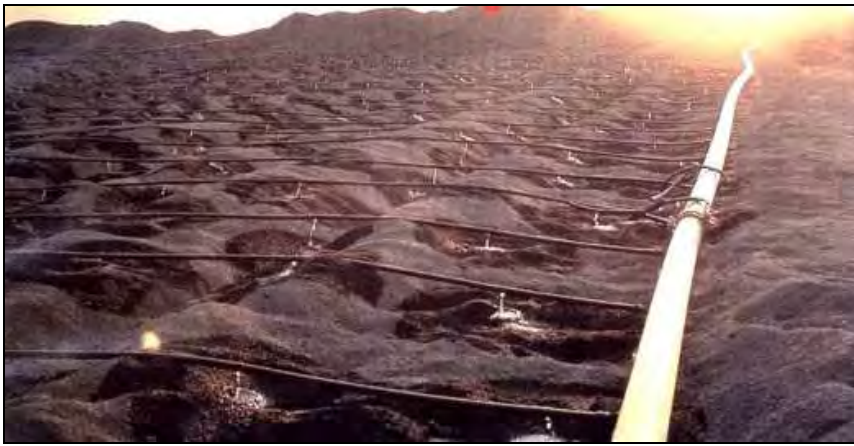

Figure 2.18: Heap leaching

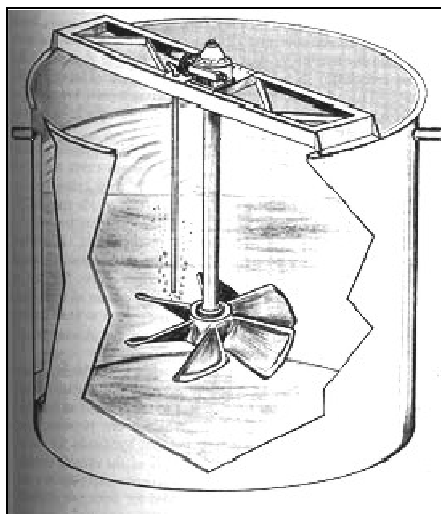

Figure 2.19: Leaching tank

2.3.1.10 Dewatering

Thickening

Uses: Thickening is extensively applied in pre-dewatering of concentrates and in tailings dewatering for water recovery, due to its comparatively low cost and high capacities compared to filtering. Intermediate thickening is also applied in several mineral processing techniques.

Principles and construction: Thickening is a sedimentation process that results in a large increase in the concentration of the suspension and in the formation of a clear liquid. Thickeners are tanks from which the settled and thickened solids are removed at the bottom as an underflow and the clear liquid flows to an overflow point or launder system at the top. They may be batch units, such as the baffle-plate thickener, or continuous units. Continuous thickeners are normally constructed of a cylindrical tank made of steel (mainly less than 30 m in diameter), concrete or a combination of both with the depth ranging from approx. 1 to 7 m and the diameter from approx. 2 to 200 m. In the tank, there will be one or more rotating radial arms, each possessing a series of blades. These blades rake or scrape the settled solids towards the underflow withdrawal point. There are several types of continuous thickeners, for instance bridge thickeners, centre pie thickeners, traction thickeners, tray thickeners and high-capacity thickeners.

General technical data:

Continuous thickener:

- diameter: 2 – 200 m
- diameter/height:
 - small thickener: 1:1 up to 4:1
 - large thickener: up to 10:1

Baffle-plate thickener:

- effective surface lamella thickener: up to 600 m²



Figure 2.20: Continuous thickener

Filtering

Uses: Dewatering of flotation concentrate, magnetic concentrates and several non-metallic minerals; removing pregnant solution from the leached solid in the cyanide process; washing the dewatered filter cake; clarifying decanted pregnant solution and in collecting precipitate.

Principles and construction: Filtration can be regarded as the process of separating solids from a liquid by means of a permeable septum, which holds the solid but allows the passage of liquid. Filtration often follows thickening, whereby the thickened pulp may be fed to storage agitators where sometimes flocculants are added and from where it is drawn off at a uniform rate to the filters. The most common types of filters employed in mineral processing are ‘cake filters’ in which the principal requirement is the recovery of large solid amounts from quite concentrated slurries. Cake filters are classed essentially as ‘vacuum filters’ and ‘pressure filters’, depending on the means employed for effecting the required pressure difference on the two sides of the porous medium. They may be also ‘batch’ or ‘continuous’ types.

The most frequently utilised types of pressure filters are ‘filter presses’, which are constructed in two main forms: ‘the plate-and-frame filter press’ and ‘the chamber press’. The operating pressure in the plate and frame press can achieve 25 bar.

On the other hand, there are several types of vacuum filters, such as ‘continuous drum filters’ (made in a wide variety of designs), ‘continuous disk filters’ and ‘horizontal belt filters’.

General technical data:

- plate-and-frame filter press:
 - plate size: up to 2 x 2 m
 - filter surface: maximum 1500 m² per machine
- continuous drum filter:
 - filter surface: approximately up to 120 m²
- continuous disk filter:
 - larger filter surface per volume unit: approximately up to 200 m²

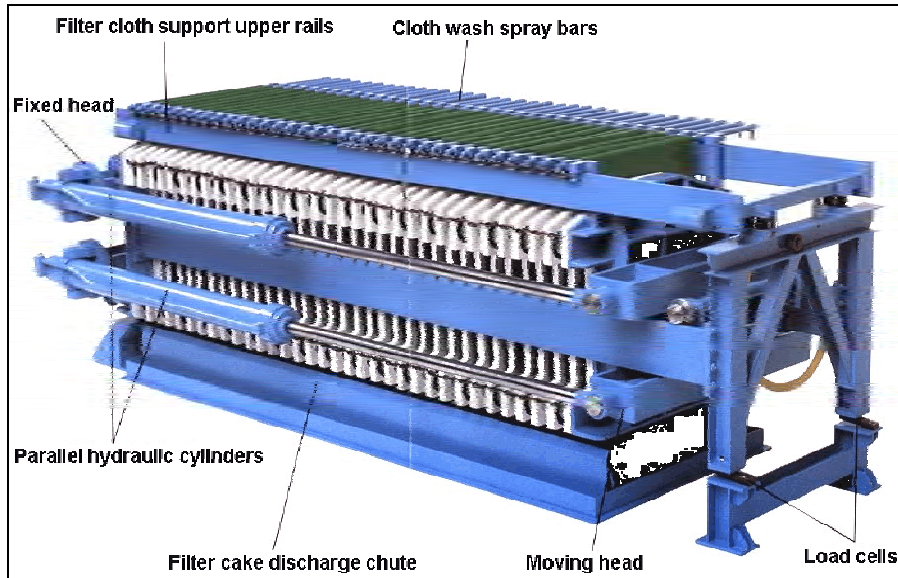

Figure 2.21: Plate-and-frame filter press



Figure 2.22: Drum filter

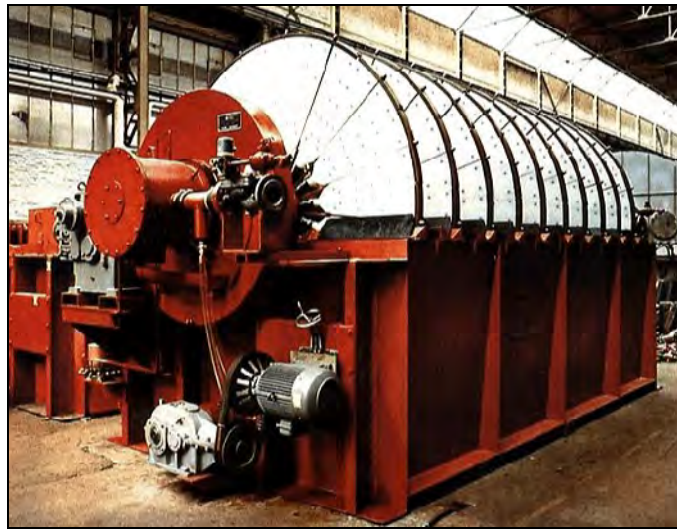

Figure 2.23: Disk filter

Centrifuging

As an alternative to plate-and-frame filter presses, solid bowl centrifuges are used for dewatering.

General technical details include:

- drum diameter: up to 1100 mm
- drum length: up to 3300 mm
- throughput: max. 15 tonnes (dry basis)/hour

Dewatering by means of centrifuges results in a lower solid contents compared to plate-and-frame filter presses. Therefore, the dewatered material behaves more like a jelly than a cake. Flocculants have to be added for optimal results.

2.3.2 Reagents

Flotation reagents

Flotation reagents are the various chemical compounds used in the flotation process, which assure the appropriate conditions for the operation. They are selectively employed according to the ore type. They comprise ‘collectors’, ‘frothers’ and ‘regulators’.

- collectors: are ‘surface-active substances’, i.e. organic compounds which adsorb on mineral surfaces, leaving them hydrophobic and making bubble adhesion possible. They are divided into ionising or non-ionising compounds. Non-ionising collectors are practically insoluble and cover the surfaces of minerals with an high natural hydrophobicity (mainly coal), to strengthen its water-repellent properties. Ionising collectors dissolve in water and have a heteropolar structure, that means a non-polar group (hydrocarbon group) which has water-repellent properties, and a polar group which attaches to the mineral surface. The type of polar group classifies the collector: anionic (carboxylic, sulphates, sulphonates, xanthates and dithiophosphates), cationic (amine) collectors or amphoteric collectors
- frothers: are reagents that help to keep the stability of the froth, e.g. acids, amines and alcohols
- regulators or modifiers: are reagents which regulate the flotation operation. They are classed as activators, depressants or pH modifiers. Activators allow collector adsorption on minerals by changing the chemical character of the mineral surfaces. Such substances are generally soluble salts. Depressants (water glass, starch, quebracho, etc.) conversely render minerals hydrophilic, thereby stopping them floating. pH modifiers (such as lime, soda and caustic soda for alkalinity, and predominantly sulphuric acid for acidification) control the pH of the

pulp, which has an important influence on most process steps (collector and depressant adsorption, etc.)

- flocculants: in German hard coal processing plants, flocculants for industrial use are applied based either on polyacrylates or on polyacrylamides.

2.3.3 Effects on tailings characteristics

Process step	Tailings characteristics								
	Grain size distribution	Generation of fines	Specific surface	% solids	Reagents	pH	ARD influence	Surface properties	Particle shape
Comminution	X	X ¹	X	X ²	-	-	X	X	X
Screening	X	X ³	-	-	-	-	-	-	-
Classification	X	X	-	X	-	-	X	-	-
Gravity conc.	-	-	-	X	-	-	X	-	-
Flotation	-	-	-	X ⁴	X ⁵	X ⁶	X	X	-
Magnetic sep.	-	-	-	-	- ⁷	-	X	-	-
Electr. sep.	-	-	-	-	X	-	X	X	-
Sorting	-	-	-	-	-	-	X	-	-
Leaching	-	-	-	X	X	X	-	X	-
Thickening	-	-	-	X ⁸	X ⁹	-	-	X	-
Filtering	-	-	-	X	X	X ¹⁰	-	X	-

1) e.g. agitated mill generates more fines than ball mill
 2) crushing dry, tumbling mills and agitated mills wet process
 3) excessive screening can lead to generation of fines
 4) flotation is a wet process with about 30 - 40 % solids in metal ore processing and 5 - 15 % solids in coal processing, in most cases water will have to be added
 5) see 2.3.2 for details
 6) raised or lowered
 7) usually no reagents, however, for fines sometimes dispersion agents are used for deagglomeration
 8) obviously % solids are reduced by thickening
 9) often use of flocculants (see 2.3.2 for details)
 10) e.g. by using flocculants such as aluminium sulphate or lime, which change pH

Table 2.2: Effects of mineral processing steps on tailings characteristics

Screening and classification have an indirect influence on the grain size distribution and generation of fines if they are used in a closed-circuit with grinding, such as a ball mill in closed circuit with a cyclone. In this example, the ball mill discharge is fed to a cyclone. The cyclone overflow is of such a grain size that the desired mineral is liberated for subsequent separation or concentration. The cyclone underflow needs further size reduction and is led back to the ball mill. In this example, the classifier ensures that overgrinding in the mill does not occur.

It should be noted that for magnetic (if wet) and gravity separation, the percentage of solids may have to be adjusted, hence the process steps also change the percentage of solids. However, this does not impact upon the tailings management if the tailings go through a thickener, prior to discharge to the pond.

The column on 'ARD influence' highlights process steps that either alter the accessibility to sulphides (i.e. comminution) or change the sulphide content in the tailings (for instance, electrostatic separation can remove part of the pyrite). The ARD influence of flotation can be both positive (sulphides removed to the concentrate) and negative (other minerals removed and the sulphides remain in the tailings). Comminution mainly has the effect of making sulphide minerals more accessible and, thereby, enhances ARD generation.

It is obvious that comminution changes the surface properties. However, in fact all process steps where reagents are added influence the surface properties.

2.3.4 Techniques and processes

2.3.4.1 Alumina refining

Alumina refining is the process that uses bauxite as a raw material to produce alumina. Alumina is a white granular material and is properly called aluminium oxide. The Bayer refining process used by alumina refineries worldwide involves four steps - digestion, clarification, precipitation and calcination.

Alumina is converted into aluminium via smelting, and these techniques are described in the BREF on non-ferrous metals industries. [35, EIPPCB, 2001]

The digestion (dissolution) of aluminium 'hydrate' (e.g. $\text{Al}_2\text{O}_3 \cdot 3\text{H}_2\text{O}$) from the bauxite is carried out under pressure in high temperature (around 250°C) sodium hydroxide. The insolubles, sand and red mud, are separated by cycloning, decantation, and, after washing and filtration, are deposited in the TMF. The aluminium hydrate is precipitated as a white slurry and dried (calcined) to produce alumina (Al_2O_3), as a white crystalline product in particles of about $90\ \mu\text{m}$ size. Six to four tonnes of bauxite are needed to produce two tonnes of alumina and subsequently one tonne of aluminium [22, Aughinish,].

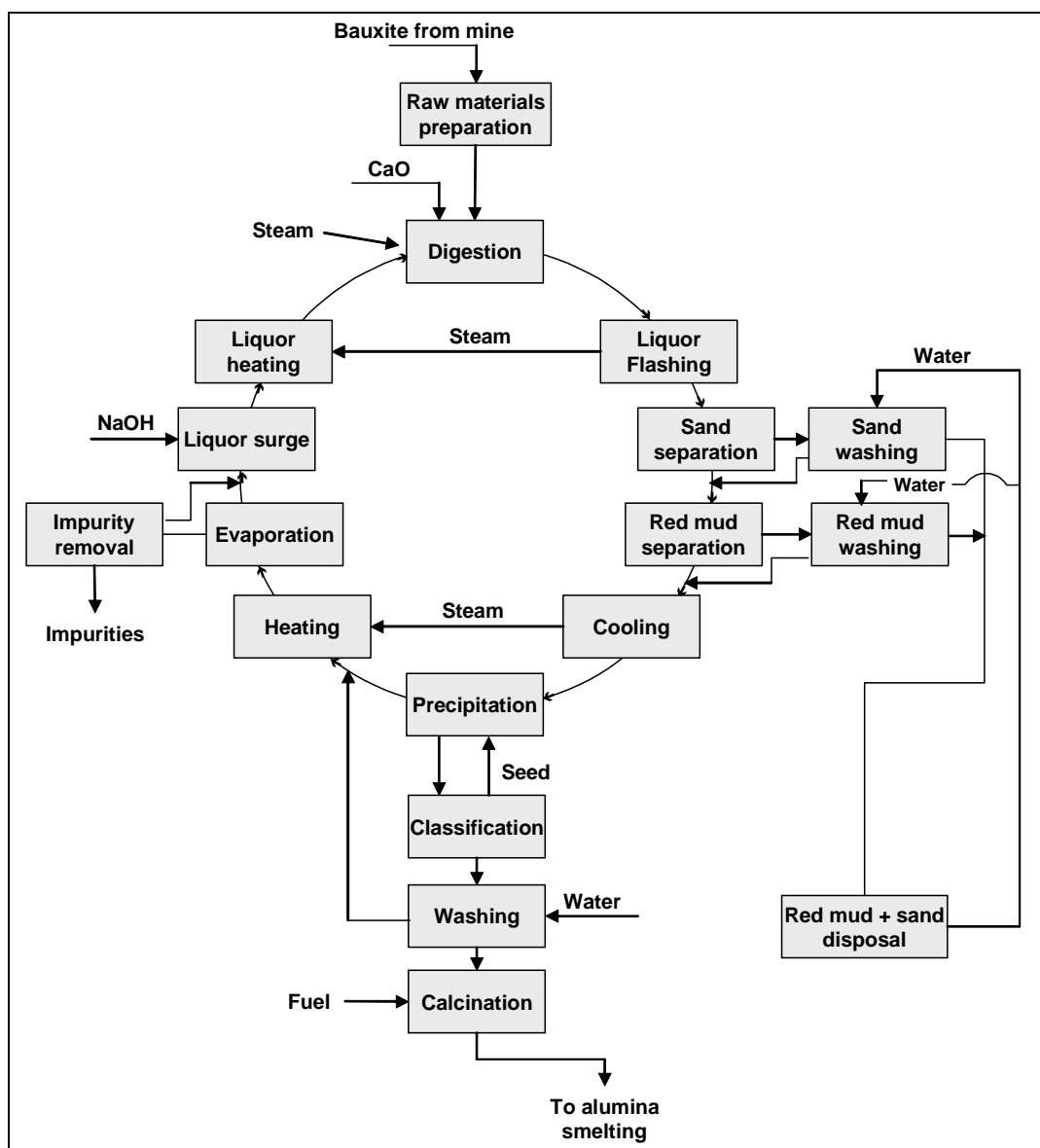

Figure 2.24: Typical flow sheet of Bayer-process

This process is normally carried out close to the mine site but there are sites in Europe where bauxite is converted to alumina at the same site as the aluminium smelter or at stand-alone alumina refineries.

More information about alumina refinery is available at:

<http://www.world-aluminium.org/production/refining/>.

2.3.4.2 Gold leaching with cyanide

Strictly speaking leaching is less a typical mineral processing technique than a hydrometallurgical process. However, for gold leaching it is applied to run-of-mine ore or is integrated into the other mineral processing steps (e.g. after comminution and gravity separation or flotation). Therefore leaching is generally considered to be part of mineral processing. Although other minerals may be leached and lixivants other than cyanide are used (e.g. salt can be leached or dissolved with water, copper may be leached with sulphuric acid), due to the high toxicity of cyanide and the public concern about its use in the mining sector, this chapter will focus on the use of cyanide in the leaching of gold. However, it should be noted that cyanide may also be used in the flotation of sulphides, as a depressant for pyrite (FeS_2).

The following text on the use of cyanide for the leaching of gold is taken from the “International cyanide management code for the manufacture, transport and use of cyanide in the production of gold” (www.cyanidecode.org), unless otherwise stated. From this website, information about cyanide chemistry and sampling and analytical methods has been downloaded and attached in Annex 1.

Use of cyanide in the gold industry

Gold typically occurs at very low concentrations in ores, i.e. less than 10 g/t or 0.001 %. At these concentrations the use of hydrometallurgical extraction processes, i.e. based on aqueous chemistry, are the only economically viable methods of extracting the gold from the ore. Typically hydrometallurgical gold recovery involves a leaching step during which the gold is dissolved in an aqueous medium, followed by separation of the gold bearing solution from the residues or adsorption of the gold onto activated carbon and finally gold recovery either by precipitation or elution and electrowinning (see the following figure).

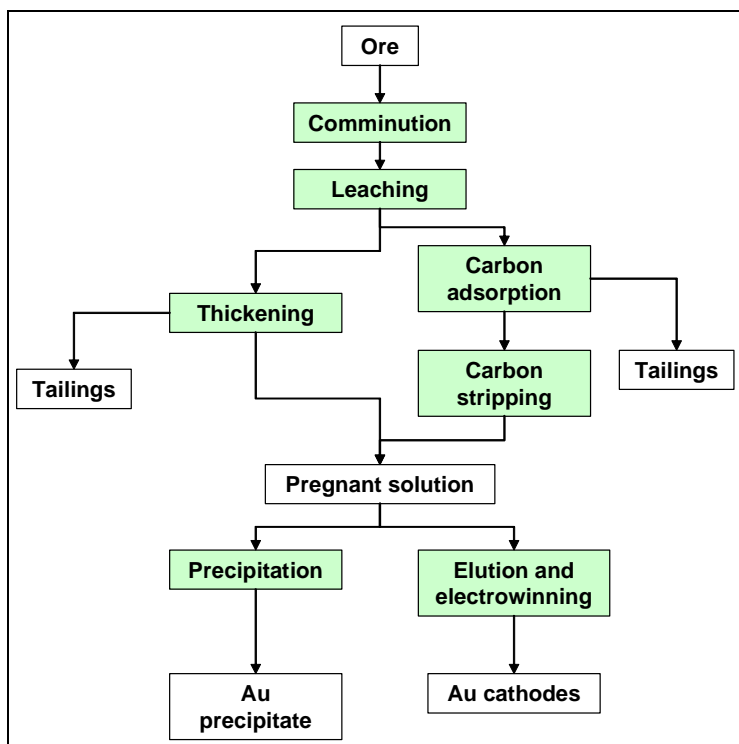

Figure 2.25: The principles of gold recovery by leaching

Often a gravity separation circuit is incorporated into this process after comminution to recover the sufficiently coarse gold particles ($>30\ \mu\text{m}$) prior to leaching. The use of gravity separation in the field of gold recovery is rapidly advancing into ever smaller particles sizes (see Chapter 6).

Gold is one of the noble metals and, as such, is not soluble in water. The presence of a complexant, such as cyanide, which stabilises the gold species in solution, and an oxidant, such as oxygen, are required to dissolve gold. The amount of cyanide in solution required for dissolution may be as low as 350 mg/l or 0.035 % (as 100 % NaCN).

Alternative complexing agents for gold, such as chloride, bromide, thiourea, and thiosulphate are available but form less stable complexes and, thus, require more aggressive conditions to dissolve the gold. These reagents are often more expensive to use and/or also present risks to health and the environment. This explains the dominance of cyanide as still the primary reagent for the leaching of gold from ores.

Ore preparation

The aim of ore preparation is to present the ore to the lixiviant (the aqueous cyanide solution) in a form that will ensure optimum economic recovery of the gold. The first step in ore preparation is crushing and grinding, which reduces the particle size of the ore and liberates the gold for recovery.

Ore that contains free gold may not yield a sufficiently high recovery by means of cyanide leaching only, and may require a gravity recovery process where the free gold is recovered before the remainder of the gold is subject to cyanide leaching.

Gold bearing ores that contain gold associated with sulphide or carbonaceous minerals require additional treatment, besides size reduction, prior to gold recovery. Gold recovery from sulphide ore is poor because the cyanide preferentially leaches the sulphide minerals rather than the gold, and cyanide is consumed by the formation of thiocyanate. These ores are subject to a concentration process, such as flotation, followed by a secondary process to oxidise the sulphides, thus limiting their interaction with the cyanide during the gold leach. Carbonaceous minerals adsorb the gold after it has been dissolved. This is prevented by oxidising the ore prior to leaching. The leaching process may also be modified to counter this effect, by the addition of activated carbon to preferentially adsorb the gold.

Leaching with aqueous cyanide solutions

Gold is leached in aqueous cyanide by oxidising it with an oxidant such as dissolved oxygen and complexing it with cyanide to form a gold-cyanide complex. This complex is very stable and the cyanide required is only slightly in excess of the stoichiometric requirement. However, in practice, the amount of cyanide used in leach solutions is dictated by the presence of other cyanide consumers and the need to increase the rate of leaching to acceptable levels.

In practice, the typical cyanide concentrations used range from 300 to 500 mg/l (0.03 to 0.05 % as NaCN), depending on the mineralogy of the ore. The gold is recovered by means of either heap leaching or agitated pulp leaching.

With heap leaching, the ore or agglomerated fine ore is stacked in heaps on a pad lined with an impermeable membrane. The term 'dump leaching' is sometimes applied to heap leaching of uncrushed ore. Cyanide solution is introduced to the heap by sprinklers or a drip irrigation system, the solution percolates through the heap, leaching the gold from the ore. The gold bearing solution is collected on the impermeable membrane and channelled to storage facilities for further processing. Heap leaching is attractive due to the low capital cost involved, but is a slow process and the gold extraction efficiency is also relatively low.

In a conventional milling and agitated leaching circuit, the ore is milled in semi-autogenous, ball or rod mills to the consistency of sand or powder. The milled ore is conveyed as a slurry to a series of leach tanks. The slurry is agitated in the leach tanks, either mechanically or by means of air injection, to increase the contact of cyanide and oxygen with the gold and to enhance the efficiency of the leach process. As mentioned earlier, the cyanide dissolves gold from the ore and forms a stable gold-cyanide complex.

The pH of the slurry is raised to pH 10 - 11 using lime, at the head of the leach circuit to ensure that when cyanide is added, hydrogen cyanide gas is not generated and the cyanide remains in solution and hence available to dissolve the gold. The slurry may also be subject to other preconditioning, such as pre-oxidation at the head of the circuit, before cyanide is added.

Where oxygen instead of air is used as the oxidant, it has the advantage of increasing the leach rate and also decreasing cyanide consumption due to the inactivation of some of the cyanide consuming species present in the slurry.

Where carbon is used to recover the dissolved gold, highly activated carbon is introduced into the process, either directly into the leach tanks (referred to as Carbon-in-Leach - CIL) or in separate tanks after leaching (referred to as Carbon-in-Pulp - CIP). The activated carbon adsorbs the dissolved gold from the solution component of the leach slurry, thereby concentrating it onto a smaller mass of solids. The carbon is then separated from the slurry by screening and subjected to further treatment to recover the adsorbed gold, as described below.

Where carbon is not used to adsorb the dissolved gold in the leach slurry, the gold bearing solution must be separated from the solids component of the slurry, utilising filtration or thickening units. The resultant solution, referred to as pregnant solution, is subjected to further treatment (other than by carbon absorption) to recover the dissolved gold, as discussed under gold recovery.

The material from which the gold has been removed by adsorption or liquids/solids separation is referred to as tailings. The tailings are either dewatered to recover the water and residual cyanide reagent, treated to either neutralise or recover cyanide, or sent directly to the TMF (see Section 3.1.6.3).

Recovery of dissolved gold

The gold is recovered from the solution by using cementation on zinc powder (the so-called Merrill-Crowe process) or by first concentrating the gold using adsorption on activated carbon, followed by elution and either cementation with zinc or electrowinning. For efficient cementation, a clear solution is required, which is typically prepared by filtration or counter current decantation. These are capital-intensive processes and have been superseded by processes using adsorption of the dissolved gold onto activated carbon. Adsorption is achieved by contacting the activated carbon with the agitated pulp. This can be done while the gold is still being leached with the Carbon-in-Leach or CIL-process, or following leaching with the Carbon-in-Pulp or CIP-process. Activated carbon in contact with a gold containing pulp can typically recover more than 99.5 % of the gold in the solution in 8 to 24 hours. The loaded carbon is then separated from the pulp using screens that are air or hydro-dynamically swept to prevent blinding by the near-sized carbon particles. This separation of ore particles (typically <100 µm) from the coarser carbon particles (>500 µm) is a lot less capital intensive than the filtration needed when using the Merrill-Crowe technique).

The fine barren ore, i.e. the tailings, is then either thickened to separate the cyanide containing solution for recovery or destruction of the cyanide, or sent directly to the TMF, where the cyanide containing solution is often recycled to the leach plant.

The gold adsorbed on the activated carbon is recovered from the carbon by elution, typically with a hot caustic aqueous cyanide solution. The carbon is then regenerated and returned to the adsorption circuit while the gold is recovered from the eluate using either zinc cementation or electrowinning. This gold concentrate is then calcined, if it contains significant amounts of base metals, or directly smelted and refined to gold bullion that typically contains about 70 – 90 % gold. The bullion is then further refined to either 99.99 % or 99.999 % fineness, using chlorination, smelting and electrorefining. Recently developed processes utilise solvent extraction to produce high purity gold directly from activated carbon eluates, or following intensive leaching of gravity concentrates.

Process operation and the environment

The following are sources of cyanide emissions to the environment:

- CN to air as HCN
- seepage from tailings ponds
- tailings pond discharges required to manage overall water balance.

It is part of normal operation to attempt to optimise process economics. This coincides with the objective of minimising cyanide impact on the environment and cyanide consumption. Process economics are sensitive to the amount of cyanide consumed in the process. Increased cyanide addition may have a ‘double-barrelled’ effect, meaning the operating costs increase through the extra amounts of cyanide that have to be purchased as well as because of the higher amounts of cyanides that will have to be destroyed or recycled prior to effluent discharge. Cyanide classified as ‘consumed’ from a process point of view may still be active from an environmental perspective, for instance as may be the case with copper cyanide complexes [24, British Columbia CN guide, 1992].

2.4 Tailings and waste-rock management

There are many options for managing tailings and waste-rock. The most common methods are:

- dry-stacking of thickened tailings
- dumping of more or less dry tailings or waste-rock onto heaps or hillsides
- backfilling of tailings or waste-rock into underground mines or open pits or for the construction of tailings dams
- discarding of tailings into surface water (e.g. sea, lake, river) or groundwater
- use as a product for land use, e.g. as aggregates, or for restoration
- discarding of slurried tailings into ponds.

Waste-rock is either managed on heaps or is sometimes dumped on existing hillsides.

The ways in which these different techniques are applied will be discussed in this section.

2.4.1 Characteristics of materials in tailings and waste-rock management facilities

This section has been taken from the UK “Spoil heaps and lagoons” technical handbook [130, N.C.B., 1970].

2.4.1.1 Shear strength

The shear strength is the most important characteristic of any tailings or waste-rock in the design of a heap or dam. Normally the appropriate shear strength parameters necessary to carry out a stability analysis are those related to the effective stress, i.e. the effective cohesion and the effective angle of shearing resistance. Comparatively small variations in the shear strength parameters used may have a significant impact on the safety factor. Therefore, strength tests are carried out on a reasonable number of samples.

2.4.1.2 Other characteristics

Other important characteristics relevant for the stability of a facility are:

- particle size distribution: as this influences shear strength
- density
- plasticity
- moisture content
- permeability. According to their hydraulic conductivity or coefficient of permeability k (in m/s), tailings and waste-rock can be classified in five groups according to DIN 18130 part 1:
 - very high permeability: $>1 \times 10^{-2}$
 - high permeability: $1 \times 10^{-4} - 1 \times 10^{-2}$
 - permeable: $1 \times 10^{-6} - 1 \times 10^{-4}$
 - low permeability: $1 \times 10^{-8} - 1 \times 10^{-6}$
 - very low permeability: $<1 \times 10^{-8}$
- consolidation: the amount and rate of settlement of tailings or waste-rock under load are related to the consolidation characteristic of the soil
- porosity.

2.4.2 Tailings dams

Tailings dams are surface structures in which slurried tailings are managed. This type of TMF is typically used for tailings from wet processing. Ponds consist of 20 – 40 % solids by weight, but levels from 5 – 50 % solids have been known.

The following figure shows a cross-sectional view of a tailings dam and illustrates the water cycle of this type of TMF.

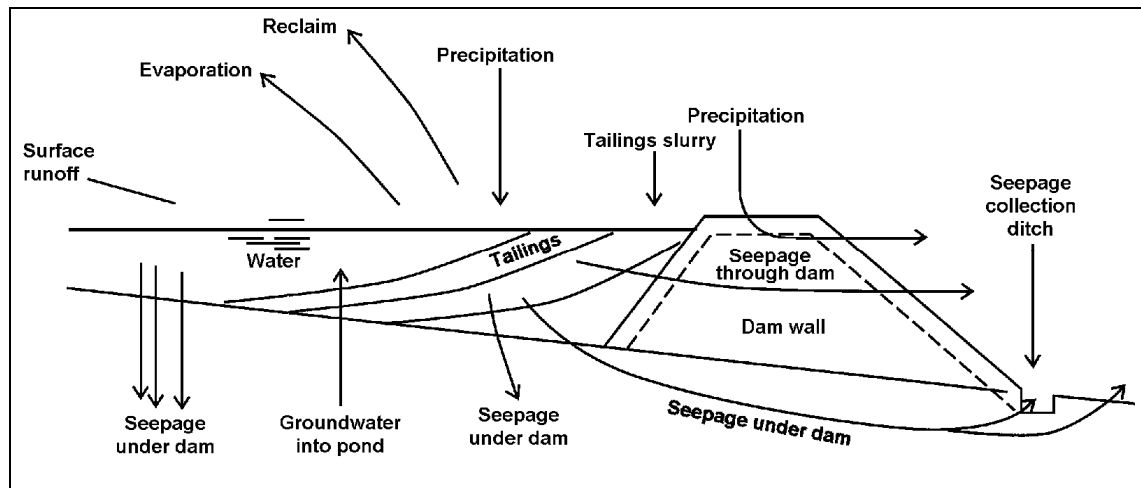

Figure 2.26: Dam water cycle changed from
Changed from [11, EPA, 1995]

The following section on tailings dams is mostly gathered from ICOLD Bulletin 106 [8, ICOLD, 1996]. Other references are mentioned where appropriate.

The vast majority of tailings are managed on land. This entails the selection of a tract of land on which the tailings are stored for an extended period while the tailings are being generated by the mineral processing plant and, unless reclaimed for further treatment, for an indefinite period thereafter. The deposit must be secure against physical damage from outflow and must not pollute the surrounding area, neighbouring water courses, the groundwater, or the atmosphere. Since the tailings are conveyed as slurry from the plant and may remain as a suspension, or since, thus, may be capable of reverting to a fluid, the deposited mass requires confinement to the extent necessary to prevent the flow of the material out of the designated area. In most tailings ponds, the solids settle out of the slurry after discharge and the pond is, therefore, composed of settled solids and free water. This may be supplemented by natural run-off, in-flowing groundwater or direct precipitation. The free fluid may be returned to the processing plant for re-use, stored in the impoundment for future use, or removal by evaporation or it may be discharged into surface water courses, often after undergoing treatment.

The basic arrangements of tailings dams may be classified as:

- existing pit
- valley site
- off valley site
- on flat land.

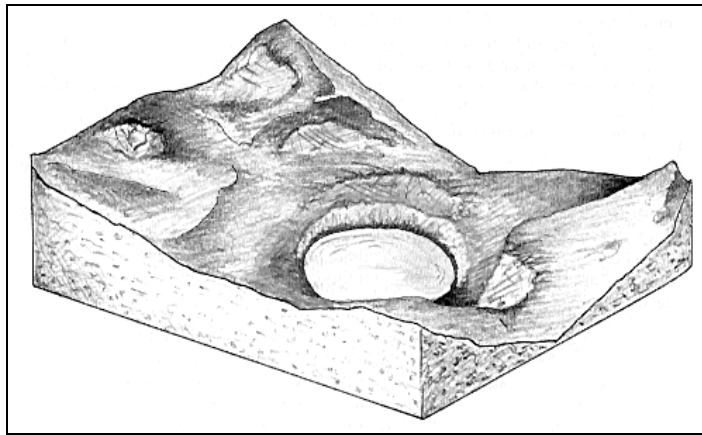

Figure 2.27: Illustration of a tailings pond in an existing pit [8, ICOLD, 1996]

The following gives an actual example of this type of TMF.

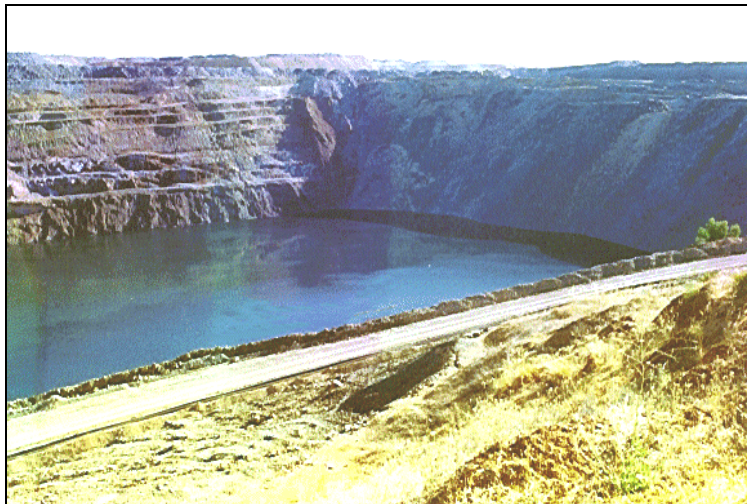

Figure 2.28: Picture of a tailings pond in an existing pit

The following two figures illustrate a valley site and an off-valley site tailings pond.

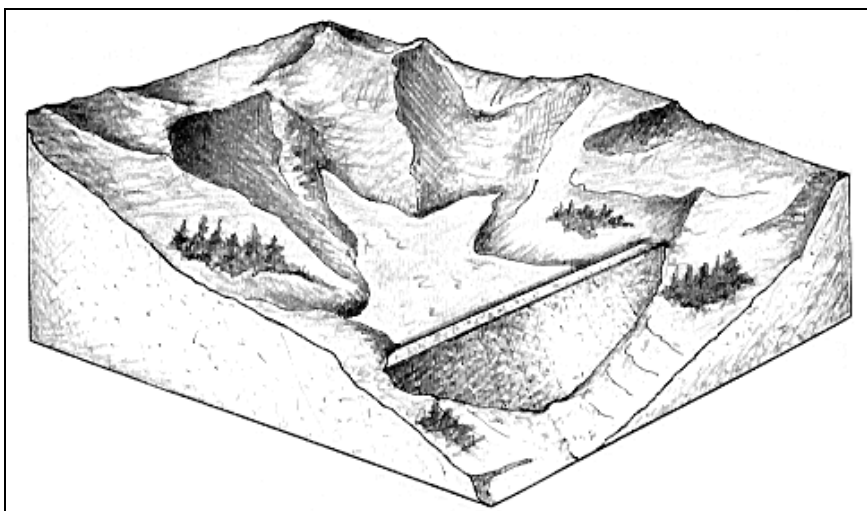

Figure 2.29: Illustration of tailings pond on a valley site [8, ICOLD, 1996]

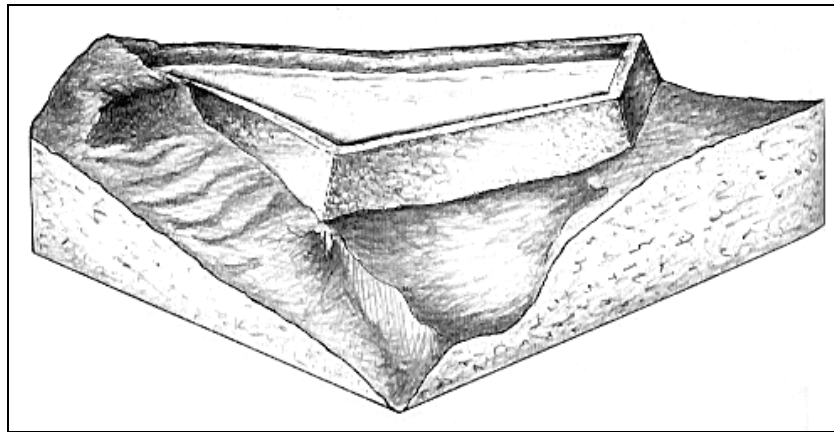

Figure 2.30: Illustration of an off-valley site tailings pond
[8, ICOLD, 1996]

If a tailings pond is built on flat land it is often referred to as a paddock. The following picture gives an impression of paddocks used in South African gold mining operations.



Figure 2.31: Tailings pond on flat land (Courtesy of AngloGold, South African Division)

For each tailings impoundment, several activities need to be considered, including:

- tailings delivery from the mineral processing plant to the tailings dam
- dams to confine the tailings
- diversion systems for natural run-off around or through the dam
- deposition of the tailings within the dam
- evacuation of excess free water
- protection of the surrounding area from environmental impacts
- instrumentation and monitoring systems to enable surveillance of the dam
- long-term aspects (i.e. closure and after-care).

Some of these activities will be discussed in the following sections. Also some aspects of seepage flow and design flood considerations will be introduced. These two aspects have an impact on several of the activities listed above.

2.4.2.1 Delivery systems for slurried tailings

Slurry transport from the plant to the TMF is usually undertaken by pipeline. In some cases, open channel conveyance may be used, as it is cheaper. The pipeline is seldom buried. Occasionally, the slurried tailings are transported from the mineral processing site to the TMF by trucks.

2.4.2.2 Confining dams

The construction material and methods used in forming the dam vary widely to accommodate the particular needs of the selected site, the availability of materials and the financial and operating policies of the entire operation.

Typically, dams are subdivided into three parts:

1. an upstream section which is capable of retaining the tailings without excessive penetration/erosion by the tailings themselves (e.g. compacted sand)
2. a middle section, or core, which provides a passage for seepage water through the structure in a controlled manner and which will not break down or become blocked by fine material (e.g. rock or crushed filter stone) and
3. a downstream section which provides toe strength and stability and which will remain 'dry' under all circumstances (e.g. sand compacted to a high density). In some circumstances, it may be necessary to incorporate artificial membranes (filter cloths) between the main sections of the structure where there is a risk of high seepage and the movement of fine material.

The dam types may be classified as follows:

- non-permeable (water-retention type) dams
 - conventional dam
 - staged conventional dam
 - staged dam with upstream low permeability zone.
- permeable dams
 - dam with tailings low permeability core
 - dams with tailings in structural zone
 - upstream construction using beach or paddock.

These types will be briefly discussed below.

Note that the term **beach** used in conjunction with the management of slurried tailings in a pond means the area of tailings resulting from the settled solid fraction of a tailings slurry in a pond not covered by free water between the edge of free water and the crest of the dam.

The purpose of a beach is to establish an area of ‘dry’ tailings against the upstream face of retaining dams for two important considerations:

1. to prevent water from reaching the crest of the dam where it could cause erosion of the inside face, or more seriously, lead to excessive leakage through the dam with the subsequent risk of ‘piping’ and possible damage/collapse of the structure
2. to allow ‘natural’ separation of the coarser and finer particles of the tailings. Where tailings are discharged into a dam by suspension in water (and most are) the larger sized particles tend to settle out more quickly. As these ‘dry’ out and consolidate, densities will generally increase over time, thereby adding to the overall stability of the structure as a whole.

The following picture shows an example of a beach at an alumina refinery’s red mud pond. The dam’s upstream face and crest can be seen on the left hand side and the free water on the right hand side. The red section in the middle is considered the ‘beach’.

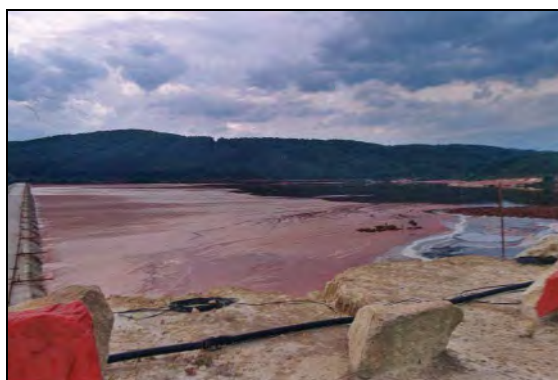

Figure 2.32: Example of a beach at an alumina refinery’s red mud pond

Conventional dam

This type of dam is completely built before tailings are discharged at the site. Hence, tailings cannot be used to build the dam. Conventional dams are constructed where the confinement is to be effected for both tailings and free water during the whole period, from the start of tailings management to the end of the particular site selected.

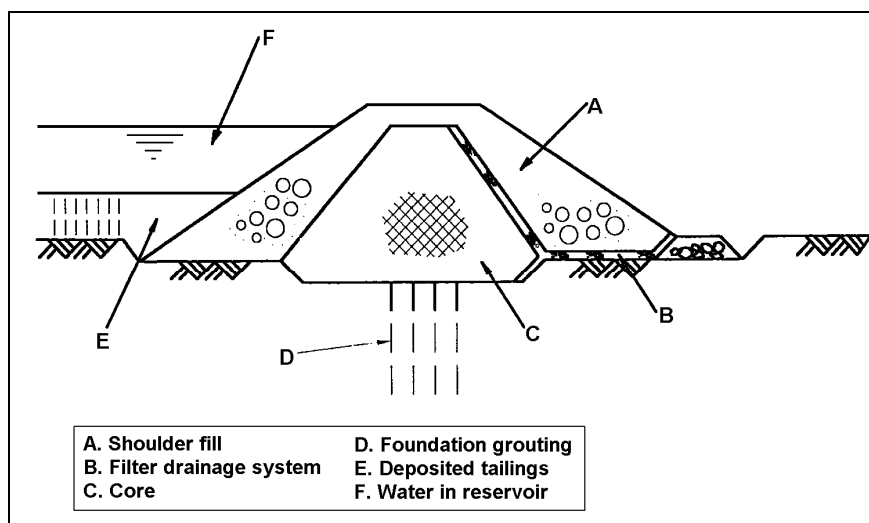

Figure 2.33: Conventional dam
[8, ICOLD, 1996]

The purpose of the shoulder fill is to increase the overall dam strength, but also to protect the core from erosion (wind and water) and from wave action from the free water.

A conventional central core section is illustrated in the above figure but the range of options is varied and similar to that for dams designed to confine water alone. In general though, the dam must be capable of:

- controlling the passage of water
- supporting the loads imposed by the tailings and water in the impoundment
- transmitting the seepage water effectively and without the passage of solids (filtration system).

Staged conventional dam

This is similar to a conventional dam but has a lower initial capital cost by staging the construction so that the costs are spread more evenly over the period of deposition.

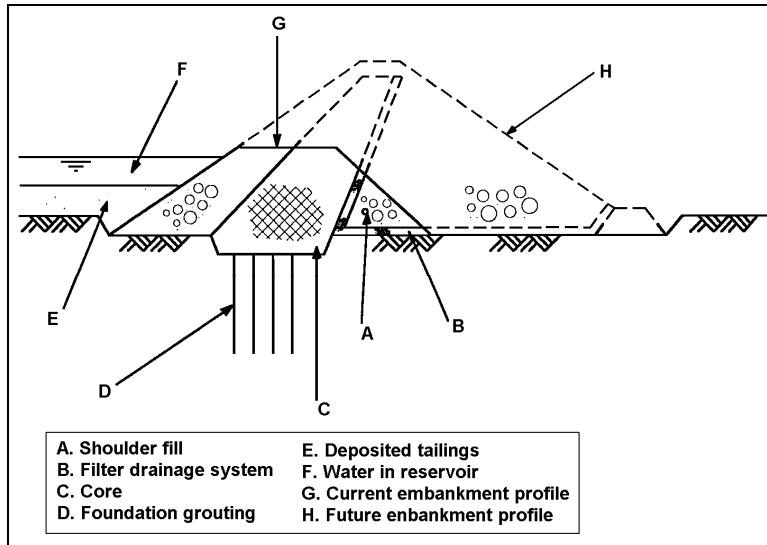

Figure 2.34: Staged conventional dam [8, ICOLD, 1996]

Staged dam with upstream core

If the deposited tailings lie close to, or above, the level of the free water in the impoundment, the low permeability core zone of the dam may be located on its upstream face. This is possible because the core is protected against erosion and wave action by the tailings.

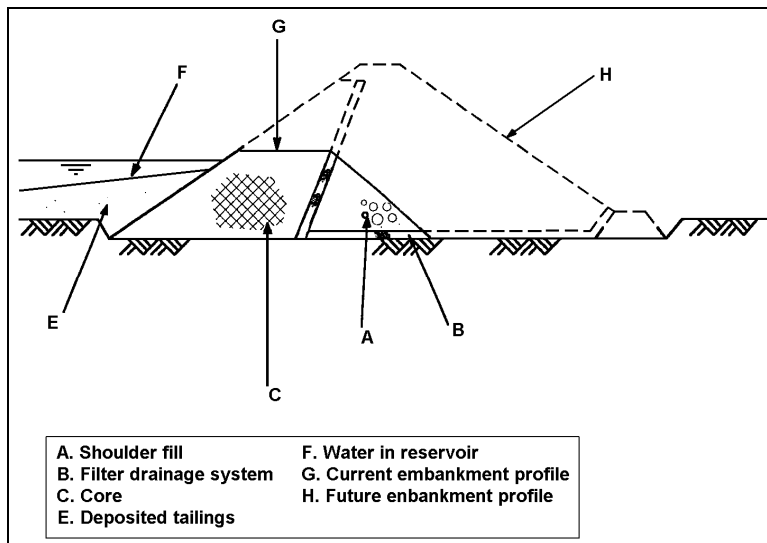

Figure 2.35: Staged dam with upstream low permeability zone [8, ICOLD, 1996]

Dam with tailings low permeability core zone

Where all or part of the tailings deposition into the pond occurs from the dam a beach of tailings may be formed. It is then possible for the tailings beach alone to provide the less permeable zone of the system.

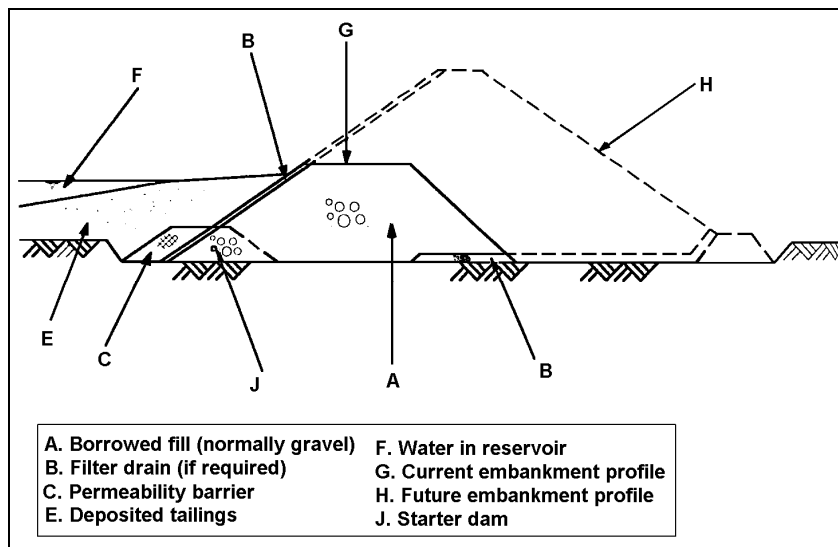

Figure 2.36: Dam with tailings low permeability core zone
[8, ICOLD, 1996]

This arrangement is only possible where the inflow of water will not allow the impoundment water level to rise above the uppermost level of the beach and, therefore, against the more pervious dam material. Therefore, continuous monitoring is required for this kind of arrangement.

For this arrangement, it is necessary to build a low impermeability barrier (C) into the starter dam, until the beach has developed far enough away from the dam itself.

Dam with tailings in structural zone

In this arrangement, tailings are not only used as a water barrier but also as construction material of the dam. In this case, typically the coarser hydrocyclone underflow is for the structural zone and the finer hydrocyclone is discharged into the pond forming the beach.

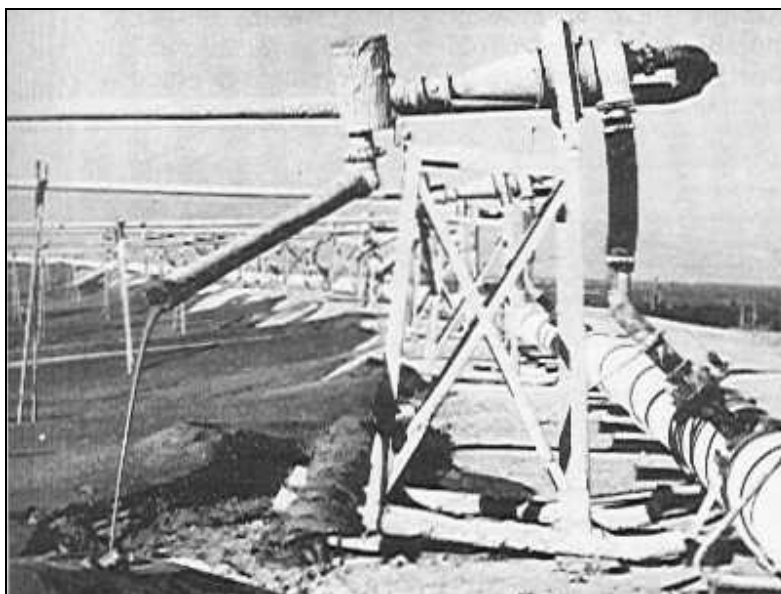

Figure 2.37: Row of hydrocyclones on the crest of a dam

For further information on hydrocyclones please refer to Section 2.3.1.3.2.

There are three main approaches when considering the progressive construction of this type of dam. These are:

- upstream method
- downstream method
- centreline method.

These methods allow for staged construction of the dam, which minimises start-up capital costs. The following figure illustrates these methods.

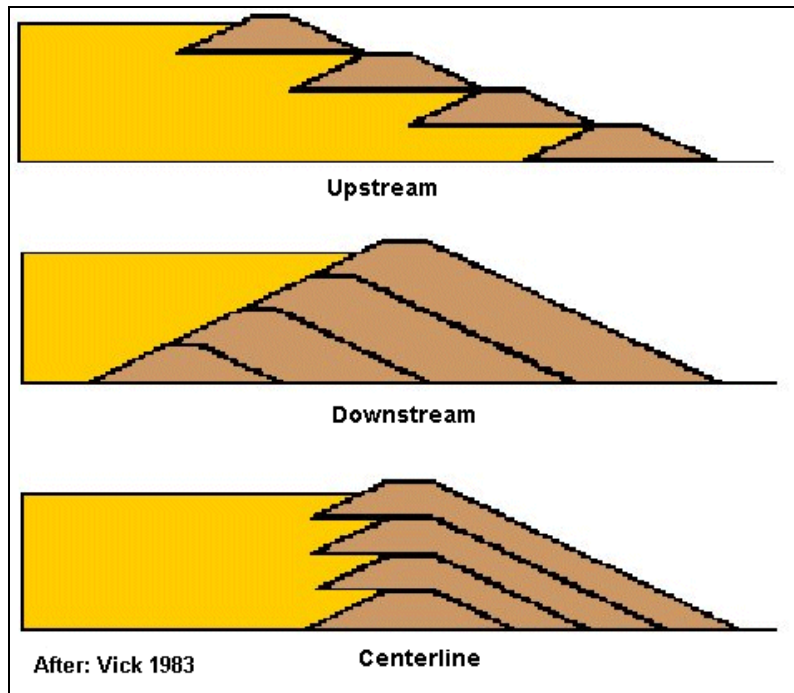

Figure 2.38: Types of sequentially raised dams with tailings in the structural zone [11, EPA, 1995]

Upstream method using cycloned tailings

This method is very economical in the use of the coarser fraction of the tailings since only a thin outer zone of this material will result.

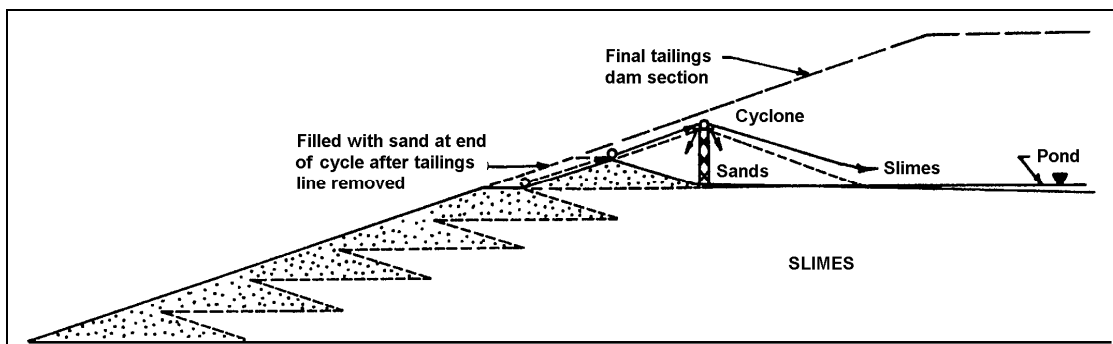

Figure 2.39: Upstream method using cycloned tailings [11, EPA, 1995]

The following picture shows a dam built using the upstream method. The dam itself consists of borrowed rock-fill, different from the example above where cyclones tailings are used.



Figure 2.40: Dams raised using the upstream method at the Aughinish site

The main disadvantage of this method has, in the past, been the physical stability on the dam and its susceptibility to liquefaction. Care must be taken in order to control the phreatic surface, which can be achieved by correct drainage. Also, the exposed tailings, used to build the dam should not have ARD potential.

Downstream method

The coarse fraction of the tailings, separated by the hydrocyclone, may be used to form the complete structural portion of the dam or a large part of it. The size of hydrocyclone is selected such that a bank of them acting in parallel can deal with the tailings throughput. With the tailings delivery line and the bank of hydrocyclone offtakes located initially on the crest of the starter dam, the underflow is discharged downstream to form the dam, and the overflow is discharged into the impoundment, as illustrated in the following figure.

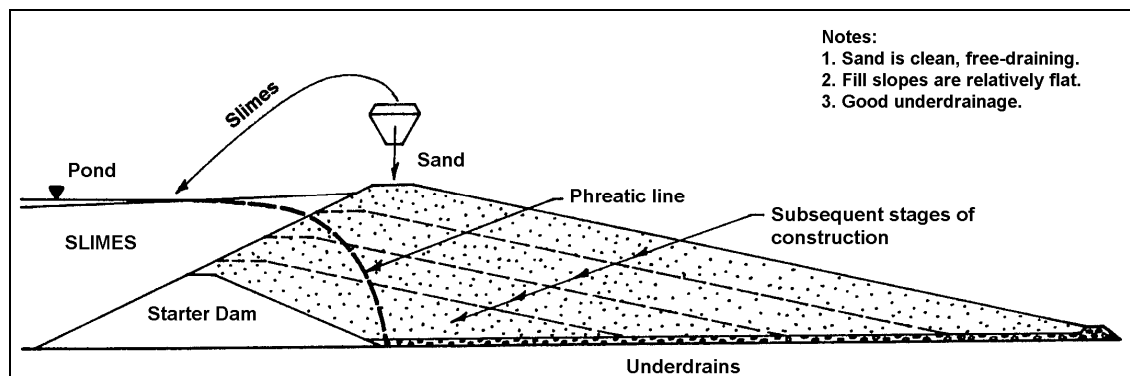

Figure 2.41: Downstream construction of a dam using hydrocyclones
[11, EPA, 1995]

This method is called the downstream method because as the dam height rises, the crest moves downstream.

Centreline method

The downstream method of construction entails the use of a considerable volume of coarse tailings for the dam, and an area of land under the footprint of the dam. Where the proportion of the coarse tailings separated out by cycloning is insufficient to permit the dam to keep ahead of the rise of the impoundment level, the tailings zone may need to be supplemented by a zone of borrowed material. As an alternative to this option, the upstream portion of the dam may be composed of the beach of deposited tailings. This is possible because the upstream face of the dam is progressively supported by the rise of tailings. The resultant structure is illustrated in the following figure and the method is generally termed the centreline method.

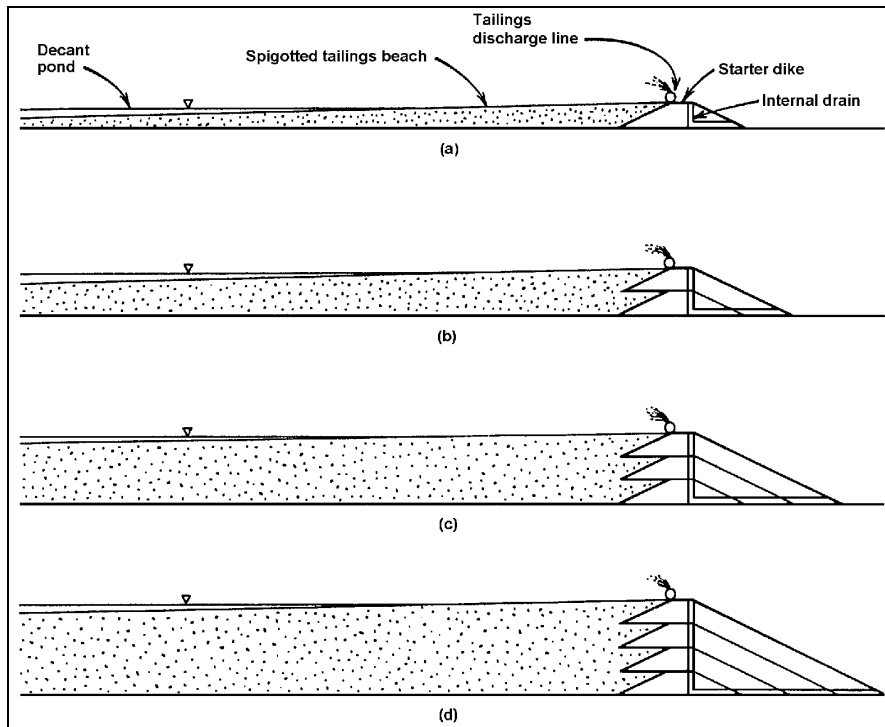

Figure 2.42: Centreline method
[11, EPA, 1995]

Upstream construction using beach or paddock

This traditional tailings dam construction method uses the beach instead of a hydrocyclone to size-sort the tailings. This method makes maximum use of the actual tailings itself for confinement, and may provide the cheapest system of tailings management. The system relies on the formation of a satisfactory beach by control of the deployment of the discharge arrangements and by control of the length of time material is discharged from each point.

2.4.2.3 Deposition in the impoundment

Hydraulic deposition

The tailings are pumped into the tailings pond with 5 to 50 % solids. In some applications, particularly where conventional dams are employed, the discharge of tailings into the impoundment can take the form of a **single-pointed open-ended discharge**. In other cases a more controlled deposition method may be desirable. This may incorporate **line or perimeter discharges** or the use of **hydrocyclones** [21, Ritcey, 1989]. For progressively built tailings dams, the discharge arrangements are dictated by the dam construction method selected.

The increase of density of deposited material is accelerated by the action of drainage and evaporation. Therefore storage efficiency can be increased by **deposition taking place on a beach**.

Thickened deposition

Thickened tailings have a solids content of over 50 %. This enables the storage efficiency, in terms of the storage volume to dam height, to be substantially increased, since the angle of deposition increases with the solids content of the tailings. Equipment used to thicken tailings are thickeners and/or filters.

Special techniques

For very fine tailings, **special techniques** may be employed, such as the addition of coarser particles or flocculants.

In some cases, it is necessary for all the tailings to be deposited under water (e.g. tailings with ARD potential or severe dust problems). This is referred to as **sub-aqueous** deposition.

2.4.2.4 Removal of free water

The aim throughout the development of the impoundment is usually to keep the pool of free water as low and as small as possible as a means of risk management. However, this needs to be balanced against several other objectives, e.g. tailings need a certain amount of time to settle within the pond. Also, in some cases the water has to remain in the dam for a certain period of time in order to allow deterioration of the process chemicals. Water saturation of the tailings may also be required to avoid dusting.

A good balance between the need to keep the pool low, and the contradicting requirements to leave a certain amount of water in the pond, may be utilisation of a clarification pond. This allows the settling of the fines slimes and deterioration of process chemicals, whilst the water level in the actual dam, containing the settled tailings, can be kept to a minimum.

The main requirement for successful removal of the water is the provision of an outlet arrangement, the effective level of which can be adjusted throughout the progressively increasing impoundment level, or of a pump, which can perform a similar function. The removed water is either returned to the mineral processing plant and/or, usually after treatment, discharged into natural water courses.

The outlet structure, or 'decanting system' as it is normally termed, is usually composed of two elements:

- an extendible intake, and
- a conduit to convey the discharge away from the dam.

The intake may take the form of a vertical tower, or a sloping chute founded usually in natural ground on a flank of the impoundment and occasionally on the upstream face of the dam.

The following figures show the three basic alternatives:

- decant tower
- decant chute
- pumped decant.

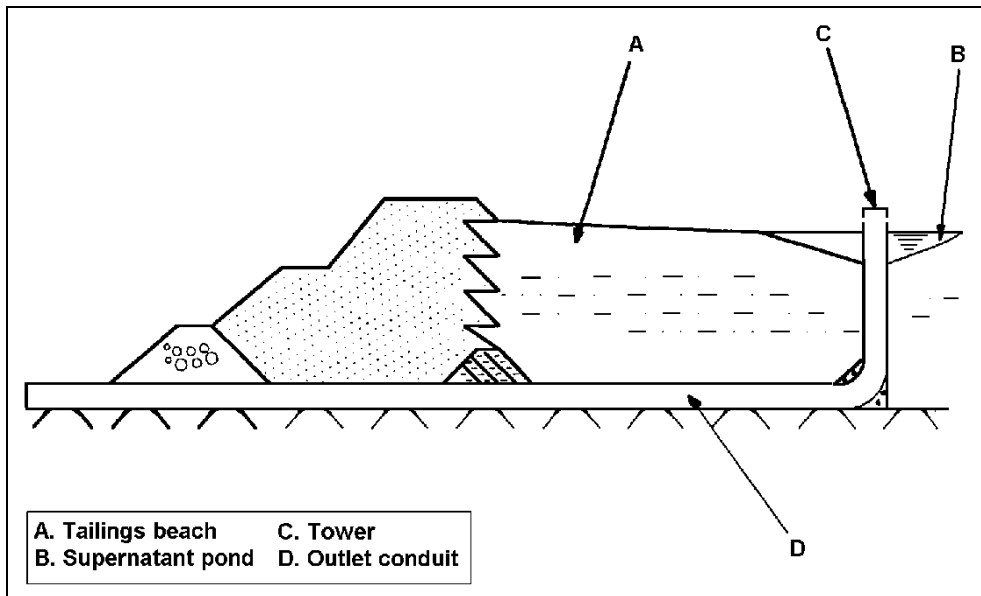

Figure 2.43: Tower decanting system
[8, ICOLD, 1996]

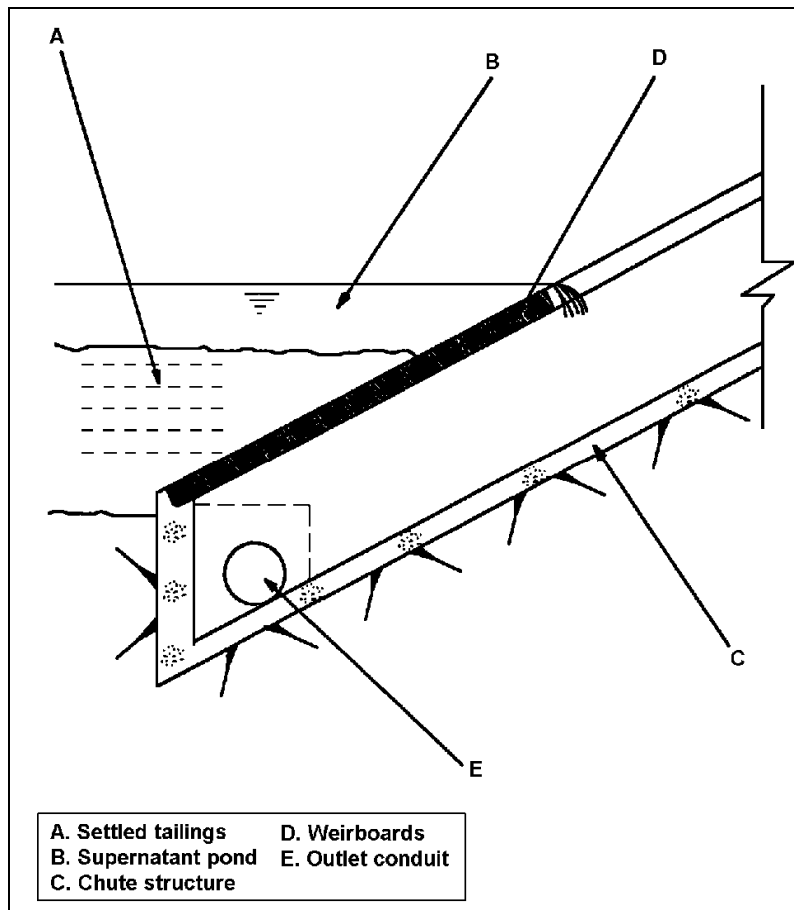

Figure 2.44: Chute decanting system
[8, ICOLD, 1996]

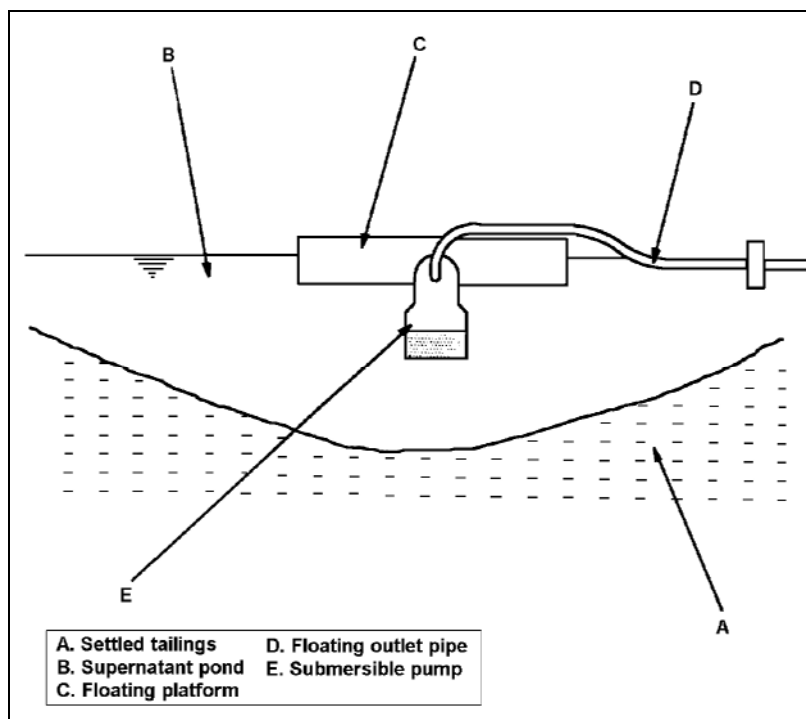

Figure 2.45: Pump barge
 [8, ICOLD, 1996]

Other options are:

- drained pond or
- overflow systems:
 - within the dam
 - around the dam.

In addition to the regular means of removing the free water, sometimes emergency overflows are installed. The idea is that in case the regular system fails, the emergency overflow will protect the dam from collapsing entirely. These outlets are typically overflow systems within or around the dam.

Emergency overflows are further discussed in Chapter 4.

2.4.2.5 Seepage flow

A tailings dam will influence the original groundwater flow pattern by introducing a hydraulic gradient (difference in hydraulic head between two points divided by the travel distance between the points). The following figures show schematic seepage flow patterns for original groundwater flow conditions and for the following basic dam types:

- existing pit
- valley site
- off-valley site
- on flat land.

Introduced in Section 2.4.2.

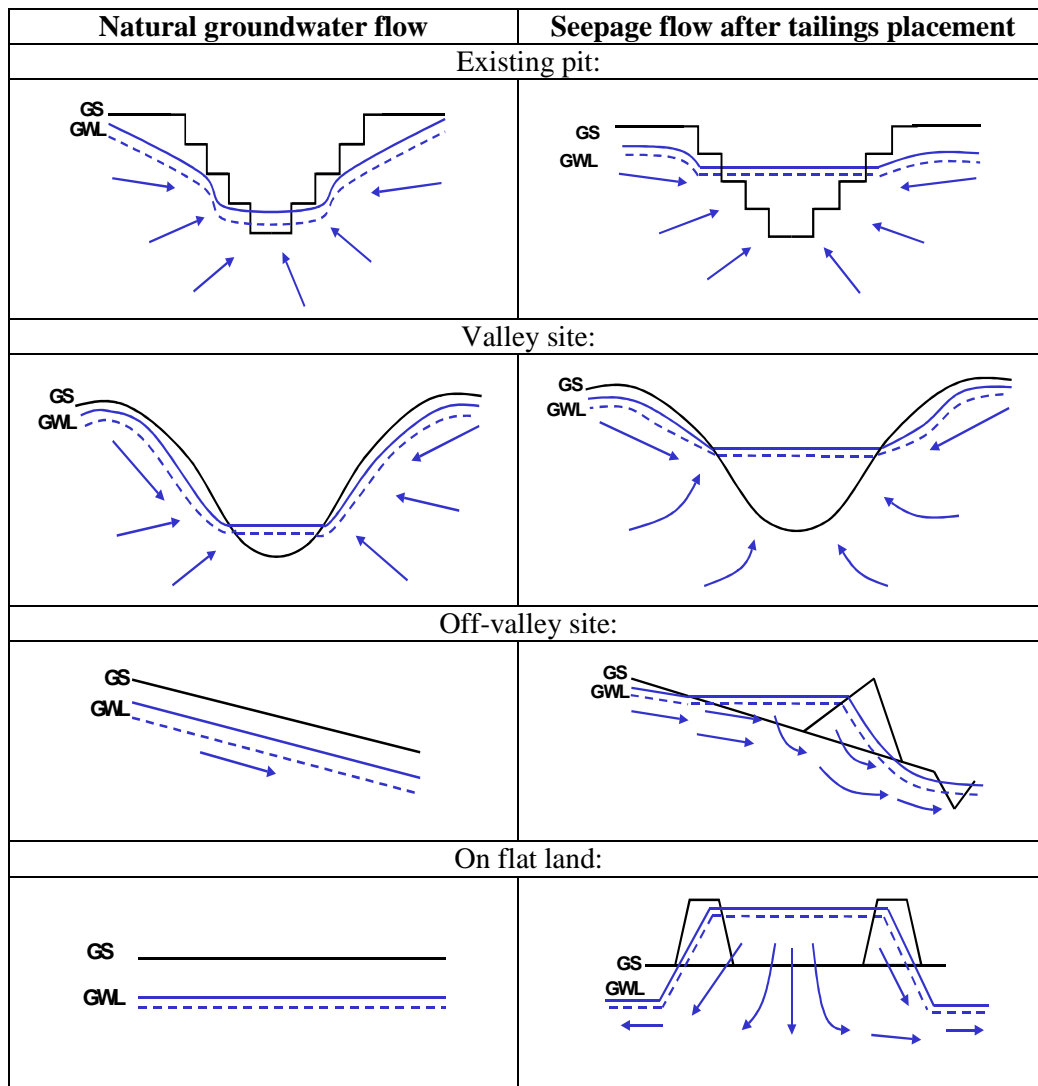

Figure 2.46: Simplified seepage flow scenarios for different types of tailings ponds

It should be noted that these are simplified schematic two-dimensional drawings. In the real world the actual flow pattern will be influenced by factors such as:

- dam properties
- water level in the dam
- permeability of the underlying formations
- ground layering
- original groundwater flow regime.

In Section 4.3.10 management and control of seepage for the various situations is discussed.

2.4.2.6 Design flood

During operation the discharge capacity should be able to handle foreseeable extreme flood events. This is based on the Probable Maximum Flood (PMF), usually defined as the 10000 year flood or two or three times the 200 year flood. The PMF is normally based on a series of local assumptions (e.g. snow smelt period, persistent rain during a number of days, plus the occurrence of an extreme precipitation event) which allow development of a hydrograph. The hydrograph is a curve of the flow (necessary discharge capacity) as a function of time at a certain point of the studied system. As a rule of the thumb one can say that the designed discharge capacity is approximately 2.5 times the highest measured flow at any point.

The Finnish “Dam Safety Code of Practice” (<http://www.vyh.fi/eng/orginfo/publica/electro/damsafet/damsafe.htm>) at Appendix 12 of this code provides information on how to determine the design flood as well as design outflow.

2.4.3 Thickened tailings

Applying thickened tailings management requires the use of mechanical equipment to dewater tailings to about 50 – 70 % solids. The tailings are then spread in layers over the storage area, to allow further dewatering through a combination of drainage and evaporation [11, EPA, 1995].

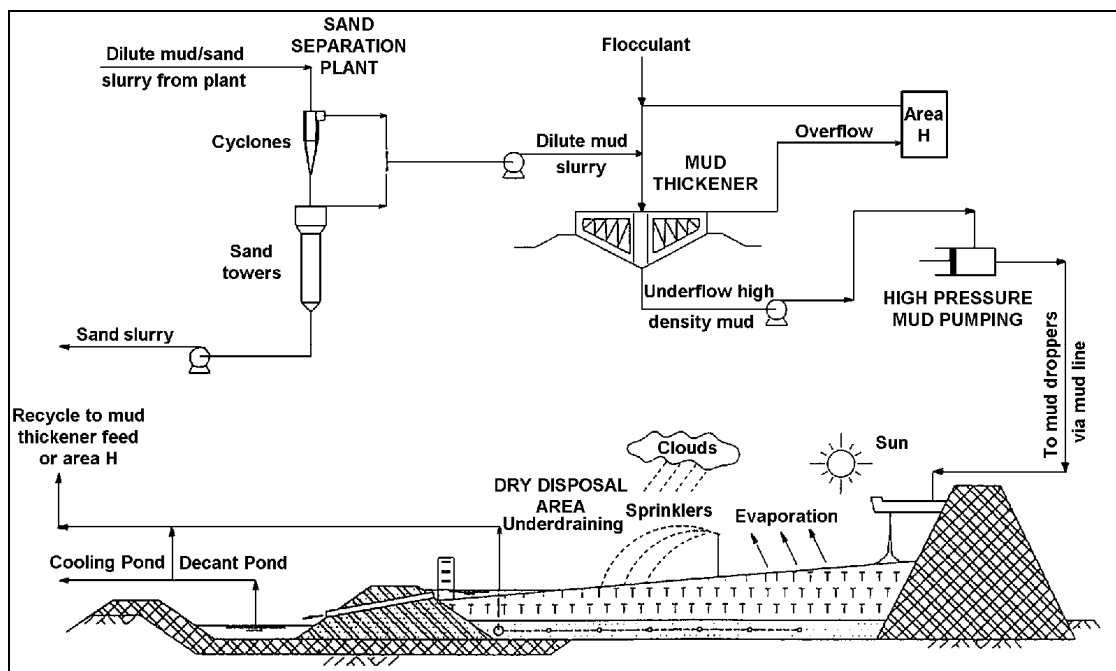

Figure 2.47: Schematic drawing of thickened tailings management operation [11, EPA, 1995]

2.4.4 Tailings and waste-rock heaps

The tailings from potash mining and the coarse tailings from iron and coal mining are often managed on heaps. Large amounts of waste-rock are managed in most metal mines using the open pit mining method.

Delivery is carried out by a conveyor belt or trucks. The heaps are surveyed to monitor for stability of the structure. Surface run-off is collected and treated, if necessary, prior to discharge or it may be diverted into the tailings ponds or separate retention basins. Geotechnically, the coarse tailings and waste-rock are usually stable. The coarseness of the material, the actual action of the truck dumping in itself, the spreading and compacting in thin layers using a tracked

machine and sometimes a vibrating roller, all help to stabilise the material during and after deposition. Apart from the heap stability itself, the stability of the supporting strata also has to be considered in the design and operation of heaps.

Dust emissions from heaps can be quite significant. With dumping from conveyor belts, the operation may have to be interrupted in windy conditions. If the tailings or waste-rock are transported by trucks the transport paths may have to be sprayed in dry periods. Progressive reclamation, if possible, helps prevent erosion and dusting.

2.4.5 Backfilling

Backfilling is the reinsertion of materials into the mined-out part(s) of the extraction site. These materials are typically overburden, waste-rock and tailings, either alone or in combination with other structural products (e.g. cement).

If other material, which does not come from the mine operation, such as smelter slags, is inserted into mine voids, this is considered infilling. In some cases, the material being infilled does not serve a geotechnical requirement but is infilled for disposal purposes.

In some cases, mined rocks of a marginal or uneconomic grade may be 'backfilled into' or temporarily stored in disused workings. Sometimes this process is referred to as 'stowing'.

Slurried and dry tailings are sometimes used in underground mines or abandoned pits or in portions of active pits as backfill. In most cases, backfill is used to refill mined-out areas in order to:

- for underground mining:
 - assure ground stability
 - reduce underground and surface subsidence
 - provide roof support so that further parts of the orebody can be extracted and to increase safety
 - provide an alternative to surface disposal
 - improve ventilation.
- for open pit mining:
 - decommissioning/landscaping reasons
 - safety reasons
 - minimise the foot print (e.g. as opposed to building ponds or heaps)
 - minimise risk of collapses by backfilling the pit instead of building a new pond or heap.

Besides the benefits for the mining operation itself (see list above), backfilling also decreases the above ground surface disturbance. Due to the increase in volume from size reduction separations a maximum of about 50 % of the tonnage extracted can be backfilled. This means that in cases where the ore grade is less than 50 % it will not be possible to backfill all the tailings. Hence, a surface TMF, as well as backfilling, may be necessary in these cases.

There are 4 types of mine backfill:

1. dry backfill
2. cemented backfill
3. hydraulic backfill
4. paste backfill.

[94, Life, 2002]

Dry backfill

Dry backfill generally consists of unclassified sand, waste-rock, tailings, and smelter slag. The backfill is transported underground by dropping it down a small shaft (or raise) from the surface directly into a stope or to a level where it can be hauled to a stope with loaders or trucks. Despite its name, the dry backfill usually contains some adsorbed surface moisture.

This type of backfill is suitable for mechanised ‘cut and fill’ or other methods where structural backfill is not required.

[94, Life, 2002]

Cemented backfill

Cemented backfill generally consist of waste-rock or coarse tailings mixed with a cement or fly ash slurry to improve the bond strength between the rock fragments. The methods of placement all involve mixing the rock and cement slurry in a hopper before placing it in voids (e.g. stopes or mined out longwall), or percolating a slurry over the rock after it has been placed. The waste-rock or tailings can be classified or unclassified. Cemented backfill contains a mixture of coarse aggregate (<150 mm) and fine aggregate (<10 mm fraction). The cement slurry concentration is often around 55 % by weight (1:1.2 water/cement ratio).

Cemented backfill is applied for longhole open stoping, ‘undercut and fill’, and other methods where a structural fill is required.

[94, Life, 2002]

Hydraulic backfill

Hydraulic backfill can consist either of classified slurried tailings or naturally occurring sand deposits mined on the surface. The hydraulic backfill is prepared by dewatering the mineral processing tailings stream to a pulp density of approximately 65 - 70 % solids and then passing it through hydrocyclones to remove the "slimes" retaining the coarse fraction for backfill. Fines are removed to improve the drainage capacity of the backfill, leading to an improved stability. The backfill mixture is hydraulically pumped from the surface through a network of pipes and boreholes to the stope. Sand obtained from surface borrow pits will be screened prior to use in a backfill plant to remove oversize particles that could plug the backfill line. Hydraulic backfill can be cemented or uncemented.

The tailings or tailings fraction suitable for hydraulic backfill depends on several factors, e.g.

- grain size distribution
- slope of the grain size distribution (the steeper the better)
- particle shape (flat silicates are not favoured whereas, round shape are).

In general, hydraulic backfill has permeability coefficients in the range of 1×10^{-7} m/s to 1×10^{-4} m/s corresponding to a grain size of about 35 μm – 4 mm. Hydraulic placement of backfill results in a loose fill structure with a void ratio of about 0.70.

In practice, an apparent cohesion often develops in uncemented backfill which increases the shear strength of the backfill. Often a vertical face of 3 - 4 m can be maintained under some mining conditions. Nearby blast vibrations can also act to compress the fill and increase its shear strength. To overcome the lack of true cohesion in the backfill, cement and other binders are added. Note that the backfill strength decreases with water content and the water content needed to transport hydraulic backfill is far in excess of what is required for cement hydration. Hence, mine operators are moving towards using less water in the fill in order to decrease the cement and binder consumption. Flow velocities in excess of 2 m/s are required to maintain a homogeneous dispersion of the fill components in the slurry.

[94, Life, 2002]

Paste Backfill

The paste backfill is a high density backfill (>70 % solids depending on the density of the solids). In order to pump material at this density, a component of fines is required. As a general rule, the fines content (<20 µm) must be at least of 15 % by weight.

Paste backfill is pumped by piston type pumps of the same type used to pump concrete. Whole mineral processing tailings can often be used to make paste backfill. The final product has a lower void ratio so the backfill is denser.

[94, Life, 2002]

2.4.6 Underwater tailings management

Deep sea/ lake tailings management

In mining areas where tailings are likely to generate acids, deep lake, deep sea or submarine tailings management is sometimes an acceptable method. However, Section 4.5.3 shows an example where the driving force for the application of this technique is the lack of space for tailings deposition on land.

River tailings management

This practice is applied for water soluble materials (e.g. salt). Some potash mines discharge saline waters into rivers. Insoluble tailings are not discharged into running surface waters.

2.4.7 Failure modes of dams and heaps

Usually the following failure modes are considered in developing a tailings management strategy:

- instability
- overtopping of dams
- internal erosion.

Also the long-term safety and failure modes other than complete embankment failure should be considered, such as:

- seepage
- dust
- long-term erosion.

Tailings may retain their hazard potential for a long period of time, which therefore requires efficient measures to contain these hazards in the long term.

From the report of the International Task Force for Assessing the Baia Mare and Baia Borsa accidents it can be seen that usually there is a combination of reasons for the failures of the tailings dams in these cases the accidents were in summary caused by:

- firstly, the use of an inappropriate design
- secondly, by the acceptance of that design by the permitting authorities; and
- thirdly, by inadequate monitoring and dam construction, operation and maintenance.

Design faults:

- a closed-circuit system was used with no specific provision for emergency discharge/storage of excess water
- the dam wall was of inadequate construction, due to lack of homogeneity of the tailings
- the hydrocyclones were non-functional at very low temperatures.

Operational fault:

- failure to observe the design requirements for tailings gradation for dam construction. [116, Nilsson, 2001]

2.5 Tailings characteristics and tailings behaviour

The tailings characteristics determine the tailings behaviour. In combination with the site location, these factors determine to a large extent the type of management facility. The following table shows how certain tailings characteristics influence the tailings behaviour.

Tailings behaviour	Tailings characteristics								
	Grain size distrib.	Fines	Specific surface	% solids	Reagents	pH	ARD influence	Surface properties	Particle shape
Permeability	X	X	X	-	-	-	-	X	X
Plasticity	X	X	X	-	-	-	-	-	X
Shear strength	X	X	X	-	-	-	-	X	X
Compressibility	X	X	X	-	-	-	-	X	X
Tendency to liquefaction	X	X	X	X	-	-	-	X	X
Chemical properties	-	X ¹	X ¹	-	X	X	X	X	X
Density (in-place and relative)	X	X	X	-	-	-	-	X	X
Consolidation	X	X	X	-	-	-	-	X	X
Dusting	X	X	-	X	-	-	-	-	-
Toxicity of discharge	X ²	-	X ²	-	X ³	X	X	X	-
Tailings delivery	X	X	-	X	-	-	X	-	-
Deposition	X	X	-	X	-	-	X	-	-
Free water management	X	X	-	X	X ³	X	X	-	-
Seepage flow	X	X	X	X	-	-	-	X	X
Long-term safety	X	X	X	-	-	-	-	X	X
ARD management	X	X	X	-	-	X	X	X	-
Emissions to air	X	X	-	X	-	-	-	-	-
Emissions to water	X	X	-	X	X ³	X	X	X	-
Emissions to land	X	X	-	X	X ³	-	X	-	-
Effluent treatment	X	X	X	X	X ³	X	X	X	X
Dam construction	X	X	X	X	X ³	X	X	X	X
Monitoring	-	X	-	-	X ³	X	X	-	-
Closure and after-care	X	X	X	X	X ³	X	X	X	X

1) because of increased/altered availability
 2) if ARD producing tailings and exposed to the atmosphere
 3) not necessarily valid if tailings water is removed (i.e. by filtration) prior to tailings discharge

Table 2.3: Effects of tailings characteristics on engineering properties and safety/environmental behaviour of tailings

In combination with Table 2.2, this table shows a connection between the mineral processing technique with the tailings characteristics, the tailings engineering properties and their safety and environmental behaviour. The two tables can be also be read 'backwards'. This means that by starting at the tailings behaviour one can trace back what mineral processing step has an impact on this feature.

2.6 Closure, rehabilitation and after-care of facility

Usually a mine, together with the mineral processing plant and the tailings and waste-rock facilities, will only be in operation for a few decades. Mine voids (not part of the scope of this work), tailings and waste-rock however, may remain long after the cessation of the mining activity. Therefore special attention needs to be given to the proper closure, rehabilitation and after-care of these facilities.

In many cases, the tailings and waste-rock do not contain any substances that are harmful to the environment. In these cases, during the closure phase the operator will ensure that the water is drained from the tailings pond to safeguard the physical stability, and then the dams will be flattened to allow access for machinery. Ponds and heaps will then be prepared for subsequent use, which in most cases, means covering the ponds and/or heaps with soil and vegetating them. In some cases these facilities may be used again, e.g. for potash mining, the tailings heaps contain more than 90 % salt (NaCl), which can be a future economic resource when other economic deposits are depleted or too distant from their markets. In other cases, the mineral processing techniques may develop in a way that more minerals can be profitably extracted. Keeping tailings materials accessible for possible future exploitation, therefore, may be a desirable objective.

If tailings and waste-rock facilities contain substances that can be hazardous to the environment, other measures need to be taken. These measures are aimed at the stability of the tailings and waste-rock facilities whilst minimising future monitoring.

Generally, the major issues to be considered for the reclamation and closure of tailings and waste-rock management facilities include the long-term:

- physical stability of constructions
- chemical stability of tailings and waste-rock and
- successive land use.

The TMF areas of a mine site should be stable under extreme events such as floods, earthquakes and perpetual disruptive forces, including wind and water erosion, such that they do not impose a hazard to public health and safety or to the environment [12, K. Adam,].

If tailings and/or waste-rock contain sulphide minerals, they may create an acid discharge. Even though Acid Rock Drainage (ARD) is a phenomenon that may occur during operation, it is the time after the closure of the facility when ARD becomes a problem. While in operation tailings impoundments are usually saturated and the voids are filled with water. Therefore, chemical oxidation is limited during operation. It is at the closure phase of an operation, when usually the water level within the tailings drops and air enters the voids, that pyrite oxidation can occur and create a problem.

The rehabilitation of a site usually aims to turn the area into something that the local society needs and can make use of. This, of course, has to be compatible with the long-term stability of the site (see Section 4.2.4.1) [118, Zinkgruvan, 2003].

There can be problems trying to establish vegetation on sites which are acid generating, have an elevated metal content, or have a coarse texture and are unable to retain nutrients or water. Guidance is provided on these topics in several reports, such as 'Restoration and re-vegetation of colliery spoil tips and lagoons'⁶, 'The reclamation and management of metalliferous mining sites'⁷ and 'Landscaping and re-vegetation of china clay waste'⁸.

2.7 Acid Rock Drainage (ARD)

For a more complete and scientifically correct description of all relevant issues regarding ARD generation a large amount of recently published literature is available. Recently published state-of-the-art reports for research purposes, with substantial amounts of literature references included, are available free on the internet (www.mimi.kiruna.se) on: Sulphide oxidation (Herbert, 1998); Predictive modelling (Destouni et al., 1998); Prevention and control of pollution from tailings and waste-rock products (Elander et al., 1998); Laboratory studies of key processes (Herbert et al., 1998); Field studies and characterisation (Öhlander et al., 1998); and on Biogeochemical modelling (Salmon, 1999).

The above-mentioned references are only included to give examples. A significant number of these publications are the result of research initiatives that are currently being undertaken, or that have been undertaken during the last 15 - 20 years, within large research programmes such as MEND, Post-MEND, AFR, MiMi, MIRO, INAP, PYRAMID and ERMITE. Some of the most active countries carrying out the research have so far been Canada, Australia, the United States, Sweden, Norway and the UK.

This section aims to provide a short overview of the chemical processes involved in the generation and consumption of acid.

Note in this section (s) stands for solid phase and (g) for gas phase.

Sulphide oxidation (acid generation)

Sulphide minerals extracted from the bedrock have been formed under strongly reducing conditions resulting in sulphur being present in its lowest oxidation states. The most commonly occurring sulphides are iron sulphides (pyrite $\text{FeS}_2(\text{s})$ and pyrrhotite $\text{FeS}(\text{s})$). These iron sulphides often coexist with other sulphides of higher economic value such as chalcopyrite ($\text{FeCuS}_2(\text{s})$); galena ($\text{PbS}(\text{s})$); sphalerite ($\text{ZnS}(\text{s})$) or with sulphides of very little economic value such as arsenopyrite ($\text{FeAsS}_2(\text{s})$). In unaltered bedrock the overlying overburden and groundwater minimise the contact with oxygen. This almost eliminates the oxidation of the sulphides. However, when the sulphides become exposed to an oxidising and humid atmosphere, e.g. by the mining activity, they start to oxidise (weather, dissolve, etc). This process is commonly demonstrated by pyrite ($\text{FeS}_2(\text{s})$) oxidation by oxygen and water as:

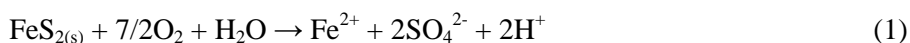

Sulphide oxidation, which is a slow kinetically controlled exothermal process, can also take place with other oxidants such as ferric iron, Fe^{3+} as:

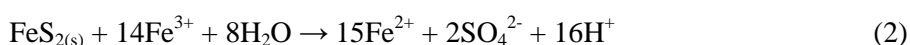

⁶ Richards, Moorehead and Laing Ltd (1996), Restoration and revegetation of colliery spoil tips and lagoons, United Kingdom, HMSO, Department of the Environment, ISBN 0 11 753315 7

⁷ Environmental Consultancy University of Sheffield and Richards Moorehead & Laing Ltd (1994) The reclamation and management of metalliferous mining sites, United Kingdom, HMSO

⁸ Armstrong W.(1993) Landscaping and re-vegetation of china clay wastes – main report, United Kingdom, HMSO, Department of the Environment, ISBN 0 11 752843 9

Oxidation of sulphides, mainly pyrite, and the processes that influence the oxidation rate of the sulphides have been studied in detail over the last decades. Of the various factors that influence the sulphide oxidation rate, the availability of oxygen has been found to be the most important. To sustain a continuous sulphide oxidation, oxygen has to be supplied from the surrounding atmosphere. This is true for sulphide oxidation with oxygen (equation 1) as well as indirectly for sulphide oxidation with ferric iron (equation 2), since oxygen is required for the oxidation of ferrous to ferric iron according to



Ferric iron may contribute to sulphide oxidation (equation 2) or it may hydrolyse and precipitate as ferric oxyhydroxide (dominant at $\text{pH} > 3.5$) according to



There are also indications that the cycling of iron through the ferrous and ferric oxidation states may potentially be a key process in anaerobic tailings and waste-rock management facilities. Field studies, however, indicate that the overall sulphide oxidation rate is dramatically reduced by applying oxygen diffusion barriers. Bio-geochemical modelling results calibrated to field data from a covered tailings deposit do not indicate that pyrite oxidation by ferric iron plays any significant role in the remediated deposit.

As described above, many factors have been found to influence the sulphide oxidation rate, such as e.g. bacterial activity, pH, Eh (oxygen concentration), temperature and galvanic processes between different sulphides. This has, to a large extent, been investigated and numerical expressions (rate laws) have been developed for pyrite oxidation under various conditions. These rate laws are available in the literature. However, under natural conditions, as e.g. in a tailings or waste-rock facility, these various factors are co-dependent and influenced by other factors such as the available surface area for oxidation determined by the grain size distribution, mineralogy, hydrology and the availability of buffering minerals, etc. and will be described in the following sections.

Dissolution of buffering minerals (acid consumption)

If readily available buffering minerals (carbonates) are present in the tailings or waste-rock, acid produced by the oxidation of sulphide minerals (equations 1 and 2) and the precipitation of iron oxyhydroxide (equation 4) will be consumed by the dissolution of the buffering minerals, demonstrated here by the dissolution of calcite

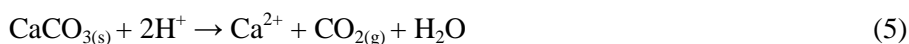

The dissolution of calcite is a fast reaction in comparison to pyrite oxidation and is therefore normally assumed to be in equilibrium (i.e., acid is consumed at the same rate as it is produced). If there are not enough readily available buffering minerals present, or if they are depleted over time, the pH in the drainage may drop and the solubility of dissolved metals will increase. This is what is normally called ARD.

Acid is also consumed by the dissolution of other buffering minerals, such as aluminosilicates, but normally at a slow rate, that cannot keep up with the acid production from sulphide weathering, as the dissolution of the aluminosilicates is kinetically controlled. Acid consumption by dissolution of aluminosilicates is demonstrated below by the dissolution of K-feldspar, muscovite and biotite.

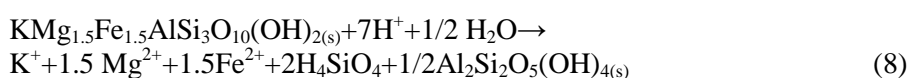
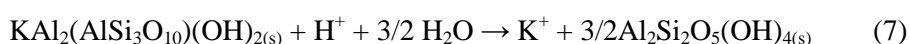

3 APPLIED PROCESSES AND TECHNIQUES

The following tables summarise the mineralogies, the mining techniques and the mineral processing for the minerals covered by this document. Furthermore they highlight some examples of the most important factors in tailings and waste-rock management, namely the characteristics of the tailings and waste-rock, the applied management methods, the measures applied to ensure the safety of the facilities and to prevent accidents, and closure and after-care planning.

It should be noted that unless otherwise mentioned, during mineral processing the ore is reduced in size by crushing and grinding. Screening is also often a part of the size reduction circuit.

As part of an accident prevention programme, it is common practice to carry out visual inspections and phreatic surface measurements with piezometers in dams.

In underground operations, the waste-rock usually remains underground.

Unless otherwise mentioned, the waste-rock from open pit operations is managed on nearby heaps, where the drainage water is collected.

It should be noted that both tables summarise the information provided on tailings and waste-rock management. This however does not generally allow an extrapolation of the information, since an operation extracting the same mineral could operate under completely different conditions and would therefore apply different tailings and waste-rock management methods.

Mineral	Mineralogy	Mining technique	Mineral processing	Tailings characteristics	Tailings management	Safety and accident prevention	Closure and after-care
Aluminium	Al ₂ O ₃ SiO ₂ Fe ₂ O ₃ CaO TiO ₂	Open pit and underground, only one mine in Europe, mostly imported ore	Bayer process	Elevated pH, red mud: d ₈₀ <10 µm, process sand: d ₈₀ <1000 µm	Slurried or thickened	Monitoring routine	Dewater and dry cover, discharge treatment
Base metals	Mostly sulphides	Open pit and underground (cut-and-fill, room and pillar, blasthole stoping)	Flotation, at Boliden CN leaching for Au	d ₈₀ : 50 – 100 µm, often ARD potential	Slurried, at Lisheen subaqueous, usually large ponds: 35 – 1450 ha, some backfill (coarse fraction)	OSM manual, independent audits, water balance	Dewater and dry cover or wet cover
Chromium	26 % Cr ₂ O ₃	Open pit	Dense medium and magnetic separation	Containing Cr and Ni	Slurried	Independent audits	No plans
Iron	Phosphorous magnetite, iron carbonates	Open pit (Erzberg), underground (large-scale sub-level caving)	Magnetic separation, dense medium separation	No ARD potential, Kiruna: mostly SiO ₂ and Fe _x O _y	Fines: slurried, coarse: heaps	OSM manual, independent audits, subsidence measurements	Dewater and dry cover
Manganese	MnO ₂	Underground	Only crushing	No tailings			
Precious metals	Complex sulphides, native gold, gossan, etc.	Open pit and underground	CN leaching, spirals, shaking table	Some have ARD potential, in case of CN leach: containing cyanide, complexed metals, cyanate, thiocyanate	Slurried, some backfill (coarse fraction), CN destruction	Risk assessment, stability calculations, planning by external experts, OSM manuals, independent audits, piezometers, inclinometers	Dewater and dry cover, wet cover, raised groundwater table
Tungsten	(Fe, Mn)WO ₄ , CaWO ₄	Underground (sublevel stoping, sublevel caving, cut-and-fill)	Flotation, dense-medium separation, shaking tables	d ₈₀ =100 µm, no ARD potential	Slurried, some backfill (coarse fraction)	Involvement of external experts and authorities	Dewater and dry cover
Barytes	BaSO ₄	Open pit, underground	All techniques e.g. jigging, dense medium, flotation		Often no tailings, fines as slurry, sometimes backfilled, coarse tailings on heaps or sold as aggregates		
Borates	B ₂ O ₃	Open pit, underground	Dissolution, crystallisation, drying/cooling		Coarse tailings first on heaps and then backfilled, slurry in ponds		
Feldspar	Orthoclase, albite, anorthite	Quarrying	Sometimes none, otherwise optical separation, flotation, electrostatic or magnetic separation	Solids contain fine sands and micas, 10 % iron oxides, some flocculants, process water: pH 4.5, some fluoride	Coarse tailings on heaps, slurries are backfilled or ponded	Topographical surveys	

Mineral	Mineralogy	Mining technique	Mineral processing	Tailings characteristics	Tailings management	Safety and accident prevention	Closure and after-care
Fluorspar	CaF ₂ (in one case also PbS)	Open pit and underground (cut-and-fill, room and pillar)	Dense medium separation, flotation,	Mostly silica (90 %), Fe and Al oxides	Backfilling and process water re-use, slurries mostly to ponds, in one case fine tailings into sea	Phreatic surface with piezometers	After-care period of 10 yrs expected to monitor heavy metals, fund for closure/after-care costs
Kaolin	Kaolinite, quartz, micas, feldspar residues	Quarrying	No comminution, magnetic separation, flotation	Fine sands and micas, <1 % iron oxides, some flocculants, process water: pH 4.5, some phosphates, sulphates, foam inhibitor	Coarse tailings on heaps, slurries in ponds lined with clay, in one case dewatered fines are transferred to heaps	Seepage flow, vertical and horizontal movements of the dam crest, emergency plans	Dewater and dry cover
Limestone/calcium carbonate	97 – 98 % CaCO ₃ , <1 % MgCO ₃ , <1 % SiO ₂	Open pit/quarry	Limestone: washing; calcium carbonate: flotation, magnetic separation	Limestone: <0.25 mm	Slurries in ponds, in one case the pond is a former quarry, sometimes the slurry is dried and the tailings discarded onto heaps	Stability calculation using DIN, quality management during dam construction, changes in dam are logged, annual reviews, independent audits	Dewater and dry cover
Phosphate	Apatite (10 %), phlogopite mica (65 %), carbonates (20 %) and silicates (5 %)	Open pit	Flotation		Slurries in ponds	Water level controls on-line and monitored, with alarms in plant operating system, seepage measurements, dam movement measurement	
Strontium		Open pit	In one case none, in the other dense medium and flotation		Coarse tailings are backfilled, flotation slurry in ponds	New lined pond with dam built to final height	
Talc	Talc, carbonates, chlorites and sulphides		Often only comminution, sometimes flotation		Flotation tailings in ponds, which through dewatering become heaps	Seepage water control, safety manuals, annual review	
Potash	Sylvinitic carnallite hard salt kainitite and other salts	Underground (room and pillar, longwall, sublevel stoping)	Hot leaching, flotation, electrostatic separation, dense medium separation	Liquid and solid tailings, containing sodium chloride with other salts, clay and anhydrite	Solid tailings on heaps, liquid tailings into deep wells or surface waters, in one case marine discharge of liquids and solids, some solid tailings are backfilled	Annual review, slope inclinometers, seismic monitoring	Heaps remain unchanged and dissolve over time
Coal	Carbon, ash, sulphur	In Spain and UK-some open pit, otherwise underground (longwall)	Coarse fractions in jigs or dense medium, flotation for fines	Clay, shale, sandstone, sulphides, some reagents, can be radioactive	Backfilling often too costly, coarse tailings on heaps or in old pits, fines in ponds, sold or filtered and to heaps	In some areas seismic monitoring	Landscape integrated heap design agreed with authorities and communities

Table 3.1: Summary of applied processes in the management of tailings

Mineral	Waste-rock characteristics	Waste-rock management	Safety and accident prevention	Closure and after-care
Base metals	Sometimes has ARD potential	In one case selective management of ARD and non ARD waste-rock, sometimes used for dam construction, in one case backfill, collection of surface run-off	1:3 slope	Vegetative cover, engineered cover to reduce ARD generation
Chromium				Backfilling of all waste-rock underground
Iron	No net ARD potential, possibly ammonium nitrate leachate	On heaps, at one site together with coarse tailings	1:2 slope	Vegetative cover using soil and seeds, long-term seepage monitoring
Precious metals		On heaps, for dam construction or backfill into open pit		At one site covering with topsoil
Barytes		Sometimes sold as aggregate or backfill		
Fluorspar		Backfill		
Kaolin		Collection of surface run-off		
Limestone		Backfilling into old quarry		
Phosphate		Some uses as aggregate		Landscaping plans have been developed with local authorities and communities
Talc			1.3 safety factor, yearly surveys, monthly inspections, periodical risk assessments	Water drainage and vegetative cover
Coal		With coarse tailings on heaps, temporary heaps and later backfilling		Final heap design agreed with authorities and communities with the goal of creating landscape integrated structures

Table 3.2: Summary of applied processes in the management of waste-rock

3.1 Metals

3.1.1 Aluminium

In the section, information about the following alumina refineries is provided:

Plant	Country
Aluminium de Greece, Distomon	Greece, Central
Aughinish Alumina, Aughinish	Ireland, Aughinish
Eurallumina, Sardinia	Italy, Sardinia
Alcoa Inespal, San Ciprian	Spain, Galicia
Ajka	Hungary, Bakony region

Table 3.3: Alumina refineries mentioned in this section

3.1.1.1 Mineralogy and mining techniques

The bauxite deposits of **central Greece** are lenticular bodies in the form of three bauxite layers. Vanadium, manganese, nickel, cobalt, chromium, zinc, copper, phosphorus and sulphides can be found in the ore at low levels or as trace elements. So far the amounts of ore resulting from from underground and open pit mining have been roughly equal, but in the future it is expected that more underground mining will be carried out because of the increase in the stripping ratio, and due to the emerging environmental aspects connected to open pits. [90, Peppas, 2002]

In underground mining the 'room and pillar' method is applied, sometimes in combination with 'cut-and-fill' if the orebody is thicker than 8 m. Ore bodies with a stripping ratio of 6 - 8 m³ of waste-rock or overburden per tonne of ore are mined in open pits via conventional drilling, blasting and loading [90, Peppas, 2002].

In the Hungarian **Bakony** region six bauxite mines are in operation, which all send their bauxite to the refinery in **Ajka**. The bauxite is of the karst type in the form of lenticular or pod-like deposits. Mining is undertaken by open pit (drilling/blasting/loading) at a stripping ratio of 6.3 m³/t, or underground using sublevel caving [91, Foldessy, 2002].

The following table shows the chemical composition of bauxite processed in European refineries.

Component	% by weight
Al ₂ O ₃	53 - 60
SiO ₂	2 - 25
Fe ₂ O ₃	6.5 - 22
CaO	0.2 - 1.2
TiO ₂	2 - 4
LOI ¹	16 - 27

Table 3.4: Chemical composition of bauxites fed to European refineries

3.1.1.2 Mineral processing

As mentioned in Section 2.3.4.1, the Bayer process is used to treat bauxite in all alumina refineries in Europe.

The Bayer process is based on a continuous re-circulation of caustic solution, which acts as the dissolving agent for the hydrate-alumina within the bauxite as well as the transport medium for carrying all the solids through the various process stages. In the first stage of this process, the bauxite is put through a wet grinding stage, resulting in a slurry with 50 % solids. This is preheated to 100 °C and held in holding tanks to make the silica more reactive. Caustic liquor returning from the previous cycle is then re-concentrated and heated up. At the subsequent leaching (or digestion) phase the bauxite slurry is mixed with the caustic liquor at a high temperature (250 °C). Gibbsite and Boehmite rapidly dissolve, leaving the inert part of the bauxite (the red mud) undissolved.

Clarification of the pregnant liquor is carried out by thickeners and filtration. The mud is separated in two steps. First, so-called sands (i.e. particles over 150 µm) are removed by cycloning the liquor and separating the solids in screw-classifiers. In the second step the mud is settled in large thickeners.

The clarified pregnant liquor is then pumped to the precipitation phase to produce solid hydrate. The hydrate is then calcined to produce alumina. The liquor is strengthened with fresh soda make-up and returned to the process.

The separated mud is extracted from the decanter's cone at around 30 % solids, and pumped to a continuous three or four stages counter current washing unit, where most of the caustic liquor accompanying the mud is recovered.

Some alumina plants pump mud from the last washer to the mud pond. Other plants thicken the mud by vacuum filtration or deep thickeners before pumping the mud to the TMF.

3.1.1.3 Tailings management

On a worldwide basis, four to six tonnes of bauxite on average yield on average two tonnes of alumina and one tonne of aluminium. The European refineries that import bauxite use high grade bauxite, in order to reduce shipping costs. The following figure shows typical mass flows for European refineries.

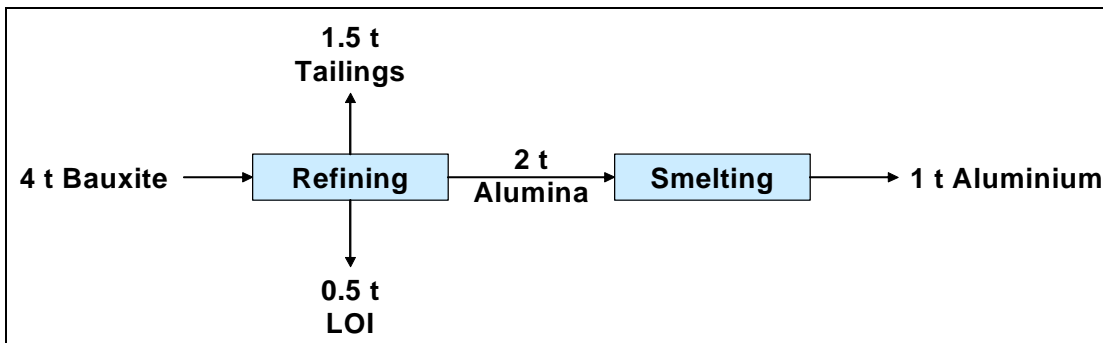

Figure 3.1: Typical mass flow from Bauxite to Aluminium (dry basis)

It should be noted that LOI stands for ‘Loss On Ignition’ or ‘Water Of Crystallisation.’

3.1.1.3.1 Characteristics of tailings

The alumina tailings consist of two major parts. The fine fraction, which accounts for 80 – 95 % of total, called ‘red mud’ and a coarser fraction, commonly referred to as ‘process sand’. These two portions represent 97 – 100 % of the total tailings. In some cases the remaining 3 % consists of salt cake, which can originate from a salting-out liquor purification process and sludge (principally aluminium hydroxide) from the underflow of the clarifier.

Red mud

The following figure shows some red mud size distributions of alumina refineries.

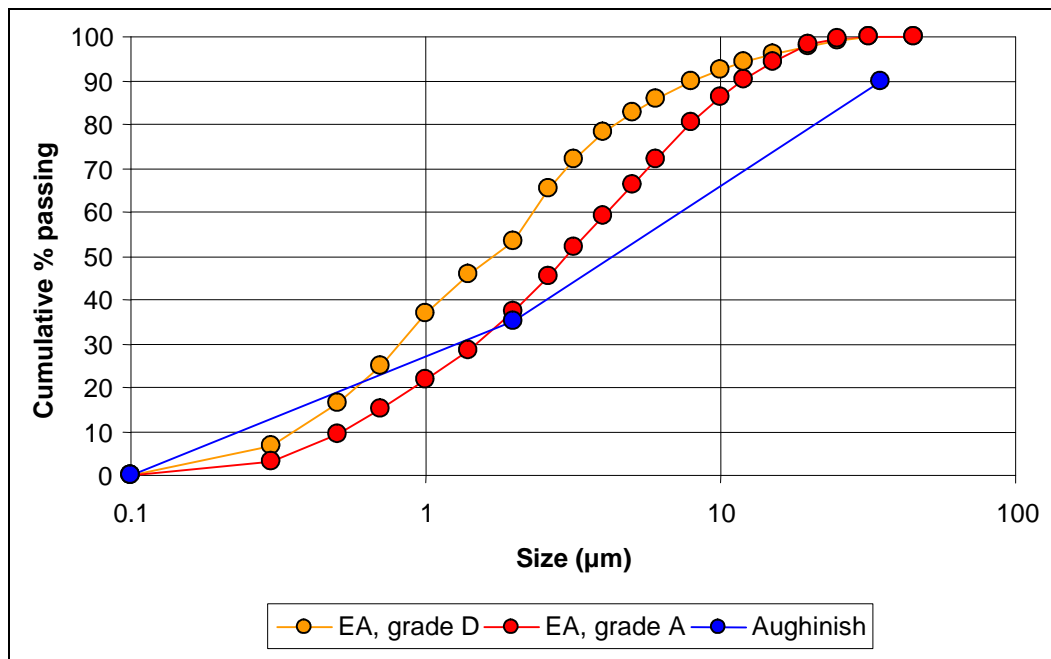

Figure 3.2: Size distribution (particle size vs. cumulative % passing) of red mud at the Sardinian (EA) and Aughinish sites [89, Teodosi, 2002], [22, Aughinish,]

If the red mud is pumped as thickened tailings, it usually has a solids content of 55 – 60 %. It then ‘matures’ at the TMF, which for thickened tailings is often referred to as a ‘stack’, over a period of three to six months to a solids content of 68 – 70 % due to compression and evaporation.

At the **Aughinish** refinery the initial permeability of the red mud is between 1×10^{-8} to 1×10^{-9} m/s. It decreases as the mud matures. The average density of dry mud solids is 3.1 t/m^3 [22, Aughinish,]. The benefit of this technique is that the tailings are physically stable upon discharge onto the stack. However, precipitation run-off and seepage water will have elevated pH levels, due to the residual caustic liquor, and must therefore be neutralised before release to the environment. Alternatively they can be used in the washing circuit in the alumina plant.

At the **Sardinian site**, the red mud is resuspended to 20 - 25 % solids using fresh seawater and free water from the tailings pond and then pumped to the tailings pond. The neutralisation of the mud is performed by the flue-gas desulphurisation in the wet scrubbing operation, and with the magnesium chloride of the fresh seawater added to the system.

After settling and evaporation, the solids content increases to 65 – 72 %. The ratio of tailings, at the Sardinian refinery, is 0.78 tonnes dry tailings per tonne of alumina. Considering that the slurry consolidates at 60 – 65 % solids in the pond, this corresponds to about 1.3 tonnes of wet material per each tonne of alumina produced or $0.8 \text{ m}^3/\text{tonne}$ of alumina produced. [89, Teodosi, 2002].

The neutralisation of the red mud leads to chemical stability of the tailings. The trade-off here is that, as for all slurried tailings impoundments, physical stability of the dams must still be taken care of.

The solids content of the tailings for both options are shown in the following figure.

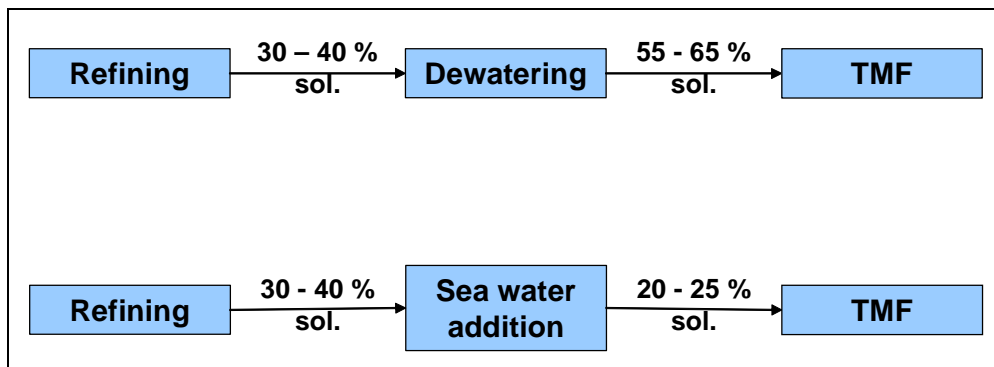

Figure 3.3: Solids content (in % solids by weight) of tailings for thickened and conventional management schemes

In both cases, the tailings mature to about 70 % solids. Generally dewatering can be carried out in vacuum filters (yields 63 % sol., e.g. Aughinish) or in deep thickeners (yields 50 % sol.).

Some chemical analyses of red mud from different sites are shown in the following table.

Component:	Site:		
	Sardinia	Bakony	Aughinish
	Dry wt. %	Dry wt. %	Dry wt. %
Fe ₂ O ₃	18	40	47
Al ₂ O ₃	26	18	17
TiO ₂	6	4	12
SiO ₂	20	15	7
Na ₂ O	12	8	5
CaO	8	7	8
LOI	9	7	3
Misc. Trace elements	1	1	1

Table 3.5: Constituents of red mud
[89, Teodosi, 2002], [91, Foldessy, 2002], [27, Derham, 2002]

Despite repeated washings, the solution entrained within the red mud still contains small amounts of caustic (sodium hydroxide), which causes the elevated pH characteristics, and alumina. Most of the caustic converts to sodium carbonate and sodium bicarbonate on the tailings stack.

The following table shows an example of a more detailed analysis of red mud, including the trace elements.

Analysis of Aughinish Alumina Red Mud			METHOD OF ANALYSIS
Name	formula	% dry	
Principal Compounds			
Titanium dioxide	TiO ₂	9.93 %	
Iron Oxide	Fe ₂ O ₃	46.18 %	
Silica Quartz	SiO ₂	8.11 %	
Sodium Oxide	Na ₂ O	4.39 %	
Calcium Oxide	CaO	4.41 %	
Alumina (aluminium oxide)	Al ₂ O ₃	16.50 %	
Loss on Ignition LOI (includes crystalline water)		9.26 %	
	subtotal		98.78 %
Secondary Compounds			
Zirconium dioxide	ZrO ₂	0.15 %	
Zinc Oxide	ZnO	0.01 %	
Vanadium pentoxide	V ₂ O ₅	0.17 %	
Phosphorus pentoxide	P ₂ O ₅	0.43 %	
Manganese Oxide	MnO	0.05 %	
Magnesium Oxide	MgO	0.07 %	
Potassium Oxide	K ₂ O	0.04 %	
Chromium trioxide	Cr ₂ O ₃	0.26 %	
	subtotal		1.18 %
	BASIC TOTAL =		99.96 %
Misc. Trace elements ex analysis by EOLAS			
Sulphur		0.12 %	
Arsenic (just at detection limit, therefore approximate)		0.005 %	
Tin	<	0.005 %	
Mercury	<	0.005 %	
Antimony		0.019 %	
Lead		0.020 %	
Gallium		0.006 %	
Bismuth	<	0.005 %	
	subtotal =		0.19 %
GRAND TOTAL (discrepancy of different dates & methods of analysis) =			100.15 %

Table 3.6: Detailed analysis of red mud, including trace metals [32, Derham, 2002]

Process sand

Size distribution curves for process sand are shown in the following figure.

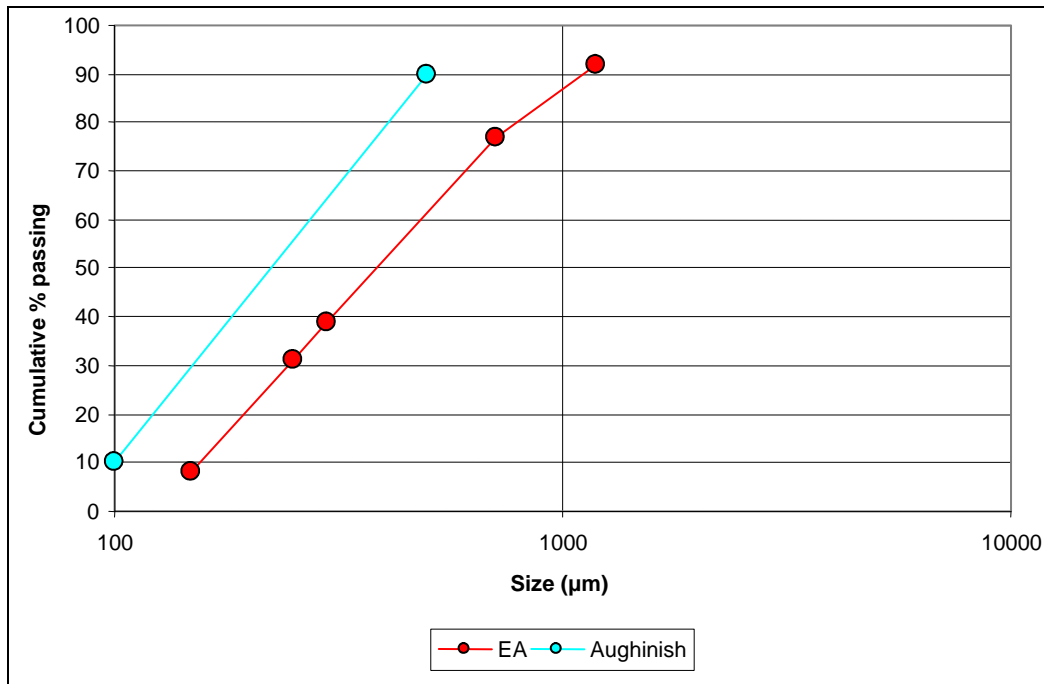

Figure 3.4: Size distribution (particle size vs. cumulative % passing) of process sand at the Sardinian (EA) and Aughinish sites [89, Teodosi, 2002], [22, Aughinish,]

The following table shows the components of the sand fraction:

Component:	Site:
	Sardinia
	Dry wt. %
Fe ₂ O ₃	14
Al ₂ O ₃	40
TiO ₂	3
SiO ₂	16
Na ₂ O	12
CaO	1
LOI	12
Misc. Trace elements	2

Table 3.7: Constituents of tailings sand [33, Eurallumina, 2002]

The permeability of the sand fraction is estimated to be 100 times higher than that of the red mud [22, Aughinish,].

Others

Salt cake is dumped as a 70 % solids cake. Clarifier sludge is pumped to the stack as a 2 to 3 % solids slurry. Salt cake consists of organic degradation products from humates in the bauxite, including sodium carbonate, sodium sulphate and sodium oxalate. [22, Aughinish,].

3.1.1.3.2 Applied management methods

For the management of tailings from alumina refining, thickened tailings as well as conventional slurried tailings, are applied. Some refineries discharge the tailings into the sea. Others manage them on land on ‘stacks’, for thickened tailings, or within dammed ponds, in the case of slurried tailings.

Generally the design of red mud stacks using the **thickened tailings method** includes pervious perimeter rock fill dams and sealing of the underlying surface. A perimeter dam is usually used for the collection of surface run-off and, therefore, typically surrounds the stack. The upstream construction method for the stacks is used, since the dewatered red mud is sufficiently stable.

Due to the very low permeability of the red mud, the principal risk of seepage arises from ponding of caustic surface water run-off in exposed areas prior to covering with mud and seepage from standing water in the perimeter ditch. This can be handled by sealing surface and ditches with liners, such as glacial till or synthetic liners combined with a drainage system. Seepage analysis for typical and worst case conditions are undertaken in order to properly design these facilities.

[22, Aughinish,]

With the **Sardinian** refinery, the red mud is diluted to 20 % solids and used in the flue-gas desulphurisation. The mud slurry to be used in the absorbers needs to have its solid content well diluted, in order to protect the perforated dishes of the absorber against early blockages by plugging by solids deposition.

[89, Teodosi, 2002]

In the Sardinian refinery the following aspects were of importance in the design of the facility:

- short distance between refinery and pond, to reduce pumping costs
- availability of surface area
- need to manage tailings on land, as opposed to discharging into the sea, in order to protect fishery
- vicinity to the sea, because of the need for seawater to neutralise the tailings
- low risk of aquifer contamination
- strong winds in the area, therefore it is beneficial to have wet tailings.

The location of the TMF can be seen in the following figure

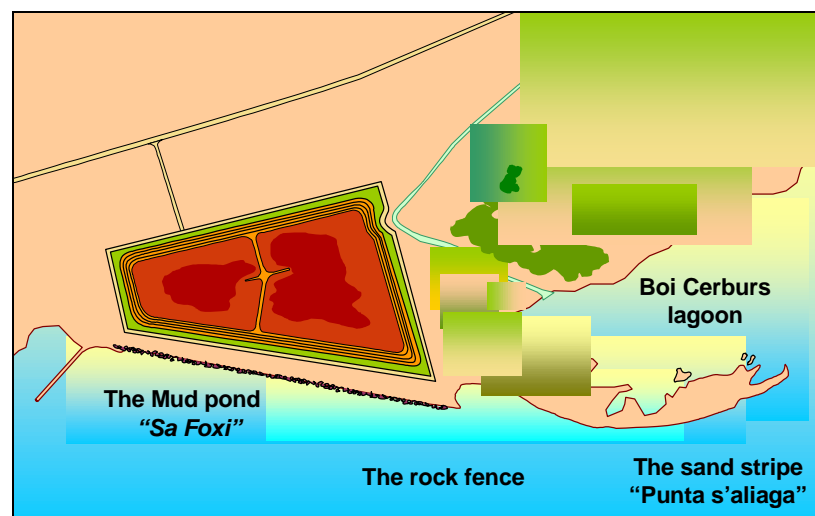

Figure 3.5: Location of TMF at the Sardinian refinery
[33, Eurallumina, 2002]

The 'rock fence' protects the TMF from waving action.

A cross-section of the dam can be seen in the following figure.

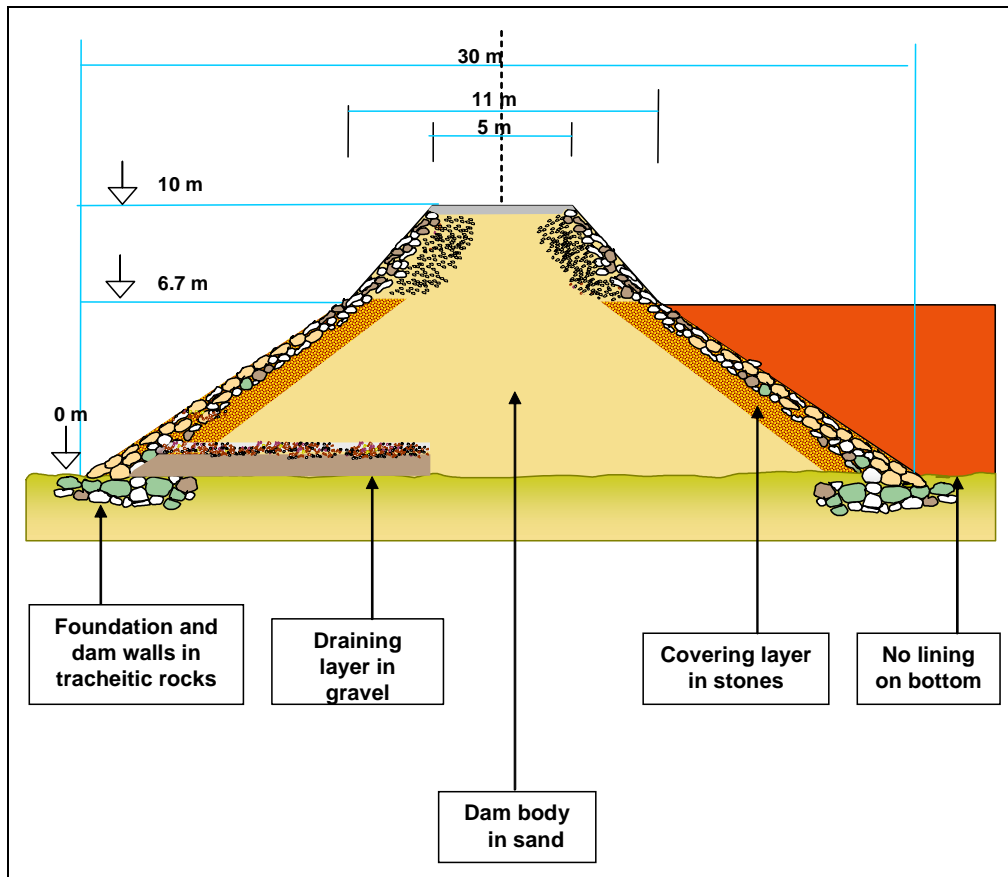

Figure 3.6: Cross-section of tailings dam at Sardinian site [33, Eurallumina, 2002]

The concept of this original dam design is to drain the tailings water whilst the tailings remain within the impound. Hence good drainage (up to 70 %) is achieved.

Further raises of the dam, using the upstream method, were carried out as shown in the following figure.

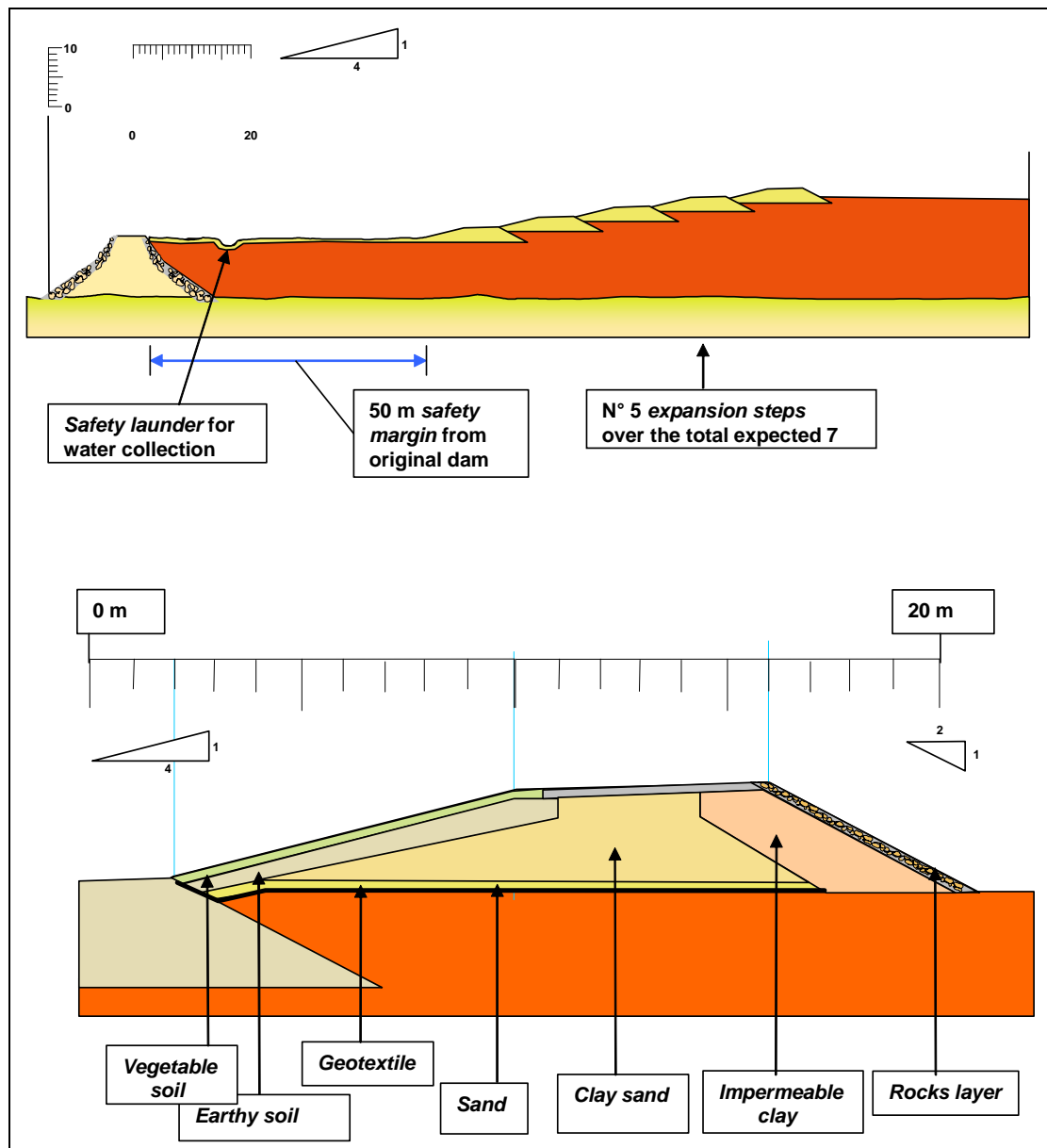

Figure 3.7: Cross-section of dam raises using the upstream method [33, Eurallumina, 2002]

The mud is distributed along the perimeter of the facility with a discharge every 50 m. To achieve an even distribution, different discharge points are used every 24 h. The sands and other process residues are transported to the TMF by trucks and discarded in a dedicated area of the TMF.

[33, Eurallumina, 2002]

In the **Ajka** refinery, ‘cassettes’, i.e. paddock-style tailings ponds for the collection of red mud, are built from gray slag derived from the nearby thermal power plant. The dams have 1:1 to 1:1.5 slope ratios (see figure below). Their final height is up to a maximum of 10 m. The red mud is transported to the TMF via pipeline at 20 % solids. The distance is 3 - 4 km. The free water from the pond is re-used in the process. The circular movement of the discharge pipe achieves an even distribution of the red mud in the cassette. The free water in the cassettes prevents the development of larger dry surfaces and the drying of the red mud.

[91, Foldessy, 2002]

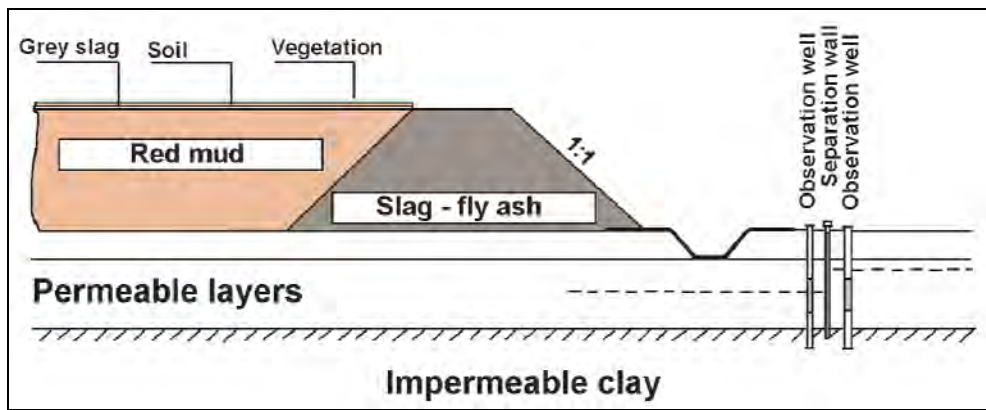

Figure 3.8: Cross-sectional view of TMF at Ajka showing the dam, pond, observation wells, separation wall and ground conditions, as well as the soil cover upon closure [91, Foldessy, 2002]

An impermeable clay layer is found 10 m beneath the tailings management facilities. For this reason, no sealing was used during the construction of the cassettes. In the 1980s it was revealed that groundwater pollution had developed in the layer between the bottom of the cassettes and the clay layer. To contain this pollution an impervious wall into the impermeable clay layer was built around the cassettes. In the inner side of this sealing wall a drainage system collects seepage water and groundwater, which is then pumped back into the cassette.

In the surrounding area 240 groundwater observation wells were drilled. These serve to measure the level and sample the groundwater for chemical analysis. Groundwater level measurements are repeated monthly, and a chemical analysis of the groundwater samples for 8-10 components is done every quarter. This system ensures the early detection of any damage of the separation wall, and also monitors the migration of the pollution plume. [91, Foldessy, 2002]

At the **Galician** alumina refinery, the initial method of raising the dam was the upstream method. For this, rock and soil was taken from local deposits of granite-quartz rock and fill material. This method has been changed since 1986. The new method, the centreline method, uses the same borrow materials. However, by using this method the available surface area and, therefore, the storage capacity does not decrease with each dam raise (see Figure 3.9).

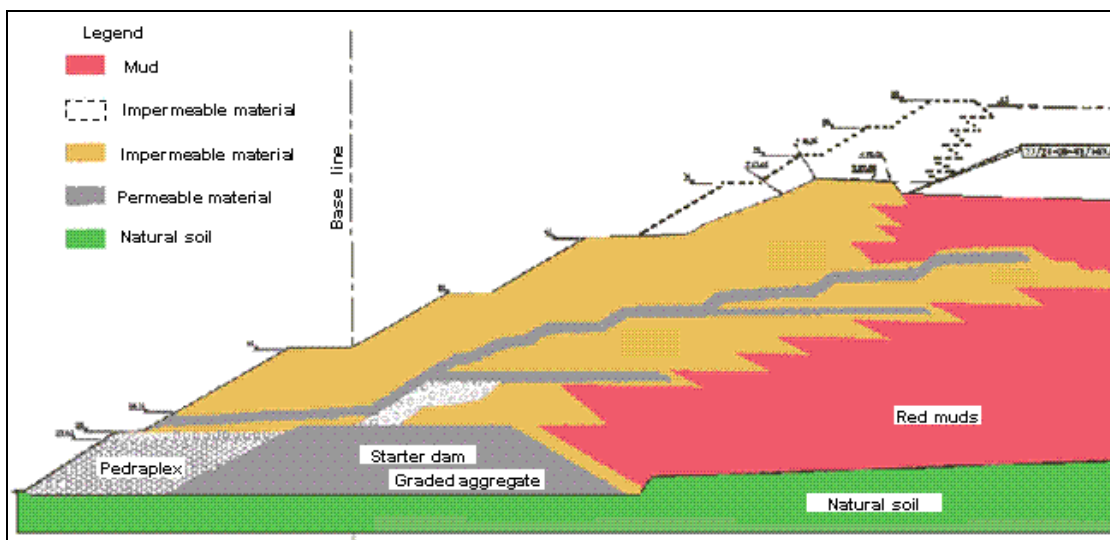

Figure 3.9: Cross-section of the tailings dam at the Galician refinery showing the upstream and centreline methods of increasing the dam height

3.1.1.3.3 Safety of the TMF and accident prevention

The control programme at the Sardinian site includes the following:

- inspection tour of the TMF every two hours
- daily overall inspection inside and outside of the TMF by trained staff
- performance control of external water collecting pumps on a daily basis and recording of the flow measurements
- monthly sampling at external piezometer network, with analysis of pH and metals
- checks of dam stability twice a year
- annual tracing of coastal profile to check erosive trends
- daily change of discharge points
- checking of water balance
- continuous recording of meteorological conditions
- continuous measure of pH upon exit from the mud filtration unit, before pumping to the TMF.

Staff working in the TMF area have been trained during specific annual training courses. An emergency procedure exists.

Seven pumps are spread around the perimeter of the pond so that they can be used should a water leakage occur from the embankment. The water level in the basin is controlled by a thorough monitoring and control of fresh seawater addition to the mud circuit. [33, Eurallumina, 2002]. However, these pumps are not capable of handling a complete failure of the dam.

3.1.1.3.4 Closure and after-care

If thickened tailings management is carried out horizontally on one stack, progressive restoration is not practical, since most of the surface will be used for dumping red mud. During restoration, the stacking slope of 2.5 % allows effective run-off of precipitation without erosion. Furthermore, the stack is accessible for construction equipment [22, Aughinish,]. The mud stack will be restored with a vegetative cover. This has been successfully demonstrated at several sites. Re-vegetation of the perimeter slopes, built with borrowed rock-fill (e.g. limestone) is common practice and usually designed in such a way that the vegetation matches the looks of the surroundings [22, Aughinish,].

Vegetative covers have already been applied successfully to conventional tailings ponds.

At the **Ajka** site, the dewatered tailings are covered by a 0.5 m thick layer of slag from a power plant and another layer of soil [91, Foldessy, 2002].

In the after-care phase, the run-off needs to be treated prior to discharge, until the chemical conditions have reached acceptable concentrations for discharge into surface waters. Also access roads, drainage systems and the vegetative cover (including re-vegetation if necessary) need to be maintained. Furthermore, continued groundwater quality sampling will form part of any closure programme implementation and must be continued. [22, Aughinish,]

3.1.1.4 Current emission and consumption levels

3.1.1.4.1 Management of water and reagents

At **Aughinish**, the water from the TMF is recycled to the process; at the **Sardinian site** the TMF water is recycled to the mud handling facilities, to better manage the water balance at the pond. In the latter case, it is not possible to re-use the free water in the Bayer process because the saline content of seawater would spoil the caustic leaching solution.

At **Ajka** a total of 1.75 Mm³ of fresh water are consumed every year, of which 50 % are released into surface water.

The following table lists the reagent consumption of one alumina refinery

Ajka site	
Reagent	Consumption
	g/t
NaOH	79167
H ₂ SO ₄	4167
HCl	50
Hg	3
CaO	39167
Water glass	19333

Table 3.8: Consumption of reagents at Ajka refinery

At the **Sardinian** refinery, the chemical additives added to the process are grouped in the following categories:

a) **Lime**: the principal process reagent, with a specific consumption of around 40 kg CaO/tonne of alumina, for a number of reactions, namely

- reaction with titanium and phosphorus contained in bauxite, by precipitating them as titanate and phosphate, to protect alumina from the relevant content of impurities
- reaction with sodium carbonate, an impurity present in the liquor, to revert it back into sodium hydroxide
- reaction with sodium oxalate, an organic impurity of the liquor, to transform it into calcium oxalate, which in the solid form is rejected with the process mud
- plus other reactions in the digestion phase, to improve the boehmite (aluminum oxyhydroxide, a source of alumina in the bauxite) extraction, and to promote the transformation of any iron oxide present in the bauxite as goethite into iron haematite, which in the solid form follows the mud, thus minimising iron impurity in the product.

b) **Other process reagents**:

- humate control agents, used to remove long chain organic matters from the caustic liquor: polyamines in water
- precipitation control agents, mostly used to control the oxalate impurity precipitation: oxygenated hydrocarbons, fatty acids and oxyalkylates
- antifoam agents: hydrogenated fatty acids
- flocculants for mud decantation, to improve mud settling and separation from the rich liquor: polyacrylic product
- flocculants for mud decantation, to improve mud settling in the mud washing circuit: polyactylamidic product
- dewatering agents, to reduce hydrate moisture at the calciners feed: based on nonyl-phenol etoxylate and oxygenated hydrocarbons

- rheology agent, to reduce viscosity of bauxite slurry and to improve its fluid flow properties: acrylic polymers with sulphonic functional groups.

c) Boiler feed water reagents:

- chelate agent, to reduce incrustation inside the boiler tubes, fed with process condensate: functional groups type NTA (nitrilo-tri-acete) or EDTA (ethylen-diamine-tetracetate), which can capture (sequester) Ca and Mg, thereby inhibiting their precipitation inside the boiler water circuit
- deoxygenating agent, to treat boiler feed water: sodium-hydrosulphite
- antifoam agent, to treat boiler feed water
- cleaning agent, for boiler water side.

d) Fuel oil treatment:

- dispersant, to improve burners cleanliness
- magnesium oxide, to reduce smoke side
- tar solvent, to reduce deposition of solids.

e) Water treatment:

- dispersant for cooling water, to reduce scaling rate in the circuit and in the tower
- biocide reagent, for water treatment
- sterilising reagent, for water treatment.

f) Reagents for chemical cleaning:

- sulphuric acid, specific consumption about 9 kg/tonne alumina, to clean digestion heater-tubes, and for the final control of mud pH, before its discharge to the pond
- hydrochloric acid, specific consumption ab.0.4 kg/tonne alumina, to clean press cloths
- corrosion inhibitor for H₂SO₄
- corrosion inhibitor for HCl
- antifoam for acid treatment.

The total quantity of all the above-mentioned reagents amounts to nearly 1 kg/tonne alumina. All organic compounds, which largely decompose into CO₂ and water during the high temperature digestion phase.

In the near future, the **Sardinian** refinery will incorporate a treatment plant for the free water from the pond. Currently the pond water balance has been maintained owing to the favourable climatic conditions (i.e. high net evaporation rate) and by recirculating water from the pond to the mud filters to suspend fresh mud. This recirculation has become more and more important at the refinery during the cold season, because of the reduced evaporative surface, as a consequence of the sequentially raised dam, using the upstream method. Once the water treatment plant is operational, it will allow discharge of the free water from the pond into the sea, and consequently it will eliminate seasonal problems with the water.

3.1.1.4.2 Emissions to air

Air pollution may result from the stack gases of the high capacity alumina calcinating kilns. Here electrostatic filters are used to separate the suspended solid particles.

Dust blowing of the TMF can be an issue, in which case in dry periods spraying with water and hay spreading are applied.

3.1.1.4.3 Emissions to water

Groundwater monitoring is carried out in wells around the stacks and ponds. No effluent is discharged into surface waters [22, Aughinish,].

3.1.1.4.4 Soil contamination

Due to the combined very low permeability of both the red mud and underlying estuarine soil (clayey silt) deposits, seepage into the ground is very limited.

3.1.1.4.5 Energy consumption

The energy consumption related to the tailings management at the Sardinian site is caused by the energy used in three pumping stations, to pump:

- the tailings slurried in water (fresh seawater and recycled water from the pond) from the refinery site to the pond, and distribution within the dam; power utilisation approx. 230 kW, 100 % of the time
- the clarified water from the pond back to the refinery to suspend other mud and reduce the usage of fresh seawater, to keep the total water into balance; power utilisation approx. 60 kW, 70 % of the time
- the fresh seawater necessary for the tailings management, both for neutralisation and for the solids suspending purposes; power utilisation approx. 100 kW, 30 % of the time.

[33, Eurallumina, 2002]

At **Ajka** in 2001, the energy consumptions were as follows:

- energy: 127705 MWh or 21 kWh/tonne of feed
- steam: 788300 t or 1.3 tonnes of steam/tonne of feed
- natural gas: 35360000 m³ or 58.9 m³/tonne of feed

3.1.2 Base metals

In this section, information about the following base metals sites is provided:

Area	Site	Country
Aitik	Aitik Mine	Sweden
Almagrera	Aguas Teñidas, Sotiel	Spain
Aznalcollar ¹	Los Frailes	Spain
Boliden Mining Area	Maurliden, Petiknäs, Renström, Åkerberg, Kristineberg	Sweden
Cantabria	Mina Reocín	Spain
Garpenberg	Garpenberg Mine, Garpenberg Norra	Sweden
Hitura	Hitura Mine	Finland
Las Cruces Project ²	Las Cruces	Spain
Legnica-Glogow copper basin	Lubin, Polkowice-Sieroszowice, Rudna	Poland
Lisheen	Lisheen	Ireland
Pyhäsalmi	Pyhäsalmi, Mullikkoräme	Finland
Tara	Tara	Ireland
Zinkgruvan	Zinkgruvan	Sweden
1. Information on closure		
2. Currently in permitting stage		

Table 3.9: Base metals sites mentioned in this section

3.1.2.1 Mineralogy and mining techniques

Mineralogy

Cadmium

There are only a few cadmium minerals, such as greenockite (CdS) or otavite (CdCO_3 and as CdO). The chemical element cadmium (Cd) can replace zinc (Zn) in the sphalerite mineral. Hence cadmium is often found in the zinc-concentrate after mineral processing. In this case cadmium is removed at the smelter. In addition lead and copper ores may contain small amounts of cadmium. [35, EIPPCB, 2001]

Copper

The most common copper minerals are:

- sulphides:
 - chalcopyrite (CuFeS_2)
 - chalcocite (Cu_2S)
 - covellite (CuS)
 - bornite (Cu_5FeS_4).

The yield of chalcopyrite is rather low in terms of atoms per molecule. It is only 25 %, compared to other copper minerals such as chalcocite – 67 %; cuprite – 67 %; covellite – 50 % or bornite – 50 %. However, the large quantities and widespread distribution of chalcopyrite make it the leading source of copper. Chalcopyrite is a common mineral and is found in almost all sulphide deposits.

- oxides: cuprite (Cu_2O).

Cuprite has long been mined as a major source of copper and is still mined in many places around the world today. Of all the copper ores, excluding native copper, cuprite gives the greatest yield of copper per molecule, since there is only one oxygen atom to every two copper atoms [37, Mineralgallery, 2002].

- others, such as:
 - malachite ($\text{Cu}_2(\text{CO}_3)(\text{OH})_2$)
 - azurite ($\text{Cu}_3(\text{CO}_3)_2(\text{OH})_2$)
 - chrysocolla, a hydrated copper silicate ($\text{CuSiO}_3 \cdot n\text{H}_2\text{O}$).

Lead

The most important lead mineral for the mining industry is galena (PbS), which can contain up to 1 % silver.

Nickel

Nickel (Ni) is a transition element that exhibits a mixture of ferrous and non-ferrous metal properties. It is both a siderophile (associates with iron) and a chalcophile (associates with sulphur). The bulk of mined nickel comes from two types of ore deposits:

- laterites, where the principal ore minerals are nickeliferous limonite ($(\text{Fe}, \text{Ni})\text{O}(\text{OH})$) and garnierite (a hydrous nickel silicate), or
- magmatic sulphide deposits, where the principal ore mineral is pentlandite ($(\text{Ni}, \text{Fe})_9\text{S}_8$).

The ionic radius of divalent nickel is close to that of divalent iron and magnesium, allowing the three elements to substitute for one another in the crystal lattices of some silicates and oxides. Nickel sulphide deposits are generally associated with iron- and magnesium-rich rocks called ultramafics and can be found in both volcanic and plutonic formations. Many of the sulphide deposits occur at great depth. Laterites are formed by the weathering of ultramafic rocks and are

a near-surface phenomenon. Most of the nickel on Earth is believed to be concentrated in the planet's core. [36, USGS, 2002]

Tin

The only mineral of commercial importance as a source of tin is cassiterite (SnO_2), although small quantities of tin are recovered from complex sulphides such as stanite, cylindrite, frankeite, canfieldite, and teallite. [36, USGS, 2002].

Zinc

Sphalerite (zinc iron sulphide, ZnS) is one of the principal ore minerals in the world.

Mining of primary sulphide ores dominates the base metal mining for Cu, Zn and Pb in Europe (Las Cruces, once in operation, will be an exception). The sulphide content and the grade of the value mineral vary significantly between the sites.

Some examples of different mineralogical characteristics found and different mining areas are described below.

- at the **Aitik** site, the contact between the main ore zone and the hanging wall is sharp, as the ore is bound in a thrustfault. The contact between the footwall and the ore zone is gradual and grade dependent. The main ore minerals are chalcopyrite, pyrite and pyrrhotite, which occur as dissemination and veinlet deposits. The footwall consists of biotite-amphibole gneiss and intrusions of quartz-monzodiorite (the footwall has less than 0.26 % Cu.) The main ore zone comprises biotite schist/gneiss and muscovite schist. The hanging wall consists of amphibole-biotite gneiss and pegmatite and is barren in copper. The value mineral in the orebody is chalcopyrite. The mean copper concentration in the ore is 0.4 %. Furthermore, the ore contains gold (0.2 g/t) and silver (3.5 g/t) [63, Base metals group, 2002]
- at the **Hitura** nickel mine, the ultramafic complex consists of three separate, closely-spaced serpentinite massives surrounded by magmatized mica gneiss. The main ore minerals are pentlandite, chalcopyrite and pyrrhotite, but in some places mackinawite, cubanite and vallerite are abundant. Pyrite occurs only in joints with [62, Himmi, 2002]
- at the **Las Cruces Project**, which is currently in the planning and permitting phase, the value mineral is chalcocite, a secondary sulphide copper mineral, in massive pyrite [67, IGME, 2002]
- in the **Legnica-Glogow copper basin** the copper ore occurs at depths from 600 to 1200 m in a 40 m thick bed-type polymetallic deposit, where aside from copper minerals other metals, such as silver, gold, platinum and palladium can be found. Ore minerals occur either in the sandstones of the 'Rotliegendes' or 'Weissliegendes' or in the copper-bearing shales and carbonate rocks of the Werra cyclothem, mainly in the dolomites. In this copper deposit in total over 110 ore minerals have been found. The main metalliferous minerals are chalcocite, bornite, chalcopirite, covellite, pyrite and galena. The distribution of mineralisation in the deposit is highly variable [113, S.A., 2002]
- at the **Lisheen** site, the sulphide mineralisation that forms the orebody occurs at the base of dolomitic limestone. The metalliferous minerals are pyrite, marcasite, sphalerite and galena, and, in smaller concentrations, chalcopyrite, tennantite, native silver, arsenopyrite and gersdorffite. The gangue material is dolomite together with barytes, calcite, shale, illite and quartz [75, Minorco Lisheen/Ivernia West, 1995]
- the ore at **Pyhäsalmi** is massive and coarse grained. The ore contains on average 75 % sulphides, made up of 3 % chalcopyrite, 4 % sphalerite, 2 % pyrrhotite and 66 % pyrite, plus minor amounts of galena and sulphosalts. Barytes and carbonates are the main gangue minerals [62, Himmi, 2002]
- the **Neves Corvo** site is a high-grade copper-tin mine in the Iberian Pyrite Belt. The dominant ore minerals in the volcanogenic massive sulphide-type orebody are pyrite chalcopyrite, sphalerite, galena, cassiterite, stannite, tetrahedrite and arsenopyrite [142, Borges, 2003].

Mining techniques

Both underground and open pit mines are represented in the base metal mining sector in Europe. The mining methods used underground are cut-and-fill, room-and-pillar and various other techniques. The ore production capacity in the underground mines is between 65000 and 1100000 tonnes/yr. In open pit mining, the production (ore and waste-rock) in 2001 was between 1200000 and 43700000 tonnes. In underground mining, almost all the waste-rock produced is directly used as backfill in the mine. In some cases, waste-rock was extracted from existing waste-rock dumps and transported under ground. In open pit mining, backfilling was not possible in the majority of the cases, however, at Mina Reocín a mined out part of an open pit was backfilled using waste-rock. Various mines and the mining techniques they apply as well as their ore and waste-rock production are listed in the table below.

Mining area	Mine	Mining method	Ore production (kt/yr)	Waste-rock deposition (kt/yr)
Aitik	Aitik Mine	Open pit	17700	26000 ⁴
Almagrera	Aguas Teñidas	Underground (cut and fill)	300	0 ¹
	Sotiel	Underground	700	0
Boliden Mining Area	Maurliden	Open pit	224.4	875.7
	Renström	Underground (cut and fill)	160.5	-104 [*]
	Petiknäs	Underground (cut and fill)	553	-15.7 [*]
	Åkerberg	Underground	32	-21 [*]
	Kristineberg	Underground (cut and fill)	503.6	4.6 ³
Cantabria	Mina Reocín	Open pit/Underground	1100	2500 ²
Garpenberg	Garpenberg Mine	Underground (cut-and-fill)	310	0
	Garpenberg Norra	Underground (cut and fill)	709	38.4 ⁵
Hitura	Hitura Mine	Underground (cut and fill)	518.3	0 ³
Legnica-Glogow copper basin	Lubin	Underground (room and pillar)	6808	0 ³
	Polkowice-Sieroszowice	Underground (room and pillar)	10436	0 ³
	Rudna	Underground (room and pillar)	11490	0 ³
Lisheen	Lisheen	Underground (cut and fill)	1110 ⁶	7
Pyhäsalmi	Pyhäsalmi	Underground (cut and fill)	1097.2	0 ³
	Mullikkoräme	Underground	64	0
Tara	Tara	Underground (blasthole open stoping) ⁷	2000 ⁷	
Zinkgruvan	Zinkgruvan	Underground (cut and fill)	850	0 ⁴

1. Waste-rock used in backfill + schists from borrow area
2. Waste-rock used to fill out mined out open pit.
3. Waste-rock used in backfill
4. 65 % deposited separately for alternative use
5. Used for dam construction
6. Source: [76, Irish EPA, 2001]
7. Source: [74, Outokumpu,]
*: A negative number indicates that waste-rock has been removed from existing deposits and brought underground for backfilling purposes.
Year 2000 figures for Almagrera, Mina Reocín, Pyhäsalmi and Hitura; year 2001 figures for the Aitik, Garpenberg and Boliden mining areas

Table 3.10: Information on mining technique, ore and waste-rock production of base metal mines

The **Aitik** site is a typical example of base metals open pit mining, incorporating the following operations:

Drilling: The drilling equipment consists of rotary drill rigs. The bench height is 15 m and subdrilling 3 m. The drilled burden and spacing are 8 m x 10.5 m. The diameter of the drillholes are approx. 300 mm. The rate of drilling is normally about 17 m/h, but in the hard parts of the ore it can be less than 10 m/h. Water is pumped from the open pit at 3 - 15 m³/min.

Charging and blasting: Emulsion explosive is pumped from a truck into the blast holes. Non-electric detonators are used for the initiation of the blast. The size of each round is about 600 kt and blasting takes place once a week. The benches are planned with a final pit slope angle of 47° in the footwall (following the foliation) and 51 - 56° in the hanging wall.

Loading and transportation: Three rope shovels and two hydraulic shovels are used. A wheel loader completes the loading fleet. The haulage is carried out by 17 trucks (172 t and 218 t trucks).

In-pit crushing: The ore is transported by trucks to the primary crushers in the pit, 165 m below the surface. The ore is loaded onto a conveyor belt from bins below the crusher. The conveyor belt takes the ore to the mineral processing plant. The inclination of the conveyor is 15°, the width 1800 mm and the capacity 4000 t/h. The total stockpile capacity at the surface is around 50000 t.

[63, Base metals group, 2002]

Both **Garpenberg** and **Garpenberg Norra** are underground mines. The techniques used in these mines are described here as examples of base metal underground mining.

The applied mining method is cut-and-fill. The coarse fraction of the tailings is used as backfill and as a platform when mining the ore above. At present, the ore is mined at a depth of between 400 and 870 m in the Garpenberg mine and between 700 and 990 m in Garpenberg Norra.

Blasting is done using emulsion explosives. Loading and hauling is carried out using diesel vehicles. The ore is crushed with an in-pit crusher before it is skipped through a shaft to the surface. A covered 500 m long conveyor belt transports the ore from the Garpenberg mine to the mineral processing plant. For the Garpenberg Norra mine, the ore has to be trucked approximately 2 km to the mineral processing plant.

[64, Base metals group, 2002]

At the Neves Corvo underground mine, four different mining methods are applied depending on the shape of the orebody. All mine voids are backfilled in order to maximise ore extraction and to reduce surface subsidy [142, Borges, 2003].

3.1.2.2 Mineral processing

In the processing of the primary sulphide ores all plants use similar processing techniques, namely:

- crushing;
- grinding
- flotation
- drying of concentrates.

Flotation can be carried in various ways, e.g., by selective flotation or by bulk/selective flotation, depending on the characteristics of the ore, the market demands, the cost of flotation additives, etc. Two possible options for the same mineral processing plant are illustrated in the figures below for the Zinkgruvan mineral processing plant.

The **Zinkgruvan** mineral processing plant, which was constructed in 1977, is located next to the mine. It operates continuously with an annual throughput of 850000 tonnes. The choice of process and technology is based on a large number of test works with the actual zinc and lead ore. Autogenous grinding in combination with bulk/selective flotation (see Figure 3.10 below) of the ore has been chosen as the main process technique and has been used at Zinkgruvan since 1977.

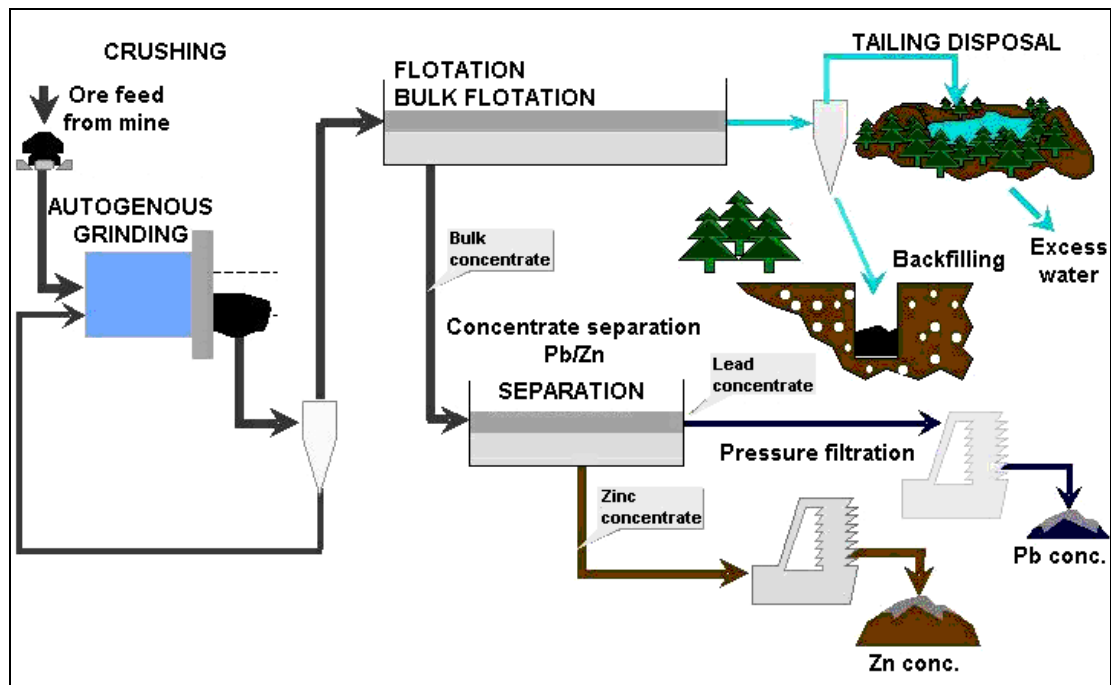

Figure 3.10: Bulk/selective flotation circuit for Zinkgruvan site [66, Base metals group, 2002]

An alternative flotation method, which could be used if there were changes in the ore composition, would be stepwise selective flotation (see Figure 3.11 below) This would require slightly different process chemicals but is otherwise similarly economical and technically feasible. [66, Base metals group, 2002]

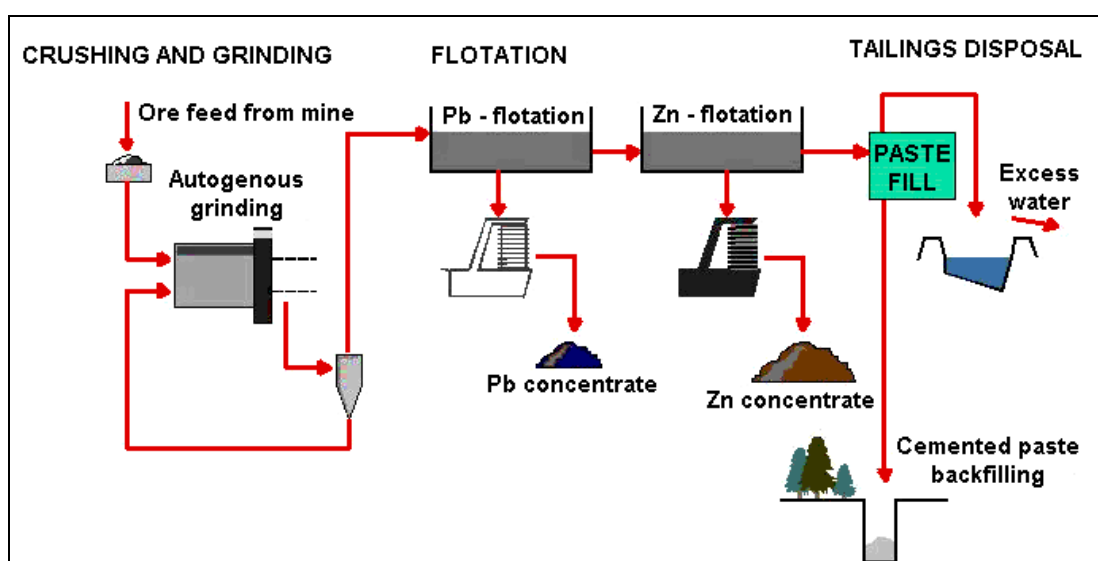

Figure 3.11: Possible selective mineral processing circuit for Zinkgruvan site [66, Base metals group, 2002]

The mineral processing set-up for the nickel ore at the **Hitura** site is similar to that for the sulphide ores as shown in the figure below.

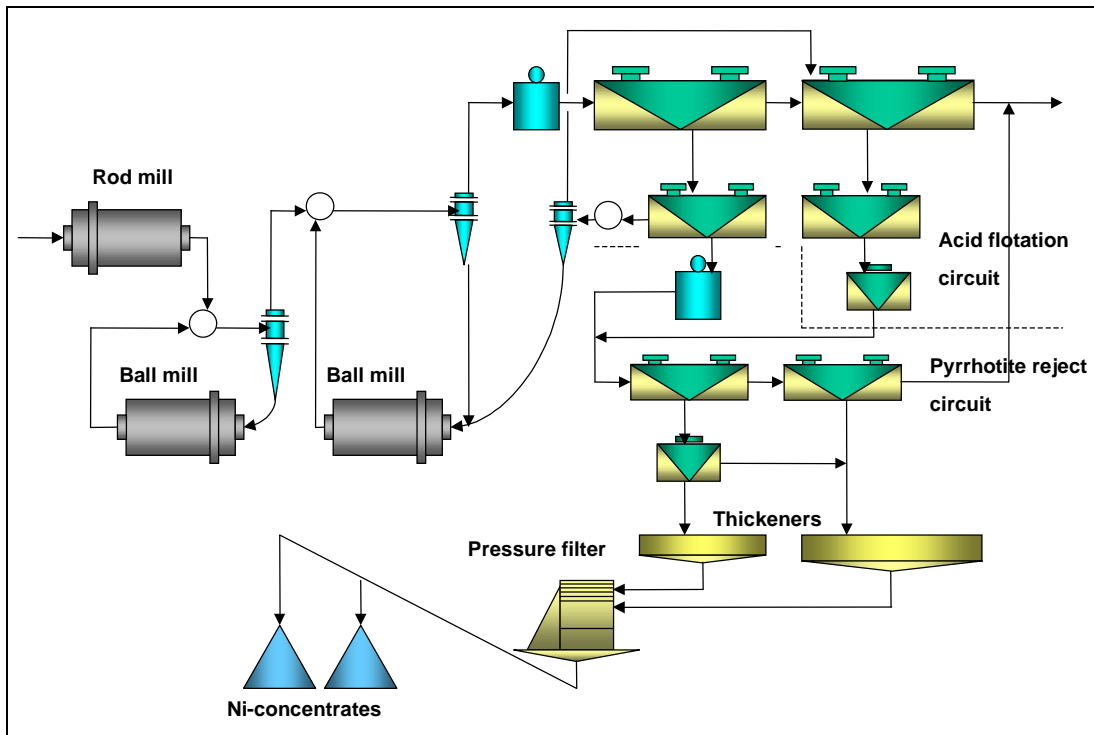

Figure 3.12: Mineral processing flow sheet at Hitura site
[62, Himmi, 2002]

In the **Las Cruces Project** leaching with sulphuric acid is the proposed process method followed by solvent extraction and electrowinning (SX-EW). Tailings will be dewatered using filtration and will be sent to ‘dry’ lined cells [67, IGME, 2002].

The ores extracted in the **Legnica-Glogow copper basin**, which vary in their lithological and mineralogical composition, are processed in three concentrators (Lubin, Polkowice and Rudna) with a total capacity of approx. 30 million t/yr. In this case, the separation technique most suitable to achieve a maximum recovery of copper and silver, is flotation. Two types of ore are processed: sandstone-carbonate in the Lubin and Rudna facilities, and dolomite-shale in the Polkowice facility.

At **Mina Reoc in**, a pre-concentration is done before grinding using gravimetric methods. Tailings are pumped as a slurry to the pond systems. The coarse fraction of the tailings, which is used in the backfilling, is separated from the fines using hydrocyclones [54, IGME, 2002].

3.1.2.2.1 Comminution

Size reduction at all sites is done by crushing and grinding using various types of crushers and mills.

At **Aitik**, two gyratory crushers are used for primary crushing. The intake opening of the crusher is 152 cm and the diameter of the inner surface at the bottom is 277 cm. The fragmentation of the crushed ore depends on the setting of the crusher but normally the width is set to 160 - 180 mm. The largest pieces are thus between 350 and 400 mm but variations occur caused by different ore characteristics. Each day 40000 to 60000 tonnes are crushed and fed to the grinding circuit. This consists of five milling lines, each made up of an AG mill followed by

a pebble mill. Each grinding circuit operates in closed circuit with a screw classifier, which feeds back material into the autogenous mill.

This site has several grinding sections, which are described below:

B-section, which comprises two 300 t/h mill lines, is the oldest primary grinding facility. All the mills are run at 75 % of critical speed. C-section is a single 460 t/h line. The AG and pebble mills are run at 76 % and 73 % of critical speed, respectively. D-section, another two 460 t/h lines both run at 75 % of critical speed.

Data B-section:

- two AG mills, 6 m diameter, 10.5 m long, installed power 3600 kW
- two pebble mills, 4.5 m diameter, 4.8 m long, installed power 1250 kW.

Data C section:

- one AG mill, 6.7 m diameter, 12.5 m long, installed power 6600 kW
- one pebble mill, 5.2 m diameter, 6.8 m long, installed power 2500 kW.

Data D-section:

- two AG mills, 6.7 m diameter, 12.5 m long, installed power 6000 kW.
- two pebble mills, 5.2 m diameter, 6.8 m long, installed power 3000 kW.

The total grinding capacity is about 50000 t/d, although the actual throughput depends on the grindability, or the hardness, of the ore. Energy consumption averages around 11 - 12 kWh/t. The grinding is done at 55 % by weight solid material. The finished ground product from the screw classifier has a d_{80} value of 180 μm and about 25 % are smaller than 45 μm . [63, Base metals group, 2002]

Ore delivered to the **Boliden** mineral processing plant arrives either crushed or uncrushed. A jaw crusher with an opening of 220 mm is installed to crush, if necessary, run-of-mine ore (mostly open pit ore). The size distribution of the ore varies from time to time, from very small rocks to rocks of 200 - 300 mm size. The size variation mainly depends on the ore type.

All ore is stored in four underground bins. Storage capacity varies between 1500 to 4500 tonnes of ore. The underground bins make it possible to blend ores if desired. Underground storage is beneficial during winter, as it minimises freezing problems. Ore from the bins is fed to the mineral processing plant by feeders and conveying belts.

The mineral processing plant uses autogenous grinding. The primary AG mill is followed by a pebble mill, which receives the grinding pebbles through a continuous draw from the output end of the primary mill. Between mills, magnetic separators are installed to clean the pulp of metal scrap from mines. The coarse material is sent back to the mills after screening and hydrocycloning. Both grinding circuits are equipped with Reichert cones, spirals and shaking tables for gravity separation of gold.

The throughput is between 92 and 110 tonnes per hour per circuit depending on the ore. Energy consumption is about 22 kWh/t. The grinding result varies between 50 - 80 % <45 μm . [65, Base metals group, 2002]

At the **Hitura** mineral processing plant size reduction is achieved via:

- crushing in three stages with a jaw crusher, a gyratory crusher and a cone crusher. The crushing circuit also includes a screen operating in an open circuit
- grinding in three stages with a rod mill ($\text{Ø } 3.2 \times 4.5 \text{ m}$) in the primary stage and two ball mills ($\text{Ø } 3.2 \times 4.5 \text{ m}$) in the following stages.

[62, Himmi, 2002]

The **Las Cruces** project proposes using:

- a primary jaw crusher
- secondary and tertiary cone crushers
- ball mills.

The predicted average grain size after comminution is 100 % $<100 \mu\text{m}$.

The first stage of crushing in the **Legnica-Glogow copper basin** is carried out underground. In three surface mineral processing plants the ore is first screened. The oversize is crushed in hammer or cone crushers. The screen underflow ground in two stages in rod mills and ball mills. The final grain sizes are as follows:

- in Lubin and Rudna mineral processing plants: 100 % $<0.3 \text{ mm}$ and 45 – 60 % $<45\mu\text{m}$
- in Polkowice mineral processing plant: 89 – 92 % $<45\mu\text{m}$.

At **Lisheen**, the ore is continuously fed from the surface stockpile into a grinding circuit. This consists of a SAG mill, a secondary ball mill, and closed circuit hydrocyclones [73, Ivernia West,].

At the **Neves Corvo** operation, the size reduction of the **copper circuit** is carried out by a primary crusher in the underground mine. Secondary crushing is carried out in the mineral processing plant via two hydroclones in a closed circuit with a screen (350 t/h capacity). Grinding is carried out in a rod mill (3.8 m x 5.5 m, 1600 kW) followed by two ball mills (4.1 m x 6.7 m, 1600 kW each) in closed circuit with hydrocyclones (230 t/h capacity). The feed to the flotation circuit has a d_{80} of 45 μm .

Size reduction for the **tin circuit** commences with the crushing section, which consists of an open circuit jaw crusher and 2 x 4.25 cone crushers, the second in a closed circuit with a 12-mm screen. The plant has a capacity of 80 t/h. The grinding circuit consists of a 3 m x 1.8 m rod mill in open circuit, followed by a 3 m x 1.8 m ball mill in closed circuit with a screen sieve, together providing a flotation feed with a d_{80} of 350 μm .

[142, Borges, 2003]

At the **Pyhäsalmi** mine, comminution is carried out by:

- one stage crushing with a jaw crusher located in the underground mine
- autogenous grinding in three stages (balls are used in the tertiary stage)
- in the grinding circuit five ball mills (3.2 x 4.5 m).

[62, Himmi, 2002]

At **Zinkgruvan** a primary crusher is situated underground. From a temporary storage at ground level, normally containing about 9000 tonnes, the ore is transported to the secondary crusher where two size fractions are produced:

- $>100 \text{ mm}$ as pebbles for the AG mill
- 25 – 100 mm is recycled
- $<25 \text{ mm}$ to AG mill.

An optimum mixture of the two size >100 mm and <25 mm fractions is then fed to the AG mills. Autogenous grinding is used to generate a product with 90 % <100 µm at 40 % solids. [66, Base metals group, 2002]

The above information on comminution is summarised in the following table.

	Aitik	Boliden	Hitura	Las Cruces	Legnica-Glogow	Lisheen	Pyhä-salmi	Zink-gruvan
Crushing in pit/ug	In-pit cone	Jaw	Jaw	Jaw	Ug crusher	Ug crusher	Ug jaw	Ug crusher
Crushing in mpp			Cone cone	Cone cone	Hammer cone			Sec crusher
Grinding	AG PM	AG PM	RM BM BM	BM	RM BM CM	SAG BM	3 stage AG BM	AG
Lines	5	2	1		29		1	1
Line capacity (t/h)	500	100	90		86 - 180		150	115
ug = underground jaw = jaw crusher cone = cone crusher mpp = mineral processing plant AG = autogenous grinding mill RM = rod mill BM = ball mill CM = cylpeps mill PM = pebble mill SAG = semi-autogenous grinding mill								

Table 3.11: Equipment types used for comminution, number of lines and throughput

3.1.2.2.2 Separation

At **Aitik**, the flotation is divided into two steps, one circuit for bulk flotation and one cleaning circuit. The bulk flotation consists of four parallel lines of nine mechanical flotation cells in each line. The cleaning step consists of four flotation and 16 mechanical flotation cells.

The feed pulp is conditioned with frothers and collectors and the pH-value is raised to 10.5 by adding lime. In the bulk flotation chalcopyrite and pyrite are floated together. Each flotation line is divided into two steps, where the first four cells are used for rougher flotation and the last five as scavengers. In the rougher flotation a bulk concentrate is achieved with 10 - 15 % Cu. The rougher concentrate from the four lines is fed to the cleaning circuit. The scavenger concentrate (1.3 % Cu) is reground in a pebble mill.

In the cleaning circuit, the chalcopyrite is separated from the pyrite after regrinding and further addition of lime. The rougher concentrate, together with returned products from the separation circuit, is reground in a ball mill in closed circuit with hydrocyclones. The cyclone overflow flows to the columns. The concentrate from column one and two normally holds 20 - 25 % Cu and is mixed together for cleaning in two steps in small mechanical cells. The final concentrate contains 28.8 % Cu, 8 g/t Au and 250 g/t Ag. The concentrate is dewatered with a continuous thickener, drum filters and oil-fired rotating kilns. Dried concentrate is shipped in containers by truck 20 km to the railroad and then by rail 400 km to the smelter.

The mineral processing plant runs on 100 % re-circulated water from the tailings pond system and recovers 90 % of the copper, 50 % of the gold and 70 % of the silver. It is equipped with a distributed control system and an on-line analysis system. [63, Base metals group, 2002]

At **Hitura** mine the separation is done by flotation. All flotation machines are mechanical. An automatic process control system with two on-line x-ray analysers (six slurry lines) is also installed.

Dewatering is carried out using two continuous thickeners for Ni-conc. (\varnothing 25 m + \varnothing 10 m) and a pressure filter (25 m²).

The reagents added to the process at Hitura are:

- grinding: Sodium Ethyl Xanthate (SEX)
- flotation: H₂SO₄, SEX, frother, carboxymethylcellulose (CMC), lime (cleaning).

[62, Himmi, 2002]

At the **Las Cruces Project** it is proposed to use pressurised leaching with sulphuric acid followed by Solvent Extraction and Electro-Winning (SX-EW) to recover the copper [67, IGME, 2002].

At the mineral processing plant treating the ore from the **Legnica-Glogow copper basin** the flotation process is performed in three stages: rougher, scavenger and cleaner. Additionally so called 'flash flotation' (or skimmer) has been introduced, at the initial grinding and classification stage at the Polkowice and Lubin plants. The concentrate from flash flotation contains 30 – 45 % Cu). At the Rudna plant flash flotation is currently being introduced to replace the rougher flotation.

In all three plants the water consumption is 4.5-5.2 m/t ore.

As collectors, a mixture of Sodium Ethyl Xanthate (SEX), Sodium Isobutyl Xanthate (SIBX) and hostafloc LET (salt of sodium diethylene dithiophosphoric acid) are consumed at a level of 50 – 68 g/t ore. Carfloc (a mixture of buthyl ethers and di-, tri-, and tetra-ethylene glycols) is used as a frother (consumption: 22 g/t ore). The pH is neutral (7-8), neither milk of lime, nor any polyelectrolytes are added.

The process is controlled continuously by X-ray analysers.

The recovery level is 87 – 90 % for copper and 83 – 87 % for silver. The final concentrate contains:

- 18 % Cu and 1000 ppm Ag (from Lubin)
- 27.2 % Cu and 480 ppm Ag (from Polkowice)
- 30.5 % Cu and 640 ppm Ag (from Rudna).

The concentrate is dewatered in thickeners, filtration presses (up to 12 – 14 % moisture content) and gas fired drum dryers (up to 8.5 % moisture content) before it is sent to the smelters.

[113, S.A., 2002]

At **Lisheen**, the ground ore is fed into a lead circuit, and then into a zinc circuit. The lead and the zinc circuit use mechanical flotation cells while the zinc circuit also uses flotation columns. The zinc circuit utilises a regrind step to assist in the production of a high-grade concentrate and to maximise metal recovery and an acid leach circuit is also added to ensure low levels of magnesium oxide in the concentrate [73, Ivernia West,]. Process water is recycled and supplemented with water reclaimed from the TMF.

The **copper separation at Neves Corvo** is achieved by flotation. The tin separation is carried out by gravity separation on Holman-Wilfley shaking tables and subsequently by cassiterite flotation [142, Borges, 2003].

At the **Pyhäsalmi** mine the separation is done using a flotation circuit composed of Cu-, Zn and finally Pyrite flotation. All flotation cells are mechanical type.

Backfilling material (coarse fraction of the tailings) is separated from the fine tailings in a hydrocyclone (\varnothing 500 mm) before pumping the fines to the tailings pond.

Reagents added to the process are:

- grinding: lime, ZnSO₄, Sodium isobutyl xanthate (SIBX), frother
- Cu-flot.: lime, ZnSO₄, SIBX, frother, NaCN
- Zn-flot.: lime, CuSO₄, SIBX, frother, NaCN (cleaning)
- Pyrite-flot.: H₂SO₄, SIBX
- dewatering: flocculant (thickeners), HNO₃, CH₃COOH (filters)
- tailings: lime (neutralisation).

[62, Himmi, 2002]

At **Tara**, sphalerite and galena are selectively floated while pyrite is depressed. Selective removal of galena is enhanced by the collector Sodium Isopropyl Xanthate SIPX. MIBC is added as a frother. During galena flotation sphalerite and pyrite are depressed with quebracho tannin, lignossal, starch and sodium cyanide. In the subsequent flotation of sphalerite, copper sulphate and calcium oxide are added to reactivate the sphalerite and to increase pH. Thiocarbonate and Potassium Amyl Xanthate (PAX) are used as collectors and MIBC as the frother. [101, Tara mines, 1999]

At **Zinkgruvan** the flotation process is done in two steps, as above, with bulk flotation followed by zinc and lead separation. In the bulk flotation sulphuric acid is added in order to lower pH to approx. 8 from its natural level of approx. 9. As collector for the desired minerals (galena and sphalerite) sodiumisopropylxanthate (SIBX) is used, together with methylisobutylcarbinol (MIBC) as frothing agent. In the bulk flotation circuit separate regrinding is done to improve the purity of the concentrate. The bulk concentrate recovers 98 %, 95 % and 85 % of the total ore content of zinc, lead and silver respectively.

Sodium hydroxide is added to the zinc/lead separation step to increase pH to about 12. The zinc concentrate is directly produced, whilst the lead concentrate requires additional flotation in multiple steps in order to achieve the final lead concentrate.

[66, Base metals group, 2002]

3.1.2.3 Tailings management

Tailings are used in the backfill of most underground operations. At these sites 16 – 52 % of the tailings are backfilled. One site, **Mina Reocín**, backfills an old open pit using 94 % of the tailings. The tailings that are not used for backfilling need to be managed in ponds. For the **Las Cruces project**, it is proposed to deposit dewatered tailings in lined cells. At **Almagrera** the coarse fraction of the tailings (33 %) is roasted and sulphuric acid is produced. The cinders are then leached and copper extracted in an SX-EW process. The cinders are deposited in a cinders dam. The remaining 2/3 of the tailings are deposited into a tailings pond.

Tailings production and the percentage of backfilled tailings at the various mineral processing plants is summarised in the table below.

Site	Mining method	Tailings production (t/yr)	Tailings used in backfill (%)
Aitik	Open pit	17700000	0
Almagrera	Underground	900000	0
Boliden Mining Area	Open pit/underground	1457000	29
Garpenberg	Underground	910000	50
Hitura	Underground	518331	0
Legnica-Glogow copper basin	Underground	27000000	0
Lisheen	Underground	910000	50
Mina Reocín	Open pit/underground	950000	94
Neves Corvo	Undergrounde	1370000	30
Pyhäsalmi	Underground	213816	16
Tara	Underground	1680000	52
Zinkgruvan	Underground	850000	50

Table 3.12: Per cent of tailings backfilled at base metal operations

Almagrera uses waste-rock and rock from quarrying (schist) in the backfill and not tailings. **Mina Reocín** fills out a mined out open pit, which explains the high backfill percentage. **Zinkgruvan** and **Garpenberg** run backfilling operations which utilise 45 – 50 % of the tailings in the backfill. The **Boliden Mining Area** received ore from one open pit and a series of underground mines. If the ore from the open pit is subtracted from the tailings production the percentage of backfilled tailings is 34 %. This value is misleading since during year 2001 large quantities of waste-rock were brought back underground at Renström, Petiknäs and Åkerberg mines (a total of 140000 tonnes of waste-rock was brought back underground during 2001).

Base metal ores usually contain several metalliferous minerals. Often copper, lead and zinc are mined together. Typically base metals are mined as sulphides. Hence, acid rock drainage is a major issue in the management of tailings and waste-rock. Long-term chemical stability is, therefore, a challenge. The tailings are in the form of a slurry and the ponds and dams can be of large dimensions.

A suite of metalliferous complexes and process chemicals are included in the tailings slurry. Hence physical stability is also of major importance for this sector.

3.1.2.3.1 Characteristics of tailings

At **Almagrera**, there are two types of tailings. The fine fraction of the tailings and the cinders resulting from the roasting and leaching of the coarse fraction of the tailings. The tailings are mainly pyrite and ARD generating. The cinders are easily leached with water. The tailings have a 66 % solids content and the compact density of the tailings material is 4.0 t/m³ (mainly pyrite). Upon discharge into the tailings pond, the tailings have an initial pH of approximately 9 but pH in the pond is around 3.2.

At **Aitik**, the main issue for the closure and decommissioning plans for the tailings pond is the possible acid generating potential. Due to an early assumption that the material would produce ARD, a number of options to change the composition of the material have been investigated. In its crude form, the tailings have an ABA value of -13 kg CaCO₃/t, determined by the pyrite content (0.9 % S). Flotation tests and sampling of various products in the mineral processing plant have yielded a range of samples with sulphur contents ranging from 0.12 % for de-pyritised tailings to 31 % for the pyrite flotation product. These samples have been subjected to humidity cell tests in different campaigns.

The results from the kinetic tests and modelling indicate that the silicates in the tailings constitute a substantial acid consuming capacity. More important, however, is the sulphide oxidation rate in the field. The dissolution of silicates is capable of consuming the acid produced by pyrite oxidation in the tailings up to a certain rate. Below that rate, the carbonates are slowly consumed, but above that rate, the carbonates are slowly depleted, after which the silicates alone are unable to neutralise the acid generated.

Field oxygen flux measurements have been carried out to illustrate the material's behaviour in field scale. The results indicate acid production will take place, corresponding to the silicate acid consumption capacity of only the top 20 cm layer of tailings. In lower strata, no acid will be produced, indicating a vast excess of buffering capacity.

In Aitik, where frost conditions prevail for seven months of the year, the kinetics differ significantly from the conditions in the laboratory and during the actual field test. To verify that the tailings do not possess ARD capabilities, column tests have also been carried out, under conditions which are representative for the unfrozen period at Aitik. In this test, the measured oxygen consumption rate was 50 % below the lowest oxygen consumption rate calculated from the sulphate export in the humidity cell experiments.

Parallel to these tests, hydrogeological modelling of the groundwater flow within the pond have shown that over 90 % of the volume will be permanently water saturated, which is technically equal to sub-aqueous tailings management. Only minor areas at the upstream and downstream dams may become unsaturated at times. To address the situation, a solution has been derived suggesting a wetland be established in the lower parts of the tailings pond. Unsaturated areas in the lower parts of the pond would then be avoided, leaving the problem with only a small fraction of the total tailings, at the upstream dam, unresolved at present.

A possible solution for the remaining, upper part of the pond, is pyrite separation and selective management of pyrite (de-pyritisation). Such a solution, however, does not eliminate possible problems, it only concentrates the pyrite into a high-potential acid generating material. This requires a technical solution which is of high quality and low risk. Such a solution could be deposition of this material in the bottom of the mined out open pit upon closure, whereby it would then remain permanently covered by water.

[63, Base metals group, 2002]

The **Boliden** mining area consists of complex sulphide mineralisations. Mining in the area started in 1925 and, to date, approximately 30 mines have been exploited in the area. The tailings in the pond consequently have variable chemical characterisations and physico-chemical properties. The characteristics of the tailings produced today are summarised in the tables below. The fine fraction after cycloning is deposited to the tailings pond and the coarse fraction is used as backfill in the underground mines.

Size µm	Total tailings Cumulative % passing	Hydrocyclone overflow to pond Cumulative % passing
350	100	100
250	99.9	100
180	99.7	100
125	97.8	100
88	93.5	95.6
63	85.9	87.8
45	76.6	78.3
20	53.2	54.4
-20	0	0

Table 3.13: Particle size distribution of tailings at the Boliden site
[65, Base metals group, 2002]

The tailings have the following composition before cycloning and CN leaching:

- Au: 0.85 g/t
- Ag: 24.9 g/t
- Cu: 0.10 %
- Zn: 0.40 %
- Pb: 0.13 %
- S: 17.8 %

More than 50 % of the tailings consist of particles less than 2 μm . The tailings slurry pumped to the tailings pond contains 20 - 25 % solids. The density of the tailings, as placed in the pond, is 1.45 t/m^3 .

[65, Base metals group, 2002]

At **Mina Reocín**, the tailings are in the form of a slurry, a mixture of water and dolomite, with 65 % solids content and with a solids density of 2.75 t/m^3 . The tailings are alkaline at the time of discharge (pH 6.5 to 8) and are reported to be easily compactable and not reactive (due to their alkaline nature).

At **Garpenberg**, the tailings were investigated with regard to composition and weathering characteristics. The methods used were mineralogical investigations, full rock analysis, Acid Base Accounting (ABA) and kinetic weathering tests (extended humidity cell tests conducted between 1995 and 1999) in combination with predictive modelling. All results show that the tailings will not produce ARD. The metal concentrations in the pore water of the tailings will have limited solubility at the naturally high pH within the pond even if the tailings are allowed to weather with full access to atmospheric oxygen. The metals mobilised by sulphide oxidation at the surface of the tailings will be immobilised by absorption and precipitation as they are transported through the tailings. Based on these results, it was concluded that no measures were necessary in order to limit the mobilisation of metals by weathering from the deposit at closure.

The tailings presently produced show large variations in mineralogy as other parts of the orebody are mined with higher sulphide content, primarily higher content of pyrrhotite (FeS). According to sampling and analysis done during 2001, it is predicted that these 'new' tailings will produce ARD (see the detailed analysis in the table below).

Following the development of the weathering, characteristics of the tailings is considered important, even though the planned decommissioning method (flooding) is well suited for potentially ARD producing tailings. Therefore, sampling and testing of the tailings will continue in the future. [64, Base metals group, 2002]

Element	Concentration (mg/kg)
As	56.3
Ba	338.8
Be	0.45
Ca	30933
Cd	18.6
Co	6.1
Cr	3.2
Cu	317.7
Fe	65533
Li	4.6
Mn	4163
Mo	2.9
Ni	7.8
P	149
Pb	4011
S	44600
Sn	<5
Sr	19.6
V	9.5
Zn	7051

Table 3.14: Average results of tailings analysis at the Garpenberg site (2001)
[64, Base metals group, 2002]

Some of the key information regarding the tailings deposited in the tailings pond can be listed as follows:

- 500000 tonnes of tailings/yr
- discharged into the pond at 20 % solids
- typical particle size distribution (% passing) ($d_{50} = 20 \mu\text{m}$, $d_{80} = 64 \mu\text{m}$).

Size (μm)	Cumulative % passing
500	100
350	99.8
250	99.7
180	99.4
125	97.5
90	93.3
63	79.1
45	68.1
20	50.8
10	31.6

Table 3.15: Size distribution of tailings at the Garpenberg site
[64, Base metals group, 2002]

Some of the key information regarding the tailings used as backfill at the Garpenberg are:

- 450000 tonnes of backfill/ year
- 80 - 85 % solids.

Size (µm)	Cumulative % passing
250	96.6
180	86.8
90	46.4
45	18.8

Table 3.16: Typical size distribution of backfilled tailings at Garpenberg site [64, Base metals group, 2002]

At the **Hitura** site the same tailings examinations as at Pyhäsalmi have been performed. The most significant problems with the tailings are the contents of Cu and Ni. The tailings will not produce ARD because the buffering capacity of the tailings is higher than the acid formation potential. The particle size distribution of the tailings is 60 % <74 µm. [62, Himmi, 2002]

For the **Las Cruces Project** the tailings generated during the estimated lifetime of the project will amount to approximately 4 Mm³ (or 15 million tonnes). The tailings are pyritic and are predicted to be ARD generating. The average grain size is estimated to be 100 µm. The tailings will be deposited 'dry' after dewatering, with a moisture content of approx. 7 - 8 [67, IGME, 2002].

At the **Legnica-Glogow copper basin** the tailings from all three mineral processing plants are pumped to a single tailings pond at 14-20 % solids. The composition and particle size distribution are shown in the following tables.

Element/ compound	Unit	Mineral processing plant		
		Lubin	Rudna	Polkowice
Cu	%	0.16	0.21	0.26
Pb	%	0.06	0.04	0.026
Zn	%	0.007	0.006	0.004
Fe	%	0.57	0.54	0.48
S (total)	%	0.27	1.12	0.66
S (s ²⁻)	%	0.15	1.01	0.12
C (total)	%	2.80	4.14	9.26
C (organic)	%	0.48	0.32	0.54
SiO ₂	%	68.03	53.05	18.42
CaO	%	5.43	12.14	26.25
MgO	%	3.15	5.72	6.88
Al ₂ O ₃	%	3.09	4.11	4.58
Mn	%	0.094	0.153	0.190
Na	%	0.26	0.40	0.40
K	%	1.23	1.20	1.17
As	g/t	71	10	37
Ag	g/t	13	7	6
Co	g/t	39	10	21
Ni	g/t	27	16	42
V	g/t	72	38	110
Mo	g/t	15	12	8
Au	g/t	0.002	0.006	0.008

Table 3.17: Chemical analysis of tailings from the Legnica-Glogow copper basin [113, S.A., 2002]

Tailings type:	Particle size		
	>0.1 mm (%)	0.1 - 0.045 mm (%)	<0.045 mm (%)
Sandstone-carbonate ore (processed at Lubin and Rudna)	27 - 36	16 - 35	40 - 60
Dolomite-shale ore (processed at Polkowice)	-	8 - 11	89 - 92

Table 3.18: Particle size distribution of tailings from the Legnica-Glogow copper basin [113, S.A., 2002]

As the tailings have a low concentration of sulphur ($S^{2-} < 1\%$) and a high concentration of buffering carbonates (20 – 80 %), no ARD has occurred so far or is bound to occur in the future. [113, S.A., 2002]

The tailings are delivered to the TMF at **Lisheen** with about 35 % solids and contain zinc, lead, some process reagents and metal salts that have a grain size of 80 % $< 95 \mu\text{m}$. The density of the tailings on a dry basis is 3.5 g/cm^2 . The in-situ density is about 1.7 g/cm^2 . ABA was performed at the permitting state and the tailings are predicted to be acid generating [75, Minorco Lisheen/Ivernia West, 1995].

The tailings at Neves Corvo are relatively fine, with a d_{80} of 30 – 40 μm . The following table shows the minerals present in the tailings:

Mineral	Weight-%
Pyrite (FeS_2)	84 – 90
Arsenopyrite (FeAsS)	3 – 7
Chalcopyrite (CuFeS_2)	1.5 – 2.5
Sphalerite (ZnS)	1.0 – 2.5
Tetraedrite, Tenandrite ($(\text{Cu, Fe})_{12}(\text{Sb, As})_4\text{S}_{13}$)	1 – 2
Non-metallic minerals	8 – 12
Others	1 – 2

Table 3.19: Mineralogical composition of tailings at the Neves Corvo site [142, Borges, 2003]

The tailings have a high acid generating potential (AP: 910 kg CaCO_3 /tonne). It is expected that throughout the lifetime of the mine a total of 42 million tonnes of tailings will be generated, of which 14 million tonnes will be backfilled. [142, Borges, 2003]

At **Pyhäsalmi**, the chemical composition and leaching behaviour (max. solubility/DIN 38614-S4 by Kuryk's method and long-term behaviour) of the tailings have been determined in laboratory scale simulation tests. Neutralisation capacity vs. acid formation potential of material has been investigated. Also wind erosion tests have been done on laboratory scale. The most significant problems are the contents of heavy metals (As, Cd, Cu, Pb, Zn) and sulphur, resulting in an ARD generating potential. Alternative processing methods to change the characteristics of tailings have been considered. One example is the selective flotation of pyrite in the tailings to achieve a final S-content of less than 1 %. This is technically possible, but in this case economically not viable. The process would generate a product (pyrite) that is impossible to sell and that requires special techniques and arrangements for its deposit or destruction.

Mixing of peat with the tailings when it is pumped to tailings area to create reducing conditions has also been investigated. The test was stopped because of technical difficulties, but the intention is to continue the investigation on a laboratory scale. The down side of this technique is the fact that a natural resource is 'consumed'.

The particle size distribution of tailings material is 65 % <74 μm . [62, Himmi, 2002]

The sphalerite concentrate at **Tara** is washed with sulphuric acid to remove dolomite ($\text{CaCO}_3 \cdot \text{MgCO}_3$). This treatment precipitates magnesium and calcium sulphates, which are added to the tailings stream. The tailings slurry also includes collectors, suppressants and MIBC. [101, Tara mines, 1999]

At **Zinkgruvan** the tailings mainly contain quartz, feldspar and calcite. Small quantities of sulphides are also present (sulphur content <0.25 %). The calcium content is approximately 8 %. The ratio between sulphur and calcite is <0.1 suggesting that the tailings are well buffered and will not produce ARD. Weathering tests have also shown that the tailings have a low weathering rate. The composition of the tailings is given in the table below.

Mineral	Weight %
SiO_2	62.4
TiO_2	0.3
Al_2O_3	11.8
Fe_2O_3	0.6
FeO	2.9
MnO	0.7
MgO	2.2
CaO	7.0
BaO	0.01
Na_2O	0.6
K_2O	4.9
$\text{H}_2\text{O}^{110-350}$	0.1
CO_2	2.1
B_2O_3	0.1
FeS	0.5
ZnS	0.2
PbS	0.1
Other minerals	3.3
TOTAL	100

Table 3.20: Chemical analysis of tailings at the Zinkgruvan site
[66, Base metals group, 2002]

Once settled in the pond the tailings have an in-situ permeability of 10^{-5} - 10^{-6} m/s and an in-situ density of 1.35 - 1.45 t/m^3 .

3.1.2.3.2 Applied management methods

At **Aitik**, the tailings are pumped to a 14 km^2 (7 km x 2 km) tailings pond. Four pipelines (rubber lined steel pipes) are used for this purpose, although normally only two are in use at any one time. All four lines are equipped with five pumps in series. The total installed power for each line is 2000 kW. The water from the tailings pond feeds into a clean water clarification pond.

The tailings pond is limited by the topography (valley-site type) and four dams, see figure below. The tailings are pumped as a slurry to the discharge area along dam A-B. There the spigotting leads to an accumulation of the coarser particles close to the dam A-B, while the finer fractions successively settle along the pond towards the downstream dam, where separated water is collected. The active water volume in the tailings pond is normally about 2 Mm^3 , which occupies about 1/5 of the pond's surface area. The water is discharged using a spillway and a steel lined culvert located at the contact between the dam and the valley side. In the future, a system of open channels in undisturbed ground will be used for discharging the water, eliminating the culvert through the dam.

The clarification pond is located west of the tailings pond, downstream dam E-F and the E-F dam extension. The pond's area is 1.6 km² and the holding capacity is about 15 Mm³. This pond serves as:

- the final treatment step for the process water
- a reservoir for process water
- and as a buffer water for spring snowmelt and precipitation events.

The freezing of the process water during winter is a climatic effect that is of particular importance for the water balance. At excessive precipitation and snowmelt, water is discharged from the pond to the receiving streams. Also, when necessary, discharge of water is possible from the recycling water channel.

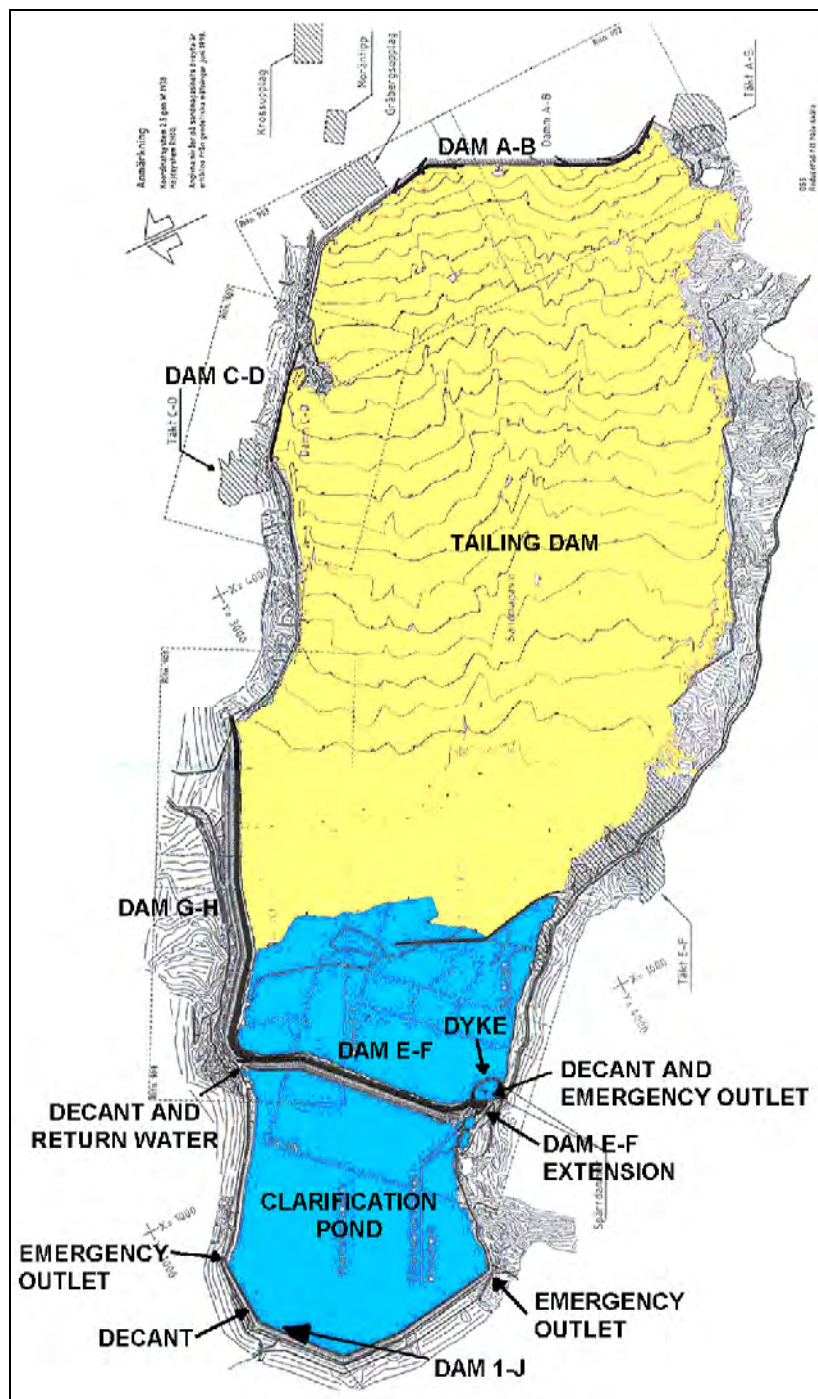

Figure 3.13: Year 2000 situation of Aitik tailings and clarification ponds [63, Base metals group, 2002]

The non-permeable dams surrounding the pond were constructed starting in 1966 and have since been raised mainly applying the upstream method (see figure below). Each raise has been of about 3 m. The material used for the raises have been till for sealing cores and waste-rock for the support fill. For the construction of the E-F dam extension, which started in 1991, the downstream method was used, with the crest of the dam moving outwards from the pond.

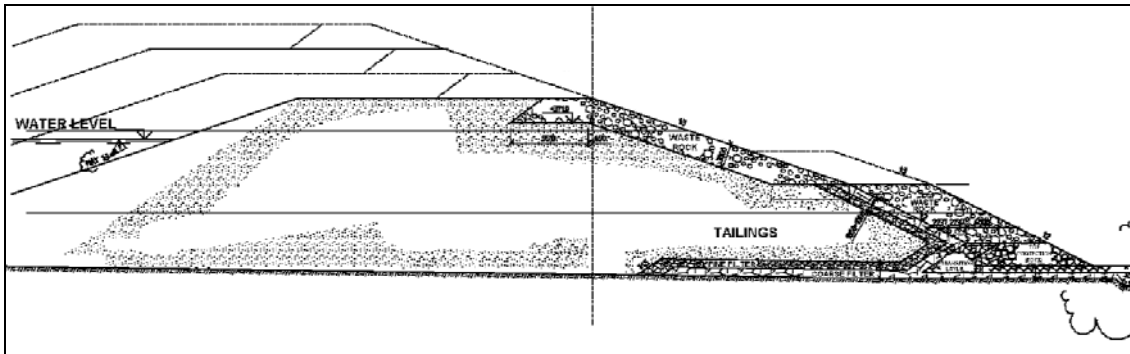

Figure 3.14: Cross-section of dam at Aitik
[63, Base metals group, 2002]

At **Almagrera**, the coarse fraction of the tailings (33 % or 300000 t/yr) are roasted and sulphuric acid is produced. The cinders are then leached with sulphuric acid and copper extracted in a SX-EW process. The cinders are deposited in a cinders pond. The remaining 66 % of the tailings (600000 tonnes fines) are deposited into a tailings pond. The dam is constructed without utilising liners. It is an earth dam with a core of compacted clay. The volume of the dam is 3.2 Mm³. Leakage through the dam is back pumped into the pond. Clarified water is pumped to a water treatment plant (liming) and treated before discharge. The emergency outlet is constructed in natural bedrock.

The cinders are deposited in a cinders dam.
[61, IGME, 2002]

The tailings management at the **Boliden** area is described in the Section 3.1.6.3.

At **Mina Reocín**, 94 % (900000 out of 950000 t/yr) of the coarse tailings, which are filtered to 15 % moisture content, are used to backfill an old open pit. The remaining 50000 t/yr are deposited in a tailings pond due to the limited filter capacity,. The capacity of the pond is 2.6 Mm³ and it currently contains approximately 2.5 Mm³ of tailings. The dams are constructed of borrow material. The pond is built on top of natural soil. The decant water is discharged to the recipient after having passed a series of clarification ponds. No water is recycled back to the mineral processing plant. 100 % of the required 2.2 Mm³ of process water are pumped from the mine [54, IGME, 2002].

All mining voids (or openings) created at **Garpenberg** are backfilled with waste-rock from development works and tailings. The concentrates constitute about 10 % of the ore processed which means that the other 90 % become tailings. 50 % of the tailings are used for backfilling. When the ore is blasted, crushed and ground, the volume increases by about 60 %, which means that the volume of tailings in Garpenberg is about 145 % of the volume of mined ore. There are no possibilities to backfill more tailings underground due to geometric reasons.

The tailings are cycloned in order to separate fine and coarse particles. The coarse particles are filtered to remove water and to allow transport by trucks. At one mine they are also mixed with cement to stabilise the backfill. After mixing with water, the cemented backfill is transported hydraulically to mined-out areas of the mine and excess water is removed by a draining system.

The tailings pond presently used in the Garpenberg area is located approximately 2 km south-west of the mineral processing plant. Before applying for the latest permit to increase the height of the tailings pond, various alternative tailings management methods were investigated, such as:

- thickened tailings and
- sub-aqueous discharge into a lake.

These alternatives were rejected because of the high cost (thickened tailings) and the public opinion against sub-aqueous deposition.

The presently active part of the tailings pond covers approximately 35 ha. The lifetime of the pond depends on the tailings production rate but is approximately 8 years assuming the present production rate. The tailings have an effective density of 1.5 t/m^3 . Currently, the dam is raised using the downstream method (see figure below). [64, Base metals group, 2002]

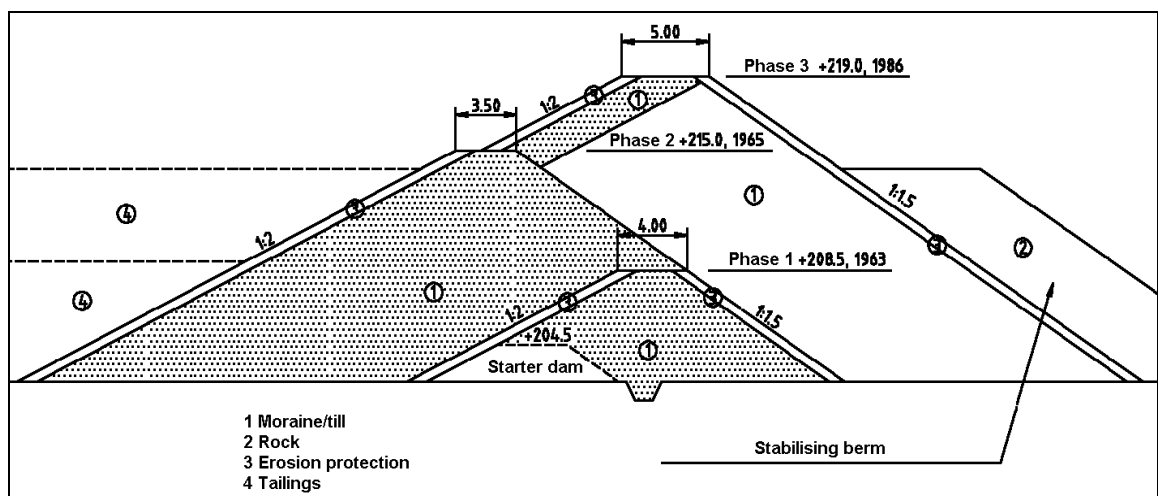

Figure 3.15: Cross-section of dam at Garpenberg before latest raise [64, Base metals group, 2002]

The operator did some analysis on the potential of used the centreline method and found that this would result in:

- lower operating costs
- the use of less construction material and
- at the same time still fulfilling the stability requirements.

Hence an application to the authorities has been filed asking for a permit for raising the dam using the centreline method.

The water discharge from the pond in 2001 was 4.55 Mm^3 . Of this 50 % was re-used in the mineral processing plant. The remaining 50 % was discharged to surface waters. The catchment area for the tailings pond is 1.56 km^2 .

[64, Base metals group, 2002]

At **Hitura**, the tailings area, 110 ha in total, is divided into three ponds. The tailings (480000 tonnes in 2000) are discharged into the first pond. The two others are clarification ponds. The solids settle in the first pond and the clarified water is decanted via a tower and led to the next pond from the central part of the tailings pond. Clarified water is re-used in the mineral processing. Only the excess water is fed to the river system. The tailings pond is off-valley-site type. The starter dams are made of moraine. The tailings are distributed with spigots. The dams are raised every 12 to 15 months using tailings.

The dams of the clarification ponds are made of moraine and are lined with coarse gravel to prevent erosion. The distance from the mineral processing plant to the TMF is about 500 m. The distance from the tailings area to the nearest river is about 3 km.

Problems with seepage of water from the tailings pond into the groundwater exist. Groundwater and seepage water are pumped into the pond in order to control the groundwater flow and to minimise any impact.

The annual rainfall in Hitura is about 550 mm. The mean temperature during a year is 1 – 3 °C. The maximum temperature in summer is 30 °C and the minimum temperature in winter is – 35 °C. During five months in a year the temperature is under zero and during six months above zero.

Before construction of the tailings management area, the soil was investigated, but apparently not carefully enough, as in one location infiltration to groundwater occurs. The affected groundwater is monitored in groundwater monitoring wells located downstream of the tailings pond and the back-pumped water is sampled.

[62, Himmi, 2002]

In the **Legnica-Glogow copper basin**, the mining of copper ore began in 1967. All of the tailings, which constitute 93 – 94 % of the extracted ore, have since been stored in tailings ponds, which have been raised using the upstream method. From 1968 until 1980, the first tailings pond of 600 ha, built upstream, was in operation and 93 million tonnes of tailings were stored there. This pond was decommissioned in 1980. It is assumed that this closure may be temporary and that in the future it may be brought back into operation again as spare capacity.

Since 1977 a new tailings pond of 1450 ha has been in operation. Similar to the previous pond it receives tailings from all three mineral processing plants. As all three mines are situated in an inhabited area and the distances between the mines is no further than 20 km, it was decided to find a topographically suitable area and convert it into a tailings pond which could serve all mines. An advantage of this set-up is that it takes into account the different characteristics of the tailings. For example, tailings from the Lubin and Rudna mines are coarse, whilst those from the Polkowice mine are fine, so it is possible to utilise coarse tailings for the dam construction and fine tailings for sealing the bottom of the tailings pond.

The tailings are transported into the tailings pond by pipeline, as a slurry of 14 – 20 % solids. The option to pump thickened tailings was considered in 2001, but the idea was rejected due to economic reasons, especially the capital cost of changing the existing system. The length of the current transport routes from the three mineral processing plants are between 6 and 9 km.

The total amount of tailings stored in the currently operated tailings ponds at the end of 2001 was 550 million tonnes.

Tailings are not utilised as backfill. The coarse fractions which technically match hydraulic backfill standards are required for dam construction. The fine tailings could only be utilised in paste form, which would currently be too expensive.

Some carbonate tailings (150000 t/yr) are used to neutralise diluted sulphuric acid from the copper smelters. The neutralisation process takes place at the Polkowice enrichment plant. The neutralisation product is mixed with the main stream of tailings.

The **previous tailings pond**, which was in operation from 1968 until 1980, was created by construction of an earthen dam across the valley of 600 ha. The characteristics of this dam were as follows: an earthen dam of in situ soils with a 15 cm-thick concrete screen on the internal slope with an inclination of 1:2; dam length 6760 m, max. height 22 m, and a triangular gravel filter drainage system connected with the dam ditch.

Decant water from the pond was collected by means of two decant towers with openings for water, and later transferred by a pipeline located in the gallery. Decant and seepage water were directed to flotation by means of a pump station located downstream of the dam. In the beginning, the tailings pond was filled by pouring the tailings from the dam crest by concrete canals located obliquely on the slopes. Later, tailings were placed directly from the outlets located on the dam crest every 40 m. At first the decant water level was up to 2 m above the tailings level. Even in this early period, some negative phenomena took place within the area downstream of the dam. These included a rising of the groundwater level, which even led to flooding, and the creation of ground surface overflow zones. A front of water seeping from the tailings pond was created, in many sections below the bottom of the dam ditch, of increased mineralisation content. The water was later transferred into the ditches of the hydrography network of the Zielenica stream in the Oder river basin.

The subject area, prior to construction of the tailings pond, was of a deep groundwater level, on a significant longitudinal slope (11-16 ‰) and with high permeability of the subsoil such as sands.

A drainage system of open ditches that allowed for water outflow into the Zielenica stream and protection against flooding of the industrial zone, roads, railway line and main forest area was constructed to counter the threat. Close to the dam, drainage by a barrier well was made in order to collect polluted water and to lower the groundwater level. The system of tailings deposition then changed. Carbonate tailings from ore flotation by the Polkowice plant of the excess clay-silt fraction was directed close to the watershed side in order to seal the base of the pond. The system of tailings disposal was also changed by introducing outlets every 20 m. This allowed for stabilisation of the beach at a minimum distance of 100 m and the fraction segregation of tailings in this zone.

The measures listed above resulted in a limitation of water infiltration into the subsoil and effective water transfer from the area directly upstream of the dam. As a result of all the measures mentioned above, the water infiltration from the pond was reduced to a level similar to the conditions prior to the construction of the pond.

The consequences of this included losses in groundwater resources (removal of the groundwater intake, which had been situated there before), losses in forest resources (premature cut-out of an area of approximately 45 ha), extra costs for protection measures against pests in the weakened parts of the forest and extra costs of mineral fertilisation and liming. Also, water in the Zielenica stream had, within this section, a much increased general mineralisation to 3300 mg/l.

The tailings pond was located mainly in the Lubin mine area, and partially extended into that of the Polkowice and Rudna mines. In order to protect the dam, a protective pillar was created. The mine disposals could have been exploited by increased mine requirements and increased losses of disposals but there would have been additional requirements related to the exploitation of the tailings pond due to settlement of the area and the possibility of paraseismic vibrations caused by mining activity.

The above-mentioned limitations resulted in a decision to stop any further use of the pond, and to reject a proposed further development by a second stage to a volume of 160 million m³.

The dam settlement, up to now, has reached a max. 3.25 m, while horizontal displacement had also been observed. Dense and loose zones were detected in the dam body. The deformations are monitored and analysed by the mine staff to meet the needs of the updated exploitation programme in the protective pillar of the dam. From this monitoring, it was decided that the observed deformations created no threat to dam safety.

Construction of the **current tailings pond** started in 1973. The location of the pond was chosen because it was outside the mining activity area, and thus, in contrast to the previous one, it was not subject to direct influence of the mine and, consequently, it did not limit mining operations.

The second factor taken into account in selection of the pond location, was its proximity to the mineral processing plants.

The subsoil of the pond is formed by Quaternary deposits to a depth of 30 - 50 m below ground level. Locally, shallow tertiary deposits heavily disturbed by glacial activity are also observed.

To find the best way for filling the tailings pond, the characteristics of the tailings were taken into account. Sandstone tailings were transferred from the dam crest in sections 500 - 700 m long, situated every 20 m, in order to have a beach not smaller than 200 m and to allow for a gravitational segregation of tailings on the beach. More coarse material was deposited on the beach, while the majority of the fine material (0.05-0.002 mm) was transferred into the pond.

Fine carbonate tailings were, at the beginning, transferred by open canals along the natural slopes with the intention of creating a sealing of the bottom. Later, piers were made that transferred the tailings by pipeline to the edge of the pond.

As starter dams, conventional earthen dams were constructed along a 14.5 km perimeter. Since then, the dams have been raised using the coarse tailings stored on the beach. 2.5 m high dams have been made, from the coarse material, by the upstream method and by stages in two-year periods on the entire perimeter, with the pond increasing on average by 1.2 m per year.

The next stage of spigotting the tailings on the beach is carried out in layers not thicker than 25 - 30 cm per day, over several weeks. Usually, after a long break, the cycle of spigotting the tailings is repeated several times (4-7 times). The spigotting of tailings in one section usually takes approximately 15 weeks until the level of the dam is reached. For longer breaks, the surface of the beach is stabilised in order to protect it against wind erosion, by means of a bituminous emulsion water solution. The emulsion is sprayed from a helicopter. Later, the stabilised surface is removed by heavy equipment. This construction by stages allows proper drainage of the tailings and a stable phreatic surface within the dam body. In this section approximately 2/3 of the coarse particle tailings are stored. The longitudinal beach inclination varies from 6.5 ‰ close to the dam to approximately 4.0 ‰ at a distance of 100 m. The dam raises are carried out by bulldozers that also compact the tailings.

Density values in the upper layer are approximately 1.40-1.45 t/m³, and increase with depth (to 10 m) to approximately 1.60-1.70 t/m³. The water content varies between 5 – 20 %. The density of tailings is equal to 1.46 t/m³. Based on piezometric measurements and CPTU soundings, it has been concluded that the pore pressure distribution is not hydrostatic, indicating tailings water seepage into the ground. This amount was assessed to be 0.862 m³/min in 2000 and 0.690 m³/min in 2001.

Circumferential drains in the tailings were installed along the majority of the tailings pond perimeter to enable control of the water level in the tailings and in the starter dams. The installation of drains is also foreseen on higher levels.

Values for the permeability coefficient 'k' in the beach area and in the pond are as follows:

- in the beach area: k is from 2.0×10^{-7} m/s to 2.0×10^{-9} m/s
- in the pond: k is from 5.0×10^{-8} to 1.0×10^{-10} m/s.

Surface water is protected against contamination by:

- intention to seal the bottom of the pond with fine fraction tailings which consolidate naturally
- collecting seepage water along the entire perimeter of the dam
- maintaining a barrier of wells along selected sections
- placing surface water intakes in selected flows at greater distances, and

- applying continuous monitoring of any underground and surface water under the influence of the tailings pond.

The monitoring network of ground and surface water includes over 800 monitoring points. [113, S.A., 2002]

At **Neves Corvo**, the tailings are managed in a pond. The retaining dam is of the conventional type. The original dam core is clay. For the two raises, both using the downstream method, an HDPE liner was used to form the low-permeability core. The dam has a slope of 1:1.8 (water/tailings side) and 1:1.7 (air side). Downstream of the core is a filter layer.

Due to the high acid-generating potential of the tailings, they are deposited subaqueously. The water cover is maintained at a minimum height of at least 1 m.

The option to apply thickened tailings for closure is currently being investigated.

At **Pyhäsalmi**, 16 % of the tailings are used in the backfilling of the mine, the remaining 84 % (180000 t/yr) are deposited in a tailings pond. This relatively low backfill percentage can be explained by the fact that only the coarse tailings are suitable for backfilling. The total area of the tailings management facilities is about 100 hectares, which includes three tailing ponds. Two of those ponds (pond B and D in the figure below) are used in parallel for settling the solids and to decant clarified water to the third pond (pond C in the figure below). The residence time of the tailing water in the area is about two months.

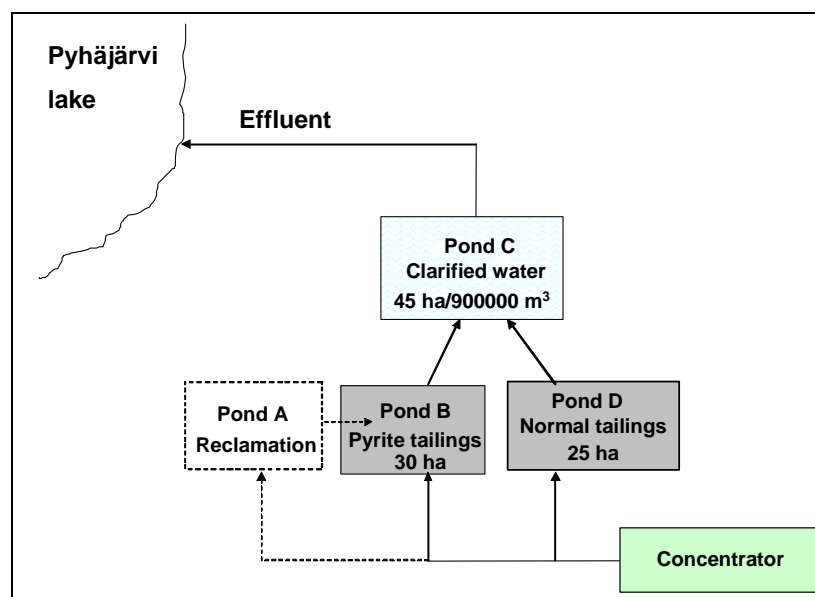

Figure 3.16: TMF set-up at Pyhäsalmi site
[62, Himmi, 2002]

Pond A in the figure above is completely filled and is not in use any more. Reclamation work for this pond was started in 2001. It will be covered with a 80 cm thick layer of soil material (30 cm clay and silt and 50 cm moraine). The central part of the pond will remain under water.

Before construction of the tailings area the soil had been studied. The soil was considered sufficiently impermeable (silt) to prevent leakage to groundwater and also stable enough to carry the load of tailings material. Base line studies were also performed on the downstream lake systems.

The tailings area is built paddock-style on a flat terrain. The base dam is made of moraine. The tailings are distributed from spigots around the first tailings pond and the clarified water is led forward from the centre part of the pond via a decant tower. The necessary raises of the tailings dams are done with tailings material. The dam of the clarification pond is constructed of moraine and lined with broken rock to prevent erosion. The area is surrounded by a ditch used to collect seepage water, which is pumped back to the tailings pond.

The distance from the mineral processing plant to the TMF is about 500 m and the distance to the nearest lake is 200 m.

The annual rainfall in Pyhäsalmi is approx. 650 mm. The climatic conditions are similar to the conditions and the Hitura site.

The tailings management area was designed in the early 1960's and no closure or after-care plans were taken into account in the design stage.

The operational routines include daily control of the facility, regular monitoring of the phreatic surface level in the dams, monitoring of discharged water and audits of the facilities.

[62, Himmi, 2002]

At **Tara** the tailings stream is cycloned. The coarse fraction (52 % of total tailings) is pumped down boreholes to the underground mine as a cement slurry (3 % cement) as backfill. The fine tailings are pumped to the surface tailings pond.

[101, Tara mines, 1999]

At **Zinkgruvan**, the mining method used requires backfilling. Up until 2001 hydraulic backfill had been used. This type of backfilling requires a drainage capacity of the tailings of at least 5 cm/h. This is why the coarse fraction had been extracted from the tailings using hydrocyclones whereby the fraction $>50\ \mu\text{m}$ was returned to the mine. In this way approximately 50 % of the tailings were backfilled using hydraulic backfill. The fine fraction of the tailings had been pumped to the Enemossen tailings pond.

A change in mining method to using 'panel stoping' requires paste backfill. This removes the requirement of the drainage capacity of the fill and thereby allows the use of the fine fraction of the tailings in the backfill. In this way, it is anticipated that up to 65 % of the tailings will be possible to backfill. Furthermore, the tailings pumped to the tailings pond will also contain the coarse fraction which will enable the use of the tailings in the construction of the dams. This method is now implemented in Zinkgruvan, so hydraulic backfilling is no longer performed.

Tailings that are not backfilled are pumped together with the process water from the mineral processing plant to the tailings pond, located 4 km south, in pipelines. The solids sediment in the tailings pond and the free water are led by gravity to a clarification pond 1 km from the tailings pond for additional clarification. In order to evenly fill up the tailings pond and to avoid dusting and oxidation of the tailings, the spigotting points are continuously moved along piers constructed of waste-rock. Water is re-circulated back to the mineral processing plant from the clarification pond (see water balance). Water is also discharged through a pipeline and a tunnel to the recipient water body. The tailings pond and the clarification pond are formed by natural basins (valley site type).

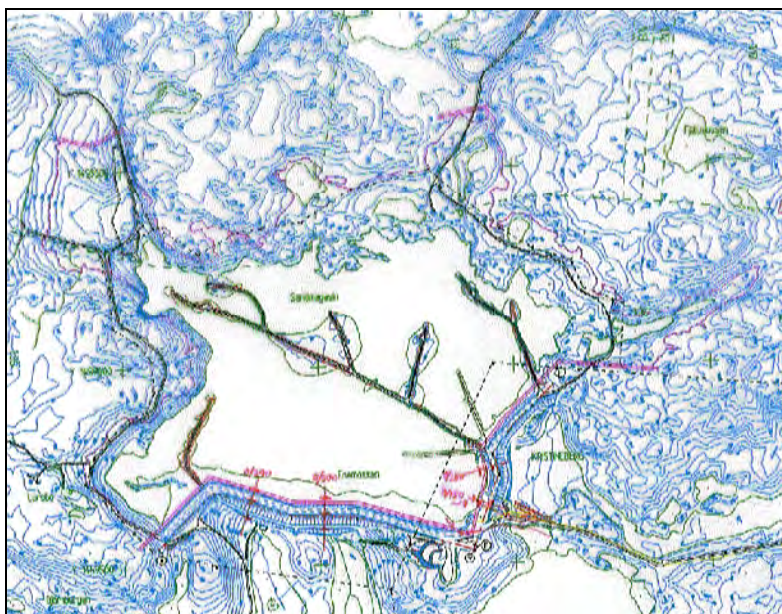

Figure 3.17: Top view of the Zinkgruvan TMF
[66, Base metals group, 2002]

The tailings pond is constructed in a valley and surrounded by natural slopes and two dams. The pond is founded on a peat bog and currently covers approximately 50 ha. At its final height it will cover approximately 60 ha. The embankments are of zoned construction, comprising erosion protection rock-fill on the upstream face, an inclined low permeability till core, a filter layer of sized screen rock and a downstream shoulder of rock-fill. The characteristics of the dams and the tailings pond is given in the table below.

Characteristic data	Dam X-Y	Dam E-F
Used capacity Dec. 2000		5.7
Permitted capacity (from 1981) (Mm ³)		7.0
Total tailings pond area (ha)		50
Total clarification pond area (ha)		16
Volume of material in dams (m ³)	380000	170000
Material from external borrow area	70000	30000
Dam height (m)	27	17
Crest length (m)	800	400
Crest width (m)	16	16
Dam upstream slope	1:1.5	1:1.5
Dam downstream slope	1:1.5	1:1.5
Width of stabilising berm (m)	7	7
Slope of downstream side of berm	1:1.5	1:1.5

Table 3.21: Characteristic data for the existing dams X-Y and E-F at Zinkgruvan site
[66, Base metals group, 2002]

To avoid dusting and oxidation sub-aqueous discharge is practised. However, to lower the phreatic surface, a 30 - 50 m beach with a height of 0.1 - 0.5 m above the water level close to the dam, is required. When discharging tailings under water, the angle of repose is significantly steeper than for discharge above the water level. In order to evenly fill up the pond the spigotting points are continuously moved along piers constructed into the pond. The beach is irrigated during the dry period of the year (spring-summer-autumn). During periods with no snow and during the winter dusting cannot be entirely avoided, even though several methods of temporary covering etc have been tried.

The decant system is tower-type. Decant water flows by gravity to the clarification pond. 50 % of the decant water is re-used in the mineral processing plant. An emergency outlet is constructed, which automatically discharges the water if the level increases above a certain level. The installed discharge capacity is 0.7 m³/s (not counting the emergency outlet discharge capacity) which corresponds to the 100 year rain event and a maximum increase of the water level in the pond of 0.5 m.

The E-F and X-Y dams are constructed as conventional dams. The foundation of the dams is natural bedrock partly covered with moraine or peat soil. Excavations were done below the dams, down to natural bedrock or at least 4 m into the moraine, for the connection between the low permeable core of the dam and the underlying foundation. The low permeable core is constructed of compacted moraine from a borrow pit area. The permeability of the moraine is between 1 x 10⁻⁸ and 1 x 10⁻⁹ m/s. During the construction of the dams quality control was carried out continuously on the moraine and the filter material, mainly including compaction tests/control and material characterisation (grain size distribution).

Hydrogeological studies of the area show that the bedrock in the area contains several fracture zones. The fractures are permeable and drained which results in seepage from the pond. The water balance for the pond is given in the figure below.

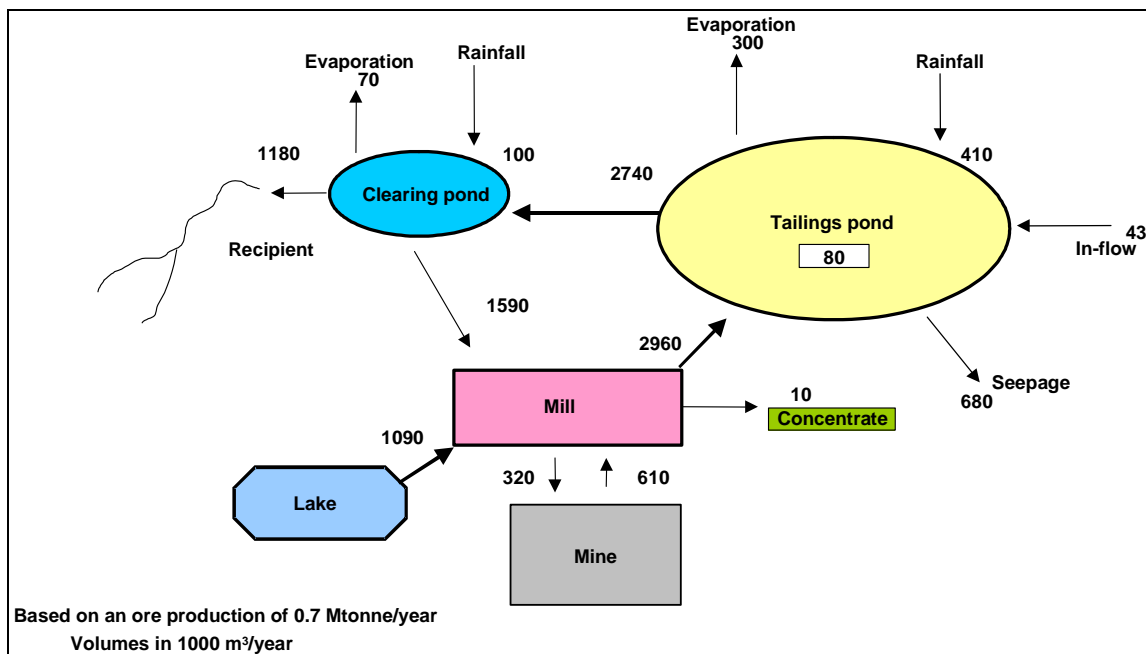

Figure 3.18: Water balance for the Zinkgruvan operation [66, Base metals group, 2002]

The design of a new TMF at Lisheen

Probably the newest TMF in Europe was constructed recently at the **Lisheen** mine. This pond was constructed on flat land (paddock style) on a peat bog and is fully lined. Even though it is designed for a maximum amount of 10 million tonnes of tailings, it is only expected to contain a total of 6.6 million tonnes of tailings over the project’s life [75, Minorco Lisheen/Ivernia West, 1995].

In the design phase of the Lisheen TMF all available primary methods of tailings management were discussed and evaluated. In the decision-making process that led to the preferred method of tailings management, the various methods were investigated on the basis the basic construction requirements and more detailed design criteria for the TMF. This process is described in the following.

Primary tailings management methods

Three primary methods of tailings management were investigated during the design phase, namely depositing them:

- into a surface water body such as a lake, river or sea
- into the mine as backfill
- into a surface tailings pond.

The first of these options was considered environmentally unacceptable. Although lake deposition, under managed conditions, has been accepted as best practice in several northern Canadian operations. However, in this case the operator adopted the philosophy that the most desirable tailings management strategy is to maximise the use of tailings as backfill in the underground workings. This was thought to have the advantages of:

- minimising the volumes of tailings to be managed on the surface
- supporting the hanging wall so that surface subsidence is minimised
- managing the tailings in an underground environment, that will be permanently under water after closure, hence oxidation will be avoided
- maximising the recovery of ore.

The layout of the mine and the sequence of mining make it possible to backfill 6.9 million tonnes tailings underground. The balance of 6.6 million must, therefore, be managed in a surface impoundment.

The topography at Lisheen, within a reasonable distance from the ore processing plant, is such that no significant valleys or hillsides were available as potential tailings pond sites, and, therefore, a ring-dyke impoundment (paddock-style) was proposed.

Other considerations

It had been identified that the tailings have the potential to generate acid if exposed to oxygen, and that the tailings pore water contains some metal ions. These two facts led to the decision that:

- a tailings pond/dam system to retain water so that the tailings are discarded and kept under water was needed
- the tailings need to be dealt with in a pond that is as impermeable as possible to minimise seepage into the groundwater system.

To satisfy these requirements a low, or very low, permeability liner with attenuating capability was considered necessary. The extensive bogs in the area contain peat which has a low permeability, making its use as a component of a composite liner very attractive. Peat has the added advantage in that it can attenuate the release of many of the likely contaminants in any seepage that may occur.

In order to identify the strength of the peat, its permeability in both the uncompressed and compressed states and its attenuation properties, a programme of tests was carried out.

Selection

It had been established that the maximum mass of tailings to be managed on the surface will be 10.0 million tonnes and the TMF should incorporate a low permeability barrier between the tailings and the local groundwater system. Using average topographical features and a reasonable thickness of tailings an area of 80 to 120 ha will be required. This area is based on the conservative in-situ dry density of 1.6 t/m³, though subsequent design is based on 1.8 t/m³, and a relatively low average height of approximately 10 m of tailings.

Since the tailings were found to be net acid generating it was decided that the containment facility must prevent oxidation of the pyrite and must be lined to restrict the seepage of

water into the groundwater system. Two methods of achieving this were discussed, namely: to provide a composite artificial liner if the site is on farm land or make use of the low permeability and high attenuation potential of compressed peat, as part of a composite liner, if the site is on a bog.

Methodology

The selection of the site for the TMF involved the assessment of the economic, environmental and engineering considerations. The objectives of the selection process were, thus, to minimise the impacts on the local community and the environment while, at the same time, satisfying the engineering requirements in the most economical way.

The site selection process involved four stages, namely:

1. a regional search for a topographical bowl or valley that would favour a tailings management scheme within a radius of 15 km of the ore processing plant site
2. a localised search to eliminate unsuitable areas within an 8 km radius. This radius was based on pumping considerations and the lack of good topographical sites in the area immediately beyond this radius
3. identification of possible locations
4. a detailed assessment of the possible locations.

[75, Minorco Lisheen/Ivernia West, 1995]

Description of the constructed TMF

The TMF was constructed on a bog which consisted of up to 4 m of peat overlying a glacial till on limestone bedrock. Limestone is a geotechnically competent lower carboniferous dolomitised Waulsortian formation with no major faulting, and a low palaeokarst potential. The site investigation found no open or infilled cavities and, for this reason and due to the minimal drawdown that takes place below the TMF, dewatering of the nearby mine does not cause reactivation of palaeokarst features, even if these are present.

The TMF consists of an earth embankment, which forms a dam around the impoundment area. Complete removal of peat from the embankment footprint was performed and the entire embankment is constructed on firm till or bedrock.

The perimeter of the TMF is a wide embankment consisting of zoned, engineered fill with a cross-section designed and built to act as a water retaining structure. The dams are constructed of compacted fill material from borrow pits with upstream and downstream slopes of 1:3 and 1:2 respectively. The dam crest is 6 m wide to provide access during construction and operation. A cross-sectional view of the dam is shown in the following figure.

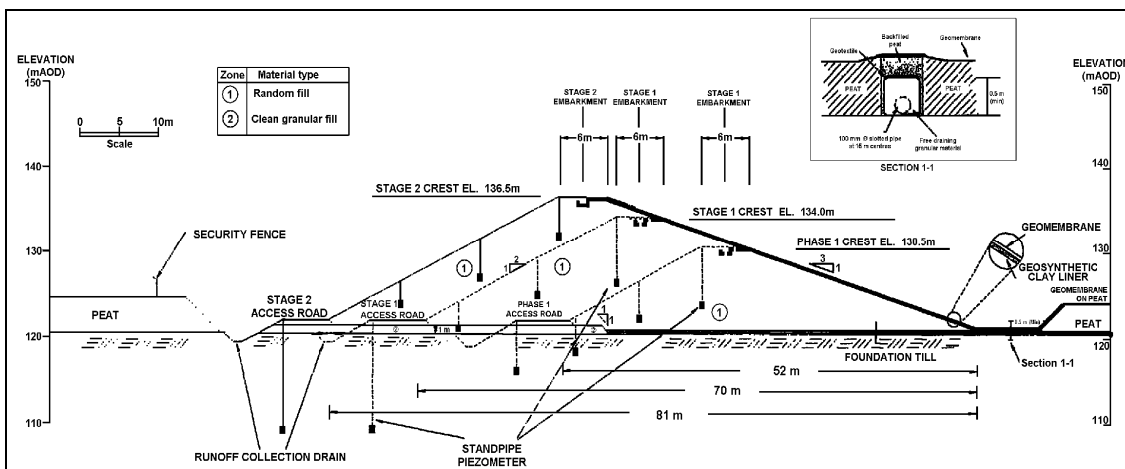

Figure 3.19: Cross-sectional view of dam at Lisheen TMF. Pond is to the right of the dam
 [75, Minorco Lisheen/Ivernia West, 1995]

The dams have been designed to a maximum height of 15.5 m above the till which lies beneath the bog. This allows for the possibility that additional capacity may be required, due to the discovery of additional ore reserves or reduction in the in-situ dry density of the tailings or change to the backfilling quantities. The dams are constructed initially to a maximum height of 9.5 m to provide for the 2.8 million tonnes of tailings which will be discarded on surface in the first six years of operations.

Most of the impoundment area will be underlain by the bog. Peat in the bog is generally of sufficient thickness and has the required physical and chemical characteristics to limit seepage and remove various metalliferous constituents from the seepage water. When loaded by the tailings, the peat will compress to become a natural liner with a permeability of less than 1×10^{-9} m/s. The permeability and strength of the peat are adequate to enable it to act with a geomembrane to form a composite liner capable of containing the tailings and its porewater. A small volume of seepage, estimated to be 34 m³/day, could pass through the composite liner due to punctures in the geomembrane. It is likely that the majority of this water will be collected in the perimeter drains and pumped back into the impoundment.

Around the inner perimeter of the dams, in areas where the peat is less than 1.5 m thick, and on the embankments, a geosynthetic clay liner was placed below the geomembrane, to complete the containment system. A series of 100 mm diameter slotted drainage pipes were installed around the inner perimeter at the level of the base of the peat. These drains will extend from the start of the blanket drain beneath the embankment to 50 m inside the toe of the embankment and will collect some of the water that will be released during compression of the peat and also collect some of the seepage water.

At start-up, prior to deposition of any tailings, the impoundment was covered with water to a minimum depth of 1 m to provide cover over the tailings. Tailings were placed below the water surface by a floating distribution system which was moved slowly back and forth across the impoundment to produce a relatively even layer of tailings so as to minimise differential loading on the peat liner.

Tailings transport water is to be returned to the ore processing plant for re-use, and any surplus water in the TMF is treated in the mine water treatment plant prior to discharge into the river system. Due to the net annual precipitation of approximately 450 mm, and the low volumes of seepage water, there is generally a surplus of water in the tailings impoundment.

The seepage and run-off water from the dams are collected in the surface drain around the TMF and pumped back into the impoundment.
[75, Minorco Lisheen/Ivernia West, 1995]

In short, for the design of the liner and the dams, the following factors were considered:

- stability
 - dam stability
 - foundation stability (in this case peat)
- seepage: seepage rates were calculated based on different defect scenarios
- seepage quality: it was concluded that the seepage water in general, meet drinking water standards, partly due to the fact that the peat has the ability to bind metal ions
- decant water and water balance
- tailings conveyance and discharge.

It was decided to discharge the tailings sub-aqueously to avoid oxidation of the sulphides. This will be achieved via floating pipelines (see figure below).

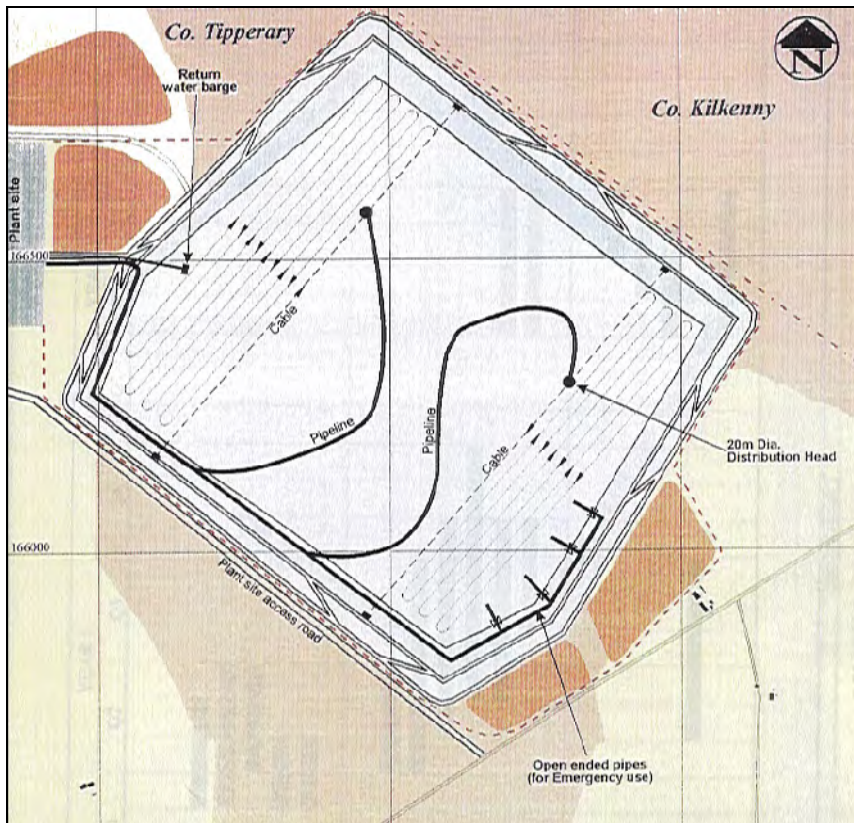

Figure 3.20: Tailings distribution system at Lisheen
[75, Minorco Lisheen/Ivernia West, 1995]

The distribution heads at the end of each pipeline are connected to a reversible, electrically driven winch (see figure below) which passes over a main pulley.



Figure 3.21: Electrically driven winch controlling the tailings distribution pipeline at the Lisheen TMF

Lisheen uses an LLDPE (Linear Low Density Polyethylene) membrane as part of the liner system. The following programme was carried out during the installation of the liner:

- soil testing of embankment fill material
- destructive and non-destructive testing of LLDPE liner
- destructive and non-destructive testing of welds on the liner
- geosynthetic clay liner testing
- micro gravity survey for potential karst features
- liner leak location survey.

The field quality control documents for the TMF liner included:

- geosynthetics inventory control form
- geomembrane panel deployment log
- geomembrane trial seam log
- geomembrane seam log
- geomembrane seam pressure test log
- geomembrane seam vacuum (spark) test log
- geomembrane defect log
- geomembrane log
- geomembrane destructive test record
- geomembrane seam destructive sample log
- geosynthetic clay liner panel log
- geosynthetic clay liner accessory bentonite test record
- failed destructive sample tracking log.

[41, Stokes, 2002]

However, recent inspections have shown that several leaks and tears have developed in the synthetic liner membrane [76, Irish EPA, 2001]. These, where accessible, have been subsequently repaired.

The operation practises an ‘open door policy’, which includes:

- environmental information office in the community
- all monitoring data is made available in monthly and annual reports to the authorities
- complaints register
- annual schools project.

[41, Stokes, 2002]

3.1.2.3.3 Safety of the TMF and accident prevention

The tailings ponds at **Aitik**, **Boliden** and **Garpenberg** follow the routines for dam safety worked out within the OMS manual for tailings ponds (see Section 4.2.3.1). Furthermore, each site follows specific monitoring and surveillance routines. For example, at Garpenberg the pore pressure in the dams is monitored on a weekly or monthly basis in 13 piezometers installed in the dam (manual monitoring). Each measured value is compared to an alarm level at which a thorough follow-up investigation is conducted to detect why an abnormal value was obtained. At the discharge point an automatic water level indicator is installed which is coupled to the information system of the mineral processing plant. Every day, the dams are inspected by personnel from the mineral processing plant. The inspections include the slopes, the discharge from the polishing pond and the pipes for sand transportation [63, Base metals group, 2002], [64, Base metals group, 2002, 65, Base metals group, 2002].

At **Pyhäsalmi** and **Hitura**, the underlying soil was investigated before the dam construction commenced. The system has been designed and constructed so that the surface water in the tailings area can be kept in balance and the excess water from precipitation can be removed in a controlled manner, i.e. the ponds have been designed on a calculated water balance. Engineering and stability issues were addressed by external experts before the raising of all the dams at the Hitura site. No formal risk assessments were carried out at either site.

The TMF area is controlled daily by the operators of the mineral processing plant and inspected annually by an independent expert and at five-year intervals by the dam safety authority. The comments are recorded and stored in a "Dam Safety File", which is compulsory for all types of tailings management areas in Finland. The operational routines applied also include regular monitoring of the phreatic surface level in the dams, monitoring of discharged water and audits of the facilities. A documented emergency plan does not exist, but it is expected, that an emergency plan will be developed in the near future according to new legislation.

[62, Himmi, 2002]

The tailing pond of the operation in the **Legnica-Glogow copper basin** is operated by a separate division called the 'hydrotechnical plant division'. Staff working within the pond area have access to all-terrain vehicles, a hovercraft, a cutter and heavy equipment for earth works (excavators, bulldozers, loaders, tractors, crane). There is a system of communication (wire and wireless) and an alarm system, and the staff co-operate closely with the Mining Rescue Station.

The dam crest is illuminated constantly, since the roads on the dam crest and on the lower shelves of the dams are in continuous use.

The normal water volume in the pond is 5-6 million m³. The reserve for periodic storage of excess water has a capacity of approximately 8 million m³, while the additional reserve for rainwater is approximately 1 million m³. The total available water volume in the pond is therefore 13-14 million m³. The beach width is maintained at a minimum of 200 m and minimum the freeboard is 1.5 m.

The monitoring of the pond is carried out in co-operation with several external experts. Numerical systems for recording, transfer and storage of the monitoring data are also implemented. Results are analysed and conclusions are then drawn, usually within a year's time-scale.

Supervision is carried out by the designers. Additionally, scientific supervision for the safety of the hydraulic structures has been established. Supervision and consultancy is carried out by a team of independent experts (the IBE – International Board of Experts). The activity of the IBE, co-ordinated by the PGE – Polish Geotechnical Expert, is carried out based on the 'observational method' applied for the long-term development of the tailings pond.

In the period 1992-1999, the IBE prepared a geotechnical report on the safety and development possibilities of the currently operating pond. The report included complex subsoil investigations and determination of geotechnical properties of the tailings. The following design data were established: soil and tailings parameters, seepage conditions, slope stability conditions, and a monitoring programme. Numerous monitoring instruments were installed, stabilising berms were placed in selected sections, and circumferential drains were installed in the tailings.

Control parameter	Monitoring applied/ monitoring frequency
Control of water level in the pond	Piezometer; measurements three times daily
Min. distance between the coast line and the dam crest – 200 m	Distance marks + binocular with range-finder
Control of phreatic line location in the tailings and in the dam body <ul style="list-style-type: none"> ▪ piezometric water level in the body of the starter dam and in the tailings ▪ piezometric water level in the body of the starter dam and in the tailings, in the vicinity of A, B and C pipelines ▪ water level in the vicinity of the circumferential strip drains in the tailings ▪ pore pressure in tertiary clays 	<ul style="list-style-type: none"> ▪ piezometer clusters: 7 cross-sections with continuous measurement and data transfer to the main station ▪ piezometer clusters: 7 cross-sections with manual measurements, every month or, for some piezometers, every 10 days ▪ 12 piezometer clusters in the tailings at the distance of 10 m upstream and 20 m downstream of the drainage axis ▪ piezometers
Discharge measurements of drainage: <ul style="list-style-type: none"> ▪ ditches ▪ circumferential strip drains in the tailings ▪ drainage of the starter dam ▪ barrier of wells downstream of the dam 	<ul style="list-style-type: none"> ▪ once per month ▪ twice per year ▪ twice per year ▪ three times per week
Dam movement	<ul style="list-style-type: none"> ▪ bench marks, twice per year, ▪ inclinometers, once per month
Slope stability	<ul style="list-style-type: none"> ▪ routine visual inspections ▪ exceptional inspections e.g. after heavy vibration and during heavy rain ▪ periodic inspection by a committee in charge of the technical state of the structure (once a month, twice a year) ▪ inspection by the competent authority ▪ system of linear transducers in the body of the starter dam, on the perimeter of the pond, on two levels with signal transfer to the main station
Properties of tailings and the subsoil (according to the programme established by the scientific supervisors and the designer)	Hyson equipment, CPT, CPTU DMT tests, Mostap sampler
Paraseismic activity induced by mining exploitation at the distance of min 800-900 m and max. over 2 km	Accelerometers in five cross-sections with transducers at the toe of the slope and on the crest of the dam and in 1 cross-section in the tailings.
Meteorological conditions within the pond area: rain, temperature, velocity and wind direction, humidity	Meteorological station

Table 3.22: Control parameters and applied monitoring at Legnica-Glogow copper basin [113, S.A., 2002]

As the tailings pond has been classified as a high risk structure, appropriate emergency procedures and an emergency plan have been prepared for failure. The warning system and evacuation shelters for the local population are now under construction in co-operation with the local and state authorities.

[113, S.A., 2002]

At **Zinkgruvan**, a risk classification of the tailings pond and the clarification pond was carried out according to the RIDAS system (Guidelines for dam safety developed by the hydro power industry, see Table 4.2). According to this classification system the dams of the tailings pond (E-F and X-Y) are classified as type 1B and the dams of the clarification pond are classified as type 2.

This classification dictates what (minimum) safety measures and control programmes need to be followed. For the dams at Zinkgruvan some applicable measures are:

- audits of the class 1 dams at least every 3 years and the class 2 dams every 6 years
- class 1 dams need to be able to discharge the 100 year flow event as well as store a class 1 flow event. Class 2 dams need only to be able to discharge the 100 year flow event
- monitoring of class 1 and 2 dams needs to be carried out according to the table below.

Parameter	Consequence class 1B	Consequence class 2
Seepage	X, Continuously	Every 6 months
Movements of the dam crest	X, Every 6 months	(X, Annual)
Movements of the slopes	(X, Every 6 months)	(X)
Pore pressure in the core	(X, Annual)	(X)
Water level in support filling	(X, Every 6 months)	(X)
Water level in the foundation	X, Every 6 months	(X, Every 6 months)
X = measuring should be compulsory where it is feasible. () = measuring is important but can be excluded under some circumstances.		

Table 3.23: Basic measuring regime to be performed at new dams [66, Base metals group, 2002]

The stability of the two dams have been assessed with the help of external experts. Results show safety factors of 1.5 and 1.6. Nonetheless, a dam safety improvement programme is running, comprising, among other things, installation of piezometer readings, flattening the dam slope from 1:1.5 towards a slope 1:2.5 – 1:3.0 and monitoring of the seepage water flow.

A number of incidents have occurred over the years mainly due to inner erosion of the dams. This has led to changed operating routines with regard to the deposition technique of the tailings in the dam. In order to lower the pore pressure and thereby avoiding any further inner erosion of the dams, a >30 m wide beach is maintained in the upstream side of the dams. The pore pressure level is monitored frequently (monthly, but more often if any abnormal levels are monitored) by installed piezometers in the dams.

A control programme for dam safety has been agreed with the competent authority and contains the following main components:

- yearly external audits of the tailings pond, dams and clarification pond. This inspection also includes pipelines for water and tailings, as well as discharge facilities
- weekly inspection of the dams by the environmental department at the site. At these inspections the dams are checked for possible damage, water levels, ice pressures and high precipitation events. Dam leakage flow is measured at the toe of the dams (stable around 5 - 10 l/s). All observations are registered in a logbook
- yearly environmental audits of the entire site that also include the tailings pond facilities
- yearly inspections by experts from the competent authority
- maintaining regular communication with the consultant who designed the dam.

Since 2001, piezometer readings have been included in the monitoring programme in order to register the hydraulic gradient over the dam. In total 21 manually monitored piezometers have been installed. In addition, three control wells have been constructed to better monitor and control seepage water flow and quality. The dam seepage flow collection and measurement facilities are shown in the figures below. Instrumentation for reading the electrical potential gradient in order to register water streaming through the embankment dams provides an additional method of monitoring the dam conditions.



Figure 3.22: Ditch for collection and flow measuring of seepage water alongside the dam [66, Base metals group, 2002]



Figure 3.23: Another ditch for collection and flow measuring of seepage water alongside the dam [66, Base metals group, 2002]

A dam safety manual is currently being prepared in order to cover all the issues connected to the tailings management. The manual will cover the following areas:

- dam safety organisation
- emergency and contingency plans

- risk assessment, environment impact and consequence classification
 - design and construction
 - hydrology and decant system
 - systematic monitoring
 - plans for closing the facility
 - official permits and other documents of importance.
- [66, Base metals group, 2002]

At **Lisheen** the following monitoring scheme is applied for this TMF:

Location	Parameter	Monitoring Frequency	Analysis Method/Technique
Piezometers in TMF Embankment	Water level pH Conductivity Pb, Zn, As, Fe, Cu, Hg, Co, Cr, Mg, Mn, Cd, Ni, CN, Sulphide & Sulphate	Weekly Weekly Weekly Monthly	Dip Meter Electrometric Electrometric Standard Method ^{Note 1}
Hydrostatic pressure cells on base of TMF	Hydrostatic pressure	Monthly	Agreed method (c.f. condition 7.4.12)
TMF Retaining Wall	Standard walk-over condition & stability checks Embankment Settlement/ movement Annual safety inspection report	Weekly Quarterly Annually	Visual Survey of seven fixed movement monitoring stations Agreed standard.
TMF embankment crest	Tailings distribution system	Twice daily	Visual
TMF	Tailings settlement/peat consolidation	Bi-annual	Agreed geophysical methodology. (c.f. Condition 7.4.11)
TMF	Volume of tailings disposed Tonnage of tailings disposed Used Capacity Remaining Capacity	Continuous Monthly Annual Annual	Flow meter Dry Density Agreed method Agreed method
Use of spigot distribution system	Period and volume/tonnage Efficiency of distribution	Continuous during use	Record Log Visual
Tailings distribution heads	Depth to tailings	Continuous	Agreed method (c.f. condition 7.4.13)
TMF Perimeter Drain (min. six N o selected locations).	Water level pH Conductivity Pb, Zn, As, Fe, Cu, Hg, Co, Cr, Mg, Mn, Ni, Cd, CN, SS, Sulphide and Sulphate,	Weekly Weekly Weekly Monthly	Dip meter/gauge Electrometric Electrometric Standard Method ^{Note 1}
TMF perimeter groundwater monitoring wells (Inner and outer rings)	Water level pH Conductivity Pb, Zn, As, Fe, Cu, Hg, Co, Cr, Cd, Mg, Mn, Ni, CN, Cl, PO ₄ , Cr, NO ₂ , NO ₃ , Na, DS Sulphide & Sulphate,	Monthly Monthly Monthly Monthly	Dip meter/gauge Electrometric Electrometric Standard Method ^{Note 1}

Table 3.24: Example of monitoring scheme of TMF
[41, Stokes, 2002]

Annex 2 provides several examples of dam failures, mainly at base metals operations.

3.1.2.3.4 Closure and after-care

The decommissioning plan for **Aitik** focuses on the three main parts of the operations, i.e. the waste-rock areas, the tailings pond and the industrial area, which includes the open pit. With regard to the tailings, the evaluation of the weathering properties are still going on. The results so far indicate that no wet cover is required. The measures planned are therefore limited to fertilising and sowing with herbs, grass and trees to prevent wind erosion of the top layer. Dams around the tailings deposit and the clarification pond will be re-sloped at an angle of 1:3 and the slopes will be sown with grass.

[63, Base metals group, 2002]

At **Aznalcollar** after the accident the emergency programme evolved into a complete decommissioning of the failed dam and the entire pond. This included:

- diversion of the nearby river
- building an impermeable seepage cut-off wall around the north and east sides of the dam
- installation of a hydraulic barrier including a back-pumping system on the inside of the cut-off wall
- cutting and re-sloping the dam to 3:1 and covering it
- remodelling the tailings surface to minimise the infiltration and to control the surface run-off
- construction of a vegetated composite cover over the remodelled tailings surface. Starting from the tailings, the cover consists of a geo-textile layer, 0.5 m waste-rock, 0.1 m blinding layer, 0.5 m compacted clay, 0.5 m protective soil layer and vegetation.

[68, Eriksson, 2000]

The decommissioning plan for the **Boliden** tailings pond is described in Section 3.1.6.3.4.

At **Garpenberg**, according to hydro-geological modelling results, the higher section of the Ryllshyttan tailings pond will be almost completely saturated with groundwater. Limited areas along the west and south dams will have a partly unsaturated top-soil.

According to the decommissioning plan, the tailings pond will be covered with vegetation. With numerous references from other sites, it is anticipated that seeding directly on the tailings surface with the addition of nutrients will be a cost efficient and realistic alternative. If problems occur measures to reinforce vegetation, such as application of an organic cover or similar, will be taken. The areas along the dams that remain unsaturated will be covered if acid conditions develop. The dams, which potentially contain acid producing material, will be covered using a 1.1 m thick engineered soil cover, containing a 0.4 m compacted clay layer as the sealing element. The dams will be re-sloped to 1:2.5 – 1:3.0 before covering and then revegetated. The lower section of the tailings pond (the part that is now active) is situated in such a way that a positive water balance can be guaranteed, to that it will thus remain covered by water.

For several years, contacts have been maintained with a nearby paper mill, regarding possible use of their organic waste products for reclamation purposes. These contacts resulted in a test programme, which was launched after the upper section of the pond was completed in 2000. The paper mill produces organic sludge and a fly ash product, a combination with properties making the material suitable as cover material. The supply of material is sufficient to cover the entire pond area within 5 – 10 years, and provides the potential for a robust and environmentally friendly technical solution.

[64, Base metals group, 2002]

A draft plan for closure and after-care has been developed at **Hitura**, which has not yet been approved by the authorities [62, Himmi, 2002].

At **Lisheen** the closure plans were developed as part of the initial permitting procedures and will be reviewed annually. It is expected that five years active care and ten years passive care will be necessary. For the TMF a permanent water cover, due to the acid generating potential of the tailings, is believed to be the best solution. Erosion protection of the dams will be achieved by vegetation and, if necessary, by a rock cover [75, Minorco Lisheen/Ivernia West, 1995].

A closure funding of about EUR 14 million (incl. perpetual after-care) has been in place with the authorities since construction commenced (i.e. IRL 11 million).
[41, Stokes, 2002]

At **Pyhäsalmi**, the closure plan for the first filled tailings pond (pond A) has been worked out and presented to environmental authorities, but it is not yet officially approved. The closure costs are estimated to be about EUR 1 million for this pond. No detailed plans for the other ponds exist, but the total closure and after-care costs for the Pyhäsalmi tailings area are estimated at EUR 5.4 million. The costs are reviewed every year. The EUR 5.4 million needed for closure have been reserved in the income statement of the company to cover the closure and after-care costs. This money, however, has not been deposited. So, for economical difficulties of the company, no assurance mechanism exists.

Production is planned to continue for at least an additional 15 years. Hence, it will be possible to gather experiences for long-term behaviour of the material and the dams at pond A. This experience will be utilised for planning the closure of the other dams in the future.

How the tailings management area will be monitored in the future, i.e. after the closure, is not yet determined. The main target of the after-care work will be to prevent ARD generation from the tailings (5 – 10 % sulphur) and to avoid the need for collection and treatment of drainage water for an indefinite period of time.

At pond A, the tailings will be covered with 80 cm of soil. The lower layer will be clay and silt material (about 30 cm thick) and the upper layer will be made of moraine. The thickness of the cover was determined taking into account site-specific design criteria and the locally available materials. Other cover materials were also considered, such as peat, sand etc., but the final choice was made based on economical and technical reasons again taking into account the locally available materials. The central part of pond A will remain water covered. A system to control the level of the water surface has to be constructed and will include a decant tower and a culvert. Finally, the surface of the treated area will be covered with suitable vegetation.
[62, Himmi, 2002]

The existing and the indicated ore reserves are estimated to give **Zinkgruvan** a mine life for at least another 15 years of operation. Plans for rehabilitation of the areas affected by the mining operation are designed according to the present status of the rehabilitation technique. Since the technology and the requirements from authorities are changing continuously this closure plan can be considered a model, developed from today's demands and standards.

The rehabilitation of the previous tailings area started in 1982 with the construction of an 18 hole golf course and was finalised in 1991 when a marina, a beach area and residences were arranged in the centre of the area. A monitoring programme for the recipient of water from the golf course area, is now running.

Until the currently operating facilities are decommissioned, the closure plan will be reviewed at least every five years.

The current tailings impoundment is planned to be dewatered and covered. Once the area has been restored and rehabilitated the land will be handed back to the original owners. At that stage it may be used for the same purposes as pre-mining i.e. forestry.

The time schedule for the rehabilitation work depends on the life of the mine and will consequently not be started until the mining operation has ceased, now estimated to be around 2025. Depending on the choice made as to how to extend the tailings impoundment area, which is currently estimated to reach permitted volumes around 2007, the need for rehabilitation of the existing tailings impoundment may occur earlier. If the authorities demand a new tailings impoundment to be constructed then rehabilitation of the existing facilities will be performed.

In the application for a new permit an extension of the existing tailings impoundment is the primary alternative. This facility can technically, by means of raising the dam, handle tailings quantities corresponding to another 25 years of ore production. A dam raise to a height corresponding to the life of the mine will imply that rehabilitation measures are not applied before mine closure. An exception to this is the downstream walls of the dams that may be rehabilitated before final restoration.

A 'wet' cover is not possible at the existing pond as the catchment area is too small to guarantee a permanent water surface covering the area. Hence, a 'dry' till cover must be arranged in order to reduce infiltration and diffusion and to prevent water and oxygen reaching the tailings.

When the pond has been dewatered the dams will no longer be subject to water pressure. Instead the dam walls can be classified as stable earth-formations with groundwater pressure. From this point on, the dams cannot be flooded and will not be subjected to inner erosion, which are normally the two most common reasons for dam failure. During times of high water flows it is important though, that water is prevented from entering the pond.

Measures will be taken to secure the physical and chemical stability of the dams and the tailings managed within the pond. Long-term stability and access for large equipment can be achieved by flattening the dams slope from the current 1:1.5 to 1:2.5 - 1:3. The major part of the material needed to flatten the slopes will be put in place simultaneously with the continuous raising of the dams.

The slopes and the surface of the pond will be vegetated to withstand erosion and to aesthetically blend into the surroundings.

The final rehabilitation of the tailings impoundment can be summarised as follows:

- excavation of by-pass ditches along the surrounding natural slopes, approximately 2000 m
- dewatering and consolidation of the pond
- contouring of the pond surface
- flattening of the downstream dam slopes
- placing of dust control cover
- placing of the final cover
- revegetation of the cover.

The table below gives the planned cover design. This proposal is based on recommendations from the authorities, international practice and experiences from other rehabilitation projects in similar settings. The design of the cover may change over time, since closure is far into the future. The suggestion below has been chosen in order to fulfil its purpose, with a good margin. It has been assumed that the following materials will be used to form a cover from top to bottom:

	0.2 m	Top soil
	0.5 m	Protective cover of moraine
	0.2 m	Drainage layer of moraine
	0.2 m	Dealing cover of material with low permeability
	0.2 m	Dust control layer of crushed rock or sand and gravel
	-	Tailings

Table 3.25: Structure for cover of Zinkgruvan TMF
 [66, Base metals group, 2002]

The water surface of the clearing pond will be lowered to a level that can be maintained by natural precipitation within the catchment area. At this level minor areas with tailings will be exposed, mainly in the upper (south) part of the pond. In these areas it is thought to be sufficient to use a simplified type of the cover compared to the cover used at the tailings impoundment. It is assumed that this simplified cover may consist of 0.2 m of topsoil and another 0.2 m of moraine.

[66, Base metals group, 2002]

3.1.2.4 Waste-rock management

At all sites, where the ore is mined underground, the relatively small amounts of waste-rock from development works remain underground.

3.1.2.4.1 Characteristics of waste-rock

The **Aitik** waste-rock has been subjected to extensive testing such as material characterisation, field-scale transport modelling, hydro-geological tracer tests, mineralogy and geology. The suite of tests performed include:

- whole rock analysis
- mineralogical investigations
- Acid-Base Accounting (ABA)
- kinetic testing, such as batch, column, humidity cell and, large scale column weathering tests
- tracer tests to determine the water flow paths within the waste-rock
- effective surface area determinations.

Field characterisation includes:

- in-situ measurements of oxygen concentration as a function of depth within the heaps
- temperature profiles within the heaps
- field-scale tracer tests
- determination of effective diffusion coefficient
- water flow and quality measurements
- water balances.

All this characterisation work has been used in various scientific exercises and in the waste-rock management planning of the Aitik site. Activities performed are, e.g., predictive modelling of water quality evolution with time, equilibrium and kinetic modelling of pore water and drainage composition, mass-balance calculations, coupled hydro-geological and transport modelling. Due to the extensive test work done, it has even been possible to use the information from Aitik to try to solve one of the biggest scientific challenges within this area - namely the dependency between laboratory tests and actual field conditions.

From these results, it can be concluded that, at Aitik, two types of waste-rock are generated – about 65 % that will not generate ARD and 35 % which have the potential of producing ARD. It is an very small percentage that will actually produce ARD, however it is not feasible to separate this fraction from rock that may produce ARD.

These results led to the decision to try to separately deposit the waste-rock that does not produce ARD and thereby minimise the surface area on which ARD-producing waste-rock is deposited. Since 1999 Aitik mine has used a new waste-rock dump for selective deposition of sulphide free waste-rock. This dump is named ‘the environmental waste-rock dump’. The results have also been used in order to develop an adequate decommissioning plan for the waste-rock dumps.

The environmental waste-rock is frequently tested and has to have less than 0.1 % S and 0.03 % Cu with a NP/AP ratio exceeding 3 to be accepted for use outside the mining area and for deposition in the deposit for ‘the environmental waste-rock dump’. Tests conducted by different laboratories have shown that the waste-rock quality is usable as ballast material for roads and railways as well as for use in asphalt.

[63, Base metals group, 2002]

Within the **Boliden** area (five operating mines) waste-rock is managed based on detailed characterisation, mainly focusing on weathering characteristics. ARD producing waste-rock is preferably used directly as backfill. For open pit mining, ARD generating waste-rock is separately deposited and at the Maurliden mine, the ARD generating material is temporarily stored in deposits and will be backfilled into the mined out open pit at closure when it will also be permanently covered by water.

[65, Base metals group, 2002]

The waste-rock at **Mina Reocín** is mainly dolomite (limestone). At the initial stage of the open pit mining, clay (marl) and topsoil were also generated and stored separately for future use during the decommissioning phase.

[54, IGME, 2002]

At **Zinkgruvan**, the mineralogical composition of the waste-rock is given in the table below (based on microscopic analysis). The waste-rock consists of mainly quartz and feldspar (>70 %) and may contain traces of sulphide minerals. The ratio of carbonates to sulphur is >10, therefore the waste-rock has a high buffering capacity and will, therefore, not produce ARD. The waste-rock is regularly sampled and analysed for Zn and Pb content, which, over a large number of samples, have been found to be 0.3 % and 0.2 % respectively. The density of crushed waste-rock is 1.75 t/m³, whilst the compact density of the rock varies between 2.6 and 2.7 t/ m³.

[66, Base metals group, 2002]

Mineral	Fraction %	Mineral	Fraction %
Quartz	32.8	Epidote	0.4
Plagioclase	1.0	Zoizit	3.1
Mikrocline	27.3	Calcite	2.5
Biotite	4.3	Titanit	0.3
Muscovite	1.6	Zircon	0.3
Hornblende	11.7	Apatite	0.1
Diopside	9.9	Other	0.5
Garnet	4.2	Total:	100 %

Table 3.26: Waste-rock mineralogy at Zinkgruvan

[66, Base metals group, 2002]

3.1.2.4.2 Applied management methods

The waste-rock deposits at **Aitik** are situated east and west of the mine and cover an area of approximately 400 ha. In 2001, 26 million tonnes of waste-rock were extracted from the mine, of which 67 % were separately deposited due to their low sulphur and metal content.

Today's strategy is to avoid expanding the stockpile area containing sulphidic waste-rock. In 1999, a new waste-rock dump area was opened. This dump is designated for non-sulphidic waste-rock exclusively, to allow for less extensive decommissioning procedures according to the permit. Furthermore, the quality of the rock opens opportunities for its utilisation as a construction material.

The selective management of waste-rock has been identified as a potential for cost savings and possible revenue if low sulphur material can be isolated. The bedrock from the hanging wall has a lower sulphide content and is therefore more suitable for selective management than rock from other parts of the mining area. The material consists of amphibole-biotite gneiss, which is intruded by pegmatite veins. The amphibole-biotite gneiss is characterised by a varying degree of amphibole banding, with a matrix of amphibole, biotite, quartz and to a lesser extent plagioclase. The pegmatites contain mostly feldspar and quartz. The thrustfault forms a sharp contact between the hanging wall and the ore zone, making it easy to follow the contact. It is known that the hanging wall is barren of copper, and earlier mapping from diamond drill holes shows no change in the bedrock. The analyses carried out show low copper and sulphur content.

A new test procedure to secure the quality of the waste-rock was developed. This included chemical analyses, acid base accounting (ABA-test) and humidity cell tests on drill core material on the future waste-rock. This work led to further investigations. Drill chip samples from the production drilling were collected and tested for several different blasts, with positive results. Today, routines are implemented for testing this type of bedrock for every blast, aiming at rapidly classifying the material for deposition on the new waste-rock dump. The material should be amphibole-biotite gneiss and/or pegmatite. Copper grades, sulphur content and the ABA-test are not to exceed the recommended values. All results are stored in databases.

In the latest waste-rock deposition plan of 1999, conditions for the selective management of various waste-rock fractions are regulated. The criteria for the selective deposition of sulphide free waste-rock are less than 0.1 % S, less than 0.03 % Cu and a NP/AP ratio exceeding 3. Analyses are conducted on accumulated samples from a minimum of eight drillholes representing 150000 t of waste-rock. To secure the quality, any waste-rock within 30 m from the ore zone needs to be excluded.

The decommissioning method involves covering the sulphide free waste-rock dump with 0.3 m of till and/or other material as a vegetative layer. The decommissioning is undertaken progressively, and the establishment of vegetation will start within two years after deposition of each terrace is completed.

Surface run-off and drainage water in collection ditches is collected and re-used in the mineral processing plant as process water. Collection ditches receiving effluents from old sections of the waste-rock dumps currently receive drainage water with a high metal content and low pH. The quality of the water in the diversion ditches is strongly influenced by the local quaternary geology, with elevated sulphide contents in the till.

The hydrogeological investigations showed that the dumps are not hydraulically connected with the pit. The whole area, on which the dumps are located, is covered with a 10 m layer of low permeable glacial till on top of the bedrock. Virtually all the infiltrated water leaves the dumps at the toe, and is easily collected in ditches. Acid drainage with an elevated content of copper was found during the 1970's. Detailed field investigations in 1992 – 1993 estimated the annual amount of copper leaving the dumps to be 80 tonnes, of which 55 tonnes originated from the old marginal ore stockpile. The corresponding overall amount of sulphate was 4000 tonnes

annually. During recent years, the bulk part of the marginal ore has been reprocessed and the influence on the pollution load of this undertaking is presently being evaluated.

A critical component of the decommissioning plan was the development of measures addressing the ARD situation. An engineered cover was identified as the only realistic way to deal with the waste-rock dumps, and between 1993 and 1996, a project using modelling tools to design a cover to reduce the flux of water and oxygen into the waste-rock was undertaken. The goal was to achieve a 99 % reduction in oxygen flux into the dump. The hydraulic properties of potential cover materials were measured and a number of cover designs involving layers of moraine and tailings sand were investigated. Following the modelling programme, a cover design was selected for the waste-rock dumps. Physical tests of the glacial till in the area, i.e. the stockpiles and the overburden that has been or will be removed in the future, indicated that this material would be suitable for engineering a cover suitable as a gas diffusion barrier of relevant quality.

A number of possible cover alternatives were evaluated. The results indicated that a 1 m layer of compacted moraine with a hydraulic conductivity of 1.5×10^{-7} m/s would reduce the oxygen transport into the dump to 1.2×10^{-9} kg O₂/m²s - less than 1 % of the reference case without cover. From this result, the estimation, based on weathering tests, was made that the reduction in copper pollution load would be of the same order of magnitude, resulting in a copper release of less than 1000 kg/yr.

Snow reduces the frost penetration. An estimation of the influence of freezing, which could possibly affect the long-term performance of the cover, was that frost would penetrate the cover to a depth of 0.7 m. The penetration of frost is strongly dependent on the depth of the snow cover, which at Aitik is considerable during winter.

To enhance the establishment of vegetation and to further secure the structure's resistance to frost penetration, it was concluded, that an additional top layer of 0.3 m of non-compacted till should be applied. An illustration of the decommissioned waste-rock dump and the proposed cover is shown in the figure below.

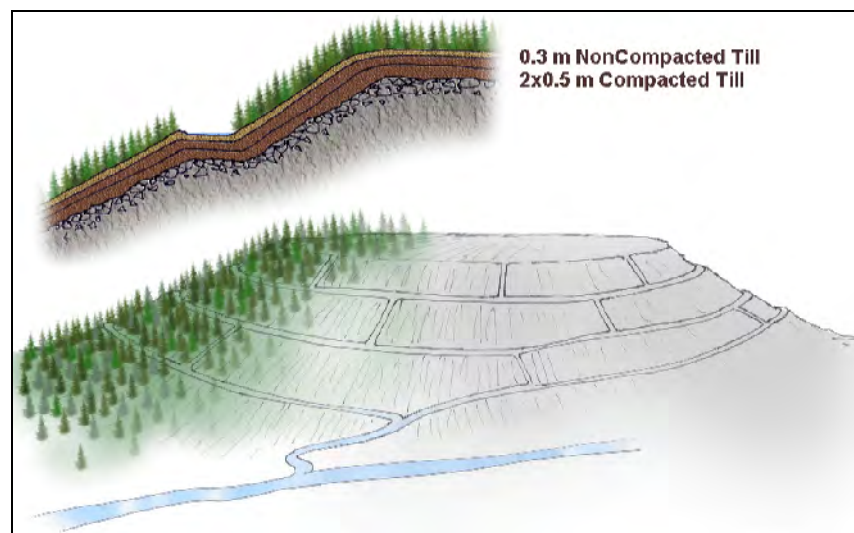

Figure 3.24: Structure of waste-rock dump cover and illustration of the decommissioned waste-rock dump at the Aitik site
[63, Base metals group, 2002]

The 1997 permit allowed Aitik to commence the cover placement in 1997, with a 14 hectares area of the east waste-rock dump. This cover consisted of 1 m of moraine, distributed in two 0.5 m layers, which were compacted individually, and 0.2 - 0.3 m of topsoil. According to the permit, the maximum hydraulic conductivity was 2×10^{-7} m/s, and the compaction rate was 93 % proctor. The surface was finally sown with grass during the autumn of the same year.

To divert surface run-off water, channels were constructed along the benches and down the slopes, using geotextile and till. It soon became obvious, that a different solution regarding the surface water needed to be developed, as erosion from snowmelt water severely damaged the cover. Replacement using new till and erosion resistant waste-rock was an immediate solution, but for future cover steps, surface water management solutions must be designed in a way that does not endanger the integrity of the cover.

The placement of the cover on the slopes, on the other hand, did not constitute any problem. The 1:3 slope is shallow enough to allow normal operation of the conventional construction machinery.

In the coming years, additional sections of the waste-rock dumps will be covered in order to reduce the exposure of the waste-rock to oxidising conditions and to minimise the material handling and costs. Therefore for future mine developments cover placements will be synchronised with the overburden removal.

Since 1999, the Aitik mine has used a new waste-rock dump for selective deposition of sulphide free waste-rock. This dump has so far received 40 million tonnes of waste-rock. It is frequently tested to verify that the permitted values, less than 0.1 % S and 0.03 % Cu and a NP/AP ratio exceeding 3, are met. Tests conducted by different laboratories on the chip value, brittleness, ball mill hardness and particle density have furthermore shown that the waste-rock quality is sufficient for it to be used as ballast material for roads and railways as well as for use in asphalt. [63, Base metals group, 2002]

In the **Boliden** underground mines, large quantities of waste-rock are moved directly to mined out areas within the mine. Only the waste-rock that is not used for backfilling is brought to the surface. In open pit mining all waste-rock has to be brought up to the surface and deposited. At closure, some of the waste-rock, e.g. highly acid generating rock, may be backfilled into the mined out open pit.

During 2001, the following amounts of waste-rock were used for backfill and were deposited within the Boliden mining area.

Mine	Waste-rock used in backfill (kt)	Waste-rock deposited (kt)
Renström	82.1	-104.0
Petiknäs	103.4	-15.7
Kristineberg	127.6	4.6
Maurliden		875.7
Åkerberg	24.3	-21.0

Table 3.27: Amounts of waste-rock backfilled and deposited in the Boliden area

Waste-rock from deposits at the Petiknäs and Åkerberg mines has been backfilled (hence negative values). The waste-rock dumps at the Renström mine have decreased significantly as material from the dumps has been used in the construction of a regional public road.

Generally it can be concluded that the managed waste-rock quantities are relatively limited, with the exception of the Maurliden open pit mine.

The waste-rock is managed based on a detailed characterisation, mainly focusing on weathering characteristics. ARD producing waste-rock is preferably used directly as backfill. For open pit mining, ARD generating waste-rock is separately deposited and for the Maurliden mine, the ARD generating material is temporarily stored in deposits and will be backfilled into the open pit upon closure, where it will then be permanently covered by water. All waste-rock deposits are surrounded by diversion ditches and drainage collection ditches. If required, the drainage can be treated before discharge.

Topsoil and moraine are deposited separately for future use in the decommissioning of the site. [65, Base metals group, 2002]

The Lubin, Polkowice-Sieroszowice and Rudna mines in the **Legnica-Glogow copper basin** produce two types of waste-rock. The first type of waste-rock is generated during the development of the underground mines. Due to the different shape of the deposit in each mine, the amount of the waste-rock varies. Annually, the Lubin mine produces about 450000 t and the Rudna mine about 600000 t. The Polkowice-Sieroszowice mine produces ten times more (6000000 t.), because its deposit is the thinnest (0.4 - 3.5 m) and in many places it is necessary to extract waste-rock and ore at the same time and separate them on site. All waste-rock is utilised as solid backfill in the mined out stopes or for underground road construction.

The other stream of waste-rock which occurs periodically comes from the construction of shafts (e.g. in 2001, 61500 t of waste-rock was extracted for the construction of a shaft at Rudna mine). This material is stored on heaps, which are shaped and reclaimed. [113, S.A., 2002]

At **Mina Reocín**, the waste-rock is deposited into an mined out part of the open pit. The old waste-rock dumps generated in the initial phase of the open pit mining are covered with soil and re-vegetated. Restoration is done using clay (marl) and top soil separately stored for this purpose [63, Base metals group, 2002].

At **Zinkgruvan**, about 0.2 million tonnes of waste-rock are produced annually in preparation works. At the end of the mine life, ore production will be possible for a couple of years without any waste-rock generation. The waste-rock is used for construction of the tailings dam, as backfill in the mine and is also sold outside the mine. About 0.5 million tonnes of waste-rock is managed on the surface close to the old open pit as a noise barrier around the east part of the industrial area. Any surplus of waste-rock is managed in deposits that are managed by an external entrepreneur who crushes and sells the material to third parties. From 1996 until 2000 58 % of the waste-rock was sold. [66, Base metals group, 2002]

3.1.2.5 Current emissions and consumption levels

3.1.2.5.1 Management of water and reagents

Water consumption

The following table shows the water consumption and percentages of re-used process water of base metal sites.

Site	Ore processed (tonnes/year)	Water consumption (m ³ /tonne)	Re-used in min. proc. plant (%)	Of which from TMF (%)	Of which from mine (%)
Aitik	17700000	1.8	100	100	0
Almagrera	1000000	3.2	0	0	0
Boliden area	1450000	3.2	0	0	0
Garpenberg	984000	2.9	68	100*	0*
Hitura	518331	6.2	100	90	10
Mina Reocín	1100000	2.0	100	0	100
Neves Corvo	1750	0.8	75	100	
Pyhäsalmi	1250000	5.3	0	0	0
Zinkgruvan	850000	2.7	63	73	27

*: mine water first pumped to TMF

Table 3.28: Water consumption and water use/re-use of base metal sites

Note that at the Pyhäsalmi and Boliden sites water is partially re-used within the mineral processing plant.

The **Aitik** mineral processing plant uses 100 % re-used water from the tailings pond. Under normal conditions the entire water consumption, $31.5 \text{ Mm}^3/\text{yr}$, is supplied by re-used water from the tailings pond. Approximately 1.8 m^3 of water per tonne of ore processed is used in the process plant. In the snow smelt period, excess water is normally released from the clarification pond to the recipient. The released water is of good quality and no water treatment is required (see Section 3.1.2.5.3). [63, Base metals group, 2002]

From the **Garpenberg** mine the mine water is pumped to the mineral processing plant and used as process water before it is pumped together with the tailings to the tailing pond system where water treatment occurs through interaction with the fresh mineral surfaces which effectively absorb any dissolved metals. From **Garpenberg Norra** the mine water is released to the recipient after clarification. At the Garpenberg mineral processing plant the consumption of used/re-used water was 1.95 Mm^3 during year 2001 and the consumption of freshwater during the same period was 0.93 Mm^3 . The discharge from the tailings pond amounted to 4.55 Mm^3 . Out of this volume approximately 50 % was re-circulated to the mineral processing plant and re-used as process water. The remaining 50 % was discharged to a lake. [64, Base metals group, 2002]

At **Hitura**, the clarified water from the TMF is re-circulated to the process. The amount of this water corresponds to almost 100 % of the total amount of water used in the process. This system does not save reagents significantly, because flotation chemicals such as xanthate and frothers are decomposed in the tailings area and the tailings material consumes the sulphuric acid. The water balance is presented in the figure below.

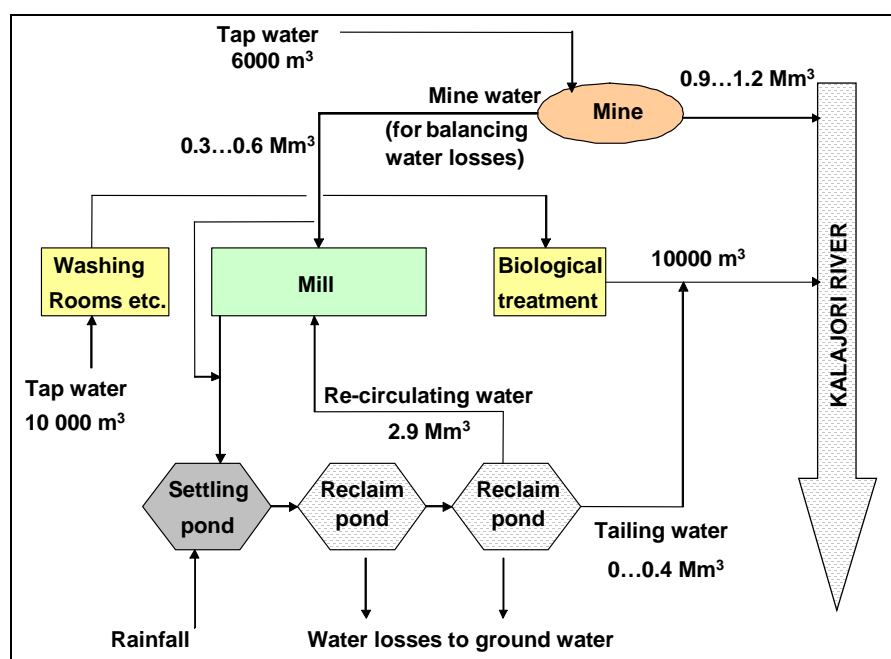

Figure 3.25: Water balance at Hitura
[62, Himmi, 2002]

It can be seen that, depending on rainfall the amount of water from the tailings pond used/re-used in the mill (mineral processing plant) varies between 88 to 100 % (0 to 0.4 Mm^3 to the river).

The mines in the **Legnica-Glogow copper basin** pump a total of about 70000 m^3 per day of mine water. The Cl^- -content of this water ranges from 0.5 to 127 g/l and the SO_4^{2-} -content is approx. 2 g/l. However, the actual amount of water pumped to the surface is higher, and its salinity is lower, because of additional water streams from backfilling and flush boring. All these waters combined are utilised in the mineral processing plant. [113, S.A., 2002]

At **Lisheen**, process water is re-used and supplemented with water reclaimed from the TMF [73, Ivernia West,].

At **Pyhäsalmi**, there is no re-use for process water from the TMF area to the process. The reason being gypsum (CaSO_4) in the water causing blocking problems in the pipes. There is only an internal re-use of water in the process, where water from the thickener in the pyrite flotation is returned to the grinding circuit to save sulphuric acid in the pyrite flotation and lime in the Cu-flotation. This amount of water is corresponding to 10 % of the total amount needed in the mineral processing plant.

Fresh water is pumped from a lake. The water balance for 2001 is presented in the table below.

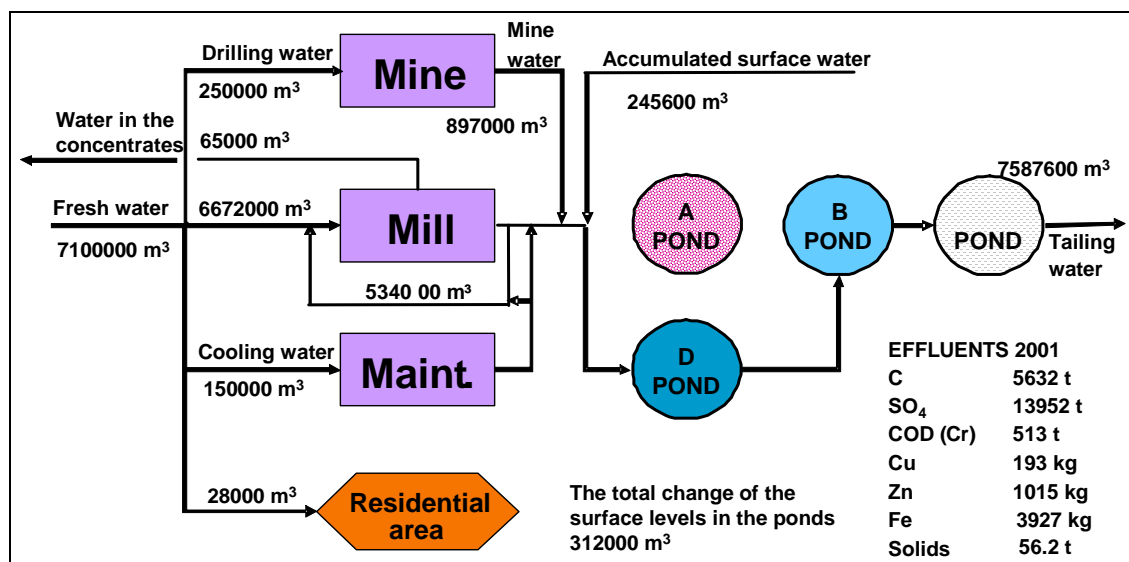

Figure 3.26: Water balance at Pyhäsalmi for the year 2001 [62, Himmi, 2002]

At **Zinkgruvan** the water consumption in the mineral processing plant is approximately 2.7 m³/tonne or 2.4 Mm³/yr in total. The water requirement is covered by freshwater supply from nearby lakes and by recycling of water from the tailings pond (partly process water and partly mine water).

The main consumption of water is in the actual process, in the paste fill and for cooling purposes. The entire water balance is illustrated in the following figure.

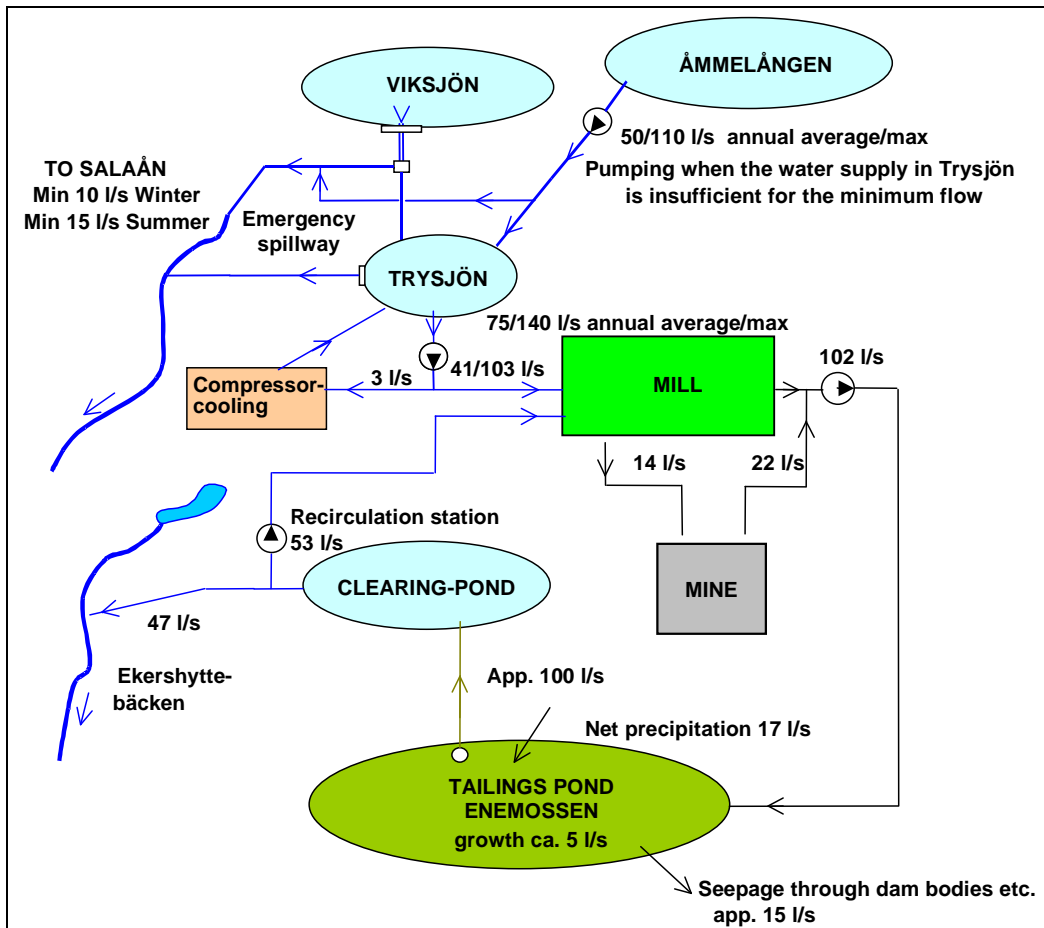

Figure 3.27: Water balance for the Zinkgruvan operations shown as average annual flows and maximum flow during operation [66, Base metals group, 2002]

Reagent consumption

The following tables shows the reagents used at base metal mineral processing plants. Note that cyanide can be used for two purposes, as a depressant for sphalerite, pyrite and some copper sulphides or as a leachate for gold.

		Site								
		Aitik	Almagrera	Mina Reocín	Boliden	Garpenberg	Hitura	Lisheen	Pyhäsalmi	Zinkgruvan
Reagent		Consumption	Consumption	Consumption	Consumption	Consumption	Consumption	Consumption	Consumption	Consumption
Group:	Type:	g/t	g/t	g/t	g/t	g/t	g/t	g/t	g/t	g/t
Collectors					179 ¹					
	Xanthates					209	300	135	250	100 - 120
	Thionocarbamate							10.9		
Frothers					28					
	Sylvapine						150		50	
	MIBC							8.8		30 - 40
	Dowfroth							0.9		
Activator										
	Copper sulphate				441	433		876	500	
	Sodium sulphide									
Depressants					90					
	Sodium cyanide				310 ²				4	
	Zinc sulphate				92	306		234	400	30 - 50
	Iron sulphate					47				
	Acetic acid								15	
	Sodium chromate				30	10				
pH										
	Dithiophosphate							55.1		
	Lime	408			3448	773	350	4368 ⁵	9000	
	Sulphuric acid						7500	5609 ⁶	12000 ³	300 - 500
	Sodium hydroxide				30					400 - 600
Flocculants										
	Nitric acid								150	
	Hydrochloric acid				1					
Others										
	CMC						100			
Others										
	Other							13.5	1	
	Soda ash							472		
	"Flotation agents"	19								
	Sulphur dioxide				869 ⁴					

1. No information about collector type, probably xanthates;
2. Used in cyanide gold leaching;
3. Based on 100 % H₂SO₄
4. For CN destruction after cyanidation;
5. pH and water treatment;
6. pH and to leach

Table 3.29: Consumption of reagents of base metal sites

As an alternative to xanthates as collector there are a number of different brands on the market. These collectors are of the type diaryldithiophosphates. A change into those collectors means for Zinkgruvan a change of the flotation process into a straight selective lead/zinc flotation process. The overall costs for chemicals in that process is twice the costs compared to the actual process used today. This is due to the fact that a set of other chemicals will be used i.e. copper sulphate, sulphur dioxide and slaked lime [66, Base metals group, 2002].

The **copper separation at Neves Corvo** is achieved by flotation. The following collectors are used:

- dithiophosphate, 80 – 120 g/t, pH 10-11
- potassium amyl xanthate (PAX), 30 – 40 g/t, pH 11

The tin separation is carried out providing by gravity separation on Holman-Wilfley shaking tables and subsequently by cassiterite flotation.

3.1.2.5.2 Emissions to air

The emissions to air for the **Boliden** site are discussed in the precious metals section.

The **Aitik** site follows a comprehensive monitoring programme for emissions to air. At the site there are mainly three sources of emissions to air:

- from the drying of the concentrates
- from blasting and diesel vehicles, and
- diffuse dusting from the whole site including the tailings pond.

However, emissions from blasting, diesel vehicles and the drying of concentrates are not part of the scope of this document. It should be noted, though, that drying ovens are gradually being replaced by filters.

The diffuse dust immissions are measured at eight monitoring points at the site as sedimented particles. The collected samples are analysed for copper and the total weight of sedimented particles (normalised towards the surface area of the collector). The results are summarised for the years 1999 to 2001 in the table below.

[63, Base metals group, 2002]

Monitoring point	1999		2000		2001	
	Sedimented particles	Cu	Sedimented particles	Cu	Sedimented particles	Cu
	mg/m ² month	mg/m ² month	mg/m ² month	mg/m ² month	mg/m ² month	mg/m ² month
S 1	1210	1.5	1910	2.5	3030	2.6
S 7	450	0.4	330	0.3	480	0.4
S 8	394420	21.4	55550	19.8	23440	12.7
S 9	1100	0.7	720	0.3	2610	1.0
S 10	920	0.9	750	0.7	540	0.5
S 11	690	0.7	1200	0.8	480	0.5
S 12	1820	0.8	1360	0.8	1000	0.9
S 13	520	0.3	860	0.5	780	0.4

Table 3.30: Measurements of total sedimented particles and Cu at Aitik
[63, Base metals group, 2002]

At **Garpenberg**, there are mainly two sources of emissions to air:

- the drying of concentrates and
 - ventilation from the mines (SO₂, NO₂ and CO₂).
- [64, Base metals group, 2002].

At **Hitura**, the main sources of emissions to air have been identified as:

- dust from the industrial area including TMF and mineral processing plant
- dust from roads.

The area of influence is monitored at several collecting points.

Dust from the TMF is a problem in dry and windy weather. Attempts have been made to prevent dusting by covering the banks immediately after raising with soil material and using lime slurry on the banks. Also the water surface level in the tailings pond is kept as high as possible in the summer time and tailings distribution is arranged so that the beach area is kept as wet as possible. [62, Himmi, 2002]

In the **Legnica-Glogow copper basin** there are three types of airborne emissions:

- dust, heavy metals, SO₂ and NO₂ emissions from the ventilation shafts of the underground mines
- dust, heavy metals, SO₂ and CS₂ emission from the three mineral processing plants
- dust emissions from the dry surface portion of the tailings pond.

As to the latter type of emissions, it is the beach, which constitutes a considerable source of dust emissions, especially on windy days. To reduce this dust a water 'curtain' is installed on the crest of the dam. Additionally, to stabilise the surface in sections which are temporarily dry, an asphalt emulsion is sprayed from a helicopter. Currently, additional water 'curtains' are being tested. These are installed inside the pond on the beach at a distance of 150 m, and are put into operation when a dry section, after removing the asphalt cover, is utilised for dam construction.

In the vicinity of the tailings pond, an air monitoring system has been installed. This consists of three continuous measurement stations, one meteorological and one central station. The measurement stations are equipped with FAG airborne dust measurement devices, which measure particulate matter (total). There is also one more station, owned and operated by the local inspection authority. The result for total particulate matter imission are shown in the following table.

[113, S.A., 2002]

Measuring point (distance from the dam)	Annual medium particulate matter (total, µg/m ³).			
	Year 1998	Year 1999	Year 2000	Year 2001
Rudna (1000 m SE)	36.3	34.3	29.2	33.6
Kalinówka (600 m NE)	33.9	29.1	28.7	30.2
Tarnówek (500 m SW)	35.7	34.0	31.3	23.9
Local authority's station (1800 m SE)	24.3	18.0	14.8	12.7

Table 3.31: Dust imissions from tailings pond in the Legnica-Glogow copper basin
[113, S.A., 2002]

Furthermore, annual medium concentrations of particulate matter (total) and metals content in ambient air within close proximity (60-2250 m) of the tailings pond are measured. The results for 2001 are shown in the following table.

	Particulate matter (total) ($\mu\text{g}/\text{m}^3$)	Metal				
		Cu ($\mu\text{g}/\text{m}^3$)	Pb ($\mu\text{g}/\text{m}^3$)	Zn ($\mu\text{g}/\text{m}^3$)	Cd ($\mu\text{g}/\text{m}^3$)	As ($\mu\text{g}/\text{m}^3$)
D ₂₄ ¹	1.0 - 70.0	<0.01 - 0.07	0.05 - 0.26	0.001 - 1.321	0.0001 - 0.0226	0.0001 - 0.0515
D _a m ²	12.7	0.019	0.099	0.151	0.0007	0.0038
1. the range of 24-hour measurement results						
2. medium annual value						

Table 3.32: Annual medium concentrations of particulate matter (total) and metals content in ambient air within close proximity (60-2250 m) of the tailings pond in the Legnica-Glogow copper basin [113, S.A., 2002]

At **Lisheen**, the emissions to the atmosphere are monitored using the following measurements:

- point source
- ambient air
- dust deposition.

[41, Stokes, 2002]

The emissions in 2001 are listed in the following table.

Parameter	Unit	Quantity
Particulates	kg/yr	3375
Nitrogen oxides	kg/yr	243266
Carbon monoxide	kg/yr	129546
Carbon dioxide	kg/yr	186713872

Table 3.33: Emissions to air at the Lisheen site [76, Irish EPA, 2001]

At **Pyhäsalmi**, the main sources of emissions to air have been identified as:

- dust and SO₂ from concentrate drying in the mineral processing plant
- dust from the TMF
- dust from concentrates loading area
- dust from roads and industrial area.

Dust emissions are measured at several collecting points. The main purpose is to survey the area of influence. Since June 2001 emissions have also been controlled with an automatic device, which continuously takes measurements.

Dust emissions from the tailings management area are a problem in dry and windy weather. Attempts have been made to prevent this by spraying lime slurry on the banks.

[62, Himmi, 2002]

3.1.2.5.3 Emissions to water

The following table summarises the total emissions to water from base metals sites.

Parameter	Unit	Site						
		Aitik	Boliden	Garpenberg	Hitura	Legnica-Glogow	Lisheen	Pyhäsalmi
		Year						
		2001	2001	2001	2000	2001	2001	2000
Discharge	Mm ³	6.44	11.10	2.60	0.08	21.1	22.9	6.89
Ca	t/yr	-	-	-	-	26164	-	4727
SO ₄	t/yr	-	-	-	254	58742	-	12057
COD	t/yr	-	-	-	-	654	51.4	334
Solids	t/yr	-	-	6.2	0.9	633	89.4	47.1
Al	kg/yr	446.0	-	-	-	-	2465	-
As	kg/yr	1.7 ¹	156	18	-	422	-	-
Cd	kg/yr	-	1	0.8	-	591	8.1	7
Co	kg/yr	5.3	-	-	-	-	17	-
Cr	kg/yr	0.2 ¹	-	25	-	1160	-	-
Cu	kg/yr	36.0	72	40	-	1435	28.5	309
Fe	kg/yr	-	-	-	24	9495	1412	9141
Mn	kg/yr	-	-	-	-	-	565	-
Hg	kg/yr	0.1	-	0.3	-	6.33	0.6	-
Ni	kg/yr	5.1 ¹⁾	-	-	107	-	311.9	-
Pb	kg/yr	0.1	191	52	-	3376	263	-
Zn	kg/yr	34.6	1070	586	-	949	2321	1464
N	t/yr	17.0	-	6.5 ²	-	130	40892	-
CL						176269	-	-

1. Dissolved metals, sample is filtered in the field before it is acidified
2. Year 2000

Table 3.34: Total emissions per year to water from base metals sites

The annual total discharge from **Zinkgruvan** was 1.5 Mm³.

Table 3.35 shows the concentrations in the emissions from tailings management facilities.

Parameter	Unit	Site			
		Aitik	Garpenberg	Legnica-Glogow	Zinkgruvan
		Year			
		2001	2001	2001	2001
pH		7.1	10	7.9	7.5
Susp. particles	mg/l	-	2.4	30	3.1
Mineral oil	mg/l	-	0.1		-
Copper (dissolved)	µg/l	2.1	-		-
Copper (total)	µg/l	7.3	15	68	2.7
Zinc	µg/l	1.7	218	45 (total)	220
Lead	µg/l	0.02	20	160 (total)	27.3
Cadmium	µg/l	0.004	0.37	28 (total)	0.3
Arsenic	µg/l	0.3		20 (total)	1.9
Chromium	µg/l	0.004	9	55 (total)	<1.0
Mercury	µg/l	0.009	-	0.3 (total)	<0.1
Iron	µg/l	8	-	450 (total)	-
Aluminium	µg/l	38.5	-		-
N-total	mg/l	2.6	-	6.16 (total)	5.4

Table 3.35: Concentrations in emissions from base metals sites

At **Aitik**, water sampling is carried out at the discharge point (clarification pond) and at 12 sampling stations in the river systems according to the regular monitoring programme. The samples are analysed for several metals, pH, N-total, oil, SO₄-S, conductivity and turbidity. Water was, during the year 2001, only discharged from the clarification pond to the Leipojoki river. No discharge was done from the recycle pond nor from the recycle channel [63, Base metals group, 2002].

The emissions to water from the **Boliden** tailings pond are described in detail in the precious metals section.

Garpenberg follows a broad monitoring programme for surface waters as well as recipient sampling and control, which is carried out within an integrated programme for the catchment area (the main river in the area). This programme contains water sampling analysis, fish investigations, sediment and bottom fauna investigations. The discharge from the tailings pond is sampled by an automatic sampler every two hours and a composite sample is produced monthly.

Sufficient water quality for the process and for discharge is obtained in the tailings pond/clarification pond system. The main contaminants are Zn and N predominantly from the mine water. The mine water contains approximately 4.5 mg/l Zn and up to 50 mg/l of total N. Major reductions in the discharge of Zn to the environment have been obtained by pumping the mine water together with the tailings slurry to the tailings pond, whereby the Zn adsorbs to the mineral surfaces. Laboratory test work has shown that the method effectively reduces the Zn concentration in the mine water from 4.5 mg/l to less than 0.2 mg/l in 40 min. N compounds are partially degraded in the tailings and clarification ponds. In 1998, it was estimated that about 10 tonnes of N was added to the system from the mine water. [64, Base metals group, 2002].

At **Hitura**, emissions from the TMF to groundwater have been reported. Exact figures are not available. The flow of groundwater has been cut and the contaminated water is back-pumped and led to the river [62, Himmi, 2002].

In the **Legnica-Glogow copper basin** tailings pond to keep the balance of water and its salinity in the circuit, an average of 60000 m³/d of clarified water, containing 16-20 g/l total suspended solids, must leave the system. The discharged water is pumped to the Oder River by a pipeline of 17 km. The amount of the water is controlled to correspond to the current river flow, so that the sum of chlorides and sulphates in the Oder does not exceed 500 mg/l. To eliminate a local higher concentration of total suspended solids in the river, the discharging system distributes the discharged water at the bottom, across the whole cross-section of the river.

The concentration of suspended solids in water leaving the pond varies, depending on its current volume in the pond and weather conditions. As the suspended solids contain heavy metals, a water treatment plant is temporarily put into operation to clean the discharged water to the level of <50 mg/l.

The purification technology is based on coagulation (with about 300 mg/l ferric chloride) supported with polyelectrolyte praestol (1 mg/dm³) and sedimentation in a lamella settling tank. Table 3.34 and Table 3.35. show total emission to water and concentrations in the emissions from the tailings management facilities. [113, S.A., 2002]

At **Lisheen** arsenic is treated with ferric sulphate if the concentration in the discharge is above 0.0048 mg/l. Thereby, the arsenic is precipitated as a meta-stable ferric arsenate compound. Similarly if cyanide is added in the process as a suppressant and the concentrations in the discharge approach 0.048 mg/l, the CN will be destroyed [75, Minorco Lisheen/Ivernia West, 1995].

At **Zinkgruvan**, the tailings and tailings pond system constitutes a very good treatment facility for the process and mine water due to its high adsorption capacity. By fully utilising the characteristics of the system and passing all mine and process waters through the system significant reductions in Zn discharge have been achieved over the last 15 year period as illustrated in the figure below.

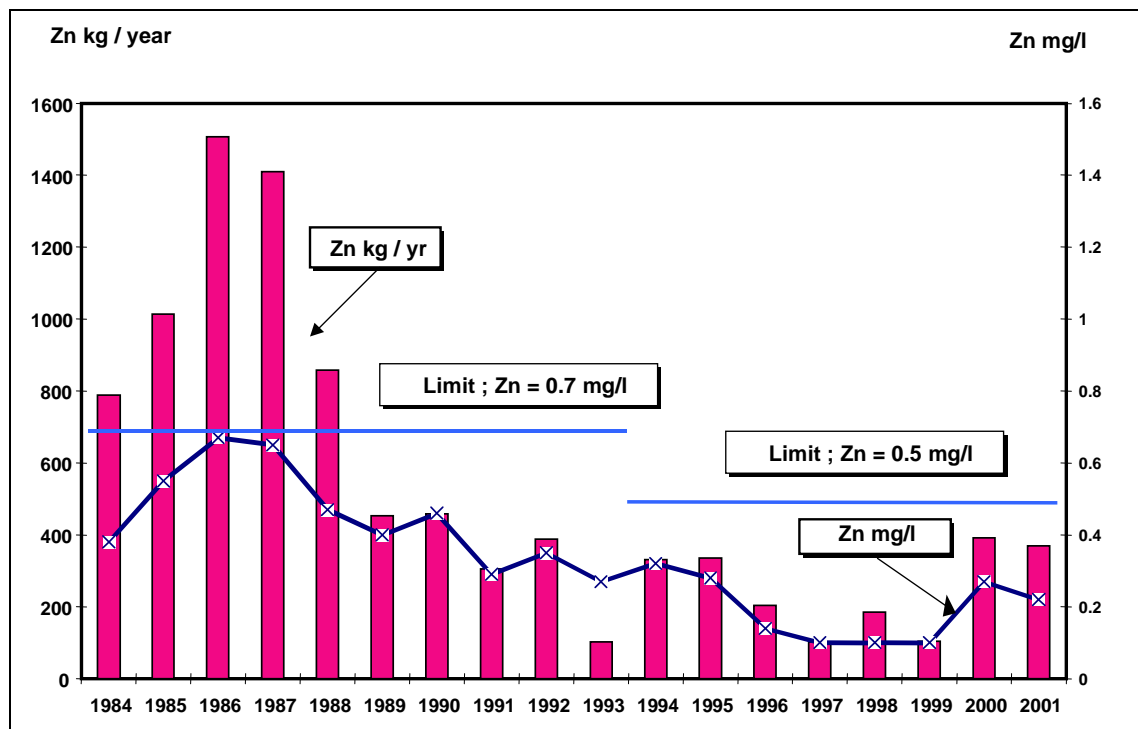

Figure 3.28: Annual average zinc concentration (in mg/l) in excess water from the clearing pond to the recipient and calculated transport (kg/yr) 1984 - 2000 [66, Base metals group, 2002]

3.1.2.5.4 Soil contamination

In an area of about 400 m around the TMF, soil contamination was discovered at **Hitura**. At **Pyhäsalmi**, soil contamination in the close environment of the plant has been observed. This was caused by sulphur (pyrite) dusting. No significant contents of heavy metals or chemicals have been reported in the soil.

[62, Himmi, 2002]

Every year soil contamination is monitored in 54 points located within close proximity (50-2000 m) of the **Legnica-Glogow copper basin** tailings pond. The results obtained from 1996-2001 indicate that a higher concentration of copper in the soil is found only in the closest proximity to the dam. The concentrations of the other metals are at background level.

[113, S.A., 2002]

3.1.2.5.5 Energy consumption

The following table summarises the energy consumption of base metal sites.

Energy consumption	Units	Site						
		Aitik	Boliden	Garpenberg	Hitura	Neves Corvo	Pyhäsalmi	Lisheen
Mine	kWh/t ¹	n/d	n/d	n/d	n/d	21.44	n/d	n/d
Mineral processing plant, total	kWh/t ¹	n/d	n/d	n/d	32.8	36.95	34.9	47.3
	GWh ¹	n/d	n/d	n/d	n/d		n/d	53.4
Grinding	kWh/t ¹	11 - 12	22	n/d	n/d	24.93	n/d	20.6
Dewatering	kWh/t ¹	n/d		n/d	0.22	1.28	3.9	n/d
TMF	kWh/t ¹	2	2	3	1	1.97	1.6	n/d
Waste-rock management	kWh/t ¹	n/d	n/d	n/d	n/d	n/d	n/d	n/d
Total electrical	kWh/t ¹	22.1	n/d	n/d	n/d	n/d	n/d	n/d
Total all energies	GWh	545.5	214.6	123.5	n/d	n/d	n/d	n/d
	kWh/t	30.7	148	126	n/d	n/d	n/d	n/d
Ore processed	Million tonnes	17.77	1.45	0.98	0.52	1.75	1.25	1.15

1. Electrical energy

Table 3.36: Energy consumption at base metal sites

3.1.3 Chromium

This section contains information about the Kemi chromium mine in Finland. All information taken from [71, Himmi, 2002].

3.1.3.1 Mineralogy and mining techniques

Chromite forms in deep ultramafic magmas and is one of the first minerals to crystallise. It is because of this fact that chromite is found in some concentrated ore bodies. As magma slowly cools inside the earth's crust, chromite crystals form and, because of their density, settle at the bottom of the magma and are concentrated there.

The chromium ores at **Kemi** are associated with a mafic-ultramafic layered intrusion within the contact between migmatite granite and schist. The formation starts at the town of Kemi and extends approximately 15 km NE, with a maximum width of 1500 m. The compact chromite-rich horizon appears 50 - 200 m above the bottom of the formation. The thickness of the continuous chromite horizon varies from a few millimetres to a couple of metres, but in the Nuottijärvi-Elijärvi area, the chromite layer contains eight layers, which are economically viable over a distance of 4.5 km. Both host rock is serpentinite and talc-carbonate rock. Idiomorphic chromite is the only ore mineral appearing in economic quantities. The average content of the ore is 26 % Cr₂O₃ and the Cr/Fe ratio is 1.55.

The **Kemi** chromium mine is an open pit mine with a waste-rock to ore ratio of 5.5:1. The mine production in 1999 was approx. 250000 tonnes.

3.1.3.2 Mineral processing

At Kemi, the ore from the mine contains 11 % iron and 25.5 % Cr_2O_3 . After the mineral processing the concentrate contains between 35 % Cr_2O_3 in the coarse fraction (lumps) and 44 % of Cr_2O_3 in the fines.

The flow sheet of the Kemi site is given below:

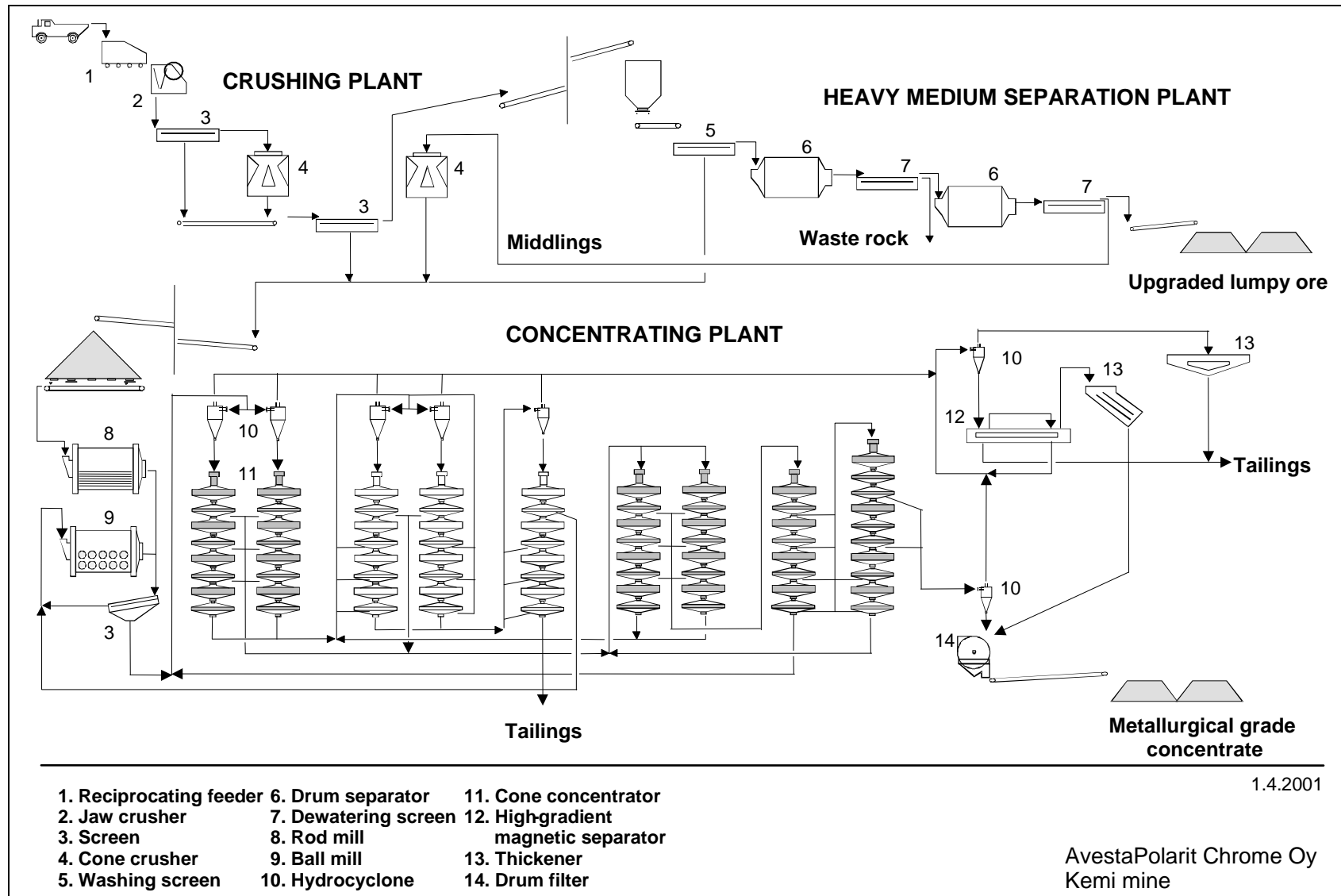

Figure 3.29: Flow sheet of the mineral processing plant at Kemi [71, Himmi, 2002]

The process steps will be explained in the following sections in more detail.

The mineral processing plant operates at 207 t/h.

Size reduction at Kemi is carried out as follows:

- crushing in three stages with a jaw crusher and two cone crushers
- grinding in two stages with a rod mill (Ø 3.2 x 4.5 m) and a ball mill (Ø 2.7 x 3.6 m).

The following equipment and techniques are used at Kemi to separate the mineral from the gangue:

- two drum separators and three dewatering screens in a dens medium separation plant for lumps
- nine cone separators and a high-gradient magnetic separator in the concentrating plant for fine material.

3.1.3.3 Tailings management

3.1.3.3.1 Characteristics of tailings

The chemical composition of both types of tailings at the Kemi site has been determined and leaching behaviour (max. solubility/DIN 38614-S4 by Kuryk's method and long-term behaviour) have been investigated in laboratory scale simulation tests. Also laboratory scale wind erosion tests have been done. In the tailings material, the most significant contents are Cr and Ni, which occur as insoluble compounds and are considered by the operator not to cause any negative effects.

3.1.3.3.2 Applied management methods

The Kemi TMF consists of three active and three decommissioned ponds and a total area of 120 ha. The tailings are pumped from the process to a first pond where the solids settle before the free water is led to one of the two clarification ponds. Water is re-used in the process. Excess water is led to the river system. One of the decommissioned ponds has been covered and landscaped, the remaining two await landscaping.

The distance between the mill and the TMF area is about 1 km. A stream runs just beside the ponds. The quality of water in the stream is poor as it comes from a moss area. Very close to the mine and the TMF there is a moss protection area. So, in respect of flora and fauna the area is sensitive. Drainage water leaks directly to the stream without any special collecting ditch and control system.

No baseline studies have been done.

The TMF has been built on flat land with paddock-style dams. The starter dams have been made of moraine and are founded on stable and low permeable soil. The supporting body has been made of broken rock. Where necessary, to improve the stability of the dams, counter banks are built.

The tailings from the process are distributed directly from the tailings pipe around the first tailings pond. The outlet is moved periodically so that the pond will be equally filled. The dams are raised annually with moraine and broken rock as a supporting body. External experts are usually involved when plans to raise the dam are first made.

The dam of the clarification pond is made of moraine and lined with broken rock to prevent erosion.

The tailings management area was designed in 1960`s and no closure or after-care plans were taken into account at that time. However a risk assessment has been performed more recently.

3.1.3.3 Safety of the TMF and accident prevention

The system has been constructed so that the surface of the water in the tailings area can be kept in balance and the excess of water, from rainfall etc., can be removed in a controlled manner.

The tailings management area is inspected daily by the operators of the mineral processing plant. The dams are inspected annually by an external expert and at five-year intervals by the dam safety authority. The comments have to be recorded in a Dam Safety Document.

As a result of recent legislation a documented emergency plan must now be created.
[71, Himmi, 2002]

3.1.3.4 Waste-rock management

Currently at **Kemi** waste-rock is deposited in three separate areas close to the mine. From 2003 the mine production will gradually change towards underground mining. The annual amount of waste-rock will, therefore, decrease and by the end of the decade all waste-rock will be directly backfilled in the underground mine. Waste-rock material from the old waste-rock dumps will also be used as backfilling material in the future.

The most important design parameters in the construction of the waste-rock heaps were:

- high stability of strata
- low permeability of the underlying strata
- short transport distance from mine
- good possibilities for material use in the future.

Drainage from the waste-rock dump area is not specifically monitored, but emissions are included in the emission figures (see Section 3.1.3.5.3), relating to calculations made according to regular samples taken from the stream both above and below the mining site.

Part of the drainage water is collected in a ditch and is led with other drainage waters from the industrial area to the tailings management area. There is also a part of the drainage that drains directly to the nearby stream.

3.1.3.4.1 Site closure and after-care

No plans for closure or after-care have been made. Also, no money has been reserved for closure and after-care.

The expected lifetime of Kemi Chromium Mine is tens of years. Therefore, no closure plans have been developed, as it can be assumed that both technical and economic plans will be further developed. There are no legal requirements to reserve money for closure and after-care.

As described above, waste-rock material will be used as the backfilling material in the underground mine in the future. No alternative use for the waste-rock can be foreseen. A plan for landscaping has been made, but no further closure plans exist.

3.1.3.5 Current emissions and consumption levels

3.1.3.5.1 Management of water and reagents

The following table shows the reagents and steel in the mills consumed per tonne of ore processed.

Reagent	Consumption (g/t of ore processed)
Flocculant	13
Steel balls	50
Steel rods	200
Ferrosilicone (for dens media separation)	80

Table 3.37: Consumption of reagents and steel at the Kemi site

In the process there are arrangements to carry out internal re-circulation of process water to minimise fresh water consumption. Re-use of the clarified water from the tailings management area covers almost 100 % of the total demand of water in the process. Sometimes (usually, when a dam raise is ongoing) it is necessary to add fresh water. Excess water from the system is removed to the stream without any further treatment.

A water balance is not available.

3.1.3.5.2 Emissions to air

Dust emissions are not regarded as a significant problem. The mineral processing plant has de-dusting equipment installed. The dust emissions from the mineral processing plant have been estimated to be approx. 1.8 t/yr. The area of influence is assumed to be very limited based on results from moss investigations. At intervals of five years, sampling of moss is carried out for determination of heavy metals and suspended particles.

Dust from the open pit and loading area has been estimated to be around 30 t/yr. Also in this case the area of influence is very limited.

Emissions from the waste-rock dumps to air are not specifically monitored. However, any dusting from the dumps is monitored in an integrated way for all emissions to air in the moss-investigations described above.

3.1.3.5.3 Emissions to water

The discharge to the stream is sampled on a monthly basis and is carried out by an external expert, also taking samples from the surrounding streams.

For the year 2000, the total emissions to surface water are summarised in the table below. The year 2000 was exceptionally rainy and wet, which resulted in extraordinarily high amounts of discharge from the pond system. However, this did not influence the other parameters listed in the table.

Parameter	Units	Amounts
Discharge from pond system	Mm ³	1.67
Ca	t	191
Fe	kg	11000
total solids	t	33
Cr in total solids	kg	79

Table 3.38: Emissions to surface water at Kemi site

3.1.3.5.4 Soil contamination

No significant soil contamination has been reported at Kemi. Limited areas, such as locations of old stockpiles of chromium concentrate, may be contaminated.

3.1.3.5.5 Energy consumption

The energy consumption for the tailings management is given in the table below for the year 2000.

Process step	Electrical energy consumption (kWh/tonne of ore processed)
Mineral processing	16.6
Dewatering	1.5
Tailings management	0.9

Table 3.39: Energy consumption data at Kemi site

3.1.4 Iron

This section includes information about the **Kiruna** and **Malmberget** mines in Sweden and the **Steirischer Erzberg** in Austria

3.1.4.1 Mineralogy and mining techniques

Commercial grade iron ores are mainly mined from proterozoic sedimentary banded iron formations. The major ore minerals are haematite (Fe_2O_3), magnetite (Fe_3O_4) and siderite (in order of importance). The main world producers are Russia, Brazil, China, Australia, India and the US. In Europe, the main producer of iron ore is Sweden. Its occurrences are phosphorous magnetite ores, which are related to proterozoic syenite porphyry volcanic activity. Several smaller mines, mainly in Central and Southern Europe (e.g. 'Steirischer Erzberg') produce lower grade siderite iron ores (iron carbonates), which are also sediment-related ore formations.

Mining operations normally consist of preparation, including stripping or drifting, drilling, blasting and transportation prior to processing.

[49, Iron group, 2002]

Underground mines

The magnetite orebody in the **Kiruna mine** is about four kilometres long with an average width of 80 m and extends to an estimated depth of around two kilometres at an incline of roughly 60°. The main haulage level is at a depth of 1045 m. Mining of the orebody between the 1045 m and 775 m levels will continue until about the year 2018. To date, about 940 million tonnes of ore have been extracted from the Kiruna orebody. Approximately 20 - 23 million tonnes of crude ore is mined every year from the ore, sending approximately 5 million tonnes to the coarse tailings facility and 1.7 million tonnes to the fine tailings facility.

The orebody is divided into ten blocks. Each block has its own group of shafts, each consisting of four shafts, except for the two northernmost blocks (the Lake Ore), which have three. In total, the Kiruna mine has 38 such shafts. Each shaft in a group is about 30 m from the next. The ten mining blocks are accessed via five separate ramps. An extension of each ramp is cut into the two neighbouring blocks on one side. By linking the blocks in this way, five smaller "mines" are created. Each block has its own air intake and exhaust shafts. The geographic division of the orebody into five mines enables greater mining efficiency. Since the mines are well separated from each other, ore can be extracted from one mine while blasting or maintenance are taking place in another. The mining operation passed the 775 m level in the summer of 1999. Mining will take place above the 1045 m level until the year 2018. The orebody between 775 m and

1045 m is divided horizontally into nine slices, each of which is 27.5 m high. The distance between ore passes is 25 m. Each blast brings down about 10000 tonnes of ore.
[49, Iron group, 2002]

The **Malmberget mine** consists of about 20 ore bodies, 10 of which are currently being mined. Most of the ore base is magnetite, but there are also occurrences of non-magnetic haematite ore. Malmberget's newest main haulage level is at a depth of 1000 m. Up until now, about 350 million tonnes have been extracted from the ore bodies. About 12 million tonnes of crude ore are mined from the ore bodies every year, generating 5.6 million tonnes of tailings each year.

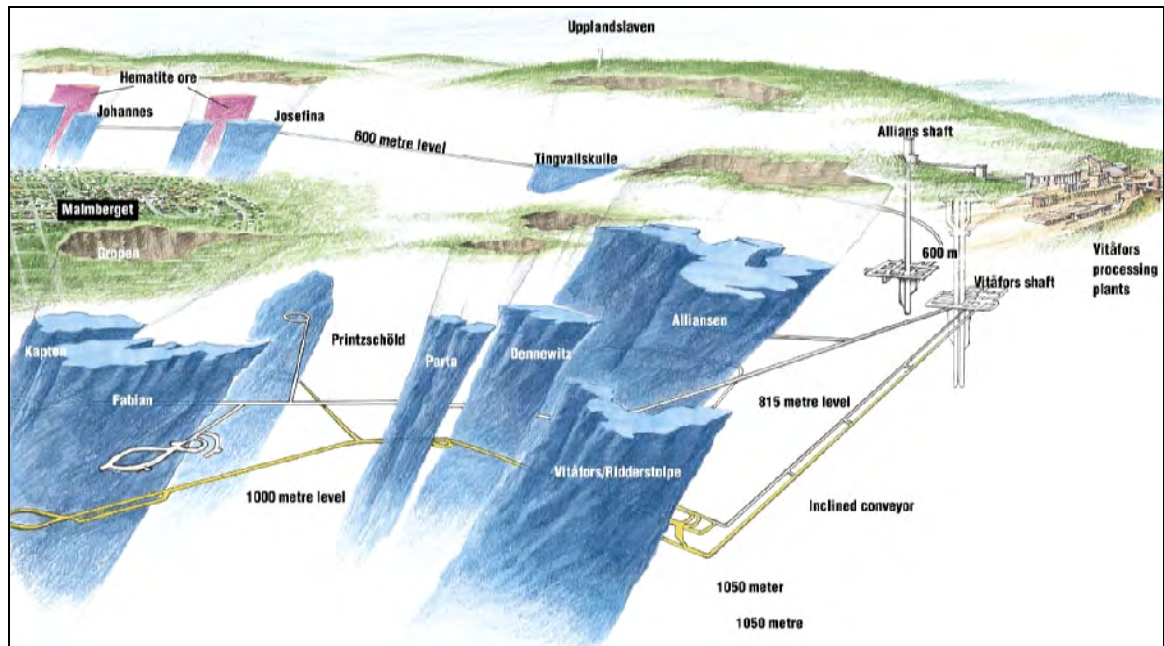

Figure 3.30: Illustration of the Malmberget ore deposit
[49, Iron group, 2002]

The ore field is 4.5 km long in an E – W direction and 2.5 km in a N – S extension. In the western part of the mine, the ores form more or less continuous undulating bands of lens-shaped ore bodies. The ores in the eastern part of the mine exhibit a more complicated, intensively folded, tectonical structure. The ore bodies are steep with great local variations. The thickness of the ore bodies varies between 20 and 100 m. The host rock is acidic to intermediate highly deformed and metamorphosed volcanic rocks, now appearing as 'leptites' (fine-grained feldspar-quartz rocks) and gneisses. The ore field is generally metamorphosed to lower amphibolite facies. In the western part of the ore field, local higher metamorphosed grade occurs.

Both Swedish mines use large-scale sub-level caving as their mining method.

Preparation/Development

At **Kiruna**, the first step is to develop drifts straight into the orebody. Drilling is done with electric-powered hydraulic drill rigs. Rounds of up to 60 holes, each five metres deep, are drilled. These holes are then charged with explosive and blasted. Rounds are blasted during the night. Ore from these blasts is removed with loaders. Then, the next round is drilled, etc., until the entire development drift is ready. Drifts can be up to 80 m long. If necessary, the walls and roofs are reinforced with rock bolts and/or concrete (so-called 'shotcrete'). Once the initial development work is completed, or when a number of cross-cuts in the same area are ready, the next step in the production chain commences, i.e. production drilling and blasting.

Production

When a number of development drifts have been developed, production drilling of a 27.5 m high 'slice' can begin. This is carried out by remote-controlled production drill rigs. The operators control several rigs in the production area by remote control from control rooms. The rig drills upwards into the ore, forming fan-shaped patterns, each with ten holes. The holes are normally 40 - 45 m long, and straight, so that subsequent loading with explosives and blasting can be done efficiently. When a pattern of holes has been drilled, the rig is moved back three metres, then drilling of the next pattern begins. About 20 of these patterns will be drilled in an 80 m long drift. Once this is completed, loading of the holes can begin.

A robot injects explosives into the drill holes in one pattern. Blasting is done every night. Each round brings down about 10000 tonnes of ore. When the blast has been ventilated, loading with wheeled loaders (LHD) can begin. Then, the next pattern is charged, etc. The procedure is repeated until the entire ore pass has been mined out. Electric wheeled loaders load and carry the ore to vertical shafts (ore passes), located along the orebody. Each loader carries a bucket payload of 17 - 25 tonnes and tips its load to an ore pass. By gravity the ore falls down to bins, located just above the main level.

In the **Kiruna** mine remote control electric loaders are also utilised. Here, the operator sits in front of a monitor in a control room, and 'drives' the machines in the production area. The machines navigate with the help of rotating lasers and reflectors on the walls of the drifts. Information, such as the position of the machine, is sent via a number of wireless base stations to the control system in the control room computer.

The main haulage level in the Kiruna mine is at the 1045 m level. Ore is tapped via remote control from the bins into railway cars. A driverless train, consisting of an engine and 24 cars, carries the ore to one of four discharge stations. When the train passes the station, the bottoms of the cars open and the ore falls down into a crusher bin, from which it is fed to one of four crushers. The ore is crushed into lumps of about 100 mm diameter. Nine locomotives and about 185 cars are operated on the main level. Each train carries approx 500 tonnes of ore.

Mining in **Malmberget** takes place at several different levels, as there are many ore bodies. The main haulage levels are at 600, 815 and 1000 m. There are crushers at each level. Twelve large mine trucks, with payload capacities of 70 to 120 tonnes, are operated at these levels. The trucks are driven to vertical shafts. Drivers control loading from inside the cab of the truck. The fully-loaded truck is then driven to a discharge station and the ore is emptied, sideways, into a crusher bin. This is also controlled from the cab of the truck. The ore is fed into the crusher and crushed into lumps of about 100 mm diameter.

[49, Iron group, 2002]

Open pit mines

The valuable mineral at **Steirischer Erzberg** is the iron-mineral siderite and the gangue mineral is ankerite. The iron content of the ore is approx. 21 %.

The Erzberg mine is an open pit operation, with a yearly production of 3.8 million tonnes/yr, of which 1.2 million tonnes is waste-rock. Conventional drilling and blasting are used. Transportation is carried out with wheel loaders and trucks. Within the pit there are 20 benches with an average height of 24 m in operation.

[55, Iron group, 2002]

3.1.4.2 Mineral processing

Typically after extraction, the ore is crushed and ground in various stages to achieve the required size. This is followed by either screening to final products, lumps and fines, or further treatment. The choice of the mineral processing methods depends on the ore type, chemical composition, fineness, etc. The most common methods used are magnetic separation, usually high intensity magnets for concentrating haematite ores and low intensity for magnetite, as well as gravity separation and flotation. The grade of the ore and the treatment method both influence the amount, type and composition of the tailings.

[49, Iron group, 2002]

At **Steirischer Erzberg** the mineral processing plant treats 1.7 million tonnes of ore per year of which 0.98 million tonnes becomes concentrate, 0.7 million tonnes coarse tailings (co-deposited together with waste-rock) and 0.1 million tonnes fine tailings. 0.9 million tonnes of ore per year is sold directly as low-grade ore without processing.

3.1.4.2.1 Comminution

The **Kiruna** and **Malmberget** operations include in pit crushers (product 100 % passing 100 mm) and secondary crushing for sinter feed production. In-pit crushing, secondary crushing, AG mill/ball mills and pebble mills are applied for pellet production [49, Iron group, 2002]. At the **Erzberg** operation, two gyratory crushers (product 100 % passing 120 mm) and secondary crushing are applied [55, Iron group, 2002].

3.1.4.2.2 Separation

The **Kiruna and Malmberget** operations use dry magnetic separation (in the so-called 'sorting plant') followed by wet magnetic separation for the sinter feed production. Dry magnetic separation, wet magnetic separation, hydrocycloning and flotation are applied for the pellets production in the so-called 'concentrator' (in Malmberget no flotation is required) [49, Iron group, 2002].

The following figure shows the Kiruna concentrator, which generates the feed for the pellet plant.

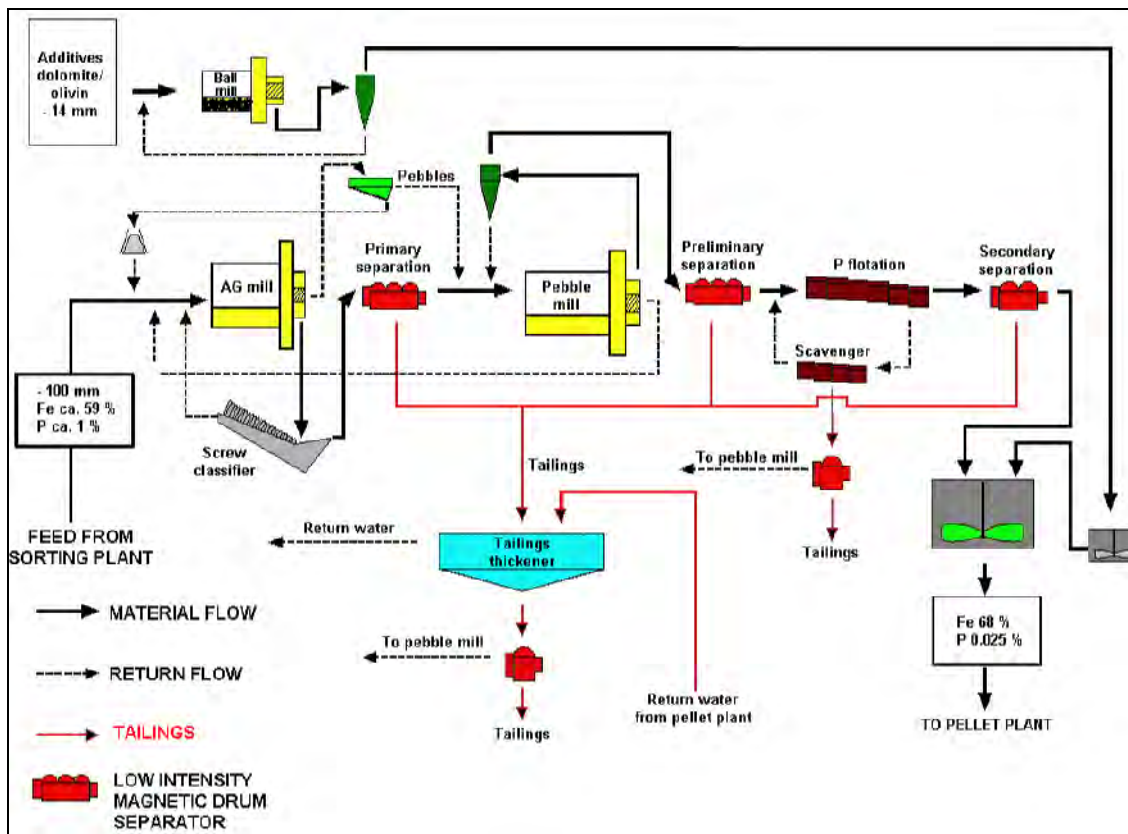

Figure 3.31: Kiruna concentrator

At **Erzberg** the coarse fraction, i.e. 8 - 30 mm and 30 - 120 mm, are separated by dense medium separation. Finer fractions, 1 - 4 mm and 1 - 8 mm, are separated by dry high intensity magnetic separation. The concentrate is further crushed to <8 mm. The fines, 0.1 - 1 mm, are dewatered via screw classifiers and are hauled, together with coarse tailings from the dense medium separation and the high intensity magnetic separation, to heaps within the mining area. Blending of the concentrate with 'direct ore' (ore that is not processed) is done in the final crushing and screening.

The process water, which is mainly the overflow from the screw classifiers, is treated in three 32 m continuous thickeners. The overflow is recycled back to the process, whilst the thickened slurry is pumped to tailings pond.

[55, Iron group, 2002]

3.1.4.3 Tailings management

3.1.4.3.1 Characteristics of tailings

Iron ores are usually mined as oxides (e.g. Kiruna and Malmberget) or as carbonates. Two tailings fractions, coarse and fines, are generated in the mineral processing step. The coarse tailings are managed on heaps and the fines are pumped into ponds. The tailings and waste-rock, if the iron is mined as oxides, are not acid generating.

The tailings from iron ore production are well characterised in the **Kiruna** area with regards to

- mineralogy
- geochemistry (kinetic leaching tests, trace element analysis)
- mechanical/geotechnical properties.

The tailings material at **Malmberget** has not been characterised.
[49, Iron group, 2002]

Example results from Kiruna are given in the tables below.

Compounds	Average Concentration (wt. %)
SiO ₂	33.82
TiO ₂	1.21
Al ₂ O ₃	6.82
MnO	0.15
MgO	6.9
CaO	15.7
Na ₂ O	2.02
K ₂ O	1.89
V ₂ O ₅	0.06
P ₂ O ₅	8.1
Fe _x O _y	16.5
Total	93.17
Element	
Fe	11.6
P	3.55
S	0.35

Table 3.40: Average concentrations in wet-sorting tailings from Kiruna and Svappavaarra
[82, Iron group, 2002]

Element	Wet-sorted tailings (ppm)	Other tailings (ppm)
As	3.67	18.1
Ba	168	205
Be	8.25	6.10
Cd	0.14	0.10
Co	94.2	67
Cr	13.4	23.5
Cu	356	211
Hg	<0.0400	0.060
La	107	331
Mo	15.4	11.8
Nb	11.9	<12.0
Ni	82.4	56.5
Pb	9.35	7.56
S	4990	4130
Sc	48.2	26.7
Sn	36.8	31.1
Sr	30.3	80.4
V	523	290
W	11.9	<12.0
Y	40.6	170
Yb	7.78	15.4
Zn	53.5	42.5
Zr	114	161

Notes: Samples marked with < are below detection limit, the numbers indicate the detection limit

Table 3.41: Average trace element concentrations for wet-sorting tailings and other tailings material at Kiruna and Svappavaarra
[49, Iron group, 2002]

Geotechnical properties for the tailings material in Kiruna have been investigated for its use as a dam construction material. It was concluded that the tailings need to be cycloned in order to fulfil the requirements for dam construction due to the grain size distribution.

Undisturbed samples of tailings have been taken at different depths in the impoundment in both Kiruna and Svappavaara. The typical results are:

- bulk density 1.71 - 2.30 t/m³
- calculated dry density 1.66 - 1.97 t/m³
- density of particles 3.2 t/m³
- friction angle 19° - 26.5°

Samples of tailings material collected from the gravity separation circuits (excluding particles from the pellet production) show the following grain size distribution:

Size (µm)	Cumulative % passing
700	100
60	75
2	5

Table 3.42: Size distribution of tailings from gravity separation [49, Iron group, 2002]

Samples of tailings material collected after the separation by screw classifiers show the following, slightly finer, grain distribution:

Size (µm)	Cumulative % passing
60	91
40	80
2	8.8

Table 3.43: Size distribution of tailings after separation by screw classifiers [49, Iron group, 2002]

Samples are collected on a frequent basis from the tailings deposition stream in order to evaluate the efficiency of the separation method.

3.1.4.3.2 Applied management methods

Note: The coarser part of the tailings which is co-deposited with waste-rock, is regarded as waste-rock and will be described in the waste-rock section (see below).

Kiruna (which has tailings ponds in Kiruna and Svappavaara) and **Malmberget** tailings facilities consist of tailings ponds and subsequent clarification ponds. All operations deposit their tailings using hydraulic methods (pumping in pipelines or by gravity flow in trenches). Conventional earth dams are used for all dams. The core consists of compacted till and filters. Support fill consists mainly of waste-rock. The three tailings ponds are described in detail below, with key information for each tailings pond being summarised in tables as well. All sites follow a very similar tailings management since the material being deposited, as well as the meteorological, geological and hydrological settings, are relatively similar.

At all sites, tailings slurries have a low solids content, ranging from 3 – 5 % to 10 – 15 %. The discharge point has remained in nearly the same location throughout the operation of the tailings ponds. In order to increase the solids content and to change the distribution of the tailings, the use of a mobile discharge point or cyclones have been discussed for future raises of the dams.

The freeboard at the tailings dams are 2 m at two of the facilities and 1.2 m at the third. The freeboard at **Kiruna** and **Malmberget** is based on Swedish guidelines for water retention dams (RIDAS), and includes precipitation, inclined water surface and wave run up. For a class 2 dam it should be possible to decant excess water from a one in a 100 year event, 24 hours rainstorm event, without a rise in the water level. The discharge of tailings into the ponds is controlled by a relatively constant operation system which produces a constant flow of tailings.

The starter dam at the tailings facility in **Kiruna** was originally completed in 1977. The tailings dam was then raised twice in 1984 and 1992 using the centreline method. The current maximum dam height at Kiruna is 15 m. A new rise has been applied for since the impoundment will be full at the end of 2003.

From the tailings pond, water is decanted to the clarification pond through two decants. These decants each consist of two vertical intake towers, with a submerged intake level, due to ice forming on the surface in winter. From the intake towers, horizontal pipes connect into one pipe/culvert (1400 mm in diameter) per decant going under the dam. Downstream of the dam there is a control chamber from where it is possible to regulate the flow. From the clarification pond, the water is decanted in a similar way, although with one change being that downstream of the clarification pond the water is pumped back to the process via a storage pond near the plant or discharged into the recipient. As a result of the new guidelines, a new emergency outlet was constructed for the clarification pond in the year 2000. The emergency outlet consists of a 13.5 m wide channel through the top of the dam near one of the abutments.

The main technical characteristics of the Kiruna tailings dam system are summarised in the following table.

Dam type	Tailings dam			Clarification pond	
	Off-valley site			Off-valley site	
Dam area (km ²)	4.2			0.96	
Tailings volume	9			n/a	
Water volume (Mm ³)	7.4			2.3	
Dam body	C-D	O-R	R-B	R-S	S-F
Dam type	Centreline	Centreline	Centreline	Centreline	Centreline
Highest height (m)	8	15	15	11	13
Dam length (m)	1450	2560	1040	1440	850
Dam width (m)	15	15	15	15	15
Lowest freeboard (m)	2.0 ¹⁾	2.0 ¹⁾	2.0 ¹⁾	2.0 ¹⁾	2.0 ¹⁾
Upstream slope	1:1.8	1:1.8	1:1.8	1:2	1:2
Downstream slope	1:1.4	1:1.4	1:1.4	1:1.5	1:1.5
Volume of dam construction material (Mm ³)	0.66	1.58	0.86	3.00	0.39
Core width	4	4	4	4	4
Fine filter width, (m)	1.5	1.5	1.5	1.5	1.5
Fine filter grain size (mm)	0 - 6 or 0 - 8	0 - 6 or 0 - 8	0 - 6 or 0 - 8	0 - 6 or 0 - 8	0 - 6 or 0 - 8
Coarse filter width (m)	0 - 30 or 0 - 100	0 - 30 or 0 - 100	0 - 30 or 0 - 100	0 - 30 or 0 - 100	0 - 30 or 0 - 100
Support fill and erosion protection material	Waste-rock	Waste-rock	Waste-rock	Waste-rock	Waste-rock
Support fill grain size (mm)	0 - 200	0 - 200	0 - 200	0 - 200	0 - 200
Erosion protection grain size (mm)	0 - 100	0 - 100	0 - 100	0 - 100	0 - 100
Discharge arrangement			2 decant towers	Emergency overflow	2 decant towers

Table 3.44: Characteristics of the Kiruna tailings dam system [49, Iron group, 2002]

The other tailings facility used for ore from **Kiruna** processed in Svappavaara is Svappavaara tailings facility, 50 km south-east of Kiruna. This facility consists of three ponds, the tailings pond, the first clarification pond and a second clarification pond called the recipient pond. In addition to these constructed ponds, a natural lake, is used as a water resource. All dams are valley-site impoundments.

The recipient pond was the first to be built, and came into operation in 1964. The purpose was to collect the draining water from the tailings settling naturally on the hillside. Water was then decanted from the recipient pond to a lake. Because of the properties of the tailings and due to the terrain, (i.e. steep ground) most tailings settled too close to the downstream dam. Therefore, a second retention dam, i.e. the tailings dam, was constructed to prevent the tailings from settling too close to the recipient dam, which has since then worked as a clarification pond. Later, in 1973, a third dam was constructed right across the tailings impoundment, to keep the tailings in the upstream part and use the downstream part as a clarification pond. This dam is constructed of rock fill as a draining dam. Due to problems with ice an overflow outlet was constructed in this dam in 2001.

From the first clarification pond the water is decanted to the recipient pond by two decants with vertical intake towers and horizontal culverts under the dam. Stop logs at the intake tower regulate the water flow. The decant at the recipient dam is similar to the ones in Kiruna where the water is regulated from the downstream side. From there the water can be pumped back to the process via a lake or discharged to the recipient. Normally, no excess water results as most of the water is re-circulated.

The dams around the tailings pond and clarification pond as well as the rock fill dam dividing the two has been raised several times (11 times in total). For the downstream clarification dam the downstream method has been used and for the tailings dam an the rock fill dam the upstream method has been used. The maximum height today is 21 m and approximately 15 million tonnes (dry weight) of tailings have so far been deposited.

[49, Iron group, 2002]

The technical characteristics of the Svappavaara tailings dam system are summarised in the following table.

	Tailings pond		Clarification pond	Recipient pond
Dam type	Off-valley		Off-valley	Off-valley
Dam area, km ²	1.2		0.7	0.42
Tailings volume, Mm ³	4.5		1.5	0.2
Water volume, Mm ³	0.4		4.5	0.45
Dam section	Soil dam	Blocking dam	Soil dam	Recipient dam
Dam type	Upstream	Upstream	Downstream	Downstream
Max. height, m	15	15.5	21	10
Dam length, m	2030	1100	2350	800
Dam width, m	8.3	12	7.2	6.0
Smallest freeboard, m	2.0		1.8	2.5
Upstream slope	1:2	1:1	1:2	1:2
Downstream slope	1:1.5	1:3/1:7	1:1.5	1:1.8
Approx. volume of dam construction material used to date, Mm ³	0.36	0.5	0.46	0.17
Discharge arrangement		overflow outlet	2 decants	1 decant

Table 3.45: Characteristics of the Svappavaara tailings dam system

[49, Iron group, 2002]

Tailings pond

- soil dam

The starter dams comprises a homogeneous moraine material with an erosion cover of 0 - 100 mm grain size. The erosion cover is 1 m thick on the downstream slope and 1.5 m thick on the upstream slope. The slope angle is 1:1.5 and 1:2 for the downstream and upstream slopes, respectively. Height increases of the dam have been constructed based on the upstream method with a four metres thick impervious core consisting of moraine material. There is a one metre thick transition layer on both sides of the core with a grain size of 0 - 100 mm. The erosion cover on the downstream side is approximately 0.5 m thick with a grain size range of 0 - 100 mm. The upstream support fill and erosion cover consist of material with a grain-size range of 0 - 200 mm and 0 - 500 mm, respectively. A two metres increase in dam height, using the downstream method, is planned for the summer of 2002.

- blocking dam

The blocking dam is made with a dam of waste-rock without an impervious core. The dam is built with the upstream method with a grain size range of 0 - 500 mm.

Clarification pond

The clarification pond is built with a soil dam constructed as a conventional dam. The starter dam is made with a homogeneous moraine material with an erosion cover consisting of material with a grain size of 0 - 100 mm. The erosion cover is 1.0 m thick on the downstream slope and 2 m thick on the upstream slope. The slope angles are 1:1.5 and 1:2 for the downstream and upstream slopes, respectively. Further height increases have been constructed based on the centreline method.

Recipient pond

The dam at the 'recipient reservoir' is built as a conventional dam and raised using the centreline method. The vertical impervious core consists of, at the top, a 3 m thick moraine material. On both sides of the impervious core, is a 2 m thick fine-sand filter consisting of a material with grain size range of 0 - 32 mm. Outside the fine filter is a coarse filter material with grain size of 8 - 64 mm. On top of the core and the fine filter is a 0.5 metre thick horizontal layer consisting of bark. The support material consists of blasted rocks on both sides. The downstream slope angle is 1:1.8 and the upstream slope angle is 1:2.

[49, Iron group, 2002]

There are five dams within the **Malmberget** mining operation; tailings dam, clarification pond, pond for biological degradation, a reserve pond and a buffer pond. Only the two first dams are described in this document.

The tailings pond was constructed in a lake. The tailings pond consists of primarily two dams of different design, the B-A dam and the C-D-E-F dam. Water is funnelled through a decant tower from the tailings pond into the clarification pond. Water is then pumped from the clarification pond back to the processing plant.

The tailings dam at Malmberget was originally constructed in 1977 and has been increased in height five times since then. The height of the dam reaches 35 m. It will be full by the end of 2002 and a height increase has been designed using the upstream method. This height increase will secure the tailings deposition for another 25 years assuming today's production rate of 1.5 million tonnes/yr. The whole pond currently contains approximately 16 million tonnes (dry weight) of tailings.

The following table lists the characteristic data for the Malmberget TMF. The tailings dam and clarification pond were constructed using the natural terrain with a main dam at the end of the valley. [49, Iron group, 2002]

	Tailings dam		Clarification pond
Dam type	Valley dam		Valley dam
Dam area (foot print)	1.8 Mm ²		0.12 Mm ²
Tailings volume	16.8 Mm ³		n/a
Water volume	0.4 + 1.2 Mm ³		0.25 Mm ³
Dam section	b-a	c-d-e ₁ -f	j ₁ -j ₂
Dam type	Up/downstream	Downstream	Centre line
Maximum height	13 m	35 m	14 m
Dam length	700 m	2500 m	1100 m
Dam width	40 m	40 m	8.0 m
Smallest freeboard	1.2 m	1.2 m	0.5 m
Upstream slope	1:2	1:2	1:1.5
Downstream slope	1:1.5	1:1.5	1:1.5
Approx. current tailings dam volume	0.2 Mm ³	2.5 Mm ³	0.2 Mm ³

Table 3.46: Characteristic data for the MalMBERGET tailings and clarification ponds and dams [49, Iron group, 2002]

Tailings dam

The dam was designed to span the width of a lake, thus blocking the lake water. The inside of this blocking dam is designed as an upstream dam to level 271 m (see Figure 3.32). The upstream dam is built with a 7 m thick impervious core of moraine material with permeability of 10^{-8} m/s. The impervious core is slanted 1:1.5. Below and above the impervious core is 1 m thick filter with grain size of 0 - 100 mm and a permeability of $1 \times 10^{-3} - 1 \times 10^{-4}$ m/s.

From level 271 m, the dam is built using the downstream method with an inside slope of 1:2 and an outside slope of 1:1.5. Between the support material and the impervious core is a 1 m filter as described above. On top of the core is a 1 m thick erosion layer consisting of material with grain size 0 - 70 mm and permeability of 1×10^{-5} m/s.

[49, Iron group, 2002]

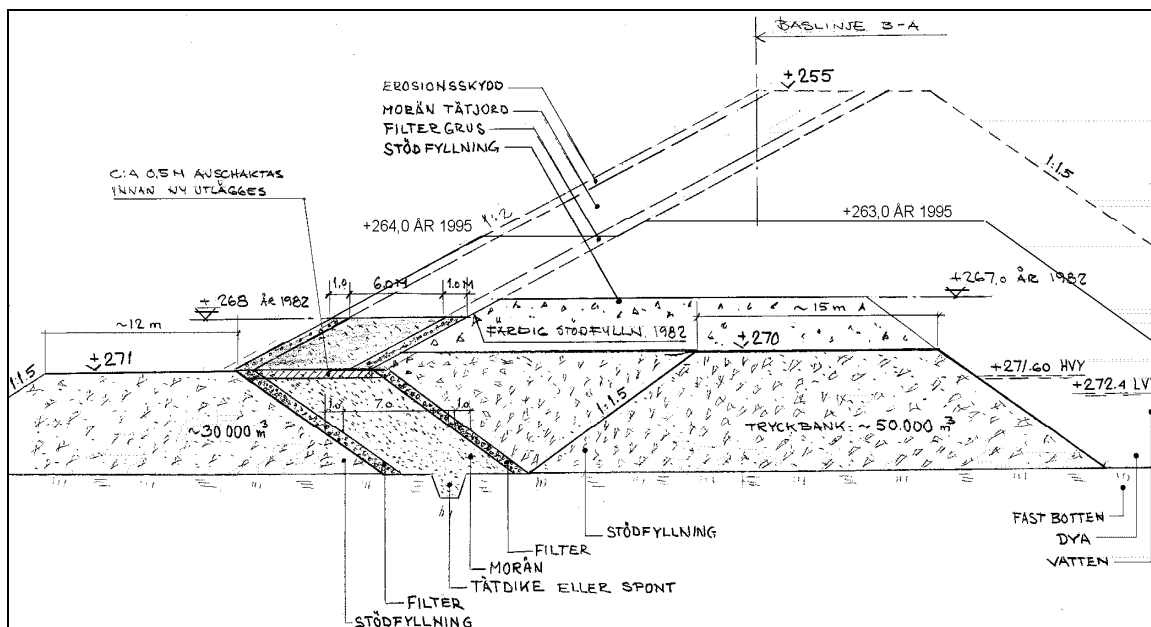

Figure 3.32: Cross-section of MalMBERGET tailing dam

[49, Iron group, 2002]

Clarification pond

The dam of the clarification pond is designed as a conventional dam with a 4 m thick impervious core of moraine material. On each side of the core is a 1 m thick filter layer. Outside this is a support material and on top an erosion layer. Both the support material and the erosion layer are made of coarse dry tailings material. Outside and inside slope are 1:1.5 [49, Iron group, 2002].

At **Steirischer Erzberg**, the tailings facilities where the fine tailings are deposited cover about 40 ha and are divided into 6 tailings ponds of which 3 are currently in operation. Up to 2002, about 5.2 Mm³ (9.4 million tonnes) of tailings materials had been deposited in total. An overview of the operation is given in the figure below.



Figure 3.33: Steirischer Erzberg
[55, Iron group, 2002]

The tailings ponds are built on top of the 50 to 100 m high waste-rock dumps and are constructed to be of low permeability but use infiltration areas to drain off the clarified water. The draining water infiltrates through the waste-rock dump and mixes with the water in a stream that flows underneath the dump. This is described in more detail below.

The distance between the processing plant and the active TMF varies between 500 and 2000 m. The tailings have to be pumped from an altitude of 745 m to an altitude of 873 m and 980 m respectively.

In the first half of the 20th century the area served as a waste-rock dump area for the mining operation. This buried the stream in this valley for practically its total length. The method applied at that time - trail bound transportation with comparatively high dump heights - resulted in a high proportion of big sized blocks at the bases of the dump, due to size segregation. The base of the dump was constructed by removing the topsoil and installation of a bottom layer of big rock blocks. Accordingly, a sufficient permeability for the dewatering of the valley was achieved and has remained intact until now. The majority of the drained water from the dump emerges at the toe of the dump. The dump material is mainly ankerite and limestone.

The fundamental design criteria were stability and tightness to water. All dams are constructed from carbonate tailings (0.15 - 120 mm) and a schist ("Werfener Schiefer") rock layer on the inner side of the dam. Sealing is done by establishing a compressed layer of schist ("Werfener Schiefer") and tailings, which provide, according to the experiences of the company, sufficient impermeability. In order to prove the suitability of the materials and techniques used for dam construction, comprehensive studies were conducted, comprising both in-situ and laboratory tests (geotechnical parameters, permeability, internal friction angle, etc.)

Investigations have shown, that the stability of the dam construction is almost independent of the tailings situation inside the pond, if a sufficiently impermeable seal layer made of compressed schist and tailings is put in place before starting the discharge of tailings. Accordingly the impermeability of the sealing layer is of great importance.

During design and construction, attention was paid to the execution of the sealing layer and the drainage of the tailings water. Depending on the dam material for each pond a particular position is selected for discharge of the water from the pond. These discharge areas are 20 to 30 m in length and consist of weathering resistant materials of appropriate fragmentation in order to warrant the necessary permeability.

[55, Iron group, 2002]

3.1.4.3.3 Development of new deposition methods

The construction of a drained cell pond is currently investigated in **Kiruna** and **Malmberget**. If the results from this test project are positive, the method will be modified to suit large-scale applications. The technique is based on the grading of waste-rocks taking place down slope from the truck dumping. This grading results in a pervious/well draining filter dam. Constrained cells can be constructed with this technique, in which tailings are discharged hydraulically. The filter dam then contains the tailings material, while process water is drained.

A collection ditch or walls will be constructed around the filter dams to collect the draining water. Collected water will be directed towards the existing tailings dam. The suggested location of these draining cell ponds will result in the tailings dam acting as a clarification pond for suspended material transported through the filter dam.

Some of the tailings material will pass through the filter dam to the existing tailings dam. This may result in a need for a height increase of the existing tailings dam during the planned 16 year deposition period, depending on the efficiency of the filter dam. It is necessary to have a high filtering efficiency (sand deposition within the cell) to make the drained cell deposition a viable method. The height increase that may be necessary (max. 1 - 2 m over the 16 years period depending upon the dam efficiency) can be constructed on the existing dam.

One advantage of this draining technique is that an increase of the footprint of the existing tailings dams is not necessary. Also since the drained cell is a 'dry' system the tailings can be stacked higher. Because the water from the tailings deposition is drained, failure of the filter dam is less likely. However should it fail, the effect of the failure will be reduced because water content is lower compared to the current system and tailings material escaping the cell ponds will be trapped in the current tailings dam. With the current conventional dam system the coarse tailings are treated like waste-rock and trucked to the waste-rock dump, which is very cost and labour intensive. An economic benefit for the operator is that with this new method both coarse and fine tailings can be pumped to the new TMF as a slurry.

[49, Iron group, 2002]

3.1.4.3.4 Safety of the TMF and accident prevention

At **Kiruna** and **Malmberget** discharge to the tailings dams is controlled by a relatively constant operation system producing a constant flow of tailings. The dams are inspected several times a week in line with guidelines set out in an Operation, Inspection and Maintenance (OIM) manual that has been developed for all three facilities. The inspections include evaluation of water level in the dams and the overflow ditches/funnels. All observations are logged in the field log book so that changes can be evaluated. Monthly and yearly inspections are also implemented according to the OIM manuals. Inspections are performed several times a week by operating personnel, monthly by the manager and yearly by an expert (usually the 'in house' consultant).

A classification of all dams according to hazardousness (human life, environmentally, economically) of a dam failure has been performed following the Swedish guidelines (RIDAS, see Section 4.2.3.1). For the classification, a risk assessment was performed that focused on the worst-case dam failure. Since the material, as described earlier in this document, is chemically stable, the risk of causing environmental hazards is very small.

The OIM manuals developed at Kiruna and Malmberget are described below.

General

In 2001 Operation, Inspection and Maintenance (OIM) manuals, similar to the OSM manuals described in Section 4.2.3.1, were developed for three large tailings dams. These manuals were developed in order to avoid dam failures, or, in the event that a failure takes place to advise on emergency responses to reduce the effect from a dam failure. The three manuals are very similar and will, therefore, be described together. Another objective of these manuals is to facilitate and document future design changes. The manuals are updated yearly.

The content of these manuals are as follows:

- dam design
- dam classification according to hazard (including risk assessment)
- possible actions for safety improvements
- operation, inspection and maintenance routines
- emergency preparedness plan for dam incidents (EPP).

The condition of the dams during operation can be classified in four different levels:

- normal operation, where there is no indication of changes in conditions
- tightened operation, when there may be some indications of dam fractures, high rainfall or process water output etc.
- disturbed operation, when there is an unusually high water level in the dams, distinct dam fractures, and water leakage; and lastly
- incidents, where operation is likely to be halted.

The following paragraphs describe monitoring/dam inspection routines and dam failure emergency plans (EPPs).

Monitoring and inspections of tailings facility

The phreatic surface is monitored using standpipes installed in selected sections of the different dams. There are nine standpipes at the Kiruna tailings dam, fiftythree at Svappavaara and four for the tailings dams and Malmberget. Measurements are taken manually on a monthly basis as long as readings are stable, otherwise more often. Climate data is received from a weather station located at the nearest airport.

The OIM manuals describe the critical parameters for operation, inspection and maintenance. These include except in the case of dam manuals, decants and outlets, tailings discharge systems, storm water diversion channels, etc. The manuals suggest regular inspections by trained operating personnel three times a week where changes such as erosion on slopes, seepage, material transport in seepage water, which indicate internal erosion are checked. All observations from these inspections are logged in a field book. The manuals require meetings once a week for the OIM personnel, when the information collected during the week is presented and discussed and decisions on dam safety improvements are made if necessary.

A monthly inspection is performed in order to evaluate the safety of the dams and to identify any possible improvements needed to maintain a high level of safety. These inspections are to be performed by the person responsible for the tailings dam together with the operating personnel. In addition to the visual inspections, readings are also taken of the stand pipes, the seepage water and pond water levels.

An expert performs a yearly inspection (audit). At this inspection all the field notes and monthly inspection reports are reviewed and a visual inspection is performed. The report from the inspection summarises all measurements collected throughout the year, evaluates the results, and suggests possible improvements or adjustments to the dams and to the daily and monthly inspections. The yearly inspections also review and evaluate the dam calculations behind the dam designs including the operation and maintenance data.

Emergency Preparedness Plans, EPP, for the four levels of operating conditions listed and described above, have been developed. These levels require different responses, which are summarised below.

Normal Operation: Routines for normal operation in the OIM manual is followed.

Tightened Operation: When the conditions indicate an increased risk of a possible dam incident such as, increased seepage, unusual high water level in the pond etc., the facility will undergo more frequent inspections (every second day or every day) to evaluate if the conditions are improving or getting worse. The person responsible for dam safety notes all observations in the field book.

Disturbed Operation: If there are major changes on the dams, more severe than described above, e.g., extreme climate, severe erosion, internal erosion or erosion along decant culverts, major cracks, sinkholes or settlements the operation is classified as 'disturbed operation'. At this stage preventive measures are required. The OIM manuals describe possible scenarios and suggested measures for these scenarios and recommend that an expert be consulted if necessary. All observations and measures are to be described in detail in the field logbook by the person responsible for the dam safety.

Incident: If an incident takes place a temporary stop in the mining operation is likely. An action plan to aid in decision making was established as well as both internal and external phone lists. An incident has to be followed up with a report that includes the reason for the incident and what actions were taken to mitigate the incident.

For the safe operation of the tailings ponds located on top of the waste-rock dumps at **Erzberg**, a series of monitoring and supervision measures are provided, focusing on crucial parameters. Parameters observed on a regular basis comprise:

- surface water level inside the dams (piezometer measurements)
- water level in the ponds
- subsidence measurements (surveys).

Operational instructions are also provided and cover:

- visual observations
- drainage control and the documentation of drainage failures and maintenance works
- water monitoring
- monitoring of dam stability by surveying fix points
- monitoring of water-levels within the dams.

The water quality is regularly analysed at sampling points defined by authorities and an internal analyses of water quality is done according to needs. However, due to the fact that the discarded tailings are classified as safe in respect to their geochemical environmental aspects, the environmental monitoring will merely be of a documentational and preventional character.

[49, Iron group, 2002]

3.1.4.3.5 Closure and after-care

For the three large tailings ponds at **Kiruna** and **Malmberget** formal closure plans have not been submitted for approval by the regulatory authority. A closure plan will be developed in co-operation with local and regional regulatory agencies. Those parts of the tailings dam system that might be decommissioned prior to mine closure, will be covered and re-vegetated, and if ponding takes place, water pumping and regrading may be performed.

At **Erzberg**, some small tailings ponds have been decommissioned. No approved closure plan exists for the ponds in operation, however, studies have been conducted and closure concepts have been developed. The methodology used so far for the closed ponds was dewatering and soil covering, followed by re-vegetation. Re-vegetation directly in the dewatered tailings has also been carried out successfully. These measures effectively eliminate dust emissions from the ponds. Water contamination is not an issue (as proven by 30 years of monitoring results) as the tailings are chemically stable and no reagents are used in the mineral processing. The closed ponds are continuously supervised and surveyed. Alternative uses for the tailings material are currently being investigated.

3.1.4.4 Waste-rock management

Two of the mining operations are underground mines (i.e. **Kiruna** and **Malmberget**). As a result, only smaller amounts of **real waste-rock**, as defined for this document, are excavated for access tunnels. However, the dry magnetic separation tailings are included in the discussion of waste-rock, since the management of these coarse tailings is more typical of waste-rock than tailings.

At the **Kiruna** and **Malmberget** operations the coarse tailings are transported on a conveyer from the processing plant to bins and from there hauled to the so called 'waste-rock' facility using dump trucks. The coarse tailings are dumped on heaps approximately 15 m high and at the natural angle of repose. In total these two sites manage about 12 million tonnes/yr of 'waste-rock' this way.

At **Erzberg**, approximately 1.9 million tonnes/yr of 'waste-rock' are managed, 0.7 million tonnes of which are the coarse tailings from the dense media separation and 1.2 million tonnes of actual waste-rock, which comes directly from the open pit mine.

3.1.4.4.1 Characteristics of waste-rock

The **Malmberget** waste-rock (the coarse tailings) has not been characterised, however, the waste-rock at **Kiruna** was tested for leachability and Acid-Base Accounting (ABA), in addition to characterisation of the ore and native rock during exploration. Detailed mineralogical and trace element analyses have previously been described under the tailings section (see above). Tests have also been performed to evaluate the amount of unexploded explosives left in the waste-rock material.

The leachability and ABA investigations indicated that the finer fraction of the waste-rock (from the sorting plant) had the highest sulphide content (1.4 - 3 weight. % S). The neutralising capacity from calcite is, however, higher than the acid producing potential from the sulphides. The leach tests performed (i.e. humidity cell tests), indicate that acid being produced due to sulphide mineral oxidation is neutralised by the calcite. The investigation also indicated that silicate minerals present in the test material also act as neutralisers. The leach tests indicate that sulphate, calcium and magnesium are the main constituents leaching from the waste-rock.

The nitrate/ammonia leaching tests indicate that the ammonium nitrate left over from undetonated explosive, is easily leachable and is primarily leached by the first infiltrating rainwater on the waste-rock.

Geotechnically, the waste-rock is stable. The coarseness of the material and truck dumping stabilise the material during deposition. The chemical weathering is very slow in the northern Sweden sub-alpine climate. The generation of clay minerals due to weathering is extremely slow. Therefore, no alternative deposition method has been considered.

[49, Iron group, 2002]

At the **Erzberg** site, the waste-rock has not shown any sign of leaching and has been mineralogically characterised as follows:

- ankerite
- limestone
- schist ("Werfener Schiefer", "Zwischenschiefer"): quartz 46 %, dolomite 14 %, haematite 6 %, mica 4 %, feldspar 0.18 %, pyrophyllite 30 %
- porphyroid (small amounts): mica 8 %, quartz, 63 %, feldspar 5 %, chlorite 25 %
- fragmentation: 0 - 1500 mm.

Ankerite, limestone and porphyroid are quite resistant to weathering. On the other hand schist shows a rather high degree of weathering, in particular due to the meteorological conditions at the site. [55, Iron group, 2002]

3.1.4.4.2 Applied management methods

There were no baseline studies performed prior to developing the waste-rock management facilities at two of the sites. However, at one site, an advanced design was carried out based on-site investigations. The locations of all dumps were chosen so as to be as close as practically and technically possible to either the mine or the processing plant.

For two of the sites the waste-rock management facility is located near the processing plant and extends to mined out open pits. In fact, at one site, the coarse tailings from dry magnetic separation were discarded into the mined out open pit over a short period using a conveyor belt system. This is not done any more because of dust problems.

At **Kiruna** and **Malmberget** the waste-rock is deposited on a thin soil cover or directly on bedrock. The bedrock consists of primarily volcanic rocks, trachytes, trachy-andesite, rhyolites, and rhyodacites. These rocks are very competent resulting in little risk for collapse into the underground mining operation [49, Iron group, 2002].

At **Erzberg**, due to the alpine location of the mine, space is scarce. The previous waste-rock dump was in operation up to the middle of the 20th century. After closure the tailings ponds were built in this dump area. As the capacity of the dump was exhausted, it became necessary to find new dumping facilities. Based on investigations done by the operator and in close co-operation with the local community, landowners and involved authorities a new area was identified for the waste-rock dump. This new waste-rock dump is located in a small valley close to the mining operation. The rivulets in this valley were dumped over while care was taken to ensure sufficient permeability for the water. Soil and loose material have been removed down to the competent rock. This formation is permeable and sits on top of an impervious bed, which consists of schist and porphyries. In the valley the base rock consists of porphyries, clay schists and carbonates. The total area of the dump is about 400 ha. Up until 2002 about 550 million tonnes of waste-rock have been dumped at this facility. The dump extends from the 1230 m level to the toe of the end dam at the 821 m level. The dump comprises several dump areas and has a total vertical extension of more than 400 m. The maximum height of a single dump slope is 70 m. The end dam, which is situated at the lowest part of the valley has a height of 147 m. The distance from the mining faces to the dump varies between 500 m and 1500 m in linear distance. Hauling distances for truck haulage are up to 3 km. [55, Iron group, 2002].

Design and construction

As mentioned above, Erzberg needed to locate the waste-rock dump area in a valley due to the topography in the area. For planning and operation of the waste-rock management facility particular care was taken due to the specific situation of this dump with respect to:

- dumping at a mountain-slope area
- dumping on top of rivulets
- distance to residents
- alpine climatic conditions.

Therefore the planning of the project considered three key factors:

- ground conditions (geological, hydro-geological)
- waste-rock characteristics
- dumping method.

Many options for dealing with mining, soil mechanics, geology and hydraulic systems were discussed. The following issues were evaluated:

- avoidance of erosion and stability of the dump slopes
- avoidance of accumulation of water behind and inside the dumps
- studies about the flowrate through the dumps at high water flow
- evaluation of the quality of water after percolating through the dumps.

The basis for the design and construction of the waste-rock management facility was developed by an external consultant. According to the concept worked out, the bottom layer of the dump (valley base) consists of large-sized carbonatic rocks. The cross-section of this layer was designed for a flood (100-year event) the water can percolate through the dump without problems and without producing an increase in the flow pressure. In addition, an extensive testing programme was executed by the responsible authority. Over a two year period, penetration tests have been conducted which show that the maximum water flow can be managed if the base of the dump is constructed as proposed.

Based on these expert opinions and investigations the waste-rock management facility was approved by the mining authority in 1969. The approval comprises a series of strict obligations with respect to the design and operation, including:

- before dumping, the ground had to be cleared from vegetation, trees, roots and soil
- the dump must not exceed a general slope angle of 31° upon completion
- the cross-section of the lateral ditch for drainage must be designed large enough to handle run-off waters from the slopes
- the total bottom layer of the dump must be made of carbonatic rock blocks of a size between 400 - 1000 mm and must be at least 1.5 m high
- in the area of the previous bed of the rivulet, block sizes of at least 700 mm should be used
- in the designated discharge zones only carbonatic rocks must be used
- at the toe area of the dump towards the valley a discharging body perpendicular to the valley must be made
- an appropriate monitoring system has to be implemented to check the phreatic surface within the heap
- the total workings for the dam and the separate construction phases have to be well documented.

Both design and construction were evaluated by an external expert on the basis of the existing documentation for the closure in 1996. This evaluation showed that all instructions of the authorities had been followed and that there were no indications of any instabilities of the dump slope.

As described above, the dumps have been designed to allow for a stream to flow underneath. Apart from this the main factor for the waste-rock dump design is hauling distance from the mining area. As described above, the waste-rock and the dry magnetic separation tailings are transported on trucks and dumped within the waste-rock facility. The dumping is based on the natural angle of repose with no further change of the slopes. This has been the historic way of depositing the waste-rock. Since the material is considered to have only a minor impact on surface and groundwater or the surrounding soils, changes to these practices have not been made. The use of conveyer belts or slurry pumping is frequently being evaluated to replace the truck hauling. However, truck hauling has so far been found to be the most efficient and economic way of transporting the waste-rock. [55, Iron group, 2002]

Operation

The deposition of waste-rock is similar at all sites. The waste-rock is hauled by trucks from the mining faces at distinct benches via the ramp system and from the dump area to the dump positions. The material is directly dumped from the truck over the dump slope or on top of the dump.

At Erzberg, the dump heights vary between 40 and 70 m. With this method, dump slopes will be between 33° and 38° . The overall general slope angle is kept lower than 28° [55, Iron group, 2002].

At the **Kiruna** and **Malmberget** sites the dumps are constructed in 15 m high lifts. The truck dumping method results in a gradation where the larger grain sizes roll down to the bottom of the slope, while smaller grains settle higher up on the slope. This was used in the design of one of the dumps as described above in order to allow for a stream to flow underneath one of the dumps. In addition, there is likely to be some compaction on the top of each lift level due to the driving of the dump trucks. Later on natural compaction of the deeper parts of the waste-rock piles may also take place. None of these different compactions considerably influence the water flow. Most of the rainfall onto the waste-rock is likely to flow vertically through the dumps. When the infiltrating water has percolated through the dumps, a portion of the water will infiltrate the groundwater and a portion will flow on top of the bedrock and be visible as seepage at the toe of the dump. It is common practice to construct ditches at the toe of the

waste-rock facility to control the seepage water. At one site, however, the seepage goes directly into the stream that flows under the dump. [49, Iron group, 2002]

3.1.4.4.3 Safety of waste-rock facility and accident prevention

At two sites the waste-rock is considered to be chemically and geotechnically stable. For that reason, monitoring systems of the waste-rock facilities are not applied.

At the site where the stream flows underneath the waste-rock a monitoring plan is followed including geotechnical monitoring (surveying, piezometer measurements) and environmental monitoring.

3.1.4.4.4 Site closure and after-care

As a part of the permit process for the waste-rock facility, one company has developed a closure plan. As described before, the waste-rock dumps are designed with 15 m lifts. The waste-rock on top of each lift is moved inwards leaving a ledge of 30 m. The reclamation concept is to focus on re-vegetation of the ledges adding soil and seeds in line with the local vegetation. A small rock berm will be constructed at the edge of each ledge. Water will be added to the re-vegetated areas in the early stages of the reclamation project but will not be required later on.

The top of the waste-rock will slope from the centre to the edge of the waste-rock dumps. The dry coarse magnetically-separated tailings will be spread on top of each lift at a thickness of 0.5 - 0.7 m. On top of this coarse tailings material it is suggested to add a 0.2 m thick soil cover. Growth enhancing organic material is also suggested to be added to the soil.

At another site the reclamation measures to be taken after closure are part of the permit by the authorities. These measures are different for distinct areas and comprise landscaping and tree-planting. However, due to the local situation characterised by

- absence of mineralogical soil
- deficit of nutrients (mainly carbonates)
- coarse fragmentation (due to mining technique and weathering resistance)
- temperature gradient
- steep slope angles.

These measures will be difficult to realise.

Due to these difficulties the company initiated a research project with specialists (biologists, reclamation experts, forest experts, mining engineers) to develop improved and site-specific reclamation techniques. Another important goal is to achieve site-specific vegetation in order to gain a sustainable reclamation.

By testing reclamation techniques over a three year period the most appropriate methods were selected. After six years of observing the vegetation progress, it is clear that sustainability of the measures is possible. Hence, the company now has the know-how to apply reclamation in the future with a high potential for success and in an economic manner. The observed and documented effects of progressive re-cultivation of the waste-rock dumps are:

- improvement of water balance (percolation and surface drainage rate)
- improvements of visual impact
- increased habitats for flora and fauna
- improvement of bio-diversity in the area.

The methods developed are also planned to be used for the areas currently in operation.

Long-term supervision for the waste-rock management facility is comprised of frequent monitoring of the seepage line within the end dam.

3.1.4.5 Current emissions and consumption levels

All operators follow established monitoring programmes agreed with the competent authorities.

The operator of the Malmberget and Kiruna sites has implemented a monitoring system for the environmental effects of emissions. The programme contains descriptions of sampling procedures, analysis, and reporting for environmental control. There are instructions and procedures within the company operation system that describe sampling in detail.

Monitoring is carried out according to the following minimum protocol:

- discharge control in one sampling point at least ten times a year. The analysis includes pH, carbonate nitrate, phosphorus, hydrocarbons and metals
- recipient control is based on two sampling points and in one reference location (for background level) at least six times a year. The analysis parameters include pH, carbonate, and phosphorus
- recipient- and surroundings investigations of the recipient environment are carried out every three to five years. The investigations consist primarily of sedimentological and biological evaluations
- evaluation of flooding overflow water from the clarification pond takes place continuously.

[49, Iron group, 2002]

3.1.4.5.1 Management of water and reagents

At **Kiruna** the total water intake into the mineral processing plant was 61 Mm³ in 2001. Of this 3 Mm³ was captured surface run-off, 9 Mm³ mine water and the rest, 49 Mm³, was water re-used from the clarification pond. For the 23 million tonnes of ore processed in that year, the process uses 2.6 m³/tonne of ore, of which 80 % are re-circulated from the pond [51, Iron group, 2002].

In the flotation at Kiruna the following amounts of reagents are consumed in a year:

- collector: fatty acid, 290 tonnes
- depressant: sodium silicate, 1500 tonnes containing 94 tonnes Na and 194 tonnes Si
- conditioner: sodium hydroxide, 60 tonnes containing 35 tonnes Na.

The fatty acid, coming from the flotation process, which goes to the tailings corresponds to 250 t/yr (86 % of total consumption), of which approx. 63 % are methylic carbon and 27 % carboxylic carbon. The fatty acids are attached to the mineral phases and are transported to the tailing pond where they sediment and decay. The complete aerobic decay can be described by the formulas below:

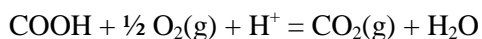

There is no collection of run-off water/seepage from the waste-rock facilities except for a drainage ditch around parts of the dumps. In these two cases, the seepage flows naturally into the tailings ponds.

At the **Erzberg** operation the mineral processing plant uses 90 % re-circulated water from the screw-classifiers. Drainage water from the tailings ponds percolates through the waste-rock dump and drains into a stream that flows under the dumps. No chemicals are used in the process. The tailings are inert and do not leach nor weather to any notable degree.

None of these operations have completed water balances. At Kiruna, however, as part of a groundwater investigation to estimate sources for contaminants to a lake, the drainage from the waste-rocks into this lake was calculated to be approximately 1.13 Mm³/yr.

3.1.4.5.2 Emissions to air

The most severe dust problems at the waste-rock dumps occur on dry days from the crushing, transport and dumping of the waste-rock. The haul roads are then watered to reduce this problem and dumping facing populated areas ceases during windy or dry days. At one site, progressive reclamation minimises the open waste-rock dump area and thereby also the possible dust emissions.

Ponds in operation at **Erzberg** are kept water covered or water saturated. This is possible due to the alpine weather conditions with:

- high precipitation rate of about 1200 mm/yr
- short summer period
- protection by nearby mountains against wind.

At **Kiruna** and **Malmberget** sampling of airborne particles is performed continuously at several locations around the three mining operations and within the residential areas. During the winter, the snow is collected at the sampling points and analysed for particles.

Testing of air imissions the last few years at the three sites, indicates that the solid particles measured so far have been less than 220 g/(100 m² x 30 days) for Kiruna, 18 - 220 for Malmberget, and <200 for Svappavarra residential area. The solid particles trapped in these tests are primarily from other parts of the mining facility and not from the tailings dams. Snow samples are collected during the winter at several collection points. These samples are analysed for airborne particle distribution and reported yearly.

3.1.4.5.3 Emissions to water

At **Erzberg** water discharges are monitored. No negative effects on the downstream water quality have been detected nor have any threshold values been exceeded.

For the other sites the emission to water is variable for each of the large sites. The following sections give a description for each of the sites. Groundwater samples have been collected in order to evaluate transport of nitrate from the coarse tailings facilities.

At **Kiruna** approximately 9 Mm³ is discharged yearly from the clarification pond to the surface water system. The yearly average discharge rate is approximately 16.8 m³/min. The discharge rate over the year is highly variable, and follows the natural drainage cycle, however, with some time delays. The total amount of nitrate and phosphate discharged in 2001 was 116 tonnes and 251 kg, respectively, which is in the range of the discharge over the last 10 years. Discharge concentrations for nitrate are approximately 13 mg/l, and for phosphate, the discharge concentrations are approximately 0.03 mg/l (average concentrations for the year). Nitrate comes from the un-detonated explosives and the phosphate comes from the ore.

The following table shows a complete analysis of the discharge of this site.

Parameter	Conc.	Units
Al	10.7	µg/l
Aliphatics	<0.1	mg/l
Aromatics	<0.2	mg/l
As	0.59	µg/l
Ba	31.35	µg/l
Ca	160.7	mg/l
Cd	0.009	µg/l
Cl	123.8	mg/l
Co	0.18	µg/l
Cr	0.049	µg/l
Cu	1.79	µg/l
F	1.71	mg/l
Fe	0.049	mg/l
HCO ₃	1.10	mmol
Hg	<0.002	µg/l
K	35.1	mg/l
Conductivity	139.7	mS/m
Mg	20.05	mg/l
Mn	32.36	µg/l
Mo	53.94	mg/l
Na	80.37	mg/l
Ni	0.92	µg/l
NO ₃ -N	11.33	mg/l
P	25.54	µg/l
Pb	0.0429	µg/l
pH	8.03	
S	141.1	mg/l
Si	3.684	mg/l
SO ₄	431.2	mg/l
Sr	551.1	µg/l
Susp. Solid	3.14	mg/l
Tot-N	12.77	mg/l
Tot-P	0.0274	mg/l
Turbidity	1.871	FNU
Zn	0.924	µg/l

Table 3.47: Average concentrations of an iron ore tailings facility discharge to surface waters for 2001

From the **Svappavarra** facilities there is normally no or only marginal direct water discharge of process water to the recipient water system except for leakage through the dams. For the year 2000, approximately 130000 m³ water was reported discharged during the period from May 23 to June 14, due to an unusually high water level in the clarification pond. Four sampling points are frequently sampled for water quality in connection with the tailings facility.

Water quality in the tailings ponds complies with Swedish and European water quality standards. Water from the tailings ponds discharges into the clarification ponds. Excess water from the clarification pond is used either as process water or for transport of the tailings to the tailings dams. Excess water from this cycle is discharged to the river system according to the discharge permits. In 2000, approximately 80 % of the excess water entering the clarification pond was re-used in to the processing plant, while 20 % was discharged. The amount discharged is 16.7 m³/min (yearly average). The water quality discharged to the river systems is classified according to the Swedish Environmental Protection Agency as low concentration waters for all three facilities at Malmberget and Kiruna.

Approximately 6168 m³ water was discharged from the Malmberget facility into the river. The discharge water and the recipient water were monitored and total mass of constituents discharged are estimated on a yearly basis. The processing water constitutes approximately 2 % of the total flow in the river.

At one of the sites a comprehensive groundwater investigation was performed to evaluate contaminant transport from the waste-rock facility to a nearby lake. Four monitoring wells were installed to depths of 2.5 - 3 m and sampled several times during the summer. The study indicated that there are only minor amounts of constituents transported from the waste-rock facility via the groundwater due to the high acid-buffering capacity of the waste-rock and the sorption capability of the aquifer.

Erzberg has direct discharge of drainage from the waste-rock dumps. After 30 years of monitoring of the surface water, no adverse effects on the surface water quality have been detected.

3.1.4.5.4 Soil contamination

At the **Kiruna** and **Malmberget** sites soil sampling is performed on a regular basis (approximately every five years). This is designed to monitor any contamination originating from atmospheric deposition. The investigation includes analysis/evaluation of ground-growing moss near (at various distances and in various directions) the mine facilities. The investigations focus on metal concentrations. The results of this investigation are compared with regional investigations performed by the competent authorities.

A water balance calculation has been performed for the tailings dams system, including:

- direct precipitation
- surface run-off
- process water discharge
- pump back process water
- evaporation
- discharge to the river system
- groundwater recharge and seepage through the dykes.

Based on this balance the estimated flow into the groundwater from the tailings pond/dam system is 2 m³/min. However, there is a large uncertainty behind this number since several parameters cannot be measured but must be estimated.

Groundwater studies to evaluate the effect of the groundwater recharge from the TMF have not been performed. However, tailings/clarification pond water quality is monitored regularly, and is considered to have low concentrations. Groundwater contamination from the tailings dam system is unlikely to occur.

There has been no investigation carried out to directly evaluate the possibility of contamination of soil from the waste-rocks facilities. The leaching from these dumps is minor except primarily for nitrate and smaller amounts of sulphate. It is considered not necessary to investigate soil contamination from the waste-rock facility other than airborne particle monitoring and the vegetation investigations updated every five years.

3.1.4.5.5 Energy consumption

One site reported a unit diesel consumption for the haulage of waste-rock: 0.18 litre/tonne (average 2001).

3.1.5 Manganese

In this Section only some information about the Hungarian Úrkút mine is provided.

3.1.5.1 Mineralogy and mining techniques

Pyrolusite (MnO_2) is the most common manganese mineral and is an important ore. The mining term "wad" is used to indicate ores that are a mixture of several manganese oxides, such as pyrolusite, psilomelane and others that are difficult to distinguish. Pyrolusite is an oxidation product of weathered manganese minerals and also forms from stagnant shallow marine and fresh water bog and swamp deposits. Minerals such as rhodochrosite, rhodonite and hausmannite are often replaced by pyrolusite [37, Mineralgallery, 2002].

3.1.5.2 Tailings management

From the several manganese occurrences in Hungary one mine operates at present. This is in Úrkút, where mining started in 1917. The open pit was in operation until 1930, but since 1935 the ore has been mined underground. The mining method is room and pillar stoping combined with sublevel caving.

Until the 1970s the oxide manganese ore was treated in a mineral processing plant. The Mn-rich mud (12 % Mn and 17 % Fe) has long been discarded near the mine (2.5 million tonnes). Presently, the ore is only crushed to less than 10 mm, and sold directly to a single end-user, the Dunaferri Steel Mills in Dunaújváros. No tailings are generated.

The small amounts of waste-rock produces are used to fill the nearby decommissioned open pit.

3.1.6 Precious metals (gold and silver)

The following list shows the current gold mining operation in Europe.

Site	Country
Baia Mare	Romania
Bergama-Ovacik	Turkey
Boliden, Bjoerkdal	Sweden
Orivesi	Finland
Río Narcea, Filón Sur	Spain
Salsigne	France
Sardinia	Italy

Table 3.48: List of current European gold producers known/reported to date

Of the sites listed in the table above Orivesi, Río Narcea, Boliden and Bergama-Ovacik provided information for this section.

3.1.6.1 Mineralogy and mining techniques

Gold and silver are very different in the way deposits occur. Silver is mined entirely as a by-product of base metal or gold mineralisations and is therefore not specifically mentioned in this Section. Gold occurs either as free gold, or as sulphide-related gold.

Various geological settings and mineralogical characteristics are represented in the precious metals sites:

- complex sulphide ores where Cu, Zn and Pb are complementary or even the main value minerals (Boliden)
- sulphide mineralisation comprising pyrite, arsenopyrite, galena and sphalerite where the contained gold is submicroscopic ($<1\ \mu\text{m}$), finely disseminated in the pyrite and arsenopyrite lattices (refractory gold) (Olympias Gold)
- low sulphidation epithermal quartz and breccia veins in andestic host rock (Ovacik Gold Mine)
- strongly altered volcanics: quartz, sericite and andalusite rich rocks or schists (Orivesi)
- native gold with copper sulphides in skarn and brecha jasperizadas (Río Narcea)
- gossan (Filón Sur).

The differing mineralogies require different mining and mineral processing techniques to obtain optimum gold recovery. Underground (with and without backfilling) and open pit mining are applied. The open pits are, in two cases, planned to become underground mines in time. There are several examples where gold is extracted from a tailings stream from a base metal mineral processing plant (i.e. Boliden) or from old waste-rock dumps (i.e. Filón Sur) and tailings ponds (i.e. Baia Mare).

3.1.6.2 Mineral processing

Various mineral processing techniques are used, mainly due to their different suitability for different mineralogy. Depending on how the gold occurs in the ore it may be necessary to use different methods to liberate the gold so that it can be extracted. The gold can, in many cases, be recovered in the copper concentrate and separated from the copper in the subsequent smelting process. Native gold can be gravimetrically concentrated and recovered. Gold in its oxide form can be directly leached with cyanide. Refractory gold may require oxidation, e.g. bio-oxidation, in order to liberate the gold and make it accessible for CN leaching.

3.1.6.2.1 Comminution

Common to all operations is that the ore needs to be crushed and ground before the gold can be liberated. In some cases this is done in the previous recovery of base metals. Tank leaching requires a finer grain size in order to allow for relatively short residence times in the leaching tanks. Heap leaching allows for a coarser grain size as the leaching time is much longer. In heap leaching a relatively coarse grain size (even conglomeration may be necessary) is desired to allow for oxygen inflow and to secure a sufficiently high permeability of the heaped material.

The type of equipment used in comminution are various types of crushers, and various types of mills such as dry semi-autogenous mills, ball mills, autogenous mills, etc.

The **Orivesi** mine uses the following equipment in the comminution process:

- crushing in three stages with a jaw crusher, a gyratory crusher and a cone crusher
- grinding in two stages with a rod mill (3.2 X 4.5) and a ball mill (3.2 X 4.5)
- classification with hydro cyclones.

[59, Himmi, 2002]

The **Boliden** comminution circuit is described in Section 3.1.2.2.1. Both grinding circuits are equipped with Reichert cones, spirals and a shaking table for gravity separation of gold.

For the tank leaching operations it is commonly required to reach a grain size of 50 - 80 % <45 µm or in some cases, if the gold is extremely finely disseminated, even below 40 µm to achieve optimum liberation. [50, Au group, 2002]

3.1.6.2.2 Separation

The mineral processing methods commonly used are:

- flotation, where the gold binds mainly to the copper concentrate (gold recovered from the concentrate in the smelting process)
- heavy-medium separation for lumps using drum separators and dewatering screens
- cone separators and high-intensity magnetic separators for fine material
- Reichert cones, spirals and shaking tables for the gravity separation of gold.

In the schematic figure below, an example of a mineral processing plant is given. This plant, with a relatively low throughput of 35 t/h, produces a concentrate containing 125 g Au/tonne. The leaching of some of the gold concentrate is carried out to reduce the content of impurities (Tellurium (Te) and Bismuth (Bi)). This step aims to dissolve Bi and Te away from the concentrate. The tailings from this process are led to a separated ditch in the old TMF (used during nickel mining phase). Because the water from the leaching process is acidic, lime is added to neutralise it. Bi is precipitated in these circumstances, but most of the Te remains in solution. The leaching process has been in use only when necessary, depending on the ore characteristics. There is no outlet from the ditch, thus the water evaporates and filtrates into the old tailing material. According to analysis on seepage water outside the TMF area, no significant concentrations of Te have been found. Currently the leaching process is not in operation, because the quality of the ore has changed and Bi and Te are no longer problematic.

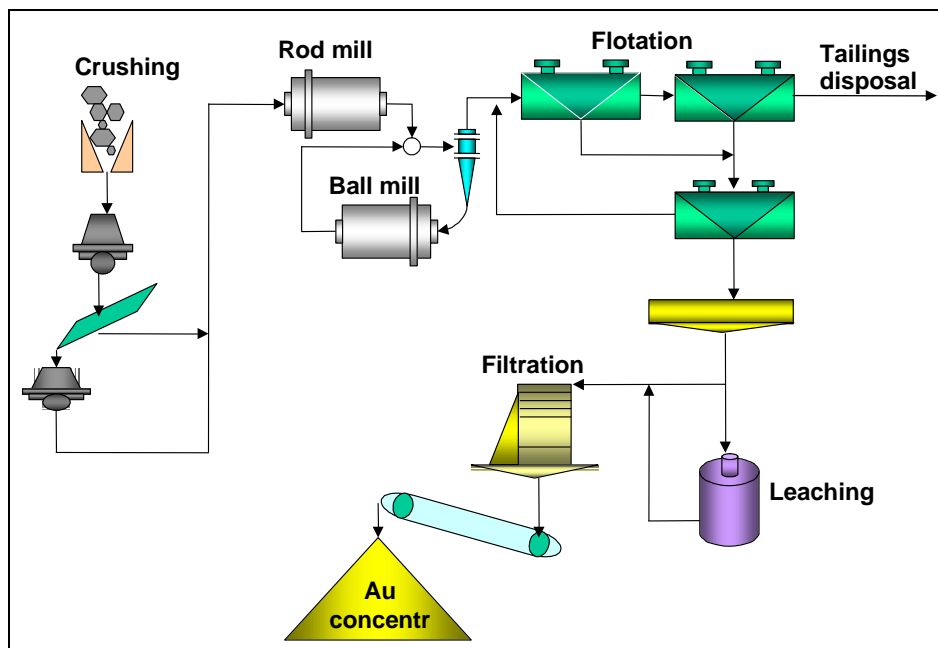

Figure 3.34: Schematic flow sheet of an example gold mineral processing circuit [59, Himmi, 2002]

Leaching of gold is carried out as follows:

- CN leaching in tanks using the Carbon-In-Pulp method (CIP) (e.g. Ovacik Gold Mine)
- CN leaching in tanks using the Carbon-In-Leach method (CIL) (e.g. Boliden and Río Narcea)

- bio-oxidation and pressure oxidation followed by CN leaching using the CIL method (all processes in closed tanks) (e.g. Olympias Gold Project)
- heap-leaching using CN solution followed by Merrill-Crowe process where the gold is precipitated on zinc powder (e.g. Filón Sur).

The leaching processes mentioned above all require further processing in order to achieve a sellable product, i.e. transfer of the gold and silver from the activated carbon into doré containing gold and silver. A complete gold tank leaching plant constitutes of the following principle stages:

- cyanide leaching (CIL-process or CIP-process)
- gold refining (elution, electrowinning, smelting and doré production)
- cyanide destruction (e.g. oxidation)
- reagents preparation (lime and sodium cyanide).

A complete plant is schematically illustrated in the figure below. This particular plant (Boliden), was commissioned in 2001 and recovers gold and silver from the tailings stream resulting from a base metal mineral processing plant. The system is designed for a throughput of 800000 t/yr with a gold production of 850 kg/yr. The recovery is approximately 80 % of the gold. The recovery of gold increased by 50 % after the installation of gold leaching.

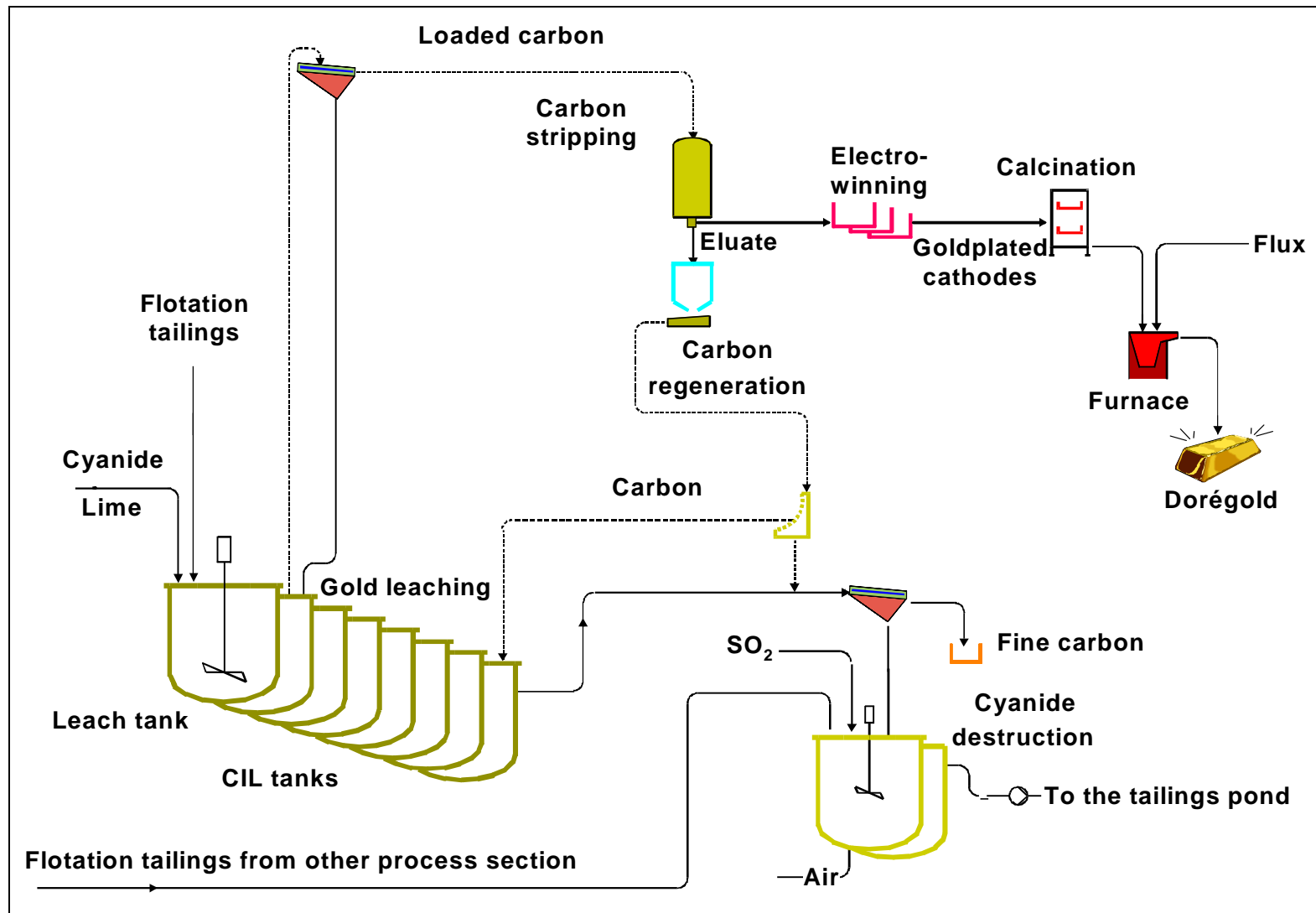

Figure 3.35: Schematic drawing of CIL process
[50, Au group, 2002]

At all sites where tank leaching is practised, the tailings slurry undergoes detoxification prior to discharge into the tailings pond.

3.1.6.3 Tailings management

3.1.6.3.1 Characteristics of tailings

The untreated tailings from gold mineral processing using cyanide contain different compounds, depending on the process used, ore type, cyanide dosage, degree of aeration, etc. The composition of tailings will also change as the ore changes [24, British Columbia CN guide, 1992].

During a CIP/CIL leaching process a small portion is lost to the mineral processing plant atmosphere by volatilisation. Some will react with whatever other cyanide consumers may be present in the ore to produce complexes such as the ferrocyanide, thiocyanate, cyanate and cuprocyanide complexes. During leaching, gold is removed from the solution by adsorption onto carbon, and some cyanide may be removed with it. The remaining unreacted cyanide, together with the products with other cyanide consumers, is discharged with the tailings. The cyanide in the tailings may be treated for cyanide removal (most European sites) or left as is for removal by natural degradation in the tailings pond (international standard). Any cyanide entering the carbon stripping circuit would either be periodically bled back into the leach circuit or destroyed during reactivation of the carbon in the carbon kiln [24, British Columbia CN guide, 1992].

The untreated tailings stream from a CIP/CIL process consists of a tailings slurry with elevated levels of cyanide, complexed metals, cyanate and thiocyanate. It may also contain arsenic and antimony, depending on the ore and mineral processing.

It is common practice to have regular control of other material characteristics (the parameters determined varies somewhat from site to site) such as, e.g.:

- grain size distribution
- solid to liquid ratio
- ARD-characteristics
- mineralogy
- trace element content.

The above-mentioned parameters are used to determine the leaching characteristics of the material which has an important influence in the operational management and suitable decommissioning methods for the tailings. For this purpose all sites using tank leaching have carefully evaluated ARD-generation characteristics for their tailings. The Boliden mineral processing plant, with 18 % sulphur and low carbonate content has to deal with potentially ARD-generating tailings [50, Au group, 2002].

At **Bergama-Ovacik** a detailed characterisation of some samples has shown that the tailings and waste-rock will not produce ARD as illustrated in the figure below.

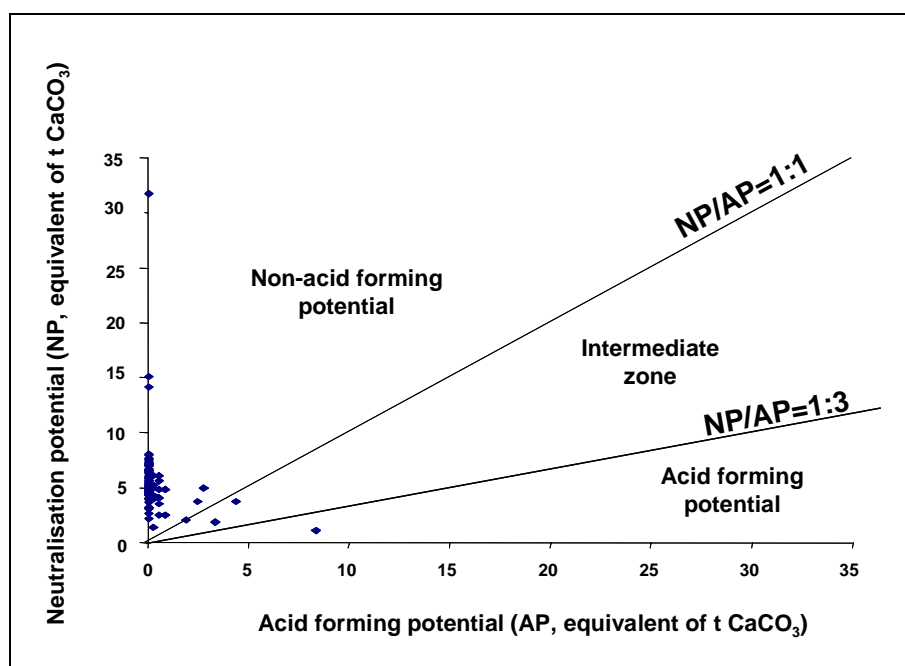

Figure 3.36: Acid forming potential vs. neutralisation potential graph of samples from Ovacik site [56, Au group, 2002]

The following table shows the average results of 99 samples.

	pH	AP*	NP*	NNP*	NP/AP*	S ²⁻ %
Average of 99 samples	7.52	0.47	5.5	5.18	4.67	0.02
*:Tonnes CaCO ₃ equivalent per 1000 tonnes						
AP: Acid Potential						
NP: Neutralisation Potential						
NNP: Net Neutralisation Potential						

Table 3.49: Acid production potential at Ovacik Gold Mine

The **Boliden** mining area consists of complex sulphide mineralisations. Mining in the area started in 1925 and to date approximately 30 mines have been worked in the area. The tailings in the pond consequently have varied chemical characterisations and physico-chemical properties. The characteristics of the tailings produced today are summarised in the tables below. The fine fraction after cycloning is discarded into the tailings pond and the coarse fraction extracted from the hydrocyclones is used as backfill in the underground mines.

Size	Total tailings	Hydrocyclone overflow to pond
µm	Cumulative % passing	Cumulative % passing
350	100	100
250	99.9	100
180	99.7	100
125	97.8	100
88	93.5	95.6
63	85.9	87.8
45	76.6	78.3
20	53.2	54.4
-20	0	0

Table 3.50: Particle size of tailings at Boliden mine [50, Au group, 2002]

The tailings have the following composition before cycloning and CN leaching:

- Au: 0.85 g/t
- Ag: 24.9 g/t
- Cu: 0.10 %
- Zn: 0.40 %
- Pb: 0.13 %
- S: 17.8 %

More than 50 % of the tailing consist of particles less than 0.002 mm. The tailings slurry pumped to the tailings pond contains 20 - 25 % solids. The density, as placed in the pond, of the tailings is 1.45 t/m³.

[50, Au group, 2002]

3.1.6.3.2 Applied management methods

At the **Filon Sur** heap leach operation, the tailings (the heap of leached material) are left in-situ and decommissioned. The heaps are built on a pad with a synthetic liner. Leachate or 'pregnant solution' is collected in a small pond before it is pumped to the plant for gold and silver precipitation. The leachate is then pumped to a conditioning pond before it is re-used in the leaching process. Very little information is available at the moment to evaluate how tailings and waste-rock management and decommissioning is done and planned, thus it will not be further described at this stage. No material characterisation is reported [57, IGME, 2002].

All other sites, using CIL or CIP to leach the gold in tanks, produce tailings in a slurry form that, after CN-destruction is applied, are pumped via pipelines to tailings ponds. The commonly used process to destroy CN is the SO₂/air process. In general this treatment results in a total CN concentration in the treated slurry stream of <1 mg/l. One site (**Bergama-Ovacik**) that measures WAD CN reports concentrations <1 mg/l.

Boliden uses the coarse fraction of the tailings as backfill in underground operations. These tailings are extracted from the tailings stream in hydrocyclones situated after the CN-destruction plant. The tailings used for backfill are also analysed for total CN (typically less than 1 mg/l).

50 % of the sites use lined tailings ponds and 50 % use unlined tailings ponds. Various dam types are used to confine the ponds.

At the **Bergama-Ovacik** gold mine, with an ore production of 0.3 million tonnes/yr, the tailings are managed in a 1.6 Mm³ capacity pond with a 30 m high downstream rockfill embankment and clay-geo-membrane composite lining system. As described earlier the tailings are treated for cyanide destruction and heavy metal precipitation utilising oxidation with SO₂ followed by ferric sulphate treatment [56, Au group, 2002].

A conceptual drawing of the TMF is given below:

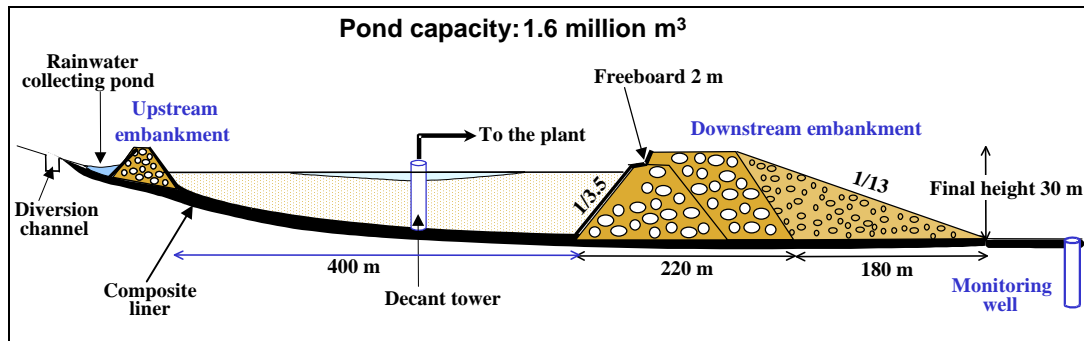

Figure 3.37: Cross-sectional drawing of Ovacik tailings pond
[56, Au group, 2002]

It should be noted that the bottom of the pond as well as the downstream face of the upstream embankment and the upstream face of the downstream embankment are lined.

The lined tailings pond is located in a valley within two hundred metres from the process units. Rock fill dam construction materials (mainly andesites) were obtained from the overburden excavation in the open pit. The region is an arid zone where evaporation plays an active role in the water deficit for the pond during the summer season. The TMF was designed as a ‘zero’ discharge unit where water in the pond is re-circulated during the operation of the mine. Because of the low cyanide concentration in the pond (less than 1 mg/l WAD), HCN volatilisation is negligible. The geo-technical and seismological investigations in the TMF area before and after the construction revealed the presence of a suitable setting for the rock fill embankments and the reservoir stability. The embankments were constructed as conventional dam structures.

Topsoil was scraped and stored on site for future use in site rehabilitation. During closure of the pond, tailings will be dewatered and the top will be covered with rock and soil and subsequently re-vegetated.

In selecting the TMF location, the main factors taken into consideration were:

- minimised land and soil disturbance
- proximity to the process plant
- use of overburden and waste-rock in the embankments in an efficient way to minimise the footprint
- storage of topsoil for vegetative cover upon closure
- cyanide destruction and heavy metal precipitation for tailings
- re-use of process water in the process
- zero-discharge of water from the TMF.

It was the company policy to select tailings dams of rock fill type for its increased stability and easy maintenance (as opposed to using the coarse tailings). The clay-geo-membrane composite liner system was selected to achieve an effective containment and to expedite the regulatory approval and permitting process.

From the geotechnical point of view, the dams were designed to withstand an earthquake induced horizontal acceleration of 0.6 g. During operation with the placement of the overburden and the waste-rock on the downstream slope of the main dam, the slope changed to less than 10°, increasing the factor of safety of the dam structure to 2.23 compared to the usual 1.2 used internationally for water retention dams.

The base of the tailings pond is covered with a composite liner system of 50 cm compacted clay, overlain by a 1.5 mm thick High Density Polyethylene (HDPE) geo-membrane, 20 cm of another compacted clay and 20 cm gravel filter layer. Drainage pipes are placed in the filter layer to drain the water towards the decant. The following figure shows the set-up of the composite liner system. [56, Au group, 2002]

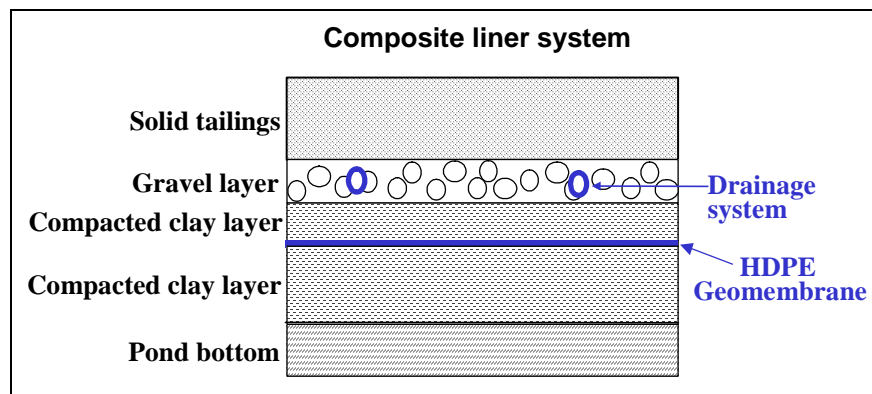

Figure 3.38: Composite liner set-up at Ovacik site
[56, Au group, 2002]

The deposition of tailings is carried out via pipelines discharging into the pond area near the downstream embankment. During the mine operation, a minimum of 2 m of freeboard is provided in the TMF design.

The TMF design includes surface run-off retention behind the upstream dam and a diversion channel for excessive flood waters (for 100-year flood conditions).

The **Boliden** base metal mineral processing plant received a total of 1.58 million tonnes of ore from five different mines during 2001 in order to produce copper, lead and zinc concentrates. Coarse gold is also extracted using shaking tables. Depending on the ore type part of the tailings produced (approx. 50 %) are further processed in the gold leaching plant. The gold leaching plant generated 0.8 million tonnes of tailings in 2001.

Of the five mines, four are underground mines and one is an open pit. The underground mines use the coarse fraction ($>125 \mu\text{m}$) of the tailings for backfilling. The amount of tailings used for backfilling depends the production level in the mines and the production status. During preparation work in the mines a significant amount of waste-rock is produced and used for backfilling. It should be noted that approx. 33 % of the ore comes from an open pit, where no backfilling is done during operation. Subtracting this amount of ore the percentage of backfilling is close to 50 %.

The tailings that are not used for backfilling are sent to the tailing pond that has been used since the 1950's. Previously the area had a lake. The amount of tailings in the pond is currently approx. 16 Mm^3 and covers a surface area of 260 ha. According to the existing operation levels, the existing tailing pond can be used for four to five more years. The tailings are pumped to the pond and discharged at various outlet points in order to allow for uniform filling of the pond.

The tailings are confined within the pond by five dams. Another dam is also constructed downstream of the tailings pond to cut off the lakes natural outflow and to create an additional clarification volume. The pond area is currently 260 ha and after a dam raise in the summer of 2002 the area will be 280 ha.

The tailings pond catchment area is 8 km^2 . The inflow of surface run-off has been estimated to be 1 Mm^3 during a dry year and 3 Mm^3 during a normal year. The pond receives approximately $4.5 \text{ Mm}^3/\text{yr}$ of process water from the mineral processing plant.

The tailings pond is approximately 3 km from the concentrating plant. Tailings are pumped via two separate pipelines, one to the north and one to the south of the pond. Downstream of the pond, slaked lime is added to the discharged water to increase the pH to 10 - 11. All water from the pond is discharged to waterways downstream. No re-circulation of process water is done at the moment.

Water sampling for monitoring water quality is done on a regular basis according to a control programme. Sampling is done both upstream and downstream of the tailings pond, as well as around the industrial area. Sampling consists of stream analysis and groundwater samples.

The dams were constructed initially in 1979 to +216.2 m as a centreline type dam with a vertical impervious core and support fills on both upstream and downstream sides of the dam. In 1995 the dam was raised to +220 m as a downstream dam (see the figure). A final raise is ongoing to +225 m to be finalised in 2002. A discharge channel constructed in natural ground will replace the current decant tower.

[50, Au group, 2002]

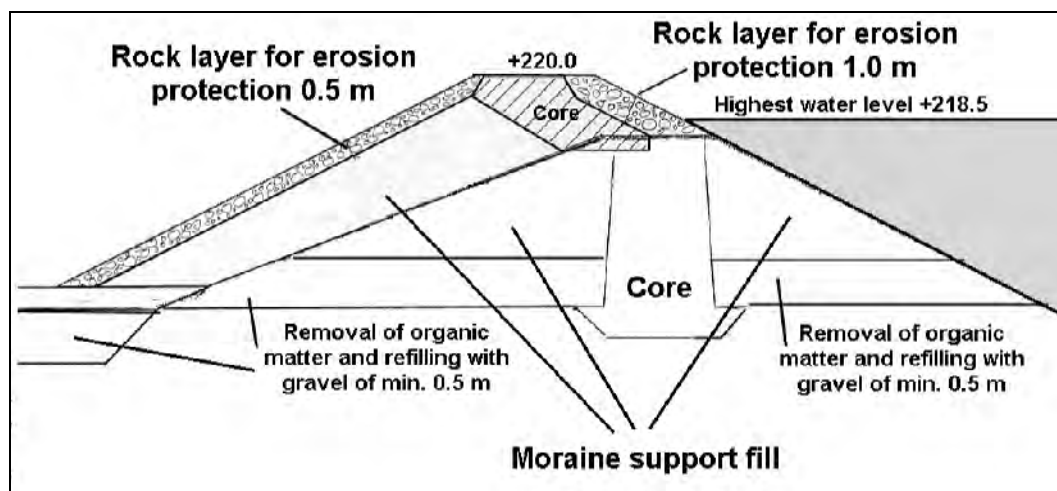

Figure 3.39: Cross-sectional view of dam at Boliden site
[50, Au group, 2002]

Any drainage through and under the dams is collected in a collection ditch and led to the clarification pond. Drainage through and under the other dams is back-pumped into the pond.
[50, Au group, 2002]

The tailings area of the **Orivesi** mine consists of two tailing ponds. The tailings from the process are pumped into the first pond (37 ha), where the solids settle and the clarified water is led forward from the other end of the pond. The second pond (14 ha) is for storing clarified water. Water is re-used in the process and only the excess is led to the river system. The starter dams have been made of moraine. The tailings are spigotted to one side of the first pond and the clarified water is led forward from the other side.

The dams of the clarification pond are made of moraine and lined with broken rock and coarse gravel to prevent erosion. The tailings management area was designed in the beginning of the 1970's and no closure or after-care plans was taken into account at that time. The tailings pond is, however, used only occasionally when the tailings are not deposited into the old mined-out underground nickel mine.
[59, Himmi, 2002]

A schematic figure of the system is given below.

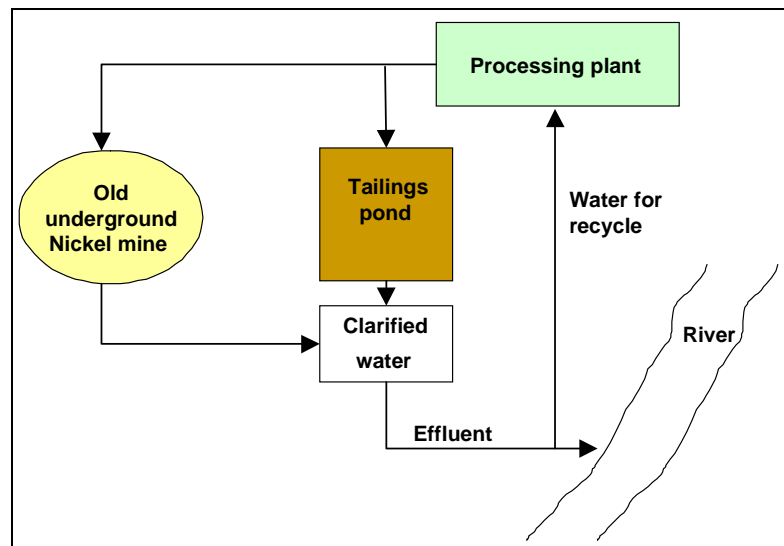

Figure 3.40: Schematic illustration of tailings and effluent treatment at Orivesi mine [59, Himmi, 2002]

The base dam of the tailings pond has been constructed of moraine and there is drainage collection outside the dam to collect seepage water. The necessary raises of the dams are done using moraine for the core and the tailings material as supporting fill.

The TMF was originally constructed for a nickel mining operation. After 20 years of operation the nickel mine was closed, but the mill has been used since to treat gold ore from Orivesi mine located 85 km from the plant. The distance from the mill to the tailings management area is about 500 m. The distance from the tailings area to the river is about 600 m. The surrounding area is not used for agriculture, but the nearest house is only 200 m from the tailings area. The operator does not consider dusting from the tailings management area a problem, because the material on the surface of the area has formed a hard layer. The drainage water is collected by a ditch system and is led directly to a river, because, according to the operator, it does not contain ‘significant’ contamination. [59, Himmi, 2002]

At **Río Narcea**, the tailings are deposited into a lined tailings pond after CN-destruction. The present volume of the deposit is 2.4 Mm³ and the pond is continuously raised according to requirements. The dams are built out of compacted clay with a supporting fill of waste-rock. The pond has an impermeable composite liner system composed of compacted clay and a 1 mm HDPE liner. The pond is surrounded by channels for the diversion of surface run-off. Collected surface run-off is diverted into three sedimentation ponds for clarification before discharge [58, IGME, 2002].

3.1.6.3.3 Safety of the TMF and accident prevention

At the **Bergama-Ovacik** site a full risk assessment has been done, stability calculations have been performed and the design has been carried out by external experts. As described above, the design aims at assuring stability for seismic load, static stability, flood events and any other relevant parameter detected in the risk assessment.

The tailings facility is under daily surveillance for environmental monitoring and structural integrity. The site is routinely audited as per the mother company’s environmental policies and an Ovacik Gold Mine Environmental Management System report prepared. The mine will be subject to an annual internal environmental audit programme using the company’s assessment process to assess the effectiveness of the environmental management systems and the level of environmental performance at the operation. An external audit by an independent expertise group was conducted during the trial operations.

Similarly, management plans on other issues such as health and safety, tailings storage, mine closure and rehabilitation, emergency action and community relations are in place.

[56, Au group, 2002]

The tailings pond at the **Boliden** site is managed according to an OSM manual (see Section 4.2.3.1) designed according to guidelines for dam safety, developed by the Swedish Association for Hydropower Operators (RIDAS). In 1997, when Boliden initiated a dam safety project for tailings dams it was decided to use RIDAS as a guideline where applicable to tailings dams. Changes would then be made when necessary, rather than developing new guidelines for tailings dams. Other mining companies have followed the same route [50, Au group, 2002].

At the **Orivesi** mine, the tailings facility is inspected daily as part of the operational routines at the site. No formal risk assessment has been done. However, the dam undergoes annual audits by independent experts and every fifth year it is audited by the competent authorities. The comments are recorded in the dam safety document, which is a compulsory document for all similar types of tailings management areas since the mid 1980's.

In the construction phase of the tailings facility the soil characteristics were investigated. The system has been constructed in such a way, that the surface of water in the tailings area can be kept in balance and the excess of water from rainfalls etc. can be removed in a controlled manner. There are no instruments installed to monitor the phreatic level in the dam body. A documented emergency plan does not exist. It is not clear if the environmental impact of the backfilling of tailings has been assessed.

[59, Himmi, 2002]

At **Río Narcea**, the dams are controlled using piezometers and inclinometers. The tailings pond undergoes regular audits by external experts. A risk assessment has been performed [58, IGME, 2002].

3.1.6.3.4 Closure and after-care

At **Bergama-Ovacik** mine rehabilitation will be done concurrent with the operation to the extent practicable. Topsoil removed during construction is retained on site for subsequent rehabilitation. A conceptual mine closure and rehabilitation plan has been prepared and will be reviewed yearly during operation. Upon closure of the mine, the tailings pond area will first be covered by rock, gravel, clay and topsoil and then replanted with trees. Prior to the operation of the mine, a financial assurance bond was submitted to the competent authority to secure rehabilitation and closure in accordance with the operation permit protocol [56, Au group, 2002].

At **Boliden**, a water cover solution has been chosen for the closure of the tailings pond. The dams around the tailings pond have been raised to their final height. The pond will be filled up in five years time after which it will be water covered according to existing permits. Apart from the water cover of the open tailings surface, the dams will be re-sloped to 1:3, covered and re-vegetated, long-term stable outlets will be arranged and breakwaters will be constructed in shallow water depths to avoid re-suspension of tailings by wave action. All dams will receive additional long-term stable erosion protection. The back-pumping of seepage water will be carried out until the water quality has improved sufficiently to allow its direct discharge. Water treatment will be conducted by straight liming at the outlet during the same time period, which is expected to last <8 years.

Water cover as a decommissioning method has been used at various sites within Boliden. The water cover established at Stekenjokk in 1991 has been extensively monitored with subsequent follow-ups in detail, showing very good results.

An alternative decommissioning technique currently being evaluated is wetland establishment. This would allow for a higher sand level in the pond (better use of existing pond), less water stored in the pond (less risk) and a self generating organic oxygen consuming cover the top of the tailings.

Boliden is also trying out an alternative method called ‘water saturation’ or ‘raised groundwater level’ which basically is applicable where the natural groundwater level in the tailings is very shallow. By applying a simple soil cover the groundwater level can then be raised to permanently cover the tailings and eliminating sulphide oxidation (see Section 4.2.4).

[50, Au group, 2002]

At **Orivesi** a plan for closure and after-care has been developed recently, concerning the mine site and the industrial area. Only a draft plan has been made concerning the tailings management area. The main idea is to cover old tailings material from the nickel process with the tailing material from the gold process. A total of EUR 0.6 million has been reserved for closure [59, Himmi, 2002].

At **Río Narcea** the tailings pond will be dewatered and covered using soil that has been temporarily stockpiled at the edge of the pond. Re-vegetation will be carried out and the area will be returned to original land use (pasture). Pore water, with a WAD CN concentrations <1 mg/l, will be collected through the installed underdrains in the pond and analysed before discharge.

3.1.6.4 Waste-rock management

At the **Bergama-Ovacik** gold mine the overburden and the waste-rock are andesites which are currently used as rock fill material on the downstream side of the TMF embankment. The waste-rock source at later stages of the mine will be from underground workings (galleries, drifts etc.) and these materials will be used as backfill in the underground voids.

ARD potential and geotechnical property tests were conducted on the waste-rock. These tests revealed that the waste-rock does not have ARD potential and is has adequate properties for use in construction of the rock fill dam and retaining structures. The non-ARD potential of the waste-rock allowed the operator to use this material in the retaining structure of the TMF while providing an optimum use of the storage area requirement at the facility. The waste-rock is transported from the open pit area by trucks and placed on the downstream slope of the TMF embankment and spread evenly and compacted with clay material.

Because of the inert nature of the waste-rock, there is no environmental risk associated with the waste-rock dumping unit at the Ovacik Gold Mine. (according to a probabilistic risk assessment carried out by an independent consultant).

[56, Au group, 2002]

At **Boliden**, the waste-rock is generated at the five mines supplying the mineral processing plant with ore. As these mines are mainly base metal mines, this waste-rock management is described under the section for base metals (see Section 3.1.2.4) [50, Au group, 2002].

At **Filón Sur**, 0.1 million tonnes/yr of waste-rock are generated. There is no information on how this is handled nor any information on the characteristics of this material [57, IGME, 2002].

Orivesi uses all its waste-rock as backfill in the underground operations. No waste-rock is hoisted to the surface [59, Himmi, 2002].

At **Río Narcea**, six million tonnes of waste-rock were produced in 2001. Approximately 20 million tonnes of waste-rock is kept in waste-rock dumps at the site. Topsoil is separately stored so that it can be used in the reclamation of the site. Waste-rock from mine production will be backfilled in mined out open pits as production progressively moves along. The initial waste-rock dump, from the initial open pit, will be decommissioned in-situ. The waste-rock consists mainly of silicates (granite and sandstone) and various carbonates (limestone) [58, IGME, 2002].

3.1.6.5 Current emissions and consumption levels

In addition to the routine occupational health and safety monitoring, an environmental monitoring programme has been established at the **Bergama-Ovacik** mine. An official monitoring committee assigned by the Turkish Government carries out verification sampling. Environmental monitoring data are compiled in monthly reports and submitted to the competent authorities. These are also opened up to the community through various means including the national press and other public reports. Environmental sampling locations are presented in the figure below. Data collected for the periodical environmental monitoring are the following:

- dust, noise and vibration levels
- WAD CN in tailings water leaving the detoxification unit and at the water intake from the tailings pond
- heavy metals (As, Sb, Cd, Hg, Cu, Pb, Zn, Cr) in the tailings water
- indicator water quality, including WAD CN at the six groundwater monitoring wells located downgradient of the tailings dam
- HCN measurements at various locations at the mine, including the tailings pond area.

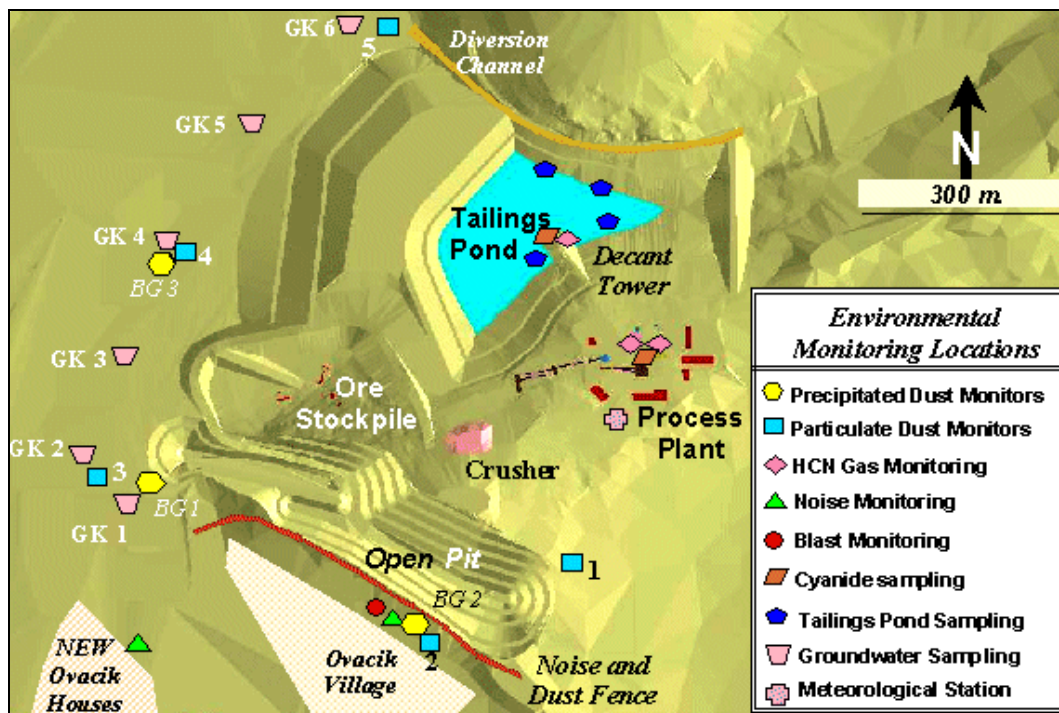

Figure 3.41: Environmental monitoring locations at Ovacik site [50, Au group, 2002]

The control programme followed at the **Boliden** mineral processing plant consists of:

- surface (numerous monitoring points with varying frequency) and groundwater monitoring (17 monitoring wells with monthly sampling)
- emissions to air (dust and gases)
- CN destruction monitoring (at various points. The discharge from the CN-destruction plant to the tailings pond is sampled six times per day and the discharge from the tailings pond daily)
- noise and vibration monitoring
- recipient investigations.

Environmental monitoring data are compiled in monthly reports and submitted to the regulatory authorities and shared with the community through various means including a local reference group that meets regularly at the site to discuss any issues of concern and for general information.

3.1.6.5.1 Management of water and reagents

The design criteria and management system for **Bergama-Ovacik** tailings pond is set for 'zero' release of water to the receiving environmental media. This is possible as the operation is a net consumer of water (due to the arid climate conditions) and re-uses all the water from the tailings pond in the process. Mean annual rainfall and evaporation of the area are 728 and 2313 mm, respectively (i.e. there is a negative water balance).

The catchment area at the point of the upgradient dam is approximately 0.6 km². Maximum possible flood discharge is calculated as 24.6 m³/s for the first hour of an extreme rainfall event. In the event of such extreme rainfall, the potential floodwaters coming from the catchment area will be stored in the run-off water pond behind the upstream embankment. The accumulated water will be pumped to the tailings pond or the excess water taken directly into the diversion channel, which is constructed along the north side of the pond.

The water consumption at the **Boliden** mineral processing plant is approximately 4.5 Mm³/yr or 2.9 m³/tonne of ore. The water is obtained from a lake 2 km north of the mineral processing plant. Some re-circulated water is used in the mill for cleaning and cycloning. Of the total amount of water used in the mineral processing plant about 10.5 % are re-used.

Due to oxidation of thiosalts and depending on the time of the year, the water contained within the pond is of low pH and contains elevated metal concentrations. The discharge from the tailings pond is, therefore, treated in a straight liming installation installed at the outlet of the tailings pond. A small sedimentation pond has been constructed to collect the precipitates. The pond is dredged biannually and the precipitates are deposited within the tailings pond. The flow of the discharged water is measured daily. Discharged water volume from the tailings pond is presented in table below.

Year	1997	1998	1999	2000	2001
Flow (l/s)	254	238	186	218	352
Volume (Mm ³)	8.0	7.5	5.9	6.9	11.11

Table 3.51: Discharged water from Boliden TMF from 1997 - 2001
[50, Au group, 2002]

The following figure illustrates the seasonal variations of the water quality in the tailings pond system and the recipient water body (year 2001 data).

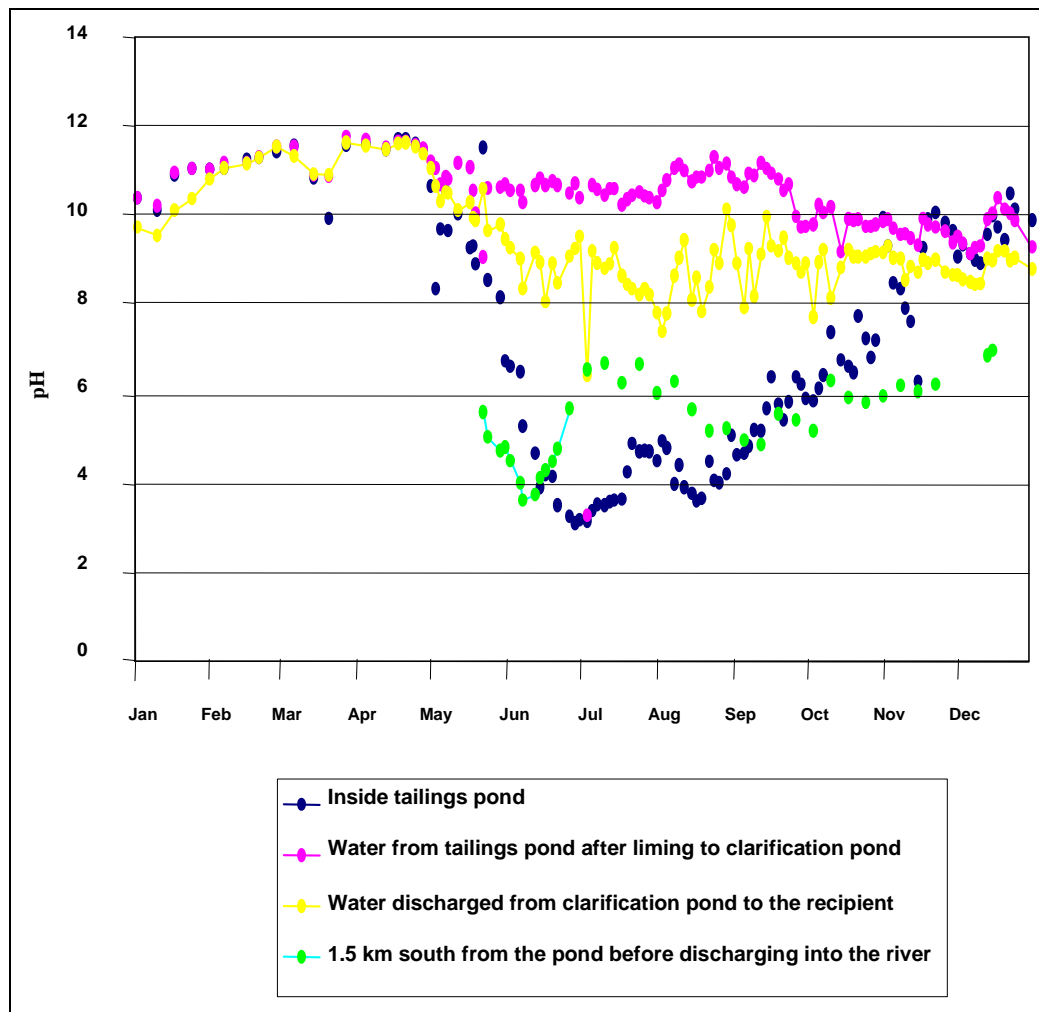

Figure 3.42: Seasonal variations of water quality in the tailings pond and the recipient at Boliden in 2001
[50, Au group, 2002]

The sampling points in the figure above are at four different sampling points: inside the tailing pond, discharge water from the pond after liming to the clarification pond, discharged water from the clarification pond to the recipient and 1.5 km south of the pond before discharging to the river. The pH in the tailings pond during winter seasons is 10 - 11. During spring and summer the pH drops to about 3.5 due to the oxidation of thiosalts and the discharged water is therefore limed to pH 9-11 to neutralise the acid effects as described above.

During 2002, the downstream dam will be raised, the discharge system will be rebuilt and a new system for flow monitoring will be installed. The discharge from the tailings pond will be rearranged from a decant tower to an overflow channel in natural ground. A back-up system for discharging water in the tailings pond is in place and will be raised.

A water balance for the Boliden mineral processing plant, the tailings pond and the surroundings is illustrated in the figure below for a year with average precipitation.

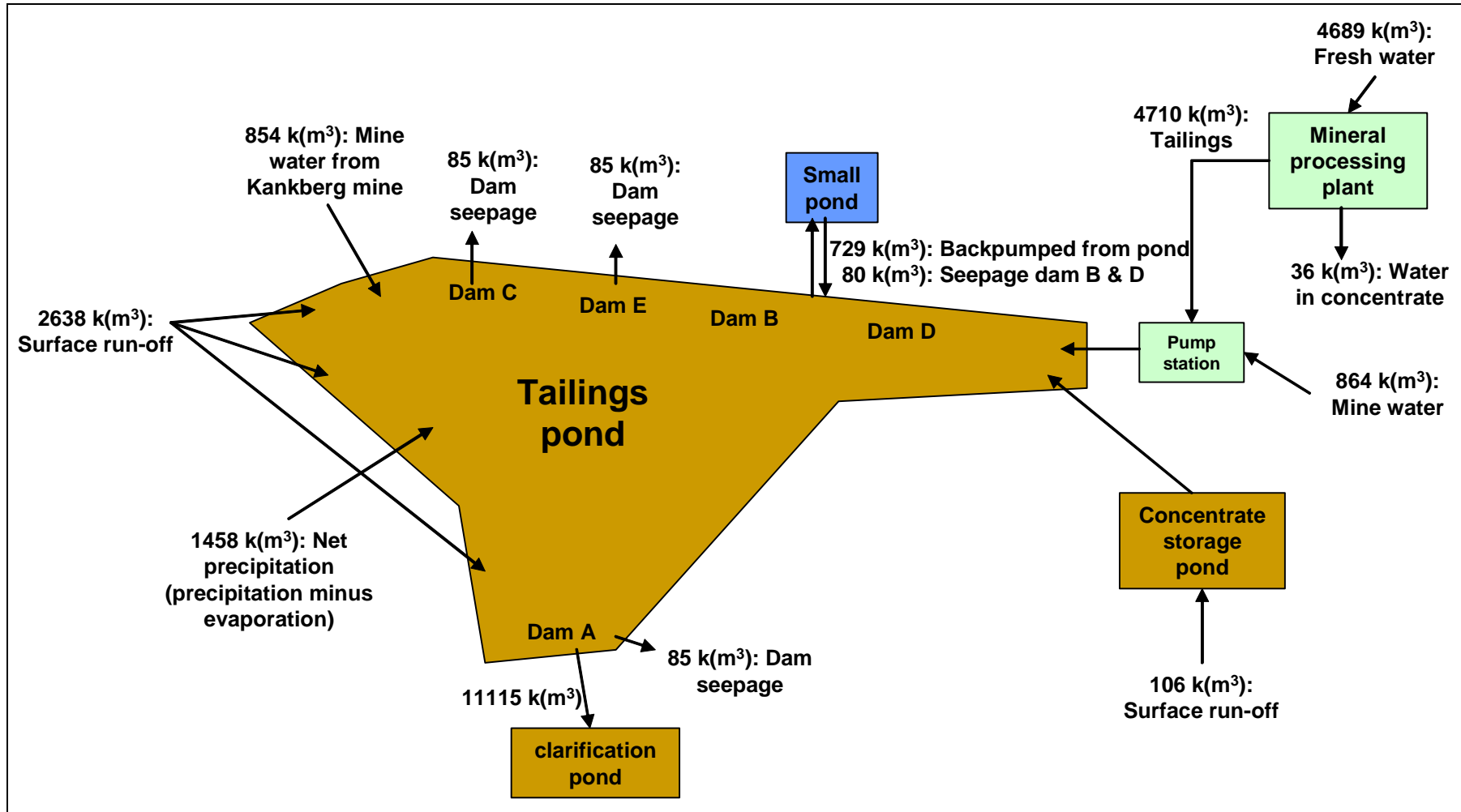

Figure 3.43: Water balance at Boliden site [50, Au group, 2002]

Within the industrial area there is an old open pit and a shaft under the mineral processing plant. Drained water is pumped to the tailings pond to be treated before discharging to the recipient. Drained water from the tailings pond is pumped back to the pond continuously. A small lake north of the tailings pond is continuously pumped in order to maintain a lower water level than the surroundings and, thereby, to capture any possible seepage and pump it back to the tailings pond. Data such as snow depth, rain and groundwater level are collected for the water balance. The data of water in the concentrates are also used for the water balance. The system is used for monitoring the amount of water in the system.

Discharge from the Boliden tailings pond only occurs through the outlet at dam A. The seepage that occurs through dams B, C, D and E is back-pumped into the pond from the small collection pond (see Figure 3.43).

It should be noted that at the Boliden TMF, dilution through precipitation and surface run-off adds (besides the natural decomposition of CN compounds) to the decreased CN concentration.

Fresh water consumption is monitored continuously in the process system in the mineral processing plant.

At the Boliden gold leaching plant sodium cyanide is used for collecting precious metals. Sulphur dioxide is used in the destruction of cyanide and lime is used for pH-regulation, before discharging to the tailings pond. During 2001 the consumption of chemicals used in the recovery of gold (at a throughput of 0.8 million tonnes) was as follows:

lime (gold and base metals):	5000 tonnes
sulphur dioxide:	1260 tonnes
sodium cyanide:	450 tonnes

The CN that is discharged into the tailings pond undergoes further natural decomposition in the pond system. This is the reason for further decreases in CN concentrations in the tailings pond and, if discharge occurs, in the discharge from the tailings pond. Values from Ovacik site, where there is no discharge to the recipient, shows that the average WAD CN concentration in the discharge to the pond is 0.33 mg/l while the concentration in the pond itself is 0.19 mg/l. At the Boliden site the total CN concentration in the discharge to the tailings pond is on average 0.89 mg/l, while the discharge from the pond contains only an average 0.06 mg/l total CN. Natural decomposition of possible trace contents of cyanide is assumed to take place in the tailings pond, following a complex scheme of processes.

At the **Orivesi** mine, the clarified water from the tailings management area, including the rainfall water, or from the old underground mine is re-used/used in the process. The mineral processing plant is operating only with this water, without any additional water from natural surface waters. Depending on the rainfall, it is sometimes (but not every year) necessary to remove excess water from the system by leading it to the river. Recycling also saves small amounts of reagents, but the savings are not very significant, because the flotation reagents decompose in the tailings management area. A schematic water balance is presented in the figure below.

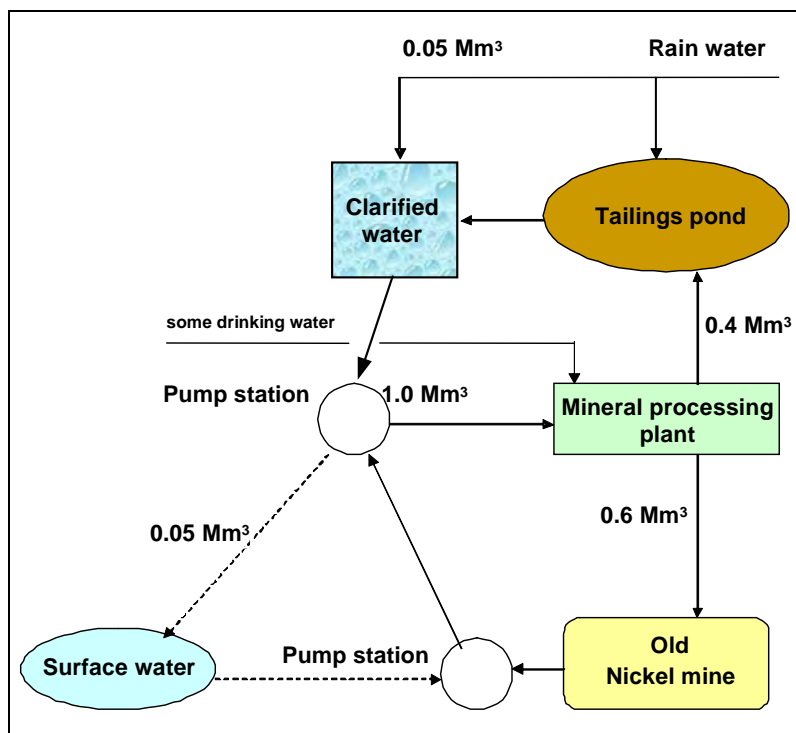

Figure 3.44: Water cycle at Orivesi site
[50, Au group, 2002]

During 2001 the (unit) consumption of reagents at the Orivesi gold mine is given in the table below.

Reagent	Consumption
	(g/t)
SIBX	50
DTP	50
Dowfroth	8
Flocculant	2
Steel balls	1500
Steel rods	700

Table 3.52: 2001 unit reagent consumption at Orivesi mine

3.1.6.5.2 Emissions to air

At **Bergama-Ovacik**, dust and HCN emissions are monitored on a daily basis. Dust emissions are eliminated by surface wetting of the roads and by a scrubber system at the crushers and conveyors. HCN gas is monitored over the leach tanks and on the embankment of the tailings pond, producing monitoring results of nearly zero. A scrubber treats the gas emissions to air from the regeneration oven of the activated carbon.

At the **Boliden** mineral processing plant, the emissions to air are monitored. During the last years the biggest emission source to air, drying of concentrates, has been completely eliminated by the introduction of filters instead of using ovens. The gold leaching plant has a complete purification plant for all ventilation air. This air passes through a wet scrubber where any possible HCN is absorbed in a sodium-hydroxide solution at high pH. The CN laden solution is returned to the CIL-process. The regeneration circuit for the activated carbon is equipped with a wet scrubber where lime is added for pH adjustment.

The emission from the gold leaching plant during year 2001 is summarised in the table below. Apart from the emissions reported in the table below the Boliden mineral processing plant reported emissions of 0.1 tonne particles in suspension.

Date	Operating hours	Emissions				
		Particles	CN _{tot}	Hg	H ₂ S	SO ₂
Regeneration of activated carbon	h	kg	kg	kg	kg	kg
2001 – 10 - 16	30	128.550	0.270	0.000	8.700	1.275
2001 – 11 - 22	30	1.350	0.009	0.006	10.050	1.275
Wet-scrubber						
2001 – 11 - 22	1400		4.200			
2001 – 10 - 16	1400		3.080			
2001 – 07 - 03	1400		0.042			
Ovens						
2001 – 12 - 03	437.5	0.013	0.051			
2001 – 09 - 25	437.5	0.001	0.001			
Total		129.91	7.65	0.007	18.75	2.55

Table 3.53: Emissions to air from Boliden gold leaching plant

At the **Orivesi** mine dust emissions are not measured, but some dust emission occurs from the crushing plant.

3.1.6.5.3 Emissions to water

No discharge of water occurred from the **Bergama-Ovacik** site during year 2001 therefore no direct emissions. Groundwater monitoring does not indicate any discharge to the groundwater.

The emissions to surface water from the **Boliden** site are summarised in the table below for the last four years (1998 - 2001). The annual average concentrations are given together with total annual load of each element.

Year	Volume Mm ³	Cu		Pb		Zn		As		Cd	
		µg/l	kg	µg/l	kg	mg/l	tonne	µg/l	kg	µg/l	kg
2001	11.1	7	72	19	191	0.1	1.07	14	156	0.1	1
2000	6.9	10	70	34	235	0.11	0.77	8	55	0.1	3.0
1999	5.9	8	51	10	59	0.2	1.04	10	58.7	0.1	0.6
1998	7.5	22	134	20	100	0.22	1.33	1	7.5	0.2	1.5

Table 3.54: Emissions to surface water from Boliden site

The production at the gold leaching plant started in July 2001. During the remainder of that year a total of 417 kg of CN_{tot} were discharged. Once the plant had reached normal production the average concentration of CN_{tot} in the discharge reached 0.06 mg/l.

At the **Orivesi** mine the total emissions to surface water for year 2000 are given in the table below.

Parameter	Unit	Year 2000
Tailings water discharge	m ³	780000
Ca	t	-
SO ₄	t	680
COD	t	-
Solids	t	15
Cu	kg	10
Zn	kg	-
Fe	kg	-
Cd	g	-
Ni	kg	278
Cr	kg	-

Table 3.55: Emissions to water from Orivesi site

A slight increase of metal contents in groundwater (compared with the contents in the baseline study) have been observed after the nickel mine was closed and the groundwater had reached the original level. The tailings water from the current gold process has not increased the metal contents in ground water.

3.1.6.5.4 Energy consumption

The energy consumption for tailings management at **Orivesi** is reported to be 1 kWh/t. The total energy consumption at the site per tonne ore processed is 53.5 kWh/t.

At **Ovacik** mine the monthly total energy consumption (based on the first 10 months of operation) 1500 MWh. Corresponding to the designed throughput of 0.3 million tonnes/yr, this results in a total energy consumption of 60 kWh/t of ore processed.

At the **Boliden** mineral processing plant it is estimated that tailings management consumes about 2 kWh/t.

3.1.7 Tungsten

In this section, information is provided about the Panasqueira mine in Portugal and the Mittersill mine in Austria.

3.1.7.1 Mineralogy and mining techniques

Wolframite ((Fe, Mn)WO₄, iron manganese tungstate) is actually a series between two minerals; huebnerite and ferberite. Huebnerite is the manganese-rich end member of the series while ferberite is the iron rich end member at the other end of the series. Wolframite is the name of the series and the name applied to indistinguishable specimens and specimens intermediate between the two end members. Most specimens found in nature fall within the 20 - 80 % range of the series and these are termed wolframites. Only if they are more pure than 80 % manganese are they called huebnerite and conversely if they are 80 % iron they are called ferberite. Scheelite (CaWO₄, Calcium Tungstate) is an important ore of tungsten which is a strategically important metal. Scheelite is named after the discoverer of tungsten, K. W. Scheele [37, Mineralgallery, 2002].

The **Panasqueira** mine in Portugal mines ferberitic type wolframite. In the year 2000, 332000 t of ore were extracted, which yielded 1269 t of wolframite concentrate (75 % WO₃), 12 t of cassiterite concentrate (72 % Sn) and 132 t of chalcopyrite concentrate (28 % Cu).

The Panasqueira orebody occurs as a sequence of almost parallel quartz veins containing, amongst other minerals, wolframite and cassiterite. The mineralised zone has a length of approximately 500 to 1000 metres, and continues 500 metres downwards. The upper parts of the orebody have been mined out. The wolframite mineralisation occurs as very large crystals or large crystal aggregates, usually concentrated towards the margins or, occasionally, close to the mid-line of the quartz vein host. The mineralisation may be accompanied by intense biotite alteration.

At **Panasqueira** the applied mining method is room-and-pillar mining. [141, Panasqueira, 2003]

In 1975, the mining operation in **Mittersill** started with an open pit operation. In 1979, the underground operation was developed. The open pit was closed in 1986. Today 450000 tonnes of ore are mined yearly in the underground mine with an average WO_3 -content of 0.50 %.

The host rock of the Mittersill deposit consists of quartz lenses, laminated quartzites, pyroxenites, orthogneisses, amphibolites, hornblendites and granites. The tungsten bearing mineral at Mittersill is scheelite ($CaWO_4$). The main gangue minerals are quartz, silicates (mica, talc, biotite, hornblende, amphibole, pyroxene, etc.), carbonates, apatite and sulphides. The content of sulphide minerals is <0.5 %. The most frequent sulphide mineral is pyrrhotite. Less frequent are pyrite, chalcopyrite, galena and molybdenite.

The whole mining operation in Mittersill is situated in a protected landscape. Therefore, all the social facilities, workshops and warehouses are installed underground. The ore is crushed underground. The mine and the mineral processing plant are connected by a 3 km long gallery. The ore is transported from the crushing station to the mineral processing plant by a conveyor belt system.

The main mining methods used for the extraction of the massive orebody are:

- sublevel stoping
- sublevel caving
- cut and fill.

The waste-rock which is mined during the development of the orebody is dumped into open stopes underground. There are no waste-rock dumps on the surface. Tailings are used for backfilling of the open stopes.

3.1.7.2 Mineral processing

At **Panasqueira**, the wolframite is recovered by a combination of dense medium separation, shaking tables and flotation. Tin and copper are also removed by flotation. [141, Panasqueira, 2003]

In **Mittersill**, due to the fine intergrowth of scheelite with the gangue minerals, the ore is treated by flotation as using gravity separation would result in high losses of scheelite, making the operation uneconomical. In the following section the circuit at the Mittersill operation is described in more depth.

3.1.7.2.1 Comminution

The ore is crushed to <14 mm by means of a three stage crushing system, situated underground. The crushed ore is then stored in two underground ore bins before being transported to the mineral processing plant by a conveyor belt system situated in a 3 km long gallery. Just beside the mineral processing plant there is a stockpile dimensioned so as to secure the supply of the process with ore for discontinued production at the crushing plant.

The top size of the feed is further reduced to <10 mm in a one stage crushing system consisting of a cone crusher which operates in closed cycle with a vibrating screen. The crushed ore is stored in two ore silos from where the ore is fed to a single stage ball mill at a feed rate of 80 – 82 t/h. To achieve sufficient liberation of the scheelite from the gangue, the ore has to be ground to 80 % passing 180 μm . The mill discharge is pumped to a classification system, which consists of screens and a hydrocyclone. The fines with a top particle size of 500 μm are pumped to the flotation process, the coarse fraction is recycled to the ball mill.

[52, Tungsten group, 2002]

3.1.7.2.2 Separation

Flotation consists of one rougher bank and four cleaning stages. A concentrate with an average grade of 40 % WO_3 is produced. The rougher tailings are pumped to a hydrocyclone. The cyclone underflow, which contains coarse and intergrown scheelite is recycled to the ball mill for regrinding, the hydrocyclone overflow represents the final tailings stream. The collectors used for flotation are fatty acids (carboxylates), alkyl sulphonates and alkyl sulphate.

A schematic flow sheet of the processing plant is given in the figure below.

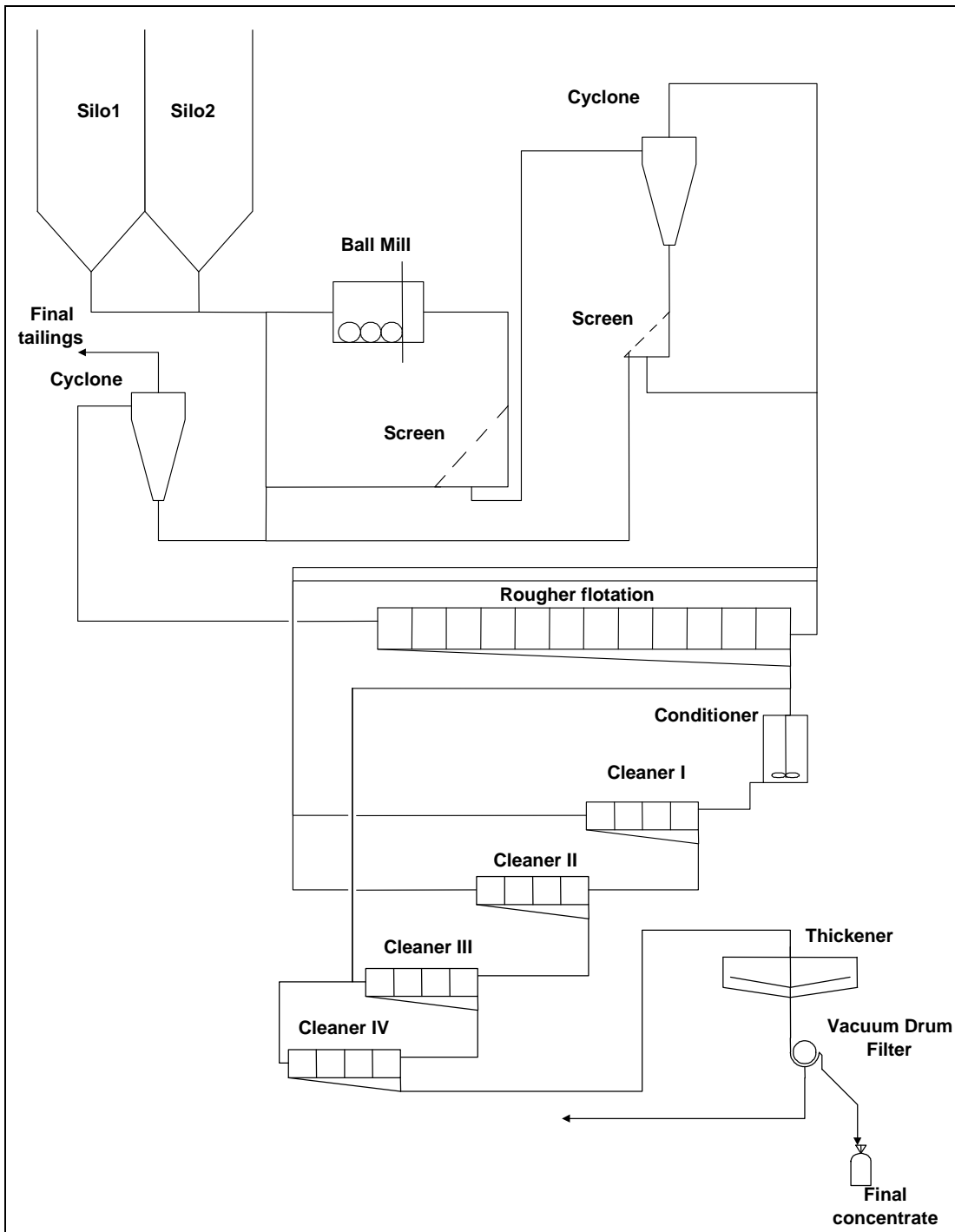

Figure 3.45: Flow sheet of Mittersill mineral processing plant [52, Tungsten group, 2002]

3.1.7.3 Tailings management

The tailings at the **Panasqueira** operation are managed in ponds [141, Panasqueira, 2003].

The tailings stream at **Mittersill site** represent 99 % of the initial process feed. At the present throughput of 450000 t/yr, a storage volume of 250000 m³ is needed every year.

The Mittersill site operates two tailings management systems:

- a tailings pond, approximately 10 km away from the mineral processing plant in a valley
- a backfilling system, with a maximum capacity of 35 % of the mineral processing plant feed.

The tailings ponds cover an area of 34 ha, of which 20 ha have already been reclaimed.

3.1.7.3.1 Characteristics of tailings

The chemical behaviour of the tailings has been characterised. The test procedures involved:

- performing leachate tests
- determination of the total content of heavy metals by leaching the solids with aqua regia.

The following tables show the results of these tests.

Parameter leachate	Test results
pH	7.8
Conductivity, mS/cm	0.8
Ca, mg/l	10
Mg, mg/l	9
Al, mg/l	0.17
Sb, mg/l	<0.01
As, mg/l	<0.05
Ba, mg/l	<0.5
Be, mg/l	<0.005
B, mg/l	<0.01
Pb, mg/l	<0.05
Cd, mg/l	<0.005
Cr total, mg/l	<0.05
Fe, mg/l	<0.1
Co, mg/l	<0.01
Cu, mg/l	<0.01
Mn, mg/l	<0.01
Ni, mg/l	<0.05
Hg, mg/l	<0.001
Se, mg/l	<0.01
Ag, mg/l	<0.05
Th, mg/	<0.01
V, mg/l	<0.01
Zn, mg/l	<0.5
Sn, mg/l	<0.05
F, mg/l	<0.01
PO ₄ , mg/l	0.6
SO ₄ , mg/l	156
CN, mg/kg dry solids	n/d
F, mg/kg dry solids	n/d
NO ₃ -N, mg/kg dry solids	0.8
Anionic surfactants, mg/kg dry solids	<0.05
Total hydrocarbons-C, mg/kg dry solids	Not detectable
Hydro-Carbons, mg/kg dry solids	Not detectable
Extractable organic halogens, mg/kg dry solids	Not detectable

Table 3.56: Leachate test results of tailings at Mittersill site
[52, Tungsten group, 2002]

Parameter total content	Test results (mg/kg dry solids)
As	7
Cd	<0.5
Co	<0.5
Cr	31
Cu	<0.5
Ni	22
Hg	Not detectable
Pb	12
Zn	82
THC	Not detectable
HC	Not detectable
PAH	Not detectable

Table 3.57: Heavy metal contents of tailings at Mittersill site
[52, Tungsten group, 2002]

The following figure shows the grain size distribution of the feed to the mineral processing plant and the tailings.

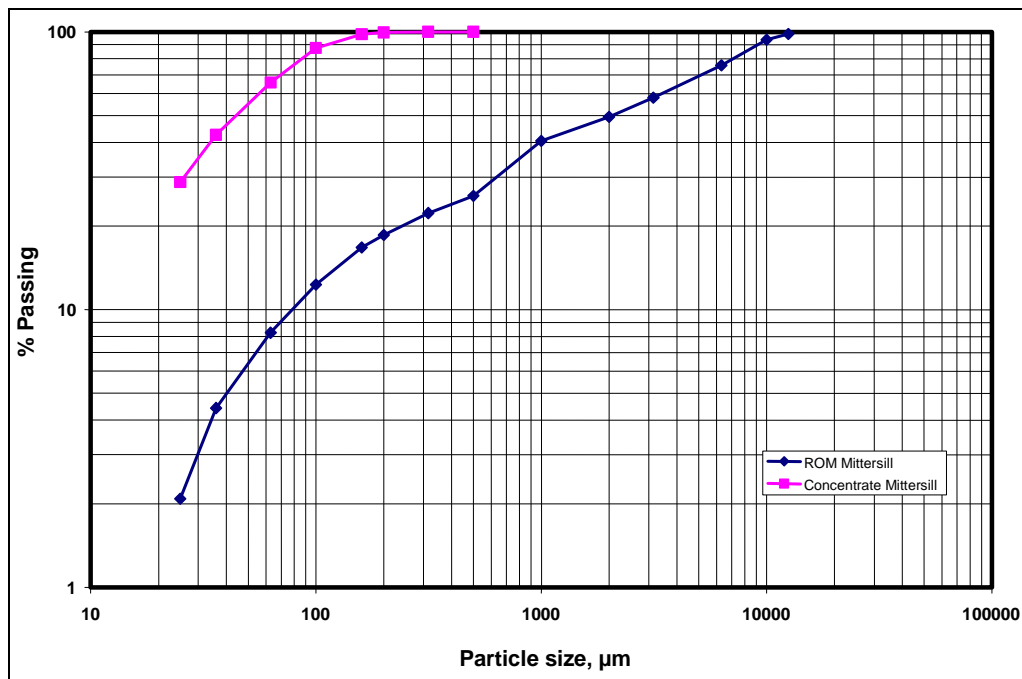

Figure 3.46: Size distribution of feed to mineral processing plant and tailings at Mittersill site
[52, Tungsten group, 2002]

3.1.7.3.2 Applied management methods

The backfilling system was installed in 1987 and consists of a lamella thickener, a piston diaphragm pump and a steel pipeline which connects the mineral processing plant with the different levels of the underground mine. The backfill has to be pumped over a distance of 3000 m and up to a maximum height of 280 m.

The currently operated tailings pond is situated south of the little village of Stuhlfelden. The start-up of the tailings ponds was in 1982. Until this time the first tailings pond, the 'Felbertal' pond, situated just on the opposite side of the mineral processing plant, was in operation. The final height of this first tailings dam was 24 m. The dam was built using the upstream method.

Every 8 m a drainage system was installed. The starter dam consists of borrow material, the second and third stage were built using tailings.

The tailings ponds in Stuhlfelden are built using the upstream method. The final height of the tailings dam Stuhlfelden I & II was 16 m. The dams IVA and IVB will reach a final height of 24 m. The starter dams of ponds I and II with a height of 4 m were constructed using borrowed material. The starter dam of tailings pond IVA was built with tailings. To prevent erosion, the surface of the dam is covered with humus and re-vegetated. On one side, the area is limited by a slope. Two roads which cross the slope 30 and 60 m above the pond prevent uncontrolled entering of surface water into the tailings pond area. Prior to construction of the starter dam, the area was investigated by geotechnical engineers. Where necessary, the foundation of the starter dam was reinforced. The construction was surveyed by geotechnical engineers and reviewed by the water and mining authority.

In spring and summer, the water surface in the pond is kept high enough to prevent dust emissions from the tailings pond area. In autumn, water is discharged to the nearby stream. To prevent dusting from the tailings pond area, an automatic sprinkling system was installed. The sprinkling system is started and monitored from the central control room of the plant. During shutdowns of the mineral processing plant, standby teams are on duty to control the tailings pond area. The nearest river, the river Salzach is approximately 600 m away from the tailings ponds.

3.1.7.3.3 Safety of the TMF and accident prevention

The dams are raised in 2.5 m sections every year. The height of the layers applied to the dam surface is 0.5 m. The dam is divided in sections of 50 m. From every profile four samples are taken from the applied layer. The compaction is checked by using the proctor method. From one sample of every profile a particle size analysis is performed. The construction, monitoring, sampling and the data are controlled by a civil engineer and the federal authority.

For monitoring settlements of the tailings pond piezometers were installed. The ground movements are checked yearly. The data are controlled by the federal authority.

Monitoring of the TMF is performed three times a day by the process supervisors. For heavy rainfalls and failure of the barriers, excess water can be discharged through an emergency outlet.

To prevent erosion of the dam by the slurry, the inner surface of the dam is covered by a geotextile.

3.1.7.3.4 Closure and after-care

It is planned to cover the pond surface with humus and grass. After reclamation the land is given back to the landowners. The tailings of the Mittersill operation readily dewater. It is known from already reclaimed tailings ponds that the tailings dewater and consolidate within a time period, i.e. 2 – 4 years.

Partial reclamation of the tailings pond is already performed during operation. The dam is constructed at the final inclination. The outer dam surface is already covered with humus and reclaimed.

3.1.7.4 Waste-rock management

At Mittersill, the waste-rock which is mined during development of the orebody is dumped into open stopes underground. There are no waste-rock dumps on the surface.

3.1.7.5 Current emissions and consumption levels

3.1.7.5.1 Management of water and reagents

No water is recycled from the tailings pond to the mineral processing plant.

3.1.7.5.2 Emissions to air

The average emissions of dust particulates from the tailings pond area are in the range of 50 mg/(m² 28 days).

3.1.7.5.3 Emissions to water

The following table shows the parameters measured in the effluent discharged from the tailings pond.

Parameter	Average Values 1997
Temperature, °C	13.8
pH	7.9
Volume of sediment, ml/l	<0.1
Aluminium, mg/l	0.072
Iron, mg/l	0.285
Tungsten, mg/l	<0.1
Nitrite, mg/l	<0.1
Phosphorus, mg/l	<0.1
Chemical oxygen demand, mg/l	32.3
Total hydrocarbons, mg/l	<1

Table 3.58: 1997 averages of parameters measured in discharge from TMF of Mittersill site [52, Tungsten group, 2002]

Monitoring of the effluent of the tailings pond is performed twice a week by the laboratory technicians. When discharging the water into the nearby river, sampling of the water of the river upstream and downstream is performed daily. These samples are analysed in the laboratory of the mill and by a chemical laboratory. A report is sent to the federal authorities every year.

3.1.8 Costs

3.1.8.1 Operation

The following table lists the costs for tailings and waste-rock management.

Operation	Sub-operation	Cost interval	Units	Site/reference
Waste-rock management				
	Hoisting to surface	0.5 - 1	EUR/t	¹
	Surface transport to dump	0.2 - 0.5	EUR/t x km	¹
	Dump construction	0.1 - 0.5	EUR/t	¹
Tailings management				
	Pumping to pond	0.1	EUR/t	¹
	Tailings distribution	0.05 - 0.3	EUR/t	¹
	Dust suppression	>0.1	EUR/t	¹
	Tailings dewatering	1.0 - 4.0	EUR/t	¹
	Truck transport to mine/dump	0.5 - 1	EUR/t	¹
	Tailings pumping and maintenance	0.1	EUR/t	¹
	Dam raises	0.4	EUR/t	¹
	Water treatment with lime	0.1	EUR/t	¹
	Monitoring	0.1	EUR/t	¹
	Total operating cost	0.8	EUR/t	Boliden ²
	Capital cost for 7 Mm ³ pond	5.34	EUR million	Zinkgruvan ³
	Capital cost pumps, 100 l/s	0.45	EUR million	Zinkgruvan ³
	Tailings pumping	0.11	EUR/t	Zinkgruvan ³
	Pumping water back to processing plant	0.04	EUR/t	Zinkgruvan ³
	Pipe wear	0.16	EUR/t	Zinkgruvan ³
	Piers	0.07	EUR/t	Zinkgruvan ³
	Total operating cost	0.37	EUR/t	Zinkgruvan ³
	Dam safety monitoring	0.05	EUR/t	Zinkgruvan ³
	Total operating cost	0.8	EUR/t	Zinkgruvan ³
	Dam raises	0.5	EUR/t	Río Narcea ⁴
	CN destruction	1.0	EUR/t	Río Narcea ⁴
	Others (energy, pipes, maint.)	0.5	EUR/t	Río Narcea ⁴
	Total operating cost	2.0	EUR/t	Río Narcea ⁴
	Total operating cost	0.6	EUR/t	Kemi ⁵
	Total operating cost	0.4	EUR/t	Orivesi ⁶
	Total operating cost	0.48	EUR/t	Pyhäsalmi ⁷
	Total operating cost	0.3	EUR/t	Hitura ⁷
	Total operating cost	0.4	EUR/t	Garpenberg ⁸
Sources:				
1 = [98, Eriksson, 2002]				
2 = [65, Base metals group, 2002]				
3 = [66, Base metals group, 2002]				
4 = [58, IGME, 2002]				
5 = [71, Himmi, 2002]				
6 = [59, Himmi, 2002]				
7 = [62, Himmi, 2002]				
8 = [64, Base metals group, 2002]				

Table 3.59: Costs for tailings and waste-rock management at metal sites

At the **Boliden** mineral processing plant the operational cost for deposition of tailings is EUR 0.8/t. This figure includes the energy cost for pumping the tailings and maintenance (EUR 0.1/t) and the actual cost to raise the dam (EUR 0.4/t), water treatment of discharged water from the pond (EUR 0.1/t) and monitoring costs (EUR 0.1/t).

At **Garpenberg** the operational cost for the tailing deposition is EUR 0.4/t ore processed. This cost includes pumping costs, raising of dams, maintenance of pipelines and pumps, monitoring etc. However, it does not include decommissioning costs.

Tailings management costs in the **Legnica-Glogow copper basin** are as follows:

Sub-operation	Costs interval	Unit
Tailings pumping to the tailings pond ¹⁾	0.530	EUR/t
Dam construction	0.060	EUR/t
Pumping water back to the processing plant ¹⁾	0.333	EUR/t
Dust spraying with asphalt emulsion ²⁾	0.031	EUR/t
Air, water, soil and seismic monitoring	0.020	EUR/t
Safety supervision and control procedures (geotechnical monitoring)	0.014	EUR/t
Emergency alarm system	0.0004	EUR/t
Ecological fee for tailings disposal ³⁾	0.470	EUR/t
Pumping excess water to the Oder river ⁴⁾	0.064	EUR/m ³
	0.046	EUR/t
Purification of discharged water ⁴⁾	0.043	EUR/m ³
	0.031	EUR/t
Hydrotechnical monitoring ⁴⁾	0.003	EUR/m ³
	0.002	EUR/t
Ecological fees for discharged water ⁴⁾	0.135	EUR/m ³
	0.097	EUR/t
Total operating cost	1.634	EUR/t
1. The relevant figures to relate to these costs are shown in the following tables 2. Cost includes cost for emulsion and distribution from helicopter and ground vehicles. The yearly sprinkled surface is about 1080 ha, taking into account that some places are sprinkled more than once. 3. Compulsory fee 4. In 2002 18.9 Mm ³ of water was discharged from the tailings pond, from which 18.6 Mm ³ to the Oder river and 362664 m ³ to the bottom of the pond. The data refer to 1m ³ of discharged water and to 1 t of tailings (1t of tailings refers to 0.721 m ³ of discharged water).		

Table 3.60: Tailings management costs in the Legnica-Glogow copper basin
[113, S.A., 2002]

Processing plant	Tailings generated in 2001 (dry Mt/yr)	Horizontal distance (km)	Elevation (m)
Lubin	6.4	13.4	47
Polkowice	8.0	13.7	39
Rudna	12.5	11.2	23

Table 3.61: Relevant tailings generated, distance and elevation between mineral processing plants and the tailings pond in the Legnica-Glogow copper basin
[113, S.A., 2002]

Processing plant	Water returned in 2001 (Mm ³ /yr)	Horizontal distance (km)	Elevation (m)
Lubin	26.8	12.1	45
Polkowice	27	9.7	60
Rudna	67	6.4	60

Table 3.62: Relevant amounts of water returned to mineral processing plants, distance and elevation between mineral processing plants and the tailings pond in the Legnica-Glogow copper basin
[113, S.A., 2002]

At **Zinkgruvan** up to the beginning of 1990's the tailings were managed above the water surface which was less expensive as the pipes could be stationary at one fixed point for a long time. Since the start of discharging mainly under the water surface the costs per unit have been more than double. On the other hand the management under water has given a significant reduction of the metal transport from the pond and less dusting from the tailings area.

The operating costs can be divided into the following items (EUR/m³):

- pumping of tailings: 0.15
- water recycle: 0.05
- pipe arrangements, wear: 0.22
- piers: 0.10

The dam safety monitoring system now underway will add another EUR 0.07/m³ and may be complemented with other systems as well.

[66, Base metals group, 2002]

The following table shows some further cost information relevant to the management of tailings and waste-rock.

Operation	Sub-operation	Cost	Units	Comment/Site
Dam costs	Dam construction	0.05 - 0.5	EUR/t	Scale. site & method dependent ¹
Lining	HDPE liner, 16 ha	7.5	EUR/m ²	Ovacik ²
Environmental monitoring	One water sample (surface or GW)	220	EUR/sample	Sampling, sample preparation, shipping, analysis and reporting ¹
Installation of monitoring well	Ground water monitoring well	200	EUR/m	Establishment, drilling, lining and rinsing ¹
Backfill	Transport cost, 15 km	0.3	EUR/t	¹
	Transport cost, 100 km	0.8	EUR/t	¹
Thickened tailings	Operating costs excluding capital costs	0.15	EUR/t	³
	Capital cost thickener, (14 m high)	170000	EUR	³
	Total capital cost	2.2	EUR million	³
	Of which for dam construction	1.4	EUR million	³
Sources:				
1 = [98, Eriksson, 2002]				
2 = [56, Au group, 2002]				
3 = [31, Ritcey,]				

Table 3.63: Cost of other operations relevant to the management of tailings and waste-rock

The following table gives more detailed information on costs for destroying cyanide using the SO₂/air method.

Site	Tonnes/day	Weight % solids	WAD-CN (mg/l)		Operating cost	
			Feed	Treated	USD/tonne	USD/kg WAD-CN
A	2800	35	80	0.30	0.35	2.56
B	920	47	175	0.90	0.77	4.28
C	800	45	120	0.50	0.91	6.06
D	2700	40	290	0.15	0.95	2.40

Table 3.64: Operating cost in USD for CN destruction using the SO₂/air method in 2001 [99, Devuyst, 2002]

The operating costs are actual and include the costs of SO₂, lime, copper sulphate and power. Capital costs for these operations are in the range of USD 360000 to 1.1 million installed. Capital costs include reactor, agitator, air compressor, SO₂ delivery system, and copper sulphate delivery system. It does not include the tailings pump box and pump and the lime system (usually already part of the plant). It assumes the system is outdoors, including reagent systems and air compressor. Therefore no additional building facilities need to be constructed, only site preparation and proper foundations. None of the examples in the table make use of a sulphur burner for the source of SO₂. If this was the case, the capital cost would be much higher (about 80 %), but the operating cost would be reduced by about 60 %. The variation in operating costs is due to unit reagent cost for SO₂, lime, copper sulphate and power.

[99, Devuyst, 2002]

3.1.8.2 Closure

The following table lists cost information related to closure cost.

Sub-operation	Cost interval	Units	Comment/Site
Dump or tailings pond revegetation	0.1 - 0.5	EUR/m ²	Scale dependent ¹
Engineered cover on dump or pond	3.0 - 10	EUR/m ³	Scale and method dependent ¹
Flooding of tailings pond	0.5 - 1	EUR/m ²	Scale and site dependent ¹
Wetland establishment	0.1 - 1	EUR/m ²	Scale and site dependent ¹
Groundwater saturation	0.2 - 2	EUR/m ²	Scale and site dependent ¹
Dewatering of pond	0.7 - 1.2	EUR/m ²	Tara ²
Revegetation	0.7 - 0.8	EUR/m ²	Tara ²
Monitoring	1.3 - 1.7	EUR/m ²	Tara ²
Maintenance	0.1	EUR/m ²	Tara ²
total reclamation and closure	3.1 - 3.7	EUR/m ²	Tara ²
Closure (dewatering and cover)	1.8	USD million	Ovacik ³
Closure (not specified), 37 ha	0.6	EUR million	Orivesi ⁴
Closure (water cover, vegetation), 280 ha	1.5	EUR million	Boliden ⁵
Closure and after-care, 100 ha	5.4	EUR million	Pyhäsalmi ⁶
Rehabilitation	14.4	EUR/m ²	Zinkgruvan ⁷
Apirsa actual costs			
Apirsa tailings pond reclamation	18.5	EUR/m ²	Total cost/total area ¹
clay cover placed	2.9	EUR/m ³	Material it self not included ¹
Protection cover placed	3.1	EUR/m ³	Material it self not included ¹
Resloping of dam	0.9	EUR/m ³	<100 m movement of material (bulldozer) ¹
Resloping of dam	4	EUR/m ³	>100m movement of material (loading transport and placement) ¹
Revegetation with grass	0.05	EUR/m ²	Conventional seeding ¹
Saxberget actual reclamation cost			
Composite cover unit cost (1995)	7	EUR/m ²	Total cost/total area ¹
Stekenjokk actual reclamation cost			
Water cover unit cost (1992)	1.5	EUR/m ²	Total cost/total area ¹
Kristineberg actual reclamation costs			
Unit cost water cover	1.5	EUR/m ²	Total cost/total area ¹
Unit cost composite dry cover	6	EUR/m ²	Total cost/total area ¹
Unit cost increased ground water level	4	EUR/m ²	Total cost/total area ¹
Sources:			
1 = [98, Eriksson, 2002]			
2 = [23, Tara, 1999]			
3 = [56, Au group, 2002]			
4 = [59, Himmi, 2002]			
5 = [50, Au group, 2002]			
6 = [62, Himmi, 2002]			
7 = [66, Base metals group, 2002]			

Table 3.65: Cost information for closure and after-care of metalliferous mining tailings and waste-rock management

Reclamation and closure costs estimated for the Tara tailings facility are calculated for a five year active monitoring phase, a five year passive monitoring phase and a ten year long-term monitoring phase. Re-vegetation costs were calculated for a surface area of 66.8 – 85.4 ha with a unit cost of approx. EUR 3200/ha including fertiliser and seed. The costs for monitoring are based on the assumption that one full time staff be employed for a five year so called active care period monitoring phase. Other cost factors included are reclamation performance, agronomic performance assessment (examination of grazing sheep), wildlife monitoring, surface water quality, groundwater quality, dust monitoring, geotechnical monitoring (piezometers and visual inspections).

The decommissioning cost for the Boliden tailings pond are estimated to be EUR 1.5 million. This includes the arrangements for securing a permanent water cover, stabilisation of shallow bottoms, reconstruction of discharge devices, re-vegetation costs, long-term monitoring and management of the water cover. At the last raise, the dams are built to their final long-term stable slope angle and required erosion protection is installed, costs that are not included in the decommissioning costs are given above [50, Au group, 2002].

At Pyhäsalmi deposits of EUR 3.6 million and at Hitura EUR 0.6 million have been reserved in the accounts for closure and after care. The total closure and after-care costs for Pyhäsalmi tailings area is estimated to EUR 5.4 million.

Río Narcea has posted a bond of approximately EUR 3 million which corresponds to the Spanish norm (PTS 2 million/ha).

3.2 Industrial minerals

The term "industrial minerals" covers a wide range of different materials. Their common denominator is that they are all used as functional fillers or as production aids by industry. They are generally reduced in size to a very fine powder before use. The main categories included in this family are talc, calcium carbonate (ground and precipitated), feldspar, kaolin, ball clays, perlite, bentonite, sepiolite, silica, borates, etc. The mineralogical and chemical characteristics, as well as the particle-size distribution of the final product, determine the possible end uses. Quality requirements are usually very precise. The end uses of these minerals are extremely diversified. The geological availability of industrial minerals depends on the categories considered: talc, for instance, is less common than silica sand. However, even for the categories which seem more common, the physico-chemical requirements can be so high and precise that only a limited number of ore bodies can be worked.
[48, Bennett, 2002]

3.2.1 Barytes

The following production sites within the EU-15 were reported to this work:

Site	Country
Barytine de Chaillac, Chaillac	France
Wolfach Dreislar Bad Lauterberg	Germany
Vera, Coto minero Berja	Spain
Foss Mine, Aberfeldy Closehouse Mine, Middleton-in-Teesdale	United Kingdom

Table 3.66: Barytes mines in Europe

3.2.1.1 Mineralogy and mining techniques

Barytes is the naturally-occurring mineral form of barium sulphate (BaSO_4).

Within the EU-15, 55 % of the Barytes is produced by underground mining [29, Barytes, 2002].

Barytes deposits worldwide occur in ore bodies as residual, vein-type and bedded formats. Extraction is by both surface and underground techniques dependent on the geology and economics of the region. Each deposit and the most suitable extraction and processing route are very site-specific. Overburden and waste-rock generally remain in-situ, or are sold as construction products or are used in general reclaim/restoration.

3.2.1.2 Mineral processing

There is no standard flow sheet for the industry due primarily to the wide range of products. Mineral processing varies from a simple crush-only aggregate-type operation through to heavy-medium processing, jigging, fine grinding and flotation. At some operations small quantities of finished product are subsequently and separately acid-washed for special sale applications [29, Barytes, 2002]. Optical separation is also used in at least one operation.

The prime requirement for oil-well applications and for several of the filler applications (e.g. sound deadening, nuclear shielding) is high density (4.3 kg/l) and often BaSO_4 content (80 - 90 %) is sufficient to meet this. These operations generally only require crushing the run-of-mine material to produce a finished product with no processing waste.

Several other operations only require simple gravity methods to enhance the quality for the finished product, generally jigging or heavy-media separation.

Mineral processing may be necessary:

- for more complex ore bodies
- where the barytes is associated with other minerals (e.g. fluor spar, iron ore)
- where the barytes is finely disseminated in the host-rock (flotation)
- for the chemical industry where grades greater than 97 % BaSO_4 are required.

The following flow sheet shows a site using gravity separation using jigs and flotation.

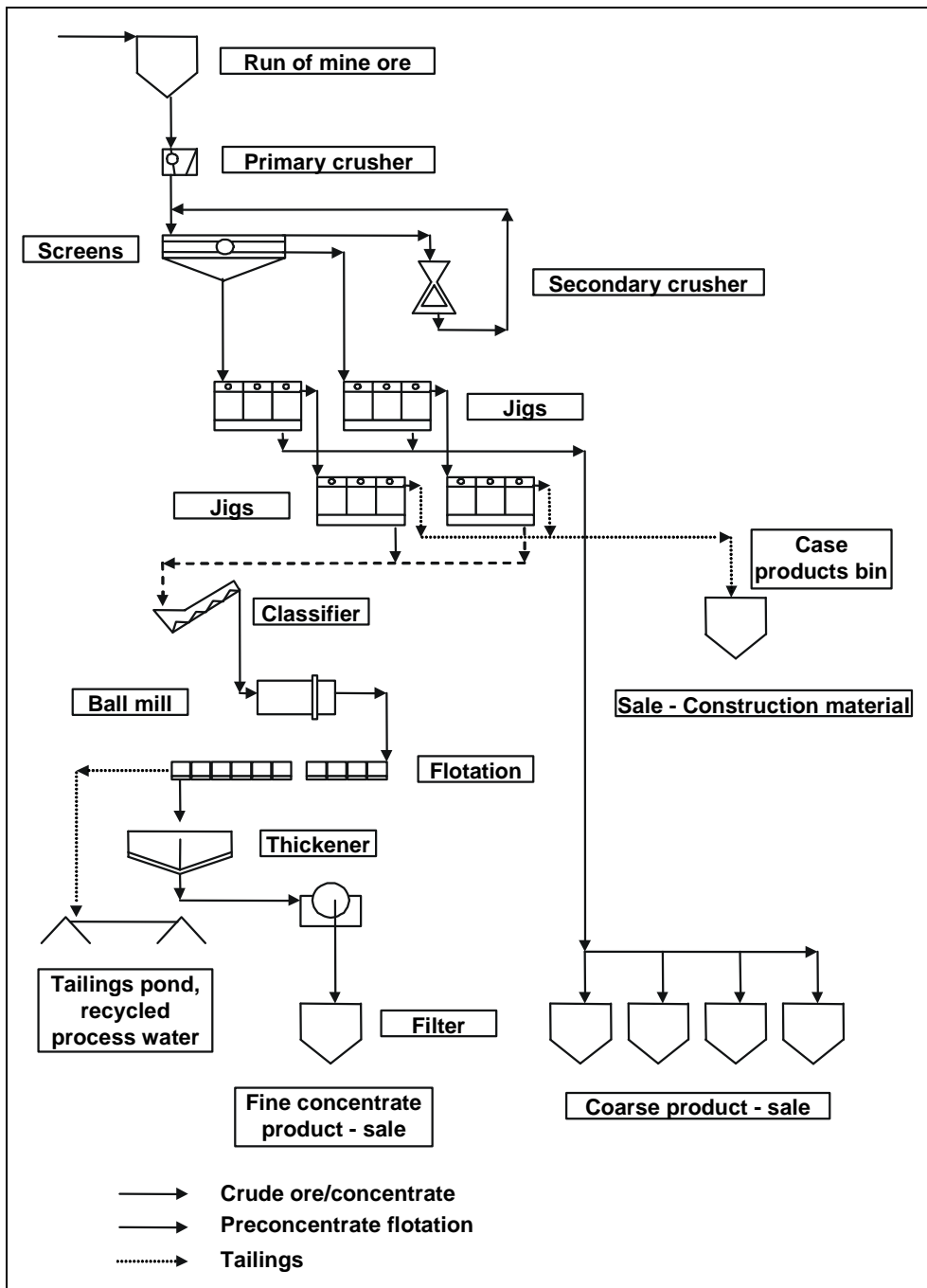

Figure 3.47: Flow sheet of barytes mineral processing plant using jigs and flotation

Sites with flotation operations use standard reagents for processing e.g. alkyl sulphates as collectors and all or some of sodium silicate, quebracho tannin (suppressant for talc and carbon) and citric acid as pulp modifiers [29, Barytes, 2002].

3.2.1.3 Tailings management

The following table shows the tailings management methods that are applied to different mineral processing schemes.

Type of mineral processing	No. of sites	% total output	Tailings management
Crushing Only	2	15	Nil
Crushing + Jigs only	4	23	Nil
Crush + Grind + Flotation	2	22	Dry tailings
Crush + Grind + Flotation	5	40	Wet tailings

Table 3.67: Tailings management methods applied to Barytes mines in Europe [29, Barytes, 2002]

It can be seen that five sites, which together produce 40 % of the Barytes, use wet tailings management. Two out of these five sites together discard only 12500 tonnes of tailings into small ponds and nearly half of this tonnage is regularly dredged out as a product for land use.

In general it can be said that only a small percentage (2 %) of the tailings produced within the EU-15 are discarded as slurry in ponds. Typically coarse tailings are sold as aggregates. Finer tailings are mostly dewatered and also sold or used as backfill in the mine.

The tailings management options are listed in more detail in the following table.

Size fraction		Amount (kt/yr)
Subtotal >250 - 300 μm (including sales)		77
	<250 - 300 μm dewatered, heap/sale	214
	<250 - 300 backfill	20
	<250 - 300 μm tailings pond, recycle	5.5
	<250 - 300 μm tailings pond	7
Subtotal <250 - 300 μm		255.5
Total		323.5

Table 3.68: Tailings management options at European barytes operations

The operation in **Coto minero Berja** with a total mine production of 150000 t/yr produces three types of tailings:

- coarse tailings (>25 mm): after crushing in a hammer mill and screening
- after density separation the light fraction passes a screw classifier. The coarse fraction of these tailings are backfilled after dewater in basins in the pit (see figure below)
- the slimes from the screw classifier (17000 t/yr dry basis) are dewatered via evaporation in small concrete tailings basins (total capacity of 240 m³). The dried slimes are then also backfilled in the open pit (see figure below).



Figure 3.48: Dewatering of barytes tailings in the pit
[110, IGME, 2002]



Figure 3.49: Dewatering of tailings in concrete basins
[110, IGME, 2002]

3.2.1.4 Waste-rock management

In general waste-rock remains in-situ, is sold as a construction product or used for site restoration.

At the operation in **Coto minero Berja** the waste-rock (325000 m³/yr) is transferred with trucks within the mine and backfilled on the mined out site of the open pit and progressively re-vegetated.

[110, IGME, 2002]

3.2.2 Borates

This section includes information about the Turkish borates sites, the only producer of borates in Europe.

3.2.2.1 Mineralogy and mining techniques

The oldest form of boron known is the mineral salt called tincal (sodium tetraborate decahydrate, or simply borax). Other boron-containing minerals that occur naturally and are mined commercially include colemanite (calcium borate), hydroboracite (calcium magnesium borate), kernite (another sodium borate), and ulexite (sodium calcium borate). [92, EBA, 2002]

3.2.2.2 Mineral processing

Boron minerals coming from open pit or underground mines are crushed into appropriate sizes and are then fed to the mineral processing plant.

The following figure shows a simplified flow sheet of the production of refined boron products.

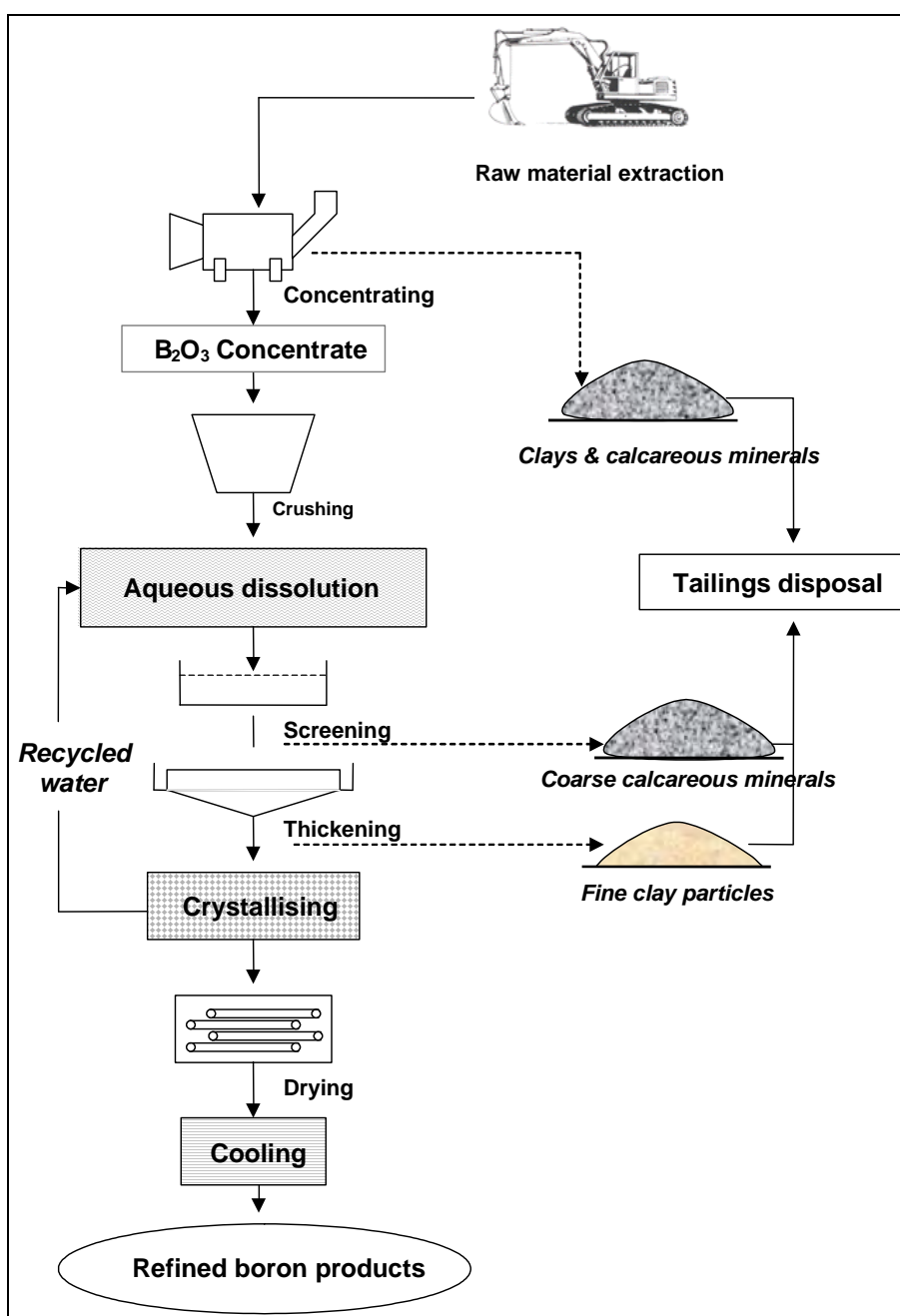

Figure 3.50: Simplified flow sheet of the production of refined boron products [92, EBA, 2002]

The following table lists the inputs and outputs from the main steps of the borate process:

Process step	Inputs	Outputs
1. Cassifying	Raw material	Clays and calcareous minerals (solid) B ₂ O ₃ concentrate
2. Aqueous dissolution	B ₂ O ₃ concentrate Hot water	Unrefined Borax saturated solution
3. Screening	Unrefined Borax saturated solution	Coarse calcareous minerals Borax solution and fine clays
4. Thickening	Borax solution + fine clays Flocculants	Fine clays particles and flocculants Borax solution
5. Crystallising	Borax solution	Boron refined products (wet)
6. Drying/ cooling	Boron refined products (wet)	Boron refined products (dry)

Table 3.69: Inputs and outputs from the main steps of the borate process
[92, EBA, 2002]

3.2.2.3 Tailings management

In short, the coarse tailings consist of clays and calcareous minerals which are stored on heaps for backfilling purposes. The tailings slurries, which contain fine clays particles and flocculants, are managed in ponds. After the settlement of the clays particles, the water is recycled into the process.

The following table provides a list of the tailings released from the process and the type of management applied to them.

Process step	Tailings generated	Management method
1. Classifying	Clays and calcareous minerals (solid)	Heap
2. Aqueous dissolution	Non	n/a
3. Screening	Coarse calcareous minerals	Tailings ponds
4. Thickening	Fine clays particles & flocculants	Tailings ponds
5. Crystallising	Non	n/a
6. Drying/cooling	Non	n/a

Table 3.70: List of the tailings released from the process and the type of management applied
[92, EBA, 2002]

The tailings from screening and thickening are discharged into lined ponds near the mines. The ponds have five levels, with the first one being at the lowest and the fifth one at the highest level. The tailings pulp from the plant is pumped directly to the second, third and fourth ponds. After the solid particles contained in the tailing pulp settle down in these ponds, the overflow water is transferred progressively into the first pond. The 'clean' water in the first lake is then pumped back in the processing plant. Discharging tailing pulps to the fifth pond has recently started and the water level is increasing at this pond.

The annual quantity of the solid waste is about 350000 - 400000 tonnes and the amount of water for pumping the tailings to the lakes is 300000 – 500000 m³/year. Total capacity of the current pond system is 14 million m³.

The following alternatives are under evaluation for the management of tailings in the future:

1. constructing a new pond
2. discharging the solid tailings from the third and fourth pond to the heap area, and re-using the ponds
3. using a decanter system to recover the tailings in a solid form, and discarding them on a heap.

[92, EBA, 2002]

There is a monitoring system for CO, SO₂, NO_x and dust emissions. Boron particles in neighbouring streams, chemical oxygen demand in neighbouring streams, pH and conductivity values of neighbouring streams are measured on a regular basis. The analysis shows that the B₂O₃ content in the water is negligible, and it was demonstrated that this B₂O₃ content was coming from the groundwater being in contact with the deposit.

3.2.3 Feldspar

Unless otherwise mentioned, all information provided in this section originates from [39, IMA, 2002]

3.2.3.1 Mineralogy and mining techniques

Feldspar is by far the most abundant group of minerals in the earth's crust, forming about 60 % of terrestrial rocks. Feldspar minerals are essential components in igneous, metamorphic and sedimentary rocks, to such an extent that the classification of a number of rocks is based on feldspar content. The crystalline structure of feldspar consists of an infinite network of SiO₂ octahedron and AlO₄ tetrahedron. They usually crystallise in the monoclinic or triclinic system.

The mineralogical composition of most feldspars can be expressed in terms of the ternary system orthoclase (KAlSi₃O₈), albite (NaAlSi₃O₈) and anorthite (CaAl₂Si₂O₈). The minerals, the composition of which is comprised between albite and anorthite are known as plagioclase feldspars, while those comprised between albite and orthoclase are called alkali feldspars. This latter category is of particular interest in terms of industrial use.

Feldspar is extracted from quarries by simple excavation (loading shovel). The mineral ore is crushed into the appropriate size and transported to the processing plant by conveyor belts or trucks.

3.2.3.2 Mineral processing

Feldspars are either selectively mined or processed by optical, flotation and/or electrostatic separation, in order to remove the accessory minerals (e.g. quartz, mica, rutile, etc.) present in the ore. The feldspar then undergoes a comminution step. The degree of refining and possible comminution is very dependent upon the final use of the product. For a number of uses, it is perfectly acceptable, and even advantageous, that the product retains some accessory minerals, e.g. quartz, while at the other extreme some applications require extremely pure and fine-grounded grades. Basically, the two properties which make feldspars useful for downstream industries are their alkali and alumina content.

The flotation process is only used by AKW, INCUSA, and SP Minerals. The feldspar recovered by flotation only represents about 10 % of the European feldspar production. The flotation process is essential to get a high quality grade (low iron content and high alumina content) required for some specific and important applications (e.g. TV/computer screens). For instance, although the Italian producer Maffei is the biggest producer in Europe, the three above-mentioned companies supply the Italian market with these high quality grade products.

The essential use of the flotation process may be explained by the following figure:

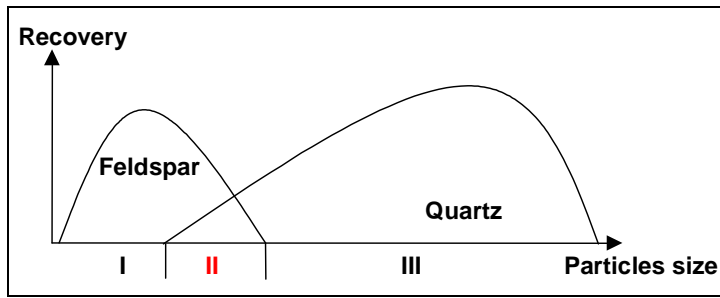

Figure 3.51: Feldspar particle vs. recovery graph
[39, IMA, 2002]

In Sections I and III a primary mechanical separation (hydrocycloning, centrifugation) can be achieved. In Section II, either optical, flotation or electrostatic separation can be used to separate feldspar from quartz, depending on both the intrinsic characteristics of the raw material, and the final product requirements.

The following flow sheet shows the steps involved in the recovery of feldspar.

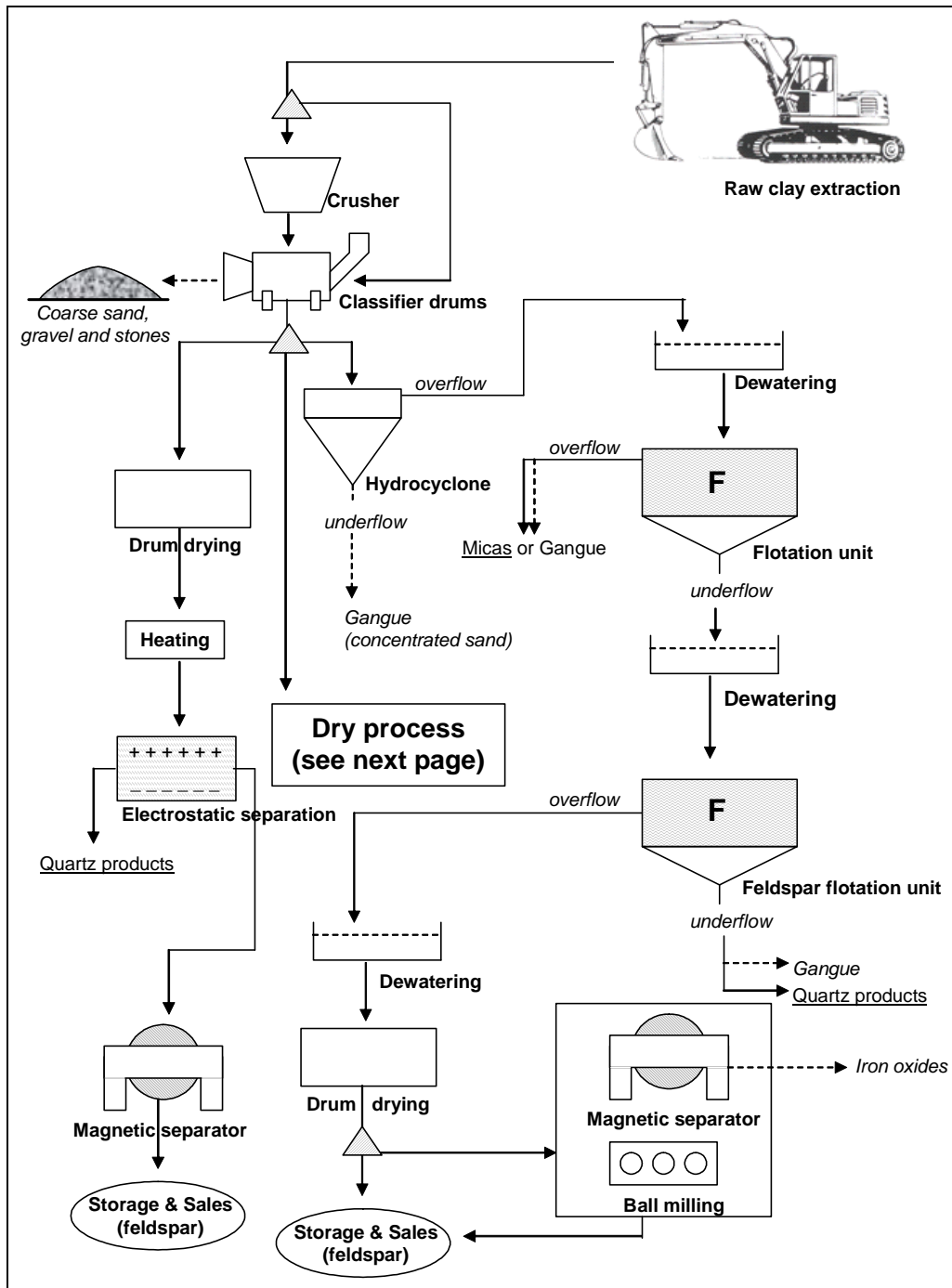

Figure 3.52: Flow sheet for Feldspar recovery using flotation [39, IMA, 2002]

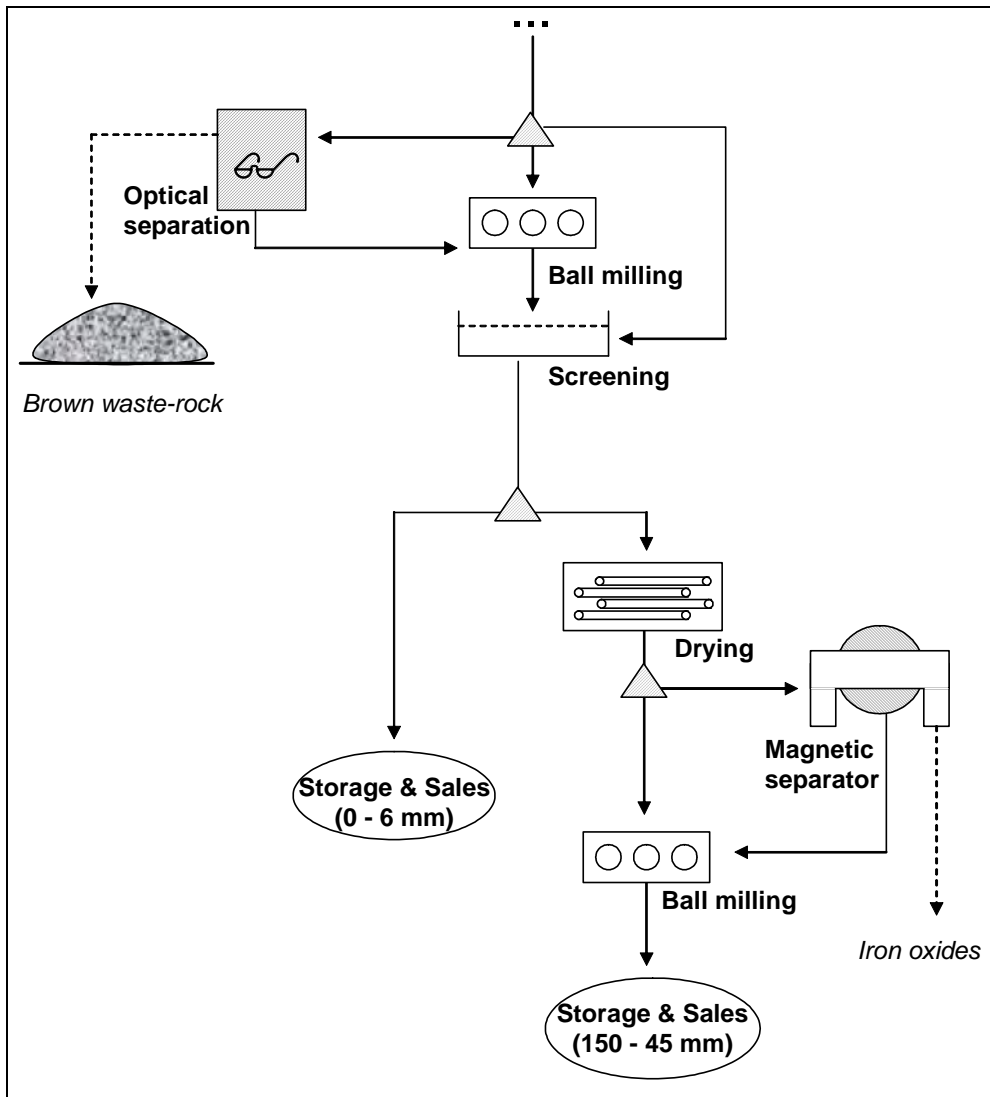

Figure 3.53: Dry processing step in the recovery of feldspar [39, IMA, 2002]

In the feldspar process, one may distinguish three different flotation steps, namely the micas flotation, the oxides flotation, and the feldspar flotation. **Each of these requires a different reagent regime.**

The following table shows the inputs and outputs from the main steps of the feldspar process.

Process step	Inputs	Outputs
1. Milling & classifying	<ul style="list-style-type: none"> ▪ raw material ▪ water 	<ul style="list-style-type: none"> ▪ slurry mixture (containing feldspar) ▪ coarse sand, gravel, and stones
2. Hydrocycloning	<ul style="list-style-type: none"> ▪ slurry mixture ▪ water 	<p><u>Overflow</u></p> <ul style="list-style-type: none"> ▪ feldspar, fine sand and micas <p><u>Underflow</u></p> <ul style="list-style-type: none"> ▪ gangue: concentrated sand ▪ process water
3. Dewatering by screens or vacuum filters	<ul style="list-style-type: none"> ▪ feldspar, fine sand and micas 	<ul style="list-style-type: none"> ▪ feldspar, fine sand and micas ▪ process water
4. Micas or oxides flotation	<ul style="list-style-type: none"> ▪ feldspar, fine sand and micas ▪ foam inhibitor ▪ acids (H₂SO₄) ▪ surfactants 	<p><u>Overflow</u></p> <ul style="list-style-type: none"> ▪ micas or oxides <p><u>Underflow</u></p> <ul style="list-style-type: none"> ▪ feldspar, fine sand, quartz ▪ process water
5. Dewatering by screens or vacuum filters	<ul style="list-style-type: none"> ▪ output from the underflow of the previous step 	<ul style="list-style-type: none"> ▪ feldspar, fine sand, quartz ▪ process water
6. Feldspar flotation	<ul style="list-style-type: none"> ▪ feldspar, fine sand, quartz ▪ foam inhibitor ▪ acids (HF) ▪ surfactants 	<p><u>Overflow (reverse flotation possible)</u></p> <ul style="list-style-type: none"> ▪ feldspar <p><u>Underflow</u></p> <ul style="list-style-type: none"> ▪ fine sand and quartz ▪ process water
7. Dewatering by filters	<ul style="list-style-type: none"> ▪ output from the overflow of the previous step ▪ feldspar (moisture <25 %) 	<ul style="list-style-type: none"> ▪ feldspar (moisture <25 %) ▪ process water
8. Drying	<ul style="list-style-type: none"> ▪ feldspar (moisture <25 %) 	<ul style="list-style-type: none"> ▪ feldspar (moisture <1 %)
9. Magnetic separation	<ul style="list-style-type: none"> ▪ feldspar (moisture <1 %) 	<ul style="list-style-type: none"> ▪ feldspar (moisture <1 %) ▪ iron oxides

Table 3.71: Inputs and outputs from feldspar mineral processing steps
[39, IMA, 2002]

At the operations in the **Segovia region** and in **Finland**, the process used for the separation of the feldspathic sands from the silica sands is that of flotation in a highly acid environment for which hydrofluoric acid is used. The flotation plants are fed with the fraction smaller than one millimetre. The mineral processing plants have a capacity of 2400 t/d.
[110, IGME, 2002]

3.2.3.3 Tailings management

3.2.3.3.1 Characteristics of tailings

An example chemical analysis of a tailings eluate is presented below:

Parameter	Units	Result
pH- eluate after 2 hours	-	7.76
pH- eluate after 8 hours	-	9.06
pH- eluate after 24 hours	-	9.14
pH- eluate after 48 hours	-	9.20
pH- eluate after 72 hours	-	9.04
pH- eluate after 102 hours	-	9.03
pH- eluate after 168 hours	-	8.5
pH- eluate after 384 hours	-	8.0
Cyanide	µg/l	<10
Chloride	mg/l	<10
Fluoride	mg/l	<0.5
Nitrate	mg/l	23
Sulphate	mg/l	101
Arsenic	µg/l	<5
Barium	mg/l	<0.1
Cadmium	µg/l	4
Cobalt	µg/l	<100
Chromium	µg/l	14
Beryllium	µg/l	<1
Mercury	µg/l	<0.1
Nickel	µg/l	2
Lead	µg/l	19
Copper	µg/l	16
Selenium	µg/l	<1
Vanadium	µg/l	<100
Zinc	mg/l	2.4
COD	mg/l of O ₂	27

Table 3.72: Example of a chemical analysis of feldspar tailings eluate

The following table shows the characteristics of the materials released from the process.

Process step	Material released from the process	Destination
Comminution and classifying	▪ coarse sand, gravel, and stones	▪ by-product or tailings heap
Hydrocycloning	▪ concentrated sand ▪ process water	▪ by-product or tailings pond
Dewatering by screens or vacuum filters	▪ clear water overflow is directly recycled or used to hold reserves of water.	
Micas flotation	▪ micas ▪ process water	▪ by-product or tailings pond
Oxides flotation	▪ oxides ▪ process water	▪ tailings pond
Dewatering by screening or with vacuum filters	▪ clear water overflow is directly recycled or used to hold reserves of water.	
Feldspar flotation	▪ fine sand, quartz, and micas ▪ process water	▪ by-product or tailings pond
Dewatering in filters	▪ clear water overflow is directly recycled or used to hold reserves of water ▪ process water, tailings pond	
Drying	▪ non	▪ n/a
Magnetic separation	▪ iron oxides	▪ by-product or tailings heap

Table 3.73: Products and tailings from the mineral processing of feldspar [39, IMA, 2002]

Besides the tailings heaps consisting of coarse sand, gravel and stones, there are tailings ponds which contain:

Solid materials:

- fine sand and micas (50 - 70%)
- some iron oxides (less than 10 %)
- flocculants (in the ppm range)
- fluoride strongly adsorbed or bounded onto the solids.

Liquid (process water)

- water at a pH value of about 4.5
- foam inhibitor (traces)
- fluoride (100 – 1000 ppm).

3.2.3.3.2 Applied management methods

At most sites the tailings are stored in dug out settling basins within the pit, and thus they do not have dams. The bottoms of the ponds are lined with clay layers.

At one of the operations in Segovia, 110000 t/yr of tailings are generated (mine production 600000t/yr). These consist of a sandy fraction (80000 t/yr) and the tailings after flotation. The sandy fraction consists of coarse sands that do not have a market. They are backfilled in the open pit. The flotation tailings are filtered. The filter cake (28000 t/yr) is also backfilled, whereas the remaining slurry is sent to small ponds. The backfilling area in the open pit had been prepared by placing a drainage system to control and sample the drainage water prior to discharging to the river.

The flotation concentrate is led to a treatment facility that generates 200 t/yr of calcium fluoride sludge from neutralisation of the HF-acid using lime. After filtration in a filter press the sludge is backfilled together with the tailings. The flotation tailings stream is not neutralised directly. Instead the tailings pond has four control wells in its periphery from which the seepage water is pumped to the water treatment plant.

[110, IGME, 2002]

Tailings heaps have a natural slope of 30 to 45°.

3.2.3.3.3 Safety of the TMF and accident prevention

The TMFs are controlled visually and by topographical surveys.

3.2.3.4 Current emissions and consumption levels

3.2.3.4.1 Management of water and reagents

1. Micas flotation:

Chemicals used in the process:

Chemicals	pH/concentration
Acid (H ₂ SO ₄)	To adjust to a pH value of about 3
Surfactant	10 - 100 ppm
Foam inhibitors	10 - 100 ppm

2. Oxides flotation:

Chemicals used in the process:

Chemicals	pH/concentration
Acid (H ₂ SO ₄)	To adjust to a pH value of about 3
Surfactant	10 - 500 ppm
Foam inhibitors	10 - 100 ppm

3. Feldspar flotation:

Chemicals used in the process:

Chemicals	pH/concentration
Acid (HF)	pH <3
Surfactant	10 - 500 ppm
Foam inhibitors	10 - 100 ppm
Alkaline solution (CaO, Ca(OH) ₂ , NaOH)	To adjust to a pH value of about 4.5

Water is neutralised with CaO, Ca(OH)₂, Na(OH) to pH values of about 7; using calcium ions there is the advantage that the fluoride is bounded and a larger part of it disappears from the balance because the CaF₂ is almost insoluble. After this treatment, the water is added to the waste water-stream.

3.2.3.4.2 Energy consumption

The average energy consumption for the feldspar mineral process is approximately 300 MJ/tonne. However, large discrepancies have been observed from site to site (min: 10 – max: 1800).

3.2.4 Fluorspar**3.2.4.1 Mineralogy and mining techniques**

The chemical element F is not rare in the earth's crust (at 0.07 % it is the 13th most abundant element by weight), but naturally occurring concentrations are scarce. The elements fluorine (F) and calcium (Ca) are strongly bound in CaF₂ and this molecule is very stable.

[43, Sogerem, 2002]

The mineralogy of the Sardinian fluorspar/lead sulphide operation can be described as follows:

- fluorspar, with a grade of 26 – 38 %
- lead sulphide, with a grade of 1.5 – 8 %
- barium sulphate
- zinc sulphide
- iron sulphide, as pyrites and marcasite
- calcium carbonate, as calcite
- quartz
- silicates.

Of the above, only the first two are of economic interest; as the liberation size of 6 mm makes the comminution and separation relatively simple, to pre concentrate the mineral in a static dense medium separation process [44, Italy, 2002].

Mining is carried out both underground and open pit.

In one operation the underground mining method is applied in a vein, cut and fill mining [44, Italy, 2002].

Fluorite mining in Asturias is carried out in three mines using the room and pillar technique. The deposit is of the hydrothermal type, where CaCO_3 has been replaced by CaF_2 . About 60000 m^3 of waste-rock are generated in the mining operation each year. This waste-rock is backfilled directly in mined out chambers of the mine [110, IGME, 2002].

3.2.4.2 Mineral processing

3.2.4.2.1 Gravity concentration

At the fluorite mine in the Southern Pyrenees, after crushing to <30 mm, the different components of the ore are separated dense medium separation. This process is capable of upgrading the ore from 30 – 60 % CaF_2 to around 90 % CaF_2 .

The gravity concentration, a continuous process, is done in a water environment at ambient temperature in closed circuit (hydrocyclones or drums) with automated regulation. The water is re-circulated in a closed circuit. The washed material is sorted by size (2 mm, 5 mm, 25 mm) and stored outside on concrete surface.

All tailings are subsequently processed in the flotation plant described below to increase recovery. The finished product can be sold in wet form and the delivery to the customers is done in covered dump trucks. If it is delivered dried, transportation is done in covered dump-trucks or in silo-trucks.

[43, Sogerem, 2002]

3.2.4.2.2 Flotation

At the fluorite mine in the Southern Pyrenees, after crushing and grinding, the ore with a fluorite content around 40 % is reduced in size to particles under 1 mm and is then dispersed in water. The fluorite grains are rendered hydrophobic by the surface action of natural fatty acids (oleic acid for example). The ‘fatty’ particles attach to the injected air bubbles to form a froth that is then mechanically skimmed off at the surface of the cells. This froth, containing mainly calcium fluoride, i.e. 97 – 98 % of CaF_2 (dry basis), is washed several times with water. Filtration of the slurry gives a filter-cake with around 10 % moisture.

[43, Sogerem, 2002]

In Asturias, the ore from three mines, 400000 t/yr, is processed in one plant. The distance from the mines to the mineral processing plant is between 18 and 100 km. The plant includes primary and secondary grinding, fine milling and hot flotation.

[110, IGME, 2002]

3.2.4.2.3 The fluorite/lead sulphide process

The Sardinian Silius Mine mine produces fluorite and a lead sulphide concentrate. The average rate of production per year is 45000 tonnes of 97 % CaF_2 and 5000 tonnes of 67 % PbS. Silius Mine is the only operating mine in Europe for Fluorite and Lead Sulphide. The fluorite product is sold to a chemical plant and the lead sulphide is sold to a smelter located in South West Sardinia

The ore is pre-concentrated at the mine site using gravity concentration. The pre-concentrate with a fluor spar grade of 43 – 50 % is transported via trucks to the mineral processing plant 57 km away from the mine, the reason for this being the availability of large amounts of water, not available at the mine.

The mineral is ground in ball mills to 100 % passing 0.5 mm. The first mineral recovered is the lead sulphide in a 3-stage flotation unit. The reject of this stage is then processed in a 4-stage fluor spar flotation unit. The commercial products are filtered in drum filters.

[44, Italy, 2002]

3.2.4.3 Tailings management

3.2.4.3.1 Applied management methods

In one operation in the Southern Pyrenees, the tailings, containing 1 to 5 % CaF_2 , are backfilled into the mine after dewatering with filter-presses, located inside the plant itself. The water is entirely recycled. The coarseness of the tailings is close to the one of the finished concentrated fluor spar, with a particle size less than 350 μm .

The constituents are silica and shale (80 - 90 % SiO_2), and on a smaller scale iron derivatives (5 - 10 % Fe_2O_3 : shales, iron hydroxides, iron carbonate), other oxides (1 – 2 % Al_2O_3), iron/copper sulphides, and of course some residual CaF_2 (usually 1 – 5 %).

[43, Sogerem, 2002]

In another case, that being the operation in Sardinia, the tailings are cycloned in a dense medium to separate the sands from the muds. The sands are settled in 'sand ponds'. The muds are pumped into 'settlement ponds'.

The process water is cleaned in three ponds. The clean water from the third pond is partially recycled and partially discarded into the river. The total volume of the tailings ponds is about 1300000 m^3 .

The dried sands are stocked in heaps and are sold for civil construction works; the muds are under evaluation for new uses such as for tiles, cement.

Further developments aim to eliminate the settlement pond by introducing filter press sections.

The tailings facilities are located near the plant very close to the river. The ground where the facilities are located is an alternation of sands and clay layers, with the result that no seepage into the ground occurs.

A conventional dam with a clay nucleus of the classical trapezoid shape contains the tailings. The dam slope is 1:1.5. The dams are raised every three to four years.

A characterisation of the site is in progress to evaluate the chemical situation, the leaching behaviour, and so on. Alternative solutions to the present management will be decided after the results of the study. An important factor to be considered in these conditions are related to the heavy metal contents and the systems to avoid that those metals can migrate into water and surrounding properties.

[44, Italy, 2002]

The tailings at the operation in Asturias are discarded into the sea after removing the coarse, sellable fraction in hydrocyclones [110, IGME, 2002].

3.2.4.3.2 Safety of the TMF and accident prevention

At the fluorspar/lead sulphide operation, the dam slopes and decant system are checked visually on a daily basis. The water coming from the ponds overflow is chemically checked weekly before discharge into the river. The phreatic surface is controlled by means of piezometers. For safety reasons the dam height is limited to 7 - 10 m.

There are no specific emergency plans because the risk of a heavy accident is considered 'basically zero'. [44, Italy, 2002]

3.2.4.3.3 Closure and after-care

The closure and after-care plan for the fluorspar/lead sulphide operation is currently in progress. The costs of closure are expected to be in the order of several million EUR. Monitoring of the site after the end of the operational life must be carried out for several years (currently about 10 years are foreseen) in order to establish if any migration of heavy metal occurs. There are no arrangements for financial assurance to cover the long-term risk of pollution, but a special fund has been established by the company in the annual balance to finance the closure operations [44, Italy, 2002].

3.2.4.4 Waste-rock management

One operation backfills all waste-rock along with the tailings in the underground operation. The waste-rock comes from the excavation of galleries in rock mass outside of the orebody. The waste-rock is used as backfill, so that the surface heaps are reduced to a minimum and are only used as a temporary deposit [44, Italy, 2002].

3.2.4.5 Current emissions and consumption levels

3.2.4.5.1 Management of water and reagents

In one case, the clean water from the last clarification pond is partially recycled and partially discarded into the river. The total volume of the tailings ponds is about 1300000 m³ [44, Italy, 2002].

The water is cleaned before the discharge. The reagents used in mineral processing are of vegetal origin (e.g. oleins from olive or pine oil); potentially dangerous reagents are chemically treated before discharge. The water consumption is on average 8000 m³ per day. [44, Italy, 2002]

At the operation in Asturias the following reagents are used:

- oleic acid, as a collector and frother, 400 g/t
- quebracho tannin, as a depressant for calcite
- sodium carbonate, as a pH adjuster.

[110, IGME, 2002]

3.2.4.5.2 Soil contamination

At the fluorspar/lead sulphide operation, due to the nature of the material processed, heavy metals contamination could occur. The metals contained are lead, zinc, iron and fluor. However, the concentrations are low and emissions are monitored.

3.2.5 Kaolin

3.2.5.1 Mineralogy and mining techniques

Clay minerals are divided into four major groups. One of these is the kaolinite group. This group has three members (kaolinite, dickite and nacrite) and a formula of $\text{Al}_2\text{Si}_2\text{O}_5(\text{OH})_4$. The different minerals are polymorphs, meaning that they have the same chemistry but different structures. The general structure of the kaolinite group is composed of silicate sheets (Si_2O_5) bonded to aluminum oxide/hydroxide layers ($\text{Al}_2(\text{OH})_4$) called gibbsite layers. The silicate and gibbsite layers are tightly bonded together with only weak bonding existing between the layers [37, Mineralgallery, 2002].

Kaolinite can be formed as a residual weathering product, by hydrothermal alteration, and as a sedimentary mineral. The residual and hydrothermal occurrences are classed as primary occurrences and the sedimentary occurrences as secondary.

Primary kaolins are those that have formed in-situ, usually by the alteration of crystalline rocks such as granite or gneiss. The alteration results from surface weathering, groundwater movement below the surface, or due to the action of hydrothermal fluids. Secondary kaolins are sedimentary minerals which have been eroded, transported and deposited as beds or lenses associated with other sedimentary rocks. Most of the secondary deposits were formed by the deposition of kaolinite which had been constituted elsewhere. One type of kaolin deposits which can be considered as either primary or secondary, depending on the point of view, are arkosic sediments which were altered after deposition, primarily by groundwater.

Kaolin is extracted from quarries either by hydraulic means or by simple excavation (e.g. by use of a loading shovel).

3.2.5.2 Mineral processing

The processing of kaolin varies greatly from company to company; with each kaolin producer using different equipment and methods. Even when companies use identical methods, they may use them at different stages of the processing.

Kaolin ore, generally composed of kaolinite, quartz, micas, feldspar residues, etc., is commonly wet processed to eliminate the unwanted minerals. The various steps in the processing are:

- placing the 'ore' in suspension with water
- recovery of the kaolin fraction through sieving and cycloning
- concentration of the suspension through decantation in basins followed by passing it through filter-presses.

The kaolin properties (brightness, rheology, purity, grain size distribution) can be improved during the treatment, by using magnetic separation, bleaching or centrifugation.

Comminution is usually not necessary. Sometimes during wintertime, crushers (e.g. jaw crushers, cone crushers, roll crushers, hydrocone, etc.) are used to break frozen raw material.

Coarse clay may be used as a low grade filler or a ceramic clay. Alternatively, it can be upgraded by further processing. The flotation process is used to refine coarse clay and to maximise the recovery of kaolin. It can increase the kaolin recovery yield by up to 15 %, which is a significant improvement in the management of this natural resource. Not all producers use flotation. This depends on the product requirements and the characteristics of the deposit.

The following figure shows a typical kaolin process flow sheet

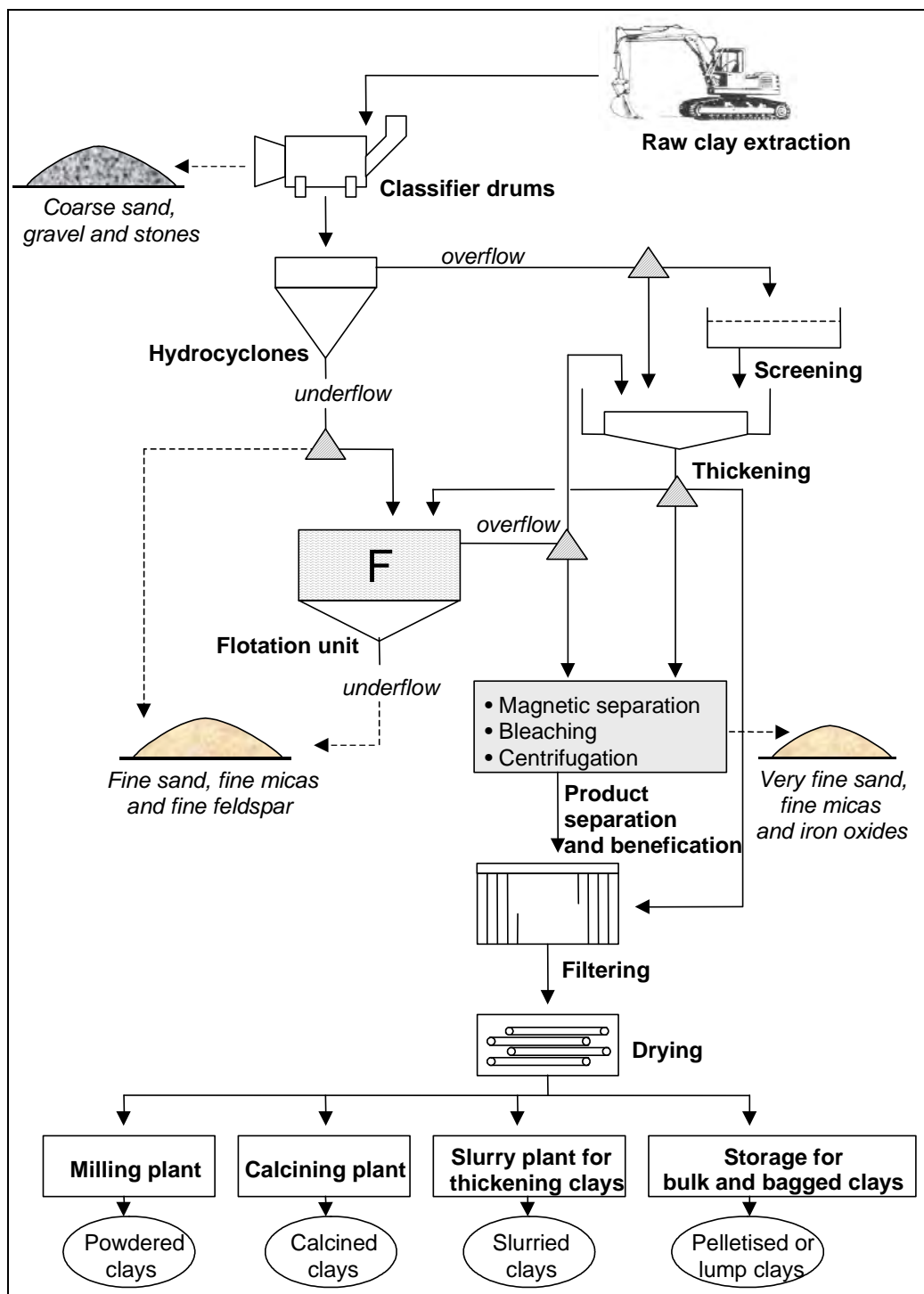

Figure 3.54: Typical kaolin process flow sheet
[40, IMA, 2002]

The essential use of the flotation process can be explained by the following figure:

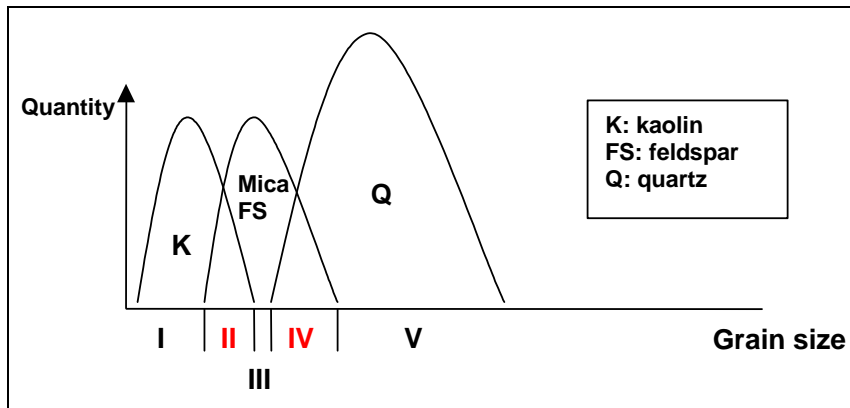

Figure 3.55: Kaolin grain size vs. quantity graph
[40, IMA, 2002]

In Sections I, III, and V, a primary mechanical separation (cycloning, centrifugation) can be achieved.

In Sections II and IV the grain size of different minerals is equal. If there is only a minor difference in specific weight, mechanical separation is not possible. Other differences will then have to be used. At smaller grain sizes (Section II) the only possible separation method is flotation. At larger grain sizes, Section IV, other methods, such as electrostatic separation of feldspar, is possible.

The following table shows the inputs and outputs from the main steps of kaolin processing.

Process step	Inputs	Outputs
Classifying	Raw material Water	Coarse sand, gravel and stones Slurry mixture (containing kaolin)
Hydrocycloning	Slurry mixture Water	<u>Overflow</u> Kaolin + fine sand, micas, (and feldspar) <u>Underflow</u> Kaolin + fine sand, micas, (and feldspar) Process water
Flotation	Underflow from the hydrocycloning step, or kaolin concentrate Acid (H ₂ SO ₄ , H ₃ PO ₄) Surfactants Anti-foam chemicals Alkaline solution (NaOH)	<u>Overflow</u> Kaolin mixture (after acid neutralisation) <u>Underflow</u> Very fine sand, micas, (and feldspar) Process water
Thickening	Overflow from the hydrocycloning step or flotation Flocculent	Kaolin concentrate (15 – 30 % solid content)
Product separation	Kaolin concentrate, or kaolin mixture <u>Magnetic separation</u> <u>Bleaching</u> Sodium hydrosulphite Ozone gas <u>Centrifugation</u>	Kaolin Iron oxides (very small amount) Very fine sand and micas
Filtering	Kaolin, kaolin concentrate	Kaolin (moisture <18 %) Process water
Drying	Kaolin (moisture <18 %)	Kaolin products

Table 3.74: Inputs and outputs in the processing of Kaolin
[40, IMA, 2002]

3.2.5.3 Tailings management

3.2.5.3.1 Characteristics of tailings

Characterisation of the materials released from the process

Process step	Material released from the process	Destination
Classifying	<ul style="list-style-type: none"> ▪ coarse sand, gravel and stones 	<ul style="list-style-type: none"> ▪ heap or saleable products (if local market available)
Hydrocycloning	<ul style="list-style-type: none"> ▪ fine sand, micas, (and feldspar) ▪ process water 	<ul style="list-style-type: none"> ▪ if it contains feldspar, it is further refined in the feldspar process ▪ mica is a commercial product ▪ fine sand: heap or saleable products (if local market available) ▪ tailings pond
Flotation	<ul style="list-style-type: none"> ▪ very fine sand, micas, (and feldspar) ▪ process water 	<ul style="list-style-type: none"> ▪ tailings pond ▪ if it contains feldspar, it is further refined in the feldspar process
Thickening	Clear water overflow is directly recycled or used to hold reserves of water.	
Product separation	<ul style="list-style-type: none"> ▪ very fine sand and micas ▪ iron oxides 	<ul style="list-style-type: none"> ▪ tailings pond or ▪ heap (compared to the other outputs, the amount is here negligible - several orders of magnitude less)
Filtering	<ul style="list-style-type: none"> ▪ process water 	<ul style="list-style-type: none"> ▪ tailings pond ▪ the filtrate ("process water") can also be recycled (depends on applied flocculants)
Drying		

Table 3.75: Tailings and products from Kaolin mineral processing
[40, IMA, 2002]

Beside the heap of coarse sand, gravel and stones, there are tailing lagoons which contain:

Solid materials:

- fine sand and micas (more than 95 %)
- some iron oxides (less than 1 %)
- flocculants (in the ppm range).

Liquid (process water)

- water at a pH value of about 4.5
- some phosphates
- some sulphates
- foam inhibitor.

3.2.5.3.2 Applied management methods

Beside the heaps of coarse sand, gravel and stones, there are also tailings ponds for the fine tailings. These are a mixture of fine clay particles (95 % of the solid content) associated with some surfactants and foam inhibitors (in the ppm range) in an acidic solution (pH of about 4.5). Usually, tailing ponds are used to clean the water before recycling or discharging to the river. The ponds are lined with impermeable clay layers.

In the **Nuria** operation, the tailings are the ultrafines after classification (2 % of total feed). Flotation is not applied. These fines are dewatered in several concrete settling basins in series (each with a size of about 300 m²). The basins are dewatered with syphons. In the summertime the dewatered fines are transferred to the waste-rock heap [110, IGME, 2002].

The **Kernick** mica dam is a micaceous tailings facility for the china clay (kaolin) industry in Cornwall, UK. It has been in use for 30 years and is one of the largest tailings dams in Europe. It occupies an area in excess of 55 ha and is 92 m high (above lowest ground level). The dam contains approximately 14 million tonnes of bulk fill which impounds approximately 28 tonnes of micaceous tailings. The structure consists of an embankment constructed around the perimeter of a worked-out china clay pit (quarry) which had been previously backfilled with micaceous tailings. The purpose of the embankment is to impound the tailings above the rim of the quarry.

The china clay industry generates three main types of residues from the deposit matrix:

- waste-rock, known locally as ‘stent’ which is a mixture of unkaolinised granite and other hard mineral lodes removed by drilling and blasting
- sand tailings, a coarse grained silica sand removed by mechanical separation
- mica tailings, a residue of mica and very fine sand removed by flotation.

The sand tailings and the waste-rock have been used to construct the dam in specific zones separated by transition layers. The waste-rock, evenly graded between 50 mm and 750 mm in size, forms a central core for the capture and drainage of seepage through the structure. The sand tailings, containing no material larger than 150 mm but typically less than 25 mm grain size, forms both the downstream and upstream parts of the main dam. The transition layer, consisting of clean, crushed rock typically between 75 mm and 125 mm, forms a filter layer between the sand tailings and the waste-rock core.

The embankment structure sits on a prepared ground surface which was stripped of all vegetation, topsoil, weathered profile and soft material. The excavation was proof-rolled by vibrating rollers and backfilled with clean sand in order to establish an even working foundation. A 1 m thick drainage blanket of clean stone was laid beneath the entire length and breadth of the rock core and downstream embankment. This blanket incorporates a longitudinal cut-off trench at the base of the rock core in which are situated a number of reinforced concrete (inlet) manifolds. The manifold in return are connected to reinforced concrete conduits used to transmit seepage water beyond the toe of the structure into collector chambers prior to final discharge to the adjacent watercourse.

During construction, the embankment site was protected (separated) from the quarry backfilling operation by a coffer dam built of randomly placed waste materials.

The downstream and upstream sand tailings embankments have been raised in horizontally placed layers approximately 0.5 m thick and compacted by vibrating rollers. The waste-rock core was ‘free-tipped’ by dump trucks to achieve an even distribution, and has not been compacted (other than by the weight and passage of bulldozers used to level the surface). The transition layer was placed by mechanical shovel to achieve a maximum thickness of 3 m.

The outer face of the embankment has a designed profile of 35°/32° (1:1.5/1:1.7 (V:H)) to which has been added a thin veneer of topsoil as a growing medium for subsequent vegetation. A hydroseeding technique is used to spray the surface with a mixture of grass, legumes, fertiliser, lime and organic binders, which together progressively establish a dense growth of gorse/lupin scrub, typical of unfarmed areas in the south-west of England.

Deposition of the tailings is carried out by using pipelines and spigots around the entire crest of the dam. The hydraulic separation leaves the coarser mica closer to the inside face of the dam with finer particles gradually settling out towards the back-end of the pond, where the free water is decanted by a pump barge.

Decanted water is either:

- re-circulated back into the process operation, or
- released to the watercourse (together with sub-pond drainage).

The performance of the structure (stability) is monitored by survey monuments to observe any horizontal/vertical movement, by piezometers to measure phreatic seepage patterns within and below the embankment, and by weirs to measure gross ground water flow through the final discharge flume.

Additional storage capacity is currently being achieved by surcharging the pond with bunds of compacted sand, placed directly on the 'dry' beach - this also creates a landscaped profile to the final surface of the lagoon which will eventually be dewatered and vegetated.

[125, Grigg, 2003]

3.2.5.3.3 Safety of the TMF and accident prevention

The TMFs are controlled visually and by topographical surveys.

3.2.5.4 Waste-rock management

The Nuria operation operates a waste-rock heap of 2.8 Mm³. The foundation of this heap was first stripped of the topsoil before a drainage system (consisting of perforated pipes covered with gravel and a geotextile) was installed. The surface run-off, containing a large amount of fines, is gathered and collected in a series of sedimentation ponds. The bench height is 15 m with 10 m wide berms [110, IGME, 2002].

3.2.5.5 Current emissions and consumption levels

3.2.5.5.1 Management of water and reagents

The reagents used in the flotation of kaolin are listed in the following table.

Reagent	Average concentration
Acid (H ₂ SO ₄ , H ₃ PO ₄)	To reach a pH value of about 2.5
Surfactant	10 - 100 ppm
Foam inhibitors	10 - 100 ppm
Alkaline solution	To neutralise to a pH value of about 4.5

Table 3.76: Reagents used in the flotation of kaolin
[40, IMA, 2002]

3.2.5.5.2 Energy consumption

The average energy consumption for the kaolin mineral process is about 2000 MJ/tonne. The average diesel consumption of a truck is 25 l/h.

3.2.6 Limestone

3.2.6.1 Mineralogy and mining techniques

From a mineralogical point of view, calcium carbonate falls into three structurally different groups: the calcite and the aragonite groups (both CaCO_3), and the dolomite group ($\text{CaMg}(\text{CO}_3)_2$). Calcite (CaCO_3) crystallises in the hexagonal system, but its crystals are extremely varied in habits, and often highly complex. The rhombohedron and the scalenohedron are the most frequent forms. Calcite is one of the most common and widespread minerals on earth, particularly in sedimentary rocks. Aragonite (CaCO_3) is formed in a narrow range of physico-chemical conditions. It crystallises in the orthorhombic system, typically in thermal springs. However, aragonite is also formed through biomineralisation processes; mollusc shells, pearls, and the human skeleton is made of aragonite. Dolomite is a double carbonate of calcium and magnesium, with the formula $\text{CaMg}(\text{CO}_3)_2$. Like calcite, it crystallises in the hexagonal system. It forms by the secondary transformation of calcite sediments in limestone, under the influence of circulating water, through partial substitution of Ca by Mg. These minerals constitute rocks, of which chalk, limestone, marble, and travertine are the most important ones. Chalk is a poorly compacted sedimentary rock, whose diagenesis is incomplete, and which is almost exclusively made up of calcium carbonate (calcite). The sediments from which chalk originates predominantly include compacted coccolithophoridae skeletons (calcareous algae) with limited cement, if any. This rock shows a very fine grain size, and is porous. Limestone is generally used as a generic term which designates a compacted sedimentary rock made of calcium carbonate. It is often used as a synonym for natural calcium carbonate. Marble is a metamorphic rock, which is the result of a re-crystallisation process of limestone, under conditions of high pressure and temperature. True marble has a low porosity and may host calcite crystals of several centimetres. Travertine, which is also called "calcareous tuff" or "spring deposit tuff", results from the chemical or biochemical precipitation of calcium carbonate in thermal springs, as calcite or sometime as aragonite. All these minerals, when of the highest quality, are the source of industrial calcium carbonate.

[42, IMA, 2002]

Limestone is almost exclusively mined in open pits.

The limestone in Flandersbach has the following parameters:

- 97 – 98 % CaCO_3
- <1 % MgCO_3
- <1 % SiO_2 (quartz)
- sometimes a higher content of shale or mud is included.

[107, EuLA, 2002]

3.2.6.2 Mineral processing

Limestone

At the **Flandersbach** quarry, after blasting, the limestone is transported by trucks to the crusher. There, the waste-rock is separated and dumped into another mined out quarry. The limestone goes to the mineral processing plant, which is essentially a washing plant for separation of 'mud' sediment from the limestone. The slurry after the washing plant is pumped into the tailings pond, another nearby mined out quarry.

The amount of raw material from the quarry is between 7 and 8 million tonnes/yr. Nearly 10 % of this raw material is waste-rock. Another 10 % is 'mud' sediment which is separated in the washing plant. The amount of sediment pumped into the tailings pond is, therefore, nearly 700000 t/yr. For every tonne of washed limestone 1 m³ of process water is required.

[107, EuLA, 2002]

Calcium carbonate

The vast majority of the mine production is marketable, as can be seen in the following table.

	Amount (kt)	Per cent
Ore from the quarry (natural calcium carbonate)	16655	100.0
Stock for sale	16100	96.7
Tailings released to the outside	75	0.4
Dust managed on-site	111	0.7
Tailings managed on-site for the rehabilitation of the quarries	369	2.2

Table 3.77: Production figures of calcium carbonate in the EU in 2000

Tailings released to the outside:

These tailings include the flotation residues with the mica (such as phlogobite, biotite, muscovite) and graphite impurities. They are sometimes settled in ponds or directly released to the recipient.

Dust managed on-site:

This dust includes all the tailings coming from the various dust collectors and cleaning systems in the plant bagging stations, etc.

Tailings managed on-site for the rehabilitation of the quarries:

This kind of material consists mainly of off-colour production or ground fillers and pigments outside of the product specification.

The production of Ground Calcium Carbonate (GCC) starts with its extraction. Identifying the right orebody in terms of composition, homogeneity, etc. is essential to the whole production process that will follow; a pure calcium carbonate source needs to be identified. Generally, the processing includes washing, sorting of undesirable by-minerals, grinding, size classification of particles and possibly drying. Depending on the circumstances and intended uses, the order and necessity of those different steps vary. At the outlet of the process, the material is delivered in bags or in bulk (trains, boats, trucks) when dry, or as bulk container from slurries. GCC results directly from the exploitation of pure calcium carbonate ore bodies (ore grade >96 %). The production process maintains the calcium carbonate very close to its original state, resulting in a finely ground product delivered either in dry or slurry form. Blasted raw marble is pre-crushed, and depending on the geology washed and sometimes screened. The fines are normally sold for different applications, such as road making, cement mills etc.

In the dry process, calcium carbonate is ground in ball mills, classified and stored in silos, or bags, before shipped by railway wagons or trucks. The products are mainly used in paint and plastics industries, minor applications are in the chemical industry, for fertilising and desulphurisation. Fillers and pigments for the paper industry are produced as slurries, which are finely dispersed calcium carbonate in water. Crushed material is ground with water in rod mills, or ball mills in open or closed circuit, classified and stored in silos before loaded onto railway wagons or trucks.

Due to the geology and mineralogy some calcium carbonate deposits contain unwanted minerals such as graphite, mica, or schist. To remove these natural impurities, selective mining and optical separation are developed together with other mineral processing steps in order to meet the requirements of the customers. Such mineral processing systems can be flotation or magnetic separation.

When magnetic minerals are bound to the marble, magnetic separation is a successful method to separate those "impurities".

Gangue minerals such as mica (such as phlogopite, biotite, muscovite) lead to abrasion in the paper producing machines, while graphite leads to a grey colour in the pigments. Therefore, product requirements impose to separate these minerals during the production process of the aqueous dispersion by means of flotation. The thickened concentrate is normally dewatered in filter presses.

As with all minerals the flow sheet for the production of calcium carbonate fillers and pigments must be adjusted according to the mineralogical characteristics of the calcium carbonate deposits.

The following figure shows an example calcium carbonate process flow sheet.

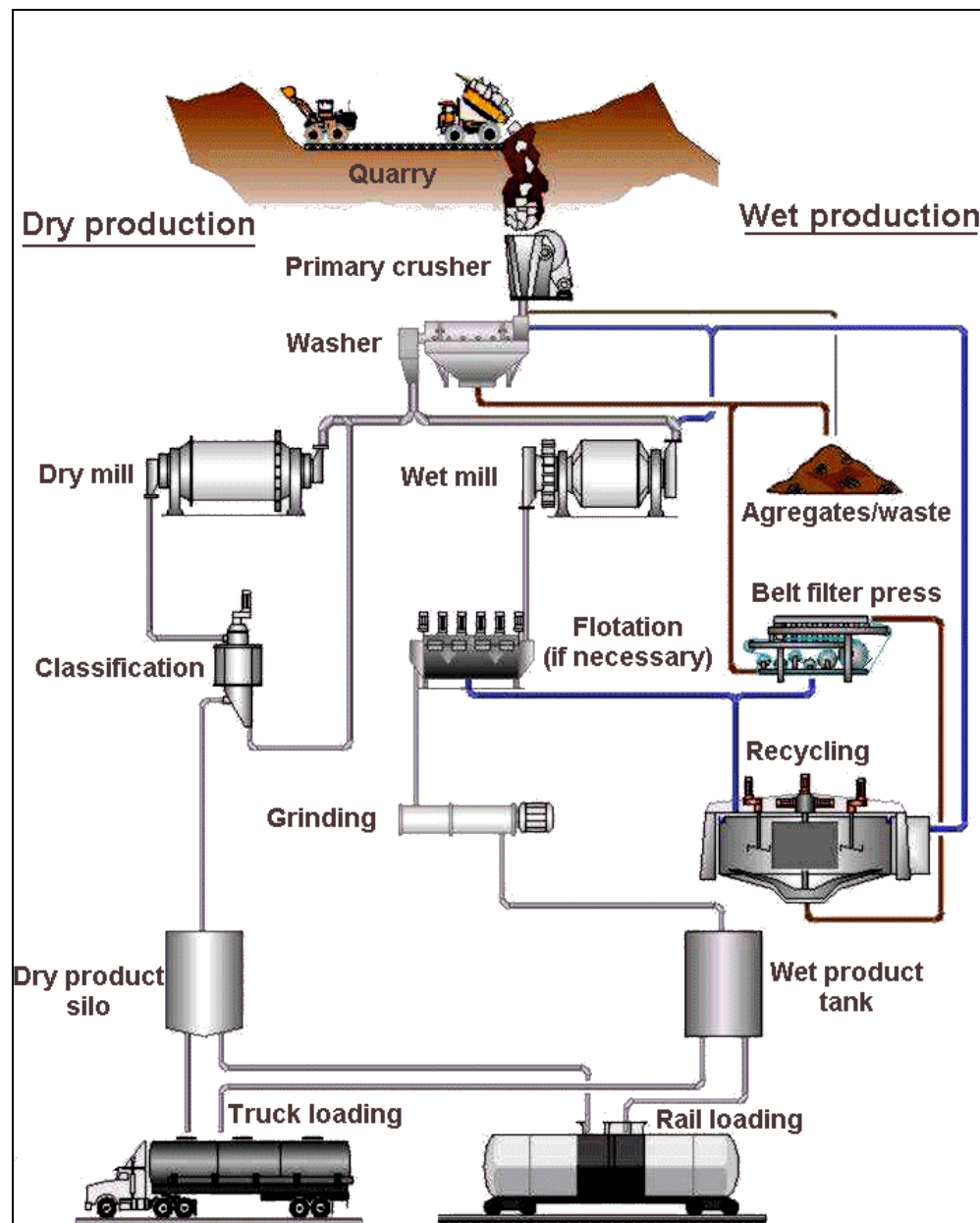

Figure 3.56: Calcium carbonate process flow sheet [42, IMA, 2002]

3.2.6.3 Tailings management

3.2.6.3.1 Characteristics of tailings

Limestone tailings are a mixture of calcite, dolomite, wollastonite and other very insoluble silicates and very small amounts of heavy metals. The grain size of the tailings is usually less than 0.25 mm.

3.2.6.3.2 Applied management methods

Limestone

The tailings pond of the Flandersbach quarry is installed in a mined-out quarry. The area today is 27 ha. The area in the future will be about 60 ha. The total capacity is over 30 Mm³. The pond is located close to the mineral processing plant. The pipes for the process water to the pond and for the clarified water back to the mineral processing plant have a length of about 1 km. There is also groundwater inflow into the pond from dewatering of the working quarry. Surplus water is led into a nearby river. [107, EuLA, 2002]

At the Münchehof quarry the tailings are stored in a pond surrounded by a dam. The following monitoring scheme is applied:

- groundwater level around the dam (monthly measurements)
- phreatic surface in the dam
- seepage water measurements (in a sump from which all drainage water is pumped collectively)
- surveillance of the dam crest and downstream dam toe
- water level in the dam (measured continuously)
- visual inspection by trained staff.

The monitoring scheme is designed in a way that changes of the dam can be recognised in time so that appropriate measures to maintain the stability of the dam can be initiated. [108, EuLA, 2002]

Calcium carbonate

The calcium carbonate industry uses tailings ponds from which the water is re-circulated to the mineral processing plant. The tailings are a saleable by-product. As far as possible waste-rock and dry tailings are also sold for other applications such as road making, cement and concrete manufacturing, but when there is a lack of customers, those aggregates have to be brought to heaps.

Prior to discarding, the ground is investigated in order to check whether the geology, hydrology, environmental issues and stability fit the requirements set up by the competent authorities. These studies are essential to get the permission for a heap from the competent authorities. The waste-rock and tailings are discharged together in horizontal layers. The end benches are immediately covered with soil and reclaimed with grass and trees according to long-term recreation plans. The evolution of the heap is monitored as well as water quality, groundwater level, and the slope stability if relevant or required by the authorities.

Slurried tailings are either:

- dried (thickener and filter press) and discarded on a tailings heap, or
- discharged to the outside water system (effluent) under conditions controlled by the competent authorities, or
- discharged into a tailings pond (one instance in Europe).

In the latter case the quality of the mineral deposit is such that about one third of the quarried stone is not suitable to the mineral processing plant and was used to construct the 16 m wide starter dam after removal of the huminous material. The slope of the starter dam was 1:1 and the impermeable core is protected against erosion by a layer of 1 - 2 m of 0 - 20 mm material. The impermeable core consists of 2 - 3 m of clay surrounded by a membrane.

Eventually the dam was raised. The starter dam was broadened (+ 12 m) and its height increased (+ 5 m).

Today the total area of the clarification pond is about 45 ha. All tailings discharged at the same point into the pond (single-point discharge). The seepage water through the dam is gathered and pumped back into the pond or, if the free water level in the pond is too high, it is discharged in a controlled manner (quality and amount) into the sewer system, from where it is further discharged into the municipal sewer system.

When the level of the flotation sand rises to a certain level, the discharge is moved and the dry flotation sand is excavated and sold. According to analyses of flotation sand (NEN 7341, NEN 7343 and ISO 11466), the contents of heavy metals are negligible. Also the concentration of flotation reagents is very low and they are very tightly fixed on the mineral particles but easily decompose if liberated.

[42, IMA, 2002]

3.2.6.3.3 Safety of the TMF and accident prevention

The permitting procedure for the TMF at the Münchhof quarry included, according to DIN 19700 T 10, a proof of stability of the dam including static and hydraulic aspects.

The stability calculation is carried out with the following elements:

- geotechnical and hydrogeological modelling
- slope stability
- shear strength
- base failure safety
- safety against pore pressure build-up in the foundation
- overtopping and erosion stability.

Another essential requirement for the dam stability is the suitability of the dam construction material. This is investigated in geotechnical tests. The following parameters are examined:

- friction angle
- specific density
- compressibility
- water content.

During the construction phase quality management was applied to ensure that the parameters that are crucial for the stability of the dam were met. This applies to dam foundation, the dam body and the dam core.

[108, EuLA, 2002]

The control and monitoring of the tailings facilities is done by both industry and the competent authorities. All the constructions (plans, design, etc.) must receive prior approval by the competent authority. The dams are checked every day and all possible changes in the constructions are marked in the control diary. If any leak is noticed, it will be instantly repaired and the information will be sent to the authority. An in-depth inspection is done yearly, and the authority audits the constructions and the record-keeping every five years.

[42, IMA, 2002]

3.2.6.3.4 Closure and after-care

Upon closure of the TMF, the ponds are dewatered and covered with a vegetative cover. [108, EuLA, 2002]

3.2.6.4 Waste-rock management

At the Flandersbach quarry, waste-rock is separated before the washing and dumped into an old quarry [107, EuLA, 2002].

3.2.6.5 Current emissions and consumption levels

3.2.6.5.1 Management of water and reagents

Due to the circulation of process water the consumption of fresh water is low, since only the pore water attached to the product and the evaporated water is lost. The addition of fresh water strongly depends on the climatic conditions (evaporation and rainfall). The Münchehof quarry, for example has to add 437 m³/d for 23000 m³ (dry basis) of tailings. [108, EuLA, 2002]

3.2.7 Phosphate

All information from [143, Siirama, 2003].

3.2.7.1 Mineralogy and mining techniques:

The Siilinjärvi mine is located in Eastern Finland 400 km north-east from Helsinki. The known ore deposit is 16 km long and up to 800 m wide, and is an almost vertical outcrop.

Besides the phosphate mineral apatite (10 %), the ore consists of phlogopite mica (65 %), carbonates (20 %) and silicates (5 %). The ore quality varies strongly throughout the ore body. Apatite is distributed quite evenly through the deposit, but the mica and carbonate distribution varies significantly. Siilinjärvi is one of the world's poorest deposits to be exploited; the average P₂O₅ content in situ is 4 %.

The mining in the open pit is done in 14-metre wide benches. Drilling is done by hydraulic top hammer drilling machines using mainly 203 mm diameter boreholes. Transportation of the blasted ore to the processing plant is carried out by 100-tonne dumper-trucks.

3.2.7.2 Mineral processing

The Siilinjärvi mineral processing flow sheet is shown in the following figure.

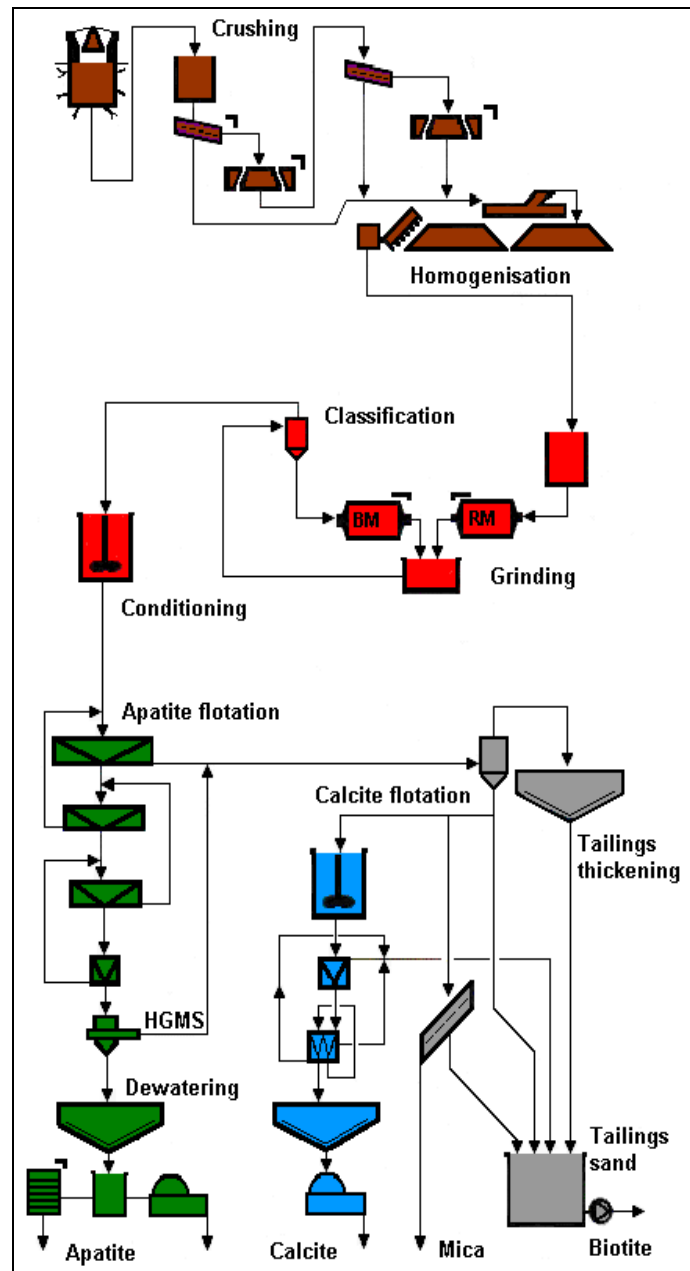

Figure 3.57: Flow sheet of the Siilinjärvi mineral processing plant

Blasted ore is first crushed in three steps, and after homogenisation ground in rod mills (RM) and ball mills (BM). Subsequently, the apatite mineral is recovered by flotation, cleaned and dewatered, before the concentrate is transported by trucks to the phosphoric acid plant. Calcite is removed from apatite tailings, as are mica and other micaceous products. Tailings are pumped to the tailings dam area.

3.2.7.3 Tailings management

There are two tailing dam areas at Siilinjärvi. One is Raasio dam area (150 ha), which was used during the start-up phase of the operations, but today is only used as a temporary stand-by pond and as a part of the closed water circulation system. The TMF which has been used since 1982 is the Musti dam area (over 800 ha).

The Musti area is located 5 km from the mineral processing plant and is an off-valley type dam, built on a sloped landscape (east side up to 30 m higher than the west side). Due to the repeated dam raises, almost the entire facility is now surrounded by the dam.

The tailings within the pond are crushed and milled rock (i.e. sand), consisting mainly of phlogopite mica, which can be considered inert. After settling, the clarified water is pumped via Raasio back to the process water pumping station from where the plant gets its process water, with the surplus water being pumped via chemical treatment to the nearby lake. Water pumped to the lake is treated with water purification chemicals, with a pH reduction to 7 to allow for efficient sedimentation of the solids.

The dam is a staged conventional downstream type (see Section 2.4.2.2), built out of moraine, with crushed waste-rock as a filter and blasted rock as support part.

The operation of the tailings dams at Siilinjärvi includes the following programmes and routines:

- control programmes:
 - water level controls on-line and monitored, with alarms in the plant operating system
 - regular measures of the amount of circulating and surplus waters
 - daily inspection of the area
 - seepage measurements
 - dam movement measurement
- risk assessments:
 - according to Finnish dam safety law
- ensuring continuity throughout the mine life:
 - planning ahead 10 - 15 years
 - continuously carrying out dam construction programmes and filling estimates
 - owning the land
 - applying for permissions years in advance
 - maintaining a good relationship with the permitting authorities and also the people living around the mine
- using the downstream method to raise the dams
- emission controls:
 - water quality control in seepage, surplus and circulation water
- continuous free water surface control (amounts and quality)
- emergency plans:
 - based on Finnish dam law, a simulation of a total collapse has been done together with permitting and rescue authorities

3.2.7.4 Waste-rock management

The waste rock from the open pit is used as a raw material of crushed rock products or as a structural material in soil engineering constructions (roads, dams, railroads). The excess of waste rock is stockpiled to certain areas around the open pit.

The waste rock stockpiles are landscaped following a landscaping plan, which is used during piling. The landscaping plans have been done together with local authorities and with the input of people living around the mine.

3.2.7.5 Current emission and consumption levels

Emissions to air are not measured, but observations of dusting are recorded.

The excess water, which cannot be returned to the mineral processing plant, is discharged into the river system, where the phosphate load and BOD and solids are measured. The half-yearly floating average in these watercourses is about 1.5 kg of phosphate per day.

3.2.8 Strontium

3.2.8.1 Mineralogy and mining techniques

There are two open pit mines in the south Granada area in Spain. In one case the orebody is very pure and massive. The ore is extracted using drilling and blasting. At the other site the deposit is irregular and not as pure. There, the ore is mined selectively with excavators, so that practically no waste-rock is generated.

[110, IGME, 2002]

3.2.8.2 Mineral processing

The ore from the pure massive orebody is of such high grade that only classification is needed to obtain the final product.

At the other operation the characteristics of the deposit require the installation of a mineral processing plant incorporating grinding, classification and concentration. The latter is carried out by dense media, to obtain a pre-concentrate, and finally fine grinding and flotation.

[110, IGME, 2002]

3.2.8.3 Tailings management

There are two types of tailings from the mineral processing step at the Granada sites: One coarse fraction from the dense-media pre-concentration and the fines tailings from flotation.

The coarse tailings are backfilled into the open pit where they are used in the site restoration. The flotation fines, in the form of a slurry are managed in a tailings pond. At the pond currently in operation, the tailings are cycloned, with the coarse fraction being used in the structural zone of the dam, while the fines are discharged into the pond (see figure below). The current pond, with a surface area of 14 ha, 17 m height and containing 700000 m³ of tailings, will soon be replaced by a new impoundment.

This new construction follows a completely different approach, namely that:

- a flat area has been excavated on a hillside
- the dam has been constructed to its final height using the excavated rock and borrow material
- the foundation of the new pond has been lined with PVC, under which has been placed another geotextile layer to protect the liner from possible punctures by direct contact with the natural bedrock.

With a total capacity of 800000 m³, this new TMF has an expected lifetime of 10 years.

The following picture illustrate the old and the new site.



Figure 3.58: Old strontium TMF with tailings in structural zone
[110, IGME, 2002]



Figure 3.59: New strontium TMF with a synthetic liner and decant towers
[110, IGME, 2002]

3.2.9 Talc

3.2.9.1 Mineralogy and mining techniques

Talc is a hydrated magnesium silicate; it is the softest mineral known in nature. Talc occurs mainly in two forms: schistose talc-magnesite rock and massive pure talc. There is no specific mining technique for the excavation of this kind of mineral, because the choice of the technique depends on the structure of the orebody.

Talc deposits in Finland are located on the early Proterozoic schist belt in Eastern Finland. Talc deposits are related to Mg-rich ultramafic rocks which have been altered to talc-carbonate rocks. The schist belt is about 2 billion years old and the talc was formed during the Svecokarelian orogeny some 1.8 billion years ago. Talc is extracted from a talc magnesite rock which is mainly composed of talc, carbonates (magnesite and dolomite), chlorite and sulphide minerals. Oxides and sulpharsenides are present as trace minerals. The amount of talc varies from 45 to 60 % and carbonates from 35 to 45 % while chlorite (5 %) and sulphides (1-3 %) are just minor components. Some parts of the deposits are relatively sheared where the talc ore is also schistose and fine grained. Talc is typically fine-grained (0.05-0.2 mm) and platy, chlorite occurs in a similar form while carbonates are much coarser (up to several mms or cms in diameter). On the other hand, some parts are massive with relatively coarse grained talc (up to 1 millimetre) and carbonates. Talc carbonate rock is typically greyish occasionally with a greenish or reddish colour, whereas talc itself is typically greenish or very pale, almost white mineral. Talc ore must be ground before the flotation to liberate different minerals and flotation is needed to achieve a high purity and brightness of the end-product.

3.2.9.2 Mineral processing

When using dry processes (67 % of the European production), no tailings are generated. All the raw materials are used and sold with different grade specifications. The flotation process is only used to treat the Finnish ores, which represent about 33 % of the total European talc production. The use of the flotation process is imposed by the characteristics of the Finnish deposits.

The following flow sheet shows the process for the Finnish operation using flotation.

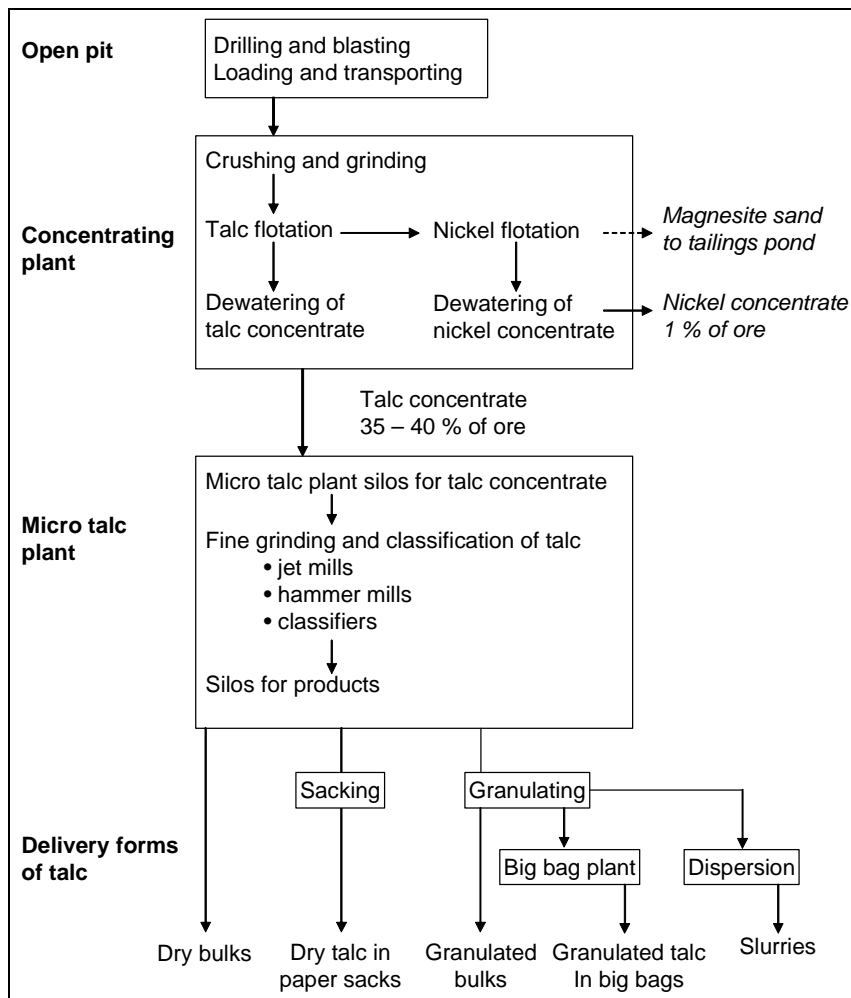

Figure 3.60: Talc process flow sheet using flotation

The process chemicals used in the flotation are Montanol, Na Xanthate and CMC.

3.2.9.3 Tailings management

Three tailings ponds are in use with a total current volume of about 10 Mm³ and dam heights up to 17 m. Part of the tailings are discarded onto a heap (currently 1 Mm³).

The heap is constructed as follows:

Tailings slurry is pumped into a pond with a decant tower in the centre. The tailings are distributed from the surrounding dams into the pond so that the tailings sand settles close to the dams and can be used as construction material to increase the height of the dam. Clear free water is discharged through the decant tower. By systematically changing the discharge points of the tailings slurry, the height of the whole area can be increased by 5 - 10 m. The outer slopes of the dams are covered with soil to prevent dusting and to promote vegetation. After dewatering the tailings the pond can be considered a heap.

The operational monitoring is done as follows:

Every day the tailings areas are visually checked and the necessary level monitoring is carried out and recorded. When necessary, monitoring is carried out (Ni and As analysis) of the tailings pond water, before draining it as waste water. During the snow melting season visual checks are made of the tailings areas and the dams on every shift. Annual monitoring of dams is carried out

in summertime and all data are filed in dam safety manuals including dam condition, seepage water assessment, etc.

According to the Finnish dam safety regulations a dam safety manual is required for each tailings pond. An inspector from the competent authority visits the tailings area every five years and carries out a visual check of the dams and inspects the collected operational monitoring. The dam safety manuals include the tailings area and dam maps, design values and stability calculations of tailings dams, classification criteria, inspection and monitoring documents, risk assessment of tailings areas, etc.

The water management of the three plants can be described as follows:

- Sotkamo plant: the process water needed for flotation comes from recycled water from the tailings ponds. Recycling percentage is close to 100 %. Additional water to the process water system comes from the adjacent open pit mine (nickel containing), fresh water system of the steam boiler and rainwaters collected on-site. This additional amount of water is drained from the tailings pond to the local lake
- Vuonos plant: the process water needed for flotation comes about 50 % from the recycling water in the tailings ponds. Additional water to the process water system comes from the local lake, adjacent old open pit mine (nickel containing), the fresh water system of the steam boiler and rainwater collected on-site. This additional amount of water is drained from the tailing pond to the local lake. Process water is used also in the production of some paper talc qualities
- Kaavi plant: the process water needed for flotation is comes to 100 % from the local lake. Additional water to the process water system comes from the fresh water system of the steam boiler and rainwaters collected on-site. No recycling of process water from tailings ponds is available. All process water is treated and drained from the tailings pond to the local lake. The waste water permit states that a recycling system has to be operational at latest by the end of 2003.

3.2.9.4 Waste-rock management

Trucks are used to haul and dump the waste-rock to the heaps which are designed with a safety factor of at least 1.3. The heaps are surveyed yearly by an external topographic contractor and (inspected) monthly by mine staff. Risk assessments are periodically done by the operator.

The heaps are permitted with a final rehabilitation project including water drainage and vegetal planting (trees and local grass).

3.2.10 Costs

In European feldspar operations the average cost for moving solid residues to a heap within a site amounts to EUR 0.80 and the average diesel fuel consumption of a truck is 28 l/hour.

For the flourspar/lead zinc operation the overall cost for tailings management in several ponds, 1300000 m³ in total volume, is around EUR 210000/yr; this includes energy consumption and maintenance of the section.

For kaolin operations the average cost for moving tailings to a heap within a site amounts to EUR 1/tonne (if done internally) and EUR 2/tonne (if done by a contractor).

Approximate costs per m³ of water are, in the dewatering system EUR 0.10/m³ and, in the water cycle of the limestone plant at **Flandersbach**, another EUR 0.10/m³. [107, EuLA, 2002]

At the Finnish talc operation, the cost of trucking tailings is EUR 2 per tonne and km.

3.3 Potash

The applied techniques for potash are very much different than all other industrial minerals, hence a separate Section has been dedicated to discussing potash. Unless otherwise mentioned the information has been submitted by the potash subgroup [19, K+S, 2002]. This contribution describes potash sites in Germany, Spain and the UK.

3.3.1 Mineralogy and mining techniques

Potash deposits were formed by the evaporation of seawater. Their composition is often affected by secondary changes in the primary mineral deposits. More than 40 salt minerals are known, which contain some or all of the small number cations Na^+ , K^+ , Mg^{2+} , and Ca^{2+} , the anions Cl^- and SO_4^{2-} ; and occasionally Fe^{2+} and Br^- , as well. The most common minerals are listed in Table 3.78.

Mineral name	Chemical composition
Anhydrite	CaSO_4
Carnallite	$\text{KCl} \times \text{MgCl}_2 \times 6\text{H}_2\text{O}$
Gypsum	$\text{CaSO}_4 \times 2\text{H}_2\text{O}$
Halite	NaCl
Kainite	$\text{KCl} \times \text{MgSO}_4 \times 11\text{H}_2\text{O}$
Kieserite	$\text{MgSO}_4 \times \text{H}_2\text{O}$
Langbeinite	$\text{K}_2\text{SO}_4 \times 2\text{MgSO}_4$
Leonite	$\text{K}_2\text{SO}_4 \times \text{MgSO}_4 \times 4\text{H}_2\text{O}$
Polyhalite	$\text{K}_2\text{SO}_4 \times \text{MgSO}_4 \times 2\text{CaSO}_4 \times 2\text{H}_2\text{O}$
Sylvite	KCl

Table 3.78: Most common salt minerals in potash deposits

The most important salt minerals are halite, anhydrite, sylvinitite, carnallite, kieserite, polyhalite, langbeinite and kainite. Gypsum and/or anhydrite occur at the edges of salt deposits and in the overlying strata.

Potash salt deposits always consist of a combination of several minerals (Table 3.79). The German term "Hartsalz" (hard salt) refers to the greater hardness of sulphate- and magnesium-containing potash minerals.

Marine salt minerals	Main compounds
Sylvinitite	Sylvite, halite
Carnallitite	Carnallite, halite
Hard salt	Sylvite, halite, kieserite and/or anhydrite
Kainitite	Kainite, halite

Table 3.79: Marine salt minerals

In the following, to avoid confusion, the term sylvinitite will be used for the mineral mixture of sylvite and halite, which usually occur together.

Salt deposits in Central Europe are the result of intensive evaporation of marine water more than 250 million years ago. Over millions of years, the original salt deposits were covered with other sediments, such as clay, limestone and anhydrite. Tectonic influences left them as flat layers (sub-horizontal deposits) or deformed them into steeply dipping deposits (see figures below).

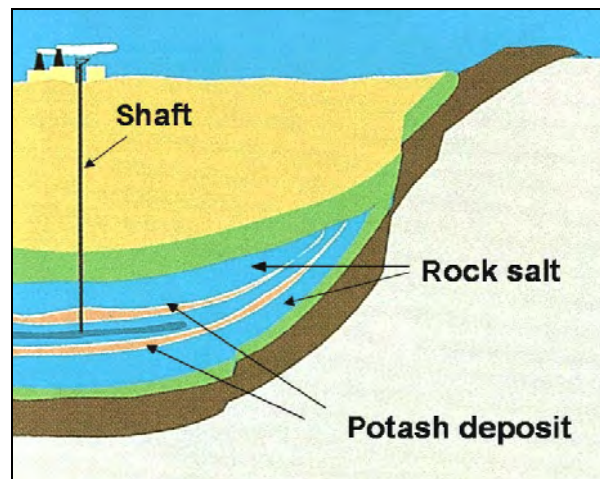

Figure 3.61: Sub-horizontal potash deposit

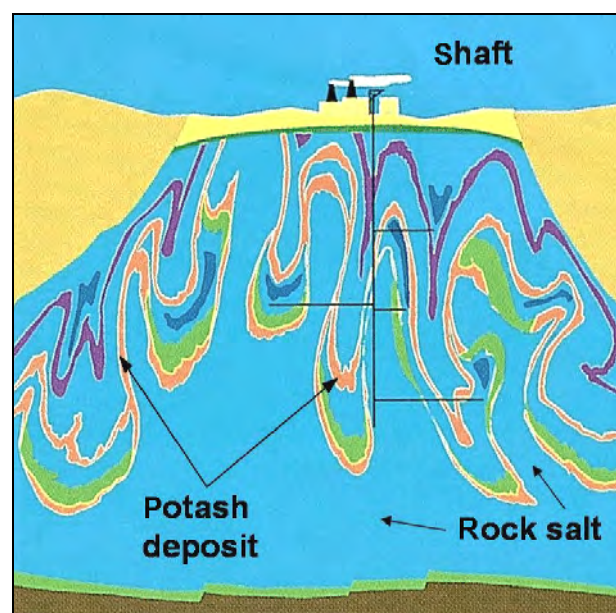

Figure 3.62: Steeply dipping potash deposit

Potash is usually extracted by room and pillar and sometimes longwall mining. Sometimes the 'solution mining' method is also applied. However, today solution mining is only of minor local importance in Europe. Open pit mining is not an option, due to the water solubility of potash.

Room and pillar mining

With this method the height of stopes is about two to three metres. Usually 25 - 60 % of the ore can be extracted from the mine. The pillars remain unmined. Two ways of applying this method are currently practised:

- drilling and blasting: Drilling machines are used to cut small diameter boreholes over a distance of 7 m to 30 m in the face, either horizontally (sub-horizontal/flat deposit) or vertically (steep deposit). The holes are filled with explosives (prills of ammonium nitrate with 3 % mineral oil) and the rock is blasted. The fractured salt is hauled by loaders to underground pre-crushing stations where it is crushed to a size which can be transported by conveyor-belts

- continuous mining: An excavation machine with a rotating head, the so-called ‘continuous miner’, is used to mine the ore in a size which can be transported directly by conveyor belts. The following surface operations are similar to the drill and blast mining method. Bolts are placed in the roof of the underground galleries for support and to protect the workers and the equipment.

At present, potash mining in Germany is carried out in depths between 400 and 1200 m. The ore is always transported in pre-crushed form by conveyor-belts to intermediate underground storage prior to hoisting with skips.

Longwall mining

This is the same method commonly used to mine coal deposits in Europe.

Sublevel stoping

In steeply dipping deposits in Northern Germany, sublevel stoping (also called ‘funnel mining’) is carried out. Entry drifts are driven one above the other at intervals of 15 - 20 m, and the remaining potash salt is mined by drilling vertical boreholes and then blasting. The blasted ore falls into the main level underneath. The mined-out room, 100 – 250 m in height, is usually backfilled with salt tailings.

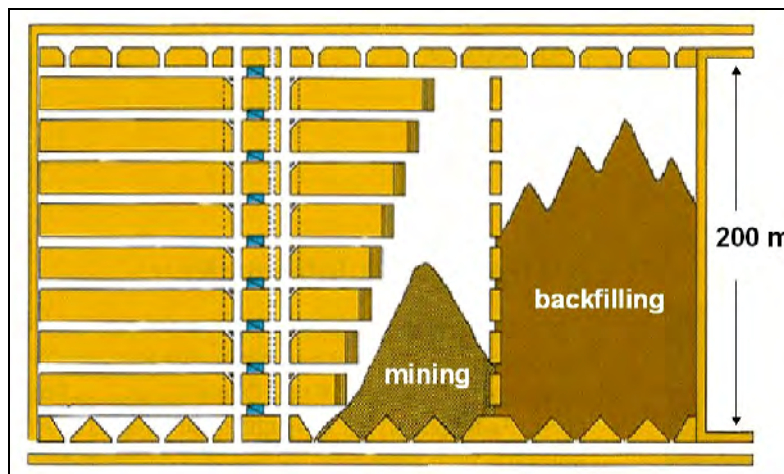

Figure 3.63: Sublevel stoping with backfill in steep potash deposits

Solution mining

KCl-unsaturated brine is injected in a borehole into the salt deposit to dissolve potassium chloride. The KCl-saturated brine is pumped back to the surface. The saturated solution crystallises and precipitates by evaporation of the brine in huge evaporator-vessels. A second separation process - e.g. flotation or re-crystallisation - follows to purify potassium chloride and sodium chloride as marketable products.

Exploited potash deposits in Europe

The exploited potash deposits in Europe were mainly formed in the Permian period, which took place in a vast evaporite basin, called the Central European Basin. This basin extends from North-East England to Central Poland and Lithuania, and from Central Germany to the northern part of the North Sea. The Alsacian and Spanish deposits were formed in the Tertiary period and are isolated basins.

France

The deposit in Alsace contains two sylvinitic seams in a marl-rock salt series. The upper layer has a thickness of up to 2 m and contains 19 - 25 % K_2O ; the lower, up to 5.5-m-thick layer, with 15 - 23 % K_2O , also contains 15 % insolubles (clay, anhydrite, and dolomite). Mining is carried out at comparatively high rock temperatures at a depth of 500 - 1000 m in flat or slightly inclined seams that have been disturbed by faults. The last producing mine was closed in 2003.

Germany

In the Werra and Fulda areas, the Hessen and Thuringia potash seams of the Werra series are mined (hard salt and carnallite in level deposits at a depth of 400 - 1000 m with a thickness of 2 - 5 m, containing 9 - 12 % K_2O and 4 - 20 % $MgSO_4$). The Stassfurt potash seam of the Stassfurt series was mined in the Harz-Unstrut-Saale area (hard salt and carnallite at a depth of 500 - 1000 m and a thickness of 5 m, containing 20 % K_2O). The last potash mines, extracting hard salts of the Stassfurt series closed in 1991 for economic reasons. The potash seams Ronnenberg and Riedel of the Leine series are mined in the Hanover area in salt diapirs (sylvinitic in inclined deposits at a depth of 350 - 1400 m with a thickness of 2 - 40 m, containing 12 - 30 % K_2O). Finally, potash is mined on the Massif of Calvörde near Zielitz (at a depth of 350 - 1200 m, Ronnenberg sylvinitic inclined at $<18 - 25^\circ$, thickness of up to 10 m, containing 14 - 20 % K_2O).

Spain

Deposits are located in two areas of the Ebro Basin. In Catalonia and Navarra, potash salts lie above the rock salt. These deposits are up to 15 m thick in Catalonia and up to 10 m in Navarra. Above this occurs an interbedded deposit of rock salt, carnallite, marl, and anhydrite. Only the sylvinitic seams A and B are mined. These are up to 4 m in total thickness at a depth of 1020 m, some deposits are level and some inclined. The crude salt contains 12.5 - 14 % K_2O .

United Kingdom

In Cleveland, a level deposit of sylvinitic is extracted, which correlates with the German Riedel seam, both petrographically and stratigraphically (average thickness of 7 m, containing 25 % K_2O at depths of 800 - 1300 m).

3.3.2 Mineral processing

The processing of potash generally involves a series of steps including size reduction (crushing/grinding), separation (hot leaching-crystallisation, flotation, electrostatic separation) and de-brining. These steps are described below.

3.3.2.1 Comminution

The salt minerals in run-of-mine potash ore are intergrown to varying extents. Before the minerals can be separated and the useful components recovered, the raw salt must be sufficiently reduced in size to liberate the desired mineral from the gangue.

For the hot leaching process, a maximum grain size limit of 4 - 5 mm is adequate. For mechanical processing (e.g. flotation), the potash minerals must be ground to a degree of liberation $>75\%$. For sylvinitic minerals and hard salts, this is achieved by grinding to a maximum size of 0.8 - 1.0 mm.

Various grain size fractions are produced in mills and different types of screens. In the first stage impact- or hammer mills generally produce particles of about 4 - 12 mm, depending on the raw material and the processing method used. The final fine grinding stage works with rod mills (when wet) or under dry conditions with roller mills or impact crushers (see figure below). The selection of the equipment used is based on minimising the generation of fines and ultrafines

which have a negative influence on the subsequent separation, e.g. in flotation the reagent consumption increases significantly with the amount of fines due to the larger specific surface.

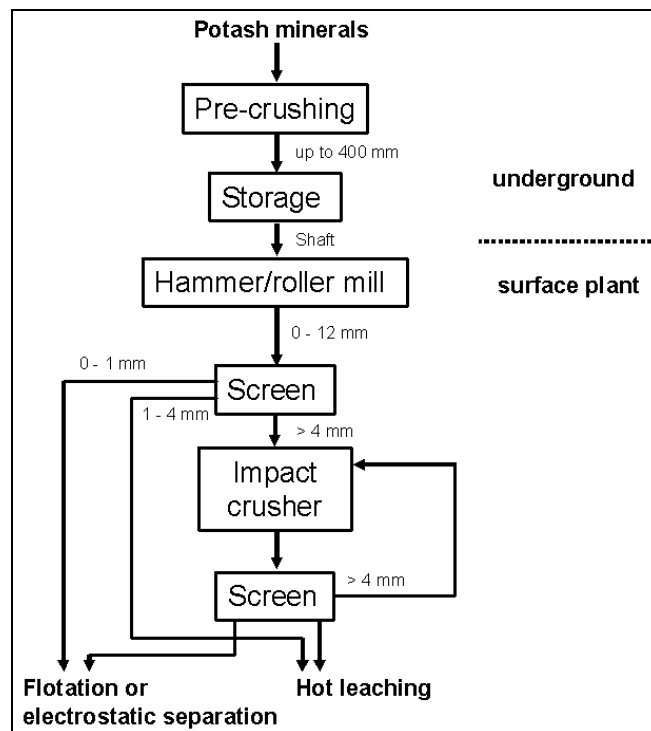

Figure 3.64: Dry grinding and screening (schematic) of potash ore [19, K+S, 2002]

3.3.2.2 Separation

If potash is mined ‘mechanically’, i.e. not by solution mining, there are four methods which can be applied for separating the desired salts from the gangue:

1. hot leaching
2. flotation
3. electrostatic separation
4. heavy-medium separation.

For all wet processes (i.e. 1,2,4) de-brining is necessary.

The following sub-sections describe these process steps.

3.3.2.2.1 Hot leaching process

For the hot leaching process, two different processes are used, depending on the composition of the salt minerals. In the **syvinitic hot leaching process**, the other salts present besides KCl and NaCl play only a minor role in process solutions. The **hard salt leaching process** solutions contain appreciable amounts of MgSO₄ and MgCl₂. For carnallite-containing hard salts or unique carnallite, preliminary carnallite decomposition must be carried out if the amount of carnallite present exceeds a critical level of about 20 - 30 %.

In both processes the potash minerals, ground to a fineness of <4 - 5 mm, are stirred in a continuous dissolver with leaching brine heated to just below its boiling point. The leaching brine (with a temperature of approx. 110 °C) is the preheated mother liquor from the crystallisation stage of a previous process cycle. The potassium chloride should be extracted

from the minerals as completely as possible, and the resulting product solution should be nearly saturated. The tailings consist of two fractions of different particle size. The coarse fraction is removed from the dissolver and de-brined. The fine fraction (e.g. slime) is removed from the dissolver along with the crude solution. After separation in a clarifier, the fine fraction is filtered off.

The tailings are washed with water or plant brines low in potassium chloride to remove the adhering crude solution, which has a high potassium chloride content. The tailings are then discarded by stacking or backfilling in the mine. If kieserite needs to be separated, the tailings are transported to further mineral processing (e.g. flotation). The filtrate of tailings-dewatering is recycled to the re-circulating brine.

The hot, clarified, solution is cooled by evaporation in the vacuum station. Evaporated water must be replaced to avoid crystallisation of undesired sodium chloride. The desired potassium chloride crystals, formed by cooling the crude solution stage by stage (down to about 25 °C), are separated from the mother liquor and further processed. The mother liquor (saturated with KCl and NaCl at 25 °C) is heated and recycled to the dissolver as leaching brine. The layout of a leaching plant including crystallisation is shown in the figure below.

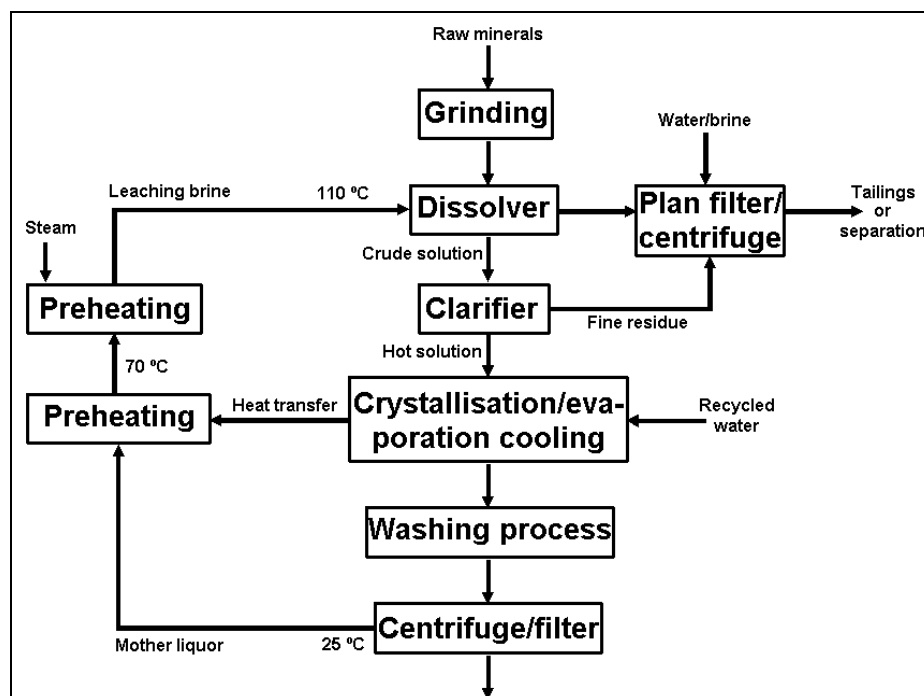

Figure 3.65: Flow diagram of the hot leaching-crystallisation process used for the production of KCl from potash minerals (schematic)

This simple process is used for the treatment of sylvinitic minerals only. The mineral processing of hard salt minerals is more complicated. With higher magnesium salt contents, the temperature dependence of the solubility of NaCl becomes undesirable and the yield of potassium chloride decreases.

In many plants, especially in Canada, where flotation is the main production process, small hot leaching plants are also operated, in which the product "fines" (<0.2 mm) are re-crystallised, or potassium chloride is separated from flotation tailings or thickened clay slurries. These procedures lead to a considerable improvement in total yield and result in a very pure, completely water-soluble product. The hot leaching process is necessary to generate pure potassium chloride products for chemical or pharmaceutical uses.

3.3.2.2 Flotation

In the German potash industry, potash flotation as well as kieserite flotation is used. After grinding or previous separation-processes the fine size fraction (0 - 1 mm) is added to an aqueous, saturated potassium/kieserite and sodium chloride solution. As a frother pine oil is added. Rotating paddles scrape the potassium chloride or kieserite bearing froth from the surface of the mechanical cells for further treatment. The most satisfactory collecting agents are long chain alkylammoniumchlorides.

The following figure shows a schematic illustration of the mineral processing of the raw minerals or intermediates, carried out in rougher and cleaner flotation cells.

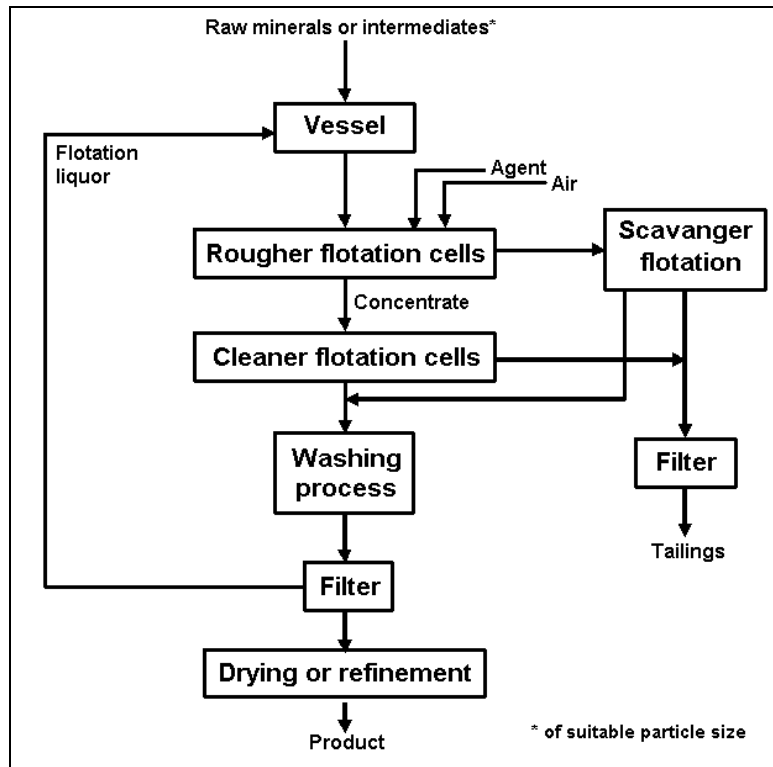

Figure 3.66: Flow diagram of a flotation plant (schematic)

3.3.2.3 Electrostatic separation

Crushed and ground raw salt is conditioned to achieve greater retention of the electrostatic charge by heating to less than 100 °C. The crystals are coated with an organic agent such as a primary fatty acid, a derived salt, ester or amine. Depending on the aim of the separation 20 to 100 g of conditioning agents per tonne of raw salt are applied.

The ground mineral is electrostatically charged, under a specified relative humidity, by friction in a heated fluidised bed (see figure below). Separation of the halite minerals occurs when the charged crystals fall under gravity through an electric field of about 120000 volts in a free fall separator. The separation process is controlled by adjustable flaps, that are placed in the bottom of the separator (see Section 2.3.4). The middlings are reconditioned and recycled.

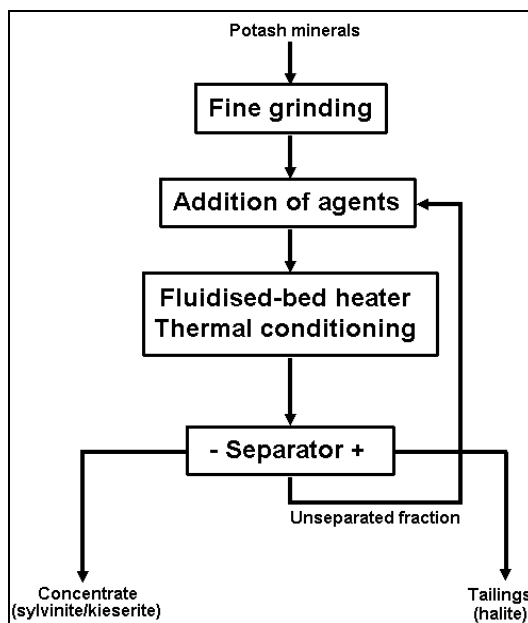

Figure 3.67: Flow diagram of an electrostatic separation process (schematic)

In most cases, a multi-stage separation or treatment is used. The solid tailings (sodium chloride/halite) are stacked directly on the tailings heap. Other options, such as firstly separating the sylvinite and carnallite from the kieserite, are also possible and are applied at other plants.

3.3.2.2.4 Heavy-media separation

Halite has a higher density than sylvinite (specific gravity 2.13 g/cm^3 versus 1.9 g/cm^3 for sylvinite). Commercial dens media operations use a very finely divided weighting agent, typically ferrosilicon or magnetite of a fine grade, which is slurried to create an artificial dens medium at the specific gravity required for separation. After separation, the magnetite or ferrosilicon is recovered by magnetic separation and re-circulated to the system.

A plant of this type operates in Canada. This process is also applied for the separation of langbeinite (specific gravity 2.83 g/cm^3) from sylvinite/halite a plants in New Mexico and the US. At present, this technique is not used in Europe.

3.3.2.3 De-brining

The products and tailings from all potach treatment processes, except for the dry electrostatic process, are obtained as suspensions/slurries with various solid contents and must be de-brined – after first being thickened in circular thickeners. The equipment used includes centrifuges, plan filters, drum filters and belt filters, especially for de-brining fine tailings (moisture content of about 9 - 14 %) and, when it is necessary, to wash the filter cake. The choice of equipment is determined mainly by the particle size of the material to be treated and the content of other minerals such clay.

For coarse products and tailings, vibrating screens and screw screen centrifuges are commonly used.

3.3.3 Tailings management

The mineral processing of potash minerals leads to over 78 % solid or liquid tailings (see figure below).

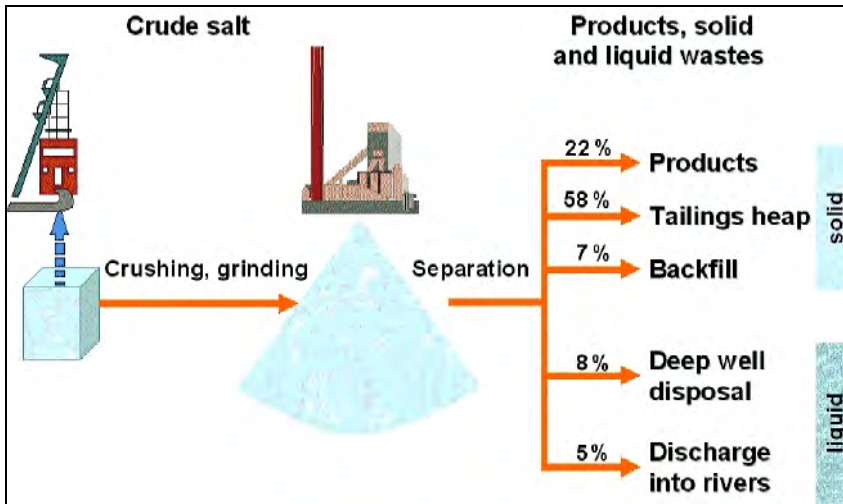

Figure 3.68: Distribution of products, solid and liquid tailings after mineral processing

Six methods for managing process water and/or tailings are applied:

- discarding solid tailings onto heaps
- backfilling solid tailings underground into mined out stopes
- discarding slurried tailings on tailings piles (only carried out in Canadian/US-Potash Mines)
- applying marine tailings management of solid and liquid tailings
- pumping liquid tailings into the ground (deep well tailings management)
- discharging liquid tailings into rivers.

3.3.3.1 Characteristics of tailings

Solid potash tailings consist of sodium chloride with a few per cent of other salts and insoluble materials such as clay and anhydrite (see figure ‘sylvinite tailings’). Hard salt tailings additionally contain about 5 % kieserite (see figure ‘hard salt tailings’).

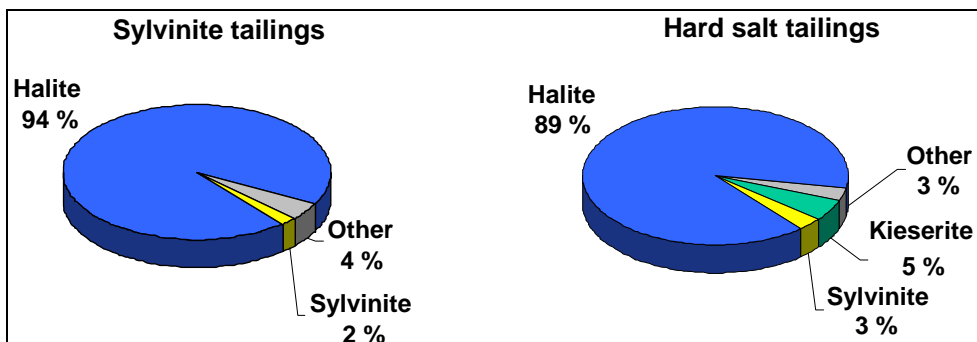

Figure 3.69: Mineral composition of sylvinite and hard salt tailings

The stacked tailings harden immediately, and the density of the tailings increases to nearly the same density as underground due to compaction. This has been shown by measurements from borehole-samples of tailings heaps. Heaps are stacked with an angle of repose of about 37 ° (natural soil angle: 25°). Therefore, no problems with the slope stability of the heap occur, if the underlying ground is stable. There is a wide experience in stacking potash tailings. The first heaps going up to 200 m in height were started about 30 years ago. Smaller heaps with tailings from potash mining exist from the beginning of potash-mining in about 1890.

Precipitation dissolves the tailings heaps slowly and over a long period of time. As a result of compaction and hardening, the interior of potash tailings heaps is impermeable to water. Water and generated brines flow down in an outer sphere around the inner impermeable core. To protect soil and groundwater, the outer seam of heaps outside the impermeable core zone is carefully sealed and the brines are collected in sealed ditches around the heap. The slope of the heap consists of hardened rock salt without any erosion after compaction and re-crystallisation.

The dissolved NaCl needs careful management to reduce its impact on the local environment. However, the tailings usually contain insignificant amounts of heavy metals and other trace elements or substances.

Liquid potash tailings are essentially the same material as in sylvinite tailings (90 % NaCl) but which have been dissolved in fresh- or seawater for transport to a suitable receptor. For discharges into surface waters or through long pipelines (i.e. as in Spain), the suspended solids content is usually very low.

3.3.3.2 Applied management methods

The amount of tailings generated by a potash mine depends primarily on the potash seam configuration, rock stability and mineral composition. These are all natural conditions that vary between mines and deposit and sometimes even within a deposit. As a result, there is no standard model of mines in terms of processing and generation of products and tailings. Each mine has its own specific conditions affecting solid or liquid tailings generation and management. Also, these specific conditions can change over the lifetime of a mine. However, economic reasons mean that operators will seek to minimise the amount of gangue materials mined and processed.

For **solid tailings**, the management of the tailings on heaps and by backfilling underground are applied. The tailings from the hot leaching and flotation process with sodium chloride as the main compound are dewatered by centrifuges, filters and then transported by conveyor-belts to the tailings heap. In addition, in Germany, the dry electrostatic separation process allows dry management of tailings on tailings heaps.

For **liquid tailings**, management of the tailings involves deep well discharge (under specified geological conditions) and/or discharging into surface waters. Under special geographical conditions, marine discharge of solid and liquid tailings is applied.

3.3.3.2.1 Tailings heaps

About 21 million tonnes of potash tailings are stacked by the German potash industry every year. Large tailings heaps are built with quantities of 25 to 130 million tonnes, altitudes of 90 to 240 m with a footprint of 47 to 110 ha.

The largest tailings heaps, their location, altitude, size, the quantity of tailings and the main compounds are shown in Table 3.80.

Plant/facilities	Location	Altitude (m)	Size (ha)	Quantity (million tonnes)	Main compound	Remarks
Hattorf	Werra-area	160	47	59	Halite	
Wintershall	Werra-area	240	55	99	Halite	
Unterebreizbach	Werra-area	42	4.6	<1	Kieserite	Currently reprocessed
Neuhof-Ellers	Fulda- area	180	70	80	Halite	
Sigmundshall	Hannover area	150	26	25	Halite	
Zielitz	Zielitz	50	53		Halite	
	Zielitz	90	110	130	Halite	

Table 3.80: Tailings heaps of the German potash mines

The following figure shows a typical salt tailings heap in Germany.



Figure 3.70: Aerial view of a salt tailings heap

Environmental impact studies including baseline studies are a necessary part of the design of these heaps. They include research into different site aspects, such as:

- stability of the heap
- stability of the supporting strata
- water protection (ground- and surface water, water quality and supply)
- dust emissions
- technical operations
- wildlife habitat
- rehabilitation and after-care
- control and monitoring systems.

It is necessary to ensure the **stability of the heap** to avoid possible movements of parts of the heap. The rock salt hardens rapidly, due to the sufficiently low moisture content of the stacked material. Therefore no significant erosion occurs and additional support around the heap is not necessary. In essence, the stability of the tailings heap is ensured by the application of fundamental civil engineering rules.

The **stability of the supporting strata** is controlled regularly by seismic monitoring (see monitoring and control systems, below), which search for and determine seismic, seismic-acoustic and geo-mechanic facts. Survey of pillars and the determination of the mineral compounds are used to calculate and observe the stability of the mined out rooms.

To ensure **water protection** the following items are taken into consideration:

- water balance (groundwater and surface water)
- detected aquifer strata
- watersheds
- water impermeability of supporting strata
- possibility of process water re-use
- water supply and distribution management
- quantity and management of accumulated drainage water
- salt quantities to be managed
- land requirements for stacking.

The interior of potash tailings heaps is impermeable to water. Water and generated saline solutions only flow down in an outer sphere around the inner impermeable (see). The toe of the heaps outside the impermeable core zone is carefully sealed and the solutions are collected.

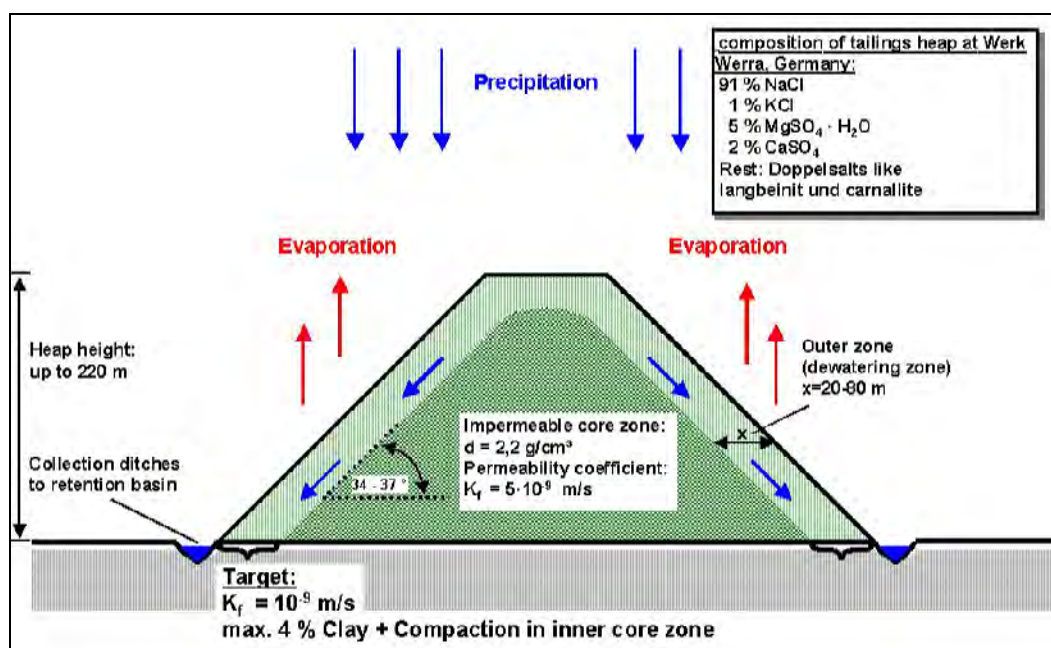

Figure 3.71: Schematic drawing of a tailings heap in German potash mining

After collecting the brine in the retention basin for intermediate storage and depending on the received water quality, the liquid is pumped to the river or into the ground (deep well discharge). In some cases the collected brines are re-used for processing (e.g. granulation, recycled processing brine). In general, only small amounts of collected brine are re-used.

Since the water flow from precipitation runs down the heap underneath the surface (see blue arrows in figure above) erosion at the surface does not occur. If possible, saline drainage from the heaps is kept separately from surface run-off. This is one way to minimise salt water contamination of soil and groundwater.

Another objective is to reduce land use by stacking the tailings to a maximum of height. In this operational technique (see below), the design used (conical/longitudinal heap) and the natural angle of repose are critical to obtain this.

The commonly applied technique uses conveyor-belts, continuously stacking the tailings on a heap, which is located near the processing plant. After the addition of a small amount of processing brine to the dry tailings from electrostatic separation the moisture of the stacked combined tailings results to the aimed 5 - 6 %. The stacked salt hardens immediately because of compaction and re-crystallisation.

The **technical operations** for stacking have been applied and optimised over more than 30 years.

The salt tailings are stacked using conveyor-belts and spreader systems, this allows steeper, higher stacking than wet stacking. Up to 1200 tonnes per hour solid tailings are stacked on one heap. These enormous amounts of material are piled near the processing plant, to minimise material transport over long distances or through communities.

The distribution of tailings on the heap is performed by combination of several conveyor-belts. Depending on the type of construction chosen, the discharging belt can be slewed, adjusted in height and, if necessary, be telescoped. A low discharge height is preferred. A last short underlying conveyor-belt, arranged below the main conveyor-belt is reversible (see figure below), which is particularly effective in avoiding dust in windy conditions. Dust control is not an issue with tailings from the wet separation processes as the residual moisture content of 5 - 10 % is sufficient to eliminate dust problems and to cause rapid consolidation with the tailings heap.



Figure 3.72: Photo of a conveyor belt with an underlying reverse belt

Processing, and therefore also tailings discharge, is carried out continuously day and night. The employees usually work in rotating shifts. Continuous working systems create less dust and noise and material transport over long distances is not required.

Possible effects on **wildlife**, both at present and for future, developments need to be examined, carefully considered and, as far as possible avoided during the operation.

The **controlling and monitoring regime** examines seismic events or subsidence of the surface as a result from mining activities. The stability of the supporting strata and underground mined rooms can be measured by seismic monitoring.

At the surface, different controlling and monitoring systems are applied e.g. for groundwater protection, determination and control discharging brine to the river and the mineral processing process, dust emissions, energy consumption, water supply etc.

Several locations have slope inclinometers which are used to study the deformation and stability of the tailings heap. Slope stability needs less monitoring on tailings heaps that are confined by natural topography.

3.3.3.2.2 Tailings piles

Commonly the tailings in **Canadian/US** plants are pumped as a slurry with 20 – 35 % solids to the top of the tailings piles in the tailings management area. The slurry flows down the gentle back slope of the pile with the slimes settling out at the toe. Low containment dykes are built to confine the discharge of brine to the surrounding area. At present, the tailings piles are generally about 50 m in height. Due to this low height compared to tailings heaps large areas are occupied by this tailings management method.

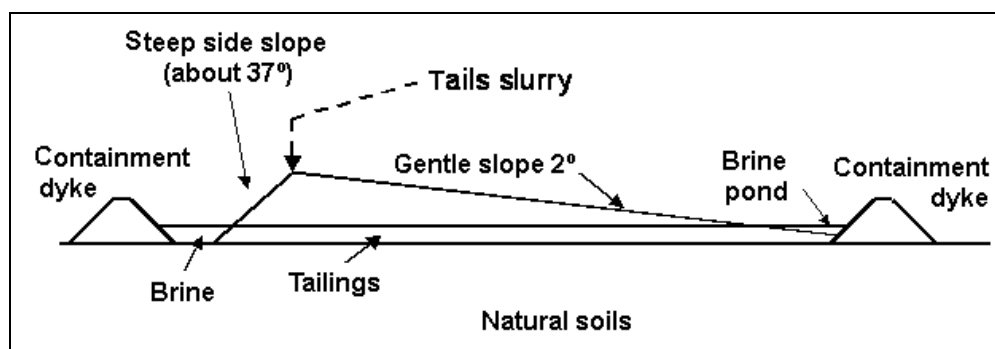

Figure 3.73: Typical cross-section of Canadian tailings piles (schematic)

3.3.3.2.3 Backfill

The second method of tailings management for solid tailings is **underground**. This method is applied in steeply dipping deposits in Northern Germany and in the potash mines of New Brunswick in Canada. Since the bulk density of the tailings is much lower than that of the original potash ore, only a part of the tailings can be accommodated by the space left after extraction of the crude salt.

In most potash plants, where the mineral is mined from flat deposits, backfill is not carried out for economic reasons.

A similar method, although less important for active European mines, is backfilling of tailings as a slurry. The tailings slurry is returned underground to fill up the potash cut-and-fill stopes, which are shaped as ‘domes’. However, the applicability of this option, amongst other reasons, depends on the existence of suitable geological formations (i.e. local steeply dipping deposit).

At one plant, Unterbreizbach in the Werra-region, brine is added to the tailings and the resulting slurry is pumped for backfill.

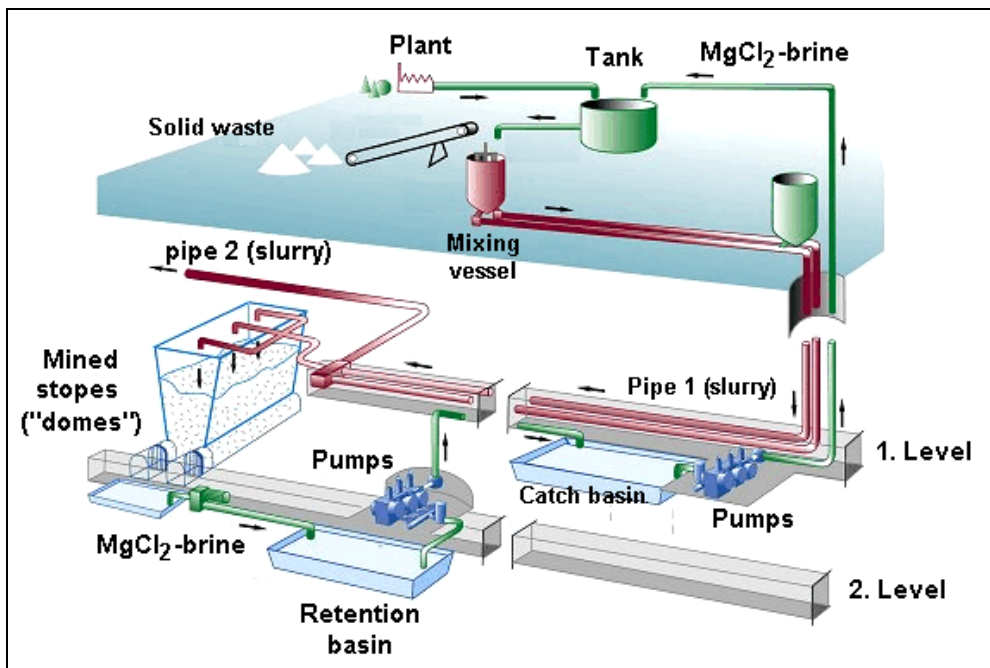

Figure 3.74: Backfill system of solid tailings (sodium chloride) at the plant Unterbreizbach, Germany

The Unterbreizbach plant differs from the other potash plants with flat deposits in various aspects:

Geology:

- the exploited seam Thuringia contains a very thick layer of carnallite above the hard salt seam. When the carnallite is mined, a series of empty "domes" are left.

Mineral processing:

- a combination of thermal dissolution process and the flotation of kieserite is used.

Tailings management:

- salt tailings (solid sodium chloride) from the flotation of kieserite are slurried with $MgCl_2$ -brine (salt-saturated) from the thermal dissolution process and pumped underground for backfill. The efficiency of the backfill system could be increased with a second pipe. The brine is recovered underground and pumped back to the surface for re-use.

In the UK, backfilling a proportion of the insoluble tailings as a slurry is being investigated. In this instance suitable geological conditions and appropriately configured mine workings dictate the volume available for placement. Similar trials in Spain failed because of the poor geological conditions.

3.3.3.2.4 Surface water discharge

At the operations in Germany and Catalonia brine from production, sometimes mixed with small amounts of salt water from the tailings heap, is collected in lined retention ponds from where the brine is discharged into surface water (e.g. river). The following figure shows one of these basins.



Figure 3.75: Water retention basin of German potash mine

In Germany the surface water discharge is combined with deep well discharge (see following section).

3.3.3.2.5 Deep well discharge

Pumping salt solutions back into the ground is possible if certain geological requirements are met. The geological formation required for this purpose must possess sufficient porosity and permeability, and must have no contact with formations that can be used for water supply.

In the German potash industry a combination of river and deep well discharge are used. As much water as possible is discarded into the river system. This is determined by the set threshold for chloride in the river taking into account the total discharge of all potash mines (see figure below). All excess water is pumped into the deep wells.

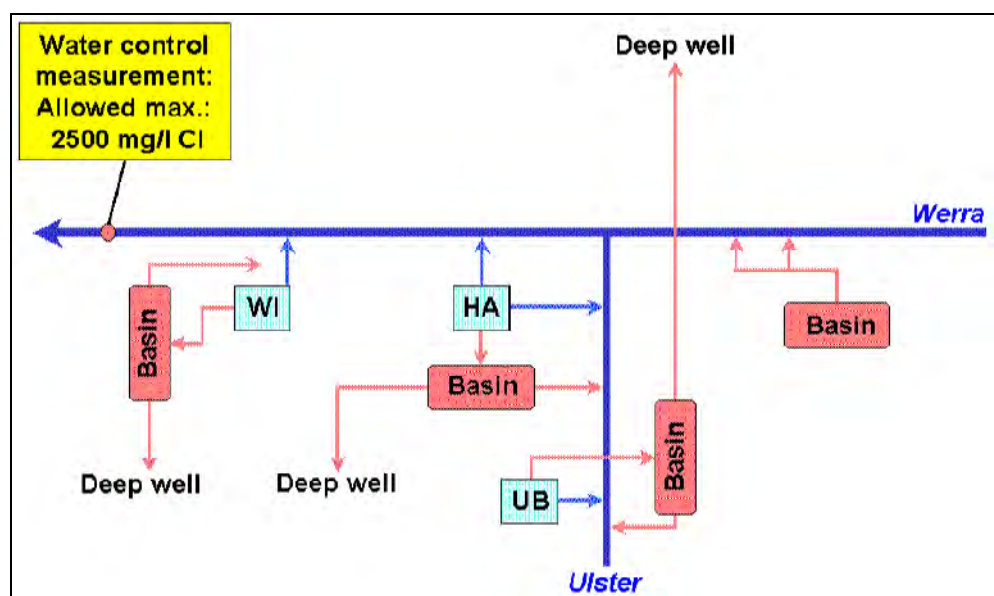

Figure 3.76: Management of three potash mines (WI, HA, UB) in the Werra area, Germany

3.3.3.2.6 Marine tailings management

At the Cleveland Potash operation, the ore is crushed and separated into the potash and tailings fractions. The tailings consist primarily of sodium chloride with small quantities of calcium sulphate and clay. These naturally occurring components are mixed with seawater and discharged into the North Sea through a long outfall pipeline.

Discharges into the North Sea are controlled by the OSPAR Commission (OSPARCOM, <http://www.ospar.org/eng/html/welcome.html>) and in this case, permitted by the UK regulatory body. Meaning that guidance concerning discharges into the North Sea developed by OSPARCOM was adopted by the UK government, which used the information for the permitting and monitoring requirements. Extensive baseline studies of the receiving body were conducted including bathymetry, benthic flora and fauna, water quality and the state of the important local fisheries. Continual monitoring of the quantity and quality of the discharge ensure that all parameters remain below consented values. Trace element analysis of the ores, products and effluents solids allow mass balances to provide checks on the flow and other monitoring data.

Continuing annual surveys of all the parameters are conducted by external experts to ensure that the effects of the discharge are determined and kept to a minimum. Audit samples are taken by the regulatory body for independent confirmation of the company results. Annual stakeholder meetings ensure that the results of the monitoring are communicated to all interested bodies and that they have the opportunity to influence the direction and content of future monitoring programmes.

3.3.3.3 Safety of the TMF and accident prevention

In the design of the TMFs, the following factors are considered:

- examination of ground stability
- examination of heap stability
- reduction of permeability of supporting strata if the average permeability coefficient exceeds e.g. 1×10^{-9} m/s, but site-specific and depending on the findings of the environmental impact assessment
- avoidance of artificial sealing layers with low shearing strength (has a negative effect on heap stability)
- application of moist tailings but with a moisture content below about 10 %.

Inspections of tailings heaps are routinely carried out by the operator. These include yearly surveillance of the heaps and observation of ditches and basins.

3.3.3.4 Closure and after-care

For **rehabilitation and after-care**, the description of the current state and future development of the facility including the tailings management area, and the closure plans of the mining operation are compiled in the form of a detailed plan.

After permitting of the monitoring and surveillance plan for closure, the operation facilities from the plant must be removed. However, the tailings heaps remain unchanged for a long period of time. A fund to cover future maintenance cost is financed from operational costs before closure.

3.3.4 Waste-rock management

Since potash mining is only carried out underground, the amounts of waste-rock arising are relatively small. The waste-rock remains underground in mined out areas of the mine. Usually this underground movement of waste-rock is referred to as 'stowing' or 'backfilling'.

3.3.5 Current emission and consumption levels

The quantities of emissions and effluents vary from mine to mine. They are also in some respect a function of natural conditions - the components of the exploited deposit and the mined minerals. Site-specific contributions - the form of mineralisation, the grade and liberation of the material, the mixture of mineral constituents in the mined deposit - are always unique. Depending on the mined ore and the desired products a process is chosen with solid and liquid tailings in varying proportions. Emissions and effluents are also a function of management and processing method.

3.3.5.1 Management of water and reagents

In general, it is possible to dissolve all solid tailings and discharge the resulting solution including insolubles into natural water systems (e.g. marine tailings management in UK).

Tailings heaps generate saline solutions when atmospheric precipitation dissolves the salt. This run-off water is collected in sealed ditches around the tailings heap and pumped into sealed retention basins. From these retention basins the saline water is discharged into natural flowing waters (e.g. rivers) or pumped into the ground (deep well tailings management).

The sealings of ditches and retention basins are inspected to avoid soil and groundwater salinisation. Furthermore, the water of groundwater wells in the surrounding of a tailings heap is periodically analysed to verify its quality.

No addition of water is applied for backfilling. For the backfill of slurries at the Unterbreizbach plant, processing brine is combined with solid tailings. The brine is used as a transportation medium only and is recycled. Processing brine is re-used for different applications in mineral processing to minimise the consumption of water.

In solid tailings no significant amounts of reagents are detectable. The only reagents used result from the electrostatic separation or the flotation process. These processing methods work with a low content of organic compounds (salicylic acid, fatty amines).

The main components of the liquid brine are inorganic salts, while the presence of organics (TOC) and heavy metals is negligible. This is a consequence of the deposit-formation by the evaporation of seawater about 250 million years ago.

3.3.5.2 Emissions to water

No noticeable amounts of trace elements, heavy metals or organic substances can be detected in the surface run-off from the heaps. The main components of surface run-off are salts such as sodium, magnesium, potassium and calcium chlorides and sulphates. The volume of surface run-off from the heap depends on land consumption, precipitation (per year) and the components of the salt tailings.

If the mineral kieserite ($\text{MgSO}_4 \cdot \text{H}_2\text{O}$) is one component of the mined salt, some kieserite will be in the tailings, too. Upon contact with rainwater, kieserite is hydrated and thus binds some of the rainfall. In consequence, the water binding capacity of a tailings heap from potash mining is strongly dependent on the specific minerals content.

A second important factor influencing the amount of surface run-off is the evaporation of water, which depends on several factors such as temperature, humidity, wind speed, colour of the tailings, sunshine intensity, etc.

3.4 Coal

In this section contributions about practices in Spain, the Ruhr, Saar and Ibbenbüren areas in Germany and the Ostrava and Karviná areas in the Czech Republic are included. Furthermore, comments from the UK have been added.

3.4.1 Mineralogy and mining techniques

All of Germany's hard coal resources are carboniferous in age. While the Saar and Ibbenbüren Basins represent remnants of larger coalfields, the Ruhr contains massive resources that dip towards the North Sea. Current working areas are located in depths ranging between 900 and 1500 m. Conditions in the Saar Basin are more complex than in the Ruhr.

The high-quality coke, gas and steam coals typically contain 6–9 % ash, and less than 1 % sulphur, although some seams require extensive washing before sale. The Niederberg mine and the Ibbenbüren deposit contain anthracite, which is coal with a fixed-carbon content between 92 % and 98 % (on a dry, mineral-matter-free basis).

Longwall faces of up to 400 m are now in service. The seams worked range in thickness from 1.0 - 4.0 m, with ploughs being used in the thinner seams and shearers in thicker applications.

Hard coal in the Czech Republic mainly occurs in the Upper Silesian Basin. The major fault, called the Orlova fault, divides the Czech part of the Upper Silesian Basin into the western section (the Ostrava part), which is older and of paralic character of sediments and coal seams, and the eastern section (the Karviná part), which exhibits a limnic character of the sediments as well as the coal. The western part consists of several thin coal seams of high grade coking coal, whereas the eastern part is characterised by abundant thick seams containing mixed coking coal and highly volatile steam coal. Some of the characteristics of hard coal include a carbon content of more than 73.4 %, less than 50 % volatile matter, and a dry (ash free) calorific value that exceeds 24 MJ/kg.

Mining in the Ostrava part of the basin has reached depths of about 1000 m, which together with complex and unfavourable mining and geological conditions makes economic mining extremely difficult. Consequently, the Ostrava mines have been gradually abandoned. The majority of mines in the eastern part have sufficient reserves which can be extracted at much lower costs. However, this coal is of low grade, as far as coking properties are concerned.

Relatively large reserves of coal were verified south of the original Upper Silesian basin, particularly near Frenštát pod Radhoštěm, where carboniferous sediments are buried under Miocene sediments and the Beskydy napes. Here, the coal can be extracted from depths of 800 to 1300 m under difficult geological and mining conditions. As the deposit is situated on the border of a protected landscape area, conflicts of interests may arise with Beskydy protection. [83, Kribek, 2002]

Most operations in Europe are based around longwall mining, using both shearers and ploughs for production. Most mines operate in several seams, with each unit operating several faces. In Germany, an increasing number of longwalls are controlled remotely from the surface, high levels of automation allowing saleable outputs of up to 20000 t/d per longwall [79, DSK, 2002], [83, Kribek, 2002].

In the UK (about 15 million tonnes/year) and Spain coal is also mined in open pit mines [84, IGME, 2002]

3.4.2 Mineral processing

In general, after the extraction step, particle size ranges from pieces of more than one metre in diameter to ultrafine grains ($<5\ \mu\text{m}$). In the three German coalfields of Ruhr, Saar and Ibbenbüren a wide range of coal qualities are mined, from anthracite at the Ibbenbüren colliery with 6 % volatile matters (VM) up to the high volatile bituminous coals of the Ensdorf underground mine with more than 36 % VM. In 2000, 12 coal processing plants with feed rates between 950 and 1700 t/h were in operation in these coalfields. [79, DSK, 2002].

In most cases the coarse ($>10\ \text{mm}$) and fine fraction ($0.5 - 10\ \text{mm}$), are separated in jigs. The finest fraction $<0.5\ \text{mm}$ is separated by flotation. In some cases, the fraction $>10/30\ \text{mm}$ is separated from heavier gangue by dense media separation.

A typical flow sheet can be seen in the following figure:

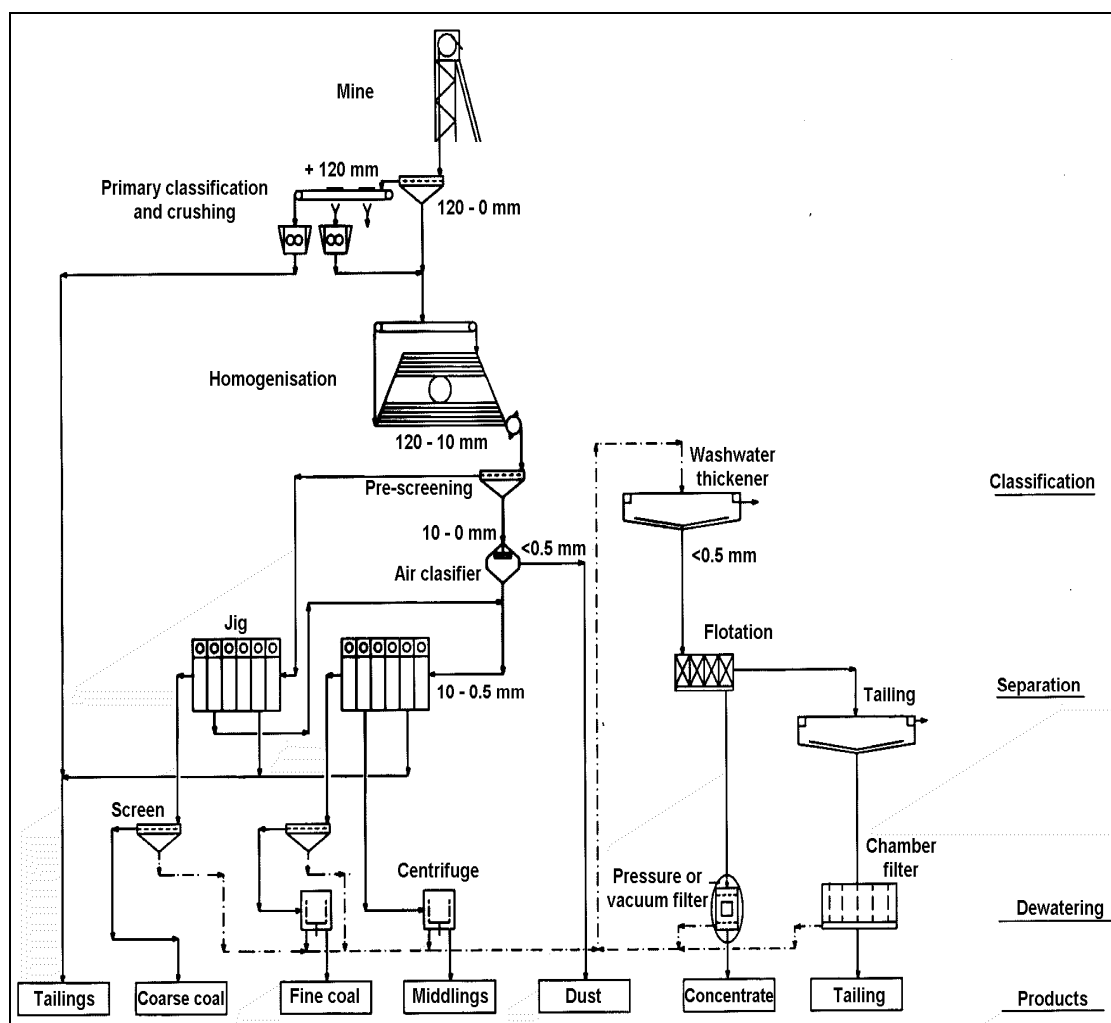

Figure 3.77: Standard flow sheet for coal mineral processing [79, DSK, 2002]

There is also one site that uses hydrocyclones instead of flotation of the fines [83, Kribek, 2002].

3.4.3 Tailings management

3.4.3.1 Characteristics of tailings

Typically tailings from the Ruhr, Saar and Ibbenbüren areas in Germany consist of 55 - 60 % clay shale, 30 - 40 % sandy clay shale and 5 - 15 % sandstone (Prosper-Haniel mine) [79, DSK, 2002]. Hard coal deposits can be influenced by maritime 'footprints', when formed as paralic basins, i.e. in a marginal marine environment. Freshwater coal basins formed in a river delta, so-called limnic basins, lack such evidence. Amongst environmentally relevant substances embedded in intermediary layers, chloride and pyrite are the most important ones. Precipitation coming into contact with tailings material takes up the salt and is acidified through sulphuric oxidation. As a consequence, the pH-value of a leachate or surface water so influenced decreases (ARD, see Section 2.7).

The fine flotation tailings from the Ruhr, Saar and Ibbenbüren coal mines <0.5 mm with a >77 % solids and a homogeneous mineralogical composition were tested in detail. In physical and chemical tests with long-term considerations including environmental impact assessment, it has been proven that flotation tailings can be used for the construction of surface liners even achieving the stringent requirements of the German Technical Standard for the construction of liners for landfills [80, DSK, 2002]. In laboratory tests pure flotation slurries from hard coal processing can reach k_f -coefficients of around 5×10^{-9} m/s. In-situ tests resulted in k_f -coefficients of $\sim 2 \times 10^{-7}$ m/s. These k_f -coefficients do not reach values required by TASI/LAGA standards for mineral liners ($k_f = 5 \times 10^{-10}$ m/s) and surface seals for landfill category I ($k = 5 \times 10^{-9}$ m/s). [79, DSK, 2002].

In the Ostrava and Karviná areas the coarse tailings are handled on heaps and the fines from flotation are sent to basins or ponds. In one case, a level of radioactivity of 75.5 ± 6.9 Bq/kg was measured in the tailings [83, Kribek, 2002].

Two other important aspects that need to be considered in the management of coal tailings are:

1. coal tailings can have increased contents of naturally occurring radioactive materials (NORM) due to their genuine strata
2. and may cause similar ARD problems as sulphide containing metal ores, because of the pyrite content of the coal.

3.4.3.2 Applied management methods

In the Ruhr, Saar and Ibbenbüren areas, a total of 23 tailings heaps and 7 tailings ponds are currently in operation [79, DSK, 2002]. Considerable amounts of tailings from coal mining have to be handled (about 33 million tonnes in the Ruhr, Saar and Ibbenbüren areas in 2000), since they can amount up to around 50 % of raw production. Principally, three management options are available:

- internal application, i.e. for underground backfill or construction projects linked to mining operations (e.g. compensation measures for mining-induced ground subsidence such as heightening of bridges or embankments)
- external application, i.e. commercial products, such as bulk mass material or base material in construction sector and civil engineering
- management on dumps and in ponds.

As a rough guide, around one quarter of all rock and tailings in the Ruhr, Saar and Ibbenbüren area is sold for internal and external purposes (see Section 4.5.3), whilst the remainder is managed on dumps (or heaps) and in ponds (see figure below).

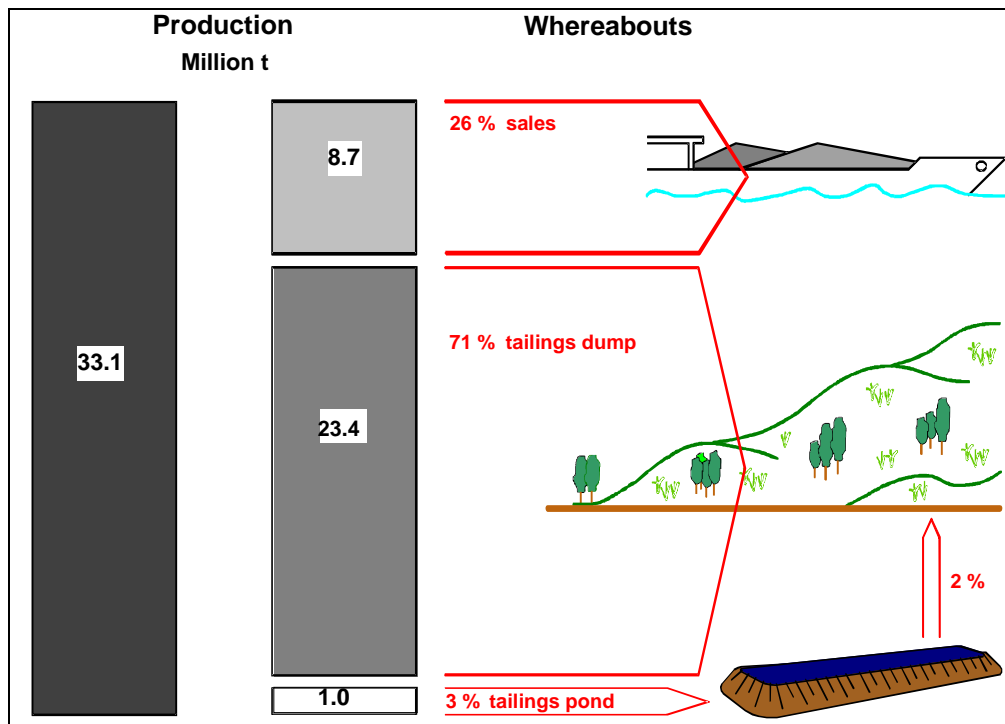

Figure 3.78: Tailings production and applied management methods in the Ruhr, Saar and Ibbenbüren areas in year 2000
[79, DSK, 2002]

At the Prosper-Haniel colliery, flotation tailings, which amount to around 13 to 18 % of total tailings, are transported with trucks on public roads [79, DSK, 2002].

Dewatering of fine tailings

Fine tailings <0.5 mm from flotation are thickened to 25 – 50 % solids. Provided sufficient area for final deposition in engineered ponds is available, fine tailings are directly transported via pipelines or trucks to these facilities. When the deposition of fine tailings on heaps is considered, e.g. for reasons of restricted area capacities, they have to be further dewatered in order to reach a sufficient structural stability.

In principle, three methods can be applied for further reducing the thickened tailings' water content:

- plate-and-frame filter presses, usually featuring more than 1000 m² of filter area (see Section 2.3.1.10)
- in those cases, where a higher water content is acceptable, solid bowl centrifuges (see also Section 2.3.1.10), e.g. used for dewatering flotation tailings
- sedimentation ponds (temporary stowing in ponds, i. e. around three years).

Dewatering by means of sedimentation ponds is carried out as follows: in phase one, the first pond is filled with thickened tailings which then start to settle. In phase two, the pond's content advances in settling, and in phase three, dried tailings are excavated either for deposition on heaps or for external use, e.g. as a construction material. Depending on climatic conditions, each phase can last up to one year. This in turn means, that a set of sedimentation ponds usually consists of three or more adjacent ponds.

In **Spanish coal mines** the coarse material is discarded onto heaps or used as backfill or as filling material in other areas. Flotation slurries are either:

- filtered and sold, or
- filtered and discarded with the coarse tailings, or
- discharged as slurries into tailings ponds.

[84, IGME, 2002]

3.4.3.2.1 Tailings heaps

As shown in the following figure in the year 2000 some 23.4 million tonnes of tailings, out of a total of 33.1 million tonnes, from the Ruhr, Saar and Ibbenbüren area were discarded onto tailings heaps.

The development over time of the tailings heap design in the Ruhr, Saar and Ibbenbüren areas is shown in the following figure.

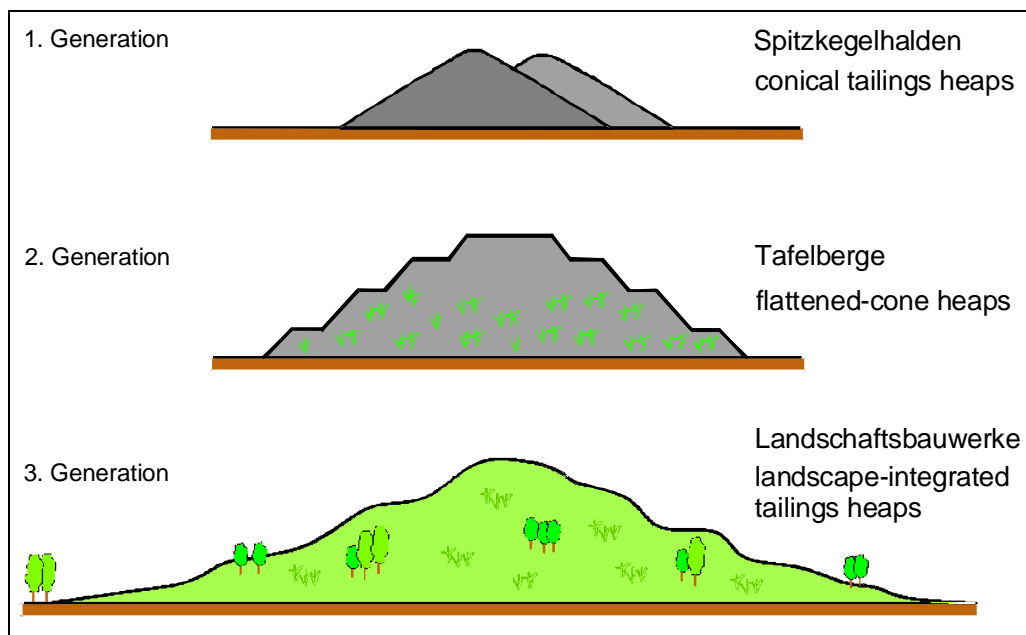

Figure 3.79: Development of tailings heap design in the Ruhr, Saar and Ibbenbüren areas [79, DSK, 2002]

Since the 1970s, the third generation of tailings dumps - so-called landscape-integrated earth constructions – has been established. Since then, these heaps have been accepted as essential landscape elements in the densely populated industrial regions of Ruhr and Saar owing to their high recreational and ecological value.

Principally, tailings are dumped onto the heaps in layers. The thickness of layers ranges from 0.5 to 4.0 m. Compaction is achieved by way of the trucks' rolling wheels and via vibration rollers to reduce, as much as possible, penetration by oxygen or precipitation into the dump body and, thus, minimising or even preventing the generation of ARD by pyrite oxidation.

As an example, the tailings heaps at the Prosper Haniel colliery in the Ruhr region are described:

Currently, operation of the Haniel tailings heap is in its final stage whilst dumping at the new 'Schöttelheide' heap commenced in 1998. Both facilities are so-called "third generation" tailings management facilities (see). The following table provides some information about the sizes of the two heaps.

	Haniel tailings heap	Schöttelheide tailings heap
Start of operations	1963	1998
Final area (ha)	108	66.7
Current area (ha)	108	10.0
Final elevation (m above ground)	126	62
Current elevation (m above ground)	99	5
Overall capacity (million m ³)	57.3	15.8
Residual capacity (million m ³)	6.3	15.2

Table 3.81: Tailings heaps at the Prosper Haniel colliery in the Ruhr region

Haniel tailings heap

The landscaping of the tailings heap’s top section included the construction of an amphitheatre on the top with a seating capacity for 750 persons. To date, this tailings heap represents a unique landscaped earth structure for the Ruhr district with a high cultural interest.

As opposed to the previous planning approval, the heap’s flanks hitherto planned for forestation are now solely sown. This, in turn, requires more than 20 ha of forestry compensation measures in the tailings heap’s vicinity.

Schöttelheide

For the permitting of the new Schöttelheide heap, the following information was collected:

- water management:
 - hydrologic study, including a groundwater model
 - drainage concept for the tailings heap’s surface
 - plan of a hydraulic/subsurface drainage system in the heap’s rim area
 - study of the hydrochemical processes in the drainage system, with respect to operational safety
 - compensation measures for balanced water management, retention and discharge of precipitation and leachate emanating from the tailings heap
- dumping:
 - dumping plan, including essential calculations on structural stability and subsidence
 - expert opinion on fire protection during the dumping phase
- emissions, immissions:
 - expert opinion on emissions and immissions of dust
 - expert evaluation on noise emissions and immissions
- climate:
 - expert opinion regarding possible effects on local climatic conditions in the tailings heap’s vicinity
- environmental impact study:
- regional development plans:
 - regional development plans for constructing a landscaped earth structure including modelling and recultivation plan
 - regional development plans for tailings truck transport track
- recreation:
 - control of recreational activities at the tailings heap location
- forestry:
 - transition of woodland.

At the beginning of preparatory works, recovery of the growable topsoil from the entire ground area was carried out.

For the Schöttelheide facility, the ring drainage method is applied (see Figure 4.16). Above the drainage system, a ditch runs along the dump's toe, which collects the surface run-off and transports it to the sedimentation ponds.

With the exception of the Schöttelheide facility's Western area, the underlying ground is impermeable. In a small area only, the ground moraine has hydrological 'windows'. These were sealed by means of compacted tailings material.

Surface run-off, seepage and groundwater are collected in a retention lagoon and discharged by means of a pressure pipeline to the Emscher River.

For documentation and evaluation of the effects resulting from the impacts on the groundwater cycle system, a comprehensive groundwater monitoring system is run, using precipitation measurements as well as surface water and groundwater surveillance. For this purpose, new observation wells were sunk. This set of measures allows the operator to discuss possible changes in groundwater composition with experts at any point and to rapidly initiate necessary measures.

The final heap will consist of two hill tops, with heights of 52 and 62 metres and will rise smoothly out of the surrounding woodlands. Only the lowermost slope is constructed with an incline of 1:2 in the bordering forest areas. The entire heap surface will be made accessible by a large trail system for recreational purposes, which is integrated into the heap's surroundings. The surface will be covered in part by topsoil; some parts, however, will remain 'black' by tailings material.

Planting will be carried out with autochthonous trees and shrubs, i.e. plants that can be found in the surrounding area. Recultivation is scheduled to commence as soon as possible and will progress successively.

For the sake of tipping and of other construction measures, e.g. a retention lagoon, approx. 15 hectares of woodland had to be cut. Around 46.6 hectares are reforested on the heap itself and additional silvicultural replacement measures have to be carried out in the surrounding area.

In the **UK** the tailings heaps are raised to a profile agreed with the competent authorities and are soiled and landscaped on completion. Surface run-off and discharge to watercourses are required to meet specified limits to minimise water quality impacts.

The coarse tailings, typically several hundred thousand tonnes per year, from coal mines in the **Ostrava and Karviná areas** are transported to the heap on conveyor belts or with trucks. In other cases they are used in the reclamation of old tailings basins or for landscaping of subsidence areas.

[83, Kribek, 2002]

3.4.3.2.2 Tailings basins/ponds

Often the fine slurry from flotation is pumped to sedimentation basins (e.g. caused by ground subsidence) or engineered ponds. The settling of tailings is occurs in several ponds/basins in series. The settled tailings are excavated periodically and refloated or sold. The clarified overflows are mostly recycled to the mineral processing plant [83, Kribek, 2002], [84, IGME, 2002].

Hahnwiese pond

The following text describes the experiences of operating a coal tailings pond in an area influenced by underground coal mining, both from the past and scheduled for the future.

The technical features are as follows:

- dam volume: 1.6 million m³
- largest height of dam above strata of the valley: 36 m
- length of dam across the crest: 636 m
- width of dam crest c. 40m, planned as base for future raises
- slopes: 1:2 (water side/upstream), 1:3 (air side/downstream)
- impounding volume: 2.2 million m³.

By calculating the ground movement elements in the planning area originating from past mining activities in two nearby mining districts, the effects had to be assumed as follows:

Ground movement element	Max. amount affecting the investigation area
Subsidence, m	~4 m at dam crest ~5.5.m at dam toe
Elongation (mm/m)	2 - 8 mm/m
Compression (mm/m)	2 - 4 mm/m in dam area

Table 3.82: Effects on TMF resulting from past mining activities

Additionally, the effects of future mining activities were taken into consideration.

Additional investigations within the planning process included:

- assessment of geologic subsurface conditions, including an analysis of existing fracture systems
- development of a groundwater model.

The dam is a staged dam with an upstream core and a filter drainage system. A cut-off trench system made up of interlocking sheet piling sealed at the joints ("sealing lip") represents the central sealing element. A grout curtain aims at preventing seepage underneath the dam. This system can cope well with deformations from mining-induced ground movements.

The dam concept for impounding structures exposed to mining-induced ground movements aims to allow for dangerous situations by installing a redundant control system. Measurements and observation programmes are important means for identifying irregularities at the impounding structure as well as during operations. Only by early identification, can directed measures be undertaken and major damages at the tailings pond system prevented. The concrete measures for improving situations detrimental to operational safety and stability are listed below.

Source of concern	Observation	Observed by or at	Resulting risk	Possible measures, follow-up
G + M	High ground water mobility in dam areas, in underground	Phreatic surface gauging points, hydraulic gauging station	Water losses from pond, erosion problems	Mud layers and/or injections, directional mud discharge, installation of mud discharge banks
G + M	Rise of water below the dam	Gauging stations in conjunction with drainage outflow	Scour, undermining, headward/regressive erosion	Sealing measures in underground, grout curtain, drainage checks
M	After core seal elongation: water rise in downstream dam side, saturation line	Gauging stations, drainage	Imperfection of core seal, erosion	If possible, resealing of core, eventually drainage cleaning, reinforcing the dam toe; layers of suitable material after rise of saturation line
G	Sedimentation in drainage pipes	Inspection with TV camera	Reduced water flow up to backwater, and thus affecting saturation line in the dam	Rinsing/cleaning, removing sediments by mechanical means or chemicals (e.g. acidic solution)
M	Subsidence, slumping, settlement of earth dam	Levelling, gauge measurements	Overflow at dam crest	Raising the dam, if necessary by extending internal core seal (incl. spillway)
M	Cleats, fissures, contraction joints in underground, in dam and in impoundment area	Visual observations, linear measurements, if necessary pond bed topographic survey	Scour, erosion	Filling or sealing with impervious material (e. g. loam)
M	Movement at abutment of spillway bridge	Visual observations, inclination measurement, position measurement	Loss of the spillway bridge's necessary support moment	Adaptation of bridge abutment
M	Movement at sockets of surplusing works	Special measurements at spillway/pipelines	Damages at sockets of spillway, water spill in pipeline trench, by-passing, headward/regressive erosion	Pipeline enhancing, if necessary by inserting inliner
M	Movement of spillway	Position/tilt measurement	Damages at link to pipeline, by-passing	Pipeline enhancing, if necessary by inliner
M	Movements at safety elements of tailings pipeline (stretcher)	Geometric control of stretcher	Leakage, headward/regressive erosion	Pipeline re-adjustment within stretcher limits
G	Precipitation in drainage outlet pipes	Inspection with TV camera	Reduction of tube diameter, blockage/backwater followed by erosion	Rinsing, mechanical cleaning
G + M	Indications of earth dam failure	Cracks in dam with quickly regressing erosion in conjunction with failure of sealing elements and drainage	Failure of dam, dam collapsing	Quick emergency relief via spillway (down to mud level)

Source of concern:
G: general, given by circumstances and operations
M: initiated by mining activities

Table 3.83: Tailings ponds influenced by mining-induced ground movements: Catalogue of potential risks and counter measures

3.4.3.3 Safety of the TMF and accident prevention

The Ostrava and Karviná area has a high seismic risk. Therefore seismic events are monitored [83, Kribek, 2002].

3.4.3.4 Site closure and after-care

Basically, five types of subsequent utilisation of tipping locations are common in the Ruhr, Saar and Ibbenbüren areas:

- forestal utilisation
- agricultural utilisation
- installations for leisure and recreational purposes
- secondary biotopes
- new industrial areas.

Land availability is very limited in the densely populated areas of the Ruhr and Saar coalfields. Areas under use for industrial purposes such as tailings management have to be reintegrated into the landscape as rapidly as possible.

The dumped tailings are sampled immediately after dumping, after the two years and after three years as far as required. Per each 2500 m² dump area, three samples from depths between 0 and 20 cm are taken and blended for a representative mixed sample. One sample is taken from a depth between 40 to 50 cm. Investigation of sample material includes pH-value determination to identify the acidification grade, total sulphur content (first sample) and total alkalinity content. For the second samples, the contents of P₂O₅, potassium, calcium and magnesium accessible to plants are determined. These results are taken into account for the soil cover and the revegetation. [79, DSK, 2002]

The subsequent utilisation of a tailings location results from a balanced consideration of the ecological, environmental, recreational, and economic aspects. As shown by the example of an amphitheatre (Bergtheater ("mountain theatre")) erected on the Haniel tailings heap, also cultural and sports aspects can be taken into account. Further examples include a large hall structure built on the Prosperstrasse tailings heap for downhill skiing, and the exposed location of an art monument, such as the Tetraeder ("tetrahedron") on the Beckstrasse landscaped earth structure.

Tailings management heaps in Germany's coal districts are often designed by landscape architects taking into account many ideas from the public.

Ongoing re-vegetation already during operation can be accelerated by different measures (see Section 4.3.6). After completion of the slope areas, the dump surface is sown with herbs seed. The herbs layer assists the heap's integration into the landscape, prevents erosion to a major extent and contributes to humus formation in the uppermost soil layer. Sizing and composition of seed mixture is dependent on local situation at individual dumps, on ground structure and on climatic influences. For wet sowing, water is used as carrier. Apart from the seed, fertiliser, soil amelioration agents and mulch, mixed with water, can also be applied.

Next step shrubs and trees are chosen only after evaluation of soil investigations. Selecting the plants and designing the planting scheme is done in close co-operation with forestry authorities. Plant material, in most cases, is taken from tree nurseries after a growing period of three years and planted with a narrow spacing between 1 m x 2 m to 1 m x 1 m.

Apart from the vegetation measures described above, by landscaping wet and dry bi-topes, small water courses as well as by creating areas left to natural succession, reclamation in the Ruhr, Saar and Ibbenbüren areas aims at creating the basis for a variety of flora and fauna habitats. [79, DSK, 2002]

A regional closure plan for the landscaping of mines and tailings management facilities in the Ostrava and Karviná area has been developed [83, Kribek, 2002].

3.4.4 Waste-rock management

The small amounts of waste-rock from underground operations are managed with the coarse tailings on the heaps.

Normally waste-rock arising from UK open pit mines is managed in temporary heaps in accordance with the technical requirements of the Health & Safety at Quarries:- Quarries Regulations 1999 – Approved Code of Practice. After removal of coal deposits, the waste-rock is then returned to the void and restored in accordance with the Planning Consent. Note that removal of the overburden from site is normally specifically prohibited by the Minerals Planning Authority

Waste-rock heaps are raised to a profile agreed with Mineral Planning Authorities in the UK and are soiled and landscaped on completion. Surface run-off and discharge to watercourses are required to meet specified limits to minimise water quality impacts.

3.4.5 Current emission and consumption levels

3.4.5.1 Management of water and reagents

The reagents used in the flotation of coal are mixtures, whose composition is only partially known. Also they are subject to the variations of any product from large scale refinery processes. In most cases mixtures of certain light oil fractions (collectors) or alcohols (frothers) together with emulsifiers are used. The flotation reagents used can contain traces of up to 50 different substances.

Whilst the salt and metal contents of coal and their leachability are well known, the content of organic chemicals is not so well documented. It is assumed that most contaminants will accumulate on the fine flotation tailings because of their large specific surface. Organic contaminants can originate from flotation reagents, as mentioned above, but also from hydraulic oils used in the mining operation.

Conventional methods of analysing the content of organic chemicals in the coal tailings are prone to errors, firstly because they are not suitable for such small concentrations but also because these methods dissolve naturally present hydrocarbons. However by means of radioactive tracing (i.e. by using ^{14}C) it can be shown that 1 kg of flotation tailings contains 120 mg of flotation reagents. This 'load' decreases with increasing ash contents of the tailings. [102, Diegel, 1994]

Although flotation reagents can accumulate on the surface of fine tailings, they remain immobilised. By applying long-term monitoring of surface run-off and percolation water from tailings heaps, it was demonstrated that no water contamination occurred due to the organic constituents of the flotation reagents. This is attributed to the tight binding of the organic components and to the compacted construction of the entire heap.

In German hard coal processing plants, flotation reagents based on hydrocarbons or alcohols are applied. For flocculation, reagents based on polyacrylates or polyacrylamides are used.

In addition to fine coal, the following lists some typical reagents used in coal mineral processing plants in the US:

- anionic or cationic flocculants
- lime
- natural and modified starches
- caustic starch
- sulphuric acid as pH adjuster
- alum (aluminium sulphate) as pH adjuster
- anhydrous ammonia.

[81, MSHA, 2002]

The clarified water from basins/ponds in the Ostrava and Karviná area are re-used in the mineral processing plant. Surplus water is discharged to surface water.

In flotation the agent Flotalex, which is a mixture of alcohols and mineral oil, is used in concentrations of 0.25 - 0.35 kg/t. As a flocculant an organic agent based on polyacrylamide is added.

[83, Kribek, 2002].

3.4.5.2 Emissions to air

To minimise dust and noise emissions from dumping tailings transport and spreading operations, ramps and working benches are transferred into the heap's inner area as far as possible and are shielded by embankments or hollows [79, DSK, 2002].

3.4.5.3 Emissions to water

Fine tailings from flotation are often managed in ponds and basins (e.g. Ostrava and Karviná area). Most of the clarified water is re-used in the mineral processing plants. However, in some cases surplus water is discharged to surface water. The amounts of discharge per year and the concentrations of emissions to surface water are shown in the following table.

Parameter	Units	Site				
		Paskov	CSA	Lazy	Dukla	CSM
Discharge	Mm ³	0.2	2.0	1.6	4.0	0.27
COD	mg/l	22208	16985	19.19	50.91	1920.2
BOD	mg/l		2333	4.34	6.54	20.65
Total soluble matter ¹	mg/l		1310			
Soluble inorganic salts ²	mg/l	687833				
non-soluble matter	mg/l	131667	7166	9.88	20.58	285.4
P total	mg/l	0.04				
N-NH ₄	mg/l	0.06	0.33	0.2	1.48	
Cl	mg/l		382.5			
SO ₄	mg/l	204.5	290.5			
PO ₄	mg/l		0.055			
Phenols	mg/l		0.1			
Fe	mg/l			0.17	0.22	
Mn	mg/l			0.09	0.14	
Hg	µg/l	0.9				
Cd	µg/l	0.5		<0.005	<0.005	
CN total	µg/l		6			
FN	mg/l		0.1			
pH			8	8	7.61	
1 total soluble (not suspended) matter (organic and inorganic) obtained from the sample after filtering and washing with distilled water						
2 soluble inorganic salts are determined after oxidation of the total soluble matter fraction with H ₂ O ₂ using the gravimetric method						

Table 3.84: Amount of discharge and concentrations of emissions from tailings ponds/basins in the Ostrava and Karviná area in 2000
[83, Kribek, 2002]

4 TECHNIQUES TO CONSIDER IN THE DETERMINATION OF BAT

This section presents a number of techniques for the prevention or reduction of emission and techniques to prevent or mitigate accidents in accordance with Section 6.3 of the Communication (COM (2000) 664). They are all currently available and applied.

4.1 General principles

If the total operation (mine, mineral processing plant, tailings and waste-rock management facilities) is designed concurrent with the tailings and waste-rock characteristics, taking into consideration the various chemical, physical and biological interactions due to the influence of the mining and the processing, then the tailings and waste-rock management environmental problems and costs can be reduced [21, Ritcey, 1989]. Also, the management of tailings and waste-rock, including water management, is usually an integral part of the entire life cycle of an operation, as fundamental as the extraction itself [45, Euromines, 2002].

The good management of tailings and waste-rock includes evaluating alternative options for:

- minimising the volume of tailings and waste-rock generated in the first place, by e.g. proper choice of mining method (open pit/underground, different underground mining methods)
- maximising opportunities for the alternative use of tailings and waste-rock, such as:
 - use as aggregate
 - use in the restoration of other mine sites
 - use in backfilling
- conditioning the tailings and waste-rock within the process to minimise any environmental or safety hazard, such as
 - de-pyritisation
 - addition of buffering material.

The most efficient way of reducing the amount of waste-rock is to extract the ore using underground mining instead of an open pit. This may have economical advantages over underground mining which completely changes what is ore and what is mineralisation. Consequently, it is often possible to utilise a much larger part of the orebody if open pit mining is applied.

However, as can be seen in Section 2.1, there are many aspects to consider when deciding on the applied mining method, e.g. open pit or underground mining or combinations of the two main alternatives. Waste-rock generation and management is one such aspect, whilst safety, working conditions, costs, optimisation of resource use, stability, the geometrical form of and depth to the ore-body etc. are examples of other aspects that also influence the decision when evaluating mining methods. Whichever mining method used, it is not in the interest of the operator to generate more waste-rock than necessary as the waste-rock management is resource consuming and constitutes a cost to the mining company, with very little or no benefit company itself.

Typically a **risk assessment** is applied, in order to assess the techniques used and to ensure they are the most appropriate to the specific circumstances, in terms of environmental, safety, technical and engineering aspects [45, Euromines, 2002]. In order to determine possible reasons for failure of a TMF and consequently to prevent any future collapses, the underlying question that has to be considered is “*what if*?”. This means several scenarios have to be considered and, based on the possible impact emergency or contingency response, plans have to be developed and, this is the essential part, known and understood by the staff.

Any tailings and waste-rock that cannot be avoided (due to accessibility to the orebody, safety reasons, etc.) and that are not suitable for alternative use (e.g. due to physical or chemical properties, transport costs, lack of market) require a suitable management strategy, which aims to assure the:

- safe, stable and effective management of tailings and waste-rock, with a minimised risk for accidental discharges into the environment in the short, medium and long term
- minimisation of quantity and toxicity of any contaminated release/seepage from the management facility
- progressive reduction of risk over time.

If more than one type of tailings and waste-rock are generated, segregating them according to type would facilitate any future recovery for alternative use or re-processing; however, blending the different types of tailings and/or waste-rock might become a good environmental management option if, for example, ARD minimisation could be achieved as a result.

4.2 Life-cycle management

An effective reduction of the risk of failure can only be achieved by a commitment of the operator to the adequate and enforced application of available engineering techniques to the design, operation and closure of TMFs over the entire period of their operating life.

4.2.1 Design phase

To achieve an environmentally responsible management of tailings and waste-rock, it is important that the operation is designed for closure from the very start and that adequate attention is given to quantification of the long-term environmental function and consequences of the TMF/WRMF. The following figure illustrates the information flow for a ‘design for closure’.

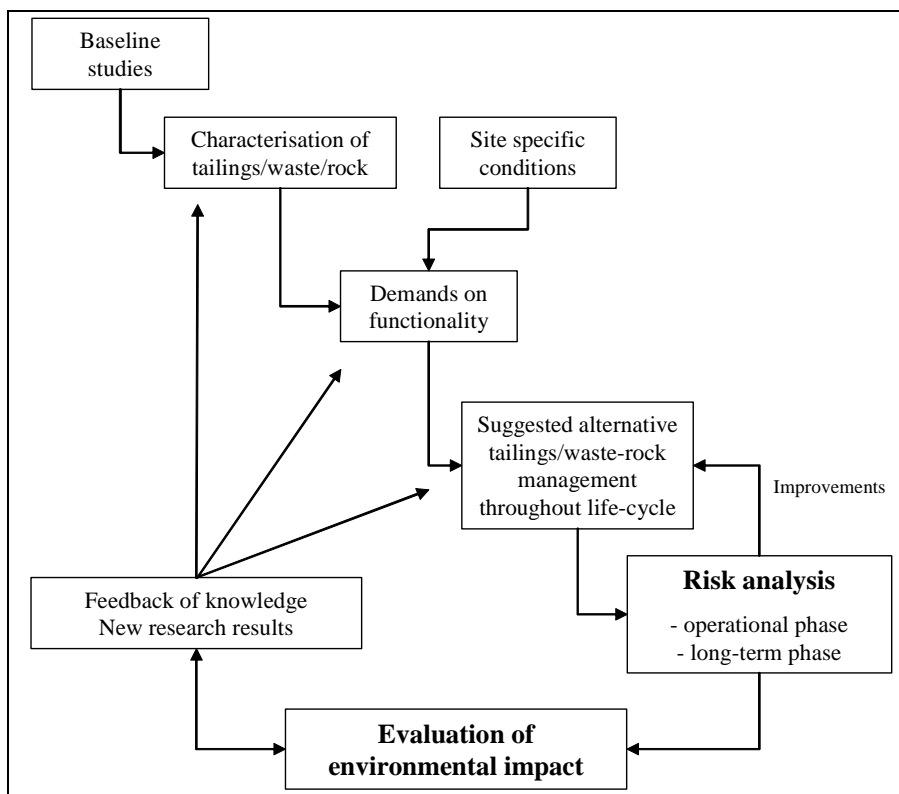

Figure 4.1: Illustration of the information flow for a ‘design for closure’

In this section considerations to be made in the design stage of a TMF or Waste-Rock Management Facility (WRMF) are described. Unless otherwise mentioned, this information is taken from the “Canadian guide to the management of tailings facilities”, [18, Mining Association of Canada, 1998] the “Framework for mining waste management” [45, Euromines, 2002] and oral contributions from TWG members.

4.2.1.1 Environmental baseline

The following is a summary of considerations that need to be taken into account when collecting and collating environmental baseline information for use in site selection, design and operation. This same baseline information is important for the development of closure plans and environmental monitoring programmes. More comprehensive lists may be found in specific environmental assessment guidelines.

- existing resources and use - existing resources and land uses within the tailings facility area and within the greater potential impact area need to be identified, in particular:
 - land and water use:
 - current and historical uses, including recreational, parks, human habitation, drinking water sources, archaeological considerations, mining, logging, farming, hunting and fishing
 - land tenure:
 - establishment of the right to acquire the necessary land for a TMF/WRMF
 - identification of land ownership and mineral rights
- baseline scientific data - baseline environmental scientific data relevant to the tailings project area need to be compiled, including:
 - physical:
 - climate (e.g. temperature, wind, precipitation, evaporation, return period floods, precipitation and run-off, air quality)
 - water (e.g. hydrology, watershed delineation and flow patterns, stream flow, lake bathymetry, subsurface hydrogeology and groundwater quality characteristics, surface water and sediment quality)
 - land forms
 - geology and geochemistry (e.g. surface deposits (type, location, density, permeability), stratigraphy, geomorphology, mineralogy, background elemental content)
 - topography (e.g. regional and detailed topographic maps, stereo aerial photography, satellite imagery)
 - soils (e.g. soils sampling and characterisation)
 - natural hazards (landslides, avalanches, seismic events, flood potential, frost action)
 - information concerning old mining sites nearby or below the TMF/WRMF
 - biological:
 - ecosystem identification
 - terrestrial survey (e.g. flora, natural pastures, fauna, endangered and threatened species, migratory species)
 - aquatic survey (benthos, macro-invertebrates, fish, aquatic plants)
- baseline socio-economic data - baseline socio-economic data relevant to the tailings project area need to be compiled, including:
 - historical background
 - population
 - regional economy (e.g. health, education, culture, demography)
 - identification of socio-economic issues which might arise for the tailings project.

A baseline study is usually established as part of the Environmental Impact Assessment (EIA).

This baseline investigation identifies the range of resources potentially at risk from a site and provides data describing these resources. It therefore provides measures from which the environmental impacts of a proposed development can be predicted and a database against which future changes in environmental quality can be judged [25, Lisheen, 1995]. A well performed baseline study also provides valuable data for the further design, layout and planning of the site.

It should be noted that the contents of a baseline study need to be established on a case-by-case basis. For instance, the scope depends on the type and scale of the proposed operation. The measurement of metal levels would probably not be relevant where metalliferous pollution can be ruled out from the outset.

Annex 3 shows an actual example of the scope of a recently performed baseline study.

4.2.1.2 Characterisation of tailings and waste-rock

Critical for the correct management of tailings and waste-rock is the proper characterisation of the waste. The characterisation results will determine how to manage the tailings and waste-rock during operation (deposition technique, protective measures etc), at closure (closure requirements and techniques) and in the post-closure phase (prediction of long-term behaviour).

Ideally the tailings and waste-rock are properly characterised before the start of the operation and the results fully incorporated into the design of the management facilities and the management plans. The characterisation includes physical and chemical characteristics which allow for the prediction of the short, medium and long-term dissolution/weathering characteristics (release of elements) as well as its geotechnical behaviour. In this work, which often is done in phases according to the results obtained, a series of methodologies are used ranging from relatively simple analysis, over more sophisticated leach experiments, to complex interpretation models and predictive models.

The following characterisations of ore, waste-rock (if used for dam construction or if managed within the same TMF), tailings and mineral processing are used for the design of a TMF/WRMF:

- ore and waste-rock characterisation:
 - amount of reserves
 - mineralogy
 - chemical properties
 - physical and engineering properties
 - acid generating potential
 - leachable contaminants
 - ore and changes of ore qualities during mine life
 - low-grade ore and mine rock quantity and schedule
 - kinetic testing
 - grain-size distribution
 - hydrological properties⁹
- tailings characterisation including the general description of physical and chemical characteristics, such as:
 - daily/yearly throughput and total quantity
 - size distribution

⁹ Mineralogy hydrologic properties are essential in performing geochemical - water quality, reactivity prediction, and mass loading-estimates (Walder et al. in prep., Environmental Geochemistry of Ore deposits, pp 250)

- solid or slurried tailings, pulp density (% solids)
 - density of solids
 - stability/plasticity
 - liquid phase chemistry
 - acid generating potential
 - geochemical characteristics (metal content, leaching behaviour)
 - pore water
 - consolidation behaviour
 - kinetic testing
 - mineralogy
 - hydrological properties¹⁰.
- mineral processing characteristics:
 - reagents used, their concentrations and quantities
 - water recirculation requirements
 - mineral processing plant treatment processes (e.g. cyanide destruction)
 - other inflows to tailings pond
 - pipes and associated structures
 - potential for pit and/or underground backfilling
 - ratio of management of tailings on surface to backfill.

[18, Mining Association of Canada, 1998]

The implementation of cost effective tailings and waste-rock management techniques requires the accurate prediction of the behaviour of these mineral residues in the natural environment. Many test procedures and predictive tools are in use internationally to characterise mining waste and to evaluate the potential for mine tailings and waste-rock to produce acidity and or metal contaminated effluents. The reliability of these tools depends on the consideration of many important chemical and mineralogical variables and factors under which the waste are disposed of and the development of fully documented standardised techniques for the characterisation of mine waste materials and other materials.

A summary of methodologies available for the geotechnical and geochemical characterisation of tailings and waste-rock is presented in Annex 4. In order to predict the probable drainage water quality and flow these characterisation results are combined with relevant data (i.e. physical information gathered for the baseline study) of a specific site. The interpretation takes into account the various scaling effects between the laboratory and the field. It is common to use computerised models to predict the behaviour of different management options.

4.2.1.3 TMF/WRMF studies and plans

The following is a summary of studies and plans which were developed in the design of an actual TMF WRMF to an adequate level of detail relevant for each stage (conceptual, preliminary and detailed design stages) and then maintained throughout the sites operation and closure:

- site selection documentation
- environmental impact assessment
- risk assessment
- emergency preparedness plan
- deposition plan
- water balance and management plan, and
- decommissioning and closure plan.

¹⁰ Mineralogy hydrologic properties are essential in performing geochemical - water quality, reactivity prediction, and mass loading-estimates (Walder et al. in prep., Environmental Geochemistry of Ore deposits, pp 250)

The plan contents listed above only represent the minimum requirements. In practice, on a case-by-case basis there may be additional aspects which need to be included.

[18, Mining Association of Canada, 1998]

The listed items are elaborated in more detail below.

Site selection

The operator selects a preferred site and prepares a documented rationale for its selection, including a discussion of the alternate sites studied and rejected. Furthermore public perception issues related to the project (i.e. internal and external stakeholder requirements) need to be identified. Issues to consider in site selection include:

- environmental considerations:
 - effluent treatment requirements
 - emissions to surface water
 - emissions to groundwater (hydrogeological containment)
 - historical use of the receiving watershed
 - background environmental conditions
 - impact on vegetation, wildlife and aquatic life
 - natural flora and fauna
 - archaeological considerations
 - potential emissions to air
 - aesthetic considerations
 - conceptual water balance

- planning considerations:
 - accessibility (road construction)
 - distance from the mineral processing plant
 - relative elevation from the mineral processing plant
 - distance from habitation and areas of human activity
 - topography
 - existing land and resource use
 - property ownership and mineral rights
 - transportation corridors, power lines, etc.
 - watershed and surface area considerations
 - volumetric capacity
 - pond volume/storage capacity ratio
 - geology, including potential ore bodies
 - construction material availability
 - conflict with mining activity
 - dam foundation conditions
 - basin foundation conditions
 - downstream hazards
 - hydrology
 - groundwater, contaminant seepage
 - potential impact area
 - human and environmental risk
 - water management scheme and preliminary water balance
 - operational plan
 - deposition plan
 - preliminary containment and water management structures
 - preliminary cost estimate based on preliminary considerations
 - conceptual risk assessment
 - health and safety assessment

- decommissioning/reclamation considerations:
 - flood routing requirements
 - revegetation potential
 - long-term physical and chemical stability
 - ease of establishing permanent drainage
 - reduction and/or control of acid drainage and other contaminants
 - dust control
 - long-term maintenance, monitoring and treatment requirements
- development, operating and closure cost considerations:
 - capital cost
 - cost of tailings transport
 - tailings facility operating and maintenance costs
 - closure costs
 - cost per tonne of ore processed.

Environmental impact assessment

In order to obtain stakeholder and regulatory acceptance for siting a new TMF/WRMF, it is often necessary and indeed a legal requirement to conduct an Environmental Impact Assessment (EIA). In EU Member States, the EIA is regulated by Council Directive 97/11/EC of 3 March 1997¹¹ amending Directive 85/337/EEC of 27 June 1985 on the assessment of the effects of certain public and private projects on the environment¹². The Directive allows Member States to decide for certain activities whether they need an EIA or not. However according to Annex I of the Directive quarries and open pit mines where the surface of the site exceeds 25 hectares, are obliged to do an EIA. Annex II of the Directive states that it is up to Member States to decide if underground mines and smaller quarries and open pits are subject to an EIA. The information the operator has to supply in an EIA is described in Annex IV of the EIA Directive. The website <http://europa.eu.int/comm/environment/eia/home.htm> provides plenty of information and guidance regarding EIAs.

Baseline studies determine what the existing conditions are before a new site goes into operation. They therefore provide the basis for any impact identification and assessment that might follow. The detailed extent of the baseline study and environmental impact assessment is usually defined by a scoping assessment conducted by the permitting authority. It can also sometimes be supplemented by approaching other stakeholders.

The environmental impact assessment process requires integration of knowledge about the project as it is being designed, the natural and social environments in which the project is situated, and community and stakeholder concerns. At the environmental impact assessment stage, the tailings facilities will usually be components of a larger, integrated project. The following is a summary of some significant aspects related to tailings, and which need to be addressed in an environmental impact assessment:

- environmental baseline
- mineral processing plant tailings aspects
- tailings and waste-rock facility site selection, with a clearly documented rationale for the selected site
- conceptual tailings and waste-rock facility design.

¹¹ OJ N° L 073 of 14 March 1997

¹² OJ N° L 175 of 05 July 1985

The environmental impact assessment addresses the projected impacts of the tailings and/or waste-rock facility on the environment, including:

- physical impacts
- physiography
- climate and possible effects of climate change
- air quality
- noise
- hydrology
- hydrogeology
- water quality
- biological impacts
- aquatic life
- vegetation
- wildlife
- archaeological impacts
- socio-economic impacts
- land-use impacts.

Risk assessment

In many parts of Chapter 3 it can be seen that the techniques applied to prevent accidents are actually based on risk management. Furthermore the amendment of the Seveso II Directive¹³ and the initiative on the management of waste from the extractive industry, will make a risk assessment a legal requirement of some or all tailings and waste-rock management facilities in the near future.

Overall risk management involves an examination of the individual risks of operations, linked closely to the tailings and waste-rock characteristics, the physical and chemical features, as well as other key features such as the nature of the ore and the site characteristics. The most cost-effective methodologies can then be selected to reduce the risk of harm to an acceptable level, in the particular circumstances. As described in Section 4.2.3.1, in some cases the TMFs or WRMFs are classified, for example, according to the consequences of a possible dam failure.

Risk assessment includes not only the identification of the 'risk sources' but also the evaluation of the probabilities of actual failure, as well as the severity of the likely consequences to follow from such a failure. It is clear from this that the risk assessment must provide the basis for the development of any risk management strategy and all its consequent action plans and procedures (including communication, contingency, mitigation and emergency response).

The risk should be assessed (and managed) through each phase of the life cycle of the TMF/WRMF. However, the intensity of the assessment will vary at different stages, depending on the objectives of the review, the complexity of the pertinent issue and the extent of information available.

Generally risk assessment includes the following considerations:

Scope and purpose of assessment

At this stage all stakeholders in the risk assessment are identified.

¹³ Council Directive 96/82/EC of 9 December 1996 on the control of major-accident hazards involving dangerous substances

Risk assessment team

An experienced, multi-disciplinary risk assessment team is required to determine potential failure modes, probabilities and the consequences of any failure. The team typically includes the TMF/WRMF designer, the construction contractor, operators, environmental and management staff, and, in cases of detailed assessments, a risk assessment specialist. Consequence evaluation involves environmental staff and specialists, including, in some cases, health experts and cost engineers. Involving operating staff is critical for a risk assessment of an existing tailings/waste-rock facility, in order to incorporate their knowledge and experience of the facility.

Evaluation criteria

Criteria have to be developed to guide the evaluation of findings and to establish levels of acceptable or unacceptable risk. High probability, high consequence failure modes are obviously of concern, but low probability, high consequence modes may also require examination. Potential human health and safety, environmental impact or business (e.g. downtime, reputation, property damage) consequences are considered.

Methodology

Risk assessment can be qualitative (subjective ratings of probability, consequence and overall risk) or quantitative (numeric values of probability and cost values for consequences). A simple qualitative assessment is appropriate to evaluate a number of potential TMF/WRMF sites, whereas a detailed quantitative assessment is more appropriate for a proposed major modification to an existing facility.

Commonly practised methodologies for risk assessment include:

- process/system checklists
- system design models
- safety reviews
- relative ranking
- preliminary hazard analyses
- "what-if" analyses
- hazard and operability (HAZOP) studies
- failure modes, effects (and criticality) analyses - FMEA, FMECA
- probabilistic simulation analyses
- fault-tree analyses
- event-tree analyses
- cause-consequence analyses and human error analyses.

Potential triggers and failure modes

- dam overtopping from:
 - a landslide into reservoir generates a wave which overtops the dam
 - wave action overtopping the dam
 - perimeter bypass system fails and water enters the reservoir, exceeding the capacity of the spillway or storage, or an external stream diversion fails and water enters reservoir
 - pond allowed to reach crest of dam
 - discharge from top end of pond to save dam height
 - outlet structures becomes blocked
 - precipitation exceeds storage capacity
 - water balance not maintained
- dam instability (upstream or downstream), from:
 - seepage causes piping and removes dam material (i.e. filter failure)
 - seepage raises pore pressures and causes shallow or shallow instability
 - non-seismic liquefaction of dam due to straining or increased pore pressures
 - seismic activity causing:
 - liquefaction of dams

- liquefaction of tailings leading to erosion
- liquefaction of tailings leading to an horizontal thrust on the dam
- deformation of dams
- seepage failure raises pore pressures and triggers a slide
- construction pore pressures rise and accuse the slope to move
- saturation of uncompacted fill either by first fill or rain or snow encapsulated in dam fill melts, dam settles, overtops
- uncontrolled toe erosion retrogresses
- dam face erodes due to uncontrolled precipitation or snow melt
- foundation instability:
 - Karst collapses beneath dam/heap
 - collapse due to mine subsidence allowing the tailings to escape into mine or void
 - sliding on weak soil or liner interface
 - compression of weak soils leading to cracking of the dam
 - construction pore pressures rise and cause the foundations to move
 - seepage through a poor membrane or pervious soils into groundwater system, bypassing seepage recovery systems
 - seismic liquefaction of foundations; seismic deformation of foundations; non-seismic liquefaction of foundations
- structural failures:
 - piping around a culvert or decant pipe, decant tower fails
 - pumps fail due to loss of power
 - pipeline or conduit fails
 - landslide blocks spillway
 - ice blocks spillway
- power failure.

Probability of failure

The probability of failure for each potential failure mode is based on past experience at the facility, experience of similar facilities, engineering analyses and professional judgement.

Consequences of failure

The consequences of failure for each potential failure mode are estimated, including consideration of the impacts on the health and safety of workers, contractors and general public; environmental impacts including consideration of the assimilative capacity and environmental sensitivity of the site; and the business impacts.

Reporting

The results of risk assessments are presented and summarised in a clear manner for both operating and management personnel. It is essential that this information is well presented so that it can be well understood by all relevant staff.

Risk Management

The risk assessment leads to a list of identified and assessed risks. The risk assessment is followed by the planning of risk reduction measures. In principle, a risk can be managed in two ways: (1) measures to reduce the probability of a failure, or (2) measures to reduce the consequences of a potential failure. An evaluation of possible risk reduction measures are conducted and a plan, including timelines and responsibilities is developed. An important component in minimising the consequences of a failure will be the development of an emergency preparedness plan.

Emergency preparedness plan

It is standard practice to be ready for emergencies and to have appropriate contingency and emergency preparedness plans in place. Emergency preparedness includes preparation both for on-site incidents and for incidents having off-site implications, including dam breaches. Contingency and emergency preparedness plans should be reviewed on a periodic basis, tested, and widely distributed within an organisation and to potentially affected external stakeholders.

The site's emergency preparedness plan usually integrates the tailings facility aspects into the overall site emergency preparedness plan and includes, but is not limited to, the following:

- identification of planning co-ordinator, team and organisational structure
- identification of emergency organisation, roles and responsibilities
- identification of legal requirements, codes of practice, notification and reporting obligations
- identification of available resources
- mutual aid agreements
- public relations plan
- telephone lists
- establishment of communication system for notifications and for post-notification purposes
- risk analysis for on-site and off-site effects
- maps and tables for both physical and environmental releases (including facility failure)
- basis for activation of emergency plan and emergency decision making
- training of personnel
- investigation and evaluation of incidents and accidents
- restoration of safe operating conditions.

For establishments to which Article 9 of the Seveso II Directive¹⁴ applies, i.e. that are obliged to prepare a safety report, the operator is also obliged to draw up an internal emergency plan for measures to be taken inside the establishment for a major accident.

According to the Directive, the emergency plans must be established with the objectives of:

- containing and controlling incidents so as to minimise their effects, and to limit damage to man, the environment and property
- implementing the measures necessary to protect man and the environment from the effects of major accidents
- communicating the necessary information to the public and to the services or authorities concerned in the area
- providing for the restoration and clean-up of the environment following a major accident.

Emergency plans shall contain the information set out in Annex IV of the Seveso II Directive.

The United Nations Environment Programme (UNEP) publication “APELL for Mining” provides further guidance on emergency preparedness (http://www.uneptie.org/pc/apell/publications/publication_pages/mining.html).

Two important requirements of the Seveso II legislation relate to the establishment of on- and off-site emergency plans and the provision of information to the public. Emergency plans are a preparedness measure that aims at controlling and containing incidents so as to minimise the effects, and to limit damage to the employees inside and the population outside the establishment, as well as to limit damage to property and the environment. Information to the public consists of active information about the planned requisite behaviour in the event of an accident and of passive information that the interested public can obtain from the plant operator and/or the public authorities upon request. Although Seveso II and APELL are different

¹⁴ Council Directive 96/82/EC of 9 December 1996 on the control of major-accident hazards involving dangerous substances, OJ L 10 of 14 January 1997, pages 13-33

instruments and represent different approaches, they are complementary. APELL can be seen as a tool for the practical implementation of some core requirements of the Seveso II Directive. [135, Wettig, 2003]

Deposition plan

A tailings/waste-rock deposition plan is developed for the expected mine life. Deposition plans can allow for the staging of TMF/WRMF lifts and raises over the life of the mine to accommodate the long-term storage of tailings and/or waste-rock, to maintain adequate solids storage capacity, and to allow the adequate polishing of free water during operation of the mine.

An appropriate consideration for future expansion requirements and/or capacity should be considered in the plan. The deposition plan development requires information on the tailings quantity and density; the water content and production information, estimated from the process/mineral processing plant; the water balance; and should include provisions for estimating uncertainty and contingencies. The basic parameters are validated and updated on a periodic or regular basis.

Equally important are the construction specifications and the recording in detail of the built and extended facility, which will need geodetic surveying at regular intervals.

Water balance and water management plan

The water issue is considered in conjunction with the mine, so that an integrated water management is achieved. A water management plan develops site-specific standards, targets, operational or contingency plans and procedures (as appropriate) for all of the following:

- statutory requirements
- risk management
- monitoring of hydrological processes
- operational monitoring
- emergency monitoring
- water supply
- soil erosion
- water quality
- computer models
- performance indicators, and
- training and research.

[97, Environment Australia, 2002]

Hydrology

Hydrology data, including the delineation of tailings site catchment area(s) and all potential water sources, both natural and process related, are used in the development of a water/contaminant balance and the design of the tailings facility components. Design parameters are first established and documented, then actual experience are monitored to identify variances, validate projections and to anticipate potential problems.

Design flood

The appropriate probable maximum flood (PMF) is identified, with reference to current design standards and in consultation with regulatory agencies. Design flood considerations should be consistently applied in all stages of the life cycle. Storage requirements, and the operating and spillway design all need to be based on the hydrology of the watershed.

Water balance

A water balance study is performed. A specification of the requirements for ongoing data collection for the mineral processing plant and TMF water balance calibration purposes needs to be developed.

Surface water/groundwater management plan

Completion of a water management plan detailing appropriate designs and strategies, when required, needs to cover:

- seepage collection
- reclaim/pump-back systems
- treatment/discharge systems, including all water conveyance systems
- water retention and discharge strategy, including operating parameters.

Emissions balance and release

The emissions balance provides estimates of emissions to land, air and groundwater. A plan is developed to minimise emissions.

Effluent criteria

Development of effluent criteria for the TMF/WRMF, with reference to regulatory requirements and operating licences and permits, is required and needs to cover:

- dissolved and suspended matter
- suspended solids
- effluent quality
- periods of discharge
- bacterial and biological levels
- toxicity.

[18, Mining Association of Canada, 1998]

Decommissioning and closure plan

Closure plans and performance criteria are developed in the early stages of facility design, and then verified and updated periodically through the operating life of the facility in preparation for final decommissioning and closure. Closure is usually covered by regulations, and the following list gives some general considerations applicable to the development of closure plans. In some circumstances closure has to be followed by long-term after-care. This requires similar plans and controls as for closure.

Elements of a closure plan

- determination of background data, including:
 - history of site
 - infrastructure
 - process flow controls
 - system operations
 - mineralogy
 - topography
- hydrology/water management
- hydrogeology
- soil capability
- revegetation
- impact assessment
- long-term maintenance
- geotechnics
- chemistry and geochemistry
- monitoring programme
- effluent management or treatment requirements, where relevant
- communications
- financial assurance
- stakeholder consultation

- potential end land use; and closure technology (i.e. dry or wet cover, flooded, wetlands, perpetual treatment, vegetative cover).

Aspects of TMF/WRMF stability relevant for closure plan considerations:

Closure plans require a thorough re-assessment of the facility and its stability under closure conditions. All aspects of the facility, and of the physical and chemical stability need to be reviewed. In particular, the actual performance of the facility in service, including:

- deformation
- seepage
- foundation and sidewalls

are checked against design projections, as well as against projected post-closure conditions. Design loads might be different after decommissioning and closure.

Structural monitoring and inspections are continued for all facilities until they are decommissioned, and thereafter as appropriate. Identification and delineation of any requirements for continuing inspection and/or the monitoring of remaining structures after closure is necessary.

Action plans are prepared to deal with shortcomings in closure quality and/or difficulties in complying with closure specifications. Examination of the consequences of closure of the facilities on emergency preparedness procedures, and the updating of these plans as appropriate, is also desirable. Continuing availability of design, construction and operating records after closure for structures remaining in place has to be ensured.

4.2.1.4 TMF/WRMF and associated structures design

The following list may not apply to all sites or to all situations and therefore it is up to the operator and the permitting authority to decide which aspects apply. Site-specific conditions may require the use of different or additional criteria. Criteria for the operational phase as well as the after closure phase are covered. Different criteria resulting in different design values may apply during the operational and the long-term phases.

Information relating to the TMF/WRMF site is compiled from literature survey and field/laboratory investigation programmes.

Hydrology and hydrogeology

- hydrological and hydrogeology studies
- water balance, water quality
- design flood
- freeboard requirements
- drought design (i.e. water cover requirement)
- catchment run-off and diversion arrangements
- deposition plan
- erosion management plan.

Foundations, geology and geotechnical engineering

- geomorphology
- regional and local geology, faults
- stratigraphy
- bedrock and soil characteristics
- geotechnical information, including:
 - compressibility
 - shear strength

- angle of friction
- grain size
- density
- plasticity
- fractures
- liquefaction potential
- permeability
- erosion potential
- hydraulic fracture.

Construction materials

The availability of naturally occurring construction materials is assessed, as is the engineering characteristics of these potential construction materials, tailings, grout/concrete or other potential liner materials (both natural and synthetic), i.e. with regards to:

- grain size
- density
- volume
- shear strength
- permeability
- acid generating potential
- chemical reactivity (acid generating potential, reaction with pond water, thiosalt generating potential)
- wind and water erosion potential.

Potential detrimental effects of tailings and/or process water on construction materials are determined. Environmental impacts, stability and rehabilitation requirements related to the use of any construction materials are considered at this stage.

Topography

This cover regional and topographical mapping and air photos.

Special environmental considerations

Seismic risk; seismic attenuation of foundation strata and construction materials; liquefaction potential of foundation strata and construction materials; climatic conditions, need to be assessed, including:

- extreme values to be expected
- wind and wave actions
- permafrost effects
- frost.

Seepage

The maximum allowable seepage objectives for environmental and structural requirements are determined. Requirements for pervious vs. impervious materials and construction methods are identified and a seepage management plan is developed.

Closure considerations

The choice, or probable choice, of closure method of a TMF/WRMF may have an impact on the design and should therefore be considered in the design phase.

Required design parameters

- facility classification (if existing under local jurisdiction)
- stability
- earthquake criteria
- safety factors

- design permeabilities
- acid rock drainage
- wildlife
- dust
- closure considerations.

These parameters are outlined in the following paragraphs.

Stability

The stability of the foundation, facility and associated structures under conditions covering construction, operations and closure; and under static and dynamic conditions, including consideration of wave, frost/ice action and rapid drawdown (for a pond) must be analysed. Density and compaction targets are established.

Foundation preparation

The requirements for the preparation of the TMF/WRMF foundations prior to construction are determined, including consideration of:

- vegetation removal, including merchantable timber
- excavation of organic soils
- cut-off walls
- groundwater control and containment
- bedrock cleaning and slush grouting
- high-pressure grouting
- diversion wells
- diversion channels
- dewatering requirements
- stability
- constructability
- other special construction requirements.

Seepage analysis and management

The requirement for seepage control are assessed, including into groundwater, and consideration of the water chemistry and acid generating potential. The implementation of appropriate measures, are also planned for, such as:

- filter design
- cut-off trench
- grout curtain
- ditching
- low permeability core
- interception wells.

Associated structures

The following options are designed, as required:

- spillways
- towers
- pipelines (e.g. vacuum breakers, secondary containment)
- maximum flood-handling requirements
- gates and valves
- siphons
- pumps
- natural hazards handling requirements (e.g. debris, beavers, rabbits, ice blockage).

TMF/WRMF design

- type of facility (e.g. heap, dam (type of dam))
- design philosophy
- criteria for major elements.

TMF/WRMF construction plan

A plan for executing the initial TMF/WRMF construction and subsequent lifts, including sequencing and requirements for stability monitoring are developed. A construction methodology, schedule and anticipated costs are established. Potential environmental impacts due to construction of the proposed design are determined.

TMF/WRMF monitoring systems

- piezometers
- inclinometers
- settlements gauges
- seepage flow monitoring
- temperature (permafrost, frost penetration, heating)
- surveillance methods.

Failure mode analysis

Potential TMF/WRMF failure modes are analysed: during construction, during operation, in its final condition and after closure.

4.2.1.5 Control and monitoring

A comprehensive control and monitoring plan needs to be developed, and should cover the full site life cycle with regard to control of the emissions and impacts, and monitoring of the same.

Quality assurance/quality control (QA/QC) plan

It is good practice to maintain and have available throughout the construction, operation and closure phases:

- construction drawings and as-built construction records, including revisions
- test results
- meeting minutes
- construction photographs
- monitoring notes.

Construction control

Typical components of a construction management system include:

- planning and scheduling
- survey control (layout, as-built records)
- grouting monitoring
- foundation preparation monitoring
- material quality control
- compaction control
- instrumentation monitoring and data synthesis
- record keeping
- construction safety
- construction environmental criteria.

Dust control

It is necessary to minimise dust releases from the tailings facility. This may involve keeping the tailings wet and/or using short- or long-term chemical or organic covers.

Inspection of tailings management facilities

- performance monitoring - visual inspection – with high frequency
- groundwater pressure (pore water pressure)
- seepage
- deformation (settlement and stability)
- weather influence
- seismic events (after the fact)
- special inspection programmes after major events (earthquakes, hurricanes, spring break-up, floods)

- Indicators of instability:
 - ‘soft zones’ and ‘boils’ along the toe
 - dirty sediment in seepage
 - increased seepage rates
 - new areas of seepage
 - longitudinal and transverse cracking
 - settlement.

- Areas requiring special attention:
 - spillways
 - decant structures
 - drain and pressure relief wells
 - concrete structures
 - pipes and conduits through dams
 - riprap areas
 - siphons
 - weirs
 - trees and animal dens.

Stability monitoring programme plans

- location of control stations
- scheduling (control periods and inspections)
- type of monitoring (visual inspections, measures and parameters)
- appropriate level of instrumentation (e.g. piezometers) with clearly identified purpose
- inspection methods, data compilation and evaluation
- persons responsible for monitoring
- data storage and reporting systems
- criteria to assess monitoring programme.

Water quality plan

- hydrology:
 - severe storm events and drought events
 - necessary information and parameters for water management activities
 - criteria to manage water levels within safe limits, including any required daily or seasonal water level control

- water control, ensures that:
 - safe water management is carried out within the confines of the system
 - damage to all structures is prevented/controlled/repaired
 - reviews and revision are carried out as required after changes in design or methods, during and after construction programme, when the pond level exceeds specified critical elevations, and after major storm or spring melt events must be performed.

- Perimeter seepage
 - evaluate potential for seepage from the tailings area
 - define levels and characteristics of acceptable seepage
 - prepare action plans to deal with deviations from design seepage
 - measure performance including control of seepage within design rates
 - monitoring and controls to ensure that systems are performing as per design.

Tailings deposition plan

This ensures the efficient use of the tailings capacity and effective closure of the facility. Long- and short-term scheduling of TMF/WRMF lifts and raises are also covered in the plan. At pre-set intervals a schedule for deposition of the tailings and a filling curve (volume/elevation/graph) need to be validated against actual field conditions.

4.2.2 Construction phase

For some mining tailings and waste-rock facilities the distinction between construction and operational phases are not so clear, because often construction continues or reoccurs during operation (e.g. raising of the dam). Construction of the facility will be well documented and follows the construction plan established in the design phase. ‘As-built’ documentation is provided highlighting any changes compared to the construction plan.

In the construction of the facility and for the future:

- ‘as built’ drawings and ‘actual’ procedure records are maintained, highlighting any variances from the original design and if necessary revisiting the design criteria
- construction is supervised by an independent qualified engineering/geo-technical specialist
- records of the results of test work (e.g. compaction) carried out for and during construction are properly maintained.

[45, Euromines, 2002]

4.2.3 Operational phase

The two main causes of TMF incidents have been found to be

- lack of control of the water balance
- a general lack of understanding of the features that control safe operations.

[9, ICOLD, 2001, p. 6]

This indicates that successful operational management is the key factor in operating a safe TMF/WRMF.

Geotechnical engineering has advanced far enough to design sound and safe dams. It is now the management of the TMF/WRMF that makes the difference between a smooth operation or a possible disaster.

The following actions are often taken to avoid incidents:

- monitoring of phreatic surface with properly sited piezometers and open tube standpipes
- foreseeing provisions for diverting water and tailings discharge away from an impoundment in event of difficulties
- providing alternative discharge, possibly into another impoundment
- providing emergency overflow facilities and/or standby pump barges for emergencies
- measuring ground movements with deep inclinometers and having a knowledge of pore pressure conditions

- providing adequate drainage
- maintaining records of design and construction and recording any updates/changes in design/construction
- educating and training staff,

[9, ICOLD, 2001]

and furthermore:

- providing continuity in the engineering of the dam, and
- in some cases, independent audits of the dam with a 'sign-off' by the third-party auditor.

The operation of the management facility should follow the tailings and waste-rock management plan, the operational instructions and the monitoring plan for the facility. Any deviations from these plans need to be documented and evaluated. Monitoring data is evaluated on a regular basis and followed up where necessary. Internal and external reviews (audits) are performed in some cases.

The following are measures taken to ensure sound operation:

- the production of tailings and waste-rock receives the same level of management attention as the production of saleable product
- effective operational control and monitoring is maintained
- there are systems for keeping records of tailings and waste-rock production quantities and characteristics
- accountabilities and responsibilities for tailings and waste-rock management are clearly defined with appropriately qualified personnel
- management facilities are routinely inspected by a qualified professional engineer experienced in tailings and waste-rock management and signed off to confirm that all significant risks have been identified and are adequately managed in the continued operation of the facilities
- operating instructions are prepared in the language of the operators and followed. These instructions include all the monitoring requirements
- operating records, such as rise in levels, tonnes contained, seepage quantities, water consumption (maybe meteorological data), etc. are stored and properly maintained
- operating conditions which occur beyond the boundaries identified by the design are immediately reported to the designer or checked by a qualified technical person
- appropriate training of operational personnel is provided, including incipient fault diagnosis
- special attention is given to the follow-up of the water management plan
- effective mechanisms for the reporting of faults are established and maintained
- effective emergency response plans are maintained and further developed.

[45, Euromines, 2002]

4.2.3.1 Operation, supervision and maintenance (OSM) manuals

Several operators use dam safety manuals. These manuals are known as OSM-manuals (operation, supervision and maintenance) [50, Au group, 2002]. An example of such an OSM manual covers the following:

- dam safety organisation
- emergency preparedness plan
- classification according to the consequences of the dam failure
- dam construction
- hydrology
- environment
- operation
- monitoring
- permits
- reports.

[50, Au group, 2002]

TMF/WRMF safety organisation

The dam safety organisation consists of one dam safety manager appointed at each site. To support these managers there may also be one safety co-ordinator who specialises in TMF/WRMF and works full-time on TMF/WRMF safety. For operation, supervision and maintenance, the manager will also utilise people in his own organisation, often the same staff responsible for the environmental sampling and supervising the tailings storage facilities.

Emergency preparedness plan, (EPP)

For each TMF/WRMF there is an EPP in case of an accident related to the facility. The EPP includes lists of who to contact within the operation and the authorities in the event of an accident occurring. Consultants and contractors who are familiar with the site are also listed, in case support is needed within short notice. The EPP also includes examples of what to do and what measures to take in various possible situations. In general, the manager and co-ordinator are always consulted and involved in all major decisions and measures taken regarding the dams. The manager is the person who has to make the final decisions of what to do in each situation.

Risk management of TMF/WRMF

In some cases, the TMF/WRMF is classified according to the consequences of a possible failure (and not on the probability of a failure). In Sweden, the operators of tailings dams adopted the RIDAS system from the water dam operators. According to the possible consequences there are four different classes; 1A, 1B, 2 and 3 according to the tables below. The table is split into two classes, with classification of risks for humans separated from the risk for property, infrastructure and environment.

Class	Consequences
1A	Obvious risk for human life
1B	Non-negligible risk for human life or serious injury

Table 4.1: Classification with regards to loss of lives or serious injury

Class	Consequences
1A	Obvious risk of: <ul style="list-style-type: none"> ▪ serious damage of important infrastructure, important structures or significant harm to the environment, and ▪ serious economic damage (>EUR 10 M)
1B	Considerable risk of: <ul style="list-style-type: none"> ▪ serious damage to important infrastructure, important structures or significant harm to the environment and ▪ serious economic damage (>EUR 10 M)
2	Non-negligible risk of: <ul style="list-style-type: none"> ▪ considerable damage to infrastructure, important structures, harm to the environment or third parties property (<EUR 0.5 M)
3	Negligible risk for: <ul style="list-style-type: none"> ▪ considerable damage to infrastructure, important structures, harm to the environment or third parties property.

Table 4.2: Classification with regard to damage to infrastructure, environment and property from: Svensk Energi AB, 2002. RIDAS, Kraftföretagens riktlinjer för dammsäkerhet (Revised 2002). Svensk Energi - Swedenenergy - AB

This classification forms the basis for operation and supervision. It sets the limits for the freeboard required and the spillway capacity, i.e. the safety margin from the maximum water level up to the crest of the dam, and the maximum discharge capacity, respectively.

The Swedish RIDAS system is comparable to the Norwegian classification, as shown in the following table

Class	Consequence	Affected dwelling units
1	Low hazard	0
2	Significant hazard	0 - 20
3	High hazard	More than 20

Table 4.3: Classification of dams according to Norwegian legislation [116, Nilsson, 2001]

Relevant mapping and site visits are used as the bases for the assessment. Both class 3 and class 2 effect housing units and involve risks to human population. The classification also considers, e.g.:

- potential damage of major roads or railways
- economic and environmental damages.

The final consequence class is thus subjected to a certain amount of judgement. The classification, and any re-classification, is undertaken by those responsible and needs to be presented to the competent authorities for approval.

[116, Nilsson, 2001]

Spanish legislation also promotes a hazard-based approach, as illustrated in the following table:

Dam category	Risk for			
	Population	Essential services	Material damages	Environmental damages
A	Serious for more than 5 dwellings	Serious	Very serious	Very serious
B	Serious for 1 - 5 dwellings	-	Serious	Serious
C	Incidental loss of life (no dwellings)	-	Moderate	

Table 4.4: Classification of dams according to Spanish legislation [116, Nilsson, 2001]

Under Finnish legislation, a similar approach is taken. Depending on the hazard risk, dams are classified as P, N, O, T, with P being the one with the highest potential impact on human life, environment or property.

[117, Forestry, 1997]

TMF/WRMF construction

Each TMF/WRMF needs to be described in detail. From the starter dam to its present height, a full description is recorded of the type of construction and material used, the name of the contractor, any problems that occurred during construction, the type of spillway, the volume of tailings/waste-rock and water being deposited, etc. In this way, at any time, all the information required about the TMF/WRMF relevant for safety can easily be found.

Hydrology

The requirement is that every dam must have a minimum free board, a maximum wave height allowance and a minimum spillway capacity. This means all dams classified under the RIDAS system as 1A or 1B are designed for a spillway capacity which can handle a once in a 100-year storm, excluding any allowance for water storage. These dams are also designed for a 'class 1 flow' (which should roughly correspond to a once in a 10000-year storm), allowing sufficient storage of water to a safe level. Dams classified as 2 under the RIDAS system are designed for the once in a 100-year storm, whereas class 3 does not have any specific requirements.

Environment

For each TMF/WRMF and mine, an environmental monitoring programme is developed, which covers sampling, evaluation and reporting to the authorities.

Operation

Proper operation of the TMF/WRMF is essential for ensuring reliable operation and a high level of safety. Detailed up-to-date instructions are given of the way the facility is operated to meet design requirements, respond to tailings properties, and to fulfil the demand for process water and climatic conditions. Everybody working on the plant and on the facility should be familiar with these instructions. Education is therefore stressed as an essential requirement.

Monitoring

Supervision and correct operation of the facility are probably the most important requirements to obtain a high level of dam safety. Supervision requires suitable instrumentation, which in turn requires competent staff to evaluate the results and to draw the correct conclusions from them.

Regular monitoring is carried out basically at four different levels, following a stage-wise approach starting with daily inspections, ending with in-depth safety audits carried out with long intervals:

- 1) routing site inspections
- 2) supervision
- 3) annual/bi-annual inspection
- 4) audits.

Site inspections are made at different intervals for each facility, varying from three times a day to several days a week. Normally the staff from the plant, or those that undertake the environmental sampling, carry out the daily inspections.

Supervision is carried out monthly, or at least once every three months, by the manager or an appointed person.

A yearly inspection is carried out by the co-ordinator, or by an external specialist. The inspector examines all events and measures at the site since the last inspection and will issue a report. The yearly inspection will also include a full review of the OSM-manual.

A complete audit is usually carried out at intervals of several years. The survey includes a full investigation of archive material and inspections, and also includes an on-site inspection and a review of the OSM-manual. The result is a report, stating the status of the TMF/WRMF. Audits are discussed in more detail in the following section.

Permits

It is common practice to compile all permits given for TMF to make it easy to check on how operations are faring against the given permits.

Reports

It is common practice to store all reports relevant for TMF/WRMF safety in one place, so that they are easy to find when necessary. The comments from all monitoring exercises need to be prioritised and dealt with in the form of action plans.

Additional information regarding TMF/WRMF safety

After completion of the safety manuals, a lot of effort has to be made to implement the OSM-manuals on site and to educate staff working of the facility. In one example, as a first step all manuals were presented on site, then a four-hour introduction course was held for all staff and other people at each plant involved with the dams. The next step was a three to four-day programme, covering theory, practical training, review of present conditions (labour availability and physical resources), with sufficient time put aside for adequate discussions. Implementation of OSM-manuals and the education of staff is an ongoing project, connected with the yearly inspection. The result of the inspection is presented to all relevant staff, and further education can be linked to this. [50, Au group, 2002]

The advantages of using this type of a documentation system are:

- documentation covering important facts about the TMF/WRMF is gathered in a way that is easy to overview
- information is easily accessible at all time; this facilitates 'hand-over' in the case of change in responsible person or owner
- for any incident, an easy access to all relevant information is assured.

Disadvantages are:

- in countries with a small extractive industry it may be difficult to find a suitable consultant who can perform the audit
- for small operations, the cost of such an audit can be burdensome
- a continuous administrative process, and therefore manpower, for the up-dating of the document is necessary and critical.

[118, Zinkgruvan, 2003]

OSM manuals are applicable in all cases where the risk for considerable damage to infrastructure, important structures, harm to the environment or third party property is not negligible and where there is free water on the pond. In some cases, a certain pond size or heap

height is used to draw the line between negligible and non-negligible risk. For instance, under German legislation these limits are set at 100000 m³ total volume and a dam height of 5 m.

It is not possible to give reliable cost figures for the manpower required for the creation and maintenance of the manuals. However, it can be stated that the cost is comparable to that of other management systems. Two factors that will influence the cost is the amount of information already compiled in the design phase of the site and the size of the operation.

4.2.3.2 Auditing

The independent auditing of a TMF/WRMF evaluates the performance and safety of a facility on a regular basis by a qualified and experienced expert, who was not/is not associated with the design or operation of the facility.

Motivations in support of such audits are:

1. if failures continue to occur even though technology to construct and to operate safe tailings and waste-rock facilities is available. In this case, most of the failures and incidents may be caused by mistakes, either in the design phase or during the operation of the facility [9, ICOLD, 2001]. Human errors and construction defects are consequently factors that cannot be excluded from analysis, which makes a second opinion a useful tool
2. Often an independent audit will not just uncover human mistakes but will allow an 'outsider' to look at the facility from a different (more objective) view that might have been lost for the people working on the site on a daily basis
3. As the experts used for design, construction and other projects on the facility are always to some extent dependent on the mining company, and therefore working closely as an in-house contractor or as a consultant for a mining company can, with time, make the contractor or the consultant become 'one of them', which might unconsciously effect decisions even if the intentions are to be objective. Therefore the audits are usually performed by an expert that had not previously been involved at the specific site
4. That the audits are important and should therefore be carried out on a regular basis. The intervals in-between audits can vary depending primarily on the hazard rating of the facility. Other factors that affect the interval are the rate of rise, construction and deposition method, dam safety organisation, experience within the company and advice from the in-house consultant. The person/team performing the audit will agree on a suitable interval for the next independent audit together with the mining company.

An audit covers all aspects that can effect the overall TMF/WRMF safety, e.g.:

- current design, design according to permits and applicable standards, as-built and design changes documentation
- previous construction/deposition phases in accordance with design
- past problems and incidents
- future/planned design in accordance with applicable standards
- ongoing construction and deposition in accordance with applicable standards
- monitoring of:
 - seepage, surface and groundwater sampling (frequency, location and analysed parameters)
 - pore pressure
 - calibration of equipment
 - evaluation and records of readings
 - action plan when readings fall outside expected results
- TMF/WRMF safety organisation of the mine, i.e. check that one person is appointed responsible, roles and responsibilities for individuals, training programme and incident reporting system

- adequacy of the operating manual, Operation, Maintenance and Surveillance manual (OMS manual) or similar incl. deposition and dam raise methodology, pond and water management, seepage and dust control, access roads, surveillance, documentation and reviews of the manual
- overall water balance of the facility
- surveillance performed according to applicable standards
- risk assessment, incidents, uncontrolled seepage
- hazard rating, incl. loss of lives, environmental and economic (or corporate) aspects
- emergency preparedness plans, evacuation procedure, list of all details for safety personnel and emergency services
- decommissioning plan, incl. hazard analysis, long-term stability, safe containment of toxic material, land productivity and aesthetics.

Qualifications to perform an audit might vary depending on the hazard rating of the facility, but also depending on a specialists available in the region. If the audit incorporates several technical fields, usually a team of specialists needs to be assembled. For tailings dams, geotechnical science is generally of particular interest. Other sciences, depending on local site conditions, may be hydrology and hydrogeology. The person or persons performing an audit need to be specialists with documented experience in the particular sciences. It may be useful to work with specialists from abroad to bring in new knowledge and views.

[119, Benkert, 2003]

Annex 5 describes some current standards for auditing in different parts of the world.

4.2.4 Closure and after-care phase

Usually the closure of tailings and/or waste-rock management facilities occurs simultaneously with the closure of a mine. Therefore an integrated closure and after-care plan needs to be developed and carried out. However, this section focuses on sites within the scope of this work (i.e. not the mine but rather the tailings and waste-rock management facilities). Where necessary or useful interfaces with the overall closure plans are mentioned. It is standard practice that successive reclamation activities that have been performed during the operational phase of the mine life will be evaluated before the final closure of the site. The following issues are included in the previous phases, but are reconsidered again against the 'as built' situation at the site and the closure plans are adjusted accordingly:

- closure costs are included in the assessment of alternatives
- closure plans adopt a risk assessment approach
- closure plans are maintained throughout the active life of the facility and are routinely updated taking into account any modifications to the design and during operation
- facilities are designed to facilitate premature closure if necessary
- after-care design should minimise the need for active management
- the closure plan developed in the planning stage should be reviewed and up-dated with a certain frequency during the design and operational phase of the mine life.

[45, Euromines, 2002]

An important part in developing a closure plan is to develop a post mining land use. A successful subsequent utilisation of a tailings location is facilitated by a balanced consideration of the ecological, environmental, recreational and economic aspects. All effected stakeholders (e.g. operator, permit writers, NGOs, neighbouring communities) need to participate in this discussion.

It should be noted that the OSM manuals, mentioned in the previous section are also applied throughout the closure and after-care phase.

4.2.4.1 Long-term closure objectives

The following three classes of failure mechanisms are considered when designing long-term stable tailings and waste-rock management facilities:

1. slope failures in the foundation or the management facility itself
2. extreme events such as floods, earthquakes and high winds
3. slow deterioration actions, such as water and wind erosion, frost and ice forces, weathering of fill materials and intrusion of vegetation and animals.

[6, ICOLD, 1996]

The reference [100, Eriksson, 2002] used in this section is mainly based on the MIRO (1998) guidelines “A TECHNICAL FRAMEWORK FOR MINE CLOSURE PLANNING“ and the MiMi (1998) state-of-the-art-report on “Prevention and control of pollution from tailings and waste-rock products”. Both of these documents are recommended to interested people as they give a good overview of the subject and provide many good ideas.

The following table summarises the fundamental criteria for closure processes, from initial planning through to actual implementation.

Issue	Closure objectives
Physical stability	All remaining anthropogenic structures are physically stable
Chemical stability	Physical structures remaining after closure are chemically stable
Biological stability	The biological environment is restored to a natural, balanced ecosystem typical of the area, or is left in such a state so as to encourage and enable the natural rehabilitation and/or reintroduction of a biologically diverse, stable environment
Hydrological and hydrogeological environment	Closure aims at prevent physical or chemical pollutants from entering and subsequently degrading the downstream environment - including surface and ground waters
Geographical and climatic influences	Closure is appropriate to the demands and specifications of the location of the site in terms of climatic (e.g. rainfall, storm events, seasonal extremes) and geographic factors (e.g. proximity to human habitations, topography, accessibility of the mine)
Local sensitivities and opportunities	Closure optimises the opportunities for restoring the land and the upgrade of land use is considered whenever appropriate and/or economically feasible
Land use	Rehabilitation is such that the ultimate land use is optimised and is compatible with the surrounding area and the requirements of the local community.
Funds for closure	Adequate and appropriate readily available funds need to be available to ensure implementation of the closure plan
Socio-economic considerations	Consideration must be taken of opportunities for local communities whose livelihoods may depend on the employment and economic fallout from the mining activities. Adequate measures are made to ensure that the socio-economic implications of closure are maximised

Table 4.5: Summary of criteria for closure
[100, Eriksson, 2002]

Physical stability

All anthropogenic structures that remain after the mine closure must be physically stable. They should pose no hazard to public health and safety as a result of failure or physical deterioration, and they should continue to perform the function for which they were designed. The structures should not erode or move from their locations, except where such movement does not endanger public health and safety nor cause detrimental effects to the adjacent environment. This means that full account must be taken of possible extreme events, such as floods, winds or earthquakes, as well as other natural perpetual forces, such as erosion, in the design periods and in consideration of the factors safety proposed. Monitoring of structures is aimed at demonstrating that there has been no physical deterioration or deformation.

[100, Eriksson, 2002]

Differences from conventional practice arise in several areas, and these are considered in turn:

Extreme events

Tailings dams are designed to remain stable under the influence of some chosen magnitude of floods and earthquakes, such as the Probable Maximum Flood (PMF) or Maximum Credible Earthquake (MCE). The corresponding design values are established within the framework of the meteorological and seismic understanding of the region, and are thus a function of the state of knowledge at the time they are derived. However, this state of knowledge continually changes as the understanding of technical factors improves and the occurrences of large floods and earthquakes accumulate. Hence, the original design estimates also change over time and will increase in magnitude. As time advances, the largest event to have been experienced can always be exceeded, but never reduced. The bulk of dam safety expenditures for most owners of conventional hydroelectric dams are devoted to improving spillways and foundations to accommodate these new and higher values. For some tailings facilities (e.g. many tailings ponds) under after-care circumstances, this kind of upgrading may have to be performed perpetually. Without this it would be impossible to sustain the extreme event estimates that future knowledge provides. [13, Vick,]

However there are some key variations over time in the geotechnical parameters which can improve stability. In particular, elevated pore water pressures within both settled tailings and coarse discard embankments will, in almost all scenarios, significantly dissipate over time. This normally leads to consolidation of the deposits, to increased shear strength and reduced permeability (especially vertically). This is particularly the case when tailings deposits are capped and surcharged. Providing proper provision for drainage is made, the factor of safety against instability will almost always increase over time and is likely to be further enhanced by the establishment and growth of appropriate vegetation.

There is a need to consider the subsidence effects of subjacent and adjacent mining and the potential for groundwater recovery in the vicinity of the dam or tip after mining has ceased and its likely effect on instability.

Cumulative damage

A related factor involves cumulative damage from repeated occurrences of extreme events, or progressive processes such as internal erosion, that degrade the dam stability over time. For earthquakes, conventional dam safety practice is to undertake repairs immediately after a damaging event. For tailings facilities, the repairs may be physically impossible to accomplish. For conventional dams, drawdown of the reservoir may be required to repair major damage, and is also an important emergency response. But a reservoir containing tailings solids cannot be reduced in level. Moreover, a tailings dam will experience repeated occurrences of extreme events during the indefinite future, their number depending on time and recurrence rate. For major earthquakes in some mining regions this is in the order of only hundreds of years. An example of the cumulative effects of seismic shaking is provided by the La Villita Dam in Mexico, which has experienced progressively increasing crest settlements during four separate episodes of major seismic shaking in just 30 years. Cumulative damage also results from simple deterioration with age. No concrete structure - spillway, decant facility, or tunnel lining - lasts forever without continuing maintenance and repair.

[13, Vick,]

Climate change

The effects of long-term climate change are of intense interest and great uncertainty. Yet for a tailings dam to remain stable in perpetuity requires somehow that the influence of these changes on floods and spillway capacity be accurately predicted, something that even climate experts are not able to do. Climate change may also affect both physical and chemical stability in other ways. Frozen conditions are relied upon to reduce ARD reaction rates at some mines in arctic and sub-arctic regions, where certain tailings dams also depend for stability on the presence of frozen ground. It goes without saying that permanent submergence requires sufficient water,

even during sustained drought, periods notwithstanding any future changes in climate. [13, Vick,]

It is therefore important to evaluate the potential effects of climate change as a part of the Environmental Impact Assessment (see Section 4.2.1.3) if this may be relevant to the long-term behaviour of the chosen management option.

Geologic hazards

While tailings dams are designed to accommodate the geological hazards known to exist at the time they are constructed, in the indefinite future they will eventually be subject to the full suite of geomorphic processes operating at their sites (e.g. landslides, rock avalanches, volcanic activity, karst collapses). Like the occurrence of extreme events, the damaging effects of these processes are only a question of time and recurrence rate, a factor particularly difficult to predict for most large-scale geological phenomena. Even the more benign processes of alluvial deposition will eventually fill water conveyance facilities unless they are continually cleared of sediment and debris. [13, Vick,]

Chemical stability

Tailings and waste-rock management sites and the structures within them must be chemically stable throughout all phases of their life cycle. This means, for example, that the consequences of any chemical changes or conditions leading to the leaching of metals, salts or organic compounds should not endanger public health and safety nor result in the deterioration in environmental resources. In practice, aspects such as the short and long-term effects of changes in tailings geochemistry, the seepage from tailings impoundments, waste-rock dumps and underground backfill, or the draining of surface waters draining from the site must be examined. Where contaminated discharges are predicted in advance, appropriate mitigation measures (e.g. settlement or passive treatment using wetlands) must be employed to alleviate or eliminate such discharges if these are likely to cause adverse environmental effects. Monitoring is aimed at demonstrating that there are no adverse effects, (e.g. raised concentrations that exceed statutory limits), from the waters, soils and air surrounding the closed site.

[100, Eriksson, 2002]

For **sulphide tailings/waste-rock** the most evident closure objective is to maintain the chemical stability of the tailings/waste-rock by preventing the release of oxidation products to the surrounding environment, whether this is accomplished by preventing oxidation reactions from occurring, or by preventing the transport of these products beyond the site boundaries, or indeed both. Natural processes can strongly influence how this objective is achieved. For example, measures to restrict infiltration into the deposit may be preferred over those such as applying low-permeability bottom **liners** with accompanying hydraulic gradients that promote contaminant transport (the so-called 'bathtub' effect). [13, Vick,]

Biological stability

The biological stability of the closed site is closely related to its final land-use, whereas the stability of the surrounding environment will be primarily dependent upon the physical and chemical characteristics of the site. All three are linked because biological stability may significantly influence physical or chemical stability. For example, plant roots will inhibit erosion by binding the soil surface, and the development of a healthy plant cover over a wetland treatment area will increase the surface depth of organic matter, thus creating the anoxic conditions necessary for water treatment. The rehabilitation of most sites involves the revegetation of large areas of restored land, which can often be of a poor quality in terms of sustained plant growth. It is important, therefore, that the methods of amelioration and cultivation of the soils or soil forming materials, together with the species chosen result in the development of a sustainable plant cover. This should be appropriate to the chosen land-use and may play an important part in maintaining the physical and chemical stability of the site, for instance by stabilising the soil cover and preventing erosion. Monitoring is aimed at demonstrating that not only plant growth has been successful in the first instance, but over a period of several growing seasons has developed into a self-sustaining plant community.

[100, Eriksson, 2002]

Conventional safety practice recognises the detrimental effects of burrowing animals and root penetration as matters that need to be addressed with continuing maintenance. Other problems may be more unexpected. For example, as the country's national symbol, the beaver is ubiquitous to Canada, and its habits are well known to engineers and biologists alike. Its propensity to undertake its activities in response to the sound of running water has been acknowledged as a serious long-term closure issue for tailings dams as it builds dams which can cause the blockage of diversion facilities, and indeed this has been documented as a cause of tailings dam failure in the past. In Europe, it should be noted that the European beaver, which became extinct in Sweden in the 1870s, was reintroduced in the 1920s and is now thriving successfully.

These factors show at a more detailed level the extent to which long-term dam safety depends on the need for continuing maintenance, modification, and repair, and conversely how difficult it is to assure stability in the long term. [13, Vick,]

Successive land use

The general successive use of a closed site is determined by the following factors:

- pre-mining or current land use surrounding the site
- any expected future changes in surrounding land use
- the reasonably expected post-operational use of the mine site
- viability of re-using the site infrastructure and facilities
- the extent of any environmental impacts
- the need to safeguard against physical, chemical and biological hazards (both anthropogenic and naturally occurring).

Specific issues related to the chosen long-term management need to be considered in the determination of the successive land use.

From this, there are a number of different options that are considered for most sites. These include the following:

- natural recolonisation of the site by local vegetation
- planting of commercial forestry plantations
- development for agriculture
- encouragement of alternative industrial activities
- use of infrastructure facilities as part of the commercial development in the region.

Whatever the final choice, the sites are usually rehabilitated so that the ultimate land use and morphology of the site is compatible with the surrounding area or with the pre-mining environment. This does not preclude maintaining the area as an industrial or commercial site, if this is appropriate.

4.2.4.2 Specific closure issues

Heaps

The geometry and related stability of heaps is dependent on the type of material in the heap, the construction method and on the local topography.

Potential problems and hazards associated with heaps include:

- unstable slopes
- formation of toxic leachate leading to downstream contamination
- generation of ARD
- pollution of surface water and/or groundwater
- fires/spontaneous combustion
- damage of livestock, native fauna and harm to the public
- dust pollution and wind erosion
- visual impact.

It is common practice to fully research the geology prior to operation. Should there be a risk of seismic activity or other natural or man-induced destabilising events, all measures and structures implemented should be designed and constructed adequately.

[100, Eriksson, 2002]

Ponds/Dams

Slurried tailings are generally discharged into a containment site, e.g. a pond, where they are isolated from the surrounding environment, thus preventing potential impacts on this environment. The impoundments are generally constructed using natural topography and dams within which the management of the tailings can be controlled.

Determination of the type of impoundment and the location of a specific site relies on the following factors:

- topography
- natural hazards
- local climate and water balance
- volume of tailings
- extent of tailings consolidation
- toxicity of tailings
- environmental concerns of the tailings and process water
- amount of suitable material for capping
- available topsoil
- economics.

Potential problems and hazards associated with tailings ponds include:

- unstable slopes leading to collapse or dam failure
- seepage or leakage of leachate leading to downstream contamination
- generation of ARD
- pollution of surface water and/or groundwater
- damage of livestock, native fauna and harm to the public
- dust pollution and wind erosion.

It is common practice to fully research the geology prior to the operation of the site. Should there be a risk of seismic activity or other natural or man-induced destabilising events, all measures and structures implemented should be designed and constructed adequately. A comprehensive report on the hydrology and geochemistry and the geotechnical aspects of the site thus need to be prepared. [100, Eriksson, 2002]

Water cover

When designing a tailings pond the containing dams need to provide an acceptable level of safety, both over the operational period and for the post closure period. In many cases, it is desirable to maintain a permanent water cover or a wetland on top of the deposited tailings, to avoid mobilisation of contaminants and/or for aesthetic reasons.

The following text describes how a long-term stable earth dam can be designed so that it can sustain such a **permanent water cover**.

The water cover technique as a means of ARD management is described in more detail in Section 4.3.1.2.1.

A tailings pond could potentially pose a threat to the environment during operation as well as during the post closure phase. To avoid a negative effect on the environment, the tailings pond needs to be physically and chemically stable. In this sense two conditions have to be met:

1. the dam needs to provide an acceptable level of stability, both over the operational period and for the post closure period
2. material that might have a negative impact on the environment needs to be stored/deposited in an environmentally safe manner.

After the operation has ceased, measures need to be taken to integrate the tailings pond into the surrounding landscape in a safe and aesthetic manner.

If the tailings contain sulphides, which in contact with air and water may slowly oxidise and produce acid and dissolved metals, oxidation of the sulphides should be avoided, e.g. by permanently depositing the tailings under water. In this case, the tailings pond needs to be designed and built to satisfy the needs for a long-term stable dam and to meet the conditions for permanent flooding of the surface.

The following requirements need to be fulfilled for a permanent water cover:

- the refill of water to the tailings pond has to be sufficient to guarantee the water cover and a stable water chemistry at all times
- the dam has to be stable enough to provide an acceptable level of safety during operation as well as thereafter.

With regard to stability, the long-term requirements will require proper dimensioning of the dam for the given design. 'Long-term' normally means 'until the next ice age' or 'a couple of thousand years'. Based on current knowledge, the following issues/failure mechanisms need to be addressed in order to fulfil the requirements for a 'long-term stable dam':

- slope stability
- overtopping of the dam crest
- instabilities of the foundation and within the dam
- extreme events such as flood events, earthquakes and strong winds
- slowly deteriorating processes caused by seepage water, precipitation, frost, ice, vegetation, etc.

[126, Eriksson, 2003]

Long-term stable slopes of dams designed to permanently retain water

Experiences and studies of natural formations similar to tailings dams indicate that a slope flatter than 1:3 (V:H) has so far proven stable for water and wind erosion, frost and weathering for the last 10000 years (i.e. since the last ice-age). An angle flatter than 1:3 will also support vegetation, which will also decrease the impact of slow deterioration actions.

[127, Benkert, 2002]

Vertical filters are installed between the low permeable core and the support fill. The downstream toe is equipped with a filter (the purpose of the filter material has been explained in Section 2.4.2.2) and can also be supported by coarse rocks. A seepage collection ditch needs to be constructed downstream of the toe for monitoring the seepage flow and quality (possibly for collecting the seepage if it does not fulfil the discharge quality standards during the operational phase). [126, Eriksson, 2003]

Overtopping

The risk of overtopping is dependant on the local weather conditions and on the size of the catchment area. During operation, the discharge capacity should be able to handle foreseeable extreme flood events (e. g. PMF, see Section 2.4.2.6). The discharge capacity is usually 2.5 times the highest flow measured at any point. If a water cover solution is chosen for the closure of the tailings pond, the discharge facility (outlet) needs to be long-term stable, preferably constructed as a spillway in natural ground and not through the dam. The long-term stable outlet should, with sufficient safety margin, be able to handle any extreme flood event and at the same time manage the risk posed by clogging by ice, falling trees, branches, etc without jeopardising the required discharge capacity. These requirements imply that a very wide outlet needs to be constructed for the long-term phase.

As a consequence of assuring adequate freeboard, there is likely to be a considerable distance from the edge of the pond (free water) under normal climatic conditions to the crest of the dam (the so-called beach). This area of tailings will, upon closure, be covered with an impervious layer of material to prevent infiltration, aeration and weathering. The advantages with a long beach distance are that the slope stability is improved and the potential for internal erosion is reduced as a consequence of the flat phreatic surface and flow lines.

Instabilities

A safety factor of 1.5 is often considered to give sufficiently low long-term probability for instabilities in the underground, the foundation and within the dam. Section 4.4.13.1 gives further examples for safety factors and their determination. Furthermore, when applying a wet cover, the slope angle of the hydraulic gradient needs to be less than 50 % of the friction angle for the material of which the dam is constructed.

Extreme events

The dam design needs to be checked for dynamic stability against the site-specific design earthquake acceleration. A safety factor of 1.5 is considered to be sufficient for dynamic stability. Strong winds create waves, which can damage the upstream slope and the crest of the dam. Site-specific wind data should be used when calculating the height of the dimensioning waves. The dimensioning wave height will determine the necessary erosion protection on the upstream slope and possibly add to the necessary freeboard. Erosion protection is necessary for the long-term phase, as well as during operation.

[126, Eriksson, 2003]

Slow deterioration actions

During the long-term phase, dams can be damaged by slowly deteriorating processes such as seepage, erosion, temperature, frost, ice, vegetation, etc.

The long-term process that most likely is of greatest importance for the stability of a dam is the seepage through the dam. Seepage through the dam may cause inner erosion, which is a common cause of damage to large hydropower dams. However, it is possible to avoid/prevent inner erosion if the inclination of the hydraulic gradient (i.e. the pore pressure line) is as low as in natural soil formations that are stable against groundwater flow. Generally, a soil slope is stable against internal erosion if the inclination of the hydraulic gradient is less than half of the friction angle of the soil material.

Following the reasoning above, a long-term stable dam is constructed in such a way that the inclination of the hydraulic gradient is less than half of the friction angle of the soil material. In this case, the dam can be considered to be under groundwater pressure instead of a static water pressure and will thus have an acceptable level of safety against inner erosion. This condition is likely to be used when dimensioning how wide the dam needs to be.

Damages by erosion, temperature and vegetation can be avoided by using long-term stable materials in the construction of the dam and by constructing the slopes of a sufficiently low angle. A slope angle of 1:3 (V:H) is considered long-term stable as such slopes naturally occur in the landscape. These natural slopes will have been naturally submitted to erosion, temperature, vegetation etc over very long time periods, in Nordic countries since the last ice age (approx. 10000 years) and in spite of this long time period very little sign of alteration can be noticed. The most obvious sign of alteration is the oxidation and leaching of the upper-most 0.5 m of the soil. However, below that depth, the moraine is practically unaltered. It can therefore be assumed that a dam constructed of such material can continue to withstand such processes. Similar reasoning can be made regarding other material that is used in other parts of Europe. [126, Eriksson, 2003]

The following figure shows some typical examples of dams designed for permanent water covers. Note that in this figure the coarse tailings are adjacent to the dam.

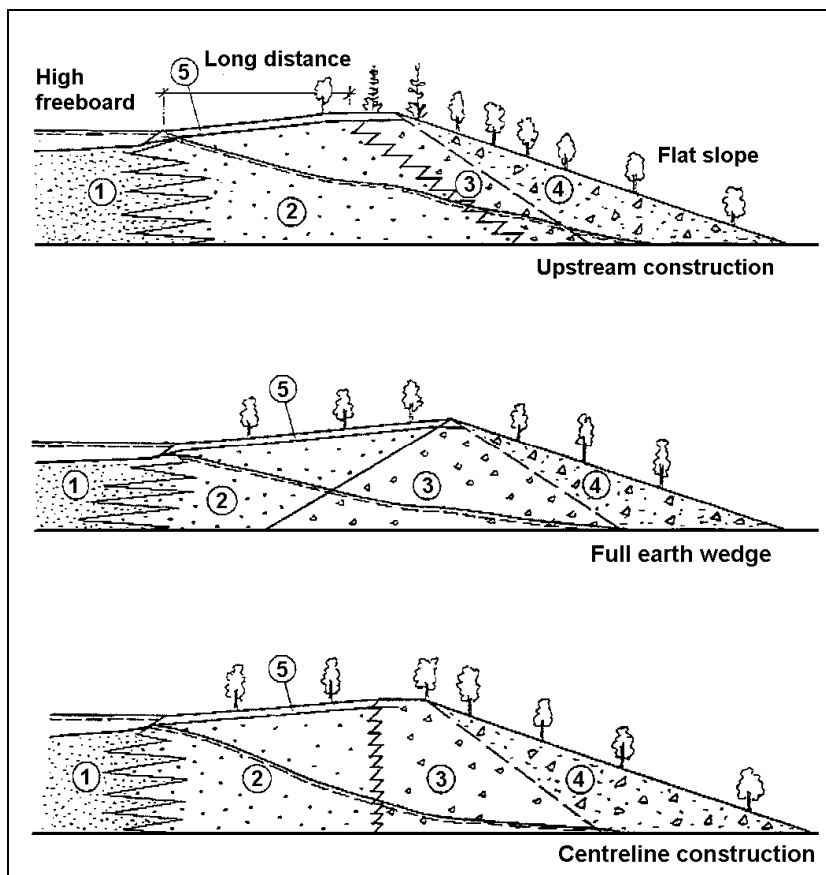

Figure 4.2: Dams for permanent water covers
 1. Fine tailings, 2. Coarse tailings, 3. Support fill, 4. Support fill, long-term stable, 5. Impervious cover and erosion protection
 [6, ICOLD, 1996]

Dewatered ponds

Upon closure the lowering of the phreatic surface will increase slope stability and reduce the risk of internal erosion. The following are aspects that are considered to avoid the potential problems and hazards mentioned above:

- the outer slopes of the dams are modified to ensure an adequate safety factor for both long-term stability and seismic loading conditions
- seepage needs to be controlled by adequate drainage
- arrangements need to be made for the collection and deviation of surface run-off
- the dam needs to be long-term stable against slow deterioration actions
- where the tailings have an ARD potential, a suitable cover to avoid/inhibit infiltration and diffusion is required (see Section 4.3.1).

Existing systems of storm-water diversion can be upgraded to improve capacity and durability, in order to prevent erosion of the deposit in the event of high rainfall. Decant towers and outfall pipes need to be maintained in such a state that they do not constitute a potential long-term risk. It is common practice to seal outfall pipes with a cement plug. The upper surface of the dam is contoured to ensure an acceptable balance between precipitation and evaporation. In high rainfall areas, a spillway may be required to decant the excess water of the surface of the dam.

The following figures show some typical dams for dewatered ponds. Note that in this figure the coarse tailings are adjacent to the dam.

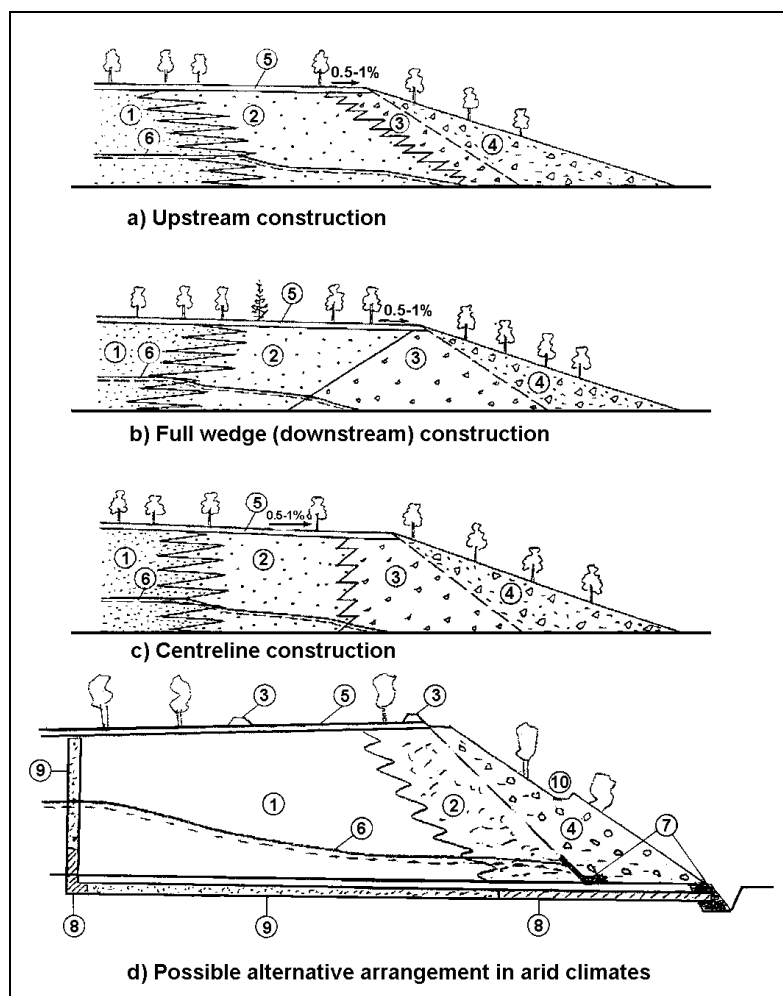

Figure 4.3: Dams for dewatered ponds
[6, ICOLD, 1996]

Water management facilities

Water management facilities include all the facilities at, or associated with, a mine site utilised to control, store, treat and convey water for the purposes of the process and domestic use, as well as covering the diversion discharge and the treatment of excess water. This includes:

- ponds/dams
- reservoirs
- spillways
- intake structures
- diversion ditches
- culverts
- pipelines
- pump houses
- treatment plants
- settling ponds
- dewatering systems.

Potential problems and hazards associated with the closure of water management facilities include:

- contamination of surface water and/or groundwater
- uncontrolled water discharges leading to flooding and/or alteration of the natural hydrological regime
- harm, including injury and/or death, to livestock, native fauna and the public.

An inventory of all the equipment and facilities present at the site or in use for the purpose of handling and/or treating water arising from the site is usually compiled. The status of the above documented and their locations indicated on maps and site plans. Full information on the hydrological conditions and related mine workings is obtained prior to closure. Should there be a risk of seismic activity or other natural or man-induced destabilising events, all measures and structures implemented should be designed and constructed adequately.

Water management facilities are usually decommissioned and, where possible, removed from the site to prevent unacceptable levels of contaminated water from being discharged off site. It is good practice to remove those facilities requiring maintenance during the closure phase, especially when safety, stability and environmental impacts are possible. The site decommissioning plans integrate any re-usable components into the post-mining land use, the water management system and/or drainage pattern for the area.

Water management at a mine site is likely to have altered the natural hydrological regime. The water storage of impoundment facilities generally change the naturally occurring surface water and alter the flowrates and volumes moving through natural water channels. Re-watering of the natural hydrological regime involves the cessation of pumping from underground wells to allow flooding of the mine workings and the pumping to surface and treatment of this water until it no longer poses a threat to groundwater quality. A large portion of the exposed surface area in the abandoned underground workings may be pyritic and may be subject to oxidation prior to the initial flooding of the mine. Water may be used to flush the mine of impurities, especially to reduce sulphates and metals and to reduce the risk of contamination. This continues until normal groundwater quality is restored.

[100, Eriksson, 2002]

Closure of tailings and waste-rock management facilities containing non-reactive tailings and/or waste-rock

For non-reactive tailings and/or waste-rock, the important issues to consider upon closure are

- long-term physical stability
- landscaping and revegetation
- prevention of:
 - erosion
 - dusting.

Many sites already landscape the outside of the dams during the construction of the dams. Upon closure, the phreatic surfaces are then maintained under the top level of the tailings by means of an overflow arrangement, in order to avoid erosion of the dam toe. The tailings are covered with clay, soil and grass. Bushes and trees are planted.

The following figure shows some typical covers for TMF. Options 1 and 2 are applied for non-reactive tailings.

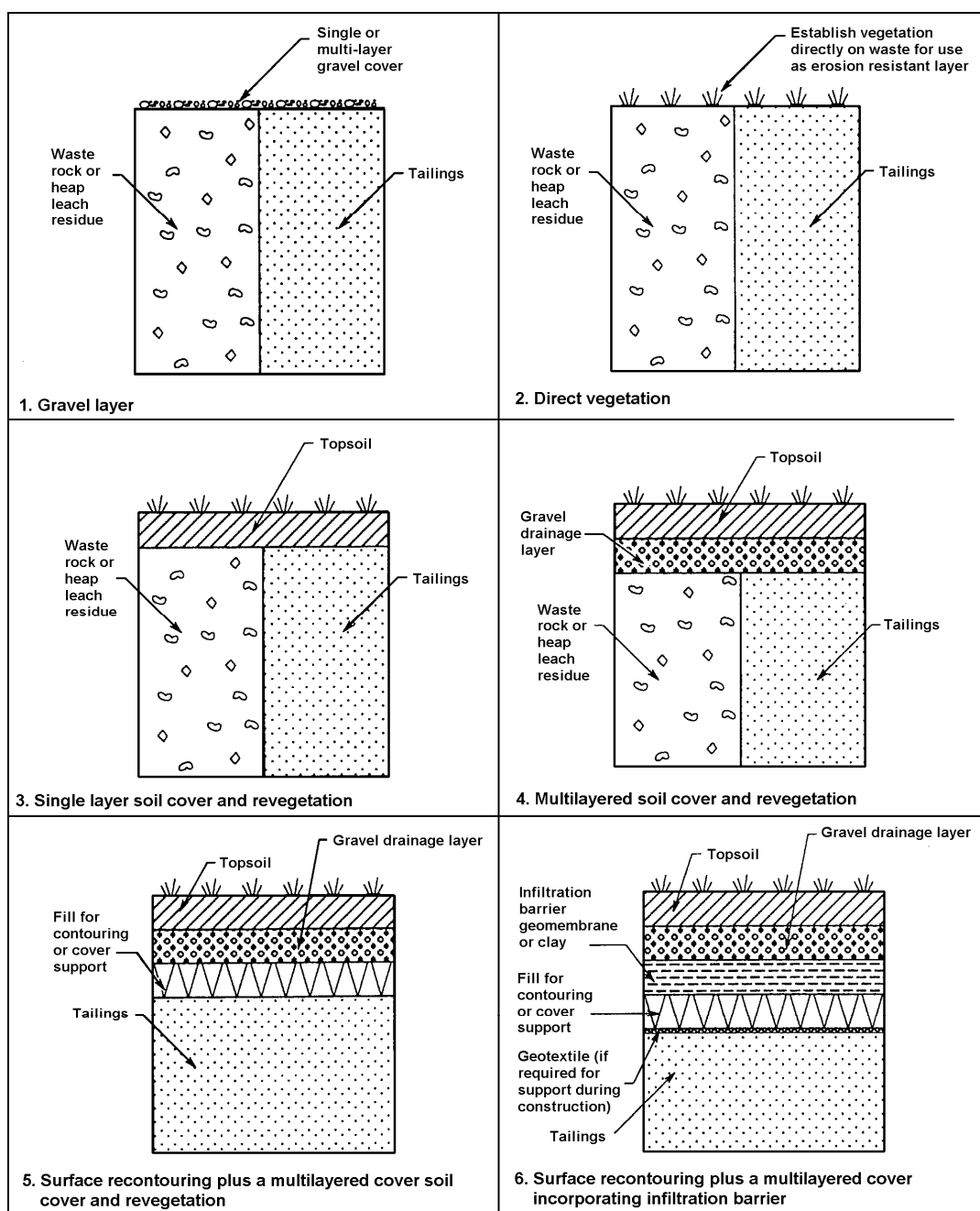

Figure 4.4: Typical covers for tailings management areas
[11, EPA, 1995]

4.3 Emission prevention and control

4.3.1 ARD management

The management of potentially ARD generating tailings or waste-rock normally follows a risk based approach. During the risk assessment the accurate characterisation and understanding of the material is of critical importance. The management process is a cyclic process, and is originally done in the planning phase of the mine, but is renewed and re-evaluated continuously throughout the mine life. The assessment process always covers the 'cradle-to-grave' concept, i.e. any preferred option with respect to the management of tailings and waste-rock during the operational phase of the operation should also include an acceptable closure strategy. Initial material characterisation is done in the planning stage of the mine, however, the initial characterisation results are continuously followed-up and confirmed by material characterisation during the operational phase of the mine.

This section is based on the MiMi (1998) state-of-the-art-report on "Prevention and control of pollution from tailings and waste-rock products" [95, Elander, 1998]. Some additional case studies have also been added. The entire report can be found on the website .

There are a number of prevention, control and treatment options developed for potentially ARD generating mining waste, applicable for the operational as well as for the closure phases of the mine life.

Section 2.7 describes the processes involved in the generation of ARD.

4.3.1.1 Prediction of ARD potential

At **Ovacik**, a detailed characterisation of samples has shown that the tailings and waste-rock will not produce ARD.

The following table shows the average results of 99 samples.

	pH	AP*	NP*	NNP*	NP/AP*	S ²⁻ (%)
Average of 99 samples	7.52	0.47	5.5	5.18	4.67	0.02
*:kg CaCO ₃ equivalent per tonne						
AP: Acid Potential						
NP: Neutralisation Potential						
NNP: Net Neutralisation Potential						

Table 4.6: Acid production potential at Ovacik Gold Mine
[56, Au group, 2002]

The characterisation of tailings and waste-rock (see Section 4.2.1.2 in combination with Annex 4) includes:

- determination of the Acid Potential (AP) based on the total sulphur or sulphide-S content
- determination of the Neutralisation Potential (NP).

If $NP/AP \leq 1$: 1 a sample is considered to have an acid-forming potential. If $NP/AP \geq 3:1$ a sample is considered to be non-acid forming.

4.3.1.2 Prevention options

The basis for any preventive measure is the characterisation of the tailings and waste-rock, together with a comprehensive management plan which identifies and minimises the amount of tailings and waste-rock that requires special attention. Many preventive methods focus on minimising the sulphide oxidation rate and thereby the primary mobilisation of weathering products. This can be accomplished by minimising the oxygen transport to the sulphides through applying an oxygen transport barrier (cover). The covers are normally variations on two basic concepts: (1) 'water covers' or 'wet covers' (i.e. flooding), or (2) 'dry covers'. A third type, 'oxygen consuming covers' have also been developed and applied. Other preventive methods aim at removing sulphide minerals from the tailings or waste-rock (depyritisation), adding buffering minerals, minimising the bacterial activity or minimising the mineral surface area available for weathering, respectively. Oxidation of the sulphide minerals can be minimised during operation by e.g. the underwater management of tailings.

Prevention method	Used principle
Water cover and underwater (sub-aqueous) discharge	Uses a free water cover as an oxygen diffusion barrier. Oxygen diffusion is 10^4 times less in water than in air
Dry cover	Uses a low permeable layer with high water content as an oxygen diffusion barrier
Oxygen consuming cover	Uses a low permeable layer with high water content as an oxygen diffusion barrier. In addition, the low permeable layer has a high content of organic matter which, when it degrades consumes oxygen and thereby further reduces oxygen transport to the underlying sulphides
Wetland establishment	Wetland establishment as a closure method uses the same principle as the water cover but with less water depth as the plant cover stabilises the bottom, and thereby re-suspension of the tailings can be avoided
Raised groundwater level	Maintains the underlying sulphide material constantly below the groundwater table by retaining water through: <ul style="list-style-type: none"> ▪ increased infiltration ▪ reduced evaporation ▪ increased flow resistance ▪ capillary forces
Depyritisation	Separation of pyrite from the tailings and separate discharge of the pyrite (e.g. under water)
Selective material handling	Selective management of various tailings or waste-rock fractions determined by their composition and properties, e.g. separation of material with ARD generating potential for separate handling

Table 4.7: ARD prevention methods and the principle or which they are based on

4.3.1.2.1 Water covers

A water cover, or ‘wet cover’, is a closure method which uses free water as an oxygen diffusion barrier. The oxygen diffusion coefficient is 10^4 times less in water than in air. This implies that if a water cover can be established, sulphide oxidation can be almost eliminated. The prerequisites for a water cover are:

- a positive water balance, which can guarantee a minimum water depth at all times
- long-term physically stable dams (if not a pit, a natural lake or sea has been used in some cases for the deposition of the tailings)
- long-term stable outlets with sufficient discharge capacity even during extreme events
- a water depth within the pond deep enough to avoid the re-suspension of tailings by wave action (break waters can be used to reduce the required water depth)
- that the tailings can dissolve in water.

Furthermore, it is a benefit if there is a natural stream entering the pond, i.e. one which can supply organic material, flora and fauna to the decommissioned system. This will further improve the performance of the water cover by providing an additional diffusion barrier due to the sediments and can speed-up the re-colonisation of the system.

Water covers are a closure option for tailings ponds of any type (e.g. for ‘normal’ tailings discharge or for subaqueous discharge during operation).

Two examples of sites where these have been implemented are Stekenjokk and Kristineberg.

Stekenjokk constitutes a pioneer site set up for the decommissioning of tailings ponds containing sulphide tailings. The decommissioning occurred in 1991, which therefore provides for more than ten years of evaluation of the results. The Stekenjokk decommissioning project has been described in detail by Broman and Göransson (1994). The implemented measures at Stekenjokk are schematically described in the figure below (from Broman and Göransson, 1994). [100, Eriksson, 2002]

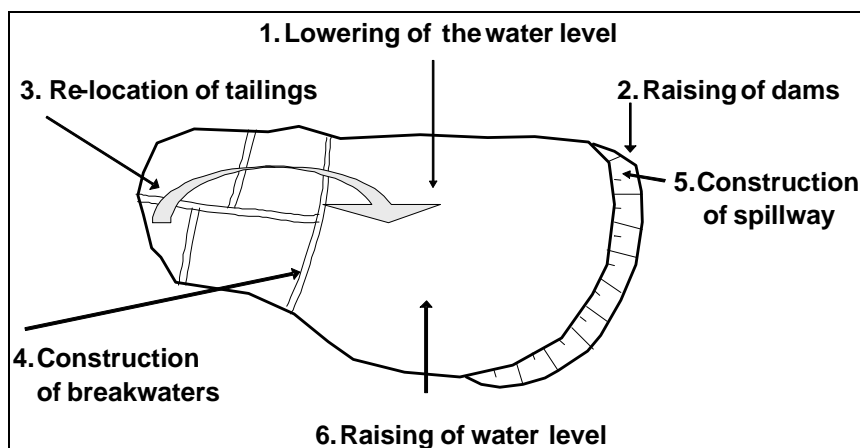

Figure 4.5: Implemented measures at Stekenjokk TMF [100, Eriksson, 2002]

The performance of the implemented measures have been monitored and evaluated over time. A mass balance calculation is presented in the report using data from the first 8 years of follow-up activities and with the assumption that the sulphate can be used as a tracer for sulphide oxidation. The analysis indicates that the water cover efficiently reduces the sulphide oxidation rate of the deposited tailings. Expressed as the oxygen flux through the water cover to the tailings, the upper limit of the sulphate outflow of the pond corresponds to an upper limit of the effective oxygen flux of 1×10^{-10} kg O_2/m^2s . This is comparative to, or even better than, that

obtained from engineered composite dry cover solutions. These results demonstrate that the objectives of the decommissioning project have been surpassed. Similar results have previously been reported from studies of tailings subaqueously deposited in natural lakes. The water cover is both efficient and cost effective compared to a dry cover.

The implemented water covers had an investment cost of USD 2/m² compared to the costs of studied dry covers of USD 12/m². Furthermore, no borrow pits needed to be opened for the extraction of cover material.

The uncertainty about water covers relates to the long-term stability of the dam. Some aspects related to the long-term stability of facilities where the water cover technique is applied are discussed in Section 4.2.4.2

It can be argued that it is not possible to completely eliminate sulphide oxidation since the water cover will always contain oxygen. However, the results indicate that the sulphide oxidation rate is negligible at Stekenjokk. Steady trends of falling sulphate concentrations in the discharge of the pond have been observed. After 10 years the sulphate concentration in the pond effluent is close to background values.

The main experiences learnt from this site are listed below:

- the extreme winter conditions that prevail at Stekenjokk have added special difficulties to the project. Abnormal increases in the water level in the pond (which in the extreme case could cause overtopping of the core) were detected during the late period of the winter. Investigations showed that partial ice clogging in the outlet was the cause. This led to the complete reconstruction of the outlet. The new outlet was constructed in natural bedrock and a significantly deeper discharge channel was constructed to allow water flow even under the most extreme ice conditions (up to 2 m of ice thickness has been documented in Stekenjokk)
- in the spring of 1998, the seepage water at one location of the toe showed signs of being "turbid". This was interpreted as a possible sign of inner erosion. A stabilising berm designed as a filter was immediately put in place at the toe of the dam. However, analysis results showed that the "turbidity" had been caused by the formation of alumina-silicates (as a result of dissolution of silicates to buffer sulphide weathering). Consequently, there had not been any inner erosion
- in 1998, the Stekenjokk tailings pond was submitted to a full safety audit in connection to the development of the Dam Safety Manual (OSM manual) for Stekenjokk. This audit recommended that an additional outlet should be constructed in order to secure sufficient discharge capacity in case of ice blocking the main outlet. The outlet was constructed the same year. The safety outlet enters into function automatically if the water level increases above a specific level
- the dam body has not been subject to any measures related to stability issues after the closure works were completed and the dam slope was adjusted to 1:2.5 (V:H). However, in 1994, it was decided to cover the downstream slope with a moraine cover as it was detected that the dam contained sulphide material that was subject to weathering, which was affecting the downstream aquatic environment.

The decommissioning at the **Kristineberg** 4 pond is not yet completed but the measures taken are carefully followed up by the MiMi research project and are reported at www.mimi.kiruna.se [100, Eriksson, 2002].

The problem with maintaining a water cover and a dam for a very long time period and without management is an issue.

Some additional information has been gained by studying natural lakes that have been used for the subaqueous deposition of tailings for relatively long time periods. Fraser and Robertsson (1994) reported that tailings sub-aqueously deposited in Mandy Lake between 1943 and 1945 show little or no evidence of chemical reaction after 46 years on the lake floor. There are also studies showing similar results for Buttle Lake (Vancouver Island).

References:

Dave N. K. and Vivyurka A. J., 1994. Water cover on acid generating uranium tailings-Laboratory and field studies. In proceedings of the Fourth International Conference on Acid Rock Drainage, vol 1; 297-306.

Eriksson N., Lindvall M. and Sandberg M., 2001. A quantitative evaluation of the effectiveness of the water cover at the Stekenjokk tailings pond in Northern Sweden: Eight years of follow-up. Proceedings to Securing the Future, International Conference on Mining and the Environment, Skellefteå, June 25 - July 1, 2001.

Fraser W. W. and Robertsson J. D., 1994. Subaqueous disposal of reactive mine waste: An overview and update of case studies - MEND/CANADA. Bureau of Mines Special Publication, SP 06 A-94, 250-259.

Pedersen T. F., McNee J. J., Mueller B., Flather D. H. and Pelletier C. A., 1994. Geochemistry of submerged tailings in Anderson Lake, Manitoba: Recent Results. Bureau of Mines Special Publication, SP 06 A-94, 288-296.

Robertson J. D., Tremblay G. A. and Fraser W. W., 1997. Subaqueous tailing disposal: A sound solution for reactive tailing. In proceedings of the fourth International Conference on Acid Rock Drainage, vol 3; 1029-1041.

St Arnaud L., 1994. Water covers for the decommissioning of sulphidic mine tailings impoundments. Bureau of Mines Special Publication, SP 06 A-94, 279-287.

4.3.1.2.2 Dry cover

It should be noted that the term 'dry cover' does not mean that it does not contain water. This term is merely used to differentiate between this type and 'water covers'. A dry cover or soil cover is a cap-and-cover solution common to other waste materials. Following the termination of mining and the cessation of active tailings deposition, ponded water is removed from the surface of the tailings deposit and the surface allowed to dry, although much of the finer-grained tailings remain soft and saturated. A low-permeability cover is then constructed over the surface and graded to enhance run-off, sometimes incorporating pervious layers for drainage, monitoring, or capillary breaks. In principle, such a cover achieves two purposes:

- (1) it restricts oxygen from the surface tailings and oxygen diffusion into void spaces, reducing reaction rates and therefore ARD generation, and
- (2) thereby, the cover acts to prevent ponding and reduces the infiltration of surface water, thereby restricting transport of reaction products.

In practice, however, for a variety of reasons these effects can be hard to assure and may be only partially realised. Moreover, suitable cover materials may not be locally available, and the cost and difficulty of earthwork operations on the soft tailings surface can be considerable.

[13, Vick,]

A general method to design a dry cover is to arrange a number of layers consisting of different soil types as clay, silt, sand and gravel. How effective the cover is depends on the content of moisture in the covering layers. The total thickness of the cover layers normally range between 0.3 - 3.0 m and the permeability for the sealing cover ranges between 1×10^{-7} – 1×10^{-9} m/s.

Different investigations have demonstrated that the relationship between the diffusion rate and the degree of water-saturation is strong and highly non-linear. The following figure shows the ratio between the effective diffusion coefficient for porous material with a given water saturation and diffusion in air as proposed by Collin [140, Collin, 1987].

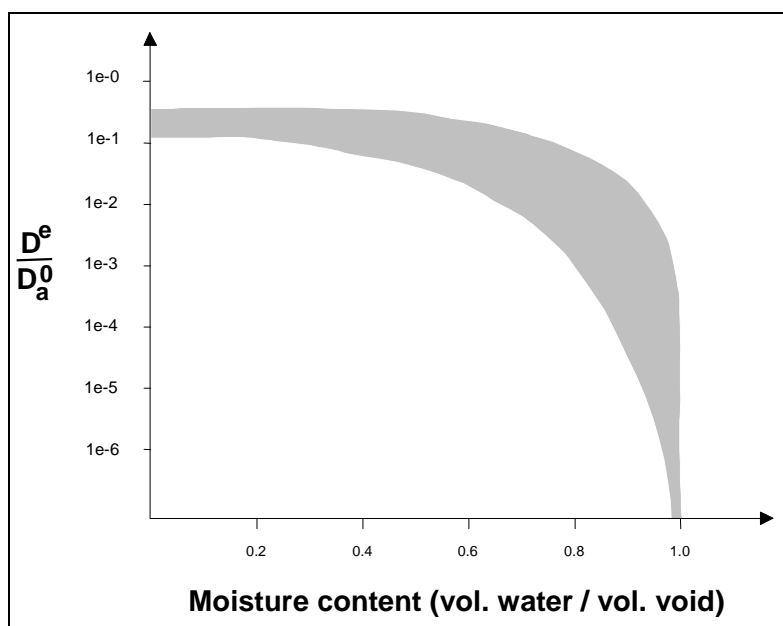

Figure 4.6: Ratio between the effective diffusion coefficient in a porous material partially water-saturated and diffusion in air

Before the tailings pond can be covered it has to be dewatered so the sand can consolidate. The consolidation can take a long time depending on the properties of the sand. Consequently it is sometimes necessary to apply a dust control cover on the tailings to prevent dusting during the consolidation phase. To prevent the gathering of water, it is common practice to construct by-pass ditches and to reshape the surface of the pond. Ideally the surface should decline 0.5-1.0 % towards the edges of the pond. [66, Base metals group, 2002]

The sealing layer is protected from drying out and from mechanical destruction through the application of a protection layer. The protection layer is vegetated.

The short-term efficiency of a dry cover can decrease in the long term as a consequence of different destructive processes that may cause cracks or other discontinuities in barrier layers. Such processes are erosion, frost action, drying, differential settlements, root penetration, digging animals and man-made intrusion [95, Elander, 1998].

The simplest soil cover is unspecified, uncompacted soil material, as in example A (see Figure 4.7 below). Under Nordic conditions, a 1.0 to 1.5 m of till cover is likely to decrease the oxidation rate by 80 – 90 %. To enhance the performance of the cover a number of actions can be taken. The disadvantage of a single unspecified soil layer on top of the tailing is that the volume of infiltrating water is just slightly reduced (~10 %), while the reduction of oxygen diffusion is also limited if the groundwater surface is not raised to reach up into the cover.

If the available cover material has a relatively low hydraulic conductivity when compacted, an option to improve this simple soil cover (example A) is to place the cover in on 2 or more layers and then to compact each layer individually. This reduces the hydraulic conductivity, and thereby the degree of saturation is increased, which in turn reduces the effective oxygen diffusion coefficient.

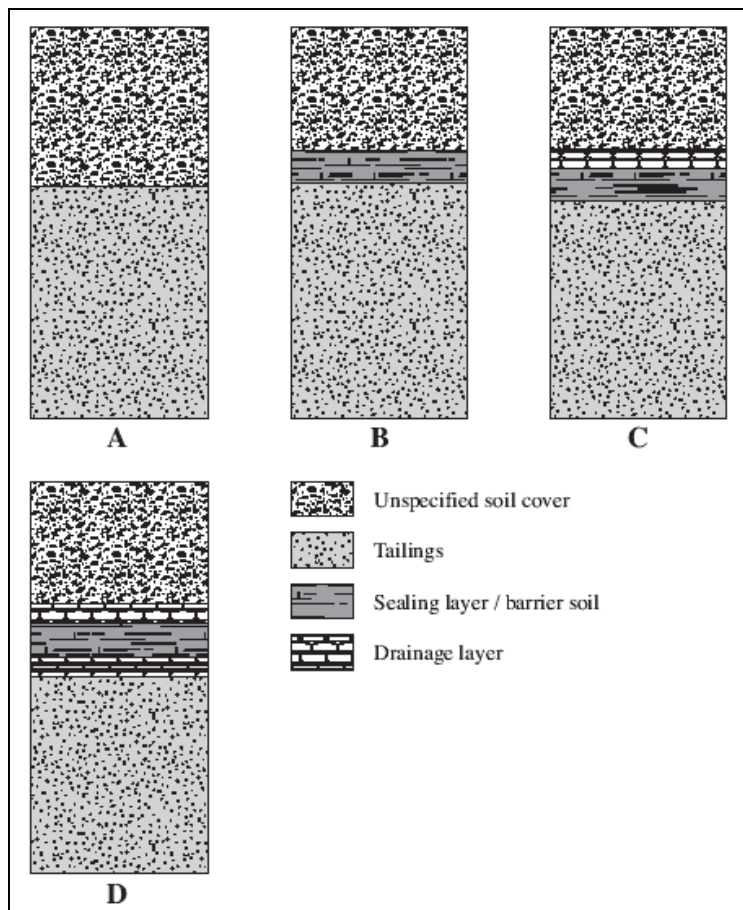

Figure 4.7: Four different soil-cover designs

A more advanced soil cover includes a compacted sealing layer with low hydraulic conductivity, such as clay or clayey till (where larger stones have been removed), as in example B in figure 4.7. In Kristineberg in Northern Sweden, applying this type of cover has been estimated to reduce the oxidation by >99 % if 0.5 m of compacted clay and 1.5 m of protective till is applied on top of the tailings (the cover actually built in Kristineberg was 0.3 m compacted clayey moraine and 1.2 m protective layer of unsorted moraine). Water infiltration was reduced by >95 % and the amount of metals transported out of the impoundment with the leachate was estimated to be reduced by >99.8 %. The required thickness of the protective layer depends on the local climatic conditions (freezing, drying out, precipitation etc, and on the local flora and fauna, i.e with respect to root penetration depth, digging animals, etc. and the characteristics of the available protective cover material. In Europe, protective cover thickness range from between 0.5 m (e.g. in Aznalcóllar, Spain; determined by the dry cycles) and 1.5 m (e.g. in Saxberget and Kristineberg, Sweden; determined by frost penetration plus a safety factor). Measurements of the temperature in the cover at Kristineberg has indicated frost penetration to a maximum depth of 0.9 m.

A drainage layer on top of the sealing layer (Example C in Figure 4.7) further reduces the infiltration, as the hydraulic gradient is kept lower, but on the downside this tends to increase the transport of oxygen into the tailings as the water content in the cover is reduced and can therefore be counter productive. A coarse layer between the sealing layer and the tailings (Example D in Figure 4.7) may act as a capillary break which prevents dewatering by capillary transport downwards and the possible diffusive transport of dissolved elements upwards. If the low hydraulic conductivity layer is dewatered, there is an increased risk for cracks, followed by an increased transport of oxygen. To prevent mixing of the coarser materials and the finer, surrounding material, a geotextile layer is usually installed in between. This however, has implications for the long term function, as the durability of a synthetic material over a time frame of thousands of years may be questionable. If the geotextile fails due to ageing or

mechanical settlement, the layers are likely to be mixed and the function of the drainage layer will be decreased or even completely prevented. To prevent erosion of the protective till cover on top of the sealing layer, a vegetation layer is applied to the protective cover. Important questions arise as to whether the roots of the local species, likely to inhabit the remediated impoundment at some point in the future, will penetrate the low permeable layer, and how thick the protective cover has to be to prevent this. Also frost/thaw effects need to be considered, as these can cause cracks and the formation of macropores, thereby leading to an increased hydraulic conductivity. After the protective cover has been applied, grass is usually used on top of the cover to prevent erosion of the protective cover. [136, Carlssons, 2002]

Section 4.3.6 addresses revegetation and restoration issues.

Examples of sites where dry covers have been implemented are Apirsa (Aznalcollar), Aitik, Saxberget, Kristineberg, and Enåsen.

Decommissioning of the tailings ponds at the Saxberget mine in central Sweden, which were decommissioned between 1994 and 1996 using a composite dry cover, has been described in literature. Two separate ponds had been used for different periods, the West pond for the period 1930 - 1958, and the East pond for 1958 - 1988. The West pond occupies an area of 18 hectares, while the East pond is twice the size, 35 hectares. In total, the tailings amount to 4 million tonnes, with a composition of about 2 % S, less than 1 % Zn and 0.5 – 1 % calcite. This mineral composition suggests that the material is potentially acid-generating, even though the tailings in the East pond produce a circum-neutral pH drainage at present. [137, Lindvall, 1997]

The ponds are located on a permeable glacial formation, which was predicted to cause a rapid fall of the groundwater table as soon as the supply of tailings slurry ceased. Large amounts of tailings would then be exposed to the oxygen in the atmosphere. During the production period, the mobilisation of zinc was estimated to be 3 tonnes per year. Studies showed that after depletion of the readily available buffering minerals, the pollution load were likely to increase considerably if the oxygen supply to the material could not be controlled.

Modelling of the future mobilisation of metal indicated an annual mobilisation of up to 600 tonnes of zinc in the ponds. Due to precipitation and adsorption processes occurring at neutral pH levels, the amount was estimated to stay at 3 tonnes per year net transport for several years to come. However, the predicted high future pollution load called for remedial actions to be taken. As the hydrogeological situation excluded flooding of the ponds, the only realistic option remaining was to utilise a cover designed to reduce the oxygen transport to the tailings.

As the proposed project would be only the second one of its kind in Sweden, and certainly the largest, there was no real practical experience at the time of developing the remediation plans. Therefore, a number of options had to be investigated. In general terms, the cover was designed in accordance with principles defined within the Swedish EPA's investigation programme aiming at long-term, low maintenance remediation solutions for mining waste. This called for a cover with at least two components: (1) a low permeability sealing layer, and (2) a protective layer on top of the sealing layer.

In the Saxberget example, the tailings were covered with 0.3 m compacted clayey till as a sealing layer and 1.5 m unsorted till as a protection layer. The protection layer is vegetated by grass and birch.

The key component was the sealing layer. For this purpose, a number of solutions were considered. One of them was to use compacted municipal sewage sludge, which was found to possess favourable hydraulic properties. For practical reasons, mainly the time factor, this alternative was rejected.

Another option was the use of fly ash from power stations in the form of 'cefyll', a concrete-like product which had been investigated, and used, in a similar project. The major drawback for this alternative was the cost, as the source for the fly ash (coal-fired power and thermal plants in the Stockholm region) was too distant.

Investigations of glacial till occurrences in the area showed large amounts of clayey till close to the mining area. As this material was found to have excellent hydraulic properties, and the cost was the lowest of all the alternatives, this became the sealing material selected.

A modelling of oxygen and water transport, coupled to solubility calculations, yielded figures for metal transport. Based on these calculations, the specifications for the permeability of the sealing layer were established as; 0.3 m with a permeability of 5×10^{-9} m/s.

The extent of the protective layer was subject to discussion. The mining company claimed that 1 m of unclassified till would constitute sufficient protection against frost and root penetration. The EPA argued in favour of a thicker cover, and finally it was agreed that a 1.5 m protective layer should be used.

The layout of the tailings area was designed to adjust to the surrounding landscape as much as possible. Surface run-off water is led in a small stream winding along the West pond. The drainage from the West pond overflows to the East pond and forms large areas of shallow wetlands. In this way, water saturation is maintained in the sealing layer, and it gives the area an attractive and varied appearance. Excess water is discharged through a stone paved outlet down the former dam slope.

Follow-up results show a positive trend in the development of the contaminant load from the area. It is, however, too early to draw any conclusive results about the performance of the cover. [100, Eriksson, 2002]

To keep the cover from eroding, the surface water is collected and discharged in a controlled fashion.

After the failure of the tailings pond in Aznalcóllar, which still contained 96 % of the tailings stored before the accident, a dry cover was applied on the 150 hectares tailings pond. The active part of this cover consisted of a sealing layer of 0.5 m compacted clay ($k=10^{-10}$ m/s) and a 0.5 m protective cover. In addition to the cover, a stabilising berm was also put in place to avoid any further movements of the dam, the dam crest was lowered to increase the safety factor, the dams were resloped to 1:3 (V:H), drainage channels were constructed on top of the cover to manage surface run-off, a cut-off wall was installed around the pond, and finally a network of back-pumping wells were installed inside the cut-off wall to collect any drainage from the dewatering of the tailings. The cost was in the order of USD 37 million for the project (EUR 22/m²). Furthermore a comprehensive monitoring programme was implemented to insure the performance of implemented measures.

The following diagram shows the applied solution at the Apirsa mine.



Figure 4.8: Collection and discharge channel at closed Apirsa tailings pond

4.3.1.2.3 Subaqueous tailings disposal of reactive tailings

Subaqueous tailings disposal means the disposal of tailings under water. The objective of subaqueous tailings disposal is to minimise the contact between atmospheric oxygen and the tailings, and thereby to minimise the oxidation of reactive materials, especially the oxidation of sulphides. The objective is normally to maintain a permanent water cover on the tailings during operation as well as after closure.

The effectiveness of the subaqueous tailings disposal is mainly based on four mechanisms, as summarised by Robertson et al. (1997):

1. reduced availability of oxygen, due to two reasons: (1), the saturated oxygen concentration in water is 25000 times lower than in air, (2) the oxygen diffusion coefficient is 10000 times lower in water than in air. This means that very little oxygen is available for oxidation reactions and that the transport process to supply oxygen is very slow
2. sulphide reduction. At low oxygen concentration levels in the water, sulphate reducing bacteria consume sulphate and thereby produce hydrogen sulphide, which easily reacts with most dissolved metals and form a stable precipitate
3. oxide scavenging. This involves the formation of iron and manganese oxides which are effective in absorbing a broad range of dissolve metals
4. sediment barriers. After production has stopped, a sediment layer will naturally develop on top of the deposited tailings which is very effective in minimising the interaction between the tailings and the overlaying water.

The subaqueous disposal method was studied in detail by the Canadian Research Programme MEND. The ultimate result of this research project was the development and release of the Design Guide for the subaqueous disposal of reactive tailings in constructed impoundments (MEND, 1998) which in a detailed way describes all relevant aspects of designing a subaqueous tailings disposal site. Numerous publications focusing on detailed geochemistry in water covered tailings have been produced by the University of Luleå at Stekenjokk and the Kristineberg water covers, mainly by Öhlander, Ljungberg and Holmström (e.g., Ljungberg, 1999; Holmström, 2000).

Subaqueous disposal or submerged tailings disposal can, in principle, be done in constructed impoundments (tailings ponds), flooded open pits, natural lakes or in marine conditions. The environmental and political complexity increases in the same order as the disposal alternatives are listed. Normally one out of two methods of disposal are commonly used:

- a floating pipeline, that discharges the tailings under the water surface into the disposal facility which is normally mobile in order to distribute the tailings over the facility
- a submerged pipeline, that discharges the tailings below the water surface.

Applying deep sea tailings management, either confined or unconfined, reduces engineering requirements (i.e. no dam needs to be built or maintained), increases the chemical stability and reduces the footprint on land. Therefore deep sea or lake deposition eliminates dam safety issues. Often submarine tailings management is considered risky because of the inability to predict, control or rectify the spread of contaminants throughout the environment. Another concern is that too little is known about the subaqueous environment and therefore an impact assessment is difficult to undertake.

Underwater disposal can provide the most efficient means of preventing the oxidation of sulphides. This will result in better water quality during operation, with eliminated or reduced needs for water treatment.

Underwater disposal minimises material demands at closure and eliminates the need for extensive borrow pits to be opened for the cover material. Some additional advantages with subaqueous disposal are, e.g. the elimination of dust emissions as there is no beach, and on improved visual impression.

Underwater deposition is slightly more costly compared to conventional deposition above the water level, as it requires more day to day adjustments in order to optimise the filling of the pond. Final decommissioning costs are drastically lower.

Several criteria need to be taken into account to determine the applicability of this technique. The hydrological situation is critical, with a **need for a positive water balance**. The physical capacity for storage under water needs to be sufficient. For large mines, very large and deep lakes or access to the ocean is required or, else large dams need to be constructed, which is not always possible.

The Lökken mine in Norway used continuous underwater deposition. The Lisheen mine currently uses this technique. Water covers, or other techniques to submerge tailings, waste-rock and mines are successfully used as a decommissioning method and are described in literature (e.g., Eriksson et al., 2001; Pedersen et al., 1997; Amyot and Vézina, 1997). A detailed performance study on water covers was carried out within the MiMi research project (<http://mimi.kiruna.se>).

References

Amyot G. And Vézina S., 1997. Flooding as a reclamation solution to an acidic tailings pond: the Solbec case. Proceedings to the Forth International Conference on Acid Rock Drainage, Vancouver, vol. 2, 681-696.

Eriksson N., Lindvall M. and Sandberg M., 2001. A quantitative evaluation of the effectiveness of the water cover at the Stekenjokk tailings pond in Northern Sweden: Eight years of follow-up. Proceedings to Securing the Future, International Conference on Mining and the Environment, Skellefteå, June 25 - July 1, 2001.

Holmström H., 2000. Geochemical processes in sulphidic mine tailings: field and laboratory studies performed in northern Sweden at the Laver, Stekenjokk and Kristineberg mine-sites. Doctoral Thesis, Luleå Technical University, 2000:03

Ljungberg J., 1999. The Geochemical Dynamics of Mine Tailings at Laver, and Stekenjokk, Northern Sweden. Doctoral Thesis, Luleå Technical University, 1999:38

MEND, 1998. Design Guide for the subaqueous disposal of reactive tailings in constructed impoundments. MEND report 2.11.9.

Pedersen T.F., McNee J.J., Flater D., Mueller B., Sahami A. and Pelletier C.A., 1997. Geochemistry of submerged tailings in Buttle Lake and the Equity Silver tailings pond, British Columbia and Anderson Lake, Manitoba: What have we learned? Proceedings to the Forth International Conference on Acid Rock Drainage, Vancouver, vol. 3, 989-1006.

Robertson J.D., Tremblay G.A. and Fraser W.W., 1997. Subaqueous tailings disposal: A sound solution for reactive tailing. Proceedings to the Forth International Conference on Acid Rock Drainage, Vancouver, vol. 3, 1029-1041.

[122, Eriksson, 2003]

4.3.1.2.4 Oxygen consuming cover

An oxygen consuming cover uses a low permeable layer with a high water content as an oxygen diffusion barrier. The low permeable layer, and possibly also the protective layer, will have a high content of organic matter which, when degrading, consumes oxygen and thereby reduces oxygen transport to the underlying sulphides. Access to large quantities of suitable organic matter is a prerequisite for this method to be viable.

Example of sites where this type of cover is implemented are Galgberget (Central Sweden) and Garpenberg (Central Sweden).

[95, Elander, 1998] describes the decommissioning of the Galgberget tailings pond using an oxygen consuming cover in the following manner¹⁵:

One example plant is Galgbergsmagasinet, a tailings pond in Falun, Sweden, a cover with a high content of organic material was constructed from paper mill sludge, fly ash and wood waste. On the top of the tailings pond a 1 m thick layer of fly ash mixed with paper mill sludge was laid out and compacted in two layers and thereafter covered with a 0.5 m layer of wood waste and coarse till. This cover is believed to form an effective barrier against oxygen transport partly due to consumption of oxygen in the cover and partly due to a physical barrier effect in the compacted low permeable mixture of fly ash and paper mill sludge. The hydraulic conductivity of the mixture was measured in the laboratory at $\leq 5 \times 10^{-9}$ m/s and the water retention capacity was measured and considered satisfactory to maintain a high degree of saturation in the barrier. Other possible positive effects are inhibiting of the acidophilic leaching bacteria due to the high content of calcium hydroxide in the fly ash that will raise the pH in the percolating water, and the formation of a sustainable environment for sulphate-reducing bacteria producing hydrogen sulphide that precipitates metals. However, there is also a risk that the combination of organic compounds and iron hydroxides in the upper (oxidised) part of the deposit could produce bacterial iron reduction that would dissolve co-precipitated heavy metals. The ongoing follow-up indicates that the oxidation of sulphides has decreased and that the pH at the site is higher than at the reference site. No evidence of any significant bacterial sulphate reduction has yet been noticed.

¹⁵ From the MiMi (1998) state-of-the-art-report on "Prevention and control of pollution from tailings and waste-rock products The entire report can be downloaded from the following web site:<http://www.mimi.kiruna.se>

Another example of where an oxygen consuming cover has been constructed is the reclamation of the East Sullivan Mine in Quebec. Furthermore, in a combination of bench and pilot scale laboratory testing three different organic materials (peat, lime stabilised sewage sludge and municipal solid waste compost) were investigated in order to evaluate their effectiveness as oxygen consuming covers (Elliot et al 1997).

4.3.1.2.5 Wetland establishment

Wetland establishment as a closure method uses the same principle as the water cover but with less water depth as the plant cover stabilises the bottom thereby avoiding the re-suspension of tailings. Less water in the pond reduces the potential risk for a dam failure. The prerequisites are the same as for water covers but with the additional requirement of adding organic matter, to enhance the establishment of the wetland vegetation in the pond.

It should be noted that the principal idea of a wetland establishment is not the treatment of the water but the establishment of a self generating and sustainable cover that reduces the requirements for the water depth and that acts as a oxygen consuming barrier when organic matter is deposited on top of the water saturated tailings.

Several UK coal TMFs have been restored as wetlands, most notably Rufford Lagoon No. 8. This was reported to the British Dam Society in “The prospect for reservoirs in the 21st century” (Proceedings of the tenth conference of the BDS held at the University of Wales, Bangor on 9-12 September 1998): Ed. Paul Tedd: Thomas Telford, 1998 ISBN 0 7277 2704 4 and also to the Institution of Mining and Metallurgy (Nottinghamshire and South Midlands Branches) and published in “International Mining and Minerals”: January 2001 No. 37. ISSN 1461-4715. An update (June 2001) was reported to the 3rd British Geotechnical Association Geoenvironmental Conference held at the University of Edinburgh in September 2001 published in “Geoenvironmental Engineering – Geoenvironmental impact management”: Ed. R.N. Yong & H.R. Thomas: Thomas Telford, 2001 ISBN 0 7227 3033 9.

Examples of sites where wetlands are considered/planned to be implemented are Lisheen and Kristineberg. [100, Eriksson, 2002]

4.3.1.2.6 Raised groundwater table

For this method, a thin cover is applied with the objective of raising the phreatic surface above the tailings level, thereby preventing oxidation. This is an intermediate (e.g. ‘between’ wet cover and dry cover) solution for water saturation without creating open ponds.

The benefit of the method is, apart from the reduced thickness of the cover, the lack of need for compaction of the cover and the drastically reduced quality requirements on the cover material.

This is applicable in TMFs with a phreatic surface already close to the tailings surface.

It is more costly than a water cover, but cheaper (as it is thinner) than a dry cover.

This method is practised in two ponds in Kristineberg, both containing strongly weathered material. As the material is entirely water saturated, further oxidation is inhibited. This is accomplished without the problems connected to flooding (i.e. the dam stability issue). The basis for such a measure is careful groundwater modelling, taking into account the influence from surface water management and groundwater raising dams.

[100, Eriksson, 2002]

4.3.1.2.7 Depyritisation

This method is somewhat similar to selective material handling, but is carried out as part of the mineral processing in the mineral processing plant. Pyrite can be separated by flotation and handled separately. It is applicable if the ARD potential of the bulk amount of tailings can be altered significantly (i.e. converted from ARD generating to non-ARD generating) by lowering the pyrite content. The de-sulphurised tailings will require less extensive decommissioning measures.

Flotation is the predominating technique for the separation of sulphides. Pyrite can be recovered from siliceous tailings with good recovery, using xanthates and frothers in a dedicated flotation circuit.

The flotation of pyrite is used in some plants to recover pyrite as a sulphur source for sulphuric acid production. The technique is well known. Both acid and alkaline processes are used. The pyritic product has a high reactivity and therefore carefully designed measures for deposition are required. Suitable disposal alternatives for the pyritic product could be underwater disposal in abandoned open pits, in mine voids or in the tailings pond at a location where the groundwater level will cover the material at all times.

Cross-media effects to be considered are:

- small additional energy and reagent requirements for the pyrite flotation
- energy penalty for separate management of high-pyrite and depyritised tailings.

Flotation and separate management of the pyrite will also require significant costs.

The viability of this technique is ruled by the pyrite content necessary to be removed. If this content is too high, the cost impact is negative. One criterion is that the resulting pyrite content needs to be sufficiently low to secure buffering.

Example plants are the Bolidens mill #1, which produced pyrite for sale until 1991, and the Pyhäsalmi mill, which still produces pyrite. It is not known whether any plant separates pyrite as a part of the reclamation plan.

At the Aitik copper mine, depyritisation is considered as a key element in the closure plan for the tailings pond. At this site, it is expected, based on hydrogeological modelling, that only a small fraction of the decommissioned pond will be dewatered during dry periods. The plan is to perform depyritisation of the tailings during the final couple of years of production, so that a top layer of tailings with a low sulphur content are created. This concept includes the separation and the separate management of the pyrite fraction with a sulphur content between 30 and 35 per cent and the depositing of it into a separate section of the tailings pond. Deposition of the pyrite will be arranged in a pond with permeable dams, raised concurrently with the surrounding structures. The area of the pyrite pond will occupy 0.5 – 1 % of the total area (6 - 12 ha). This pond will mainly be water saturated, but at closure it could also be covered using the concept of a soil/dry cover.

4.3.1.2.8 Selective material handling

Selective material handling needs to be applied during operation in order to be effective. By selectively depositing reactive and non-reactive tailings or waste-rock, the decommissioning of the non-reactive part can be significantly reduced. It might even be possible to find alternative uses for the non-reactive fraction.

As an example the selective management of ARD and non-ARD generating waste-rock is discussed here:

Geological formations at a sulphide ore deposit often exhibit zonation, with elevated pyrite content in the layers near the ore. In open pit mining, it is in some cases possible to manage waste-rock types selectively using the geochemical properties as a criterion. Careful geological mapping and follow-up analyses using drilling chips are means to provide the information required for classification. Based on this, it is then possible to separate the non-ARD waste-rock from the ARD-generating waste-rock.

The operating and decommissioning requirements for waste-rock depend on the net ARD generation potential. Waste-rock that does not have the potential to produce ARD will require less extensive decommissioning measures than waste-rock with ARD production potential.

If no selective waste-rock handling was applied, the entire waste-rock would need to be prevented from generating ARD. By applying selective handling, the ARD-generating waste-rock fraction is more easily manageable because of the reduced amounts (compared to the total amount of waste-rock).

The selective management of waste-rock does not call for advanced technology, merely prompt routines for information gathering and management of the material according to these results.

Low sulphur waste-rock may meet the criteria for construction material and aggregates, which enables replacement quarry supplies:

Selective management requires increased costs during operation. At the time of mine closure, however, the reclamation costs may be reduced.

The applicability is ruled by the geology, the mining method, and the geochemical properties of each type of waste-rock.

Several mines in the world practise the selective management of waste-rock. Boliden's Aitik mine is one example of a large scale application.

Another example of selective material handling is the Ridgeway gold mine in South Carolina, (US), where non-reactive material mined early in the mine life was stockpiled, and then processed at the end of the mine life to provide part of the final cap on the tailings impoundment. [120, Sawyer, 2002]

4.3.1.3 Control options

When the weathering reactions cannot be prevented (such as might be the case during the operational stage of the mine life), the migration of ARD needs to be controlled. Methods that focus on minimising the transport of weathering products from the deposit into the environment include, e.g. diversion of unaffected surface water, collection of affected surface water and control of groundwater flow. Minimisation of the infiltration into the deposit is often achieved by simple covers. Other control methods, as can be seen in the following table are blending and the addition of buffering minerals.

Control method	Used principle
Blending	Adds tailings and waste-rock with high buffering capacity to potentially ARD producing material, thereby pH can be maintained at a neutral level
Addition of buffering minerals (liming)	Adds buffering capacity to potentially ARD producing material, thereby pH can be maintained at a neutral level
Compaction and ground sealing	By a combination of compaction and sealing of the underlying strata, ARD generation is minimised and uncontrolled seepage into the ground is avoided (see Section 4.3.10.4)

Table 4.8: ARD control methods and the principle on which their function is based

4.3.1.3.1 Addition of buffering material

The addition of buffering materials (e.g. limestone) is normally practised before applying a dry cover. This helps to immobilise the weathering products readily available at the time of the decommissioning of the site.

It is also theoretically possible to use this as a decommissioning method, as an addition of enough buffering material would delay or even eliminate a drop in pH and the production of ARD. However, to accomplish such a long-term buffering effect in a potentially ARD generating deposit normally requires large amounts of buffering materials, which would need to be brought in to the site at prohibitively high cost.

[100, Eriksson, 2002]

This "blending" is only feasible if the buffering material is already available at the site and preferably as part of the waste generated at the site. Otherwise the transport costs will be too high.

4.3.1.4 Treatment options

During the operational phase of a mine or where the minimisation of the sulphide oxidation rate is not readily obtainable, it may become necessary to collect and treat the drainage before it reaches the environment. This treatment could be done either through passive treatment (e.g. wetlands or anoxic limestone drains) or through active treatment in a water treatment plant (straight liming, HDS-process, etc). At closure, it may be necessary to treat the drainage even after a cover has been put in place, until the impact of releasing the resulting drainage to the environment can be regarded as acceptable.

Effluent treatment techniques are described in Section 4.3.11.

4.3.1.5 Decision making for closure of ARD generating sites

Various guidelines for mine closure planning have recently been developed (e.g. MIRO, 1999, "A technical framework for mine closure planning", Mineral Industry Research Organisation, Technical Review Series No. 20). The following figure presents one of the decision trees used in the literature for closure design of a potentially ARD generating tailings and waste-rock deposit.

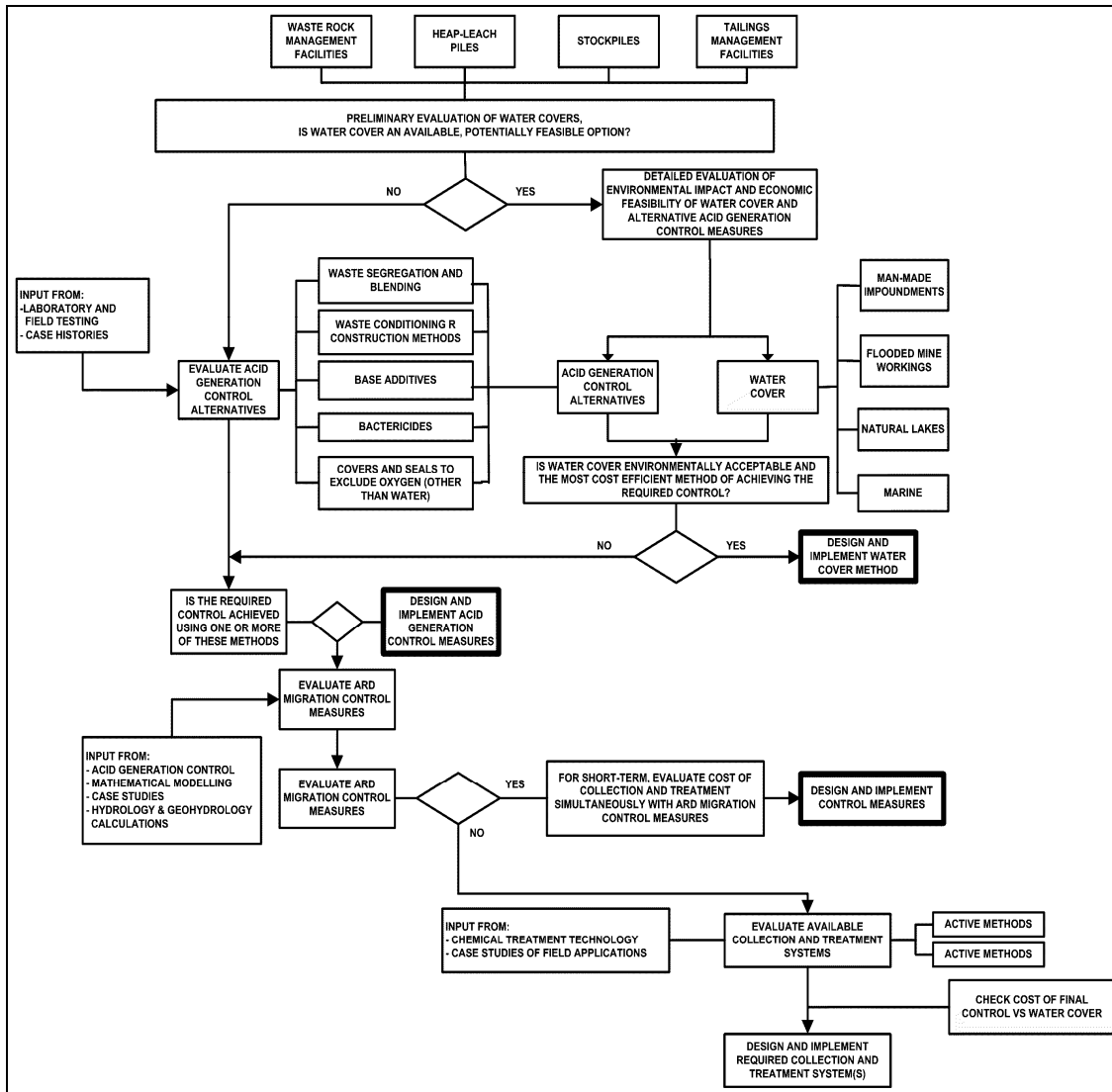

Figure 4.9: Decision tree for closure of a potentially ARD generating tailings and waste-rock management facility [20, Eriksson, 2002]

Depending on the mineralogy, physical, chemical and biological characteristics sulphide oxidation may take place over an extended period of time. This is taken into account when designing management facilities for potentially ARD generating tailings and waste-rock.

4.3.1.6 ARD management at a talc operation

This subject is typically not relevant for industrial minerals, except in Finnish talc deposits. In these specific cases, there is ARD generating fraction of the waste-rock consisting of black schist. The normal carbonate containing waste-rock does not generate ARD.

To prevent or reduce ARD generation in this case, the following techniques are used:

Selective management of ARD and non-ARD waste-rock

The waste-rock is mainly carbonate containing low quality talc-magnesite rock or black schist. Black schist contains ARD generating minerals (sulphides). In the construction of waste-rock piles, ARD waste-rock is surrounded by carbonate rock, which buffers the ARD of black schist. Waste-rock piles have to be planned carefully with a long-term view to manage ARD waste-rocks as well as possible with the lowest costs.

Reduction of infiltration

During construction of the waste-rock piles, the slopes are flattened and covered with local moraine. This reduces erosion and supports vegetation growth. Applying a moraine cover with well-planned surface run-off collection and vegetation, prevents most of the rain and snow melting waters (75 %) going through to the waste-rock piles. Seepage waters coming through the piles are collected and treated with lime if they are still acidic and contain metals.

Reduction of ARD generation in tailings ponds

During operation of the tailings ponds, the majority of the tailings are covered by free water so that the ARD generation minerals (sulphides) are usually in non-oxidising conditions and therefore only limited amount of acid seepage is generated. The tailing are mainly magnesite (Mg-carbonate), which is a buffering mineral that forms a non-ARD environment inside the ponds. However, in some operations, old copper mine sulphide containing tailings are below the present magnesite layers. Sulphide containing layers are designed to stay in a stable condition after closure of the operations by covering the tailings ponds with a dry cover of local moraine. Rain and snow melting waters are collected on the old pond to keep the water table high enough to prevent oxidising of the old sulphide tailings. Seepage waters from tailings ponds are collected to treat them outside the pond area with lime or wetland technology.

Wetland technology to treat seepage waters from tailings ponds or waste-rock piles

In wetland technology (see Section 4.3.11.5), the seepage waters are collected into a wetland area constructed on an old pond or on swamp areas close to the operation. Using neutralising construction materials (carbonate rocks) and natural specific vegetation, the metals in seepage waters are precipitated and clean waters can be lead towards local rivers/lakes.

[131, IMA, 2003]

4.3.2 Techniques to reduce reagent consumption

Efforts are being made to reduce the amount of reagents added. This provides economic and environmental benefits. In many cases, the ore feed is constantly monitored for its chemical composition, which then allows the reagent addition to be automatically adjusted to optimum values.

In general, as far as technically and economically feasible, the use of biodegradable chemicals is promoted. Usually, reagents cannot be recycled because they are strongly bonded to the surface of the particles [131, IMA, 2003].

4.3.2.1 Computer-based process control

Process-computer based process control is a key factor for optimising recovery in the mineral processing as well as reagent consumption. Reductions of reagent consumption have been reported to reach a level of up to 30 % after introduction of process control systems. By applying this control, all relevant information concerning the process is collected in a computerised system and shown on screens in control rooms and other strategic places. This may be a totally computerised system where the dosage of chemicals is controlled automatically or a semi-computerised system where the operators execute the changes in the dosage of the chemicals with guidance from the information displayed by the computers.

Advantages:

- high level of control of the process is possible, which allows for optimisation of the reagent usage
- adjustments of the process are easy to perform.

Disadvantages:

- expensive to install
- demands a high level of computer skills by the operators.

[118, Zinkgruvan, 2003]

In the flotation process, it is necessary to analyse products on a regular basis, so reagent adjustments can be very sharp. Some on-line analysers are available on the market, but so far none of them have been efficiently applied in the Industrial Minerals sector.

[131, IMA, 2003]

The success of the flotation process is based on the proper use of the chosen set of chemicals. Any reduction of the prescribed chemicals may affect the financial results of the production significantly. However, it is also necessary that the use of chemicals is kept to a minimum for economical and ecological reasons. To achieve this, often the ore grade is measured frequently or even constantly so that the reagent addition can be adjusted accordingly. Newer technologies in this area are cameras that monitor the froth on the flotation cells on-line. Together with expert systems this results in an optimisation of the process conditions and therefore in higher recovery rates and a more advantageous use of reagents [69, Nguyen, 2002].

4.3.2.2 Operational strategies to minimise cyanide addition

The following operational strategies are applied to minimise cyanide addition:

- taking steps to reduce the consumption of cyanide by other components such as copper minerals, pyrrhotite, etc.
- attempting to retain cyanide in the circuit rather than discharging it to the tailings pond. This may be achieved by washing the tailings, where practical
- employing a strict control of water additions to the circuit, to reduce the need to discharge the solution in order to maintain a water balance. In arid climates no-discharge facilities are possible
- utilising a close monitoring of the cyanide concentration in the process and in the tailings, in order to keep cyanide addition to a minimum. Some sites have installed on-line analysis systems (e.g. automatic cyanide control, see below). These instruments can be coupled with automatic reagent dosing instrumentation
- improving aeration in the leach and/or adding oxygen or other oxidants to achieve the maximum rate of dissolution
- applying pre-aeration (e.g. using hydrogen peroxide, see below) of the slurried ore before cyanidation to oxidise the cyanide consuming constituents, which can then be thickened and removed from of the process
[24, British Columbia CN guide, 1992]
- using gravity separation, if possible, and leaching the concentrate from this process. Gravity concentration can nowadays be applied down to a grain size of 30 μm .

4.3.2.2.1 Automatic cyanide control

Up until about a decade ago, it was common practice to only dose cyanide manually into the cyanidation circuit by adjusting a valve, with the result that overdosing often occurred, leading to CN losses. A typical value for the loss of cyanide was 10 %, however values up to 30 % were possible.

The manual method has the additional disadvantage that samples are taken only every few hours, meaning that a long time can pass before the desired adjustment can occur. Also, the sample taken is manually filtered and then titrated manually using silver nitrate, measuring the optical endpoint, but meaning that the result could be erroneous since it is operator dependant.

With the introduction of automatic cyanide detoxification technologies, it is possible to take samples at a frequency of approx. every 5 - 15 min, and to automatically and promptly adjust the cyanide concentration close to the desired set point, accordingly. In this manner, it is often possible to save up to 10 – 20 % of the cyanide compared to the manual operation, whilst achieving the same gold recovery.

Many small gold mines still use manual dosage, since a certain critical or threshold cyanide consumption of about 500 t NaCN per year is necessary for economical viability. However above this threshold in most cases it is economic for the operator to apply this technique.

In short, the benefits of this technique are:

- savings in CN
- reduced CN destruction cost.

Rio Narcea (El Valle operation) uses automatic cyanide control.

The capital cost for such an automatic system is around EUR 100000, but depend on the size of the operation.

4.3.2.2 Peroxide pretreatment

Although not universally applicable, many ores have very reductive properties when in an ore pulp (often but not always sulphide ores), with the result that standard aeration or oxygenation may not be sufficient to provide sufficient dissolved oxygen and/or oxidative properties for the oxidation of gold. This is necessary in cyanidation, since otherwise, the gold cannot be leached using cyanide, or this may only occur extremely slowly.

If the aeration is carried out using hydrogen peroxide (H_2O_2) instead of air or oxygen gold recovery can be increased. One positive side effect is a reduced cyanide consumption, since less cyanide is consumed by the sulphides.

This technique is generally applicable to ores containing sulphides. However a detailed mineralogical study laboratory scale test is necessary to determine which ore is suitable for this treatment.

The consumption of hydrogen peroxide is often c. of 1 kg H_2O_2 per tonne of ore treated. The cost of H_2O_2 is around EUR 600 per tonne of (70 %) H_2O_2 .

Capital cost for the treatment plant are around EUR 100000, but vary widely depending on the throughput, the hydrogen peroxide consumption and on the ore mineralogy.

4.3.2.3 Pre-sorting

By presorting the feed to the mineral processing plant by either manual (naked eye) or optical sorting, it is possible to reject some fractions which are not appropriate for further processing. These basic practices are widely used in the industrial minerals industry. On top of that, these techniques have no impact on the environment and can be inexpensive. To apply the rejected fractions can often be used for building tailings dams or as construction materials. The choice between manual and the optical sorting depends on the ore characteristics.

4.3.3 Prevention of water erosion

Water erosion of tailings or waste-rock management facilities during the operational phase can be avoided by using the following techniques:

- covering the sloping surfaces of the impoundment with a protective layer such as gravel, a soil and grass cover, geofabric and grass cover, or some form of synthetic coating
- impregnation of the surface layer of the tailings with a chemical which can repel water or result in particle binding, such as a silica compound, cement, bitumen or bentonite
- using the chemical properties of the tailings, such as those containing sulphides, to assist in particle binding.

4.3.4 Dust prevention

The following table lists ways in which **solid** tailings are disposed from dams or heaps and some prevention options.

Solids may be dispersed by:	Prevention:
Wind erosion to the surfaces of the impoundment: <ul style="list-style-type: none"> ▪ crest of dam/heap ▪ slopes of dams/heaps ▪ surface of the beaches 	<ul style="list-style-type: none"> ▪ dam crest and slopes may be treated as for water erosion ▪ surface may need wind breaks, water spraying, application of binding material, i.e. spraying with bituminous emulsion [8, ICOLD, 1996], surface mulch [11, EPA, 1995], lime slurry ▪ in extreme cases tailings may have to be deposited under water ▪ surface vegetation, either floating or on inactive areas ▪ frequent change of discharge points around perimeter to achieve constantly wetted surface [11, EPA, 1995].

Table 4.9: Dispersion by wind erosion of solid tailings from tailings and waste-rock management facilities and prevention options

4.3.4.1 Beaches

To minimise dusting from beaches, the surface is usually kept wet. For example **water spraying** on red mud is applied when dusting conditions are imminent. This is more cost effective than placing decaying vegetation such as hay on the red mud surface. Covers such as hay impede the optimum maturation of the red mud deposits. At the Aughinish site, sprinklers are distributed throughout the TMF and raised with the tailings level. Such a system can only be applied where tailings can be accessed by vehicles, i.e. for thickened tailings.

Sprinkling of the beach in combination with the continuous management of the discharge point of the tailings onto the beach is normally satisfactory. Sprinkling is often applied in thickened tailings operations.

Advantages:

- water from inside the TMF can be utilised
- not expensive.

Disadvantages:

- problems in cold climates with freezing
- labour intensive.

Another method to avoid dusting is to **cover the beach** with non-dusting material such as topsoil, lignine compounds, straw or bitumen. This method is only practical when the beaches are raised in campaigns and not continuously. The beach must be stable enough for machinery to work on it in order to spread the material, otherwise alternative costly methods such as using helicopters are required for the placement of the material. The application of vegetative covers, such as tree bark or hay, can be very effective but they inhibit the maturation of the tailings deposits. The technology to apply these on very soft but maturing tailings is very expensive to develop and operate.

Advantages:

- once the material is put in place the dust problem is solved for a long period.

Disadvantages:

- the beaches cannot be continuously raised
 - the non-dusting material might have to be removed when raising the dam
 - the beach must be stable enough for machinery to work on it in order to spread the material.
- [118, Zinkgruvan, 2003]

At the tailings pond in the **Legnica-Glogow copper basin**, the water level inside the pond is kept at a distance of at least 200 m from the dam crest. The beach constitutes a considerable source of dust emissions, especially on windy days. To reduce this dust a water ‘curtain’ is installed on the crest. Additionally, to stabilise the surface in sections which are temporarily dry, an **asphalt emulsion** is sprinkled from a helicopter. Currently, additional water ‘curtains’ are being tested. These are installed inside the pond on the beach at a distance of 150 m, and are put into operation when a dry section (after removing the asphalt cover) is being utilised for dam construction.

At **Pyhäsalmi**, **spraying of lime slurry** has been used to prevent the wind erosion of the fine particles of the tailings. Spraying has been done by equipment originally made for agricultural uses. This consists of a tank mounted onto a tractor and pump and hose system. This equipment has the capability to disperse the lime slurry in more or less even layers to the desired areas. When drying, the lime forms a hard surface layer, which lasts throughout the dry summer period. Based on visual inspections this technique has significantly decreased the effects of dusting. However, there is no reliable data demonstrating the achieved benefits.

It should be noted that at Pyhäsalmi the lime slurry spraying is only done for the purpose of the mechanical and physical prevention of dusting and not to prevent any chemical purposes (i.e. neutralisation of ARD). With better equipment the result could be more homogeneous and efficient. The costs of this technique has been around EUR 1500/ha, which is relatively high considering the demanded area (5 – 6 ha) and the need for spraying every year (spring time).

Another, organisational way of dust reduction/prevention is to utilise a frequent change of discharge points around the perimeter to achieve constantly wetted surface [11, EPA, 1995] or to constantly keep the tailings water covered (see Sections 4.3.1.2.1 and 4.3.1.2.3).

4.3.4.2 Slopes

One way to prevent dusting from the slopes of the dam is to cover the slopes with coarsely crushed waste-rock.

Advantages:

- non expensive if the operation has an excess of waste-rock
- dam stability will be increased with the extra amount of weight from the waste-rock.

Disadvantages:

- additional cost for crushing and putting in place.
[118, Zinkgruvan, 2003]

4.3.4.3 Transport

Tailings and waste-rock are usually transport by pipeline (only slurried tailings), conveyor belt or trucks. If by of pipeline transport (of slurried tailings), no dust emissions occur.

4.3.4.3.1 Conveyor belt

The following table lists several approaches for reducing dust emissions from a potash operation where the tailings are transported (on conveyor belts) and discarded onto heaps.

Type of approach		Reduction method
Primary approaches		<ul style="list-style-type: none"> • choosing mineral processing equipment that generates as little fines as possible • spraying the tailings
Secondary approaches	Organisational	<ul style="list-style-type: none"> • continuous processing • reducing the transport distances • maintenance of possible sources of noise emissions • logistics of stacking areas
	Technical	<ul style="list-style-type: none"> • use of wind protection (e.g. covering of conveyor-belt) • using discharge heights to a minimum • transverse/reverse conveyor-belt • moistening of the solid tailings
Tertiary approaches		<ul style="list-style-type: none"> • Not dumping at high wind speeds

Table 4.10: Dust reduction approaches in transport

At the German potash operations, dry solid tailings from electrostatic separation are moistened indoors. The tailings are transported on conveyor belts and stacked with a moisture content of about 5 – 6 %. This leads to low dust emissions, due to be recrystallisation of the surface layer. The only atmospheric pollution which then arises is salt dust, from stacking the tailings on the top of the tailings heap, especially when discharging from a conveyor-belt onto a heap in very strong winds. Therefore to avoid this, stacking is stopped automatically if the wind speed exceeds a pre-determined limit. During recent years, the maximum dust detected by several immission measuring stations (dust monitoring and control system) around the tailings heaps measures less than 60 mg/m²/day.

Transfer stations are commonly enclosed in and the air cleaned in filters [131, IMA, 2003].

4.3.4.3.2 Trucks

Various methods of dust suppression are commonly used, including:

- spraying the shovel/bucket of the loader when loading
- spraying the bucket of the truck
- watering of the roads; spraying at unloading
- direct water spraying of the trucks and/or sprinkling devices along the road [131, IMA, 2003]
- establishing a speed limit of 30 km/h [142, Borges, 2003].

In concentrate transports, the trucks often have to pass water traps to clean the tires, and in some extreme cases the trucks are washed before leaving the site.

At Rio Narcea, a number of dust sampler monitoring units have been placed along the perimeter of the El Valle site, with data being recovered and analysed on a monthly basis. This monitoring system works in parallel with the existing Occupational Health & Safety programme which already includes dust monitoring through personal samplers.

4.3.5 Techniques to reduce noise emissions

The most common sources for noise emissions are transport, dumping, and spreading when trucks and conveyor belts are used.

At Zinkgruvan, about 0.5 million tonnes of waste-rock have been placed on the surface close to the old open pit, to act as a noise barrier around the east part of the industrial area.

At the coal mines in the Ruhr and Saar regions, ramps and working benches are transferred into the heap's inner area as far as possible, where they are shielded by embankments, to minimise dust and noise emissions from tailings transport, dumping and spreading operations [79, DSK, 2002].

In some cases an outer slope is first created to keep noise, dust and the movement of machinery out of the view of the neighbourhood, since generally what cannot be seen usually has a lower affect. With this technique it is first necessary to manage the outside of the heap in such a way so as to ensure a quick re-vegetation, which can then act as an appropriate noise barrier. According to neighbours, the most annoying noise is the warning noise of reversing dumpers. [131, IMA, 2003]

This technique is illustrated in Figure 4.15.

At the German potash mines, processing and tailings management are operated continuously. The transport to the tailings heap is carried out using conveyor belts. This set-up creates less noise than truck transport.

Continuous working systems are not always possible or practical to use. In waste-rock management, especially in the case of large operations, the location for the drop-off points vary so much that truck transport is often the only practical solution.

Appropriate maintenance of the trucks is necessary to keep all vehicles in perfect working order.

Belt drives are commonly encapsulated [19, K+S, 2002].

4.3.6 Progressive restoration/revegetation

Progressive restoration/revegetation during operation has the following advantages:

- costs are spread over a longer period and may be recovered from mining revenues
- closure activities can be integrated into the daily operational activities of the mine
- a shorter closure implementation period will result
- monitoring programmes are integrated into routine environmental management
- successful techniques can be incorporated into the final closure plan
- adverse environmental effects are minimised.

Progressive restoration cannot be practised if the entire area functions as a single operational unit. For instance, this may be the case when a site wants to facilitate the maturation and consolidation of the tailings, especially if the upstream method of perimeter embankment/dyke raising is employed.

Heaps are often progressively revegetated, which gives the added benefit that erosion is reduced. For instance at the Finnish talc site, the waste-rock piles and tailings ponds are progressively covered by local moraine and revegetated [131, IMA, 2003].

When tailings are deposited on heaps, the heap can be built in horizontal layers. This allows operators to reclaim the final slopes immediately and subsequently in order to prevent dust. Recultivation/reclamation is done according to the future use of the area, the existing vegetation in the surrounding area, and the needs of the local community. The aim is that a quick reclamation with pioneer seeds (grasses, bushes, trees) will successfully prevent dusting and will create valuable biotopes for different fauna and flora, and at a reasonable cost to the operator. [131, IMA, 2003]

Ongoing revegetation already occurring during operation can be accelerated by different measures:

- loosely tipping tailings to a depth of 2m in the outer area, in order to accommodate good root formation
- blending with materials such as fly ash from power plants, lime and dolomite rock. In this way the buffering capacity, water retention ability and nutrient capacity can be increased
- applying a 5 to 10 cm thick layer of arable soil. To promote quick and lasting vegetation, applying either a thick (around 1.8 m, when tailings properties require that option) or a thin earth layer (5 to 10 cm) are favoured options. In most cases, such soils are available in sufficient quantities. This soil will help the herbs root formation, and shrubs can be planted directly into the tailings. This has the advantage, that the young plant can accustom itself to the soil conditions available in the tailings material and leads to a natural root formation, which can also provide enough moisture to the plant in dry seasons
- applying mineral fertilisers to compensate for the lack of nutrients. Organic fertilisers contain nutrients, which are organically bound, but which are released by microbial degradation. Additionally, they improve soil structure, activate soil organisms and enhance water retention capacity
- applying surface mulching to enhance protection against adverse climatic conditions, as well as for humus enrichment and to improve the water retention capacity, especially in the early stages of vegetation. Mulching materials can be straw or hay, but also wood chaff
- in extremely dry seasons, irrigating at night time only [79, DSK, 2002]

- adding appropriately treated materials such as sewage sludge, bark, organic wastes and/or ashes with sufficient buffering capacity and rich in minerals, in order to help start up the revegetation. These materials have been successfully tested at several sites, e.g. Garpenberg and Falun. It is important that wastes such as sewage sludge or biowaste are used only after the appropriate treatment, to ensure the minimisation of pathogens. Compliance with Community or national regulations applicable to the use of these wastes must be ensured. If sewage sludge is used, attention has to be paid to the heavy metal load in the sludge.

In some mountainous regions, heaps are constructed by dumping from a hillside (see Figure 4.10 below), at its natural angle of repose. In that case, reclaiming of the slope cannot take place before the end of the construction of the heap.

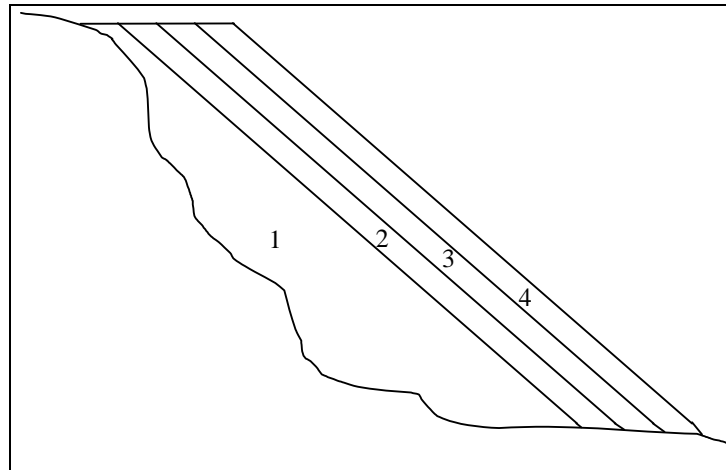

Figure 4.10: Example of a hillside dump
[131, IMA, 2003]

Figure 4.10 above shows how by continuous dumping (layer 1, covered by layer 2, layer 2 covered by layer 3 and so on) the slopes cannot be reclaimed during operation. Resloping of the heap will be expensive and the footprint significantly increased in order to ensure safety, enable revegetation, etc. Another option is to construct the dump in benches wide enough to allow for the resloping of one bench at a time. In this way the material will already be placed as close as possible to its final location (see Figure 4.11).

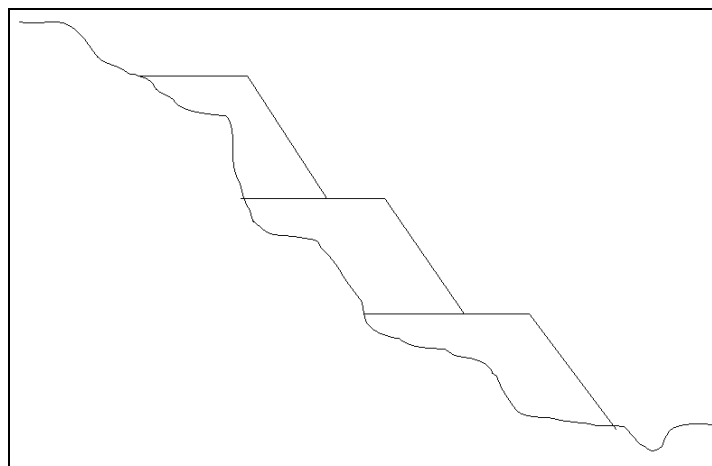

Figure 4.11: Example of an alternative construction of a hillside dump

In general, to avoid damages of dams and heaps, restoration and revegetation are carried out in accordance with the stability of the dams and therefore designed and controlled by experts, as vegetation can potentially cause serious stability problems (i.e. roots may destroy the dam construction). Also with revegetation the possibility of monitoring, e.g. by surveying, at any time has to be taken into consideration.

4.3.7 Water balances

Completing a detailed water balance is important for the design of any tailings pond, mine site and for the post mining scenario. The water balance will determine e.g.:

- the discharge capacity of the pond
- the required freeboard (if the water from the pond cannot be directly released into the recipient)
- the required water treatment capacity
- if there is enough water available and of the right quality for the mine processes
- how to handle excess water
- the amount of water escaping the handling system (seepage through waste-rocks and tailings to surface and groundwater).

Upon closure, the water balance is evaluated in order to carry out the closure plans, and to evaluate the elemental mass loading from the TMF. Some components of the water balance for a TMF are included in Figure 4.12. In addition, the water storage capacity of the dam construction material is determined.

The following figure shows a cross-sectional view of a tailings dam and illustrates the water cycle of this type of TMF.

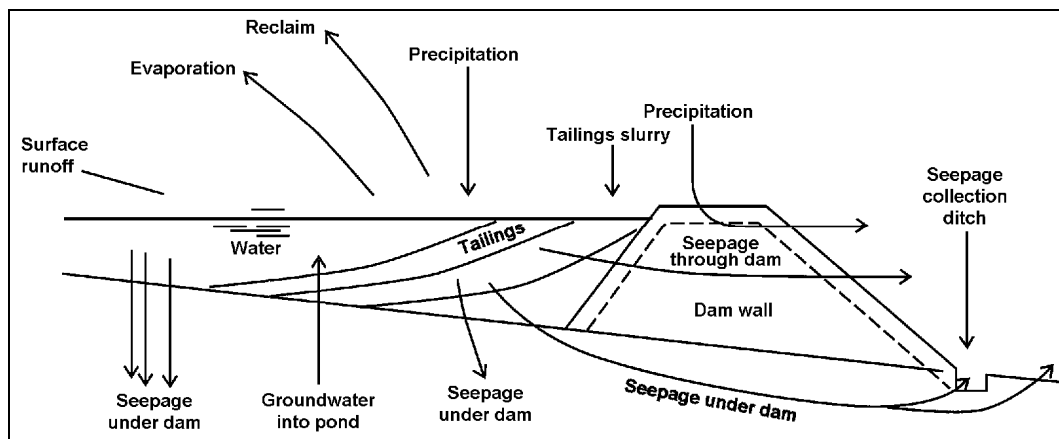

Figure 4.12: Dam water cycle
Changed from [11, EPA, 1995]

At the Swedish iron ore mines, water balance calculations were performed for the tailings dams system. These covered:

- precipitation
- surface run-off
- process water discharge
- reclaim process water
- evaporation
- discharge to the river system
- seepage under and through the dam.

Based on the water balance the estimated flow into the groundwater from the tailings pond/dam system could be calculated. However, there is a degree of uncertainty associated with this number since several of the parameters cannot be measured and therefore must be estimated.

Further examples of water balances are shown in, Figure 3.25, Figure 3.26, Figure 3.27, Figure 3.43, Figure 3.44.

4.3.8 Drainage of ponds

At the Ovacik site, the base of the tailings pond and the dams were made impermeable by means of a composite liner system of 50 cm compacted clay, overlain by a 1.5 mm thick high density polyethylene (HDPE) geomembrane, 20 cm of another compacted clay and 20 cm gravel filter layer. Here drainage pipes are placed in the filter layer to drain the water towards the decant. Figure 4.13 shows the set-up of the composite liner system. [56, Au group, 2002]

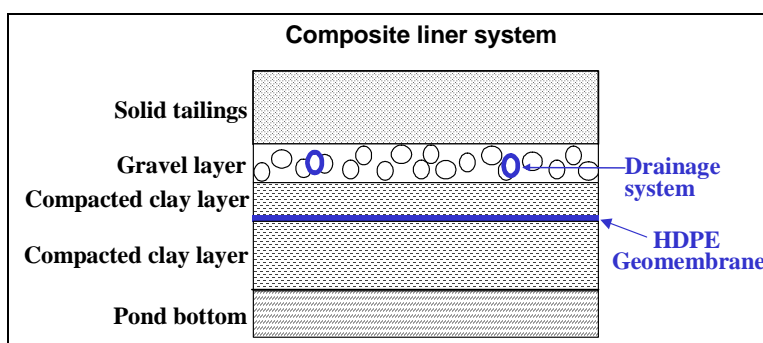

Figure 4.13: Composite liner set-up at Ovacik site
[56, Au group, 2002]

This type of system is applied in small impermeable ponds, where the process water is re-used. The benefit of this set-up is that the water is filtered when reaching the drainage system. The alternative would be a bigger clarification area. Hence, this system may be a means of reducing the pond size.

This system may be preferred over an extra clarification pond or a larger pond area if the process water contains contaminants (e.g. cyanide).

However, the cost of such a drainage system is high. In the case of the Ovacik operation, the cost for installing the HDPE liner was EUR 7.5 /m² (year 2001) for an area of 16 ha (see Table 3.63).

Other disadvantages are that it is not possible to repair the drainage system if it clogs, and that the reduced footprint results in higher dams.

4.3.9 Free water management

If the free water in the pond is not discharged directly into the natural water courses, it will be necessary to arrange the deposition in such a way that all the free water is returned to the plant or, in arid, hot climates, evaporated. The decant water may be stored in a clarification or reclaim pond downstream of the tailings pond and, in some cases, needs to be treated before discharge into the natural water course.

4.3.10 Seepage management

The basics of seepage flow are described in Section 2.4.2.5.

A prerequisite for the design of seepage management systems is a thorough understanding of the hydrogeological background of the site. This normally involves the installation and monitoring of piezometers to determine the directions of flow, hydraulic gradients and aquifer characteristics. On consideration of such data, decisions can be made on the appropriate measures.

Any **seepage through the dam** is collected in ditches where the flowrate and quality are monitored. The same ditch also typically intercepts the flow into the ground.

If the **seepage to the ground (or under the dam)** is of good quality it may be allowed to seep into the ground. If this is not the case, measuring the groundwater quality and lifting and treating the water may be necessary. The basic approach taken to avoid seepage to the ground and groundwater is to identify an appropriate location for the facility, i.e one where the groundwater flows into the pond instead of out of the pond; in this instance the hydraulic conditions are fulfilled for avoiding infiltration to the groundwater. Other approaches practised in the management of seepage into the ground are to either try to completely seal the ground by using clay liners or a synthetic membrane or a combination of both. In some operations, the presence of naturally occurring clay layers is sufficient to efficiently prevent the seepage to the ground. Liners are becoming more popular. However, critics quote the 'bathtub effect' as issues to be considered in the long term, meaning that the liners hold back the liquids for a certain amount of time but at some point in time will eventually overflow.

Seepage capture by pumping is another option for controlling the emissions into groundwater, provided that it is recognised that there may be an ongoing commitment to continuing this after the tailings impoundment is closed. The necessity for pumping after closure thus should be reviewed in the rehabilitation and closure plan.

4.3.10.1 Seepage prevention and reduction

The most efficient technique to prevent seepage into the ground is proper site selection, i.e. in a discharge area where an impermeable hydraulic barrier is available or where geohydrological conditions exist that result in a groundwater flow into the pond. For example, waste-rock areas or tailings ponds could be constructed on natural wetland areas where the ground is naturally impermeable.

If it is necessary to avoid seepage into the ground and no natural barrier exists, the bottom of the pond can be made impermeable with clay or other sealing material, so that the penetration of water is lower than 10^{-8} m/s. For this, huminous material must be taken off before the lining. In some cases, the permeability values are lower than 10^{-8} .
[131, IMA, 2003]

Liner systems are designed to restrict the seepage of leachate through the base of the tailings storage area. All liner systems have eventually leakage; the rate of which will depend on:

- the magnitude of the hydraulic head above the liner
- the thickness and effectiveness of the liner material
- the length of time the hydraulic head is applied to the liner.

It is important to be aware of the hydro-geological features of the site and the geochemical features of the tailings to be managed [11, EPA, 1995].

The use of liners is a regularly debated subject. Their greatest advantage is the possibly high reduction of seepage. However, critics say that it is not possible to predict how long the liners will function properly. One alternative is to handle the seepage from the commencement of use.

Figure 4.14 shows the types of liner systems available.

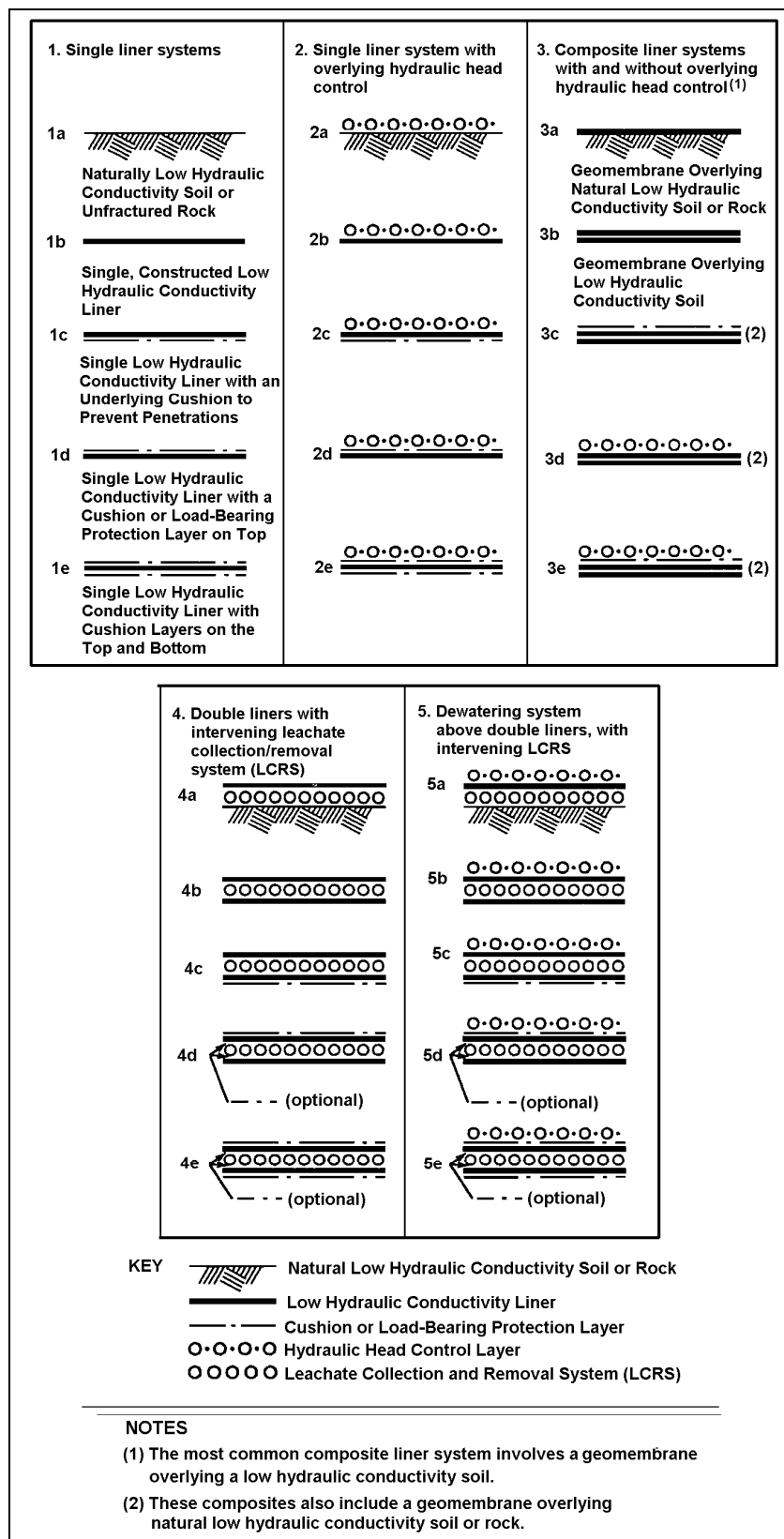

Figure 4.14: Available types of liner systems [11, EPA, 1995]

However, as mentioned in the previous section, measures to restrict infiltration into the deposit may be preferred over low-permeability bottom **liners** with accompanying hydraulic gradients that promote contaminant transport (the so-called ‘bathtub’ effect) [13, Vick,].

One field of application for liners are ponds where:

- the process water would otherwise seep into the ground (e.g. a pond on flat land as shown in Figure 2.4.2.5, no hydraulic barrier), and
- there is a desire to keep the process water within the pond during operation, e.g.:
 - in order to re-use process water
 - because the water is contaminated (e.g. CN)
 - to avoid dusting by keeping the beach saturated, and
- it is not necessary to ensure that tailings remain water saturated after closure.

Temporary ponds (only during operation) containing ‘pregnant’ (loaded with gold) process liquor in CN leaching and heap leaches are also often lined to avoid the seepage of CN laden solution into the ground, in many cases with double liners.

It is virtually impossible to repair a loaded liner. Removal of the material is not practical. Retro drilling over the affected area (presuming one can locate it!) and injection of bentonite are very difficult and costly. Accuracy is also a major problem.

From a non-repair point of view, TMF perimeter interceptor trenches or hydraulic barriers are other possibilities, but are also very expensive, and given the size of most tailings ponds would have to be very big constructions. They are also depth limited, so if the leakage is dropping into the bedrock these barriers would have little effect. Pumping and treating the leakage is another possible solution, but this would be very expensive, and perhaps only practical when a mine is operational, as only then will there likely be treatment available locally. This is not a long-term solution, as it is not sustainable.

Another key aspect is that the leakage is entirely controlled by the hydraulic head. If this is removed then there is no, or negligible, leakage. So, draining tailings and capping them will reduce or prevent build-up of head and thus leakage. This is perhaps the most practical solution to leakage problems in a closed facility.

A liner can never be guaranteed to prevent all leakage. Some holes or construction flaws are inevitable. What the liner does is reduce the leakage to such a rate that the receiving environment can cope with it by dilution and dispersal or degradation.

When designing a lined TMF it is necessary to account for the possibility of leakage and confirm that low leakage rates (within standard industrial factors for construction defects in liners) will not result in significant environmental pollution. Otherwise some form of secondary containment (or leak collection layer) is desirable (e.g. clay, peat, bentonite, etc.). In many cases the tailings are so fine that, following consolidation, they have a similar permeability as a mineral liner. That is, the secondary containment comes from within. This is better where the tailings are drained. The consolidation can take many years following loading and until the tailings are at a sufficient depth and/or drained. In this case, the synthetic liner provides the principal containment until the tailings are consolidated. Thereafter the tailings tend to be the controlling barrier. Thus the long-term life expectancy of the synthetic is less of a concern.

4.3.10.2 Seepage control

Two types of control measure could be considered, namely:

- seepage barriers and
- return systems.

Seepage barriers serve to prevent seepage into the ground and include cut-off trenches, slurry walls and grout curtains.

However, possible disadvantages of these measures in connection with the stability of the tailings dam must be considered in each case.

In some cases, it may be more appropriate to install return systems instead of seepage barriers. Return systems collect, rather than impede, seepage flow, thereby enabling seepage water to be retained for treatment or for disposal in a manner which will not damage the environment. The return system could consist of collector ditches and wells.

The advantages and limitations of seepage control measures are given in the Table 4.11.

Seepage control measures	Type	Advantages	Limitations
Seepage barriers	Cut-off trench	Inexpensive; installations can be well controlled.	Not practical for saturated barrier foundations; effective only for shallow pervious layers.
	Slurry walls	Low-permeability barrier can be constructed.	High cost; not well suited for steep terrain or bouldery ground; impervious lower boundary required.
	Grout curtains	Barrier can be constructed to great depths; not affected by site topography	High cost; limited effectiveness due to the permeability of grouted zone; cement grouting practical for only coarse soils of wide rock joints.
Return systems	Collector ditches	Inexpensive; suitable for any type of dam	Effective for shallow pervious layers, but still beneficial in other cases.
	Collector wells	Greater depth possible; useful as a remedial measure	Expensive; effectiveness depends on local aquifer characteristics.

Table 4.11: Summary of seepage control measures

It should be noted that, in reality, seepage control at a site often involves a combination of the methods listed above. Also, in addition to the barriers, which are constructed only for controlling the transport of seepage, the treatment of the contaminants in the seepage is possible by certain reactive barriers.

4.3.10.3 Potash tailings heaps

At tailings heaps from potash minin, the water permeability of the soil needs to be determined on a case-by-case basis (baseline conditions). Mostly, the soil components determined will be sufficiently impermeable to prevent the contamination of groundwater. If not, the ground under potash tailings heaps can be sealed, e.g. by improving the natural soil with the addition of up to 4 % of clay. The clay is milled into the natural soil and the mixture is distributed and compressed to reach impermeable conditions. After treatment the permeability coefficient is controlled and if it is insufficient the procedure is applied again.

The toe of the heaps outside the impermeable core zone is lined and the solutions are collected.

A long experience in stacking potash tailings is necessary to be able to apply the appropriate tailings management methods. For example, the use of clay liners underneath the heap can result in stability problems. For the extension of a tailings heap in the Fulda area of Germany, the authorities demanded the ground be sealed with an artificial clay liner of 0.6 m. As the heap expanded over this sealed ground, rapid movement of that part of the heap on top of the clay liner was observed to such an extent that the safety of the employees on top and in front of the heap was threatened and operation had to be stopped. An investigation concluded that any material with a low shearing strength should not be used for sealing the ground beneath potash tailings heaps. [19, K+S, 2002]

4.3.10.4 Coal tailings heaps

In the Ruhr, Saar and Ibbenbüren, there are coal tailings which have been dumped onto the heaps in layers. The thickness of the layers ranges from 0.5 to 4.0 m. Compaction is achieved by way of the trucks' rolling wheels and via vibration rollers to reduce as much as possible the penetration by oxygen or precipitation into the heap body and, thus, minimising the generation of ARD by pyrite oxidation.

The principle of erecting a tailings heap is shown in the Figure 4.15, displaying four construction steps within the spreading phases. The first step is the construction of an outer rim wall, which is immediately revegetated, and which serves as a shield for the subsequent deposition of tailings in the inner zone.

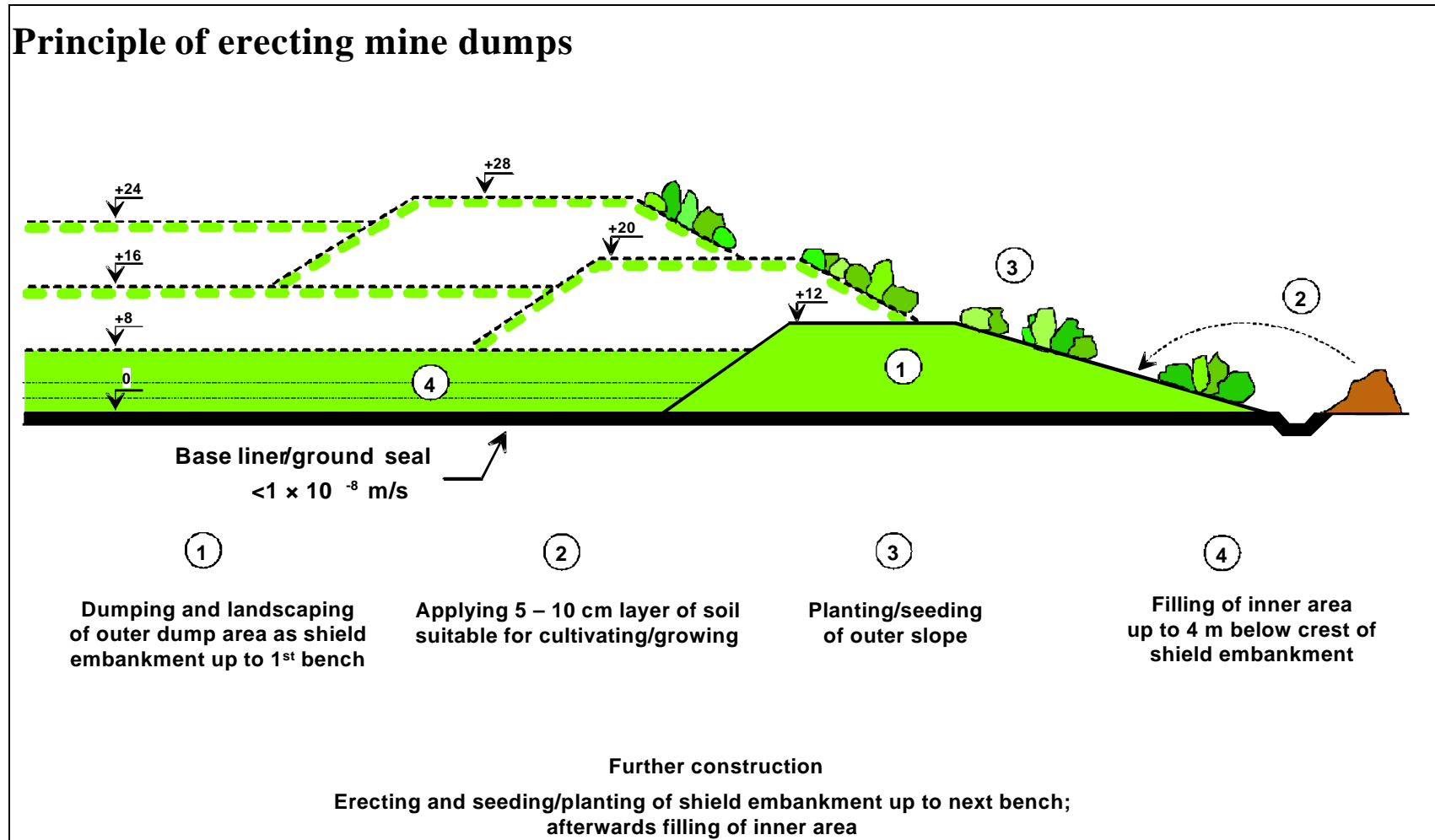

Figure 4.15: Schematic drawing of tailings heap construction in the Ruhr, Saar and Ibbenbüren areas [79, DSK, 2002]

It is known from investigations with lysimeter tests, that seepage water from coal tailings heaps can contain dissolved elements. Results from these tests showed that chloride can be washed out and sulphate, calcium and magnesium levels can increase due to pyrite oxidation. ARD generation is possible. When this happens, the decreasing pH-values and the falling buffer capacity of tailings material or aquifer can lead to trace elements in the heaps being mobilised.

As a consequence, groundwater protection is the main environmental concern when constructing and operating a heap. There are four main measures which are used to protect groundwater from possible heap effluents (Figure 4.10 below).

Specific solutions are chosen depending on site-specific circumstances, i.e. single measures may be selected or a combination of different measures.

It was discovered recently that an older tailings heap had 'self-compacted' to such an extent, that the inner body of the heap was absolutely dry.

[79, DSK, 2002]

In the Ruhr, Saar and Ibbenbüren, the coal tailings are a mix of silica and clay. Over time this mixture tends to compact further. The silica content is such that wetting of the clay does not cause slope stability problems.

The surface run-off and seepage of the tailings are collected and led towards the receiving surface waters.

Measures for avoiding negative effects on ground water and drainage system

Case 1: impermeable subsoil

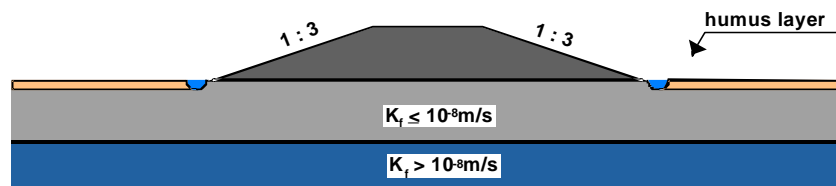

Case 2: ground seal/base liner

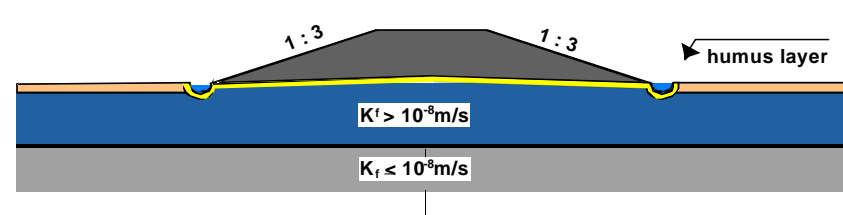

Case 3: downstream polder

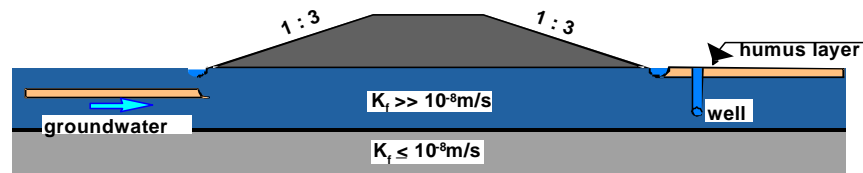

Case 4: ring drainage

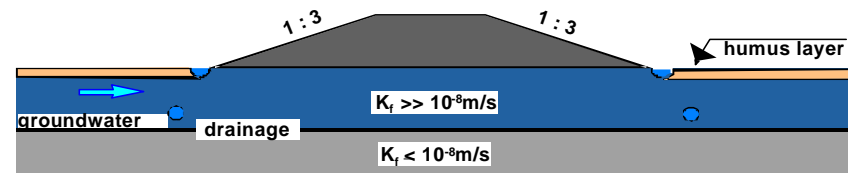

Figure 4.16: Tailings heap design – options for avoiding negative effects on ground and surface water system [79, DSK, 2002]

4.3.11 Techniques to reduce emissions to water

4.3.11.1 Re-use of process water

One approach to reduce emissions to water is to re-use the process water. This has been applied successfully at several plants. Only the surplus, which cannot be re-used, e.g. because of

- snow smelt
- saturation with magnesium containing salt (in the case of potash mines) [19, K+S, 2002] is either, for some potash mines, pumped into deep wells or discharged into surface waters.

The re-use of process water may not be possible, if the accumulation of reagents/components interferes with the mineral processing (e.g. calcium sulphate in the water which can cause blockage problems in the pipes).

4.3.11.2 Washing of tailings

Reagents in the flotation of silicates are very strongly adsorbed on the silicate particles. However, tailings from flotation are washed with clarified process water in order to bind possible free reagents. Tailings containing silicate particles bind the residual free reagents present in the waste water. Therefore, a subsequent dewatering process leads to a clear and reagent free water, which can then be discharged to a recipient or recycled into the process.

[131, IMA, 2003]

4.3.11.3 Dissolved metals treatment

The adsorption ability of finely ground tailings has a cleaning effect on water containing dissolved metals (e.g. that coming from the mine, or drainage water from waste-rock dumps). Therefore if mine water is added to the tailings stream, the dissolved metals tend to attach to the mineral surface. Metals adsorbed to the mineral surfaces will be kept in that form as long as the pH-values are favourable (e.g. >7 for zinc, >5 for copper). To assure good contact between the dissolved metals and the tailings particle surfaces, the mine water is added to the tailings stream sump prior to pumping to the TMF.

This is a simple system utilising the adsorption effects offered by 'natural material'. The technique can easily be used at most TMFs. Retrofitting is not a problem.

[118, Zinkgruvan, 2003]

Mixing of the tailings stream (including process water and tailings solids) and other waters containing dissolved metals (e.g. drainage water from waste-rock heaps, not-fresh water from the mine) is applicable during the operational period if:

- the tailings stream is at an alkaline pH and contains freshly ground minerals (this is normally the case in tailings originating from a flotation process)
- the buffering capacity of the tailings stream is considerably higher than the acidifying capacity of the added waters
- the metal containing water can be added to the tailings stream in the tailing pumps in such a way so as to provide sufficient contact time and mixing with the tailings stream.

This technique is considered favourable to flocculation.

The advantages with the method are:

- it is a very effective water treatment method
- no costs for building, operating and maintaining a water treatment plant during the operation of the site
- no need for sludge management (which would result if conventional water treatment was applied)
- the method can well handle flow variations and is effective at all temperature ranges; important as the process water normally has an elevated temperature.

A variation of this technique is carried out in the Legnica-Glogow copper basin, where acids from the smelters are mixed with tailings for neutralisation and to immobilise the metals (e.g. arsenic).

4.3.11.4 Suspended solids and dissolved components

In water discharges, solids emissions to water are either particulate matter or dissolved components. Successful water treatment must combine the reduction of suspended solids with removal of the harmful dissolved content of contaminants.

Water treatment may take place either in open ponds or in constructed treatment plants. The processes involved are the precipitation of dissolved elements, mainly metals, and separation of precipitates and particles. For precipitation, either sulphide or lime or a combination is used. For the separation of precipitates and solids, gravity or forced sedimentation is used. Gravity separation may take place in ponds or in thickeners.

The sludge obtained will require proper management and deposition. In the ideal case, it can be deposited as part of the backfilling operation of the mine.

Water treatment, however necessary, constitutes a significant cost.

Each mining operation needs to design a proper system for water treatment. The requirements on the system will depend on the site-specific water quality and volumes to be treated. Local conditions will also determine the choice of technology.

The purification technology to precipitate suspended solids in the Legnica-Glogow copper basin is based on coagulation (with about 300 mg/l ferric chloride) supported with polyelectrolyte praestol (1 mg/dm³) and sedimentation in a lamella settling tank.

[113, S.A., 2002]

4.3.11.4.1 Sedimentation ponds

When depositing tailings from flotation or other tailings containing fines on a heap, emissions to water may derive from solids and eluates. Emissions of solids to water due to heavy rainfall can be successfully prevented by the installation of sedimentation ponds along the roads and before the receiving surface water body. The construction depends on the maximum rainfall, the area and inclination, the flowrate, size of solids, etc. For documentation, monitoring of the solid content is necessary but according to the local circumstances. The frequency and the kind of measurements are fixed according to the requirements laid down in the geotechnical/environmental study, and are adjusted during the lifetime of the TMF.

[131, IMA, 2003]

The interiors of **potash tailings heaps** are impermeable to water. Water and generated saline solutions only flow down in an outer sphere around the inner impermeable core. The toe of the heaps outside the impermeable core zone is carefully sealed and the solutions are collected.

This type of collection system is suitable if the quality of the run-off is such that an immediate discharge into the ground is not environmentally sound.

At the Schöttelheide **coal tailings heap**, a ditch runs along the dump's toe, which collects the surface run-off and transports it to the sedimentation pond before the water is discharged to the recipient. This is necessary because of the high content of suspended solids.

During the operational phase of a heap, it is normally necessary to collect surface water run-off at the toe of the heap in ditches. The further management requirements of the collected water depend on the water quality of the run-off. If the water is of good quality and contains low concentrations of suspended solids, the water can be directly released to the recipient. If the water quality is good, but, the suspended solids content is elevated, then it may be sufficient to pass the water through a sedimentation pond/trap in order to reduce the suspended solids load to the recipient. In some cases additional treatment is required. Collected surface run-off can often be used as process water.

4.3.11.5 Acid water treatment

Water treatment methods used to eliminate or reduce acidity and heavy metals precipitation from impacted waters can be grouped into two types: (1) active and (2) passive treatment:

(1) **Active** treatment involves neutralising acid-polluted waters with alkaline chemicals. However, the chemicals can be expensive and the treatment facility is expensive to construct and operate

(2) **Passive** treatment involves the construction of a treatment system that employs naturally occurring chemical and biological reactions that aid acid rock drainage treatment and which require little maintenance. Passive control measures include anoxic drains, limestone rock channels, alkaline recharges of groundwater, and the diversion of drainage through man-made wetlands or other settling structures.

There is also a possibility to combine active and passive treatment techniques (e.g. liming and constructed wetlands)

Active treatment - chemicals

- Limestone (calcium carbonate)

The advantages of using limestone include low cost, ease of use, and formation of a dense, easily handled, sludge. Disadvantages include slow reaction time; loss in efficiency of the system, because of coating of the limestone particles with iron precipitates; difficulty in treating ARD with a high ferrous-ferric ratio; and ineffectiveness in removing manganese. A typical flow sheet of an acid water treatment plant is shown in Figure 4.17.

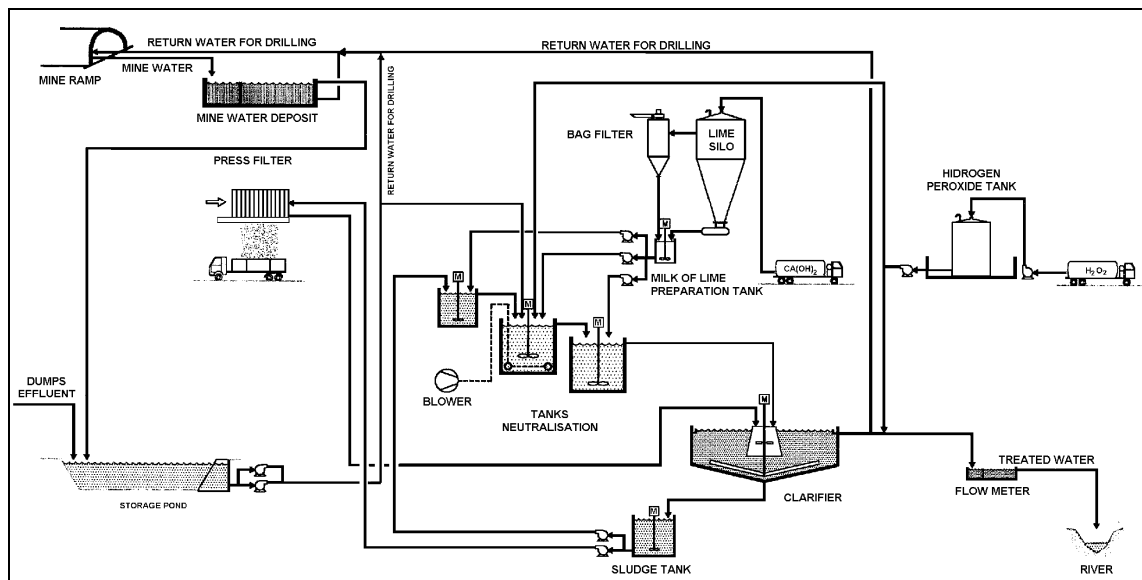

Figure 4.17: Flow sheet of a water treatment plant for low pH process water
(from Almagrera)

It should be noted that in the flow sheet, mine and process water are managed in a combined manner. This is not always the case

- Hydrated lime (calcium hydroxide)
Hydrated lime is normally the neutralising agent of choice for the coal mining industry because it is easy and safe to use, effective, and relatively inexpensive. The major disadvantages are the voluminous sludge that is produced (when compared to limestone) and high initial costs incurred because of the size of the treatment plant [85, EPA, 2002]. Hydrated lime is not applied as a neutralising agent in the German coal mining industry as acidic seepage from heaps does not occur
- Soda ash (sodium carbonate)
Soda ash briquettes are especially effective for treating small ARD flows in remote areas. Major disadvantages are the higher reagent cost (relative to limestone) and poor settling properties of the sludge
- Caustic soda (sodium hydroxide)
Caustic soda is especially effective for treating low flows in remote locations and for treating ARD having a high manganese content. Major disadvantages are its high cost, dangers involved with handling the chemical, poor sludge properties, and freezing problems in cold weather
- Ammonia
Anhydrous ammonia is effective in treating ARD having a high ferrous iron and/or manganese content. Ammonia costs less than caustic soda and has many of the same advantages. However, ammonia is difficult and dangerous to use, and can affect biological conditions downstream from the mining operation. The possible off-site impacts are toxicity to fish and other aquatic life forms, eutrophication and nitrification. Fish species generally exhibit low tolerance to unionised ammonia and toxicity levels can be affected by pH, temperature, dissolved oxygen and other factors. Ammonia use is not allowed in all areas and, where permitted, additional monitoring is required.

Passive treatment

- **Constructed wetlands**

Constructed wetlands utilise soil- and water-borne microbes associated with wetland plants to remove dissolved metals from rock drainage. Unlike chemical treatment, however, wetlands are passive systems requiring little or no continuing maintenance. This is a relatively new treatment method with many specific mechanisms and maintenance requirements not yet fully understood. The optimum sizing and configuration criteria are still under study. Old, stable, naturally formed wetlands should be left untouched, because, for example, digging the drainage ditches may restart the acidification processes again.

Influent waters with high metal concentrations and low pH flow through the aerobic and anaerobic zones of the wetland ecosystem. Metals are removed through ion exchange, adsorption, absorption, and precipitation with geochemical and microbial oxidation and reduction. Ion exchange occurs as metals in the water contact humic or other organic substances in the wetland. Wetlands constructed for this purpose often have little or no soil, instead being made of straw, manure or compost. Oxidation and reduction reactions catalysed by bacteria that occur in the aerobic and anaerobic zones, respectively, play a major role in precipitating metals as hydroxides and sulphides. Precipitated and adsorbed metals settle in quiescent ponds or are filtered out as water percolates through the medium or the plants.

Influent water with explosive residues or other contaminants flows through and beneath the gravel surface of a gravel-based wetland. The wetland, using emergent plants, is a coupled anaerobic-aerobic system. The anaerobic cell uses plants in combination with natural microbes to degrade the contaminant. The aerobic, also known as the reciprocating cell, further improves water quality through continued exposure to the plants and the movement of water between cell compartments.

Wetland treatment is a long-term technology intended to operate continuously for years

Wetlands have been used to treat acid mine drainage generated by metal or coal mining activities. These wastes can contain high metals concentrations and are acidic. The process can be adapted to treat neutral and basic tailings solutions. The wetlands remediation technology must be adjusted to account for differences in geology, terrain, trace metal composition, and climate. Wetlands are generally more effective in removing iron than manganese. The greatest utility of wetlands appears to be in the treatment of small flows in the order of tens of litres per minute [85, EPA, 2002]. The following factors may limit the applicability and effectiveness of the process:

- the long-term effectiveness of constructed wetlands is not well known. Wetland ageing may be a problem which may contribute to a decrease in contaminant removal rates over time
- the cost of building an artificial wetland varies considerably between projects and may not be financially viable for many sites
- temperature and fluctuations in flow affect the wetland function and can cause a wetland to display inconsistent contaminant removal rates
- colder conditions slow the rate at which the wetland is able to remove contaminants.
- a heavy flow of incoming water can overload the removal mechanisms in a wetland, while a dry spell can damage plants and severely limit wetland function.

[124, US FRTR, 2003]

Initial design and construction costs may be significant, ranging into tens of thousands of Euros.

- **Open limestone channels/anoxic limestone drains**
This is the most simply constructed passive treatment method and consists of open ditches filled with limestone (anoxic drains are covered). Dissolution of the limestone increases the alkalinity and raises the pH. Coating of the limestone, by iron and aluminum precipitates, affect the performance of this treatment method
- **Diversion wells**
Acidic water is diverted to a "receptacle" or "well" containing crushed limestone. Iron precipitate coating is prevented by turbulence of the flow through the well. Needs periodic replenishment of limestone.

[85, EPA, 2002]

Passive treatment systems are often not very favourable in their applicability due to problems with capacity, especially with regard to flow, capability of handling high acidity waters, seasonal variations, flow variations, etc. However, they may very well constitute a long-term solution after the decommissioning of a site when used as a polishing step combined with other (preventive) measures.

4.3.11.6 Alkaline water treatment

At the Sardinian alumina refinery, the alkaline waters accompanying the mud released from the washing and filtering units are adjusted to pH 10 by the following methods:

- desulphurisation of combustion flue-gases rich in SO_2
- seawater addition for MgCl_2 reacting with caustic soda
- sulphuric acid if needed.

At the Galician alumina refinery, water from the red mud pond (free and seepage) is collected and pumped to a treatment station (see figure below). The first step involves neutralising the water by adding sulphuric acid. The optimum pH is 6.85, at which point the aluminium in the water becomes insoluble helping the sedimentation process. After the neutralisation the water overflows to the flocculation tank. The clear water is pumped back to the refinery.

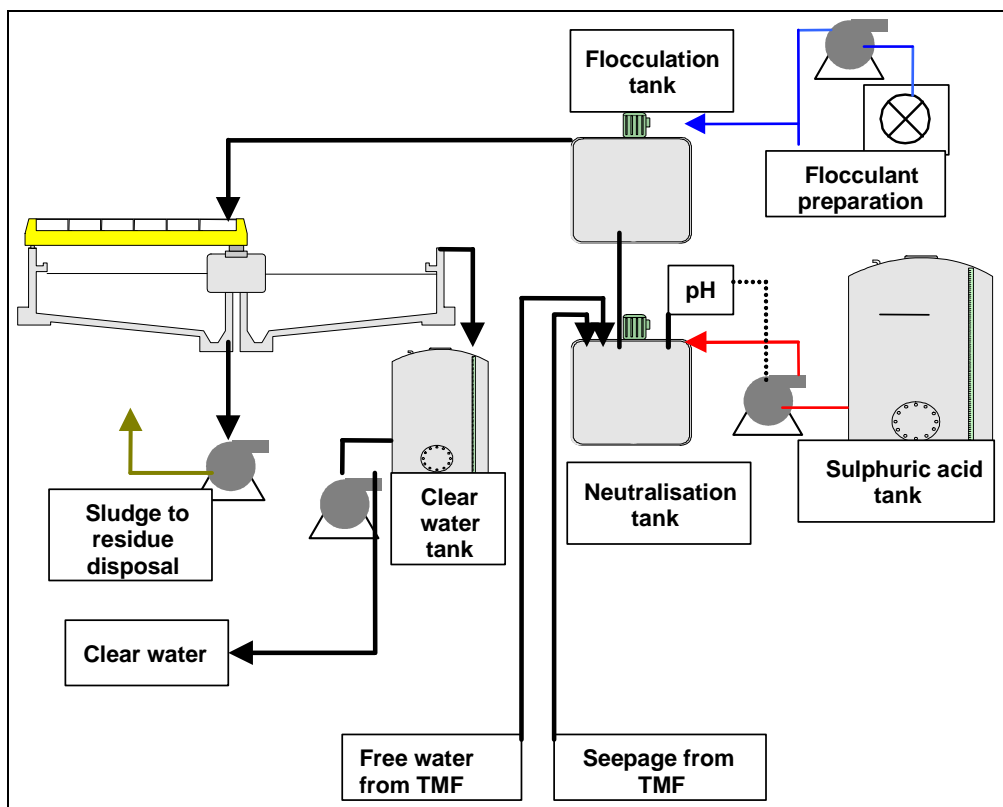

Figure 4.18: Treatment of alkaline water at an aluminium refinery

In other cases, carbon dioxide is used to lower the pH.

4.3.11.7 Arsenic treatment

Trace metals are effectively removed from mining effluents by the addition of ferric salts. Arsenic is removed as either calcium or ferric arsenate by precipitation. Through precipitation, arsenic is removed as either calcium or ferric arsenate. Arsenites can also be precipitated, but they are generally more soluble and less stable than arsenates. Arsenite-containing effluent is generally oxidised prior to precipitation to ensure that the arsenate predominates. Process water from the processing of arsenic bearing ores may contain varying amounts of arsenic (III) and (V) oxyanions, arsenites and arsenate. The presence of such metal ions as copper, lead, nickel, and zinc limit the solubility of arsenic because of the formation of sparingly soluble metal arsenates.

The stability and solubility of these arsenates depends on the ratio of iron to arsenic. The larger the ratio, the more insoluble and stable the precipitate. Thus, where ferric arsenate is relatively soluble, the basic arsenates with an iron-to-arsenic molar ratio of eight or more are orders of magnitude less soluble in the pH range of approximately 2 to 8. Dissolved arsenic concentrations of 0.5 mg/l or less can be obtained by precipitation with ferric iron.

The precipitation of insoluble ferric arsenates is very likely accompanied by the co-precipitation of other metals such as selenium; that involves interactions between the various metals species and the ferric hydroxide precipitate. This makes ferric salts a very effective scavenger for the removal of trace contaminants. Thus, arsenic and many other elements such as antimony and molybdenum can be reduced to levels of less than 0.5 mg/l by contact with ferric hydroxide. The process normally involves the addition of a soluble ferric salt to the process water, followed by the addition of sufficient base to induce the formation of insoluble ferric hydroxide. In many situations, the process water contains adequate iron, thus only the addition of a base is required to induce the precipitation of ferric hydroxide. [78, Ron Tenny, 2001]

In Finnish talc-magnesite ores, some arsenic minerals occur. During the processing of talc-magnesite ore (grinding and flotation), some arsenic is dissolved in the process waters. Arsenic is precipitated as Fe-As compounds by adding ferric sulphate ($\text{Fe}_2(\text{SO}_4)_3$). If the pH is 6 or lower, arsenic can be precipitated completely. If the pH in the process water is higher (in one case 7 – 8 has been repeated) more ferric sulphate has to be added to reduce the arsenic to an acceptable level (less than 0.4 mg/l). It is difficult to precipitate nickel and arsenic at the same time, hence a two stage treatment is required. [131, IMA, 2003]

4.3.11.8 Cyanide treatment

On a worldwide scale, natural degradation is still the most common treatment method of treating cyanide in gold leaching effluents, although it is often supplemented by other treatment processes. In dry and sunny climates e.g. in South Africa, natural degradation is usually the only treatment method.

The following table lists the currently applied cyanide treatment alternatives.

Treatment Process	Stage	Applications	Comments
Natural degradation <ul style="list-style-type: none"> ▪ neutralisation by CO_2 absorption ▪ HCN volatilisation ▪ metal cyanide complex dissociation ▪ metal cyanide precipitation 	C	TP, SW	Application is limited to site-specific factors (e.g. arid, sunny) and regulations
Oxidation Processes <ul style="list-style-type: none"> ▪ alkaline Chlorination ▪ SO_2/air process ▪ hydrogen Peroxide 	C C C	TP, SW TP, SW SW	Displaced by SO_2 -air and H_2O_2 due to cost, inability to remove iron Universal application, slurry treatment can result in elevated reagent consumption Not applicable to slurries due to reagent consumption
Adsorption <ul style="list-style-type: none"> ▪ activated carbon adsorption 	D	SW	Limited to low CN concentrations, site-specific
Biological treatment <ul style="list-style-type: none"> ▪ biodegradation 	C	SW	Limited to low CN concentrations, site-specific, may require supplemental heat.
Cyanide Recycle <ul style="list-style-type: none"> ▪ AVR 	C	TP	<ul style="list-style-type: none"> ▪ not very practical on slurry ▪ high capital cost ▪ need sufficient recoverable cyanide to break even on operating costs versus cyanide recovered. Free cyanide is easy, then increasingly more difficult recovery for zinc, copper and nickel cyanide. Precipitation of CuCN lowering cyanide recovery usually becomes too expensive when trying to recover below 30 mg/l cyanide. Therefore, still need for removing/destroy cyanide after AVR [109, Devuyt, 2002]
TP = discharge into tailings pond SW = Discharge into surface water C = commercial D = Development			

Table 4.12: Applied CN treatment processes

Several other options for cyanide recovery are under development but need piloting and full plant implementation. The ‘Sart process’ uses sodium sulphide in solution to liberate the

cyanide from Zn and Cu, leading to the recovery of a thickener overflow cyanide, which can be directly recycled. The 'Hannah process' uses the same principle, but uses ion-exchange in solution or pulp to remove cyanide, stripping cyanide from the resin, then the precipitation of Zn and Cu with sodium sulphide. This produces a more concentrated cyanide stream for recycling and offers the possibility for higher recoveries.[109, Devuyst, 2002]

The SO₂/air process, which is used in all European sites to treat the slurry prior to discharge into the TMF is usually described using the following reactions:

Oxidation:

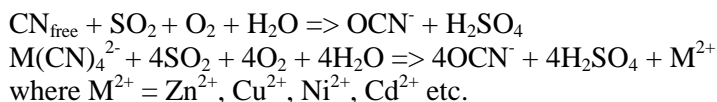

Neutralisation using lime:

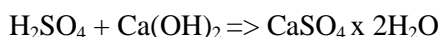

Precipitation:

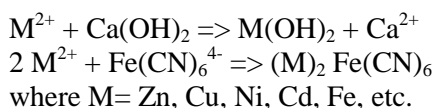

The presence of copper ions catalyses these reactions. It binds to the cyanide forming stable complexes of copper (I), which can be destroyed using the INCO process by oxidation of both copper and cyanide. The higher the concentration of copper, the more stable those complexes are. On the other hand, high copper contents in the ore will require more cyanide in the leaching and, if the efficiency of the CN destruction remains, the residual cyanide concentration will be higher.

The influence of sulphur dioxide is not fully explained, but it is assumed, that some intermediary compounds are generated, that accelerate the reactions. The **Bergama-Ovacik** site uses ferric sulphate to even further stabilise any heavy metals.

The oxygen dispersion is related to the viscosity. When the viscosity is high, the levels of dissolved oxygen are lower and the kinetics of the reaction slow down.

The CN destruction is capable of reducing the WAD-CN concentration in the slurry from 140 mg/l to below 2 mg/l, if the copper content in the ore is not too high. If the feed to the cyanide leaching contains more than 0.1 % Cu, it is not possible to achieve such low levels of WAD-CN in the tailings. At high copper concentrations, several stages of CN destruction may be necessary.

Table 4.13 gives the CN concentrations of several sites [50, Au group, 2002].

Site:	Boliden	Ovacik	Rio Narcea
Leach:			
Free CN (mg/l)	120	200	400 - 450 (NaCN)
pH		10.5	10.5
Measurement frequency	Daily	2 hrs	Continuously online
Min	70	180	
Max	50	220	
Discharge from Detox:			
Free CN			0
WAD CN			10 - 30
Total CN		0.33	
pH	0.87	0.4	8.5
		7 - 8	
Measurement frequency	1/day SIS method, 3/day picric method	2 hrs	3 hrs
Min	0.31 (total)	0.06 (WAD)	1 (WAD)
Max	1.94 (total)	0.88 (WAD)	40 (WAD)
In TMF			
Free CN			0
WAD CN		0.23	20 - 30
Total CN	0.3	0.39	
pH		7 - 8	8.5
Measurement frequency	Sporadic	Daily	Daily
Min	0.05 (total)	0.04 (WAD)	10 (WAD)
Max	0.74 (total)	0.71 (WAD)	30 (WAD)
TMF discharge:		No discharge	No discharge, drainage returned to pond
Free CN	0.06		0
WAD CN			0.5 - 1.0
Total CN			
pH			8 - 8.5
Measurement frequency	Daily		Daily
Min	0		0.2 (WAD)
Max	0.33		2 (WAD)

Table 4.13: CN levels at European sites using cyanidation

At the Boliden mineral processing plant, monitoring of the CN-destruction and the water quality of the discharge from the tailings and clarification pond was carried out during year 2001. Results showing that 99.5 % of the CN_{free} was destroyed. Further degradation of the CN occurs naturally in the tailings pond. Similar results are reported from Ovacik and Rio Narcea.

While currently cyanide management has centred on the destruction of cyanide in single-pass systems, it is possible to **recover and re-use cyanide**, thereby minimising the total amount of cyanide used and reducing the operational costs. The recovery and re-use of cyanide lowers the CN concentration in the ponds and decreases the costs for destruction of CN [106, Logsdon, 1999].

CN recovery and re-use has been used since the 1930s. One method, called 'AVR' (acidification/volatilisation/re-neutralisation) has been successfully applied at several sites. It is apparent that this method consumes large amounts of acids and bases but consumes less energy than hydrolysis/distillation processes. Also volatilisation rates are higher [104, Young, 1995].

Section 4.4.15 addresses cyanide management issues aimed at the prevention/mitigation of accidents.

4.3.11.9 Permeable reactive barriers

A permeable reactive barrier is a permeable zone containing or creating a reactive treatment area oriented to intercept and remediate a contaminant plume. It removes contaminants from the groundwater flow system in a passive manner by physical, chemical or biological processes.

A full-scale continuous permeable reactive barrier (PRB) was installed in August 1995 down gradient from an inactive mine tailings impoundment at the Nickel Rim Mine site in Sudbury, Ontario, Canada. Nickel Rim was an active mine from 1953 to 1958. Primary metals extracted were copper (Cu) and nickel (Ni). Tailings have been undergoing oxidation for approximately 40 years. The groundwater plume emanating from the tailings is discharging to a nearby lake. The primary contaminants on site are nickel (Ni), iron (Fe), and sulphate. Initial concentrations were 2400 - 3800 mg/l sulphate, 740 - 1000 mg/l Fe, and up to 10 mg/l Ni.

The contaminated aquifer is 3 - 10 m thick and composed of glacio-fluvial sand. The aquifer is confined to a narrow valley, bounded on both sides and below by bedrock. Groundwater velocity within the aquifer is estimated to be 15 m/yr.

The PRB was installed across the valley using a cut-and-fill technique. The barrier spans the valley and is 15 m long, 4 m deep, and 3.5 m wide. It is composed of a reactive mixture containing municipal compost, leaf compost, and wood chips. Pea gravel was added to the mixture to increase hydraulic conductivity. Coarse sand buffer zones were installed on both the upgradient and downgradient sides of the reactive material. A 30 cm clay cap was placed on top of the PRB to minimise entry of surface water and oxygen into the PRB. Remediation at the Nickel Rim Mine Site was accomplished by sulphate reduction and metal sulphide precipitation resulting from the presence of the organic material.

Monitoring wells were installed along a transect parallel to groundwater flow. Samples were collected one month after installation and again nine months after installation. Passing through the PRB resulted in a decrease in sulphate concentrations to 110 - 1900 mg/l. Iron concentrations decreased to <1-91 mg/l. Dissolved nickel decreased to <0.1 mg/l within and downgradient of the PRB. In addition, pH increased from 5.8 - 7.0 across the barrier. As a whole, the PRB converted the aquifer from acid-producing to acid-consuming. Monitoring is planned to continue for a minimum of three years with sampling occurring biannually.

The cost was approximately USD 30000. This includes design, construction, materials, and the reactive mixture. [123, PRB action team, 2003]

At a Finnish site, a PRB has recently been installed consisting of limestone and peat in an open ditch around the quarry. The results indicated that at first the system gained reductions of metals of about 90 %. In time the system will clog and the reactive material will have to be renewed. The rate of clogging depends on circumstances, such as metal and solid substance concentrations and water amounts. Establishment costs of these kind of system construction are estimated to be about EUR 100/m³. The costs of renewing the materials are estimated to be around the same level.

This technique is applicable in reclaimed ponds where several years after closure small amounts of ARD can still be found. An alternative passive treatment is the use of wetlands. PRBs can be used for acid and alkaline waters if any of the contaminants can be removed by bacteriological reduction.

For this method to be successful, the flow regime has to be well identified in order to ensure that the water actually flows through this barrier.

The working bacteria needs a pH level around 5 - 7. The pH of ARD is usually lower, therefore the pH has to be raised to achieve sulphide precipitation (e.g. by adding limestone). However a too high pH precipitates metals, which can result in rapid clogging. Therefore the PRB needs to be well adjusted to the treated effluent in order to be effective.

PRBs have a limited treatment capacity and have to be renewed periodically.

4.3.12 Groundwater monitoring

Groundwater is usually monitored around all tailings and waste-rock areas. The level of the water table and the quality of water are monitored regularly. [131, IMA, 2003]

At a large TMF in the Legnica-Glogow copper basin, the monitoring network of ground- and surface water includes over 800 monitoring points. [113, S.A., 2002]

Generally, the specific hydrogeological conditions at the site determine the monitoring requirements rather than the size of the pond. Ponds on flat land will most likely need more monitoring points than a pond located on a site where the groundwater flow regime is better defined.

4.3.13 After-care

4.3.13.1 Alumina red mud TMF

In the after-care phase the run-off needs to be treated prior to discharge, until the chemical conditions have reached acceptable concentrations for discharge into surface waters. Also access roads, drainage systems and vegetative cover (including re-vegetation if necessary) need to be maintained. Furthermore continued groundwater quality sampling will form part of any closure programme implementation and must be continued. [22, Aughinish,].

4.4 Accident prevention

4.4.1 Tailings or waste-rock management in a pit

In order to prevent the collapse of dams' ore heaps, the best possible place to construct a tailings or waste-rock management facility is a suitable nearby pit, since in this case dam/heap stability is not an issue. Generally, it is not possible to find such a place near the facilities.

Care has to be taken that groundwater is not contaminated.

In bauxite mining, waste-rock is to a large extent directly backfilled into mined-out open pits. This allows for a reduction in the footprint and facilitates reclamation of the pits.

4.4.2 Diversion of natural run-off

4.4.2.1 Ponds

Diversion of natural external run-off may be required:

- to maintain the necessary freeboard
- to avoid contamination of the natural run-off with process liquids or chemicals
- to reduce the volume of water in those impoundments relying on evaporation, to remove excess water rather than treatment and discharge.

Three standard methods of diversion are employed, the choice generally being related to the site topography and expected flowrates:

- channels above and around the dam
- conduits underneath the dam
- tunnels through the flank of the dam.

The diversion system is critical to the safety of a tailings dam. Failure of any part can lead to the impoundment receiving floods of which it was not designed, possibly causing an overtopping with a risk of total failure of the dam. The engineering of diversion structures has thus to be given a high priority in planning the facility.

Generally, the design of red mud stacks using the thickened tailings method includes pervious perimeter rock fill dams and sealing of the underlying surface. A perimeter dam for the collection of surface run-off typically surrounds the stack.

At **Ovacik**, the TMF design includes surface run-off retention behind the upstream dam. At **Río Narcea**, the pond is surrounded by channels for the collection and deviation of surface run-off. Collected surface run-off is diverted into a segmented pond for clarification before discharge. Similarly, at the Kaolin operation in **Nuria**, the surface run-off, containing a large amount of fines, is gathered and collected in a series of sedimentation ponds.

However, it is not always possible or necessary to collect all surface run-off, e.g. at **Kiruna** the total water intake into the mineral processing plant was 61 Mm³ in 2001. Of this 3 Mm³ were captured surface run-off. Another example is the **Boliden area** where the tailings pond catchment area is 8 km². The inflow of surface run-off has been estimated to be 1 Mm³ during a dry year and 3 Mm³ during a normal year. The pond receives approximately 4.5 Mm³/yr of process-water from the mineral processing plant.

At potash TMFs saline drainage from the heaps is, as far as possible, kept separate from surface run-off.

4.4.2.2 Heaps

Water is by far the most likely cause of instability in a tailings or waste-rock heap and for the soil underneath the heap since it may lead to increased pore pressure and a reduction in shear strength. Therefore, anything that tends to increase the amount of water or pore pressures in a heap and its foundations is a potential source of weakness. Particular attention is given to drainage around the heap in order to prevent the flow of groundwater into the heap and to prevent ponding of water at the toe. On sloping ground, drains are usually constructed near the uphill side of the facility. For calculating the capacity, the following factors are taken into account:

- catchment area uphill of the drain
- existence of springs
- agricultural drains
- natural surface water flows which will be interfered with by the heap.

[130, N.C.B., 1970]

All waste-rock deposits in the Boliden area are surrounded by diversion ditches and drainage collection ditches. If required the drainage is treated before discharge.

At the Kemi site, part of the drainage water from the waste-rock heaps is collected in a ditch and led with other drainage waters from the industrial area to the tailings management area. Another part of the drainage is led directly to the nearby stream. [71, Himmi, 2002]

4.4.3 Preparation of the natural ground below the dam

The natural ground below the retaining dam (but not necessarily the ground below the tailings) is usually stripped of all vegetation and huminous soils in order to provide an adequate 'foundation' for the structure. This stripped surface needs to be examined for the presence of any springs or groundwater which need then to be dealt with by an adequate drainage system (e.g. trenches equipped with land drainage pipes surrounded with graded stone and protected with artificial membranes). [131, IMA, 2003]

4.4.4 Dam construction material

The prime consideration for choosing the dam construction material is that the materials are competent and must not weaken under operational or climatic conditions. For instance sand and rock laid down in horizontal layers and compacted by the passage of dump trucks and bulldozers, together with additional compaction by vibrating rollers, will in most circumstances provide a strong enough structure to impound tailings, even those which are deposited hydraulically in water suspensions.

4.4.5 Tailings deposition

Proper deposition of the tailings, particularly in a wet state, will always be critical to the stability of the structure. Typically the wet tailings are discharged off the crest of the dam in as even a distribution as possible around the dam, in order to create a "beach" of tailings against the inner face of the retaining dam. This will normally result in the coarser fraction of the tailings settling out nearest to the embankment, with the fines settling nearer to the supernatant pond. [131, IMA, 2003]

The basics of tailings deposition are explained in Section 2.4.2.3

4.4.6 Techniques to construct and raise dams

Tailings dams used to be constructed of the coarse tailings fraction. This can still be a very appropriate way of retaining the tailings slurry. However, the qualities of the ore can change and the processing method can change and therefore the characteristics of the tailings may change. Hence quality management is a tricky issue over the entire life span of an operation. Therefore there is a trend to construct the initial starter dam, but often also the raises with borrow material, whose quality can be more easily monitored during the construction of the dam. However not only the type of material used to construct tailings dams but also the placing and compaction of suitable construction material is essential to ensure long-term stability.

The availability of material (e.g. suitable tailings, borrow material) to raise the dam can be an issue. At the same dam height the required amount of dam construction material is many times higher for the downstream method compared to the upstream method (see Figure 4.19 below).

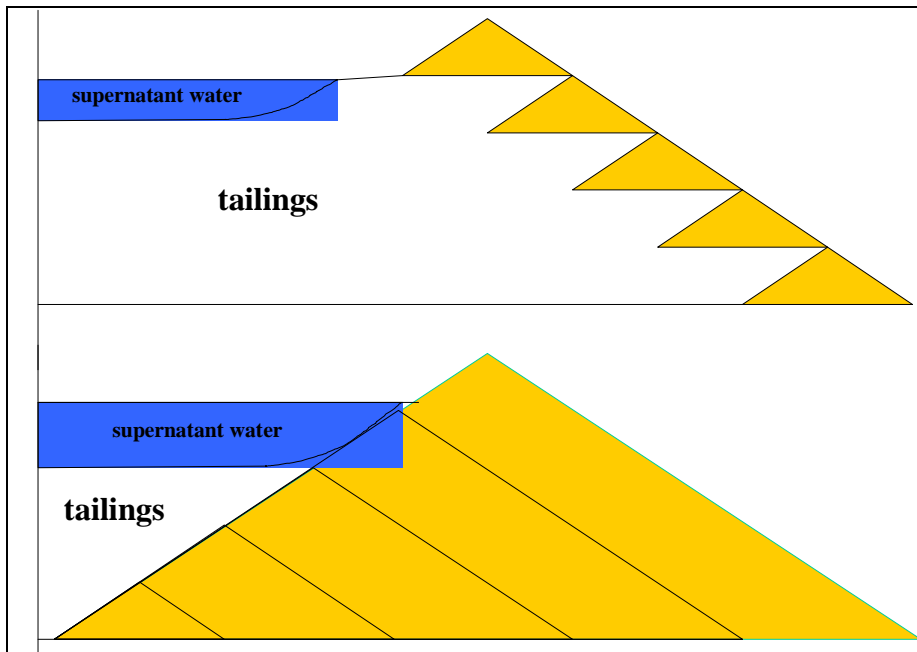

Figure 4.19: Schematic comparison of upstream and downstream method

If the dam material has to be extracted in borrow pits, the footprint of the pit will be larger and larger amounts have to be transported to the TMF for downstream construction.

Table 4.14 summarises the different ways of constructing/raising tailings dams.

Dam type	Applicability	Discharge suitability	Water storage suitability	Raising rate restrictions	Construction material	Seismic resistance	Dam cost
Conventional dam or water retention type	Suitable for any type of tailings	Any discharge procedure suitable	Good	Not dependent on tailings material properties	Natural soil borrow	Good	High
Upstream	If tailings are used: at least 40 - 60 % sand (0.075 - 4 mm) in whole tailings ¹⁾ . Low pulp density desirable to promote grain size segregation	Peripheral discharge and well controlled beach necessary, centre discharge for thickened tailings	Suitable under certain conditions	Less than 5 m/yr most desirable, to avoid insufficient consolidation and pore pressure build-up	Natural soil, sand tailings or waste-rock or sand tailings in combination with natural soil or waste-rock	Poor in high seismic areas	Low
Downstream	Suitable for any type of tailings	Varies according to design details	Good	None	Sand tailings or mine wastes if production rates are sufficient. Otherwise natural soil.	Good	High
Centreline	Sands or low plasticity fines	Peripheral discharge necessary	Not recommended for permanent storage. Temporary flood storage acceptable with proper design details	Height restrictions for individual raises may apply	Sand tailings or waste-rock if production rates are sufficient, otherwise natural soil	Acceptable	Medium

1.) does not apply to thickened tailings

Table 4.14: Comparison of dam construction techniques [11, EPA, 1995]

The basics of these dam construction techniques have been introduced in Section 2.4.2.2.

4.4.6.1 Conventional dams

The benefit of using a **conventional dam already built to its final height** before tailings deposition commences is that the dam is constructed during a short period of time when the quality control is usually easier to realise. These dams are often too costly though, which has resulted in upstream dams being more common. For this method of construction, ongoing monitoring and evaluation is necessary and vital.

This type of dam is applied where:

- the tailings are not suitable for dam construction
- the impoundment is required for the storage of water, usually on a seasonal basis, for plant or other use
- the tailings management site is in a remote and inaccessible location
- retention of the tailings water is needed over an extended period for the degradation of a toxic element (e.g. cyanide)
- the natural inflow into the impoundment is large or subject to high variations, and water storage is the needed for its control.

Advantages:

- the dam is built with supervised construction in a relatively short time span
- minimal supervision of the dam during operation
- protection against pollution by water and wind erosion.

Disadvantages:

- need for high capital expenditure before the facility is operational
- all construction materials have to be imported unless waste-rock from the mine can be used in the shoulder fill.

Staged conventional dams are also non-permeable but are raised throughout the lifetime of the TMF. One disadvantage compared to the conventional dam is that construction will be carried out over a much longer time period, which may result in lower quality due to changes in the staff and contractors making it difficult to maintain a consistent quality control.

4.4.6.2 The upstream method

The upstream method is the cheapest method, because the least amount of material is necessary for a given raise. The main disadvantage of this method is physical stability and the susceptibility of the dam to liquefaction. Care must be taken in the design stage to control the phreatic surface. This can be achieved by providing a wide enough beach, and applying correct drainage and operation. The material used to build the dam should not have ARD potential.

Note that the upstream dam discussed in Table 4.14 relates to conventional tailings management rather than thickened tailings. The suggestion that the tailings must have 40 to 60% sand fraction is not necessary for thickened tailings. For instance, red mud tailings that use the upstream tailings method very often will have already separated out the sand fraction and it is deposited in the centre of the tailings. So therefore the tailings being analysed for stability purposes at the perimeter are entirely the fine silt fraction.

Also Table 4.14 applies to dams that have annual lift rates in the order of 4 to 5 m per year. The rate of lift of most red mud tailings would be of the order of 1 to 2 m per year. The discharge suitability applies to the peripheral discharge if conventional ponding is applied and to a centre tailings discharge if thickened tailings are employed.

However, if the upstream method is applicable it may even be favourable over the other methods, especially the downstream method, as the phreatic surface will tend to remain low. Figure 4.20 illustrates this by comparing an upstream dam constructed out of cycloned tailings and a downstream dam of the water retention type using an impermeable core.

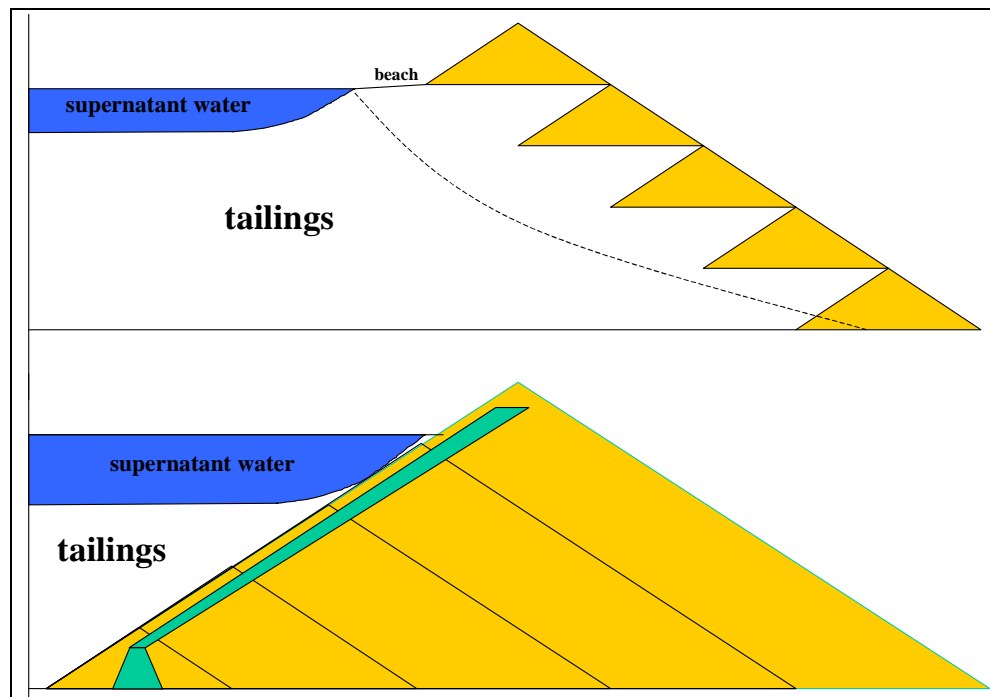

Figure 4.20: Simplified comparison of the phreatic surface for upstream and downstream method of tailings dam construction

Note that this is a simplified drawing. The upstream dam should have a downstream slope of less than 1:3 and the beach should be wider than the height of the dam. The stage-constructed conventional dam with an upstream core should have filters and drains shown, as this is where the water will flow out of these.

The upstream method might not be suitable for wet covers (see Section 4.3.1.2.1) if the free water drains too fast to keep the impoundment flooded. On the other hand, the upstream method can be a suitable dam structure to keep water in, due to the good stability of the dam because of the low hydraulic gradient.

The following conditions need to be met for water storage:

- avoidance of overtopping and maintenance of sufficient freeboard (see Section 4.4.8)
- provision of sufficient emergency discharge capacity (in Sweden 10000 year storm event, in Austria and Germany 100 year storm event (see Sections 4.4.9 and 4.4.10)
- keeping the toe of the dam unsaturated to avoid liquefaction
- good control of the water level in the pond (related to the water balance)
- monitoring of the phreatic surface within the dam to assure that the intended results are obtained.

Generally, a stability calculation is used to determine the phreatic surface.

In every case, there will also be a need for expert evaluation and assessment, e.g. independent design reviews, where the permitting authorities ask for the judgment of an expert.

4.4.6.3 The downstream method

It can be seen in Figure 4.20 above that for the downstream method the impermeable core keeps the free water in place. For increased leakage through the core, the stability of the dam may be jeopardised.

If borrow material is used, one possible negative cross-media effect may be the fact that a much larger amount needs to be extracted from the borrow pit compared to the upstream method to achieve the same height increase.

4.4.6.4 The centreline method

In many cases the **centreline method** seems to be a good compromise between seismic risk and the costs. By using this method, the available surface area and therefore the storage capacity does not decrease with each dam raise (see Figure 3.9)

4.4.7 Free water management

For a permeable dam the free water is usually kept well away from the dam crest in order to keep the gradient low [131, IMA, 2003].

4.4.7.1 Removal of free water

The standard methods for removing the free water have been shown in Section 2.4.2.4.

At Aitik the water is discharged using a **spillway** and a steel lined culvert located at the contact between the dam and the valley side. In the future, a system of **open channels** in natural ground will be used for discharging the water, eliminating the culvert through the dam. Most other metal mines in Northern Europe use this type of construction (e.g. Pyhäsalmi, Hitura, Zinkgruvan, Kiruna, Malmberget).

It is not possible to build the open channel in natural ground for a paddock-style pond.

Decant towers have proven to work well under frosty conditions with a positive water balance. However they have to be designed to resist the pressure of the tailings throughout the lifetime of the operation. Since water flow occurs by gravity, no pumps are needed, which means a constant and safe supply of energy (otherwise needed for the pumps) is not required. One disadvantage to this method is that the culvert perforates and hence weakens the dam.

At Ovacik, a variation of the decant tower is used, which may be best described as a '**decant well**'. The free water is withdrawn via a decant well constructed at the near centre of the pond. The decant system consists of a perforated tubing surrounded by rockfill (see Figure 4.21 below). This is a permanent system which is easily accessible. As opposed to discharge towers there is no tube perforating the dam. The clarified water is pumped to the mineral processing plant.

This system is applicable in small zero-discharge facilities in dry climates, where a high operating freeboard is maintained. It is also necessary to divert any surface run-off.

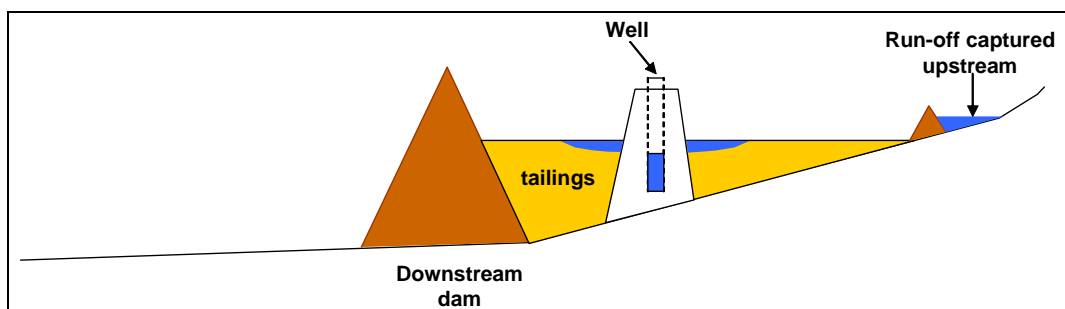

Figure 4.21: Decant well at Ovacik site

The gravel around the tower acts as a stabiliser and filter for water and aids retention of the fines. An additional feature for this system are the drainage pipes laid over the bottom of the pond during construction in fish-bone configuration and connected to the tower in order to drain and consolidate the settled solid material.

For a small pond at Ovacik a barge system was considered unsuitable because it would have necessitated moving the barge too often in order to pump free water, since the discharge points are changed frequently.

One disadvantage is that the large holding/filtering gravel support fills a good chunk of the dam. It also has limited filtering capacity and may not be practical and efficient for very large volumes.

4.4.8 Freeboard

At the Kiruna and Malmberget iron ore mines, the freeboard at the tailings dams are 2 m at two facilities and 1.2 m at the third. The freeboard is based on Swedish guidelines for water retention dams (RIDAS), including precipitation, water surface and wave run up. For a class 2 dam, a one in a 100 years, 24 hours rainstorm event, should be decanted without a raise in water level. Discharge of tailings into the pond is controlled by a relatively constant operation system producing a constant flow of tailings.

At the Ovacik gold mine, a minimum of 2 m of freeboard is provided in the TMF design.

In the industrial minerals sector, the minimum freeboard is 1 m to ensure that the pond is always capable of storing and attenuating a sudden flood in addition to its normal input of process water (see Section 4.4.10). [131, IMA, 2003]

At the TMF in the Legnica-Glogow copper basin, a minimum freeboard of 1.5 m is maintained.

According to the “Dam Safety Code of Practice”, the freeboard for dams of high risk is deduced from the maximum wave height or the depth of frost penetration [129, Finland, 1997].

4.4.9 Emergency discharge

The design of the tailings ponds and discharge facilities considers all foreseeable extreme events, such as extreme rainfall and snow smelt events. Nevertheless, further risk reduction is obtained by incorporating emergency outlets in the design. Emergency outlets are designed to work automatically if the water level reaches a predetermined critical level and to discharge any excessive water volume (that cannot be discharged through the normal discharge facilities) without hampering the integrity of the dam. In this way, emergency outlets can avoid overly elevated water levels within the dam or in the very extreme scenario over-topping, which otherwise could lead to a catastrophic dam failure.

The absence of emergency outlets in the design of the Baia Mare tailings pond was the reason for its catastrophic failure. If an emergency outlet had been in place, only a small amount of CN containing water would have been released, and no tailings would have been released.

The most commonly used system is to have a number of pipes large dimensions (so they cannot be blocked) through the dam. The pipes are installed at such a level so that the predetermined minimum freeboard will always be maintained. As erosion at the discharge end of these outlets had to be avoided, this arrangement is used as it eliminates the risk of erosion of the the dam body under extreme conditions.

Alternatively, overflows can be arranged either as controlled overflows over the dam body or constructed in natural terrain, the latter option only being available for valley type dams. For such systems, erosion protection is critical.

4.4.10 Design flood determination for tailings ponds

Under the RIDAS framework (see Table 4.1 and Table 4.2) for high consequence dams (class 1), the guidelines propose a deterministic approach, similar to the probable maximum flood (PMF) procedure, with emphasis on the critical timing of the flood generating factors. The precipitation input is however not based on estimates on probable maximum precipitation (PMP), but rather on an evaluation of observed maximum rainfalls. For a low hazard dam, the 100-year flood is used as the design flood. Typical measures to adapt to this approach may involve increasing the spillway capacity in order to safely release extreme inflows, and allowing for temporary storage above the normal high water level by raising the crest of the core. The guidelines are developed for hydropower conditions, normally with large catchment areas. For tailings dams, the catchment areas are often rather small and there is consequently a need for further development of the guidelines on this issue. [115, Mill, 2001]

According to the Finnish 'Dam Safety Code of Practice' the hazard risk class of a dam determines the design flood value. For dams of the highest risk category (P), the design flood is based on a 5000 – 10000 year return period and for the two 'lower' categories (N, O) 500 - 1000 and 100 – 500 years are to be applied when designing the spillways.

The selection of the method to determine the design flood capacity depends primarily on the hydrological data available.

4.4.11 Drainage of dams

4.4.11.1 Permeable dams

If a dam is built without any internal drainage system the conditions in Figure 4.22 a) will develop. In practice, the emergence of seepage from the outer slope and saturation of the outer toe are avoided as this may leach and cause instability unless the slope is very flat.

Permeable dams are based on the principle that seepage through the dam should be drawn down well below the toe of the outer slope. This can be achieved by applying an internal drainage system, with the drainage zone being located in the inner section of the dam.

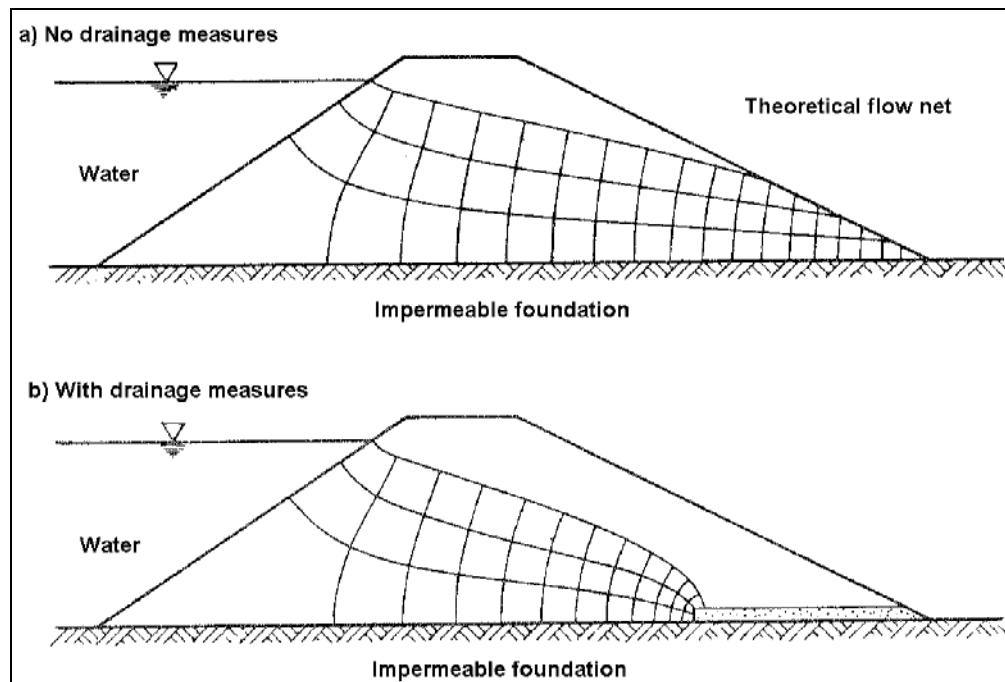

Figure 4.22: Dam without and with drainage system
[130, N.C.B., 1970]

Care has to be taken, so that the drainage, (sometimes also referred to as the filter), system does not get plugged with tailings material.

Consideration has to be given to the groundwater conditions. In some cases, it may be necessary to design a drainage system which will deal with both the groundwater and the pond drainage.
[130, N.C.B., 1970]

An example of a permeable dam with a drainage system can be seen in Figure 3.6.

At the Kernick mica dam, the sand tailings and the waste-rock have been used to construct the dam in specific zones, separated by transition layers. The waste-rock, evenly graded between 50 mm and 750 mm in size, forms a central core for the capture and drainage of seepage through the structure. The sand tailings, containing no material larger than 150 mm but typically less than 25 mm grain size, are used to form both the downstream and upstream parts of the main dam. The transition layer, consisting of clean, crushed rock typically between 75 mm and 125 mm, forms a filter layer between the sand tailings and the waste-rock core.

4.4.11.2 Impermeable dams

It should be noted that non-permeable dams also have systems similar to the drainage system shown in the Figure 4.22 above. In this case, the filter has the purpose of keeping seepage flow through the core from eroding the core and the outer slope of the dam. A typical filter for this type of dam can be seen in Figure 3.14.

4.4.12 Monitoring of seepage

Seepage through the dam as shown in Section 2.4.2.5 is not to be regarded as anything negative. It is important that a controlled seepage occurs through the dam to assure stability, by lowering the pore pressure over the dam. However, it is essential that the seepage is well controlled and managed both from the day-to-day environmental performance, as well as from an accident prevention point of view.

Seepage control is used for the management of any dam construction. By monitoring the normal seepage flow through the dam in combination with good understanding of surrounding processes (meteorology, water level in pond, etc.), an early indication can be obtained as to whether any problems may occur with the dam. Increased flow, in combination with suspended particles in the seepage, could mean that piping is starting to occur. Decreased flow could imply clogging of the drainage/filter.

Due to the prevailing hydraulic gradient (hydraulic pressure difference) between the pond and the surroundings, seepage occurs, not only through the dam but also under the dam and in some cases also through natural ground that is used for confining the tailings. Differences in the hydrogeological setting between sites makes it necessary to conduct a site-specific evaluation at each site. Depending on the outcome of this hydrogeological investigation and the necessity to collect the seepage there are various prevention and collection options available. In many cases, a combination of available options is preferred.

Section 4.3.10 discusses seepage control from an environmental point of view.

4.4.13 Dam and heap stability

The stability of dam and heap slopes depends on factors such as:

- friction angle, water saturation, phreatic surface, pore pressure
- the geometry of the cross-section
- the strength parameters of the materials (shear strength vs. shear stress) and its foundations and the resulting safety factor.

4.4.13.1 Safety factor

The safety factor of a slope is defined as the ratio of available shear strength to the shear stress required for equilibrium.

[75, Minorco Lisheen/Ivernia West, 1995]

According to the Finnish “Dam Safety Code of Practice” the total safety factor of dams in a state of constant seepage flow should be at least 1.5. At the final stage of construction, and to cover for a sudden fall in water level, the total safety should not be less than 1.3.

[129, Finland, 1997]

At the Zinkgruvan site, the stability of the two dams have been controlled by external experts, with the dams having a safety factor of 1.5 and 1.6.

The waste-rock heaps at a Finnish talc operation are designed with a safety factor of at least 1.3.

At the Bergama-Ovacik gold mine during operation with the placement of the overburden and the waste-rock on the downstream slope of the main dam, the slope changed to less than 10°, increasing the factor of safety of the dam structure to 2.23 compared to the usual 1.2 used internationally for water retention dams.

In Germany, water dams and tailings ponds follow the industry standards EN DIN 19700 T10 - 15 and DIN 4084), where a safety factor of 1.3 - 1.4, depending on the different types of design loads, is demanded and additional loads (truck traffic on the dam, snow) have to be taken into account.

According to the guidelines of the Austrian Commission on Large Dams, the factor of safety for slope stability in cases of normal load has to be at least 1.3. For safety against static soil-liquefaction, a safety factor of at least 1.5 is demanded. The safety against internal erosion, the

calculation of expected stress and movements, the stability against long term ageing and aspects concerning dynamic soil-liquefaction (e.g. due to earthquakes) also have to be taken into consideration. For all these investigations, the most important point is to give conservative and ensured assumptions for the local geotechnic parameters, as well as for the materials and the foundation (e.g. though laboratory and field tests).

As mentioned in Section 4.2.4 for long-term stable dams, where the water cover technique is applied a safety factor of 1.5 is usually considered sufficient.

4.4.13.2 Kaolin tailings heap stability

The following criteria are required to build a stable kaolin tailings heap:

- stacking must be made on a drained and topsoil-removed surface to limit slipping
- the material must be dried sufficiently before stacking, which requires a thickening process
- this can be applied down to a particle size of 80 µm.

In order to increase safety in the TMF, it is necessary to conduct a detailed stability study of the underlying ground, proposed height, groundwater situation, long-term weather conditions and the proposed composition of the tailings (kind, grain size, percentages, etc.).

Dumping can start after preparation of the ground (removal of soil, weak and soft layers) in layers, and reclaiming of the final slope taking place immediately and subsequently. Waste-rock deposited directly in contact with the underlying ground needs to be of coarse size (blasted rock) to secure permeability. Inclined underlying slopes are terraced in order to increase stability. Seepage water from the heaps is drained.

[131, IMA, 2003]

4.4.13.3 Limestone tailings dam stability

The permitting procedure for the TMF at the Münchhof limestone quarry included, according to DIN 19700 T 10, a proof of stability of the dam including static and hydraulic aspects.

The stability calculation is carried out with the following elements:

- geotechnical and hydrogeological modelling
- slope stability
- shear strength
- base failure safety
- safety against pore pressure build-up in the foundation
- overtopping and erosion stability.

Another essential requirement for the dam stability is the suitability of the dam construction material. This is investigated in geotechnical tests. The following parameters are examined:

- friction angle
- specific density
- compressibility
- water content.

During the construction, phase quality management was applied to ensure that the parameters crucial for the stability of the dam were met. This applied to the dam foundation, the dam body and the dam core. [108, EuLA, 2002]

4.4.14 Techniques to monitor the stability of dams and heaps

4.4.14.1 Development of a monitoring plan

Surveillance of the stability of a dam includes monitoring of the instrumentation (on-line or at a defined frequency), inspections (daily/weekly/monthly) and detailed audits/reviews at longer intervals (1 - 20 years).

A surveillance plan is developed based on an analysis of the critical factors, potential failure modes and the indicators of malfunctions. The frequency of monitoring, depends on an evaluation of the consequences of a failure.

The monitoring plan typically also includes:

- a description of the purpose for monitoring the individual parameters
- assessment criteria for the evaluation of results
- an identification of the person/function responsible for the monitoring, data compilation, evaluation and reporting
- a schedule for the plan review.

4.4.14.2 Measurements, instrumentation and frequency for tailings dams monitoring

The monitoring of dam stability includes a monitoring system for assessing the actual stability of the TMF, including its dam structures.

Table 4.15 gives examples of measurements that are usually performed, the instrumentation used and the frequency of manual checks/measurements and indicated relevant frequencies of the monitoring itself.

Measurement	Instrumentation	Frequency
Water level in pond	Level scale, doppler	Weekly, daily or online
Seepage discharge through: <ul style="list-style-type: none"> ▪ the dam itself ▪ the foundation ▪ the abutments 	<ul style="list-style-type: none"> ▪ weirs or containers ▪ pore water pressure gauges ▪ groundwater wells 	Weekly, daily or online
Seepage samples	Taking of samples and measurement of turbidity	Monthly or weekly
Position of phreatic surface	Piezometer (typically open standpipe)	Monthly or weekly
Pore pressure	Piezometer or bourdon tube pressure gauge	Monthly or weekly
Movement of dam crest and tailings	Geodetic datum points on beach (completed dam) and crest of the dam, aerial photography, GPS	Yearly or half-yearly
Seismicity	Strong motion accelerographs	Events (not done on site)
Dynamic pore pressure and liquefaction	Vibrating wire piezometers	Yearly
Soil mechanics	Penetrometers for density and shear strength	Yearly (only during design phase)
Tailings placement procedures	Shear strength, compressibility, consolidation, grain size and density samples, width of the non-submerged beach as indication of phreatic surface via aerial or satellite photography	Yearly (only during design phase)

Table 4.15: Typical measurements their frequency and instrumentation for tailings dams monitoring

Adapted from [7, ICOLD, 1996]

Table 3.22, Table 3.23 and Table 3.24 list examples of the measurements carried out at some base metals operations.

Measurement	Instrumentation	Frequency
Bench/ slope geometry	GPS	Half-yearly
Sub-tip drainage	Weirs/ V-notches	Yearly
Pore pressure (where a potential risk)	Piezometers/ standpipes	Yearly

Table 4.16: Typical measurements their frequency and instrumentation for heaps monitoring

4.4.14.3 Inspection and audits/reviews

The overall monitoring plan typically also includes plans for inspections and audits/reviews.

Table 4.17 proposes a monitoring programme during operation and in the after-care phase.

Assessment type	Frequency		Personnel
	Operational phase	After-care phase	
Visual inspection	Daily	Half-yearly	Dam operators, after the closure possibly follow-up staff
Annual review	Yearly	Yearly	Engineer
Independent audit	Bi-annually	Every 5 - 10 years	Independent expert
Safety evaluation of existing dams (SEED)	15 - 20 years	15 - 20 years	Team of independent experts

Table 4.17: Tailings dam assessment regime during operation and in the after-care phase

Assessment type	Frequency		Personnel
	Operational phase	After-care phase	
Visual inspection	Daily	Half-yearly	Heap operators, after closure possibly follow-up staff
Geotechnical review	Yearly	Every 2 years	Engineer
Independent geotechnical audit	Every 2 years	Every 5 - 10 years	Independent expert

Table 4.18: Heaps assessment regime during operation and in the after-care phase

The given frequencies for the after-care phase are relevant for the initial period after closure. Based on their results the frequency may be decreased with time to an extent that inspections, audits/reviews are no longer necessary if restoration is properly completed. Furthermore, the monitoring programme in the after-care allows the verification that the overall closure objectives and long-term functioning are met. If the closure objectives are not met, corrective measures need to be taken during the verification period.

Routines to assess the stability of dams and heaps may include the following:

Visual inspections - carried out by an experienced operator/supervisor, following a pre-determined 'checklist' which focuses on the features that are likely to lead to problems if they are not corrected, for example, blocked overflows, damaged pumps, excessive erosion, excessive wetness at the toe of the slope etc. These checklists are based on features which are immediately observable by experienced operators and which can be easily corrected within a reasonable period of time. It is this kind of simple inspection regime can keep a heap or a pond in good daily order; i.e. daily inspections should not be based on matters which require a more detailed scientific approach. It is important to ensure that these daily inspections are recorded for future reference, and, that if they reveal some matter of concern to the operator, which he is

unable to correct or which is particularly abnormal, then there is a procedure in place to notify a more competent person.

An example of the items to check during the daily inspection is provided in Annex 6.

Annual reviews – these include a full topographical survey of the structure at least once per year, or more frequent if the structure is large and under constant development. Accurate plans and cross-sections of the structure need to be prepared upon completion of these topographical surveys, all of which are logged into a retrievable database.

At least once a year, accurate survey measurements need to be taken of "observation pillars" or "plates" erected on the structure (particularly tailings ponds), checking for any sign of horizontal or vertical movement. It is important that these pillars have a reference datum which is on solid ground beyond the footprint of the structure. In structures where there is a potential risk of high phreatic surface or seepage zones (more likely in tailings ponds), a system of vertical piezometers needs to be installed, both within the above surface structure of the tailings embankment and below the ground level into the sub-strata. These piezometers need to be read at least once per 'season', i.e. winter, spring, summer and autumn, in order to record any seasonal differences, particularly in groundwater flow. If high levels of water are deliberately stored on a pond (for dust control perhaps), then it may be necessary to read these piezometers more frequently. These readings are ideally computer logged and annotated on the cross-sectional drawings so that the 'seepage performance' of the structure can be easily identified. Where seepage from the embankment structure is released by, or flows through a drainage system (e.g. pipes/stone filters, etc.) these systems are usually equipped with measuring weirs or conduits so that any decrease or increase can be identified and recorded for future reference. These systems need to be checked at least once per season, and any sudden or abnormal change should be notified to a more competent person.

An example of the items to check during the annual review is provided in Annex 6.

Independent audits - need to be undertaken at least once every two years for structures which are already in operation. These reviews are carried out by a team of experts (often including an independent expert). These assessments include a review of all the data available, the daily inspection records, the surveillance results, the piezometer measurements etc, in order to form an opinion as to the stability of the structure; both at the time of the assessment and during the period leading up to the next assessment. If the assessment identifies any features of fundamental concern, then it is essential for the competent person to bring such concerns to the attention of the operator, including recommendations for resolving the problem.

[131, IMA, 2003]

SEED audit – (Safety Evaluation of Existing Dams) audits are carried out every 15 - 20 years by a team of independent experts. These audits include going through all documentation related to the dam, questioning all the basic assumptions made leading up to the design and construction of the dam and assessing the coherence between the design and the "as built" dam. The audits should also include a review of all the data available, the daily inspection records, the surveillance results, the piezometer measurements, etc. In this type of review all new developments in the area of dam safety and hydrology have to be taken into account and suggestions made on how to up-date the existing dam is compared to new knowledge and developments. The output of the review will enable the experts to form an opinion as to the stability of the structure.

For more information on audits see also Section 4.2.3.2.

4.4.14.4 Stability of the supporting strata

The most stable tailings or waste-rock facility will still fail if the foundation it is built on is not stable. Therefore it is important to investigate the suitability of the supporting strata in the planning phase (see Section 4.2.1.4).

During the operation of potash tailings heaps, for example, the **stability of the supporting strata** is controlled regularly by seismic monitoring, which searches for and determines seismic, seismic-acoustic and geomechanical events or subsidence of the surface resulting from the mining activities. Surveys of pillars and the determination of the mineral compounds are used to calculate and observe the stability of the mined-out rooms (see Section 3.3.3.2).

This type of monitoring is suitable for operations where there is a history of seismic events, or which are in the proximity of underground mining operations.

4.4.15 Cyanide management

In addition to the treatment of cyanide (see Section 4.3.11.8), CN leaching and the management of CN in general involves a large amount of security measures to prevent accidents and negative environmental impacts. The design of the plant also includes several technical solutions aimed at the prevention of accidents and environmental impacts, such as:

- incorporating an integrated a cyanide destruction circuit into the leach plant. This circuit has a design capacity twice the actual requirement
- using the tailings pond system as a second cyanide treatment facility, serving as a backup to the cyanide destruction circuit
- combining the flotation plant tailings (for the extraction of base metals) and the gold leaching circuit effluent prior to cyanide destruction to prevent an increase of pH, which may cause dissolution of already precipitated cyanide complexes
- installing a backup system for lime addition
- correcting the leach circuit to a collection pond with a volume equal to the containing capacity of one leach tank
- placing the leach tanks in a concrete trough with a surrounding berm, which also functions as a collision barrier. The capacity of the trough exceeds the volume of one leach tank. The floor is heated to avoid build up of snow and ice during winter
- keeping open leach tanks placed outdoors
- installing backup power generators
- pumping all spills back to the circuit.

[50, Au group, 2002]

Further information on cyanide management can be found on the website of the international cyanide management code for the manufacture, transport and use of cyanide in the production of gold: www.cyanidecode.org

4.4.16 Dewatering of tailings

Tailings in a slurry form typically consist of 20 – 40 % solids by weight, but levels from 5 – 50 % solids have been known. They are typically managed in tailings dams (see Section 2.4.2). This is typically the most cost effective way of managing these tailings.

Additional advantages of this way of dealing with the tailings are:

- no dusting occurs due to the water saturation of the tailings (this may change once they are part of the beach and are exposed to sun and wind)

- ARD is inhibited.

The main disadvantage of dealing with slurried tailings is their mobility. In case the containment structure (i.e. the dam) collapses, they liquefy and can cause considerable damage, due to their physical and chemical characteristics. To avoid this problem some alternatives have been developed, i.e. 'dry' tailings and thickened tailings (see Sections 4.4.16.1 and 4.4.16.2)

As can be seen in Table 3.59 and Table 3.60 tailings management costs for slurried tailings management vary between EUR 0.3 and EUR 1.6 per tonne of dry tailings.

4.4.16.1 'Dry tailings'

At the Greens Creek Mine in the US, the tailings are thickened and then filtered to produce a filter cake containing about 12 % moisture. About half of the filtered tailings are used as backfill in the underground mine, after mixing with 3 - 5 % cement. The remaining tailings are trucked to a surface impoundment where they are compacted to specifications designed to minimise water and oxygen infiltration.

The tailings are fine (80 % passing 20 – 30 μm) and require an expensive dewatering process known as pressure filtration. The 'dry tailings' method was found to be the only practical (and economic) method for Greens Creek, due to the unavailability of a suitable area for a conventional tailings pond, and due to the specifications for mine backfill.

The total operating cost of 'dry' tailings disposal at Greens Creek is probably around USD 4 - 6 per tonne (year 2002) for 1000 tonnes of tailings per day. The cost is associated with thickening reagents, compressed air (mainly electric power) for the pressure filters, operating and maintenance labour and supplies and trucking of the tailings 15 km to the surface impoundment. This is much more expensive than a typical 'wet' slurry disposal system, where the tailings are piped to a tailings pond (often by gravity) and allowed to settle, and the clear water pumped back to the processing plant.

At the Asturiana de Zinc operation, the cost for the dewatering in belt filters is currently EUR 0.95 per tonne of ore. The investment cost of the filtration plant was EUR 3.5 million.

At the Neves Corvo site, the cost for dewatering on pressure filters is expected to be EUR 2.5 per tonnes of ore. These tailings with a net acid generating potential will be covered rapidly (within 8 months), in order to avoid oxidation.

Another large scale dry tailings disposal is used at the La Coipa gold/silver leaching project in Chile. There, 15000 t/d of tailings are dewatered on vacuum belt filters and then conveyed to a stacking system in the impoundment area. The costs are much lower than Greens Creek, because:

- the tailings are coarser and can be filtered on vacuum rather than pressure filters
- the economies of scale (15000 t/d vs. 1000 t/d), and
- the site conditions (flat dry desert vs. mountainous wet climate).

[120, Sawyer, 2002]

With tailings that have an ARD potential, the dry tailings method may lead to irreversible oxidation, which opposes the principle of ARD prevention. It is not practical to cover the tailings to prevent this oxidation.

In hydrometallurgical operations (i.e. leaching), this method is part of the process. In combination with naturally available clay layers for tailings deposition this method may be applicable (see Section 6.4).

This method may be favourable in cases where the available space is very limited. However, possible cross-media effects, such as energy consumption for filtration, truck emissions, and possible dust emissions, need to be considered.

For many low grade operations, this method is cost prohibitive to the extent that the tailings management cost may exceed the ore value.

Several legislations exist which require that tailings with an ARD potential water are kept saturated at all times, therefore in many cases this technique is not an available option.

The cost for this technique increases exponentially with decreasing grain size.

In all European potash operations, the tailings are managed dry.

4.4.16.2 Thickened tailings

An option for a safer tailings management is paste (or thickened tailings) disposal rather than slurry disposal [116, Nilsson, 2001].

The basics of this technique have been introduced in Section 2.4.3. Essentially, thickened tailings management requires the use of mechanical equipment to dewater tailings to about 50 - 70 % solids. The tailings are then spread in layers over the storage area, to allow further dewatering through a combination of drainage and evaporation [11, EPA, 1995].

The main difference to the 'dry' tailings, described in the previous section, is the solids content after dewatering. In the 'dry' method the tailings are filtered to a 'cake' with about 12 % moisture. Thickened tailings only dewater the tailings to a 'paste' with 30 – 50 % moisture (i.e. 50 – 70 % solids).

The main benefit of this technique is that the tailings are less mobile, which is beneficial in the event of a tailings dam burst.

Other advantages and disadvantages are:

Advantages:

- cost of maintenance and closure reduced
- storage capacity is greater for the same height of perimeter dam (this is not the case in red mud management)
- susceptibility to liquefaction is low, giving higher earthquake resistance
- the need for a decant system, is avoided
- reduced seepage to surrounding terrain
- most of the water is separated at the mineral processing plant, hence the need to recycle water from the pond is reduced. [77, Robinsky, 2000]

Disadvantages:

- transport of thickened tailings may be difficult and expensive; effectively done by the thickening facility at the management site [21, Ritcey, 1989]
- dusting may occur from the dried out surface, therefore an irrigation system may be necessary [21, Ritcey, 1989]
- a special system for collecting surface water run-off and drainage will have to be constructed. The collected water requires proper management.

In addition to being a discharge method, this method has been recommended to cover existing conventional tailings ponds [21, Ritcey, 1989].

The thickened tailings method may be of particular advantage under the following conditions:

- flat topography, allowing development of a wide conical deposit with flat slopes
- where the construction of a conventional dam may be costly because of site conditions
- where the tailings are so fine that no coarse fraction is available.

[21, Ritcey, 1989]

This method is not applicable under the following conditions:

- less than 15 % <20 μm (dry basis) in the tailings [138, Verburg,]
- if tailings have an acid-forming potential.

One publication claims that thickened tailings are also advisable for tailings with acid generating potential. This is justified by the fact that the fines in the homogenous mix of thickened tailings provide high capillary suction that maintains the tailings in a saturated state, thereby inhibiting acid generation [77, Robinsky, 2000]. However this is often disputed and has not been proven on a full industrial scale.

Figure 4.23 shows a comparison of a thickened tailings system and a conventional tailings pond in the same setting.

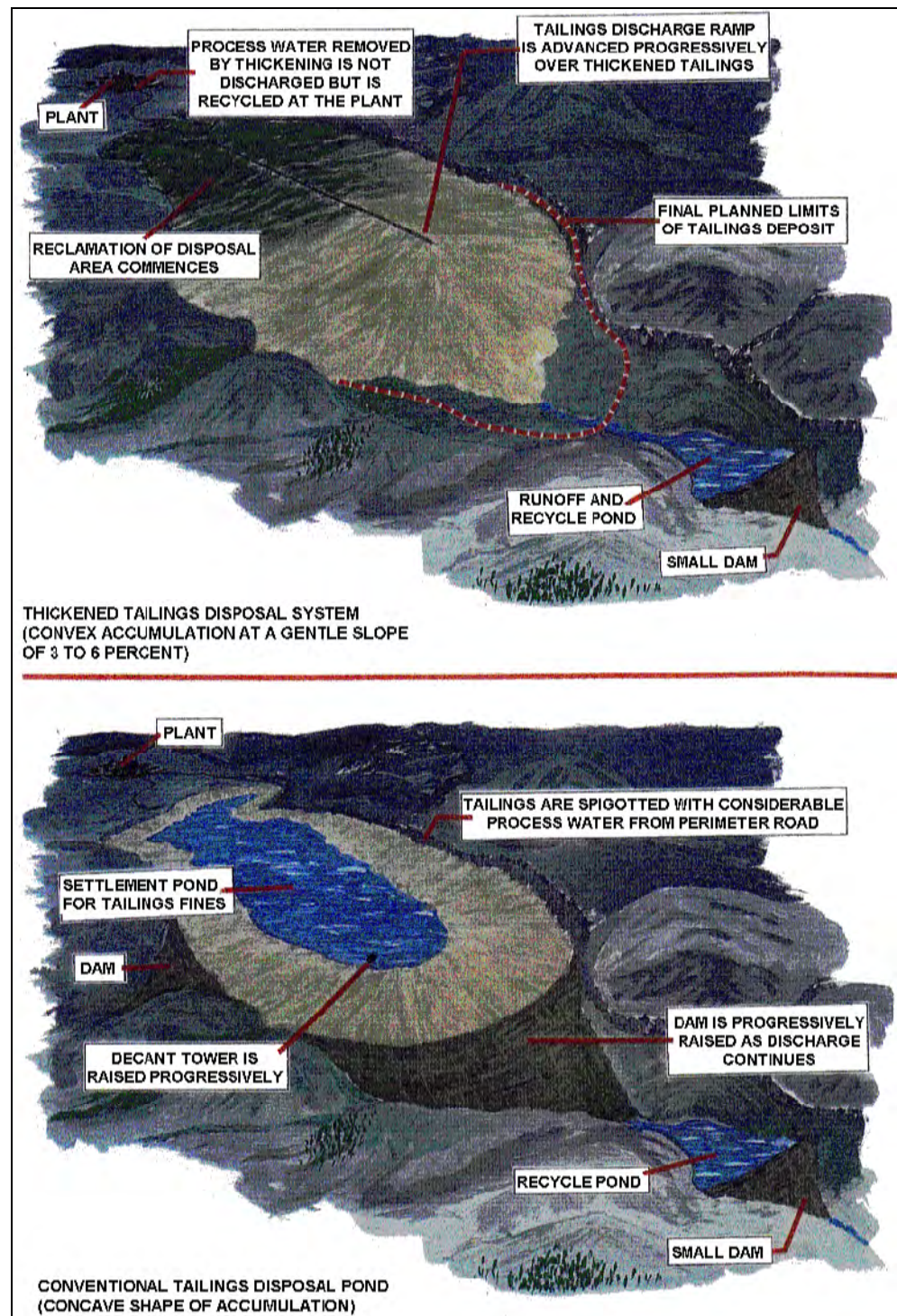

Figure 4.23: Comparison of thickened tailings system and conventional tailings pond in same geological setting
[77, Robinsky, 2000]

Thickened tailings are deposited at 50 - 70 % solids. This means that they contain more water than can be stored in the pore volume of the tailings, which subsequently implies that some water will have to be discharged from the facility in some way.

The operating cost for thickened tailings are about 25 % higher compared to slurried tailings management if deep thickeners are used and 40 % higher if filters are used.

For **alumina refining** the main differences between the use of thickened and slurried tailings can be summarised as follows:

Slurried tailings management involves much more water being treated with the mud. This method has the advantage that the slurry is easily pumpable by standard centrifugal pumps at relatively low pressure in the pipeline. The water available to suspend the mud may be seawater, if available in the refinery vicinities, together with an associated neutralisation of residual caustic. The pumping may be carried out over relatively long distances (several kilometres) between the refinery and the pond without the danger of a pressure drop along the pipeline.

Thickened tailings management is associated with a good recovery of the caustic mother liquor, as the management at the pond will not involve further neutralisation. The density and viscosity of the thickened tailings (sometimes also called 'paste') is so high that the dewatering is carried out preferably at the TMF, unless the stack is located adjacent to the refinery. If the two sites are some distance from each other, pumping is done at low density prior to dewatering at the pond site, to produce the thick slurry right at the pond feed, in which case the surplus water has to be pumped all the way back to the plant. Therefore, this technique involves an additional investment for a high pressure pumping station, such as membrane pumps, or installation and operation of a deep thickener at the pond, i.e. when far from the refinery.

The compaction of the decanted and aged slurry does not show any significant differences to 'matured' tailings. In both cases, the figures are around 70 % solids.

4.4.16.3 Dewatering of fine coal tailings

In some coal operations, fine tailings <0.5 mm from flotation are first thickened to 25 – 50 % solids. Provided sufficient area for final deposition in engineered ponds is available, processed fine tailings are transported via pipelines or trucks – depending on the distance and volumes - to these facilities. When, deposition of the fine tailings on heaps is selected, e. g. for reasons of area capacities, the tailings have to be further dewatered in order achieve a sufficient structural stability.

In principle, three methods are applied for further reducing the thickened tailings' water content:

- chamber filter presses-usually featuring more than 1000 m² of filter area, resulting in 75 - 80 % solids (see Section 2.3.1.10)
- solid bowl centrifuges-resulting in 50 – 70 % solids (see Section 2.3.1.10)
- sedimentation ponds-resulting in 50 – 70 % solids (temporary storage in ponds, see Section 3.4.3.2.2).

4.5 Reduction of footprint

The use of thickened or dry tailings management can decrease the footprint (see above). Otherwise the most efficient way to reduce the footprint of tailings and waste-rock management facilities is to backfill all or part of these materials. However, it should be noted that in many cases, even if as much of the tailings and/or waste-rock are backfilled, surface management will be necessary due to the increased volume of extracted material.

For all means of reducing the footprint the environmental impact needs to be assessed.

4.5.1 Backfilling of tailings

A basic description of backfilling has already been given in Section 2.4.5.

Possible reasons to apply backfilling are:

- for underground mining, to:
 - provide a working platform to extract the ore above (i.e. cut-and-fill mining)
 - assure ground stability
 - reduce underground and surface subsidence
 - provide roof support so that further parts of the orebody can be extracted and to increase safety
 - provide an alternative to surface disposal
 - to improve ventilation
- for open pit mining, for
 - decommissioning/landscaping
 - safety reasons
 - minimisation of foot print (e.g. as opposed to building pond or heap)
 - risk minimisation by backfilling pit instead of building a new pond or heap.

It is important to carefully analyse all the available options, as backfilling may not always provide the lowest impact solution.

The large stopes that are created in sublevel stoping make this an ideal mining method for combining with backfilling, since it is easy to dump solid or slurried tailings into the large openings. The usually much smaller remaining voids in longwall, room-and-pillar, and cut-and-fill-mining result in increased backfilling costs. Backfilling may still be applied in these cases if the ore has a high value and backfilling allows a higher extraction rate, because safety pillars can be mined after the previous voids are backfilled. If caving is applied, backfilling is not possible, because the voids are immediately filled with fallen material.

Another field of application is the backfilling of already mined out nearby open pits or any other 'opening'. The backfilling of slurried tailings in pits still in operation is usually not possible.

From an economics point of view, hydraulic backfill is the most interesting option. However if the mining method requires the backfill to stabilise quicker the need to add cement may arise. In most cases, the cost of adding cement will make backfilling uneconomical. Therefore in several operations alternative binders are used. Depending on the local situation, these materials are available at lower or even no cost. At one site the cost per tonne of fly ash delivered to the mine amounted to EUR 17 – 18 (yr 2003).

Transferring tailings to mine out pits will usually only be economical if the pits are within a maximum of a few kilometres distance and the tailings can be transported by pipeline.

For European base metal underground operations, tailings (16 – 52 % of total tailings) are commonly backfilled. At Pyhäsalmi, 16 % of the tailings are used in the backfilling of the mine, the remaining 84 % (180000 t/yr) are deposited in a tailings pond. This relatively low backfill percentage can be explained by the fact that only the coarse tailings are suitable for backfilling.

4.5.1.1 Backfilling as part of the mining method

At Garpenberg and Garpenberg Norra, the mining method used is cut-and-fill. The coarse fraction of the tailings (sometimes referred to as hydraulic sandfill) is backfilled and used as a platform when mining the ore above. Figure 4.24 illustrates how backfill is used in the cut-and-fill method.

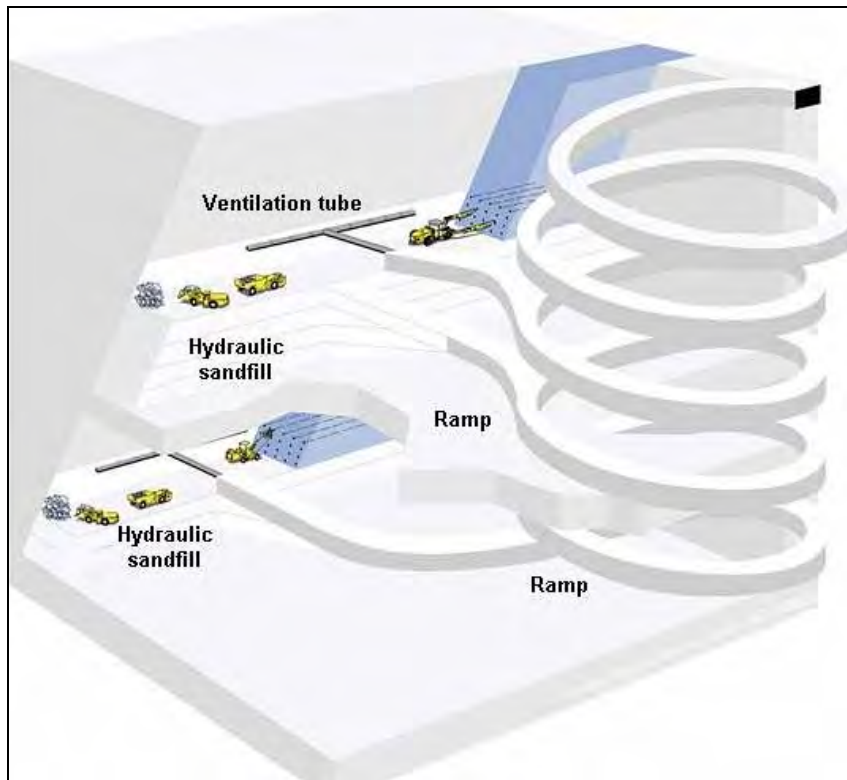

Figure 4.24: Cut-and-fill mining using backfill (hydraulic sandfill) as a working platform to extract the ore
[93, Atlas Copco, 2002]

All mining voids (or openings) created at Garpenberg are backfilled with waste-rock from development works and tailings. The concentrates constitute about 10 % of the ore processed, which means that 90 % become tailings, and the 50 % of those tailings are used for backfilling. When the ore is blasted, crushed and ground the volume increases by about 60 %, which means that the volume of tailings in Garpenberg is about 145 % of the volume of the mined ore. There are no possibilities to backfill more tailings underground for geometric reasons.

At Zinkgruvan, the mining method used also requires backfilling.

4.5.1.2 Backfilling in small-scale open pit mining

In one small barytes pit in Spain, the fine tailings are dewatered in a concrete pool and the 'cake' is then discarded by trucks in the open pit. This technique is applicable in small-scale operations and under climatic conditions where the tailings dewater rapidly [110, IGME, 2002].

4.5.1.3 Backfilling of filtered tailings

In a fluor spar operation in the Southern Pyrenees, the tailings, containing 1 to 5 % CaF_2 , are backfilled into the mine after dewatering with filter-presses.

4.5.1.4 Partial backfilling in open pits

At a feldspar operation in Segovia, 110000 t/yr of tailings are generated (mine production 600000 t/yr). These consist of a sandy fraction (80000 t/yr) and the tailings after flotation. The sandy fraction are coarse sands that do not have a market. They are backfilled in the open pit. The flotation tailings are filtered. The filtercake (28000 t/yr) is also backfilled whereas the remaining slurry is sent to small ponds. The backfilling area in the open pit was prepared by putting a drainage system in place to control and sample the drainage water prior to discharging to the river.

4.5.1.5 Backfilling in a mined-out pit

The tailings pond of the Flandersbach limestone quarry is installed in a mined-out quarry. The area today is 27 ha. The area in the future will be about 60 ha. The total capacity is over 30 Mm³. The pond is located close to the mineral processing plant. The pipes for the process water to the pond and for the clarified water back to the mineral processing plant have a length of about 1 km. There is also groundwater inflow into the pond from dewatering of the working quarry. Surplus water is led into a nearby river. [107, EuLA, 2002]

4.5.1.6 Backfilling underground stopes

In potash mining, backfill is applied in steeply dipping deposits where sublevel stoping (also called 'funnel mining') is carried out. The mined-out stopes, 100 – 250 m in height, are backfilled with salt tailings.

4.5.1.7 Backfilling in underground coal mining

In underground coal mining, backfilling is also an option. This can be done by transporting the tailings back into underground working areas and filling the previously created cavities, called the 'gob' or 'goaf'. In coal mining, backfilling is dependent on a series of geological and technical conditions in order to be applied successfully in economical terms. Since clay content in tailings from hard coal can cause blockages in pipelines when pumped with water, in the Ruhr, Saar and Ibbenbüren areas pneumatic backfill methods have been favoured in the past.

In the 1970s, backfill methods for flat dipping seams had been developed allowing integration of the backfill technique into extraction, conveying and face support technology. Limits of application were identified for pneumatic backfill operations with low seam dips and seam thicknesses of less than 1.9 m. Several approaches, aiming at applying backfill methods in smaller coal seams have failed.

Investment costs for an adequate backfill infrastructure in Ruhr, Saar and Ibbenbüren collieries have been calculated at up to EUR 40 million. Additional investigations showed, that operational costs implied by backfill operations amount to EUR 20 per tonne of coal produced, split equally between staff and material costs.

The application of backfill technique results in a considerable burden in economic terms owing to the large investment and increased operational costs (also due to be performance losses in extraction operations). Backfill operations, therefore, are considered for those cases, in which they are economically tolerable and necessary for ecological reasons with regard to the ground-surface situation. Backfilling is currently not practised in the Ruhr, Saar and Ibbenbüren area.

Some potential advantages of the pneumatic backfill technique, are:

- reduction in surface subsidence of approximately 50 % compared to caving and therefore reduction of internal and external mining damages on the surface
- reduction of tailings volumes to be managed on the surface
- extension of operational lifetime of the existing or planned dump sites
- cost savings of the surface management of tailings
- better handling of rock strata pressure
- advantages for mine ventilation system, improving climatic conditions underground
- under certain circumstances, reduction of underground water intake.

However, these need to be considered in the light of a series of disadvantages, i.e. :

- usually, subsidence movements last longer compared to the caving method (can cause delay in surface rehabilitation works or repeated damages at already repaired objects)
- idle times at coal production owing to disruptions in backfill operations (e. g. damages at back-fill pipeline); this can cause unfavourable extraction dynamics, i. e. change of load (delay/acceleration) of the movement processes covering rock strata and surface
- backfill panels adjacent to caving panels create effects of a pillar edge, equivalent to an elongation peak on ground surface
- increased rock burst danger as compared to caving method
- installation of backfill system at an existing colliery is very difficult and expensive (dimensions of underground roadways and entries)
- need of a second conveyor system for tailings transport in opposite directing to coal transport requires large investment
- exact synchronisation of tailings supply with coal production is necessary
- backfill method limits the face operations in terms of advance speed and panel production capacity, sometimes requiring alternative panels
- additional hazard potential through tailings in shafts for personnel transport
- increase of production costs by at least EUR 20 per tonne of coal through backfill operations

[79, DSK, 2002]

- increased safety hazards, especially when hazardous waste (e.g. fly ash) is added to backfill, due to narrow situation in haulage road and longwall.

4.5.1.8 Addition of binders

To overcome the lack of true cohesion in hydraulic backfill, cement and/or other binders are sometimes added. These binders can be fly ash or slags from large combustion plants, waste incinerators or smelters. They can replace some or all the cements. The suitability of alternative binders depends on the calcium oxide content, which determines the final hardness and the reaction time. Often a larger amount of these binders may be required to match the final hardness achieved when using cement. Possible problems associated with using these materials can be varying qualities, high pH and the presence of heavy metals or soluble elements.

4.5.1.9 Drainage of backfilled stopes

Hydraulic backfill in underground stopes has to be drained. Figure 4.25 shows an example of a drainage system in an underground mine.



Figure 4.25: Backfill drainage system

4.5.1.10 Paste fill

One specific way of backfilling is to utilise paste fill (see Section 2.4.5). In this technique, the entire tailings (not only the coarse fraction) are mixed with cement to create a paste. By doing this, the density of the mixture increases and more tailings can be stored in the voids underground [118, Zinkgruvan, 2003]. In this way, it is anticipated that up to 65 % of the tailings will be possible to backfill as opposed to the about 50 % when using hydraulic backfill. Several mines are moving towards paste backfill as a lower cement content (3 – 6 %) is necessary to gain the equivalent strengths needed to withstand roof pressure as compared to conventional hydraulic backfill. [94, Life, 2002]

Achieved advantages with this technique, in addition to the increased amount of backfill, are;

- for mine water with low pH: increase of pH in the mine water due to the use of cement
- less water compared with traditional hydraulic backfill
- greater stability since voids are filled with not just tailings but also with cement.

Disadvantages:

- cost for building paste fill plant
 - additional cost for cement
- [118, Zinkgruvan, 2003]
- an engineered containment structure is necessary.

Paste fill is an option in cases where:

- there is a need for a competent backfill
- the tailings are very fine, so that little material would be available for hydraulic backfill. In this case the large amount of fines sent to the pond would dewater very slowly
- it is desirable to keep water out of the mine or where it is costly to pump the water draining from the tailings (i.e. over a large distance).

Tailings used for backfill have to be dewatered in thickeners or filters. This is more costly and energy consuming than for hydraulic backfill.

The delivered cost of cement to the mine site is typically USD 80/t (year 2002). A dewatered tailings product from a filter plant could average around 15 - 20 % moisture, in this case 3 - 5 % cement addition by weight would be enough to combine with the free moisture to produce a fairly stiff mixture which would be quite stable. This would therefore cost about USD 2.40 to 4.00 per tonne of tailings placed ($3/100 \times 80 = \text{USD } 2.4/\text{t}$) [120, Sawyer, 2002]

4.5.2 Backfilling of waste-rock

In **underground mining**, waste-rock is frequently used as backfill in order to increase stability and to facilitate the mineral extraction, which decreases the need for bringing the waste-rock up to the surface.

The backfilling of waste-rock into mined-out open pits is often practised within the mining industry. This reduces the need to expand waste-rock heaps and therefore minimises the footprint and can often be cost effective. The method is practised during operation when:

- the waste-rock can be directly placed into mined-out open pit areas without the need for temporary storage and double handling, and when the available open pit is within reasonable transport distance (this is sometimes referred to as ‘transfer mining’)
- towards the end of the mine life in an open pit there might be areas within the pit where waste-rock can be permanently placed without safety risks and without obstructing the extraction activity. In such a case, waste-rock is permanently deposited in these locations instead of brought up to the surface.

Furthermore, at closure, if found economically feasible and environmentally motivated, be an option to move parts of the generated waste-rock back into the open pit. This is normally done due to stability reasons or if parts of the waste-rock have a net ARD potential and in this way they could be permanently deposited under water when the open pit naturally fills up with water. However, this is not done if:

- the cost for moving the waste-rock back into the pit is higher than applying the adequate decommissioning methods where placed
- if moving the waste-rock into the pit would not infer any significant stability, environmental or economical benefit compared to decommissioning the waste-rock heaps as placed on the surface
- if the extraction has stopped before the ore/mineralisation has been depleted, as depositing waste-rock into the pit would then make it significantly more difficult and costly to access the remaining mineralisation in the future, if so required.

Waste-rock arising from UK open pit coal mines is managed in temporary heaps during operation. After removal of coal deposits, the waste-rock is then returned to the void and restored.

Care has to be taken if oxidised sulphide waste-rock is deposited into a mined-out open pit as it may release relatively high amounts of acidity and dissolved metals. In such cases, it is important to secure a high pH in the pit water, which can be achieved by e.g. liming.

4.5.3 Underwater tailings management

At the Hustadmarmor calcium carbonate operation in Norway, the tailings are discarded into a fjord, which is sheltered and deep, as no suitable land is available for management of the tailings.

The monitoring programme, used to control the environmental impact inside and around the deposit area, covers the following parameters:

- Water analyses:
 - solids content (turbidity)
 - salinity (sea water)
 - oxygen content
 - temperature
- Sediment analyses:
 - of calcium carbonate content
 - fine particle content
 - biological activity
 - content of flotation reagents
- Shallow waters:
 - biological activity
 - visual documentation (photos).

In addition, other measurements are applied in order to be able to develop suitable models etc. in order to predict future development. These include:

- sea current measurements
- depth measurements and volume calculations
- video filming of the seabed
- revegetation of the seabed area after depositing is ended.

Operation of the process and the tailings management system includes:

- washing the fines from the flotation feed
- computer-based process control
- on-line analyses of chemical composition of the flotation feed and tailing, in order to optimise calcite recovery and reagent consumption
- making of saleable by-products from the tailing fines
- recirculation of process water
- high density of tailings slurry to deposit
- seawater used as transport water for slurry tailings
- avoiding air entering the pumping system
- avoiding leaks and spills to sea surface
- utilising a tailings pipe outlet at 20 m below sea level.

Maintenance:

- redundant pumps and piping system to the deposit area
- preventive maintenance of tailing related systems
- regular undersea inspection of tailings pipes
- regular undersea inspection at the pipe outlet area
- evaluation of the necessity to move the tailing pipes.

The advantages, as listed in Section 4.3.1.2.2 are:

- reduction of engineering requirements (no dams are needed)
- increased chemical stability
- reduction of footprint on land.

This technique is applicable where the tailings slurry will form a high density plume that will descend to the bottom of the sea, leaving a clear water area above the pipe outlet.

4.5.4 Other uses of tailings and waste-rock

In some coal operations, fine tailings <0.5 mm from flotation are firstly thickened to 40 – 51 % solids. In order to make them suitable for deposition on heaps with the coarse tailings, further dewatering is carried out in plate-and-frame filter presses (see Section 2.3.1.10) with more than 1000 m² of filter area or centrifuges. The water content of the finest tailings drained centrifuges is approximately twice that arising from plate-and-frame filter presses. [79, DSK, 2002].

Coal tailings (coarse and fine tailings) are also often used as aggregates or for other external purposes [79, DSK, 2002], [84, IGME, 2002]. Some specific examples are listed below:

- earth construction, i.e. as base material for qualified projects in earth construction. Specific fields of application are:
 - dams and embankments for roads, noise protection walls and other earth constructions
 - ground improvement (exchange of soil and mechanical soil amelioration)
 - soil fortification by applying coal tailings and hydraulic binders
 - other earth construction segments (e.g. dykes, landscape modelling, landscaped buildings)
 - liners (e. g. base and surface liners of dumps and landfills as wells as liners of well shafts)
- hydraulic engineering:
 - filling material for abandoned harbour basins
 - dyke construction along rivers
 - extension and safety measures of the German canal system
- landfill construction: tailings mixed with clay are used as base and surface liners as alternative to natural clays
- further applications:
 - applied to a minor extent in the brick industry
 - current development activities are focused on applying coal tailings products in ceramic processes.

The coarse tailings from the Swedish iron ore mines are also suitable for external use.

In limestone operations, the use of tailings as filter sand has been tested and shows good results for very fine material. The limestone tailings remove the fine material of other waste water flows [131, IMA, 2003].

The following different examples are currently applied in the German barytes mining industry:

- use within the mining industry:
 - crushed waste-rock for road construction
 - coarse tailings (< 1 – 16 mm) and waste-rock as backfill material
 - medium fine tailings (< 4 mm) as aggregates in shotcrete mixtures as a replacement for sand
 - dewatered fine tailings (< 1 mm) as backfill.
- use as product outside the mining industry:
 - crushed waste-rock for soil exchange to improve soil conditions under foundations in the construction industry, as aggregates in the construction industry (gravel surface, gravel roads)

- coarse jig tailings (1 – 16 mm) as aggregates in the construction industry (pipeline ditch refill, gravel surface for parking lots, etc.)
- medium fine jig tailings screened (1 – 4 mm) as aggregates for cobbling
- fine tailings (< 1 mm) as filler in the cement industry.

4.6 Mitigation of accidents

4.6.1 Emergency planning

Tailings and/or waste-rock management facilities usually have a documented emergency plan for critical situations and failure scenarios. Actions to meet emergencies are planned together with the competent authorities.

Emergency plans state which actions are to be taken in case of possible or actual failure. This plan covers the organigram of the operator, listing specifically each person's, responsibilities and the interfaces with external organisations. In the emergency plan, a plan for action describing operational measures and resources available to limit consequences, as far as possible, is established and documented.

The aim of the emergency planning is to:

- reduce the risk of failure of the waste facility structures and prevent damage to people or the environment
- reduce the need for improvisation in a crisis or failure situation
- ensure the optimal utilisation of available resources
- identify and pinpoint responsibilities at every level
- make sure that everyone within the organisation, as well as the public and authorities concerned, are provided with the necessary information.

NOTE: In addition, see the objectives of emergency plans as set out in Art. 6(4) of the proposed Directive (COM(2003)319 final) on the management of waste from the extractive industries.

At the preparatory stage all abnormal incidents that could create risk of damage to people, the facility and/or the environment are, as far as possible, identified, evaluated and analysed. The results form the basis for the emergency planning.

See also Section 4.2.1.3 and Article 6 and Annex I in the proposed Directive (COM(2003)319 final) on the management of waste from the extractive industries.

Section 4.4.16 addresses cyanide management issues that aim at the prevention/mitigation of accidents.

4.6.2 Evaluation and follow-up of incidents

To learn something from incidents that have already occurred it is important that there is a system for documenting all information and for follow-up procedures. When an incident occurs it is reported and documented, e.g. what happened and why it happened. At the same time suggestions on how to prevent the same thing from happening again are developed together with the names of the persons responsible for performing the suggested action and a deadline for when the action should be achieved.

Advantages:

- minor as well as major incidents are reported and documented
- if the system is computerised, it is easy to keep track on measures that were/are performed to prevent a recurrence of an incident
- it is easy to see if one type of incident is overrepresented and repeatedly occurring.

Disadvantages:

- a lot of work is necessary to fully develop and put in place a working system.
- [118, Zinkgruvan, 2003]

4.6.3 Tailings pipeline burst

At the **Neves Corvo** operation, the tailings pipelines are equipped with flow-meters at both ends (i.e. at the mineral processing plant and at the discharge end). If the flowrates differ an alarm is activated. Pressure measurements on the tailings pipeline are very difficult to interpret as fluctuations in flow (and thus also in pressure) often occur.

A ditch is dug along the tailings pipeline, which, in the event of a pipeline burst, is designed to lead the spilled slurry to emergency ponds. These ponds are designed so that they can store tailings from 8 hours of production, which equals the maximum total time required to fully shut the flow down.

Where the tailings pipelines cross a river there is a tray under the pipeline, which can catch tailings and forward them to the emergency ponds.'

[142, Borges, 2003]

There are other methods that result in a similar degree of environmental protection, i.e.:

- the use of double tubing instead of trays in sensitive sections
- many sites have one or more back-up pipelines that flow can be directly switched to instead of building large emergency ponds for the entire time period it would take to shut down the plant.

A ditch under the pipeline can result in an increased infiltration of process water and possibly contaminants and can make maintenance of the pipeline more complicated. A ditch or tray could also be difficult to maintain and operate in climates where the ditch becomes filled with water periodically or filled with ice and snow.

4.7 Environmental management tools

Description

The best environmental performance is usually achieved by the installation of the best technology and its operation in the most effective and efficient manner. This is recognised by the definition of 'techniques' as "*both the technology used and the way in which the installation/facility is designed, built, maintained, operated and decommissioned*".

For tailings and waste-rock management facilities an Environmental Management System (EMS) is a tool that operators can use to address these design, construction, maintenance, operation and decommissioning issues in a systematic, demonstrable way. An EMS includes the organisational structure, responsibilities, practices, procedures, processes and resources for developing, implementing, maintaining, reviewing and monitoring the environmental policy.

Environmental Management Systems are most effective and efficient where they form an inherent part of the overall management and operation of an operation/facility.

Within the European Union, many organisations have decided on a voluntary basis to implement environmental management systems based on EN ISO 14001:1996 or the EU Eco-management and audit scheme EMAS. EMAS includes the management system requirements of EN ISO 14001, but places additional emphasis on legal compliance, environmental performance and employee involvement; it also requires external verification of the management system and validation of a public environmental statement (in EN ISO 14001 self-declaration is an alternative to external verification). There are also many organisations that have decided to put in place non-standardised EMSs.

While both standardised systems (EN ISO 14001:1996 and EMAS) and non-standardised ('customised') systems in principle take the *organisation* as the entity, this document takes a more narrow approach, not including all activities of the organisation e.g. with regard to their products and services.

An environmental management system (EMS) can contain the following components:

- (a) definition of an environmental policy
- (b) planning and establishing objectives and targets
- (c) implementation and operation of procedures
- (d) checking and corrective action
- (e) management review
- (f) preparation of a regular environmental statement
- (g) validation by certification body or external EMS verifier
- (h) design considerations for end-of-life plant decommissioning
- (i) development of cleaner technologies
- (j) benchmarking.

These features are explained in somewhat greater detail below. For detailed information on components (a) to (g), which are all included in EMAS, the reader is referred to the reference literature indicated below.

(a) Definition of an environmental policy

Top management are responsible for defining an environmental policy for a facility and ensuring that it:

- is appropriate to the nature, scale and environmental impacts of the activities
- includes a commitment to pollution prevention and control
- includes a commitment to comply with all relevant applicable environmental legislation and regulations, and with other requirements to which the organisation subscribes
- provides the framework for setting and reviewing environmental objectives and targets
- is documented and communicated to all employees
- is available to the public and all interested parties.

(b) Planning, i.e.:

- procedures to identify the environmental aspects of the facility, in order to determine those activities which have or can have significant impacts on the environment, and to keep this information up-to-date
- procedures to identify and have access to legal and other requirements to which the organisation subscribes and that are applicable to the environmental aspects of its activities
- establishing and reviewing documented environmental objectives and targets, taking into consideration the legal and other requirements and the views of interested parties

- establishing and regularly updating an environmental management programme, including designation of responsibility for achieving objectives and targets at each relevant function and level as well as the means and timeframe by which they are to be achieved.

(c) Implementation and operation of procedures

It is important to have systems in place to ensure that procedures are known, understood and complied with, therefore effective environmental management includes:

(i) Structure and responsibility

- defining, documenting and communicating roles, responsibilities and authorities, which includes appointing one specific management representative
- providing resources essential to the implementation and control of the environmental management system, including human resources and specialised skills, technology and financial resources.

(ii) Training, awareness and competence

- identifying training needs to ensure that all personnel whose work may significantly affect the environmental impacts of the activity have received appropriate training.

(iii) Communication

- establishing and maintaining procedures for internal communication between the various levels and functions of the facility, as well as procedures that foster a dialogue with external interested parties and procedures for receiving, documenting and, where reasonable, responding to relevant communication from external interested parties.

(iv) Employee involvement

- involving employees in the process aimed at achieving a high level of environmental performance by applying appropriate forms of participation such as the suggestion-book system or project-based group works or environmental committees.

(v) Documentation

- establishing and maintaining up-to-date information, in paper or electronic form, to describe the core elements of the management system and their interaction and to provide direction to related documentation.

(vi) Efficient process control

- adequate control of processes under all modes of operation, i.e. preparation, start-up, routine operation, shutdown and abnormal conditions
- identifying the key performance indicators and methods for measuring and controlling these parameters (e.g. flow, pressure, temperature, composition and quantity)
- documenting and analysing abnormal operating conditions to identify the root causes and then addressing these to ensure that events do not recur (this can be facilitated by a ‘no-blame’ culture where the identification of causes is more important than apportioning blame to individuals).

(vii) Maintenance programme

- establishing a structured programme for maintenance based on technical descriptions of the equipment, norms etc. as well as any equipment failures and consequences
- supporting the maintenance programme by appropriate record keeping systems and diagnostic testing
- clearly allocating responsibility for the planning and execution of maintenance.

(viii) Emergency preparedness and response

- establishing and maintaining procedures to identify the potential for and response to accidents and emergency situations, and for preventing and mitigating the environmental impacts that may be associated with them.

Checking and corrective action, i.e.:

(i) Monitoring and measurement

- establishing and maintaining documented procedures to monitor and measure, on a regular basis, the key characteristics of operations and activities that can have a significant impact on the environment, including the recording of information for tracking performance, relevant operational controls and conformance with the facility's environmental objectives and targets (*see also the Reference document on Monitoring of Emissions*)
- establishing and maintaining a documented procedure for periodically evaluating compliance with relevant environmental legislation and regulations.

(ii) Corrective and preventive action

- establishing and maintaining procedures for defining responsibility and authority for handling and investigating non-conformance with permit conditions, other legal requirements as well as objectives and targets, taking action to mitigate any impacts caused and for initiating and completing corrective and preventive action that are appropriate to the magnitude of the problem and commensurate with the environmental impact encountered.

(iii) Records

- establishing and maintaining procedures for the identification, maintenance and disposition of legible, identifiable and traceable environmental records, including training records and the results of audits and reviews.

(iv) Audit

- establishing and maintaining (a) programme(s) and procedures for periodic environmental management system audits that include discussions with personnel, inspection of operating conditions and equipment and reviewing of records and documentation and that results in a written report, to be carried out impartially and objectively by employees (internal audits) or external parties (external audits), covering the audit scope, frequency and methodologies, as well as the responsibilities and requirements for conducting audits and reporting results, in order to determine whether or not the environmental management system conforms to planned arrangements and has been properly implemented and maintained
- completing the audit or audit cycle, as appropriate, at intervals of no longer than three years, depending on the nature, scale and complexity of the activities, the significance of associated environmental impacts, the importance and urgency of the problems detected by previous audits and the history of environmental problems – more complex activities with a more significant environmental impact are audited more frequently
- having appropriate mechanisms in place to ensure that the audit results are followed up.

(v) Periodic evaluation of legal compliance

- reviewing compliance with the applicable environmental legislation and the conditions of the environmental permit(s) held by the facility
- documentation of the evaluation.

Management review, i.e.:

- reviewing, by top management, at intervals that it determines, the environmental management system, to ensure its continuing suitability, adequacy and effectiveness
- ensuring that the necessary information is collected to allow management to carry out this evaluation
- documentation of the review.

Preparation of a regular environmental statement:

- preparing an environmental statement that pays particular attention to the results achieved by the facility against its environmental objectives and targets. It is regularly produced – from once a year to less frequently depending on the significance of emissions, waste generation etc. It considers the information needs of relevant interested parties and it is publicly available (e.g. in electronic publications, libraries etc.).

When producing a statement, the operator may use relevant existing environmental performance indicators, making sure that the indicators chosen:

- i. give an accurate appraisal of the facility's performance
- ii. are understandable and unambiguous
- iii. allow for year on year comparison to assess the development of the environmental performance of the facility
- iv. allow for comparison with sector, national or regional benchmarks as appropriate
- v. allow for comparison with regulatory requirements as appropriate.

Validation by certification body or external EMS verifier:

- having the management system, audit procedure and environmental statement examined and validated by an accredited certification body or an external EMS verifier can, if carried out properly, enhance the credibility of the system.

(d) Design considerations for end-of-life plant decommissioning

- giving consideration to the environmental impact from the eventual decommissioning of the unit at the stage of designing a new plant, as forethought makes decommissioning easier, cleaner and cheaper
- decommissioning poses environmental risks for the contamination of land (and groundwater) and generates large quantities of solid waste. Preventive techniques are process-specific but general considerations may include:
 - i. avoiding underground structures
 - ii. incorporating features that facilitate dismantling
 - iii. choosing surface finishes that are easily decontaminated
 - iv. using an equipment configuration that minimises trapped chemicals and facilitates drain-down or washing
 - v. designing flexible, self-contained units that enable phased closure
 - vi. using biodegradable and recyclable materials where possible.

(e) Development of cleaner technologies:

- environmental protection should be an inherent feature of any process design activities carried out by the operator, since techniques incorporated at the earliest possible design stage are both more effective and cheaper. Giving consideration to the development of cleaner technologies can for instance occur through R&D activities or studies. As an alternative to internal activities, arrangements can be made to keep abreast with – and where appropriate – commission work by other operators or research institutes active in the relevant field.

(f) Benchmarking, i.e.:

- carrying out systematic and regular comparisons with sector, national or regional benchmarks, including for energy efficiency and energy conservation activities, choice of input materials, emissions to air and discharges to water (using for example the European Pollutant Emission Register, EPER), consumption of water and generation of waste.

Standardised and non-standardised EMSs

An EMS can take the form of a standardised or non-standardised (“customised”) system. Implementation and adherence to an internationally accepted standardised system such as EN ISO 14001:1996 can give higher credibility to the EMS, especially when subject to a properly performed external verification. EMAS provides additional credibility due to the interaction with the public through the environmental statement and the mechanism to ensure compliance with the applicable environmental legislation. However, non-standardised systems can in principle be equally effective provided that they are properly designed and implemented.

Achieved environmental benefits

Implementation of and adherence to an EMS focuses the attention of the operator on the environmental performance of the facility. In particular, the maintenance of and compliance with clear operating procedures for both normal and abnormal situations and the associated lines of responsibility should ensure that the facility’s permit conditions and other environmental targets and objectives are met at all times.

Environmental management systems typically ensure the continuous improvement of the environmental performance of the facility. The poorer the starting point is, the more significant short-term improvements can be expected. If the facility already has a good overall environmental performance, the system helps the operator to maintain the high performance level.

Cross-media effects

Environmental management techniques are designed to address the overall environmental impact.

Operational data

No specific information reported.

Applicability

The components described above can typically be applied to all facilities. The scope (e.g. level of detail) and nature of the EMS (e.g. standardised or non-standardised) will generally be related to the nature, scale and complexity of the facility, and the range of environmental impacts it may have.

Economics

It is difficult to accurately determine the costs and economic benefits of introducing and maintaining a good EMS. A number of studies are presented below. However, these are just examples and their results are not entirely coherent. They might not be representative for all sectors across the EU and should thus be treated with caution.

A Swedish study carried out in 1999 surveyed all 360 ISO-certified and EMAS-registered companies in Sweden. With a response rate of 50%, it concluded among other things that:

- the expenses for introducing and operating EMS are high but not unreasonably so, save in the case of very small companies. Expenses are expected to decrease in the future
- a higher degree of co-ordination and integration of EMS with other management systems is seen as a possible way to decrease costs
- half of all the environmental objectives and targets give payback within one year through cost savings and/or increased revenue
- the largest cost savings were made through decreased expenditure on energy, waste treatment and raw materials
- most of the companies think that their position on the market has been strengthened through the EMS. One-third of the companies report increasing revenue due to EMS.

In some Member States reduced supervision fees are charged if the facility has a certification.

A number of studies¹⁶ show that there is an inverse relationship between company size and the cost of implementing an EMS. A similar inverse relationship exists for the payback period of invested capital. Both elements imply a less favourable cost-benefit relationship for implementing an EMS in SMEs compared to larger companies.

According to a Swiss study, the average cost for building and operating ISO 14001 can vary:

- for a company with between 1 and 49 employees: CHF 64000 (EUR 44000) for building the EMS and CHF 16000 (EUR 11000) per year for operating it
- for an industrial site with more than 250 employees: CHF 367000 (EUR 252000) for building the EMS and CHF 155000 (EUR 106000) per year for operating it.

These average figures do not necessarily represent the actual cost for a given industrial site because this cost is also highly dependent on the number of significant items (pollutants, energy consumption,...) and on the complexity of the problems to be studied.

A recent German study (Schaltegger, Stefan and Wagner, Marcus, *Umweltmanagement in deutschen Unternehmen - der aktuelle Stand der Praxis*, February 2002, p. 106) shows the following costs for EMAS for different branches. It can be noted that these figures are much lower than those of the Swiss study quoted above. This is a confirmation of the difficulty to determine the costs of an EMS.

Costs for building (EUR):

minimum - 18750
maximum - 75000
average - 50000

Costs for validation (EUR):

minimum - 5000
maximum - 12500
average - 6000

¹⁶ E.g. Dyllick and Hamschmidt (2000, 73) quoted in Klemisch H. and R. Holger, *Umweltmanagementsysteme in kleinen und mittleren Unternehmen – Befunde bisheriger Umsetzung*, KNI Papers 01/02, January 2002, p 15; Clausen J., M. Keil and M. Jungwirth, *The State of EMAS in the EU. Eco-Management as a Tool for Sustainable Development – Literature Study*, Institute for Ecological Economy Research (Berlin) and Ecologic – Institute for International and European Environmental Policy (Berlin), 2002, p 15.

A study by the German Institute of Entrepreneurs (Unternehmerinstitut/Arbeitsgemeinschaft Selbständiger Unternehmer UNI/ASU, 1997, *Umweltmanagementbefragung - Öko-Audit in der mittelständischen Praxis - Evaluierung und Ansätze für eine Effizienzsteigerung von Umweltmanagementsystemen in der Praxis*, Bonn.) gives information about the average savings achieved for EMAS per year and the average payback time. For example, for implementation costs of EUR 80000 they found average savings of EUR 50000 per year, corresponding to a payback time of about one and a half years.

External costs relating to verification of the system can be estimated from guidance issued by the International Accreditation Forum (<http://www.iaf.nu>).

Driving forces for implementation

Environmental management systems can provide a number of advantages, for example:

- improved insight into the environmental aspects of the company
- improved basis for decision-making
- improved motivation of personnel
- additional opportunities for operational cost reduction and product quality improvement
- improved environmental performance
- improved company image
- reduced liability, insurance and non-compliance costs
- increased attractiveness for employees, customers and investors
- increased trust of regulators, which could lead to reduced regulatory oversight
- improved relationship with environmental groups.

Example plants

The features described under (a) to (e) above are elements of EN ISO 14001:1996 and the European Community Eco-Management and Audit Scheme (EMAS), whereas the features (f) and (g) are specific to EMAS. These two standardised systems are applied in a number of IPPC installations. As an example, 357 organisations within the EU chemical and chemical products industry (NACE code 24) were EMAS registered in July 2002, most of which operate IPPC installations.

In the UK, the Environment Agency of England and Wales carried out a survey among IPC (the precursor to IPPC) regulated installations in 2001. It showed that 32% of respondents were certified to ISO 14001 (corresponding to 21% of all IPC installations) and 7% were EMAS registered. All cement works in the UK (around 20) are certified to ISO 14001 and the majority are EMAS registered. In Ireland, where the establishment of an EMS (not necessarily of a standardised nature) is required in IPC licenses, an estimated 100 out of approximately 500 licensed installations have established an EMS according to ISO 14001, with the other 400 installations having opted for a non-standardised EMS.

The following list gives some examples of environmental management systems applied in Europe:

- all Kaolin operations in the UK and the Lisheen mine in Ireland have an ISO 14001 certification
- all permits in Ireland require some sort of EMS
- the Global Mining Initiative and the associated Minerals Mining & Sustainable Development forums advocate EMS
- S&B Industrial Minerals S.A mines in Greece have an ISO 14001 certification, Stratoni Mines owned by TVX Hellas was certified with ISO 14001.

Reference literature

(Regulation (EC) No 761/2001 of the European parliament and of the council allowing voluntary participation by organisations in a Community eco-management and audit scheme (EMAS), OJ L 114, 24/4/2001, http://europa.eu.int/comm/environment/emas/index_en.htm)

(EN ISO 14001:1996, <http://www.iso.ch/iso/en/iso9000-14000/iso14000/iso14000index.html>;
<http://www.tc207.org>)

5 BEST AVAILABLE TECHNIQUES FOR THE MANAGEMENT OF TAILINGS AND WASTE-ROCK IN MINING ACTIVITIES

5.1 Introduction

In understanding this chapter and its contents, the attention of the reader is drawn back to the preface of this document and in particular the fifth section of the preface: “How to understand and use this document”. The techniques and performance levels presented in this chapter have been assessed through an iterative process involving the following steps:

- identification of the key environmental and risk/safety issues for the sector
- examination of the techniques most relevant to address those key issues
- identification of the best environmental performance, on the basis of the available data in the European Union and worldwide
- examination of the conditions under which these performances were achieved; such as costs, cross-media effects, main driving forces involved in implementation of this techniques
- selection of the best available techniques (BAT) for this sector in a general sense.

Expert judgement by the European IPPC Bureau and the Technical Working Group (TWG) has played a key role in each of these steps and in the way in which the information is presented here.

On the basis of this assessment, techniques are presented in this chapter that are considered to be appropriate to the sector as a whole and in many cases reflect current performance of some sites within the sector. Where performance levels are presented, this is to be understood as meaning that those levels represent the environmental and safety performance that could be anticipated as a result of the application, in this sector, of the techniques described, bearing in mind the balance of costs and advantages inherent within the definition of BAT. In some cases it may be technically possible to achieve better emission or consumption levels but due to the costs involved or cross-media considerations, they are not considered to be appropriate as BAT for the sector as a whole. However, such levels may be considered to be justified in more specific cases where there are special driving forces.

The emission and consumption levels associated with the use of BAT have to be seen together with any specified reference conditions (e.g. averaging periods).

Where available, data concerning costs have been given together with the description of the techniques presented in the previous chapter. These give a rough indication about the magnitude of costs involved. However, the actual cost of applying a technique will depend strongly on the specific situation regarding, for example, taxes, fees, and the technical characteristics of the site concerned. It is not possible to evaluate such site-specific factors fully in this document. In the absence of data concerning costs, conclusions on economic viability of techniques are drawn from observations on existing sites.

It is intended that the general BAT in this chapter are a reference point against which to judge the current performance of an existing installation or to judge a proposal for a new installation. In this way they will assist in the determination of appropriate "BAT-based" conditions for the installation. It is foreseen that new installations can be designed to perform at or even better than the general BAT performances presented here. It is also considered that existing installations could move towards the general BAT levels or do better, subject to the technical and economic applicability of the techniques in each case.

In any case there is a need for site-specific solutions for the design, construction, operational, closure and after-care phases, as well as a permanent control and monitoring of tailings and waste-rock management due to the very different types of mineralisations, mining and mineral processing techniques available, and the different geological, geotechnical, hydrogeological and morphological conditions that occur on a case-by-case and site-by-site basis.

While this document does not set legally binding standards, it is meant to give information for the guidance of industry, Member States and the public on achievable performances, emissions, and consumption levels when using specified techniques.

For tailings and waste-rock management, BAT decisions are based on:

- environmental performance
- risk
- economic viability.

In particular, the consideration of risk is a very site-specific factor.

5.2 Generic

BAT is to:

- apply the general principles set out in Section 4.1
- apply a life cycle management approach as described in Section 4.2.

Life cycle management covers all the phases of a site's life, including:

- the design phase (Section 4.2.1):
 - environmental baseline (Section 4.2.1.1)
 - characterisation of tailings and waste-rock (Section 4.2.1.2)
 - TMF studies and plans (Section 4.2.1.3), which cover the following aspects:
 - site selection documentation
 - environmental impact assessment
 - risk assessment
 - emergency preparedness plan
 - deposition plan
 - water balance and management plan, and
 - decommissioning and closure plan
 - TMF and associated structures design (Section 4.2.1.4)
 - control and monitoring (Section 4.2.1.5)
- the construction phase (Section 4.2.2)
- the operational phase (Section 4.2.3), with the elements:
 - OSM manuals (Section 4.2.3.1)
 - auditing (Section 4.2.3.2)
- the closure and after-care phase (Section 4.2.4), with the elements:
 - long-term closure objectives (Section 4.2.4.1)
 - specific closure issues (Section 4.2.4.2) for
 - heaps
 - ponds, including:
 - water covered ponds
 - dewatered ponds
 - water management facilities.

Furthermore, BAT is to:

- reduce reagent consumption (Section 4.3.2)
- prevent water erosion (Section 4.3.3)
- prevent dusting (Section 4.3.4)
- carry out a water balance (Section 4.3.7) and to use the results to develop a water management plan (Section 4.2.1.3)
- apply free water management (Section 4.3.9)
- monitor groundwater around all tailings and waste-rock areas (Section 4.3.12).

ARD management

The characterisation of tailings and waste-rock (Section 4.2.1.2 in combination with Annex 4) includes the determination of the acid-forming potential of tailings and/or waste-rock. If an acid-forming potential exists, it is BAT to firstly prevent the generation of ARD (Section 4.3.1.2), and if the generation of ARD cannot be prevented, to control ARD impact (Section 4.3.1.3) or to apply treatment options (Section 4.3.1.4). Often a combination is used (Section 4.3.1.6).

All prevention, control and treatment options can be applied to existing and new installations. However, the best closure results will be obtained when plans are developed for the site closure right at the outset (design stage) of the operation (cradle-to-grave philosophy).

The applicability of the options depends mainly on the conditions present at the site. Factors such as:

- water balance
- availability of possible cover material
- groundwater level

influence the options applicable at a given site. Section 4.3.1.5 provides a tool for deciding on the most suitable closure option.

Seepage management (Section 4.3.10)

Preferably the location of a tailings or waste-rock management facility will be chosen in a way that a liner is not necessary. However, if this is not possible and the seepage quality is detrimental and/or the seepage flowrate is high, then seepage needs to be prevented, reduced (Section 4.3.10.1) or controlled (Section 4.3.10.2) (listed in order of preference). Often a combination of these measures is applied.

Emissions to water

BAT is to:

- re-use process water (see Section 4.3.11.1)
- mix process water with other effluents containing dissolved metals (see Section 4.3.11.3)
- install sedimentation ponds to capture eroded fines (see Section 4.3.11.4.1)
- remove suspended solids and dissolved metals prior to discharge of the effluent to receiving watercourses (Section 4.3.11.4)
- neutralise alkaline effluents with sulphuric acid or carbon dioxide (Section 4.3.11.6)
- remove arsenic from mining effluents by the addition of ferric salts (Section 4.3.11.7).

The respective sections in Chapter 3 on emissions and consumption levels provide examples of the achieved levels. No correlation could be developed between the applied techniques and the available emission data. Therefore, in this document it was not possible to draw BAT conclusions with associated emission levels.

The following techniques are BAT for treating acidic effluents (Section 4.3.11.5):

- active treatments:
 - addition of limestone (calcium carbonate), hydrated lime or quicklime
 - addition of caustic soda for ARD with a high manganese content
- passive treatment:
 - constructed wetlands
 - open limestone channels/anoxic limestone drains
 - diversion wells.

Passive treatment systems are a long-term solution after the decommissioning of a site, but only when used as a polishing step combined with other (preventive) measures.

Noise emissions (Section 4.3.5)

BAT is to:

- use continuous working systems (e.g. conveyor belts, pipelines)
- encapsulate belt drives in areas where noise is a local issue
- first create the outer slope of a heap, and then transfer ramps and working benches into the heap's inner area as far as possible.

Dam design

In addition to the measures described in Section 4.1 and Section 4.2, during the **design** phase (Section 4.2.1) of a **tailings dam**, BAT is to:

- use the once in a 100-year flood as the design flood for the sizing of the emergency discharge capacity of a low hazard dam
- use the once in a 5000 – 10000-year flood as the design flood for the sizing of the emergency discharge capacity of a high hazard dam.

Dam construction

In addition to the measures described in Section 4.1 and Section 4.2, during the **construction** phase (Section 4.2.2) of a **tailings dam**, BAT is to:

- strip the natural ground below the retaining dam of all vegetation and huminous soils (Section 4.4.3)
- choose a dam construction material that is fit for the purpose and which will not weaken under operational or climatic conditions (Section 4.4.4).

Raising dams

In addition to the measures in Section 4.1 and Section 4.2, during the **constructional** and **operational** phases (Sections 4.2.2 and 4.2.3) of a **tailings dam**, BAT is to:

- evaluate the risk of a too high pore pressure and monitor the pore pressure before and during each raise. The evaluation should be done by an independent expert.
- use conventional type dams (Section 4.4.6.1), under the following conditions, when:
 - the tailings are not suitable for dam construction
 - the impoundment is required for the storage of water
 - the tailings management site is in a remote and inaccessible location
 - retention of the tailings water is needed over an extended period for the degradation of a toxic element (e.g. cyanide)
 - the natural inflow into the impoundment is large or subject to high variations and water storage is needed for its control
- use the upstream method of construction (Section 4.4.6.2), under the following conditions, when:
 - there is very low seismic risk

- tailings are used for the construction of the dam: at least 40 – 60 % material with a particle size between 0.075 and 4 mm in whole tailings (does not apply for thickened tailings)
- use the downstream method of construction (Section 4.4.6.3), under the following conditions, when:
 - sufficient amounts of dam construction material are available (e.g. tailings or waste-rock)
- use the centreline method of construction (Section 4.4.6.4), under the following conditions, when:
 - the seismic risk is low.

Dam operation

In addition to the measures described in Section 4.1 and Section 4.2, during the **operational phase** (Section 4.2.3) of a **tailings pond**, BAT is to:

- monitor stability as further specified below
- provide for diversion of any discharge into the pond away from the pond in the event of difficulties
- provide alternative discharge facilities, possibly into another impoundment
- provide second decant facilities (e.g. emergency overflow, Section 4.4.9) and/or standby pump barges for emergencies, if the level of the free water in the pond reaches the pre-determined minimum freeboard (Section 4.4.8)
- measure ground movements with deep inclinometers and have a knowledge of the pore pressure conditions
- provide adequate drainage (Section 4.4.10)
- maintain records of design and construction and any updates/changes in the design/construction
- maintain a dam safety manual as described in Section 4.2.3.1 in combination with independent audits as mentioned in Section 4.2.3.2
- educate and provide adequate training for staff.

Removal of free water from the pond (Section 4.4.7.1)

BAT is to:

- use a spillway in natural ground for valley site and off valley site ponds
- use a decant tower:
 - in cold climates with a positive water balance
 - for paddock-style ponds
- use a decant well:
 - in warm climates with a negative water balance
 - for paddock-style ponds
 - if a high operating freeboard is maintained.

Dewatering of tailings (Section 4.4.16)

The choice of method (slurried, thickened or dry tailings) depends mainly on an evaluation of three factors, namely:

- cost
- environmental performance
- risk of failure.

For tailings management, BAT is to apply:

- dry tailings management (Section 4.4.16.1)
- thickened tailings management (Section 4.4.16.2) or
- slurried tailings management (Section 4.4.16.3).

There are many other factors that influence the choice of the appropriate techniques for a given site. Some of these factors are:

- mineralogy of the ore
- ore value
- particle size distribution
- availability of process water
- climatic conditions
- available space of tailings management.

Tailings and waste-rock management facility operation

In addition to the measures described in Section 4.1 and Section 4.2, during the **operational phase** (Section 4.2.3) of **any tailings and waste-rock management facility**, BAT is to:

- divert natural external run-off (Section 4.4.1)
- manage tailings or waste-rock in pits (Section 4.4.1). In this case heap/dam slope stability is not an issue
- apply a safety factor of at least 1.3 to all heaps and dams during operation (Section 4.4.13.1)
- carry out progressive restoration/revegetation (Section 4.3.6).

Monitoring stability

BAT is to:

- monitor in a tailings pond/dam (Section 4.4.14.2):
 - the water level
 - the quality and quantity of seepage flow through the dam (also Section 4.4.12)
 - the position of the phreatic surface
 - pore pressure
 - movement of dam crest and tailings
 - seismicity, to ensure stability of the dam and the supporting strata (also Section 4.4.14.4)
 - dynamic pore pressure and liquefaction
 - soil mechanics
 - tailings placement procedures
- monitor in a heap (Section 4.4.14.2):
 - bench/slope geometry
 - sub-tip drainage
 - pore pressure
- also carry out:
 - in the case of a tailings pond/dam:
 - visual inspections (Section 4.4.14.3)
 - annual reviews (Section 4.4.14.3)
 - independent audits (Section 4.2.3.2 and Section 4.4.14.3)
 - safety evaluations of existing dams (SEED) (Section 4.4.14.3)
 - in the case of a heap:
 - visual inspections (Section 4.4.14.3)
 - geotechnical reviews (Section 4.4.14.3)
 - independent geotechnical audits (Section 4.4.14.3).

Mitigation of accidents

BAT is to:

- carried out emergency planning (Section 4.6.1)
- evaluate and follow-up incidents (Section 4.6.2)
- monitor the pipelines (Section 4.6.3).

Reduction of footprint

BAT is to:

- if possible, prevent and/or reduce the generation of tailings/waste-rock (Section 4.1)
- backfill tailings (Section 4.5.1), under the following conditions, when:
 - backfill is required as part of the mining method (Section 4.5.1.1)
 - the additional cost for backfilling is at least compensated for by the higher ore recovery
 - in open pit mining, if the tailings easily dewater (i.e. evaporation and drainage, filtration) and thereby a TMF can be avoided or reduced in size (Sections 4.5.1.2, 4.5.1.3, 4.5.1.4, 4.4.1)
 - use nearby mined-out open pits is available for backfilling (Section 4.5.1.5)
 - backfill large stopes in underground mines (Section 4.5.1.6). Stopes backfilled with slurried tailings will require drainage (Section 4.5.1.9). Binders may also need to be added to increase the stability (Section 4.5.1.8)
- backfill tailings in the form of paste fill (Section 4.5.1.10), if the conditions to apply backfill are met and if:
 - there is a need for a competent backfill
 - the tailings are very fine, so that little material would be available for hydraulic backfill. In this case, the large amount of fines sent to the pond would dewater very slowly
 - it is desirable to keep water out of the mine or where it is costly to pump the water draining from the tailings (i.e. over a large distance)
- backfill waste-rock, under the following conditions (Section 4.5.2), when:
 - it can be backfilled within an underground mine
 - one or more mined-out open pits are nearby (this is sometimes referred to as ‘transfer mining’)
 - the open pit operation is carried out in such a way that it is possible to backfill the waste-rock without inhibiting the mining operation
- investigate possible uses of tailings and waste-rock (Section 4.5.3).

Closure and after-care

In addition to the measures described in Section 4.1 and Section 4.2, during the **closure and after-care phase** (Section 4.2.4) of **any tailings and waste-rock management facility**, BAT is to:

- develop closure and after-care plans during the planning phase of an operation, including cost estimates, and then to update them over time (Section 4.2.4). However, the requirements for rehabilitation develop throughout the lifetime of an operation and can first be considered in precise detail in the closure phase of a TMF
- apply a safety factor of at least 1.3 for dams and heaps after closure (Section 4.2.4 and 4.4.13.1), although a split view concerning water covers exists (see Chapter 7).

For the closure and after-care phase of tailings ponds, BAT is to construct the dams so that they stay stable in the long term if a water cover solution is chosen for the closure (Section 4.2.4.2).

5.3 Gold leaching using cyanide

In addition to the generic measures in Section 5.2, for all sites applying gold leaching using cyanide, BAT is to do the following:

- reduce the use of CN, by applying:
 - operational strategies to minimise cyanide addition (Section 4.3.2.2)
 - automatic cyanide control (Section 4.3.2.2.1)
 - if applicable, peroxide pretreatment (Section 4.3.2.2.2)
- destroy the remaining free CN prior to discharge in the pond (Section 4.3.11.8). Table 4.13 shows examples of CN levels achieved at some European sites
- apply the following safety measures (Section 4.4.15):
 - size the cyanide destruction circuit with a capacity twice the actual requirement
 - install a backup system for lime addition
 - install backup power generators.

5.4 Aluminium

In addition to the generic measures in Section 5.2 for all alumina refineries, BAT is to do the following:

- during operation:
 - avoid discharging effluents into surface waters. This is achieved by re-using process water in the refinery (Section 4.3.11.1 or, in dry climates, by evaporation)
- in the after-care phase (Section 4.3.13.1):
 - treat the surface run-off from TMFs prior to discharge, until the chemical conditions have reached acceptable concentrations for discharge into surface waters
 - maintain access roads, drainage systems and the vegetative cover (including re-vegetation if necessary)
 - continue groundwater quality sampling.

5.5 Potash

In addition to the generic measures in Section 5.2 for all potash sites, BAT is to do the following:

- if the natural soil is not impermeable, make the ground under the TMF impermeable (Section 4.3.10.3)
- reduce dust emissions from conveyor belt transport (Section 4.3.4.3.1)
- seal/line the toe of the heaps outside the impermeable core zone and collect the run-off (Section 4.3.11.4.1)
- backfill large stopes with dry and/or slurried tailings (Section 4.5.1.6).

5.6 Coal

In addition to the generic measures in Section 5.2 for all coal sites, BAT is to do the following:

- prevent seepage (Section 4.3.10.4)
- dewater fine tailings <0.5 mm from flotation (Section 4.4.16.3).

5.7 Environmental management

A number of environmental management techniques are determined as BAT. The scope (e.g. level of detail) and nature of the EMS (e.g. standardised or non-standardised) will generally be related to the nature, scale and complexity of the installation, and the range of environmental impacts it may have.

BAT is to implement and adhere to an Environmental Management System (EMS) that incorporates, as appropriate to individual circumstances, the following features: (see Chapter 4)

- definition of an environmental policy for the installation by top management (commitment of the top management is regarded as a precondition for a successful application of other features of the EMS)
- planning and establishing the necessary procedures
- implementation of the procedures, paying particular attention to
 - structure and responsibility
 - training, awareness and competence
 - communication
 - employee involvement
 - documentation
 - efficient process control
 - maintenance programme
 - emergency preparedness and response
 - safeguarding compliance with environmental legislation
- checking performance and taking corrective action, paying particular attention to
 - monitoring and measurement (see also the Reference document on Monitoring of Emissions)
 - corrective and preventive action
 - maintenance of records
 - independent (where practicable) internal auditing in order to determine whether or not the environmental management system conforms to planned arrangements and has been properly implemented and maintained
- review by top management.

Three further features, which can complement the above stepwise, are considered as supporting measures. However, their absence is generally not inconsistent with BAT. These three additional steps are:

- having the management system and audit procedure examined and validated by an accredited certification body or an external EMS verifier
- preparation and publication (and possibly external validation) of a regular environmental statement describing all the significant environmental aspects of the installation, allowing for year-by-year comparison against environmental objectives and targets as well as with sector benchmarks as appropriate
- implementation and adherence to an internationally accepted voluntary system such as EMAS and EN ISO 14001:1996. This voluntary step could give higher credibility to the EMS. In particular EMAS, which embodies all the above-mentioned features, gives higher credibility. However, non-standardised systems can in principle be equally effective provided that they are properly designed and implemented

Specifically for the management of tailings and waste-rock, BAT is to apply an integrated risk/safety and environmental management system. Therefore environmental management has to be developed and carried out jointly with the risk assessment/management described in Section 4.2.1 and the operation, supervision and maintenance management described in Section 4.2.3.1.

6 EMERGING TECHNIQUES FOR THE MANAGEMENT OF TAILINGS AND WASTE-ROCK IN MINING ACTIVITIES

6.1 Co-disposal of iron ore tailings and waste-rock

The operator of the Swedish iron ore operations at Kiruna and Malmberget has, for several years, worked on the development of alternative methods of transporting and depositing their so-called 'waste-rock' (dry coarse tailings <100 mm) and tailings from concentrating operations (fine tailings <3 mm). The objectives of this research have primarily been to bring down the significant investment and operation costs of trucking (currently used for waste-rock) and of dam constructions (currently used for the fine tailings).

A major test has been conducted, where a mixture of dry tailings and wet tailings was pumped with heavy duty slurry pumps. The tests and site-specific evaluation showed that the operation was not competitive with traditional transportation techniques, mainly due to wear in pumps and pipelines. The resulting co-disposal, however, showed that the slurry stream formed a rounded moraine-like formation, similar to those created by melting ice during the withdrawal of the glacial ice. The density of the deposited material was found to be higher than that of conventionally placed material, i. e. the use of available volume is more efficient. In addition, it was concluded that if measures are taken in order to control the groundwater level in the deposit, stable and high deposits may be created with this disposal method.

The promising properties of the co-deposited waste-rock and tailings have encouraged research into ways to achieve the advantages of co-disposal combined with traditional transportation techniques. One operator has developed the concept of drained-cell disposal and has carried out laboratory, pilot-scale and full-scale tests to develop applicable design criteria, to evaluate the operational, hydraulic and geotechnical aspects and to investigate the influence of cold climate on the stability of the deposit.

The drained-cell disposal is now evaluated in pre-studies in the Malmberget and in Kiruna mine sites.

In Italy, the technique to build up tips in layers of different permeabilities was successfully used for the disposal of the overburden material in the S.Barbara (Arezzo - Tuscany) coal mine facilities. The high permeability layers can drain water off, so that the time required for pore pressure dissipation in the low permeability layers is dramatically reduced. This technique improved the short-term stability of the tips, providing sufficient safety for an acceptable building velocity.

6.2 Inhibiting progress of ARD

Artificial coatings have been found to form an impermeable and protective coating on sulphide surfaces, inhibiting the progress of acid rock drainage (ARD). This research programme intends to review the feasibility of the process of forming oxidation-protecting coatings on sulphides using reagents or electrolytic processes. This protective layer must be consistent in order to minimise access of one of the ingredients that generate ARD. The focus of the research will be on obtaining coating layers that resist the ageing process. Electrolytic studies will also be conducted in order to oxidise the surface of exposed sulphides in waste-rocks or tailing dams thereby creating a passivation layer.

(from <http://www.mining.ubc.ca> - Study of formation of passivation coatings on sulphide-rich waste-rock: a way to hinder ARD propagation).

6.3 Recycling of cyanide using membrane technology

The recycling of cyanide using membrane technology, which is currently under development, is planned to be applied to the gold metallurgical extraction process, where the efficacy of cyanide use is hindered due to the presence of copper (and similar metals such as zinc and silver). The presence of these metals causes an increase in the consumption of cyanide, a lowering of the gold recovery efficiency and also poses a heightened environmental management issue for the tailings.

The technique is an hybrid of the membrane and electrowinning technologies, which allow for the recovery of metallic copper and the simultaneous liberation of free cyanide from the copper-cyanide complexes. The free cyanide may then be recovered and returned to the front end of the milling process with beneficial savings. The process may be installed in the tailings circuit prior to discharge to the tailings pond or in the returned water circuit recovered from the tailings dam.

The component technologies of the process are well tried and tested in industry. Initial cost estimates show that the process is potentially very attractive compared to alternative approaches such as resin exchanges processes, precipitation and acidification processes.

The basic flow diagram for this process consists of three parts:

1. a solids removal step to provide a clean liquor for subsequent processing
2. a membrane step that concentrates the copper-cyanide complexes. This step also recovers a portion of the free cyanide
3. a metal recovery unit (MRU) that deposits the copper electrolytically, thereby liberating a portion of the WAD-cyanide as free cyanide.

This technique is planned to be applied to any process stream that contains free cyanide and/or cyanide complexed with copper or similar (weak acid dissociable, or WAD-cyanide). This may be either the tailings stream prior to the tailings dam or in the recovered water from the tailings dam.

This technique for recovering cyanide from gold tailings can be easily retrofitted to existing gold plants. The feed for the process is either the tailings liquor or the tailings return. This process provides a number of process benefits. Consumption of reagents is low compared to processes for the destruction of cyanide. Cyanide that would otherwise be lost to the circuit is able to be recovered from the tailings and re-used, reducing the cyanide inventory on site, and also the costs of purchasing the cyanide and the cyanide destruction. Copper metal is recovered as a by-product.

There are no limitations on the treatable cyanide WAD concentrations, although the efficiency of the process is dependent on the chemistry of the tailings stream.

There are also obvious environmental benefits. The amount of cyanide and copper in the tailings stream is reduced significantly prior to cyanide destruction or disposal of the waste to tailings storage facilities. This results in reduced environmental risk to wildlife and waterways. Recovery of cyanide reduces the amount of make-up cyanide purchased, stored and handled on site.

6.4 Lined cells

At the **Las Cruces Project**, the proposed deposition method of the tailings is dry deposition in impermeable cells. It is proposed that the cells are constructed as blocks of 100 x 100 m with a height of 25 m. The deposited tailings are proposed to be continuously covered by clay. The final encapsulation will be done using a multi-layer cover, utilising the clay (marl) extracted in the uncovering of the orebody. The cells are proposed to be constructed with an impermeable base, constructed by various layers of clay, maybe supported by a synthetic liner and drainage layers. A system for the capturing of drainage will be installed and the drainage treated for re-use in the process or discharge.

[67, IGME, 2002]

6.5 Utilisation of treated red mud to remediate problems of ARD and metals pollution

A technology has been developed whereby the process residue (i.e. the 'red mud') from alumina refineries is subjected to a proprietary treatment forming a material which possesses residual alkalinity and a capability to trap metal ions. This capacity is based on the complex quantity of minerals present in the material (such as haematite, boehmite, gibbsite, sodalite, quartz, cancrinite, and many others). This material can be used to treat acid and metals contamination of soils and water.

The material has been used at commercial scale for treating 1.5 Mm³ of tailings water at the Mt. Carrington mine, Australia. The water had a significant metal load (Al, As, Cd, Cu, Fe, Pb, Mn, Ni, Zn) and after the treatment the metal removal from the water was found to vary from a minimum of 90 to 99.9 %. It has been also found that the bound metals can neither be taken up by vegetation nor be released by leaching.

The possible applications identified so far, are the following:

- neutralisation and decontamination of ARD water
- neutralisation of tailings and waste-rock with an ARD potential
- control of acid or metal-rich spills by means of filtering barriers
- removal of phosphate from water
- removal of arsenic and other metals from groundwater.

The material can be used either as a dry powder, or as slurry. The fine particles can then be easily decanted in the bottom of a calm area, such as in a basin, and periodically be collected and taken away. The sediment has a high specific gravity and it can remain in the basin bottom for long periods of time, without creating any problems. The trapped metals are locked in a stable form as demonstrated by leaching tests. The exhausted material can then be disposed of in a landfill or can also be left in place, as a bottom layer in the basin, as a further protection of the groundwater against metals contamination. The material can also be used in a porous pelletised form and in a sand filter arrangement.

6.6 Combination of SO₂/air and hydrogen peroxide technique to destroy cyanide

One technique currently being developed which uses the synergies between the SO₂/air process (applicable to slurries) and the hydrogen peroxide technique (not applicable to slurries) for the destruction of cyanide. The benefit of this new technique is its flexibility to accommodate changes in feed chemistry. Depending on site-specific conditions, the process offers capital and operating savings over traditional SO₂/air plants.

7 CONCLUDING REMARKS

Timing of the work

The first plenary meeting of the TWG took place in June 2001. The first draft of the document was then sent out to the Technical Working Group (TWG) for consultation in September 2002. The comments were assessed and integrated into the document and a second draft, including proposals for BAT conclusions, was sent out in May 2003. The final plenary meeting on the TWG was organised in November 2003. After the meeting there was a short consultation on the concluding remarks and executive summary chapters before the final version of the document was produced.

Sources of information

Many documents were provided by industry and authorities as a basis for the information to be included in this document. Bulletins from the 'International Commission on Large Dams' (ICOLD) concerning tailings management, the Canadian 'Guide to the management of tailings facilities' document and the Finnish 'Dam safety code of practice' may be considered as cornerstone documents for this BAT document. Valuable information on specific operations and the techniques applied were provided by the metal, industrial minerals and coal mining industries. These were supplemented by information provided by Ireland, Sweden, Spain, Portugal, Finland, Greece, Italy, Austria and Germany. Site visits were carried out in Ireland, Germany, Austria, Spain, Sweden, Turkey and Poland. The consultation rounds on each draft document provided specific feedback from operators, remarks on applicability and implementation of some techniques and additional operational and cost data. Throughout the project, special attention was given to the involvement of the new Accession Countries that have important mining activities. This resulted in the active participation of Poland, the Czech Republic and Hungary.

In order to promote the exchange of information, workshops were organised in Sweden, Ireland, Poland and Bulgaria. Furthermore subgroup meetings were held in Austria and, repeatedly throughout the process, in Brussels. All these events provided additional operational data and useful technical information.

Gaps and weaknesses

At the kick-off meeting it was decided to include information on the management of tailings and waste-rock from oil-shale mining in Estonia. Unfortunately no relevant information was provided on this subject.

Initially most contributions focused on mineral processing and the general management of tailings and waste-rock. Requests for further detailed information did mostly provide the desired degree of detail for the techniques applied, but the time delay in incorporating the requests resulted in a delay in the compilation and distribution of the first draft.

The amount and quality of the data in this document show an imbalance, in that little information was provided on actual consumption and emission levels of industrial minerals tailings and waste-rock management facilities.

Emission data for metal operations is based on single facilities. No correlation could be developed between the applied techniques and the available emission data. Therefore BAT conclusions with an associated emissions level were not possible.

Very little information was provided by the TWG on the mitigation of accidents.

Degree of consensus reached

The conclusions of the work were agreed at the final plenary meeting in November 2003, with a high level of consensus being achieved.

The main issues for discussion at the final meeting concerned:

- the amounts of tailings and waste-rock generated
- BAT associated emission levels for effluent treatment and for cyanide destruction
- methods for covering tailings ponds upon closure
- safety factors for heaps and dams
- the monitoring of dams and heaps
- methods for dewatering tailings slurries
- methods for constructing and raising tailings dams.

The TWG was not able to provide information on the amounts of tailings and waste-rock generated by mining activities. Therefore only general data from the yearly Eurostat report was included in Chapter 1.

For effluent treatment and cyanide destruction, as mentioned above regarding gold leaching operations, the TWG could not agree on BAT associated emission levels for the CN concentration in the discharge to the tailings pond. The TWG found the provisions in the proposed Directive on the management of waste from the extractive industries¹⁷ to be adequate on this issue. Under Article 13(4) the Directive currently demands a value of 10 ppm WAD_{CN} within 10 years of the transposition of the Directive.

It was decided in the final plenary meeting that both the 'dry' cover technique and 'wet' cover technique are both methods that allow the prevention of ARD generation when closing a tailings pond. Additional data and text was provided by Sweden to support this argument. Hence both techniques are considered BAT for the prevention of ARD.

The TWG agreed on a general safety factor for dams and heaps during operation and upon closure of 1.3 as BAT. However there was a split view concerning the safety factor for long-term stable dams having a water cover or 'wet cover'. One Member State and some industry working group members proposed a value of at least 1.3. This proposal was supported by arguments that it is not practical to change the safety factor from 1.3 during operation to 1.5 upon closure of the tailings pond, and that furthermore 1.3 was considered to be 'safe enough' and in accordance with current legislation. However the other Members States and some industry working group members proposed a value of 1.5, arguing that by applying a factor of 1.5 the monitoring in the after-care phase could be reduced. Furthermore the International commission on large dams (ICOLD) recommends the value of 1.5. Therefore there was no unanimous BAT decision on the safety factor for long-term stable dams having a water cover.

The TWG decided that drying tailings, thickening tailings, as well as the deposition of slurried tailings are all BAT, depending on many factors (e.g. grain size, climate, etc.).

As for the methods for constructing and raising tailings dams, the TWG agreed on the applicability for the upstream method based on information available in this document and further information provided in the final meeting. Conventional dams as well as the upstream, downstream and centreline methods are all considered BAT under specific conditions.

¹⁷) COM(2003) 319 final, 2.6.2003. The proposed Directive includes references to BAT in its articles 4(2), 19(2) and 19(3)

Recommendations for future work

The result of this information exchange, i.e. this document, presents an important step forward in reducing everyday pollution and preventing accidents from tailings and waste-rock management facilities. On a few topics, however, the information is incomplete and did not allow BAT conclusions to be reached. The main issues have been presented in Section 7.2 and 7.3.

Future work could usefully focus on collecting the following information:

- expansion of the scope: In the kick-off meeting, the TWG decided to limit the scope to an appropriate extent so that this document could be developed in the given time-scale. Any future revision should seek to expand the scope in two directions: (1) the list of minerals covered should be expanded, and (2) the document should be adapted to the final scope of the Directive on the management of waste from the extractive industries after its adoption.
- generation of tailings and waste-rock: There is a lack of information in the document on the amounts of tailings and waste-rock generated in Europe. Ideally this information should be included for all of the minerals discussed in this document. This information needs to be collected by industry and Member States from ongoing projects
- BAT associated emission levels for effluent treatment and for cyanide destruction: There is a lack of information on emission levels for effluent treatment and cyanide destruction. This data should be gathered from current operations and then, analysed and compared with the information already included in Chapter 3 in such a way that it is possible to agree the BAT associated emission levels. For cyanide destruction, there are few example sites in Europe. Therefore information should be gathered from operations outside of Europe, especially Australia, Canada and the US where there is greater experience in this subject. An information exchange with industry and authorities from these countries should be established in order to gather the information necessary to establish BAT associated emission levels
- underwater tailings management in seawater: This technique was introduced following a comment on the 2nd draft. During the final plenary meeting, the TWG concluded that further information about this technique is required to decide whether it is BAT. Currently a clearer description of the technique and information on the applicability, cross-media effects and the economics of this technique are missing. This information needs to be collected by industry and Member States from ongoing projects before it is possible to fully assess whether it is BAT. Several issues were raised during the final meeting, e.g.
 - the technique may be a possible alternative to land disposal, if the material is benign and there is no land available
 - thickened tailings management is being developed in this area, which keeps the tailings from ‘moving’ once placed under water
 - sea and lake disposal have been applied many times, therefore data should be available for evaluation of this technique
 - this technique may only be applicable in fjord settings, in other cases it may be difficult to predict any further movement of the tailings
 - in the light of the “Prestige” oil spill it was noticed that in the case of error the damage cannot be undone
- economic data: There is a lack of economic information for many of the techniques presented in Chapter 4. This information needs to be collected by industry and Member States from ongoing projects
- characterisation of tailings and waste-rock:
 - in Annex 4 some standards are shown which can be used to characterise tailings and waste-rock. However for the measurements of geotechnical properties these are mainly BS and ASTM standards. There is a need to include more international and national standards in order to facilitate the use of the methods in different Member States
 - Annex 4 lists and describes many methods for the characterisation of tailings and waste-rock. A standard methodology needs to be developed that can be generally applied and accepted within Europe, in order to allow a relevant level of characterisation of all

waste-rock and tailings to be achieved. The correlation between the characterisation results and the long-term environmental behaviour of tailings and waste rock, under actual 'real world' conditions needs also to be established.

- thickened tailings: The current document describes techniques to dewater slurried tailings as well as for the management of slurried tailings in ponds. There is relatively little information in the document on the thickened tailings technique, since this technique has only been recently introduced in the mining area. It is expected that this technique will be more broadly applied in the future. Once more, if performance data is available it needs to be incorporated into the document. This would allow a more precise description of the applicability of this technique
- phytoremediation of cyanide emissions: In the case of gold mining, environmental risks nowadays originate from the use of cyanide solutions, highly toxic for animals and plants. One possible route for minimising the environmental impact of emissions from mining may be waste water treatment with constructed wetlands, i.e. wetland-phytoremediation. Phytoremediation is the use of green plants to stabilise or remove contaminants from soils, sediments or water. Previous studies on phytoremediation of heavy metals and organic contaminants have proven the general ability of plants to take up substances from soil or water. The goal of an ongoing research project is to find high biomass plants that combine a sufficiently high uptake of cyanide with low susceptibility towards cyanide as well as towards toxic metals. After laboratory studies the aim is to establish field-scale experiments in model wetlands in order to develop a bioremediation technology for industrial use. The results of this research project¹⁸ should be included in a future revision of this document.

The EC is launching and supporting, through its RTD programmes, a series of projects dealing with clean technologies, emerging effluent treatment and recycling technologies and management strategies. Potentially these projects could provide a useful contribution to future reviews of this document. Readers are therefore invited to inform the EIPPCB of any research results which are relevant to the scope of this document (see also the preface of this document).

Suggested topics for future research and development projects

The information exchange has also exposed some areas where additional useful knowledge could be gained from Research and Development projects. These relate to the following subjects:

- life-cycle management: The TWG recognised that applying full life-cycle management would be essential for a site to achieve a high level of safety and environmental performance. However, economic data showing that it is economically effective to manage a mining operation with the entire life-cycle model is currently missing. Research in this area is needed to investigate any existing case studies, to determine the economics of applying integrated life-cycle management compared to the conventional approach (i.e. maximum profit during operation)
- cyanide decomposition products toxicity: The toxicity of cyanide itself is a well investigated subject. However, it seems that some decomposition products may also be of toxicological importance. In view of the impact of spills from sites using cyanide to leach gold there is a need for research on the toxicity of cyanide decomposition products.

¹⁸) Prof. Dr. Andreas Schaeffer, University of Technology Aachen (RWTH Aachen), Germany, Biology V - Environmental Chemistry

REFERENCES

- 6 ICOLD (1996). "Tailings dam and environment", ICOLD, Paris, issn 0534-8293.
- 7 ICOLD (1996). "Monitoring of tailings dams", ICOLD, Paris, issn 0534-8293.
- 8 ICOLD (1996). "A guide to tailings dams and impoundments, design, construction, use and rehabilitation", ICOLD, Paris, 92-807-1590-7.
- 9 ICOLD (2001). "Tailings dams, risk of dangerous occurrences", ICOLD, Paris, issn 0534-8293.
- 11 EPA, A. (1995). "Tailings containment", Best practice environmental management in mining.
- 12 K. Adam, E. M. (2001). "Closure plan of a pyrite concentrate stockpile at Stratoni mines , Greece", TVX Hella/Echmes.
- 13 Vick, S. G. (2001). "Stability aspects of long-term closure for sulfide tailings".
- 14 Höglund, L. O. (2001). "EU - Towards a new mines directive - Main priorities", *Ireland*.
- 19 K+S (2002). "Potash Industry contribution to MTWR-BREF", K+S.
- 20 Eriksson, N. (2002). "Acid Rock Drainage (ARD)".
- 21 Ritcey, G. M. (1989). "Tailings management, problems and solutions in the mining industry", *Process Metallurgy 6*, Elsevier, 0-444-87374-0.
- 22 Aughinish (2001). "Residue storage area extensions scheme, environmental impact statement, chapter 4", Aughinish alumina refinery, IPC permit application.
- 23 Tara, M. L. (1999). "IPC application, attachment No. 22, reclamation and closure plan - preliminary cost estimate (Golder Associates)", Irish EPA.
- 24 British Columbia CN guide, H. (1992). "Technical guide for the environmental management of cyanide in mining".
- 25 Lisheen, M. L. L. (1995). "Environmental impact statement", Irish EPA.
- 26 Mudder, B. (2000). "A global perspective of cyanide", <http://www.mineralresourcesforum.org/initiatives/cyanide/docs/mudder.pdf>.
- 27 Derham, J. (2002). "Analysis of red mud", personal communication.
- 29 Barytes, A., P. Huxtable (2002). "Barytes BAT note".
- 30 Weber, Z. (2001). "World mining data", 3-901074-14-7.
- 31 Ritcey (1989). "Tailings management ,same as tm 21".
- 32 Derham, H. (2002). "Detailed red mud analysis", Irish EPA, personal communication.
- 33 Eurallumina, I., Alfredo Teodosi (2002). "BREF questionnaire reply, Bauxite", 5.4.2002.
- 34 EAA, E. N. (2002). "European Alumina plants production in 2001", EAA, personal communication.
- 36 USGS (2002). "Metal Statistics and Information", US Geological Survey, <http://minerals.usgs.gov/minerals/pubs/commodity/>.
- 37 Mineralgallery (2002). "Minerals information", <http://mineral.galleries.com>.
- 38 Weber, L. (2002). "Information on manganese", personal communication.
- 39 IMA (2002). "3.x Feldspar (if recovered by flotation)_1", IMA, 29.3.2002.
- 40 IMA (2002). "Kaolin chapter draft 1", 19.03.2002.

References

- 41 Stokes, M. (2002). "Presentation on Lisheen TMF", Anglo, Lisheen, personal communication.
- 42 IMA (2002). "Limestone contribution", IMA, 15.4.2002.
- 43 Sogerem, E. (2002). "Fluorspar contribution", Euromines, 17.4.2002.
- 44 Italy (2002). "Questionnaire response from Nuova Mineraria Silius Italy, Fluorspar and Lead Sulphide", ENEA - C.R. CASACCIA, 5.4.2002.
- 45 Euromines (2002). "Framework for mining waste management", Euromines, 22.4.2002.
- 48 Bennett, E., Jans (IMA-EUROPE) (2002). "Good environmental practice in the European extractive industry: A reference guide".
- 49 Iron group, E. (2002). "Contribution iron ore, Swedish mining industry (LKAB)", Euromines.
- 50 Au group, E. (2002). "Contribution gold, Swedish mining industry (Boliden)", Euromines.
- 51 Iron group, E. (2002). "LKAB water data", Euromines, personal communication.
- 52 Tungsten group, E. (2002). "Industry contribution tungsten", Euromines, 2.5.2002.
- 53 Vick, S. G. (1990). "Planning, design, and analysis of tailings dam", BiTech, 0-921095-12-0.
- 54 IGME (2002). "Base metals contribution (Asturiana de Zinc)", Instituto Geologico y Minero de Espana, 10.4.2002.
- 55 Iron group, E. (2002). "Contribution iron ore, Austrian mining industry (Erzberg)", 3.7.2002.
- 56 Au group, E. (2002). "Contribution gold, Turkish mining industry (Ovacik)", Euromines, 26.3.2002.
- 57 IGME (2002). "Contribution gold, Spanish mining industry 1 (Filon Sur)", Instituto Geológico y Minero de Espana (IGME), 10.2.2002.
- 58 IGME (2002). "Contribution gold, Spanish mining industry 2 (Rio Narcea)", Instituto Geológico y Minero de Espana (IGME), 10.2.2002.
- 59 Himmi, M. (2002). "Contribution gold, Finnish mining industry (Orivesi)", Outokumpu Oy, 11.2.2002.
- 61 IGME (2002). "Base metals industry contribution (Almagrera)", Instituto Geológico y Minero de Espana (IGME), 10.2.2002.
- 62 Himmi, M. (2002). "Base metals industry contribution (Outokumpu, Pyhäsalmi and Hitura site)", Outokumpu Oy, 11.2.2002.
- 63 Base metals group, E. (2002). "Base metals industry contribution (Aitik)", Boliden/Euromines, 17.4.2002.
- 64 Base metals group, E. (2002). "Base metals industry contribution (Garpenberg)", Boliden/Euromines, Spring 2002.
- 65 Base metals group, E. (2002). "Base metals industry contribution (Boliden)", Boliden/Euromines, spring 2002.
- 66 Base metals group, E. (2002). "Base metals industry contribution (Zinkgruvan)", Rio Tinto/Euromines, 10.4.2002.
- 67 IGME (2002). "Base metals industry contribution (Cobre Las Cruces)", Instituto Geológico y Minero de Espana (IGME), 10.2.2002.
- 68 Eriksson, A. (2000). "The tailings pond failure at the Aznalcollar mine, Spain" Sixth International Symposium in Environmental Issues and Waste Management in Energy and Mineral Production, 30 May – June 2, Calgary, Alberta, Canada.

- 69 Nguyen, K. H., P. (2002). "JK Frothcam, flotation plant control with JK Frothcam", TK Tech, pdf file from <http://www.jktech.com.au/products/hardware/slideshows/FrothCam.pdf>.
- 70 EAA, E. A. A. (2002). "Annual report 2001", EAA.
- 71 Himmi, M. O. (2002). "BREF contribution, chrome section", Outokumpu Oy, 11.2.2002.
- 73 Ivernia West, I. (2002). "Operations, Lisheen", <http://www.ivernia.com/operate/lisheen.htm>.
- 74 Outokumpu (2002). "Tara mine", Outokumpu Oy, <http://www.outokumpu.com/mining/wwwmining.nsf/StartFrame?Openform>.
- 75 Minorco Lisheen/Ivernia West, S., Robertson and Kirsten (1995). "Planning study tailings management facility, technical report", Irish EPA.
- 76 Irish EPA, L. (2001). "Waste comparison report 2000-2001 and other reports", Irish EPA.
- 77 Robinsky, E. I. (2000). "Sustainable development in disposal of tailings" Tailings and mine waste '00, Fort Collins, Colorado.
- 78 Ron Tenny, E., Inc., and Jack Adams, Applied Biosciences Corp. (2001). "Ferric salts reduce arsenic in mine effluent by combining chemical and biological treatment", Environmental Science & Engineering, January 2001.
- 79 DSK (2002). "BREF contribution", DSK, 15.4.2002.
- 80 DSK, S. (2002). "Flotation tailings from hard coal production", DSK, personal communication.
- 81 MSHA (2002). "What is in coal tailings?", MSHA, <http://www.msha.gov/impoundments/chemicals-imp.HTM>.
- 82 Iron group, L. (2002). "LKAB tailings analysis", LKAB/Euromines, personal communication.
- 83 Kribek, H. (2002). "Czech Republic BREF contribution coal", University Ostrava and Czech Geological survey, 12.4.2002.
- 84 IGME (2002). "Gestión de residuos de la minería del carbón", Instituto Geológico y Minero de España (IGME), 18.7.2002.
- 85 EPA, U. (2002). "Mid-atlantic acidification treatment techniques", US EPA, <http://www.epa.gov/region03/acidification/treatment.htm>.
- 89 Teodosi, A. (2002). "BREF allumina addendum", 05.07.2002.
- 90 Peppas, G., Christou (2002). "BREF questionnaire reply, bauxite", Euromines, ? of April 2002.
- 91 Foldessy (2002). "BREF questionnaire reply, Hungary", University of Miskolc Hungary, 3.5.2002.
- 92 EBA, E. B. A. (2002). "BREF contribution", Industrial Minerals Association (IMA), 22.4.2002.
- 93 Atlas Copco, C. a. m. (2002). "Underground mining", Atlas Copco, <http://sg01.atlascopco.com/SGSite/Default.asp?cookie%5Ftest=1>.
- 95 Elander, L., Hakansson (1998). "MiMi - Prevention and control of pollution from mining waste products", Mistra programme MiMi.
- 97 Environment Australia, E. (2002). "Best practice principles for minesite water management plan", EA, <http://www.ea.gov.au/industry/sustainable/mining/booklets/water/water4.html>.

References

- 98 Eriksson, N. (2002). "Cost estimate", Euromines.
- 99 Devuyt, E. A. (2002). "Cost for INCO process", INCO, personal communication.
- 100 Eriksson, N. (2002). "Closure of mining waste facilities", Euromines.
- 101 Tara mines, G. (1999). "TMF reclamation plan, IPC license application", Irish EPA.
- 102 Diegel, R. (1994). "Untersuchungen über Adsorptionsverhalten und Wirkung von Flotationshilfsmitteln in der Steinkohlenaufbereitung mit Hilfe der Leitisotopenmethode unter besonderer Berücksichtigung möglicher Auswirkungen auf die Umwelt", Verlag Shaker, 3-8265-0473-9.
- 104 Young, e. a. (1995). "Cyanide remediation: current and past technologies" 10th annual conference on hazardous waste research, *Kansas State University, Manhattan, Kansas, USA*.
- 105 Wotruba, A. (2002). "Mineral processing unit processes", Institute for Mineral Processing, 9.9.: 1st draft with pictures, 10.10.: final text.
- 106 Logsdon, H., Mudder (1999). "The management of cyanide in gold extraction", ICME, 1-895720-27-3.
- 107 EuLA, E. L. A. (2002). "Fallbeispiel Flandersbach quarry", EuLA, European Lime Association.
- 108 EuLA (2002). "Planung, Betrieb und Überwachung eines Absetzbeckens im Kalkwerk Münchhof der Felswerke, Goslar", EuLA, European Lime Association, 12.09.2002.
- 109 Devuyt (2002). "CN destruct/recycle 1", INCO, personal communication.
- 110 IGME (2002). "Gestión de residuos de las explotaciones de minerales no metálicos", Instituto Geológico y Minero de Espana (IGME), July 2002.
- 111 DSK (2002). "World hard coal production", based on www.kohlenstatistik.de, personal communication.
- 112 Commission, E. (2002). "Report from the Commission to the Council concerning Mercury from the Chlor-alkali Industry", European Commission, COM(2002)489.
- 115 Mill, O. (2001). "The society and the roll of the authorities" Safe Tailings dam construction, *Gällivare Sweden*.
- 116 Nilsson, Å. (2001). "Safe dam constructions" Safe tailings dam construction, *Gällivare, Sweden*.
- 117 Forestry, F. M. o. A. a. (1997). "Dam Safety Code of Practice", Finnish Ministry of Agriculture and Forestry, 951-53-1335-X.
- 118 Zinkgruvan (2003). "Chapter 4 contribution", Rio Tinto/Euromines, 26.3.2003.
- 119 Benkert, A. (2003). "Dam safety - Independent Audits", Euromines, 26.3.2003.
- 120 Sawyer, R. (2002). "Information on mine tailings", KMC, personal communication.
- 122 Eriksson, N. (2003). "Subaqueous tailings disposal", Euromines.
- 123 PRB action team, U. (2003). "PRB installation profiles, Nickel Rim Mine Site, Sudbury, Ontario, Canada", Remediation Technologies Development Forum (RTDF) , PRB action team, <http://www.rtdf.org/public/permbarr/prbsumms/profile.cfm?mid=41>.
- 124 US FRTR, U. F. R. T. R. (2003). "Constructed wetlands", Federal Remediation Technology Roundtable (FRTR), <http://www.frtr.gov/matrix2/section4/4-43.html>.
- 125 Grigg, C. (2003). "Kernick mica dam", IMA, 8.4.2003.
- 126 Eriksson, N. (2003). "Design of long-term stable tailings dams", Euromines.
- 127 Benkert, A. (2002). "Tailings dam constructions" Gällivare tailings dam seminar, *Gällivare, Sweden*.

- 129 Finland, F. M. o. A. a. F. (1997). "Dam Safety Code of Practice", Finnish Ministry of Agriculture and Forestry, 951-53-1335-X.
- 130 N.C.B., U. N. C. B., Technical Handbook (1970). "Spoil heaps and lagoons", UK National Coal Board.
- 131 IMA (2003). "IMA's proposal for chapter 4 (final)", IMA Europe, 26.3.2003.
- 135 Wettig, J. (2003). "Actions by the European Commission concerning emergency preparedness in the mining industry" "APELL for Mining" Workshop, Geneva, Switzerland.
- 136 Carlssons, E. (2002). "Sulphide-rich tailings remediated by soil cover", Luleå Technical University, diss 2002:44.
- 137 Lindvall, M., Lindahl, L.-A., Eriksson, N. (1997). "The reclamation project at the Saxberget mine, Sweden", Prepared for The Fourth Intern. Conference on Acid Rock Drainage, Vancouver, B.C., 1997.
- 138 Verburg, R. B. (2002). "Paste technology for disposal of acid-generating tailings", Mining Environment, July 2002, pp. 5.
- 139 Eurostat (2003). "Yearbook 2003".
- 140 Collin, M. (1987). "Mathematical modelling of water and oxygen transport in layered soil covers for deposits of pyritic mine tailings", Dept. of Chemical Engineering, Royal Institute of Technology, Stockholm.
- 141 Panasqueira, M. d. (2003). "Tungsten, Minas de Panasqueira".
- 142 Borges, A. (2003). "Questionário sobre as MTD para a gestão de estéreis e rejeitados das actividades mineiras", Ministério do Ambiente e do Ordenamento do Território, Instituto dos Resíduos.
- 143 Siirama, L. (2003). "Siilinjärvi Phosphate Operation".

GLOSSARY

1. GENERAL TERMS, ABBREVIATIONS, ACRONYMS AND SUBSTANCES

ENGLISH TERM	MEANING
A	
acid	Proton donor. A substance that, more or less readily, gives off hydrogen ions in a water solution.
acid-base accounting (ABA)	Acid-Base accounting (ABA) is a screening procedure whereby the acid-neutralising potential and acid-generating potential of rock samples are determined
acid generation	Production of acidity irrespective of its effect on the adjacent pore water or whether the material is net acid producing or neutralising
acid mine drainage (AMD), Acid rock drainage (ARD)	Acidic drainage stemming from open pit, underground mining operations, waste-rock or tailings facilities that contains free sulphuric acid and dissolved metals sulphate salts, resulting from the oxidation of contained sulphide minerals or additives to the process. The acid dissolves minerals in the rocks, further changing the quality of the drainage water
acid Potential (AP)	Maximum potential acid generation from a sample. The calculation of AP (or MPA) is an integral part of acid/base accounting
acidity	Measure of the capacity of a solution to neutralise a strong base
acute effect	an adverse effect on any living organism in which severe symptoms develop rapidly and often subside after the exposure stops.
acute toxicity	adverse effects that result from a single dose or single exposure of a chemical; any poisonous effect produced within a short period of time, usually less than 96 hours. This term is normally used to describe effects in experimental animals.
aeration	the act of mixing a liquid with air (oxygen).
aerobic	a biological process that occurs in the presence of oxygen
air classifier	Machine Equipment to separate dust (<0.05 mm) fine particles from the dry input material (<10 mm) or equipment to remove fine and coarse fractions from an air stream
alkali	Proton acceptor. A substance that, more or less readily, takes up hydrogen ions in a water solution.
alkalinity	Measure of the capacity of a solution to neutralise a strong acid
anaerobic	A biological process which occurs in the absence of oxygen
angle of repose	The maximum slope at which a heap of any loose or fragmented solid material will stand without sliding or come to rest when poured or dumped in a pile or on a slope
associated structures, appurtenant works, auxiliary works, appurtenances	All structures, components and facilities functionally pertaining to the tailings dam, including, but not limited to, spillways, decant towers and pipelines, reclaim pumps, water conduits, diversion structures, etc.
aquifer	A water-bearing layer of rock (including gravel and sand) that will yield water in usable quantity to a well or spring
assimilative capacity	The ability of a natural body of water to receive waste waters or toxic materials without harmful effects and without damage to aquatic life.
autogenous grinding	The secondary grinding of an ore by tumbling in a revolving cylinder with no balls or bars taking part in the operation.

ENGLISH TERM	MEANING
B	
backfill	Reinsertion of materials in extracted part(s) of the orebody. Materials used for backfilling can be waste-rock or tailings from the mineral processing plant. In most cases backfill is used to refill mined-out areas in order to: <ul style="list-style-type: none"> ▪ assure ground stability ▪ prevent or reduce underground and surface subsidence ▪ provide roof support so that further parts of the orebody can be extracted and to increase safety ▪ provide an alternative to surface disposal ▪ improve ventilation
bactericide	a pesticide used to control or destroy bacteria
BAT	best available techniques
bio-availability	Property of a substance which makes it accessible and potentially able to affect an organism's health. Depends on site-specific conditions
biochemicals	Chemicals that are either naturally occurring or identical to naturally occurring substances. Examples include hormones, pheromones and enzymes. Biochemicals function as pesticides through non-toxic, non-lethal modes of action, such as disrupting the mating pattern of insects, regulating growth or acting as repellants.
biodegradable	that can be broken down physically and/or chemically by microorganisms. For example, many chemicals, food scraps, cotton, wool and paper are biodegradable.
biodiversity	the number and variety of different organisms in the ecological complexes in which they naturally occur. Organisms are organized at many levels, ranging from complete ecosystems to the biochemical structures that are the molecular basis of heredity. Thus, the term encompasses different ecosystems, species and genes that must be present for a healthy environment. A large number of species must characterize the food chain, representing multiple predator-prey relationships.
bio-leaching	Process in which minerals are dissolved with the aid of bacteria
biological pesticides	certain microorganisms, including bacteria, fungi, viruses, and protozoa that are effective in controlling target pests. These agents do not usually have toxic effects on animals or people and do not leave toxic or persistent chemical residues in the environment.
bioremediation	the use of living organisms (e.g., bacteria) to clean up oil spills or remove other pollutants from soil, water and waste water.
biota	All living organisms in a given area.
blending	Mixing of the raw material to get input material with a steady quality for subsequent processes
BOD	Biochemical oxygen demand: the quantity of dissolved oxygen required by micro-organisms in order to decompose organic matter. The unit of measurement is mg O ₂ /l. In Europe, BOD is usually measured after 3 (BOD ₃), 5 (BOD ₅) or 7 (BOD ₇) days
BREF	BAT reference document
C	
chamber filter press	Equipment to dewater the fine particles in a slurry
COD	Chemical oxygen demand: the amount of potassium dichromate, expressed as oxygen, required to chemically oxidise at c. 150 °C substances contained in waste water

ENGLISH TERM	MEANING
comminution	Size reduction of an ore by crushing and/or grinding to such a particle size that the product is a mixture of relatively clean particles of mineral and gangue. In order to produce a relatively pure concentrate, it is necessary to grind the ore fine enough to liberate the desired minerals
compaction	Process resulting in a reduction in volume. The change typically results from externally applied loads, creating tighter packing of the solid particles. In fine soils in particular, this requires an egress of pore water. Greater compaction often results in increased consolidation
concentrate	Marketable product after separation in a mineral processing plant with increased grade of the valuable mineral
cone crusher	A machine for reducing the size of materials by means of a truncated cone revolving on its vertical axis within an outer chamber, the annular space between the outer chamber and cone being tapered
cross-media effects	The calculation of the environmental impacts of water/air/soil emissions, energy use, consumption of raw materials, noise and water extraction (i.e. everything required by the IPPC Directive)
crushing	Comminution process that reduces the particle size of run-of-mine ore to such a level that grinding can be carried out. This is accomplished by compression of ore against rigid surfaces, or by impact against surfaces in rigidly constrained motion path
cut-off trench	An impermeable wall, collar, or other structure placed beneath the base or within the dam to prevent or reduce losses by seepage along a construction interface or through porous or fractured strata. It may be made of concrete, compacted clay, interlocking sheet piling, or grout injected along a line of holes
cyanidation	<p>Method of extracting gold or silver from crushed or ground ore by dissolution in a weak solution of typically sodium but also potassium or calcium cyanide. Also known as cyanide leaching.</p> <p>The precious metals are then recovered from the pregnant solution:</p> <ul style="list-style-type: none"> ▪ either by precipitation on zinc dust (Merrill-Crowe process), ▪ or by adsorption on activated carbon inside a column (carbon in leach, (CIL)) or within the pulp (carbon in pulp, (CIP))
D	
d50, d80	A value often used in mineral processing to describe particle size distribution. It indicates the particle size at which 50 % or 80 % of the sample are smaller than a given size.
decant lines	Pipelines that carry water decanted from the tailings pond through, above or around the tailings dam to a downstream collection point
decant tower	Intake structure that is raised as the tailings pond rises. The decant tower skims off the clear water from the surface of the tailings pond and carries it away using decant lines
decommissioning	Process by which a mining operation is shut down
dewatering	Process of removing water from an underground mine or open pit, or from the surrounding rock or non-lithified area. The term is also commonly used for the reduction of water content in concentrates, tailings and treatment sludges

ENGLISH TERM	MEANING
diffuse emission	Emissions arising from direct contact of volatile or light dusty substances with the environment (atmosphere, under normal operating circumstances). These can result from: <ul style="list-style-type: none"> ▪ inherent design of the equipment (e.g. filters, dyers...) ▪ operating conditions (e.g. during transfer of material between containers) ▪ type of operation (e.g. maintenance activities) ▪ or from a gradual release to other media (e.g. to cooling water or waste water). Fugitive emissions are a subset of diffuse emissions
diffuse sources	Sources of similar diffuse or direct emissions which are multiple and distributed inside a defined area
diversions	For tailings ponds, diversions are usually relatively small interceptor ditches that collect run-off from the contributing watershed and divert it downstream beyond the tailings pond and dam
drainage	Manner in which the waters of an area exist and move, including surface streams and groundwater pathways. A collective term for all concentrated and diffuse water flow
drainage chemistry	Concentrations of dissolved components in drainage, including element concentrations, chemical species and other aqueous chemical parameters.
drowning the beach	Rapid rising of the free water in the tailings pond which covers or floods the semi-pervious upstream beach of the tailings dam and results in a free water surface against the tailings dam
E	
ecosystem	Community of organisms and their immediate physical, chemical and biological environment
effective neutralisation potential (ENP)	The fraction of the NP, which will neutralise acid generation and acidity inputs maintaining a drainage pH of 6.0 or above
effluent	Physical fluid (air or water together with contaminants) forming an emission
EIPPCB	European IPPC Bureau
emerging techniques	Techniques with potential for environmental performance improvement but that have not yet been commercially applied or which are still in the research and development phase
emission	The direct or indirect release of substances, vibrations, heat or noise from individual or diffuse sources in the installation into the air, water or land
emission limit values	The mass, expressed in terms of certain specific parameters, concentration and/or level of an emission, which may not be exceeded during one or more periods of time
“end-of-pipe” technique	A technique that reduces final emissions or consumptions by some additional process but does not change the fundamental operation of the core process. Synonyms: "secondary technique", "abatement technique". Antonyms: "process-integrated technique", "primary technique" (a technique that in some way changes the way in which the core process operates thereby reducing raw emissions or consumptions)
environment	Interrelated physical, chemical, biological, social, spiritual and cultural components that affect the growth and development of living organisms
EOP	End-of-pipe
erosion	Detachment and subsequent removal of either rock or surface material by wind, rain, wave action, freezing, thawing and other processes.

ENGLISH TERM	MEANING
europe	Current EU Member States (EU-15) and EU Enlargement candidate countries (see Section 2 of this glossary)
eutrophication	The pollution of a body of water by sewage, fertilisers washed from the land, and industrial wastes (inorganic nitrates and phosphates). These compounds stimulate the growth of algae, reducing the oxygen content in the water, and so killing animals with a high oxygen requirement.
evaporation	Physical process by which a liquid is changed into a gas.
existing operation	An installation in operation or, in accordance with legislation existing before the date on which this Directive is brought into effect, an installation authorised or in the view of the competent authority the subject of a full request for authorisation, provided that that installation is put into operation no later than one year after the date on which this Directive is brought into effect
extraction methods	There are basically four methods of extracting ore: <ul style="list-style-type: none"> ▪ open pit (open cast) mining ▪ underground mining ▪ solution mining ▪ quarrying
F	
facility	Stationary technical unit involving tailings and/or waste rock management, and any other directly associated activities which have a technical connection with the activities carried out on that site and which could have an effect on emissions and pollution
financial guarantee	Funds provided through various financial instruments, which may be used by a regulatory authority to offset closure costs
flocculant	Substance that causes suspended particles to aggregate or clump. The larger apparent particle size causes the aggregated clumps to settle. Flocculants are used to aggregate small particles whose slow settling rate makes them otherwise very difficult to remove
flotation	A form of separation of minerals from gangue based on their different surface reaction to certain reagents (or alternatively based on the interfacial chemistry of mineral particles in solution). Reagents are used to adhere to the target mineral, and render its surface hydrophobic. The target mineral which then rises to the top of the flotation cell with the injected air, where it can be collected as a froth. When the aim is to float the gangue this process is called reverse flotation
free CN	The cyanide not combined in complex ions, both the molecular HCN and the cyanide ion [24, British Columbia CN guide, 1992]
free water	The area of water held on a tailings pond above the settled tailings, normally removed by pumping or decanting
freeboard	Vertical distance (height) between the normal maximum operating level of a pond and the crest of the dam, the purpose of which is to provide attenuation capacity in times of flood or, a sudden ingress of water
free on board (f.o.b.)	Price of consignment to a customer when delivered, with all prior charges paid, onto a ship or truck
friction angle, angle of friction	The angle between the perpendicular to a surface and the resultant force acting on a body resting on the surface, at which the body begins to slide

ENGLISH TERM	MEANING
fugitive emission	emission caused by non-tight equipment/leak: emission into the environment resulting from a gradual loss of tightness from a piece of equipment designed to contain an enclosed fluid (gaseous or liquid), basically caused by a difference of pressure and a resulting leak. Examples of fugitive emissions: leak from a flange, a pump, a sealed or tightened equipment...
G	
gangue	That part of an ore that is not economically desirable but cannot be avoided in mining (see Figure G1).
geochemistry	Science of the chemistry of geological materials and the interaction between geological materials with the environment
geology	Study of the earth, its history and the changes that have occurred or are occurring, and the rocks and non-lithified materials of which it is composed and their mode of formation and transformation
gossan	Ore within the upper part of a sulphidic orebody that has been weathered to an oxide ore
grade	Dimensionless proportion of any constituent in an ore, expressed often as a percentage, grams per tonne (g/t) or parts per million (ppm)
grinding	Comminution process yielding a fine product (<1 mm), where size reduction is accomplished by abrasion and impact and sometimes supported by the free motion of unconnected media such as rods, balls and pebbles
groundwater	Part of subsurface water in the zone of saturation. Distinct from surface water
grout curtain	An area into which grout (a pumpable cement slurry) has been injected to form a barrier around an excavation or under a dam through which groundwater cannot seep or flow
gyratory crusher	A primary crusher consisting of a vertical spindle, the foot of which is mounted in an eccentric bearing within a conical shell. The top carries a conical crushing head revolving eccentrically in a conical maw
H	
humidity cell test	Kinetic test procedure used primarily to measure rates of acid generation and neutralisation in sulphide-bearing rock.
hydraulic gradient	Difference in hydraulic head between two points divided by the travel distance between the points
hydrogeology	Science of the groundwater circuit (interrelationship of geologic materials and processes with water)
hydrology	Science of the occurrence, circulation, distribution, movement, chemical and physical properties and reaction with the environment of all water
I	
IEF	Information Exchange Forum (informal consultation body in the framework of the IPPC Directive)
immission	Occurrence and level of polluting substance, odour or noise in the environment
impact crusher	In impact crushers, material comminution is accomplished primarily through the impact action of beaters, which hit the pieces of rock free-falling through the crusher chamber and throw them against stationary surfaces at high speed
industrial minerals	Non-metallic ore, non-fuel or non-gemstone rock, mineral or non-lithified material of economic value. Industrial minerals are primarily used for construction or in chemical and manufacturing industries. Examples include barytes, borate, feldspar, fluorspar, kaolin, limestone, phosphate, potash, strontium, and talc
infiltration	Entry of water into a porous substance

ENGLISH TERM	MEANING
IPPC	Integrated pollution prevention and control
J	
jaw crusher	A machine for reducing the size of materials by impact or crushing between a fixed plate and an oscillating plate
jig	Equipment in which materials are separated in a continuous flow according to their different densities.
K	
L	
leachate	Solution obtained by leaching; e.g. water that has percolated through soil containing soluble substances and that contains certain amounts of these substances in solution.
leaching	Passage of a solvent through porous or crushed material in order to extract components from the liquid phase. For example, gold can be extracted by heap leaching of a porous ore, or pulverised tailings. Other methods are tank leaching of ore, concentrates or tailings and in-situ leaching.
liberation	Release of the valuable mineral(s) from the gangue.
life-cycle	Design, construction, operation, monitoring, closure, restoration, after-care of a facility
liquefaction	Phenomenon that occurs in loose saturated soils usually when the excess pore water pressure (e.g. caused by an earthquake) becomes equal to the original confining pressure, and the soil behaves like a dense fluid, unable to resist significant shear stresses.
lithology	Composition of rocks, including physical and chemical characteristics such as colour, mineralogical composition, hardness and grain size.
LOI, Loss on ignition	As applied to chemical analyses, the loss in weight that results from heating a sample of material to a high temperature, after preliminary drying at a temperature just above the boiling point of water. The loss in weight upon drying is called free moisture; that which occurs above the boiling point of water, is called loss on ignition.
long-term phase	Period of time required, after the end of the rehabilitation phase, for the tailings to become sufficiently inert that they no longer pose any problems to the environment
lysimeter	Device for collecting water from the pore spaces of soils and for determining the soluble constituents removed in the drainage
M	
maximum credible earthquake (MCE)	Hypothetical earthquake that could be expected from the regional and local potential sources for seismic events and that would produce the severest vibratory ground motion at the site
mine production	For metals, the amount of metal in the concentrate after production, in all other cases, unless stated otherwise, the amount of concentrate by weight after mineral processing

ENGLISH TERM	MEANING
mineral processing (benefication, ore dressing, mineral dressing, milling)	Processes to produce marketable mineral products (concentrates) from ore. This is usually carried out on the mine site, the plant being referred to as mineral processing plant (mill or concentrator). The essential purpose is to reduce the bulk of the ore, which must be transported to and processed by subsequent processes (e.g. smelting), by using methods to separate the valuable (desired) mineral(s) from the gangue. The marketable product of this is called concentrate, the remaining material is called tailings. Mineral processing includes various procedures that rely on the mineral's physical characteristics (i.e. particle size, density, magnetic properties, colour) or physicochemical properties (surface tension, hydrophobicity, wettability).
mineral processing plant (mill, concentrator)	Facility, where mineral processing is carried out
mineral resource	Concentration or occurrence of natural, solid, inorganic or fossilised organic material in or on the Earth's crust in such form and quantity and of such a grade or quality that it has reasonable prospects for economic extraction. The location, quantity, grade, geological characteristics and continuity of a Mineral Resource are known, estimated or interpreted from specific geological evidence and knowledge
mining	Methods and techniques to extract ore from the ground, including support facilities (e.g. stockpiles, workshops, transport, ventilation) and supporting activities in the mine itself or in the vicinity
mining operation	Any extraction of ore from which mineral substances are taken, where the corporate intent is to make an operating profit or build continuously toward a profitable enterprise
mitigation	Activity aimed at avoiding, controlling or reducing the severity of adverse physical, chemical, biological and/or socio-economic impacts of an activity
monitoring	Process intended to assess or to determine the actual value and the variations of an emission or another parameter, based on procedures of systematic, periodic or spot surveillance, inspection, sampling and measurement or another assessment methods intended to provide information about emitted quantities and/or trends for emitted pollutants
multi-media effects	See cross-media effects
N	
n/a	not applicable OR not available (depending on the context)
n/d	no data
neutralisation	Raising the pH of acidic solutions or lowering the pH of alkaline solutions to near-neutral pH (about pH 7) values through a reaction in which the hydrogen ion of an acid and the hydroxyl ion of a base combine to form water.
neutralisation potential (NP)	General term for a sample's or a material's capacity to neutralise acidity
O	
open pit (open cast) mining	Mining operation takes place on the surface. Mining operation and environment are in contact over an extended area

ENGLISH TERM	MEANING
operator	Any natural or legal person to whom responsibility has been delegated for the control, operation and maintenance of a mine, mineral processing plant, tailings dam and/or related facilities including the after-closure phase. Where this has been provided for in national legislation, a person to whom decisive economic power over the technical functioning of a mine, mineral processing plant, tailings dam and/or related facilities including the after-closure phase has been delegated.
ore	Mineral or variety of accumulated minerals (including coal) of sufficient value as to quality and quantity that it/they may be mined at a profit. Most ores are mixtures of extractable minerals and extraneous rocky material described as gangue (see Figure G1).
orebody (mineral deposit)	Naturally occurring geological structure consisting of an accumulation of a desired mineral and waste-rock, from which the mineral can be extracted, at a profit, or with a reasonable expectation thereof (see Figure G1)
overburden	Layer of natural grown soil or massive rock on top of an orebody. In case of open pit mining operations it has to be removed prior to extraction of the ore (see Figure G1)
P	
percentage extraction	Proportion of ore mined from the orebody expressed as a percentage of the original in-situ amount of ore
permeable reactive barrier	A permeable zone containing or creating a reactive treatment area oriented to intercept and remediate a contaminant plume. It removes contaminants from the groundwater flow system in a passive manner by physical, chemical or biological processes [123, PRB action team, 2003]
permeability	Capacity of a rock or non-lithified material to transmit fluid
phreatic	Pertaining to ground water
phreatic surface	The surface between the zone of saturation and the zone of aeration; that surface of a body of unconfined ground water at which the pressure is equal to that of the atmosphere
PI	process-integrated
piping	Mostly subterranean erosion of non-lithified materials caused by flowing water. Results in the formation of conduits due to the removal of particles
pollutant	Individual substance or group of substances which can harm or affect the environment
primary crushing	Process of reducing ore into smaller fragments to prepare it for further processing and/or so that it can be transported to the processing plant. In underground mines, the primary crusher is often located underground, or at the entrance to the processing plant
primary measure/ technique	Technique that in some way changes the way in which the core process operates thereby reducing raw emissions or consumptions (see end-of-pipe technique)
probable maximum earthquake (PME)	A geotechnical engineering parameter determined by the maximum recorded earthquake at the site, the maximum recorded earthquake for a site in a similar location for which historic data is available or the one-in-10000-year earthquake predicted statistically from previous earthquakes in the region

ENGLISH TERM	MEANING
probable maximum flood (PMF)	The most severe precipitation and/or snowmelt event considered reasonably possible at a particular geographic location. A site-specific determination based on the possible range in meteorological and hydrological events and conditions. Variables include the duration, the area and the time of year. Usually defined as the 1:10000 year flood or two or three times the 1:200 year flood
pump barge	Barge that floats in the tailings pond and supports the pumps that are used to reclaim the fee water in the pond for re-use in the mineral processing plant
Q	
quarry	Whole area under the control of an operator carrying out any activity involved in the prospecting, extraction, treatment and storage of minerals, including common related infrastructures and waste management activities, being not a mine. It is distinguished from a mine because it is usually open at the top and front, and used for the extraction of building stone, such as slate, limestone, gravel and sand
quebracho	Aqueous extract of the bark of the quebracho tree; contains up to 65 % tannin. Used in froth-flotation as depressant for oxidized minerals.
R	
reclaim lines	Pipelines that are used to convey the reclaimed water from the tailings pond to the mineral processing plant
reclaim system	Several components comprising the system constructed to reclaim water from the tailings pond and deliver it to the mineral processing plant. May include such items as: pump barges, reclaim lines, decant towers, and decant lines
reclaim water	Water recovered from the TMF, water treatment plant or mineral processing plant for re-use in the mineral processing plant
reclamation (rehabilitation, recultivation)	Restoration of land and environmental values of a mine site after the ore is extracted. Reclamation operations are usually underway as soon as the ore has been removed from a mine site. The process includes restoring the land to its approximate original appearance by restoring topsoil and planting native grasses and ground covers
recovery	Proportion, expressed as a percentage, of a constituent pertaining to the concentrate (or for coal final tonnage) as compared to the total amount of that mineral initially present in the feed prior to mineral processing. A measure of mining, extraction and processing efficiency
refractory gold	The contained gold is sub-microscopic (<1 µm) and finely disseminated in the sulphide mineral lattices
roll crusher	A type of secondary crusher consisting of a heavy frame on which two rolls are mounted. These are driven so that they rotate toward one another. Rock fed in from above is nipped between the moving rolls, crushed, and discharged at the bottom
ROM	Run of mine. Unprocessed conveyed material (ore) from the mining operation.
run-off	Part of precipitation and snowmelt that does not infiltrate but moves as overland flow.
S	
sample	Representative amount of solids, which are drawn from orebodies or processes to perform analytical testwork. The amount of solids and the number of samples drawn from the orebody or the process stream has to be statistically accurate.
screening	Separating material into size fractions
seam	Stratiform mineralization (typical for coal and some types of salt deposits). Due to tectonic overprint, seams may also be folded or steep lying

ENGLISH TERM	MEANING
secondary measure/ technique	See end-of-pipe technique
seepage recovery dam	Small, water retention dam located downstream of the tailings dam, whose purpose is to intercept, collect, and return to the tailings pond all surface and subsurface seepage flows that by-pass the main tailings dam
semi-autogenous grinding	The secondary grinding of an ore by tumbling in a revolving cylinder with only a small amount of balls or bars taking part in the operation.
separation	Processing methods to separate ore into concentrate and tailings.
shaft	Primary vertical or inclined opening through mine strata used for ventilation or drainage and/or for hoisting of personnel or materials (e.g. ore, waste-rock); connects the surface with underground workings
shear strength	The internal resistance of a body to shear stress, typically including a frictional part and a part independent of friction called cohesion
slurry	A suspension of liquids and solids
SME	Small and medium enterprise(s)
solubility	Quantity of solute that dissolves in a given volume and type of solvent, at given temperature and pressure, to form a saturated solution. The degree to which compounds are soluble depends on their ability, and that of the other dissolved species, to form ions and aqueous complexes in a particular drainage chemistry
specific emission	emission related to a reference basis, such as production capacity, or actual production (e.g. mass per tonne or per unit produced)
spigotting	Procedure whereby the tailings are discharged into the tailings pond through a large number of small outlets or spigots. Spigotting produces a fairly even distribution of tailings over the tailings beach that forms the upstream semi-imperious zone of the tailings dam
starter dam	Initial tailings dam, which is constructed before the mining operation starts and provides the starting point for construction of the ultimate tailings dam
stripping ratio	The unit amount of waste-rock or overburden that must be removed to gain access to a unit amount of ore, generally expressed in cubic metres of waste-rock/overburden to raw tonnes of ore
sub-aerial method of deposition	Name commonly used in North America for a method of spigotting which uses spray bars to place thin layers of tailings on a previously deposited beach
T	
tailings, coarse/fine discard	Ore from which as much as feasible of the desired minerals have been removed. Tailings consist mainly of gangue and may include process water, process chemicals and portions of the unrecovered minerals. Note: The UK coal mining industry uses the terms as follows: coarse discard: the coarser (and dryer) fraction of the discard, remaining after processing the mass of extracted material to separate the desired product by wet or dry methods. fine discard: the finer (and wetter) fraction of the discard, produced from the thickened or flocculated suspended solids in the wash water used to process and separate the desired product from the coarse discard by washing or floatation of the extracted material.
tailings beach	Area of tailings resulting from the settled solid fraction of a tailings slurry in a pond not covered by free water between the edge of free water and the crest of the dam
tailings dam, lagoon bank	Structure designed to settle and keep tailings and process water. Solids settle in the pond. The process water is usually recycled

ENGLISH TERM	MEANING
tailings heap, spoil heap	Engineered facility for the storage of tailings on the surface Dry disposal of tailings on the surface
tailings line	Pipeline used to carry the tailings from the mineral processing plant to the tailings pond
tailings management facilities (TMF)	Refers to the fact that tailings from mineral processing steps have to be discarded/stored or recovered. The chosen method depends amongst many other factors on the physical characteristics (coarse or fine) and on the treatment of the ore (dry or wet). Typical tailings management facilities or methods are: <ul style="list-style-type: none"> ▪ tailings dam/pond ▪ tailings heap ▪ backfill ▪ recycling (construction material) ▪ reprocessing (extract content of ore by new better processing methods).
tailings pond, lagoon	Engineered facility for managing tailings resulting from ore processing and for clearing and recycling of process water, most of the times formed by a dam construction. Mainly contains tailings along with varying amounts of free water
tailings sand	Sand obtained from the total tailings for use in construction of the tailings dam. Often produced by cycloning the total tailings
thickening	Liquid-solid separation process to increase the concentration of a suspension by sedimentation, accompanied by the formation of a clear solid
tip	Expression used in the UK mining industry for a spoil heap or lagoon composed of refuse (tailings) from a mine or quarry
top soil	Natural huminous layer on top of the orebody, which has to be stripped prior to start-up of extraction (see Figure G1)
total CN	The total of all cyanide existing in the various compounds in aqueous solution [24, British Columbia CN guide, 1992]
TWG	Technical working group
U	
ultramafic	Igneous rock composed chiefly of mafic minerals, e.g. monomineralic rocks composed of hypersthene, augite, or olivine
underground mining	Extraction of the ore takes place under the surface. The orebody is accessed by shafts, ramps and galleries
V	
vein	Thin complex structure of ore accumulations surrounded by gangue
W	
WAD CN	Weak acid dissociable cyanide represents cyanides that are dissociated under reflux with a weak acid, usually at pH 4.5 [24, British Columbia CN guide, 1992]
waste-rock, discard, dirt, spoil	Part of the orebody, without or with low grades of ore, which cannot be mined and processed profitably (see Figure G1)
waste-rock management facility (WRMF)	Facility where waste-rock is discarded, stored and in some cases treated, including waste-rock heap leaches
water balance	Process whereby all water entering the pond, all water leaving the pond and all water losses, are defined and described such that the net gain or loss of water into the tailings pond can be determined
water table	Elevation at which the fluid pressure is equal to atmospheric pressure. The surface separating the vadose zone (where water is held under tension) from the saturated zone (where fluid pressures are greater than zero)

ENGLISH TERM	MEANING
weathering	Processes by which particles, rocks and minerals are altered on exposure to surface temperature and pressure, and atmospheric agents such as air, water and biological activity
X	
Y	
yield	Mass ratio of concentrate to feed, calculated on dry basis and expressed as a percentage
Z	

Reagents:

Short form	Full name
Collectors:	
SIBX	Sodium isobutyl xanthate
SIPX	Sodium isopropyl xanthate
SEX	Sodium ethyl xanthate
PAX	Potassium amyl xanthate
DTP	Dithiophosphate
Frothers:	
MIBC	Methylisobutylcarbinol
Depressants:	
CMC	Carboxymethylcellulose

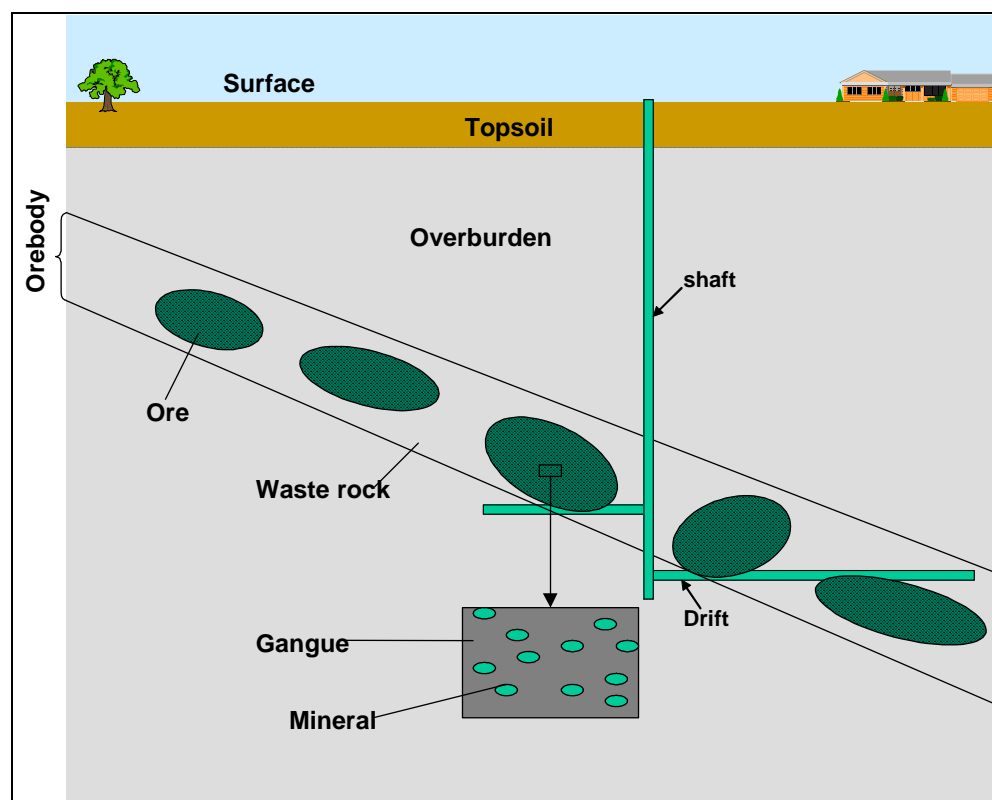

Figure G1: Schematic drawing of an orebody

Sources for glossary:

- “MANAGEMENT OF MINING, QUARRYING AND ORE-PROCESSING WASTE IN THE EUROPEAN UNION”, Study made for DG Environment of the European Commission TENDER DG XI E3/ETU/980116, June 2001, BRGM/RP-50319-FR
- “Mineral Processing Technology”, 5th edition, B.A. Wills
- Austrian comment on scope discussion paper
- <http://imcg.wr.usgs.gov/dmmrt/>
- <http://www.dep.state.pa.us/dep/deputate/minres/dms/website/training/glossary.html>
- <http://www.nrcan.gc.ca/mms/school/glossary.htm#r4>
- http://www.yesresources.com/Business_Tools/glossary.html
- <http://www.inap.com.au/inap/homepage.nsf>
- “Tailings Dam Safety. Guidelines”. ICOLD Bulletin 74, 1989.

2. EU MEMBER STATES LIST (EU-15)

Short Name	Full Name	Abbreviation	Currency ²	Currency ISO Code ³
Austria	Republic of Austria	A	Euro	EUR
Belgium	Kingdom of Belgium	B	Euro	EUR
Germany	Federal Republic of Germany	D	Euro	EUR
Denmark	Kingdom of Denmark	DK	Danish krone (pl. kroner)	DKK
Spain	Kingdom of Spain	E	Euro	EUR
Greece	Hellenic Republic	EL	Euro	EUR
France	French Republic	F	Euro	EUR
Finland	Republic of Finland	FIN	Euro	EUR
Italy	Italian Republic	I	Euro	EUR
Ireland	Ireland	IRL	Euro	EUR
Luxembourg	Grand Duchy of Luxembourg	L	Euro	EUR
Netherlands	Kingdom of the Netherlands	NL	Euro	EUR
Portugal	Portuguese Republic	P	Euro	EUR
Sweden	Kingdom of Sweden	S	Swedish krona (pl. kronor)	SEK
United Kingdom	United Kingdom of Great Britain and Northern Ireland	UK	pounds sterling	GBP
<p>1. Former Currencies (pre-euro)</p> <ul style="list-style-type: none"> ▪ Austria - Austrian schilling (ATS) ▪ Belgium - Belgian franc (BEF) ▪ Germany - German mark (DEM) ▪ Spain - Spanish peseta (ESP) ▪ Greece - Greek drachma, pl drachmae (GRD) ▪ France - French franc (FRF) ▪ Finland - Finnish markka, pl. markkaa (FIM) ▪ Italy - Italian lira, pl. lire (ITL) ▪ Ireland - Irish pound (punt) (IEP) ▪ Luxembourg - Luxembourg franc (LUF) ▪ Netherlands - Dutch Guilder (NLG) ▪ Portugal - Portuguese escudo (PTE) <p>2. ISO 4217, as recommended by Secretariat-General (SEC(96) 1820).</p> <p>3. List of countries (Situation at 26.6.2002)</p>				

3. NEW MEMBER STATES (2004)

Short Name	Full Name	Country ISO Code ¹	Currency	Currency ISO Code ²
Cyprus	Republic of Cyprus	CY	Cyprus pound	CYP
Czech Republic	Czech Republic	CZ	Czech koruna (pl. koruny)	CZK
Estonia	Republic of Estonia	EE	Estonian kroon (pl. krooni)	EEK
Hungary	Republic of Hungary	HU	forint (inv.)	HUF
Latvia	Republic of Latvia	LV	lats (pl. lati)	LVL
Lithuania	Republic of Lithuania	LT	litas (pl. litai)	LTL
Malta	Republic of Malta	MT	Maltese lira	MTL
Poland	Republic of Poland	PL	Zloty	PLN
Slovakia	Slovak Republic	SK	Slovak koruna (pl. koruny)	SKK
Slovenia	Republic of Slovenia	SI	Tolar	SIT

4. SOME OTHER COUNTRIES

Short Name	Full Name	Country ISO Code ¹	Currency	Currency ISO Code ²
Australia	Commonwealth of Australia	AU	Australian dollar	AUD
Bulgaria	Republic of Bulgaria	BG	lev (pl. leva)	BGN
Canada	Canada	CA	Canadian dollar	CAD
Iceland	Republic of Iceland	IS	Icelandic krona (pl. kronur)	ISK
Japan	Japan	JP	yen (inv.)	JPY
New Zealand	New Zealand	NZ	New Zealand dollar	NZD
Norway	Kingdom of Norway	NO	Norwegian krone (pl. kroner)	NOK
Romania	Romania	RO	Romanian leu (pl. lei)	ROL
Russia	Russian Federation	RU	new rouble; Russian rouble	RUB; RUR
Switzerland	Swiss Confederation	CH	Swiss franc	CHF
Turkey	Republic of Turkey	TR	Turkish lira	TRL
United States	United States of America	US	US dollar	USD
1. ISO 3166				
2. ISO 4217				

5. LIST OF CHEMICAL ELEMENTS

NAME	SYMBOL	NAME	SYMBOL
Actinium	Ac	Mercury	Hg
Aluminum	Al	Molybdenum	Mo
Americium	Am	Neodymium	Nd
Antimony	Sb	Neon	Ne
Argon	Ar	Neptunium	Np
Arsenic	As	Nickel	Ni
Astatine	At	Niobium	Nb
Barium	Ba	Nitrogen	N
Berkelium	Bk	Nobelium	No
Beryllium	Be	Osmium	Os
Bismuth	Bi	Oxygen	O
Boron	B	Palladium	Pd
Bromine	Br	Phosphorus	P
Cadmium	Cd	Platinum	Pt
Calcium	Ca	Plutonium	Pu
Californium	Cf	Polonium	Po
Carbon	C	Potassium	K
Cerium	Ce	Praseodymium	Pr
Cesium	Cs	Promethium	Pm
Chlorine	Cl	Protactinium	Pa
Chromium	Cr	Radium	Ra
Cobalt	Co	Radon	Rn
Copper	Cu	Rhenium	Re
Curium	Cm	Rhodium	Rh
Dysprosium	Dy	Rubidium	Rb
Einsteinium	Es	Ruthenium	Ru
Erbium	Er	Rutherfordium	Rf
Europium	Eu	Samarium	Sm
Fermium	Fm	Scandium	Sc
Fluorine	F	Selenium	Se
Francium	Fr	Silicon	Si
Gadolinium	Gd	Silver	Ag
Gallium	Ga	Sodium	Na
Germanium	Ge	Strontium	Sr
Gold	Au	Sulphur	S
Hafnium	Hf	Tantalum	Ta
Helium	He	Technetium	Tc
Holmium	Ho	Tellurium	Te
Hydrogen	H	Terbium	Tb
Indium	In	Thallium	Tl
Iodine	I	Thorium	Th
Iridium	Ir	Thulium	Tm
Iron	Fe	Tin	Sn
Krypton	Kr	Titanium	Ti
Lanthanum	La	Tungsten	W
Lawrencium	Lr	Uranium	U
Lead	Pb	Vanadium	V
Lithium	Li	Xenon	Xe
Lutetium	Lu	Ytterbium	Yb
Magnesium	Mg	Yttrium	Y
Manganese	Mn	Zinc	Zn
Mendelevium	Md	Zirconium	Zr

6. SI UNIT PREFIXES

Symbol	Prefix	Term	Number
Y	yotta	10^{24}	1 000 000 000 000 000 000 000 000
Z	zeta	10^{21}	1 000 000 000 000 000 000 000
E	exa	10^{18}	1 000 000 000 000 000 000
P	peta	10^{15}	1 000 000 000 000 000
T	tera	10^{12}	1 000 000 000 000
G	giga	10^9	1 000 000 000
M	mega	10^6	1 000 000
k	kilo	10^3	1000
h	hecto	10^2	100
da	deca	10^1	10
-----	-----	1 unit	1
d	deci	10^{-1}	0.1
c	centi	10^{-2}	0.01
m	milli	10^{-3}	0.001
μ	micro	10^{-6}	0.000 001
n	nano	10^{-9}	0.000 000 001
p	pico	10^{-12}	0.000 000 000 001
f	femto	10^{-15}	0.000 000 000 000 001
a	atto	10^{-18}	0.000 000 000 000 000 001
z	zepto	10^{-21}	0.000 000 000 000 000 000 001
y	yocto	10^{-24}	0.000 000 000 000 000 000 000 001

ANNEXES

Annex 1

Cyanide chemistry

This section provides a brief overview of the chemistry of cyanide. Cyanide chemistry is complex, and those seeking more detailed information should consult the list of reference materials found at www.cyanidecode.org.

Cyanide Species

The term cyanide refers to a singularly charged anion consisting of one carbon atom and one nitrogen atom joined with a triple bond, CN. The most toxic form of cyanide is free cyanide, which includes the cyanide anion itself and hydrogen cyanide, HCN, either in the gaseous or aqueous phase. At a pH of 9.3 - 9.5, CN and HCN are in equilibrium, with equal amounts of each present. At a pH of 11, over 99 % of the cyanide remains in solution as CN, while at pH 7, over 99 % of the cyanide will exist as HCN. Although HCN is highly soluble in water, its solubility decreases with increased temperature and under highly saline conditions. Both HCN gas and liquid are colourless and have the odour of bitter almonds, although not all individuals can detect the odour.

Cyanide is very reactive, forming simple salts with alkali earth cations and ionic complexes of varying strengths with numerous metals. The stability of these salts is dependent on the cation and the pH. The salts of sodium, potassium and calcium are highly soluble in water, and since they readily dissolve to form free cyanide, they are quite toxic themselves. Operations typically receive cyanide as solid or dissolved NaCN or Ca(CN)₂. Weak or moderately stable complexes such as those of cadmium, copper and zinc are classified as weak-acid dissociable (WAD), with equal concentrations of the complex and of its component metal and cyanide ions existing at a pH of approximately 4.0. Although metal-cyanide complexes themselves are less toxic than free cyanide, their dissociation releases free cyanide. Even in the neutral pH range of most surface water, WAD metal-cyanide complexes are sufficiently soluble so as to be environmentally significant.

The differing stabilities of various cyanide salts and complexes under varying pH conditions results in different potential environmental impacts and interactions with regard to their acute or chronic effects, attenuation and re-release. Cyanide forms complexes with gold, mercury, cobalt and iron that are very stable under mildly acidic conditions. However, both ferro- and ferricyanides release free cyanide when exposed to direct ultraviolet light in the presence of water.

Cyanide-metal species also form complexes with alkali or metalliferous cations, such as potassium ferricyanide (K₃Fe(CN)₆) or copper ferricyanide Cu₃(Fe(CN)₆)₂. The solubility of these complexes varies with the metal cyanide and the cation. Nearly all alkali salts of iron cyanates are very soluble, and if one of these double salts does dissociate to the cation and the cyanide-metal complex, the complex itself may then further dissociate to produce free cyanide. Heavy metal salts of iron cyanides form insoluble precipitates.

The cyanide ion also combines with sulphur to form thiocyanate, SCN. Thiocyanate dissociates under weakly acidic conditions, but is typically not considered to be a WAD species because it has similar complexing properties as cyanide itself. Thiocyanate is chemically and biologically oxidised to carbonate, sulphate and ammonia.

The oxidation of cyanide, either by natural processes or from treatment of effluents containing cyanide, can produce cyanate, OCN. Cyanate is less toxic than HCN, and readily hydrolyses to ammonia and carbon dioxide.

Cyanidation

The process of extracting gold from ore with cyanide is called cyanidation. The reaction, known as Elsner's equation, is:

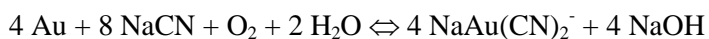

Although the affinity of cyanide for gold is such that it is extracted preferentially, cyanide will also form complexes with other metals from the ore, including copper, iron and zinc. The formation of strongly bound complexes such as those with iron and copper will tie up cyanide that would otherwise be available to dissolve gold.

Copper cyanides are moderately stable, and their formation can be a cause of both operational and environmental concerns. High copper concentrations in the ore increase costs and lower recovery efficiencies by requiring higher cyanide application rates to compensate for the reagent that complexes with copper rather than gold. The process water or tailings from such an operation can have significantly higher cyanide concentrations than would otherwise be present in the absence of copper.

Cyanidation is also adversely affected by the presence of free sulphur or sulphide minerals in the ore. Cyanide will preferentially leach sulphide minerals, and will react with sulphur to produce thiocyanate. These reactions will also enhance the oxidation of reduced sulphur species, lowering the solution pH and volatilising HCN.

Sampling and analytical methods from the CN Code

This text provides general background information on the sampling and analysis of the various forms of cyanide in aqueous samples at gold mining operations. It is not intended to be an all-inclusive reference for cyanide sampling or analysis.

General information

This text places emphasis on proven and reliable methods used globally for the monitoring of process solutions and environmental compliance at gold mining operations. Other analytical procedures do exist for the measurement of cyanide that are capable of generating acceptable results; these alternative procedures can be substituted for the traditional methods included in this document.

The mining industry, regulators and most service laboratories generally use the following guidelines for cyanide species.

Free Cyanide (CN_F)

Only hydrogen cyanide and the cyanide ion in solution can be classed as "free" cyanide. The proportions of HCN and CN⁻ in solution are determined according to their equilibrium equation; this is influenced by the solution pH. For the analysis of free cyanide, the methods used:

- should not alter the stability of weaker cyanide complexes, as they may otherwise be included in the free cyanide result
- should be clear of interferences due to the presence of high concentrations of more stable cyanide complexes or other cyanide forms. If not, the interference must be quantified and allowed for in the result.

Weak Acid Dissociable Cyanide (WAD - CN)

Unlike the definition of "free cyanide" which identifies the specific cyanide species being measured, WAD cyanide refers to those cyanide species measured by specific analytical techniques. WAD cyanide includes those cyanide species liberated at moderate pH of 4.5, such as HCN(aq) and CN⁻, the majority of Cu, Cd, Ni, Zn, Ag complexes and others with similar low dissociation constants. For the analysis of WAD cyanide, the methods used:

- should be free from interferences due to the presence of high concentrations of more stable cyanide complexes or other cyanide forms. If not, the interference must be quantified and allowed for in the result.

Total Cyanide (CN_T)

This measurement of cyanide includes all free cyanide, all dissociable cyanide complexes and all strong metal cyanide including ferro-cyanide Fe(CN)₆⁻⁴, ferri-cyanide Fe(CN)₆⁻³, and portions of hexacyano cobaltate Co(CN)₆⁻³, as well as those of gold and platinum. Only the related or derived compounds cyanate (CNO⁻) and thiocyanate (SCN⁻) are excluded from the definition of total cyanide. For the analysis of total cyanide, the method used:

- must be shown to be capable of quantitatively determining all stable complexes of cyanide, including the cobalt cyanide complex. If methods determine other analytes as well (e.g. SCN⁻), those analytes need to be determined separately and allowed for in the total result.

Sampling

The importance of sampling and sample handling, prior to delivery to the laboratory, is summarised by the following statement.

The results of analysis can be no better than the sample on which it was performed.

While the taking of either aqueous or solid samples may appear easy, the collection of correct samples, both in terms of location and with respect to the analytes to be monitored, is fraught with difficulties. Any sampling must have as its aim the collection of a representative portion of the substance to be analysed. When this portion is presented for analysis, the parameters to be determined must be present in the same concentration and chemical or biological form as found in the original environment from which the portion was removed.

Samples representative of a site, or of a portion of a site, provide information that is often extrapolated to include the whole area under investigation. This is true whether the entity being sampled is a contaminated section of land, surface water, an industrial outfall, or a drum containing waste material. Therefore, samples must be representative of the specific entity being sampled, but not necessarily representative of the entire area of which it is part.

The overall objectives of a sampling programme must be considered in the development of the sampling plan. Sampling may be performed for one of several purposes:

- to determine the maximum, minimum and average values for a near steady state stream, with the aim of monitoring compliance versus set specifications (process control, environmental criteria). Such data can illustrate the likelihood and magnitude of occurring non-compliance provided enough data points have been analysed from the samples. Process, residue, and effluent stream analyses could have this type of objective. Even aquifer sampling (boreholes) would fit this description. Often the relative mass-flows have to be known for proper data integration
- to determine the maximum, minimum and average values from the analysis of "batch streams" such as treated backfill portions or detoxified waste batches, which usually require a minimum of one data point per batch to insure a representative sample. The major objective remains one of compliance and/or verification of effective management procedures for the batch streams involved.

Additionally the following issues need to be taken into consideration:

1. non-steady state events following a cyclic pattern are often influenced by several parameters, and these parameters in themselves may also be susceptible to cyclic changes. In other words, these confounding factors create a complex situation that requires careful analysis and planning to obtain a representative sample

2. the cycle periods have to be known along with many other factors of influence in the "system". A typical example would be the sampling of tailings surface liquid (or solids), decant liquids or return dam bulk liquid. All of these "sample populations" undergo massive cyclic fluctuations through influence of chemical and physical changes from process management tailings surface events and seasonal climatic conditions
3. it will be apparent that the cycle periods are not in any way synchronised and hence seemingly random data might be obtained. An objective for such sampling campaigns could be the establishment of a predictions database based on the understanding of the fundamental principles. This means that a complete, non-biased sampling effort across the longest cycle needs to be performed at least once. Alternatively, once such principles are known, selected samples taken at certain times could be analysed for monitoring purposes.

While many sampling strategies may be developed, the main, basic approaches to sampling are depicted in the following table.

Approach	Number of samples	Relative bias potential	Basis of site selection
Judgemental	Small	Very large	Prior history, visual assessment, and/or technical judgment
Systematic	Large	Small	Consistent grid or pattern
Random	Very large	Very small	Simple random selection

Table Annex 1.1: Basic sampling approaches

Sample Preservation

Once samples are removed from their natural environment, chemical or biological reactions can occur which change the composition of the sample, so it is best to analyse the sample as quickly as possible. Preservation of the sample will keep the parameter of interest in the same form as it was prior to the removal from its surroundings. No single preservation technique will preserve all parameters, so each parameter of interest must be considered and preserved specifically.

While most soil samples require exclusion of light, air and warmth to preserve the integrity of the sample, aqueous samples require a more concerted effort. Samples of aqueous cyanide species are potentially very reactive and toxic, so safety precautions such as gloves and protective clothing must be rigorously observed. Due to their reactivity, sample solutions must be tested on site prior to cyanide analysis to preserve them against the main interfering substances, oxidising matter and sulphides.

The presence of oxidising matter is detected by potassium iodide/starch test papers. Whereby a drop of the sample is placed on a moist test paper strip; a blue colouration of the test paper indicates the presence of sufficient oxidising matter to potentially react with the cyanide present during transport. Oxidising agents must be reduced prior to sending the sample to the laboratory.

Procedure for removing the oxidising matter:

1. remove and retain any solids by decantation or pressure filtration
2. add sodium arsenite and mix. About 0.1 g/l is usually sufficient
3. retest, and if test strip is discolored, retreat as per Step 2
4. return solids to sample solution and raise pH to 12 by adding 1 - 2 pellets of solid sodium hydroxide.

The presence of sulphides is indicated by lead acetate paper turning black, whereby a drop of the sample is placed on the test paper previously moistened with a drop of acetic acid and if the paper darkens, sulphides are indicated. Sulphides are removed by reaction with lead carbonate.

Procedure for removing the sulphides

1. remove any solids by decantation or pressure filtration and hold
2. add lead carbonate (about 0.1 g/l) and mix
3. remove formed lead sulphide by pressure filtration and discard PbS precipitate
4. retest sample solution. If test strip is discolored, retreat as in Steps 2 and 3
5. return solids to sample and raise pH to 12 with solid sodium hydroxide.

Samples should be stored in a dark place at about 4 °C, such as in an esky (cool box) during transport and then refrigerated at the laboratory. Soil samples for cyanide analysis (in cores or jars) must be wrapped in dark plastic and kept cool at 4 °C without further treatment.

Transport and storage

Once correctly preserved and packaged, samples should be sealed and each container (bottle or jar) individually placed in a sealed plastic bag. All samples should then be packed in an esky (cool box with some ice bricks) to keep them cool during transport. Shipment to the analytical laboratory should occur as soon as practical by overnight truck or airfreight courier. It is essential that the sampling protocol be recorded and a chain of custody included with the shipment to allow tracking prior to and during storage and analysis.

Analytical Procedures

A quality laboratory with necessary technician experience can achieve good results with many different methods. The modified automated SFAA method using the McLeod microstill may be the method of choice for the most advanced laboratories, however global uniformity, availability and cost factors indicate that the analytical methods listed as “Primary” in the following table may be used.

Analyte	Method	Comments
Free cyanide	AgNO ₃ titration	Preferred method For process solutions primarily above 1 mg/l LQL ¹ : 1 mg/l HCN(aq), CN ⁻ , Zn(CN) _x , parts of Cu(CN) ₄
	AgNO ₃ titration with potentiometric endpoint determination	Alternate method Precise method of endpoint determination Measures same species as primary method
	Micro diffusion of HCN from static sample into NaOH (ASTM D4282)	Alternate method Close to "free cyanide"
	Ion Selective Electrode	Alternate method Close to "free cyanide"
	Direct colorimetry	Alternate method HCN(aq), CN ⁻ , Zn(CN) _x , parts of Cu(CN) ₄ + ?
	Amperometric determination	Alternate method Measures same species as primary method
WAD cyanide	Manual distillation pH 4.5 + potentiometric or colorimetric finish (ISO/DIS 6703/2, DIN 38405 Part 13.2: 1981-02)	Preferred method LQL ¹ : 0.05 mg/l HCN(aq), CN ⁻ , Zn/Cd/Cu/Ni/Ag(CN) _x Better results than ASTM method in presence of high copper concentration
	Amenable to chlorination (CN Total - non-chlorinatable part) (ASTM D2036-B, US-EPA 9010)	Alternate method Measures same species as primary method
	SFIA in-line micro-distillation pH 4.5 + colorimetric finish (ASTM D4374)	Alternate method Measures same species as primary method
	FIA In-line ligand exchange + amperometric finish (US-EPA OIA-1677)	Alternate method Measures same species as primary method
	Picric Acid, Colorimetric determination	Alternate method Measures same species as primary method
	Total cyanide	Manual batch distillation + titration/potentiometric or colorimetric finish (ISO/DIS 6703/1, DIN 38405 Part 13.1: 1981-02)
SFIA, in-line UV irradiation, micro-distillation + colorimetric finish (ASTM D4374)		Alternate method Measures same species as primary method

1: LQL, Lower Quantitation Level, is defined as about 3 times Detection Level or 10 times the Standard Deviation at near blank level.

Table Annex 1.2: Primary and alternate analytical methods

For these primary methods, the table also provides a Lower Quantification Level, representing the concentration that all laboratories should be able to reliably determine. Laboratories with a proven record of working with alternative methods, such as those based on automated standard methods, should be encouraged to continue with those methods but should establish crossreferences for each site by applying the suggested methods.

To insure that the mine receives quality analytical service, the chosen laboratory must:

- use experienced staff to perform the analyses
- be certified by the respective national accreditation body for all analytical methods
- have sound quality control procedures in place
- be able to prove the quality of their data by participation in proficiency tests.

Trained analysts and supervisory staff with an expertise in cyanide chemistry methods are critical to consistent and reliable results, as they will be aware of the potential interferences inherent in each method.

The preferred methods for analytical determination of the different types of cyanide are briefly summarised below:

Free cyanide

The preferred method for the analytical determination of free cyanide is silver nitrate titration. Silver ions are added to the solution to complex the free cyanide ions. When all free cyanide is consumed as silver cyanide complex, the excess silver ions indicate the endpoint of the titration. The analytical equipment used for the titration is rather simple. To accurately determine the cyanide concentration, a normalised silver nitrate solution is dosed with a manual or automatic burette, which should be capable of measuring volumes to an accuracy of better than 0.005 ml. Several techniques can be used for the endpoint determination. The easiest possibility is to use an indicator such as potassium iodide or rhodanine that changes colour upon the appearance of free silver ions. It is important that the first colour change is used as the endpoint indication because the silver ions tend to liberate cyanide ions from other complexes, which leads to a disappearance of the colour. The potentiometric endpoint detection is a more accurate way to determine the endpoint as a more easily identified peak signal is produced.

'Weak Acid Dissociable' cyanide (WAD-CN)

The preferred analytical method to determine weak acid dissociable cyanide is the distillation method according to ASTM or ISO/DIS. These methods create chemical conditions which allow the WAD-CN to be liberated as dissolved hydrogen cyanide gas which is then carried in an air stream to a caustic soda absorption where the WAD-CN appears as CNF. As the hydrogen cyanide is adsorbed in a much smaller volume than the original sample solution, the CNF concentration to be analysed is typically at least 10 times higher than the original WAD-CN concentration in the sample solution. The CN_F concentration in the distillation product sample is then determined using silver nitrate titration as described above.

The methods according to ASTM and ISO/DIS are similar. However, the results from ISO/DIS method are more accurate than those from the ASTM method for samples containing a high concentration of copper cyanide.

Total Cyanide

The preferred analytical method to determine total cyanide is the distillation method according to ASTM or ISO/DIS. The applied method is in principle very similar to the distillation method described for weak acid dissociable cyanide. However, strongly acidic conditions and elevated temperatures are required to liberate the cyanide ion from the stable cyanide complexes such as ferri- and ferrocyanides.

Complete descriptions of these analytical procedures can be found in the following references: DIN 38405-13: 1981-02, German Standard Methods for the Analysis of Water, Waste Water and Sludge - Anions (Group D) - Determination of Cyanides (D13), German Standards (DIN Normen, Beuth Verlag GmbH, Burggrafenstr. 6, 10787 Berlin/Germany).

South African Water Quality Guidelines, Volumes 1 - 7, Department of Water Affairs and Forestry, 1996.

Standard Methods For The Examination Of Waters and Wastewater, APHA-AWWA-WEF, 20th Edition, Washington DC, 1998.

Water Quality - Determination of Cyanide - Part 1: Determination of Total Cyanide ISO/DIS 6703/1, International Organization of Standardization.

Water Quality - Determination of Cyanide - Part 2: Determination of Easy Liberated Cyanide ISO/DIS 6703/2, International Organization of Standardization.

USEPA “Methods and Guidance for Analysis of Water”, United States Environmental Protection Agency (USEPA), June 1999.

Annex 2

In this annex, several dam failures are described. The descriptions provide useful suggestions for the safe management of tailings management facilities.

The Aitik dam failure

On the night of September 8, 2000, a dam failure occurred at the Aitik site. The failure took place in a section of the dam which separated the tailings pond from the downstream clarification pond. The event led to the discharge of 2.5 Mm³ of water from the tailings pond section into the clarification pond. The subsequent rise of the water level in the clarification pond, 1.3 m, caused a discharge of 1.5 Mm³ clarified water into the receiving streams. This resulted in a temporary rise of the suspended solids content in the river system downstream.

The event occurred in spite of manual and automatic monitoring systems in accordance with a recently developed OSM-manual.

Two theories to explain this event have been developed:

According to the first theory, the filter layers in the dam were not performing properly, so that the pore pressure within the pond increased causing erosion or sliding failures in the support fill, eventually resulting in a complete dam failure. Detrimental leaks with elevated pore pressure as a result may also have occurred:

- along the discharge culvert through the dam
- through the narrow upper section of the impermeable core
- underneath the sheet pile at the culvert
- through cracks in the bedrock
- from the right side of the breach.

According to the second theory, inner erosion occurred along the discharge culvert, possibly in combination with openings in the joints between culvert elements and/or collapse of the culvert. Break-in of water and soil to the culvert, probably caused a sinkhole in the dam with flow directly from the pond into the culvert. The failure escalated and ended with overtopping of the dam and, eventually, a complete failure.

It will probably not be possible to fully eliminate one theory in favour of the other, mainly because the dam was completely eroded away. The operator, however, interprets the results as leakage in connection with the culvert being the main cause of the failure. The reasons for this conclusion are:

- the culvert was founded on gravel, 16 – 50 mm, and at the last reconstruction covered by filter cloth. Leaks through joints and/or in the gravel have occurred which is proven by investigations after the accident, when tailings were found, that did originate from the accident
- the culvert was not equipped with a longitudinal reinforcement, and could therefore not withstand tension.

In addition, some conditions indicate that high pore pressure was not the main cause:

- as late as the evening before the failure, no visible leaks could be observed along the toe of dam E-F extension. This indicates that the failure occurred rapidly
- calculations show that before the accident the dam had a safety factor exceeding 1 even at increased pore pressure.

The operator has therefore concluded that leaks and/or collapse of the culvert were the most likely causes of the accident. However, it cannot be ruled out, that also increased pore pressure caused by deficient filter function may have contributed to the accident. [63, Base metals group, 2002]

One consequence of this accident is that a more stable culvert has been constructed, which will in the future be replaced by an overflow system built around the dam in natural rock. Future dams will be built with two filter layers, one coarse and the other fine.

The Aznalcollar dam failure

The Aznalcollar event has been described in many places. Here only the main causes for the failure and the conclusions will be described.

On the night between April 24 and 25, 1998, a 600 m section of the downstream dam of the tailings pond suddenly slid up to 60 m. The slide created a breach in the dam through which water and tailings were flushed out. In a few hours, 5.5 Mm³ of acid and metal rich water flowed out of the pond. The amount of tailings that was spilled has been estimated to be between 1.3 and 1.9 million tonnes. Due to the fine particle size of the tailings ($d_{80} < 45 \mu\text{m}$) they were easily transported in suspension with the flood wave.

The direct cause of the accident was a fault in the marls 14 m below the ground surface (see figure below). This fault was the result of surplus pressure in the interstitial water of the clay due to the weight of the dam and the tailings deposit. [68, Eriksson, 2000]

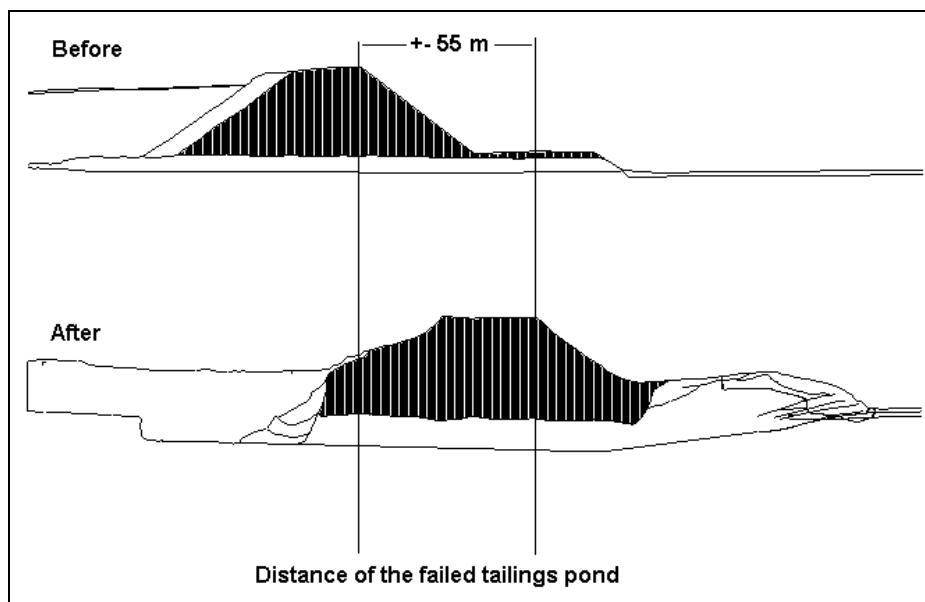

Figure Annex 2.1: Cross-section of the tailings dam
[68, Eriksson, 2000]

One of the conclusions from investigations of this incident was that a good baseline study, conducted before the accident, would have significantly facilitated the evaluation of the effects of the accident [68, Eriksson, 2000]. Another conclusion that can be drawn is that a close and thorough investigation of a TMF's foundation needs to be prepared and evaluated prior to the dam construction.

Further examples

There were many examples of impoundments retained by dams built by the upstream method at the copper mines in Chile. That country is subject to earthquakes and failures were not uncommon. A well known example is that of the El Cobre old dam, built to a height of 33 m between 1930 and 1963, with a downstream slope of 1 on 1.2 to 1.4. Two years after its construction stopped, the area was struck by the 1965 La Ligua earthquake, which occurred during daylight. Eye witnesses said dust clouds came up from the dam, obstructing it from view as it failed, releasing the liquefied tailings to flow down the valley, engulfing the miners' village and continuing for a further 5 km. Many lives were lost. This failure and others in Chile, have been described by Dobry and Alvarez (1967).

The release of dust is typical of the failure of dry loess slopes and is caused by the volume reduction on shearing that occurs in loose particulate materials. Air from the voids is expelled, carrying dust with it. The downstream face of the dam had clearly been relatively dry before it disintegrated allowing the release of all the unconsolidated tailings slurry.

In Japan, the Mochikoshi impoundment was being built in a hollow near the top of a hill to store gold mine tailings and was retained by three tailings dams. These were being built by the upstream method from very sound starter dams made from the local volcanic soil. The dams were raised by building dykes from the volcanic soil placed on the beach and compacted. The impoundment was subjected to a ground acceleration of 0.25g from the Iso-Oshima earthquake of magnitude 7.0 that occurred on 14th January 1978. The highest of the three dams failed during the main shock, releasing 80000 m³ of tailings contaminated by sodium cyanide through a breach 73 m wide and 14 m deep. The tailings flowed 30 km and into the Pacific Ocean. The second highest dam failed next day, 5 hrs. 20 mins. after an aftershock, releasing a further two to three thousand cubic m of tailings through a breach 55 m wide and 12 m deep. These and other earthquake related failures led to recommendations that the downstream method of construction should be used in earthquake areas, rather than the upstream method. In this method, coarse material, possibly from cyclones, is placed on the downstream part of the dam where effective drainage measures can be employed and the fill can be compacted. Alternatively the dam can be built from borrowed fill, as with water retaining dams.

Stava

At 12.23 on 19th July 1985, two tailings dams, one above the other and both built by the upstream method, collapsed. A total quantity of 190000 m³ of tailings slurry was released and flowed, initially at a speed of 30 km/hr down into the narrow, steep sided valley of the Rio Stava, demolishing much of the nearby small village of Stava and continued, at increasing speed, estimated to have been 60 km/hr to another small town, Tesero about 4 km downstream, at its junction with the Avisio River in northern Italy. (The only surviving eye-witness, a holiday maker, had the horrifying experience of watching the disaster from the hillside and saw the hotel where his family were taking lunch being swept away by the torrent of tailings.) The damage caused by tailings is very much more than would be caused by the same flood of water, because the tailings are so heavy. Where water could flood a building, tailings can push it over and sweep it along with the flow. This failure caused 269 deaths.

The tailings dams were for a fluoride mine that was begun in 1962 and were sited on a side slope of 1 on 8. The decant was in the form of a concrete culvert laid up the sloping floor, with coverable openings about every 0.5 m vertical rise. Water from the pond decanted into the openings, which were covered, one by one, as the level of the tailings rose. The lower dam was built by the upstream method to a slope of 1 on 1.23. When it reached a height of 19 m, the second dam was begun at the upstream end of the impoundment and built to a slope of 1 on 1.43. When it reached a height of 19 m, further planning consent was required. This was given on the condition that a 5 m wide berm was constructed at that level and permission given for the dam to be built to a height of 35 m. Construction continued at the same slope of 1 on 1.43 and the failure occurred when it was 29 m high. The cause is thought to be due to a combination of blockage and leakage from the culvert under the toe of the upper dam, thereby raising the phreatic surface sufficiently to cause a rotational slip. Six months before the failure, a local slide

occurred in the lower portion of the upper dam on its right side, in the area where the decant pipes pass underneath the dam, due to freezing the service pipe during a period of intense frost, according to Berti et al (1988). For the next three months, water was observed seeping from the area of the slide. A month before the failure, the decant pipe underneath the lower impoundment fractured allowing the free water and liquid mud from the pond to escape towards the Stava river, creating a crater above the point of fracture. A bypass pipe had to be installed through the top portion of the lower dam, and the broken decant pipe blocked to restore use of the system. During this operation the water level in the upper impoundment was lowered as far as possible, then just four days before the failure, both ponds were filled and put back into normal operation. 53 minutes before the failure a power line crossing below the impoundments failed, then only 8 minutes before, a second power line failed. The tailings from the failure reached Tesero about 4 km distance, within a period of 5 to 6 minutes. As a result of this failure, the strict Italian law governing the design and construction of water retaining dams, according to Capuzzo (1990), is being extended to include tailings dams.

Merriespruit

The Virginia No 15 tailings dam had been built by the 'paddock' method that is used extensively in South Africa's gold mining industry. It was a long dam encircling and retaining an impoundment of 154 ha holding $260 \times 10^6 \text{ m}^3$ of gold mine tailings containing cyanide and iron pyrite. The foundation soil was clay and drainage was required under the dams. General experience was that drains were often blocked by iron oxides and other residue. The impoundment formed one of several similar impoundments of the Harmony Gold Mine near Virginia in the Orange Free State. The suburb of Merriespruit containing about 250 houses had been built near the mine in 1956. Virginia No 15 lagoon was begun in 1974 and a straight northern section of the dam nearest the suburb was placed only 300 m from the nearest houses. Dam construction and filling of the lagoon continued until March 1993, when the section of the dam closest to the houses was 31 m high.

The summer of 1993/4 in the Orange Free State had been particularly wet and on the night of Tuesday 22nd February 1994 there were violent thunderstorms over Virginia and a cloudburst when 40 mm of rain fell in a very short time. The water level in the lagoon rose due to direct catchment: there was no stream or other natural source of water that came into the lagoon, which while operational, had a launder system that removed the transportation water decanted from the tailings slurry that had been delivered into the impoundment. During the early evening at about 19.00, water was found running down the streets and through gardens and an eye witness saw water going over the crest of the dam above the houses. The mining company and contractor were informed, but when their representatives reached the site it was already dark. One of the contractor's men rushed to the decants and found water lapping the top rings but not flowing into the decants. He removed several rings to try to get the water flowing, but the main pool was next to the north dam crest with no direct connection to the decants. At the same time, another contractor's man was near the downstream toe of the dam, and saw blocks of tailings toppling from a recently constructed buttress that had been built against a weak part of the dam. An attempt was made to raise the alarm, but before anyone had been contacted, there was a loud bang, followed by a wave of liquefied tailings that rushed from the impoundment into the town.

A breach 50 m wide formed through the dam, releasing $2.5 \times 10^6 \text{ m}^3$ of tailings that flowed for a distance of 1960 m, covering an area of $520 \times 10^3 \text{ m}^2$. The flow passed through the suburb where the power of the very heavy liquefied tailings demolished everything in its path, houses, walls, street furniture and cars, carrying people and furniture with it. (According to newspaper reports, people already in bed at about 21.00 hours when the mudflow struck, found themselves floating in their beds against the ceiling. 400 survivors spent the night in the Virginia Community Hall, a kilometre away. Hetta Williamson said that her husband had gone back in daylight to their former home and found nothing but the foundations.) It is remarkable that only 17 people were killed.

Apparently this north section of the enclosing dam had been showing signs of distress for several years, with water seeping and causing sloughing near the toe. A drained buttress constructed from compacted tailings had been built against a 90 m long section, but continued sloughing had caused the mine to stop putting the normal flow of tailings into the impoundment more than a year before the failure, i.e. the impoundment had been closed. At that time the freeboard was, according to the contractor, a respectable 1 m. But sloughing at the toe continued, and construction of the buttress was continued. Not long before the failure, slips had occurred in the lower downstream slope just above the buttress. In fact, although the placement of tailings had been stopped, waste water containing some tailings continued to be placed and the water overflowed into the two decants. Unfortunately there formed a sufficient deposit of further tailings to cut off the decants and cause the main pool of water to move towards the crest of the north part of the dam, leaving a freeboard of only 0.3 m, and water was still being pumped into the impoundment from the mill on the night of the failure. Evidence of what had been going on since supposed closure was provided by satellite photography. A Landsat satellite passed over the area every 16 days and the infrared images revealed the positions of the tailings and the water pool.

Government Mining Regulations that had come into force in 1976, required a minimum freeboard of 0.5 m to be maintained at all times for this type of impoundment, to enable a 1 in 100 year rainstorm to be safely accommodated without causing overtopping. Evidence of the level of tailings in the Virginia No 15 lagoon showed that the tailings had been brought up to within 15 cms of crest level prior to abandoning this storage in March 1993. Had the government regulations required inspection of the dam, particularly at closure, the very small freeboard would have been noticed and a further raising of the dam crest enforced to prevent overtopping in the event of a maximum probable precipitation.

Baia Mare

The expanding city of Baia Mare in Romania was beginning to encroach on old mining areas where there were disused impoundments of tailings. Removal of these impoundments and their retaining tailings dams would both release valuable land for city development and allow extraction of remaining metals from the old tailings. The scheme at Baia Mare involved construction of a new impoundment and a new efficient processing plant that would accept tailings removed from the old impoundments. Initially three were to be reworked and pipelines were laid out to transmit water from the new impoundment to be used for powerful jets that would cut into the old tailings, producing a slurry that would go to the new processing plant for extraction of remaining metals, with the tailings from it flowing to the new impoundment. The system used the same water going round and round with no interference with the environment.

The site for the new impoundment, well away from the city, was on almost level ground, with its main axis 1.5 km long, sloping down only 7 m from NE to SW with a width of about 0.6 km, as indicated by Fig.3. An outer perimeter bank 2 m high with 1 on 2 side slopes, as shown by Fig.4, was built from old tailings, and the whole area of about 90 ha, lined by HDPE sheet, anchored into the crest of the perimeter bank. Drainage was installed to collect any seepage, that would be pumped back so that there should be no escape of contaminated water into the environment. About 10 m inside the perimeter, starter dams were built, also with 1 on 2 side slopes, to heights of about 5.5 m along the SW lower edge of the impoundment, tapering down to 2 m height about half way along the sides, with the remainder around the NE end of the impoundment, about 2 m high. Cyclones mounted along the crest of the SW starter dam and part way along the side starter dams accepted the tailings piped from the new processing plant, discharging the coarser fraction on to the downstream side to fill the space to the parameter dam, and raise the whole dam, with the main volume of fine tailings slurry being discharged into the impoundment. Collected water was discharged into the central decant, drained through a 450 mm diameter outfall pipe embedded under the HDPE liner and pumped back to operate the monitoring jets in the first of the old impoundments, 6½ km away, and close to the city. Cyanide was used in the new processing plant for the extraction of gold, so that the tailings and water in the new impoundment contained considerable amounts of cyanide. No water should leak from the pipework circuit, although the water used in the cutting jets flowed over the

unlined floor of the old impoundment where it could soak into the ground. First discharge into the impoundment was in March 1999, and during the summer everything worked well, particularly during June, July and August when the average evaporation was 142 mm per month, although the delivered tailings did not contain quite as much coarse material as had been envisaged and the rate of height increase of the dams was lower than intended.

During the winter, however, conditions became greatly changed. The temperature fell below zero on 20 December and remained low during most of January, freezing the cyclones and producing a layer of ice over the impoundment, which became covered by snow. Tailings from the processing plant was warm enough to keep the operation working, but there was no further height increase for the dams because the cyclones were out of action. Precipitation during September to January averaged 71 mm per month and fell as rain and snow on both the whole area of the impoundment but also on the old tailings impoundments that were being worked. This extra water was stored in the impoundment causing the level to rise under the now thick layer of ice and snow.

On 27th January there was a marked change in the weather. The temperature rose above zero and there was a fall of 37 mm of rain. The ice and snow covering melted and the dams, half way along the sides of the impoundment, where they were only starter height, were lower than the developing water level. At 22.00 hours on 30th January 2000, a section overtopped, washing out a breach 25 m long that allowed the escape of about 100000 m³ of heavily contaminated water that flowed following the natural slope of the area, towards the river Lopus. This in turn fed into the rivers Somes, Tisa and Danube, eventually discharging into the Black Sea. A very large number of fish were killed with serious consequences for the fishing industry for a time. The Hungarian authorities estimated the total fish kill to have been in excess of one thousand tonnes. Water intakes from the rivers had to be closed until the plume of toxic contaminate had passed and for some time afterwards until the purity of the water could be confirmed. The cyanide plume was measurable at the Danube delta, four weeks later and 2000 km from the spill source.

The concept of a closed system in which none of the process water should escape into the environment should have been excellent, with the new tailings impoundment completely lined with plastic sheeting and provision for the collection of any seepage. Unfortunately no provision had been made for the additional water that would accrue from precipitation, nor had the problems of working at low temperatures been addressed. The scheme was one that could have worked well in the hot and dry conditions found in some parts of Australia and South Africa.

Annex 3

Example of aspects covered by a baseline study

The following sub-sections provide an example of a baseline study for a tailings pond recently performed in Europe [25, Lisheen, 1995]. These studies have become a standard procedure and are often a legal requirement. They are necessary as a point of reference in order to quantify the impact of an operation.

Archaeology and local history/cultural patrimony

This section of the baseline study investigates whether archaeological findings can be expected based on historical information. It gives answers to the questions whether any important findings may be inhibited or even promoted by a new development. From the perspective of the operator repeated archaeological findings can significantly slow down the development of a site. There may be public concern about the loss of archaeologically significant sites but many authorities will accept their preservation by professional excavation and published record.

Socio-economic

The level of employment is considered and trends for the future are discussed briefly. Major sources of employment are listed. Hence predictions can be made of the prosperity of the investigated area for the future.

Health

The typical lifestyle (e.g. eating habits) in the region is examined, mortality rates are listed and compared to “average” conditions (e.g. country/world average) and the possible reasons for abnormal findings discussed.

Infrastructure

This section describes the road, railway, shipping and airway situation. Furthermore the access to water and electricity is described. This section may also mention the waste collection in the area.

Traffic

Local traffic situation is quantified. Traffic flow compared to other areas or country average may be investigated.

Climatology

Data such as annual rainfall, prevailing winds (strength and predominant direction), humidity and air and soil temperatures are presented. If useful, these figures may be compared to other regions.

Air quality

The results of a baseline sampling programme are presented here. The levels measured are shown and the origins determined. The values measured include total dust and metals.

Geology

This part describes the geology of the mineral deposit and the nearby area. It usually includes:

- deposit depth
- strata dip
- mineral assemblage
- dimensions of the deposit
- mineable resources
- description of topsoil, overburden, bed and waste-rock.

Landscape

The countryside of the study area is described here. Will the site be in the mountains or on flat pastureland? Are there many trees and/or hedges? The visual impact of the new development may be mentioned in this context.

Ecology

This section describes, e.g.:

- the soil of the area
- woodlands of interest
- species in the habitats studied
- diversity of herbs and woods
- plant species
- diversity of birds and mammals
- any special ecological designations near the site.

Noise

Day and night time noise levels, measured for the study are often listed as 12 hour averages.

Soils and soil suitability

The overall quality of soils must be investigated in the area possibly effected by the development and compared to other areas. The field survey includes soil characteristics, quality and suitability for grassland and crop and stock production. In the UK, the assessment of soils is undertaken by a recognised system for evaluating the characteristics and quality of soils, i.e. the Agricultural Land Classification System.

Soil and herbage sampling

This section investigates the soil fertility status of the area. It includes the measurements of trace elements (i.e. magnesium, copper, molybdenum, manganese, cobalt, zinc, lead, cadmium) and other nutrient elements such as phosphorus, nitrogen, potassium, calcium, sulphur, iodine, selenium. These values are compared to other areas and anomalies are analysed. Special attention is dedicated to establish baseline levels of any constituents that may be altered by a future mining operation.

Crop and animal production

Surrounding farms are examined for the productivity of their field crop and grassland. Their types numbers and conditions of livestock are examined at the same time. A recognised methodology is needed for evaluating the cropping and livestock systems in the area which takes account of variables such as farm management skills, level of fixed costs, inputs and agricultural land classification. Comparison of yields without taking these other factors into account would be misleading.

Soil moisture

The purpose of this part of the study is to address the concern that dewatering of a mine may adversely affect the growth of crops and other aboveground vegetation including scrubs and trees. To achieve this a survey on the movement of water in soils and the possible relationship between the depth of the watertable and the soil water balance may be carried out.

Veterinary

Within an appropriate area herds are surveyed for trace elements and other important elements in blood silage and milk. Also a 12 month animal health survey may be part of this section.

Hydrogeology

All factors influencing groundwater flow should be mentioned here, including aquifer/aquitard systems, faults and fault zones as well as any other geological features influencing groundwater flow. The existence of hydraulic barriers and hydraulic conduits should be discussed. Other issues mentioned in this section may be groundwater levels and transmissivity (hydraulic conductivity x thickness).

Groundwater quality

This part of the study analyses the groundwater chemistry. The water is typically sampled in wells and piezometers. If contaminated groundwater is found, the possible source of the contamination should be identified (e.g., agricultural practices, other industrial activities, etc.).

Surface water quality

The results from a baseline surface water sampling programme are presented here. The sampling points should be selected to provide a baseline for what part of the catchment area may potentially be affected by discharges from the proposed development.

Typically, the overall quality of the water is discussed as well as the levels of organic pollution, nutrient and trace metal levels. Possible sources of contamination are identified.

Surface water hydrology

In order to determine the assimilation capacity of the receiving waters, flow data of all surface waters potentially influenced by the project are required. "Knowledge of the surface water hydrological characteristics is also important in establishing the recharge and discharge relationship between the rivers/streams and the groundwater system." [25, Lisheen, 1995]

Fisheries, fish population and spawning

A fish stock assessment in representative sections of the main watercourses within the survey area is part of this section. This assessment includes tissue analysis and density measurements of the existing species. In addition the measures such as the mean redd count (Redds are the nests that mated adult salmon build in the gravel, where they deposit and cover their eggs. A redd count is the number of such nests counted in the river at the end of the spawning season. The number of redds is a good indication of the health of a salmon run) can provided for each of the watercourses as a means of investigating the spawning activities in these rivers.

Surface water flora and macroinvertebrate fauna

Selected plant and macroinvertebrate species may be utilised as indicators of the water quality. To investigate these aquatic ecological surveys and the water chemistry, surveys are carried out. This part of the study should list the flora and macroinvertebrate fauna encountered and the implications of their existence and/or lack of existence.

Annex 4

This Annex gives an overview of used characterisation methods for waste-rock and tailings, however, it is not a complete compilation of all existing methods and does not give sufficient guideline on when to use what method. Therefore, it should be regarded as a compilation of which characterisation methods could be relevant in a specific case. Furthermore, it should be regarded as a starting point for further work in order to arrive at a methodology that can be generally applied and accepted within Europe in order to reach a relevant level of characterisation of all waste-rock and tailings.

Characterisation of tailings and waste-rock samples

A summary of methodologies available for the geotechnical and geochemical characterisation of tailings and waste-rock, and for predicting drainage quality, is presented.

Available methodologies for characterisation of tailings and waste-rock samples

Sampling

To ensure the reliable environmental characterisation of tailings and waste-rock and the design of cost-effective remediation and reclamation schemes, appropriate sample collection and preparation procedures need to be defined. These procedures will depend upon whether the programme is related to the following:

- baseline study
- pre-mine planning
- mine operations
- reclamation/closure plan.

Sampling may involve any of the following:

- point samples: These can be either a single grab sample chosen to represent a single waste deposit, or random samples taken from various source points, generally within a predetermined area
- linear samples: Continuous sampling over an interval in a line such as channel samples, profile sampling of overburden, or throughout boreholes as discrete, disturbed, undisturbed or drillcore samples
- panel samples: These are planar samples made up of multiple chips collected from a surface with dimensions
- bulk samples: Sampling of a large mass of material which will be sectioned and split into fractions with samples taken from these various fractions.

Sampling theory and practice is addressed by Pitard (1993), and sampling methodology specifically related to tailings is given in MEND (1989) and Runnels et al. (1997). Sampling guidelines and protocols are beyond the scope of this report and are not discussed further.

Geotechnical parameters

A range of field and laboratory tests is required for the characterisation of tailings and for potential additives in order to derive an understanding of their likely geotechnical behaviour. Physical and geotechnical properties of tailings may be derived from bulk sampling from the mineral process for prediction and control of the deposition process, or from disturbed/undisturbed samples from as-deposited material. The properties will include grain size, moisture content, specific gravity, sedimentation characteristics, in situ and relative density, permeability, plasticity, compressibility, consolidation, shear strength, and stress parameters. Variations in these properties are all known to affect both the geotechnical and geochemical behaviour of tailings and impact on design, stability and drainage of the impoundment as described in the CLOTADAM Green Paper (Knight Piésold, January 2002).

Due to the importance of the geotechnical characteristics of soils in civil engineering and dam design, a number of standard procedures have been developed. Many of these soil testing standard procedures, which include ISO, CEN, national standards and others, are applicable to tailings. In addition, a number of non-standard test procedures are in use for the determination of specific, tailings-related physical and geotechnical parameters.

Geotechnical testing of tailings can be divided into four generic groups:

- individual sample (single) tests
- combined geotechnical tests
- process specific tests, and
- model specific tests.

The normal suite of laboratory geotechnical testing for basic characterisation of tailings is presented below.

Method	Standards operations procedures
Moisture content	BS 1377-2, ASTM D2216
Specific gravity (Particle density)	BS 1377-2, ASTM D854,
Atterberg limits (plastic and liquid limits)	BS 1377-2, ASTM D4318
Soil classification (hydrometer and sieving)	BS 1377
Proctor (compaction) test	BS 1377-4, ASTM-D698, D1558, D558
Dry density	BS 1377-4, ASTM C127-88
Falling head permeability	KH Head: Procedure 10.7.2, BS 1377-6, ASTM D2434, D5084
Oedometer testing	BS 1377-7, ASTM D 3999

Table Annex 4.1: Geotechnical characterisation of tailings – basic characterisation

Full characterisation of the tailings involves a variety of testwork. Standard test methods and guidelines on available procedures are outlined below.

Geotechnical testing

Geotechnical tests to identify individual parameters for tailings include:

- index testing
- desiccation testing
- permeability testing
- strength testing
- consolidation testing
- settlement testing.

Method	Available standards
<i>Index Testing</i>	
Moisture content	BS 1377-2, ASTM D2216
Specific gravity (particle density)	BS 1377-2, ASTM D854
Atterberg limits (Plastic and liquid limits)	BS 1377-2, ASTM D4318
Grain size distribution	BS 1377-2, ASTM D2487, D422
Proctor (compaction) test	BS 1377-4, ASTM-D698, D1558, D558
Dry density	BS 1377-4, ASTM C127-88
Soil classification	BS 1377,
<i>Desiccation testing</i>	
Desiccation test	Mahar and O'Neill (1983)
<i>Permeability testing</i>	
Permeameter	ASTM D5887
Falling head	KH Head: Procedure 10.7.2, BS 1377-6, ASTM D2434, D5084
<i>Strength testing</i>	
Unconfined compressive strength	BS 1377-7, ASTM D2166
<i>Consolidation testing</i>	
Triaxial testing	BS 1377-5, ASTM D2435
Oedometer testing	BS 1377-7, ASTM D 3999
Rowe cell	Sheahan and Watters (1996)
<i>Settlement testing</i>	
Setting velocities	BS 812-103, no ASTM, pipette method
Mudline testing (drained and undrained)	Developed – standard procedures in preparation

Table Annex 4.2: Geotechnical characterisation of tailings - single tests

Mudline tests to determine the settled density of tailings samples on deposition, both in an undrained and drained state, have been developed (Reference Knight Piesold Personal Communication), a standardised procedure for which is being prepared within the Clotadam Project.

Index testing

Index tests provide essential geotechnical characterisation of tailings, and have the advantage of being easy to perform with a quick turn-around time and are thereby relatively cheap. Index properties can provide a rapid tailings classification.

Particle size determination

Tailings are commonly in the top three of the following four grain size distribution groups:

- clay - materials less than 2 μm
- silt - materials lying between 2 μm to 63 μm
- sand - materials lying between 63 μm and 2 mm, and
- gravel materials lying between 2 mm and 60 mm.

Test procedures for grain size analyses typically include a combination of sieves and a hydrometer.

Atterberg Limits (Plastic Limit and Liquid Limit)

Atterberg Limits assess material plasticity and hence provide a fundamental test of the tailings consistency. The water content at which the tailings ceases to act as a liquid and becomes a plastic solid is known as the liquid limit. The definitive method is the Cone Penetration Test, where a sample is tested for a range of moisture contents. From the cone penetration readings obtained, a graph of water content versus penetration is plotted, and the liquid limit is taken as the moisture content that corresponds to a cone penetration of 20 mm.

With decreasing moisture content, the limit at which plastic failure changes to brittle failure is known as the plastic limit. The plasticity index is defined as the range of moisture content over which a material behaves in a plastic manner. Generally, the finer the soil the greater its plasticity index.

Desiccation testing

Air drying tests are carried out on slurry samples to determine the effect of atmospheric evaporation on deposited tailings following initial settlement and removal of the supernatant water. The test, therefore, simulates the sub-aerial deposition of tailings. Continuous monitoring is carried out of the sample weight and volume to define a relationship between the dry density, moisture content, volume reduction, evaporation and the degree of saturation of the tailings material. The test may include the measurement of shear strength, using a laboratory shear vane.

An absolute relationship between the dry density and moisture content exists up to a breakaway point at which the degree of saturation falls below 100 %. At this stage, negative pore pressures develop and act to further consolidate the tailings. At a limiting saturation point, no further bleeding of the material occurs with further drying occurring due to the drawing of water from the voids. At this point, cracking of the sample occurs and hence the final dry density and moisture content are typically calculated by interpolation.

The standard air-drying test is undertaken using a 1 litre container with no underdrainage. For the majority of the samples the lack of underdrainage has no significant effect on the drying rate or final density of the sample. Where tailings samples contain significant amounts of salt in the water, the formation of a salt crust can inhibit drying.

Permeability testing

Standard tests are available for the determination of the Coefficient of Permeability (Hydraulic Conductivity) of a material. These tests provide a measure of the drainage characteristics of tailings.

Strength testing

Strength testing can provide basic characterisation data and also design parameters for consideration in the closure designs of tailings facilities. Consolidated undrained and drained triaxial tests use cylindrical samples. Samples typically have an aspect ratio of 2:1 and are sealed by a rubber membrane attached by rubber 'O' rings to a base pedestal and a top cap. Pore pressures measurements can be made during testing and consolidation. Undrained Triaxial testing of the samples is typically carried out at multistage cell pressure increments, to determine the shear strength characteristics over a range of effective confining stresses. From a Mohr-Coulomb curve, the fundamental geotechnical parameters can then be determined, i.e. the effective angle of resistance (friction) and the effective cohesion.

Consolidation testing

Consolidation tests are used to assess the behaviour, particularly settlement and drainage characteristics of a material with respect to changes in loading. Test results provide void ratio/log pressure ratios, coefficient of consolidation, coefficient of volume compressibility and swelling pressures. Consolidation parameters are of significance to the operation, water management and closure design of a TMF.

The consolidation of the tailings can be described by two parameters. The first parameter is the coefficient of consolidation (c_v) which describes the rate of excess pore pressure dissipation and hence the rate of gain in effective stress of the tailings. This measure of the rate of consolidation implies that higher values mean rapid consolidation. The second parameter is the coefficient of volume compressibility (m_v) that is the volume change per unit volume per unit increase in effective stress. The quotient of the two coefficients alongside the material's unit weight can be used as a calculation of the permeability. These two coefficients can also be used alongside other geotechnical parameters to perform settlement and drainage time models using suitable analytical software.

Consolidation is generally carried out in a standard fixed ring oedometer at varying pressure (effective stress) increments. Each pressure increment is double the previous, and maintained for approximately 24 hours. Routine measurements of settlement should be recorded with time during each loading stage. Once settlement ceases or becomes negligible during loading the confining pressure is increased to the next stage. Typically for tailings confining the pressures range from 0.2 kPa to 400 kPa. For low-density samples such as tailings, the Rowe cell or a specially adapted oedometer may be used for consolidation testing. These test cells permit sample placement and testing at an initial solids content approximating the state of the tailings prior to consolidation (determined from the slurry settlement tests).

Settlement tests

Drained and undrained settling tests allow the modelling of the sub-aqueous and sub-aerial phases of the tailings deposition and provide an indication of overall density achievement during placement. The tests indicate not only deposited density, but also the rate of interstitial supernatant release used for water balance modelling purposes.

Undrained settling test

The undrained settling test estimates the density at which the tailings settle in an undrained, sub-aqueous environment. Tests are performed on slurrified tailings placed in a 1 litre graduated cylinder. The rate of settling and change in volume of the tailings as the supernatant water bleeds to the surface are recorded. The dry density of the settled voids is calculated once the change in settled volume remains constant.

Drained settling test

The drained settling test provides an indication of the dry density that will be achieved from underdraining the tailings. Tests are carried out in similar fashion to that of an undrained settling test, but the cylinder includes the provision for bottom drainage and the recovery of downward seepage. The rate of settling and change in volume of the tailings is recorded with time, as the supernatant water bleeds to the surface and drains from the base. To minimise the development of a vertical gradient across the sample, it is recommended that supernatant water is continually decanted from the surface. The dry density of the settled voids is calculated once the change in settled volume remains constant.

Settling velocity

Particle settling velocities of the fine tailings solids (particle sizes <0.074 mm) are determined using the data from the hydrometer portion of the grain size analysis. Alternatively, they may be determined by the measurement of the time it takes for the particle to fall a distance of 500 mm through distilled water. The results may be used for calculating friction losses for design of a tailings slurry pipeline. To determine the tailings delivery pipeline details, the per cent solids in the total product and particulate settling velocity are utilised for the slurry transport analysis.

Geotechnical modelling testwork

A practice adopted occasionally for the modelling of tailings deposits involves the sequential testing of a sample in order to simulate tailings facility conditions. In particular, this can involve a combination of settling air-drying, consolidation and strength tests. The combined test aims to reflect the fact the development of sub-aerially deposited tailings in which any combination of two of the following dewatering processes are always taking place:

- settling
- air drying
- consolidation.

Test methods are outlined above, although the practice of settling and consolidating samples in a combined testing apparatus are not standardised.

Specialist testing

For the design of tailings disposal, a set of additional process specific tests are recognised, including:

- wind tunnel testing
- dewatering testing
- filter leaf testing
- gravity thickening testing.

In the course of modelling tailings ponds, centrifuge testing is also occasionally carried out. Such testing is standardised for soils in ASTM D-425.

Chemical-mineralogical analysesChemical analyses

Chemical analyses include methods to analyse tailings and waste-rock samples for

- (1) elements and compounds present in minerals which generate and/or neutralise acid
- (2) trace metals, and
- (3) whole rock constituents which, in conjunction with x-ray diffraction analyses, can be used to quantify mineralogical composition

The procedures to be selected are dependent on the mineralogy of the examined tailings and waste-rock sample.

Sulphur and carbonate analyses

Of particular importance are acid-producing sulphur species and acid-neutralising carbonate species. Acid producing sulphur species include sulphides associated with iron sulphide minerals (usually pyrite and pyrrhotite) and sulphates associated with jarosites, alunites and efflorescent sulphate minerals. Trace metal sulphides will contribute to drainage acidity, if following their oxidation in the presence of water and oxygen, the associated trace metals precipitate as hydroxides, oxides, or carbonates. These minerals are of interest because they can contribute trace metals to drainage. Jarosites and alunite must be distinguished from non-acid-producing sulphate minerals such as gypsum and anhydrite.

Calcium and magnesium carbonate minerals are important in determining the neutralisation capacity of a waste material, because their dissolution can neutralise acid. It is necessary to distinguish these minerals from carbonates of iron and manganese which, under oxidising conditions, will yield no net acid neutralisation.

Sulphur determinations

Existing analytical techniques, such as those using a combustion furnace (e.g. LECO furnace) with a subsequent quantification of the sulphur dioxide evolved, are capable of accurately determining the total sulphur content of the material under study. However, given the different forms in which sulphur can occur in tailings and waste-rock, e.g. sulphide sulphur, elemental sulphur, sulphates etc., and their different potentials for acid production, an analytical scheme to speciate sulphur would be most beneficial for the environmental characterisation of sulphidic tailings and waste-rock. Other sulphur species are often determined by treating the sample to remove a specific sulphur phase. Such a method involves digestion of the sample with sodium carbonate to remove sulphate minerals. Sulphide sulphur is determined as the difference between the total sulphur and the $S(SO_4)$. This procedure presents some limitations depending on the mineralogical composition of the examined tailings and waste-rock. For example, minerals such as orpiment (As_2S_3) and realgar (AsS) will dissolve to some degree during digestion, leading to underestimation of the sulphide content, while jarosites and alunite may also not completely dissolve in the digestion, leading to an overestimation of the sulphide sulphur.

Carbon determinations

Standard Techniques using a combustion furnace can be also used for the determination of total carbon content (carbon present as carbonate, organic carbon, and graphite). Carbon species are often determined by treating the sample to remove a specific carbon phase, and using a determination of total carbon on the original and treated sample to determine the change in carbon content resulting from the extraction. A method to determine carbonate content, involves heating of the sample at 550 °C for one hour to drive off organic carbon as carbon dioxide (Lapakko, 2000). The carbonate carbon is estimated as the total carbon in the residue, and tends to be slightly lower than the initial carbonate content, due to some loss of carbonate during pyrolysis. The difference in temperatures at which carbon species decompose can be also used to speciate carbon (Hammack, 1994). Transition metal carbonates (e.g. siderite, $FeCO_3$, and rhodochrosite, $MnCO_3$) decompose, yielding CO_2 , in the range of 220 °C to 520 °C. Calcite decomposes above 550 °C whereas, dolomite decomposition occurs at 800 °C to 900 °C. A second method to determine carbonate content is referred to as “Acid Insoluble Carbon” (Lapakko, 2000). After analysed for carbon, the sample is digested with hot 20 % HCl, dried, and rinsed three times with distilled water to remove residual chloride, which can interfere with the subsequent analysis for total carbon. The residual solid is analysed for total carbon and assumed to be organic carbon. The carbonate carbon content is the difference between the initial total carbon analysis and acid insoluble carbon.

Total major (whole rock), minor and trace metals

Analytical techniques for determining metal concentrations in tailings and waste-rock samples can be generally categorised as non-destructive or destructive. Non-destructive techniques analyse the sample directly, leaving it intact. In contrast, destructive techniques dissolve the sample and the resultant aqueous solution is submitted for analysis by one of several methods.

Non-destructive techniques

Non-destructive techniques include instrumental neutron activation analysis (INAA) and X-ray fluorescence spectrometry (XRF). Wavelength dispersive XRF (WDXRF) is used to determine the contents of elements with atomic numbers less than or equal to 26, generally referred to as major elements or whole rock constituents, although it can be also used for elements of higher atomic numbers. Energy dispersive XRF (EDXRF) is used for the determination of elements with atomic numbers greater than 26, having the additional benefit of being transportable for field use. XRF is the most widely used non-destructive technique.

Destructive techniques

Acid digestion, sintering, and fusion are destructive techniques used to dissolve the samples, with the resultant solution/residue being analysed for the metals under study by one of several techniques.

An aqua regia (hydrochloric and nitric acids) digestion is commonly used to attack sulphides, as well as some oxides and silicates, and to determine the trace metal concentrations. A “near total” low temperature, atmospheric-pressure digestion using a combination of hydrofluoric, hydrochloric, nitric and perchloric acids can also be employed. Sintering and fusion, with subsequent digestion, can solubilise a wider variety of minerals, however, they are generally more appropriate for determination of whole rock components than trace elements. Aqua region digestion is used to determine the maximum concentration of elements that might become available under severe acidic conditions.

The most common methods for analysis of digestates are flame atomic absorption spectroscopy (F-AAS), graphite furnace-atomic absorption spectroscopy (GF-AAS), inductively coupled plasma-atomic emission spectroscopy (ICP-AES), and inductively coupled plasma-mass spectrometry (ICP-MS) (Hall 1995). The first two methods analyse solutions for a single element at a time, whereas with the ICP methods solutions are analysed for multiple components simultaneously.

Mineralogical analyses

The petrographic or mineralogical examination of samples is usually conducted by X-ray diffraction (XRD) techniques and transmitted and reflected light microscopy, often combined with image analysis. More specialised techniques including scanning electron microscopy (SEM) and electron probe microanalysis (EPMA) are also employed, when more detailed analyses of specific mineralogical components are required. Such techniques are particularly useful in the determination of the chemical composition of sulphide oxidation products such as rims, inclusions and amorphous (non-crystalline) species.

Transmitted light microscopy utilises thin (30 µm) sections of samples and reflected light microscopy utilises polished mounted samples. Samples may be prepared from drill-core samples, or from tailings and representative samples of treated material, or from fragmented material such as humidity cell feed and residue samples.

Transmitted light microscopy is used to examine those minerals that transmit light in thin section, and these include most of the gangue or non-metallic minerals that may have a neutralising capability. Reflected light microscopy is used to examine those minerals that do not transmit light in thin section, but reflect light to varying degrees when polished. Such minerals include metal sulphides that may oxidise to generate acid.

Both types of microscopy are used to identify individual mineral grains to determine mineral grain size and size distribution, and to identify mineral grain spatial interrelationships. Grain size, size distribution and grains associations, are often examined, with the assistance of image analysis techniques combined with the above microscopes. The reaction products of sulphide oxidation (rimming of grains) are readily observed, as are many other characteristics of mineral grains (such as inclusions) not readily seen by other analytical techniques. These capabilities of microscopic examination are extremely useful in ARD studies of both tailings and waste-rock.

Metal partitioning

The concentration of a trace metal in a tailings and waste-rock does not necessarily reflect its potential for release to the environment. The phase in which trace metals exist determines how readily available they are for release to the environment. Sequential extractions testwork developed and used primarily for the chemical speciation of metals in soils and sediments (Tessier et al., 1979), can provide useful information about the mode of occurrence and mobility of trace elements. Recently, sequential extractions have been increasingly applied to tailings and waste-rock in order to study the partitioning of metals (Leinz et al., 2000), as well as the retention of mobilised elements by secondary phases (McGregor et al., 1995; Dold, 2001), as these are parameters characteristic of the overall environmental behaviour of the examined material. As an example, a 7-step sequential extraction for tailings and waste-rock reported by Leinz et al. (2000) is given in the following table.

Phase	Sample/ extraction medium	Conditions	Duration
Water-soluble	0.25g sample + 0.25 g silica gel + 25 ml of de-ionised water	Shaking/ ambient temperature	2 h
Ion-exchangeable	Residue of 1 st extraction + 25 ml 1M sodium acetate	Shaking/ ambient temperature	1 h
Carbonate	Residue of 2 nd extraction + 25 ml 1M sodium acetate buffered with acetic acid, pH: 5.0	Shaking/ ambient temperature	2 h
Fe-MnOx _{am}	Residue of 3 rd extraction + 25 ml 0.25 M hydroxylamine hydrochloride in 0.25M HCl	Water bath/ 50 °C	30 min
FeOx _{cryst}	Residue of 4 th extraction + 25 ml 4 M HCl	Water bath/ 94 °C	30 min
Sulphide	Residue of 5 th extraction + 2 g sodium chlorate +10 ml conc. HCl Separation and dilution to 25 ml with deionised water Residue + 25 ml 4N HNO ₃		45 min
		Boiling water bath	40 min
Silicate	Digestion of residue with 10 ml of each conc. HNO ₃ , HClO ₄ and HF + 25 ml 4M HCl	220 °C	
		100 °C	30 min

Table Annex 4.2: Example of a 7-step sequential extraction for tailings and waste-rock.

Acid base accounting

Procedures

Static Acid Base accounting tests are short term (usually measured in hours or days) and relatively low cost tests developed to provide an estimate of a tailings and waste-rock's capacity to produce acid and its capacity to neutralise acid. These tests do not consider parameters such as the actual availability of acid-producing and acid-neutralising minerals and differences between the respective dissolution rates of acid-producing and acid-neutralising minerals. Thus, these tests are commonly used as a screening tool, and their implications are subject to further verification.

The most common of such procedures include:

- Sobek Acid Base Accounting (ABA) procedure (Sobek et al., 1978)
- BC Research Inc. Initial Test procedure (Bruynesteyn and Duncan, 1979)
- Net Acid Production (NAP) test (Coastech Research Inc., 1989)
- Net Acid Generation (NAG) test (Miller et al., 1997)
- modified Acid Base Accounting (ABA) procedure (Lawrence and Wang, 1997)
- Lapakko Neutralisation Potential Test procedure (Lapakko, 1994)
- Peroxide Siderite Correction for Sobek ABA method (Skousen et al., 1997).

Despite individual procedural differences, all these methods involve:

- determination of the Acid Potential (AP) based on the total sulphur or sulphide-S content
- determination of the Neutralisation Potential (NP) including:
 - the reaction of a sample with an inorganic acid of measured quantity
 - the determination of the base equivalency of the acid consumed
 - the conversion of measured quantities to a Neutralising Potential in g/kg or kg/tonne or tonne/1000 tonne calcium carbonate (CaCO₃).

Initially the most commonly-used static test was the standard ABA (Sobek et al., 1978). Variations of ABA commonly applied nowadays include the modified ABA (Lawrence and Wang, 1997), NAG test (Miller et al, 1997) and the B.C. Research Initial Test (Bruynesteyn and Duncan, 1979).

As described above, the static tests quantify the acid potential (AP) using either total sulphur or sulphide-sulphur content. The total sulphur content (Standard ABA) overestimates the actual AP of samples containing substantial non acid-producing sulphate minerals (e.g. barite or gypsum). On the other hand, the sulphide-sulphur measurement (modified ABA), will underestimate the actual AP of samples containing substantial amount of acid-producing sulphate minerals (e.g. melanterite or jarosite). Knowledge of the tailings and waste-rock sulphate mineralogy will indicate whether the sulphate minerals present, if any, are acid producing and allow selection of the more appropriate AP quantification. However at present it is accepted that the AP is calculated based on sulphide sulphur.

Different static test methods can produce markedly different neutralisation potential values (NP) for the same sample. Protocol variables which may contribute to these differences include tailings and waste-rock particle size (tailings are typically run "as received"); the type and amount of acid added (i.e. digestion pH), temperature and the endpoint pH of the "back titration", if a back titration is used. The extent to which protocol variables will affect the measured NP is dependent on the sample mineralogy. The conditions and minerals reported to dissolve by various ABA procedures are summarised in the following table. It is noted that carbonates are considered as the most reactive acid neutralising minerals, whereas minerals including plagioclase feldspars, K-feldspar, muscovite and quartz are slow weathering minerals.

The Net Acid Production (NAP) (Coastech Research Inc., 1989) and Net Acid Generation (NAG) (Miller et al., 1997) tests are based on the principle that hydrogen peroxide accelerates the oxidation of iron sulphide minerals. The acid consequently produced dissolves neutralising minerals present, and the net result of the acid production and neutralisation can be measured directly. This test does not require sulphur determinations and is, therefore, more readily conducted in a field laboratory than other static tests. Based on previous studies, the application of NAP to wastes with sulphur content higher than 10 % may underestimate the acid generation potential due to incomplete oxidation (Adam et al., 1997).

Procedure	Acid	Amount of acid added	End pH of acid addition	Test duration	Test temperature	Minerals dissolved
Sobek	Hydrochloric	Determined by fizz test	0.8 - 2.5	Until gas evolution ceases (~3 h)	Elevated (90 °C)	Mineral carbonates Ca-feldspar, pyroxene, olivine (forsterite-fayallite) Some feldspars anorthoclase>orthoclase >albite ferromagnesian – pyroxene hornblende, augite, biotite
BCRI initial	Sulphuric	To reach pH 3.5	3.5	16 - 24 h	Ambient	Ca + Mg carbonates. Possibly chlorite, limonite
Modified ABA	Hydro-chloric	Determined by fizz test	2.0 - 2.5	24 h	Ambient	Ca + Mg carbonates Some Fe carbonate, biotite, chlorite, amphibole olivine (forsterite-fayallite)
Lapakko	Sulphuric	To reach pH 6.0	6.0	Up to 1 week	Ambient	Ca + Mg carbonates
Sobek – siderite correction	Procedure as for Sobek, but with peroxide correction for siderite					Ca + Mg carbonates, excludes Fe+Mn carbonates. Otherwise as per Sobek.

Table Annex 4.3: Most common procedures for acid base accounting

Screening assessment criteria

Two parameters need to be calculated to classify materials in terms of acid drainage generation potential. These are:

- the Net Neutralisation Potential (NNP), which is the difference in value between the neutralisation potential (NP) and the Acid Potential (AP), expressed in kg CaCO₃/t of material and
- the neutralisation potential ratio (NPR), which is the ratio of NP value to AP value.

The former is the parameter preferably used for the characterisation of tailings and waste-rock stemming from the Appalachian coal mines, and the latter for Western Canadian metalliferous mines. Materials with sulphide minerals whose net neutralising potential is negative are likely to be an acid drainage source. Exceptions are possible if the sulphide content of material is very low and/or if there are slow dissolving, non-carbonate sources of alkalinity. Based on the NPR values, the Acid-Base Accounting screening criteria recommended by the British Columbia Ministry of Employment and Investment of Canada are given in the following table (Price et al., 1997).

The above guidelines define a “grey zone” for NPR ranging between 1 and 4. The acid drainage potential of materials that fall in the grey zone is considered uncertain and kinetic testwork has to be conducted to further characterise them with regard to acid generation potential. It is noted that the British Columbia guidelines recommend that the neutralisation potential is determined based on the expanded version of the Sobek method (Modified ABA) and acid potential is determined based on the sulphide sulphur content of the samples.

Potential for ARD	NPR	Comments
Likely	<1:1	Likely ARD generating
Possibly	1:1 – 2:1	Possibly ARD if NP is insufficiently reactive or is depleted at a faster rate than sulphides
Low	2:1 – 4:1	Not potentially ARD generating unless significant preferential exposure of sulphides or extremely reactive sulphides in combination with insufficiently reactive NP
None	>4:1	No further testing is required unless material is going to be used as a source for alkalinity

Table Annex 4.4: ARD potential related to neutralisation potential ratio (NPR)

An alternative approach is to use Modified ABA (Lawrence and Wang, 1997) together with the mineralogy of the sample as the basis of a reliable ARD screening programme. Modified ABA has a lower risk of misclassification of the examined waste samples into the wrong category and comprises a cost-effective screening test.

Kinetic tests

Kinetic tests are performed for sulphide tailings and waste-rock that according to static test results are characterised as potentially acid generating or fall in the zone of uncertainty. Kinetic tests can also be used to determine the metal leachability of trace elements of environmental concern. It is required to estimate the acid generation rate and quality of drainage of these materials, information that is considered as critical for the environmentally safe management of tailings and waste-rock. A number of laboratory kinetic tests have been developed with humidity cells, columns and lysimeters (see table below), being the three most commonly used laboratory methods for determining kinetic acid drainage characteristics of drill-core samples, waste-rock and tailings. All kinetic testwork procedures involve two main stages, i.e. subsection of sample to periodic leaching and collection of drainage for analysis.

	Type	Procedure	Comments
1	Humidity cells (ASTM D5744-96)	Sample mass: 1 kg Oxidative wet/ dry cycles Test duration: 20 weeks minimum	<ul style="list-style-type: none"> • standard procedure • determination of acid generation/neutralisation rates • real conditions may not be simulated.
2	Column test	Operating conditions specific	<ul style="list-style-type: none"> • flexible, allowing simulation of

		to examined material or disposal site Simulation of oxidizing, reducing environment	field conditions • long duration
3	Lysimeters test	Simulation of field conditions	• no standardised practice • long duration

Table Annex 4.5: Laboratory kinetic tests

The humidity cell is a standard kinetic test (ASTM D5744-96) recommended by the government of British Columbia, Canada for the prediction of the geochemical behaviour of tailings and waste-rock. It is usually referred as an accelerated weathering procedure, since it is designed to accelerate the natural weathering rate of potentially acid generating samples and reduce the length of time for which testwork must be run. A cell 203 mm in height by 102 mm diameter is specified for material 100% passing 6.3 mm (crushed core or waste-rock and coarse tailings) and a cell 102 mm in height by 203 mm diameter is specified for material passing 150 μm (fine tailings). The humidity cell operational procedure is a cyclic one during which the sample is subjected to three days of dry air permeation, three days of humid (water saturated) air permeation and one day of water washing with a fixed volume of water, i.e. 500 ml for 1 kg of sample. The sample mass used is about 1 kg and a minimum test duration of 20 weeks is recommended.

Column testwork may be undertaken to determine the geochemical behaviour of waste-rock and tailings disposed on the surface and exposed to atmospheric weathering (sub-aerial disposal) or disposed underwater cover (sub-aqueous disposal). Unlike the humidity cell procedure, there is little, if any, standardisation of the column testwork procedure, thereby allowing considerable flexibility. This flexibility allows column testwork to be highly site or material specific with regard to material particle size, sample mass and volume, wet/dry cycles, volume of water washing, etc. Columns for sub-aerial and sub-aqueous testwork are typically 76, 102 or 152 mm in diameter and range from about 1 m to more than 3 m in height.

Lysimeters may be also used to determine the acid generation/neutralisation rates of sulphidic tailings and waste-rock and assess the drainage quality. Like the column kinetic test, the lysimeter test allows the simulation of the conditions encountered at the site. Lysimeters have usually larger diameter and smaller height compared to columns. (e.g. 30 or 70 cm in diameter and height 30 to less than 100 cm)

It is noted that a humidity cell will usually determine if a given sample will produce acidity but will not define when the sample will turn acid, or the on-site drainage quality. On the other hand, the column and/ or lysimeter test procedure may simulate field conditions and as a result, may be used to give indications of on-site drainage quality, i.e. they can enable the determination of lower and higher bound. Monitoring parameters in a kinetic test include mass/ volume of leachates, pH, conductivity, redox potential (mV), acidity/ alkalinity, sulphate and dissolved metals.

Presence of soluble salts

Paste pH is a common and simple field test, used to assess the presence of soluble acid salts on tailings and waste-rock. Most methods use a 1:1 weight ratio of distilled water to air dried solids, and pH is measured at the mixture. Sample mass and equilibration time of the water-solids mixture prior to pH measurement vary among methods. The procedure described by MEND (1990) determines pH of a mixture of 10 g sample (-60 mesh) and at least 5 ml distilled water (water addition is adequate to saturate, but not cover, the sample). The Acid Concentration Present test is slightly more complicated but supplies an estimate of acidity present rather than simply pH (Lapakko, 2000). A mixture of 20 g sample (-200 mesh) and 50 ml deionised water is agitated, the initial pH is recorded, and the mixture is titrated to pH 7 with NaOH.

The standard paste pH test was developed by the US EPA, (Method 9045C).

Metal leaching tests

Procedures

Although acid generation has received the most attention for sulphide and coal active and/or abandoned mines, leachable metals comprise potential source of contaminants in tailings and waste-rock drainage. Numerous leaching procedures have been developed worldwide addressing various management scenarios, leaching properties and tailings and waste-rock types. Tests have been developed to account for variability in the ratio of leaching fluid to solid materials, chemical composition of the leaching fluid, testing of monolithic and granular materials, as well as stabilised and solidified materials. A summary of leaching test procedures used in Europe, the US and Canada are given in the following table.

Leaching test methods can be divided into 2 general categories:

- extraction tests, in which leaching takes place with a single specified volume of leaching fluid, and
- dynamic extraction tests, in which the leaching fluid is renewed throughout the test.

Test protocols frequently incorporate a particle size reduction, in order to increase the amount of surface area available for contact, thereby reducing the amount of time required to reach a steady state condition. Examples of extraction tests used for regulatory purposes include:

- US EPA Toxicity Characteristic Leaching Procedure (TCLP, Method 1311)
- British Columbia Special Waste Extraction Procedure, SWEP (MELP, 1992)
- German standard DIN 38414-S4
- French standard AFNOR X 31-210
- Swiss TVA Eluate test
- EN 12457/1-4.

The most commonly used for the last two decades are the TCLP and SWEP tests, which were developed to simulate leaching in sanitary landfills and which involve a leaching with acetic acid. This acid, comprising the decomposition product of organic wastes found in municipal landfills, has a strong capacity to dissolve lead. Given that, in the disposal sites of the mining industry, the co-disposal of tailings and waste-rock with organic wastes, does not normally take place, leachability testing with acetic acid, is not considered as the recommended practice for the characterisation of tailings and waste-rock. Extraction tests using deionised water as the leaching medium, such as DIN 38414-S4, modified SWEP etc. more closely approximate the conditions in a tailings and waste-rock management facility.

Most recently, and within the application of the Landfill Directive (1999/31/EC), the European Standard EN 12457/1-4 was developed, and applied for the classification of waste material accepted for disposal at Landfills (COM(2002) 512 final), also using de-ionised water as the leaching medium.

In dynamic extraction protocols, the leaching fluid is renewed, either continuously or intermittently, to further drive the leaching process. Because the physical integrity of the studied material is usually maintained during the test, and the information is generated as a function of time, dynamic extraction tests provide information about the kinetics of contaminant mobilization. In general, dynamic extraction tests can be categorised as:

- serial batch tests,
- flow-around tests,
- flow-through tests, and
- soxhlet tests.

In a serial batch test, a portion of a crushed, granular sample is mixed with leachant and agitated for a specified time period. At the end of the time period, the leachate is separated and removed, fresh leachant added, and the process repeated until the desired number of leaching periods has been completed. The concentrations of contaminants measured in the serial leachates can provide kinetic information about contaminant dissolution. Examples include the Multiple Extraction Procedure (US EPA Method 1320); the Availability Test (NEN 7341) and Serial Batch Test (NEN 7349) from the Netherlands.

Flow-around tests use either monolithic samples, or samples that are somehow contained. The sample is placed in a test vessel, with space around the sample, and leachant is added so that it flows around the sample. The leachant may be renewed continuously and sampled periodically, or it may be replaced intermittently. In either case, the liquid to solid ratio is expressed as the ratio of volume of leachant to surface area of sample. Examples of flow-around tests include the ANSI 16-1 and the Monolithic Diffusion test (NEN 7345) from the Netherlands.

Flow-through tests differ from flow-around tests in that the leachant flows through the sample rather than around it, thereby simulating conditions in the disposal of tailings and waste-rock. Flow-through tests, such as the kinetic tests used in ARD testwork, are usually constructed as columns or lysimeters, and can be set up to mimic site-specific conditions. These tests, however, pose particular experimental challenges, such as channelling, flow variations caused by the hydraulic conductivity of the waste, clogging of the system by fine particulates, and biological growth in the system. Examples of flow-through tests include:

- Dutch standard column test (NEN 7343)
- ASTM D 4874-95 Column Test and
- Nevada Meteoric Water Mobility Procedure (MWMP), which allow testing for large masses and coarse particle sizes of material.

The above classification of leaching tests is directly related with the operating procedures applied, i.e. extractive, or dynamic. Another way to categorise leaching tests is in relation to their aim of application and practice. In this context, tests can be classified as:

- characterisation tests, aiming to investigate the leaching behaviour of materials under a variety of exposure conditions (typical testing run from a few days to weeks or even a month)
- compliance tests, which are generally of much shorter duration, usually aiming at a direct comparison with threshold values (test duration up to one or two days), and finally
- on-site verification tests, aimed at verifying a previous evaluation of a charge or batch arriving at a processing plant and/or tailings or waste-rock management facility.

The two last categories have been adopted in CEN, the European Standardisation Organisation, as the basis for the development of a standard leach test. As previously noted, the recently developed European Standard EN 12457 (Van der Sloot et al., 1997, EN 2002) is an extraction test proposed for the leaching of granular wastes and sludges with deionised water at a compliance level.

a/a	Organisation/ Country	Standard	Application	Leaching medium	Maximum particle size	Liquid: solid ratio	No of extractions	Test duration
<i>Extraction tests</i>								
1	US EPA	Ep Tox	Classification of wastes in terms of toxicity	Acetic acid 0.04 M, pH:5.0	9.5	16:1	1	24 h
2		TCLP		Acetic acid pH:2.88 or pH: 4.93	9.5 mm	20:1	1	18 h
3		SPLP	Assess impact of wastes	Synthetic acid rain	9.5 mm	20:1	1	18
4	British Columbia	SWEP		Acetic acid, 0.5 N, pH: 5.0	9.5 mm	20:1	1	24 h
5	Special waste regulation	Modified SWEP		Deionised water	9.5 mm	20:1	1	1 h
6	Environment Canada*	ELT	Granular wastes	Deionised water	150 µm	4:1	1	7 days
7	German	DIN 38414 S4	Sludges and sediments	Deionised water	10 mm	10:1	1 or more	24 h
8	France	AFNOR X-31-210	Granular wastes	Deionised water	4 mm	10:1	1	24 h
9	CEN/ TC 292	EN 12457	Granular wastes and sludges	Deionised water	90 % <4 mm	2:1 up to 10:1	1 or 2	24 h
10	Materials characterisation center, 1984	MCC -1P	High-level radioactive waste	Deionised water	Monoliths	Volume/surface area: 10-200 cm	1	Not determined

Table Annex 4.6: Leaching test procedures for wastes
(EPA/625/6-89/022, Van der Sloot et al., 1997)

* Environment Canada and Alberta Environmental Center (1986)

(continued)

a/a	Organisation/ Country	Standard	Application	Leaching medium	Max grain size	Liquid: solid ratio	No of extractions	Test duration
Dynamic tests								
13	US EPA	MEP Serial batch test	Granular wastes	α) acetic acid β) synthetic acid rain	9.5 mm	16:1 20:1	1 ≥9	24 h
14		MWEP	Granular wastes/ monoliths	Deionised water	9.5 mm or monolith	10:1	4	18 h per extraction
15	The Netherlands	NEN 7341 Availability test	Dutch waste management Max leachability	Deionised water at a) pH: 7.0 and b) pH:4.0	125 µm	50:1	2	3 h per extraction
16		NEN 7343 Column test	Mineral wastes - Simulate leaching in the short and medium term (<50 years)	Deionised water with HNO ₃ at pH:4.0	4 mm	0.1:1 to 10:1	7	21 days
17		NEN 7345	Tank leaching test for monoliths and stabilised wastes	Deionised water	0.1×0.1 ×0.1 m >40 mm	5:1	8	6h to 64 days
18		NEN 7349 Serial batch test	Long-term leaching behaviour of wastes	Deionised water adjusted with HNO ₃ at pH:4.0	4 mm	20:1 up to 100:1	5	23 h per extraction
19	Switzerland	TVA-eluate test Serial batch test	Granular and monolithic wastes	Deionised water, CO ₂ atmosphere pH:5-6	Not specified	10:1	2	24 h per extraction
20	Sweden	ENA shake test Serial batch test	Mineral wastes-Simulation of initial pore water quality	Deionised water adjusted to pH: 4.0 with H ₂ SO ₄	20 mm	4:1	4	24 h per extraction
21	UK Waste Research Unit	WRU	Waste disposal in inorganic environment or municipal landfill	Deionised water or CH ₃ COOH at pH:5.0	10 mm	1 to 10 pore volumes	5	2 –80 h
22	The Nordic Countries	Nordtest Serial batch	Granular waste materials	Deionised water with HNO ₃ at pH:4.0	90% <4 mm	2:1 up to 50:1	1 or 2 or 3	24 h
23		Nordtest Availability test	Granular waste materials	Deionised water at a) pH: 7.0 and b) pH:4.0	125 µm	100:1	2	3 h per extraction
24		Nordtest Column test	Granular waste materials	Deionised water with HNO ₃ at pH:4.0	4 mm	0.1:1 up to 2:1	4-5	20 days
25	ANS 1986	ANS-16.1	Low level/ hazardous wastes	Deionised water	Monoliths	Volume/surface area: 10 cm	11	2 h to 90 days
	Nevada Mining Association	MWMP		Deionised water	5 cm	1:1	1	24 h

Methodology for tailings and waste-rock characterisation

Environmental characterisation of tailings samples

Based on the techniques developed for assessing the environmental behaviour of mining wastes, as described in Section 1, of this Annex one possible methodology for characterisation of tailings and waste-rock is shown in the following figure.

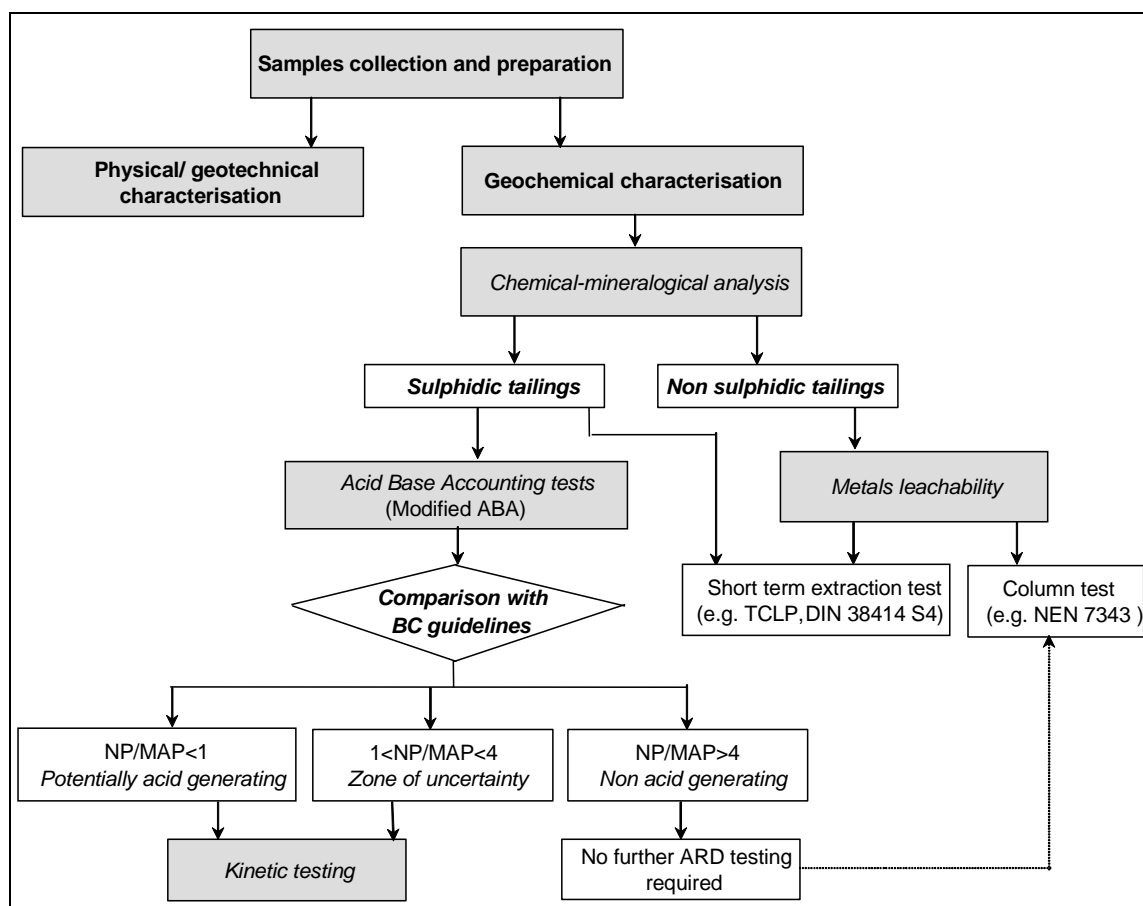

Figure Annex 4.1: Possible methodology for characterisation of tailings and waste-rock

Standard operating procedures

Standard operations procedures (SOPs) describe the way specific tests and methods are performed. These include sampling, sample preparation, calibrations, measurement procedures, and any test that is done on a repetitive basis. “Standard” means that it specifies the way the operation is to be done on each occasion, which may or may not be a procedure developed by a standards organisation. However, when such a standard procedure is available, laboratories, research organisations, and mining industries are advised to consider them since they represent peer judgement and can provide a basis for comparability of data among different user laboratories.

While the use of SOPs may provide a continuity of measurement experience, no methodology should be used without judgement. Its applicability should be reconsidered at each and every use. If used infrequently, it may be necessary for the researcher and/or operator to make a sufficient number of preliminary measurements to demonstrate attainment of statistical control of the measurement process on each occasion.

Standard Operating Procedures (SOPs) for the characterisation of tailings samples are listed in the following 2 tables. The majority of these procedures can be also applied for the characterisation of waste-rock.

Parameter	SOP*	Method
Particle size distribution	BS 1377: Part 2: 1990	Wet/dry sieving method
Particle density	BS 1377: Part 2: 1990	Gas jar method/pycnometer method
Moisture content	BS 1377: Part 2: 1990	Oven drying method
Dry density/moisture content relationship	BS 1377: Part 4: 1990	Compaction method
Consolidation column test	To be specified	
Permeability - triaxial cell - falling head	BS 1377: Part 6: 1990 KP (Appendix A.1.1)	Triaxial cell method Falling head method

*An equivalent to British preferably European standard methodology can be followed.

Table Annex 4.7: Standard Operating Procedures

Parameter	SOP	Comments
Acid base accounting	Modified ABA (Appendix B.1.1)	Recommended
Soluble salts	1. Paste pH 2. British Columbia Modified Special Waste Extraction Procedure	Recommended Recommended
Leachability		
1. Toxicity characteristic leaching procedure (TCLP)	USEPA #1311	Optional
2. Synthetic precipitation leaching procedure (SPLP)	USEPA #1312	Optional
3. Leachability by water	DIN 38414 S4	Recommended
4. Leachability by water	EN 12457	Optional
5. Sequential method	Needs standardisation	
Kinetic Testing		
1. Humidity cells	Modified from Morin and Hutt, 1997 and ASTM D5744-96	Column or humidity cell testing selectively applied.
2. Column protocol	Developed by GSG	
Chemical Analysis		
1. Flame atomic absorption spectra.(F-AAS)		
2. Graphite-furnace atomic absorption Spectra.(GF-AAS)		
3. Inductively coupled plasma-atomic emission-spectroscopy (ICP-AES)		
4. Inductively coupled plasma-mass spectroscopy (ICP-MS)		
Mineralogy		
1. X-ray fluorescence spectrometry (XRF)		
2. X-ray diffraction (XRD)		
3. Scanning electron microscopy (SEM)		
4. Transmitted light microscopy (TLM)		

Table Annex 4.8: Standard Operating Procedures

Characterisation of additives

For the environmentally safe management of waste-rock and tailings during operation and closure, the application of additives to prevent and mitigate acid and contaminated drainage formation may be required. The characterisation of additives will depend on the type and the specific objectives of additive application. The additives can be grouped in the following categories:

- alkaline materials (e.g. limestone, lime), for the addition of neutralising capacity
- pozzolanic materials (e.g. fly ash), for the addition of neutralising capacity, the modification of the geotechnical properties of disposed wastes/tailings and for the formation of low permeability of covers and barriers
- clays (e.g. bentonite), for the formation of low permeability barriers and covers and
- organic materials (e.g. biological sludge), mainly to facilitate the during the post closure period, or to enhance the maintenance of anaerobic conditions within the material.

Some methods for the characterisation of additives are given in the following table:

Parameter	Method	Alkaline materials	Pozzolanic materials	Clays	Organic materials
Moisture	BS 1377: 2 1990	√	√	√	√
Grain size analysis	BS 1377: 2 1990	√	√	√	√
Swell index	ASTM D 5890	-	-	√	-
Chemical analysis	AAS/ ICP/ Titration/ gravimetric methods	CaO, MgO, Al ₂ O ₃ , CO ₂ , SO ₃ , SiO ₂ , Fe, Mn, LOI	Al ₂ O ₃ , Fe ₂ O ₃ , CaO, MgO, K ₂ O, Na ₂ O, TiO ₂ , SiO ₂ , SO ₃ , CO ₂ , LOI Trace elements content: Pb, Zn, Cd, As, Mn, Ni, Cr		Organic carbon, nitrogen, phosphorus, LOI, heavy metals content
Free calcium oxide content	EN 451-1	√	√	-	-
Mineralogical analysis	XRD/ Optical microscopy	√	√	√	-
Neutralisation potential	Modified ABA	√	√	√	-
Cation exchange capacity	Olphen 1977	-	-	√	√
Metals leachability	TCLP DIN 38414 S4	-	√	√	√

Table Annex 4.9: Some methods for the characterisation of additives

Development of rehabilitation techniques

Physical and geochemical stabilisation

For the development and evaluation of rehabilitation and closure strategies for tailings or waste-rock management facilities, it is general practice for laboratory kinetic tests, similar with those conducted during the environmental characterisation programme, to be performed. For example, the effectiveness of alkaline additives in preventing acid generation from sulphidic tailings and waste-rock can be evaluated with humidity cell tests, columns (ROLCOSMOS, 2001), as well as lysimeters (PRAMID, 1996).

For the development and evaluation of low permeability barrier layers, involving a mixing of the tailings or waste-rock with selected additives, the methodology should include geotechnical and geochemical characterisation of the potential cover system, as shown in the following figure. This methodology, applied previously for sulphidic tailings - fly ash/ bentonite composite cover systems is based on the guidelines given by international environmental agencies for:

- design and evaluation of landfill covers (U.S EPA/625/4-91/025)

- stabilisation/solidification treatment of wastes (U.S EPA 625/6-89/022), and
- prediction and prevention of acidic drainage in a sulphide mine (Environment Australia, 1997).

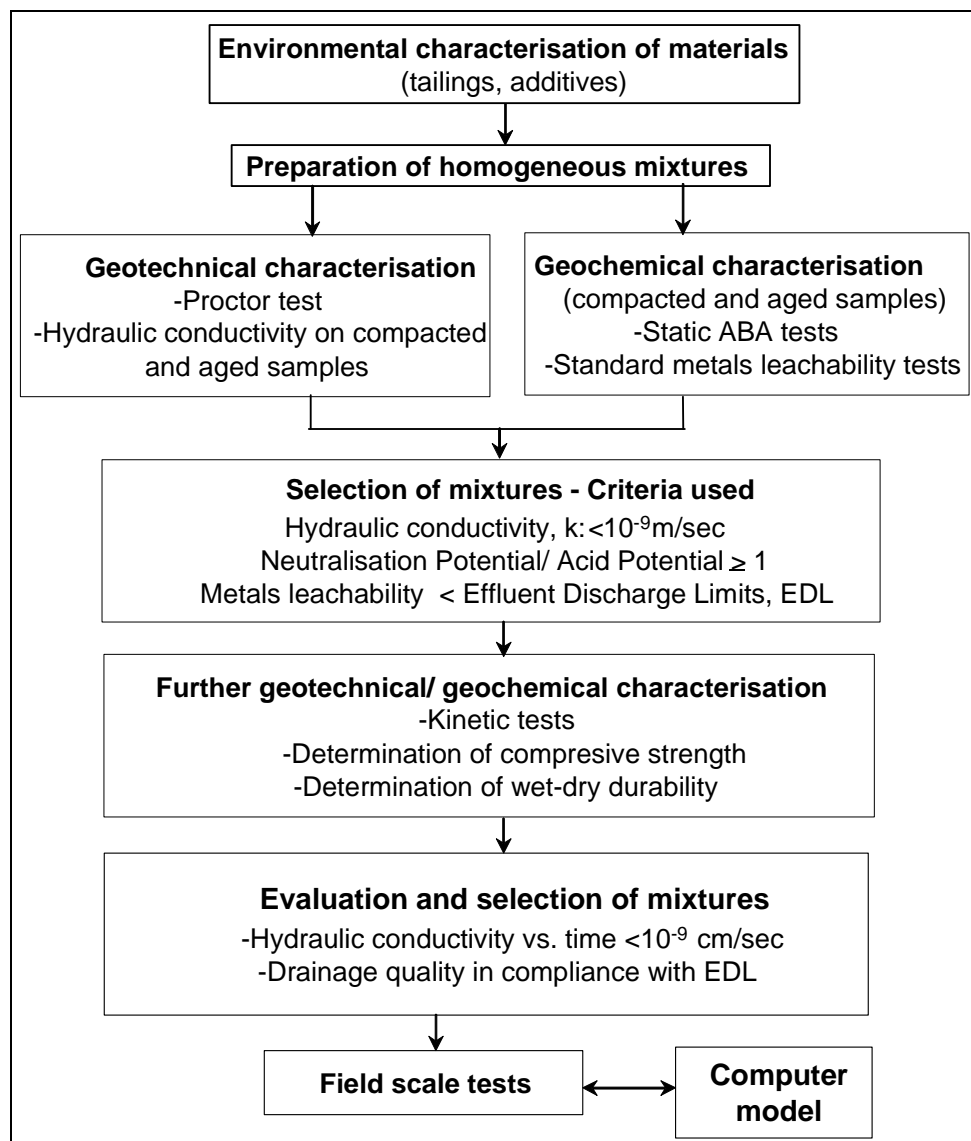

Figure Annex 5.1: Environmental characterisation of materials

Following the physical characterisation of tailings and additives, i.e. moisture, grain size analysis, the geotechnical tests performed with the composite mixtures aim to determine critical parameters used in the development of surface barriers, such as the standard Proctor compaction curve and the hydraulic conductivity. Where additives are employed which exhibit time-dependent behaviour such as bentonite/tailings or cement/tailings mixes, standard procedures for maturing the sample prior to testing are required. Such standardised test procedures are currently in preparation (CLOTADAM 2003).

The moisture vs. dry density relationship (compaction curve) can be determined according to the standard and/ or modified Proctor method (BS 1377 part 4, ASTM D698, D1557, D558). The influence of the maturation of the tailings/additive mixture on compaction delay time and moisture content of the mixtures is normally considered.

Hydraulic conductivity measurements can be conducted on samples compacted at their optimum moisture (OM) and maximum dry density and cured for 7 and/ or 28 days at a relative humidity >90 %, at room temperature. Curing of the samples is very important since it allows the pozzolanic and cementation reactions to proceed, thereby effecting the physical and geochemical stabilisation of material. The hydraulic conductivity of samples compacted wet and dry at OM is also measured, in order to determine the conditions leading to the lower hydraulic conductivity. Hydraulic conductivity can be determined with (BS 1377 Part 7) and/or the falling head method (BS 1377 Part 5/6, ASTM D 5084).

To evaluate the geotechnical suitability of the different mixtures tested, the hydraulic conductivity measurements can, e.g. be compared with the value recommended in the European legislation for low permeability liners and covers, i.e. $k \leq 10^{-9}$ m/sec. For composite mixtures complying with the above criterion, further geotechnical characterisation can be conducted, including compressive strength (ASTM D2166) and dry-wet durability tests (ASTM D559) to determine their strength characteristics and evaluate the long-term physical integrity. The US EPA considers a stabilised/solidified material with a strength of 50 psi (345 kPa), to have a satisfactory unconfined compressive strength. (U. EPA/625/6-89/022). This minimum guideline has been suggested for providing a stable foundation for materials placed upon it, including construction equipment and cover material. The minimum required unconfined compressive strength for the tailings-additive mixtures should be evaluated on the basis of the design loads to which the material will be subjected.

Geochemical tests

The geochemical tests that can be performed on compacted and aged composite mixtures, and include:

- modified ABA method to determine the acid generation potential of sulphidic tailings
- standard metal leachability tests - DIN 38414 S4 method.

Revegetation of tailings disposal areas

A number of specific chemical tests can be conducted to characterise the treated or untreated tailings materials as a growth medium for plants growth. These tests include: chemical analysis, acidity, salinity/sodicity and elements content in the soil solution. A detailed description of tests to be performed is given in:

“Methods of Soils Analysis. Part 2: Chemical and Microbiological Properties”, 2nd edition, American Society of Agronomy Inc., Soil Science Society of America Inc., Madison, Wisconsin, US, 1982.

Chemical analysis

Apart from the determination of the heavy metals content previously described, a number of inorganic elements, essential for plants growth, can also be determined during the development of the revegetation scheme. They include:

Determination of total carbon, inorganic and organic carbon:

The total carbon in soils is the sum of both the organic and inorganic C. Most organic C is present in the organic matter fraction of the soil, which consists of micro-organism cells, plant and animal residues at various stages of decomposition, stable “humus” synthesised from residues, and highly carbonised compounds such as charcoal, graphite and coal. Inorganic C is largely found in carbonate minerals.

Determination of P, N and K

The presence of these elements on plant growth media is vital. Their potential deficiency can be mitigated by the addition of the suitable fertilizers. The type and fertilizers quantity should be determined taking into account their presence in the soil. Standard procedures for the determination of P, N and K content in soils will be followed.

Potential acidity and pH

There are several different methods available for measuring pH, including direct measurement in the saturating paste, measurement in the saturation extract and measurement to dilute extracts (i.e. liquid to solid ratios equal to 1, 2, 5 etc.). The more representative measurement for soil pH (as well as for the electrical Conductivity and for the content of soluble salts) is the saturation paste/extract, since it resembles better the field conditions. However, measurement methods in other than saturating conditions are often applied, since they are easy and provide higher quantity of leachate solution, thereby allowing the execution of additional analyses (e.g. sulphates and heavy metals concentration in the extract).

Potential acidity/alkalinity is determined by back titration with base or acid to a predefined end point.

EC and soluble salts

Similarly to pH measurement, electrical conductivity (EC) can be measured either in the saturation paste or in the saturation and diluted extracts. Soluble salts are determined by measuring their concentration in the extract. The Sodium Adsorption Ratio (SAR) is calculated as follows:

$$\text{SAR} = \text{Na} / ((\text{Ca} + \text{Mg}) / 2)^{1/2}$$

where Na, Ca and Mg are all expressed as meq/l

CEC and ESP

Cation Exchange Capacity (CEC) is a measure of the ability of soil to retain cations in an exchangeable form. Most of this exchange capacity originates from the clay and organic matter components of the sample. The capacity to retain cations in an exchangeable form arises from a negative charge on clay minerals and organic matter. This negative charge balance is neutralised by an equivalent number of exchangeable cations. Procedures for determining CEC in non-calcareous or non-gypsiferrous samples and in calcareous and gypsiferrous samples are different. The Exchangeable Sodium Percentage (ESP) is the ratio of the sodium exchangeable cations to the total cations exchanged.

Annex 5

Current standards for auditing in different parts of the world

Independent audits should commence with a review of the design and operation of the facility against the standards as set down by the regulators of the country in question and the undertakings by the mine in their own documentation.

In this respect, the standards of various countries are summarised as follows:

Australia

The Australian guidelines “Guidelines on the Safe Design and Operating Standards for Tailings Storage” and “Guidelines on the Development of an Operating Manual for Tailings Storage” both produced by the Australian department of Minerals and Energy, Western Australia defines standards for routine inspections and operational audits. A complimentary document is “Tailings Dam HIF Audit” that describes the components of an independent audit according to the Australian standards. This document can be found at <http://notesweb.mpr.wa.gov.au/MODAMS/MDWebAnalysisReps.nsf/ca94b16fd41d002> and the guidelines ISBN 0 7309 7808 7 and ISBN 0 7309 7805 2.

Canada

The Canadian guidelines “A Guide to the Management of Tailings Facilities” and “Developing an Operation, maintenance and Surveillance manual for Tailings and Water Management” both produced by the Mining Association of Canada suggest that periodic inspections and reviews, audits, independent checks and comprehensive independent reviews need to be carried out as part of the surveillance programme. The documents can be found at www.mining.ca

South Africa

The primary document controlling a mining companies tailings disposal activities in South Africa is the Department of Mineral and Energy Mandatory Code of Practice for Mine Residue Deposits (MRDs) (available on the website www.dme.gov.za (publications)). This code requires each and every mine to set out in writing its intended standards and procedures for the protection of the health and safety of workers, and for the reduction of the risk of damage to persons and property.

Environmental aspects pertaining to the MRD are addressed in each mining companies Environmental Management Programme Report (EMPR), also required in terms of South Africa's Minerals Act (also available at the above web site).

Water quality aspects are controlled by the National Water Act, and a series of six Guideline Documents, M1 to M6.

The design of MRDs in South Africa is guided by SABS 0286: Code of Practice for Mine Residue Deposits.

Sweden

Generally all mining companies have programmes for daily, monthly and yearly inspections/audits, but there are no requirements on independent audits.

Annex 6

Pro Forma TMF Checklist For Visual Inspections

Name/Number of TMF:

Inspected by:

Designation:

Date/Time:

General items	Specific criteria	Defective? Comments	Yes/No
Roadways and access	Condition of roads and ramps		
	Damage and erosion of sides		
Trenches	Flow efficiency		
Drain outlets	Flow efficiency		
Outer perimeter	Evidence of spillage		
	Evidence of seepage		
	Presence of wet areas		
Slurry behaviour	Slurry flowrate		
	Slurry density		
Freeboard	Pond position		
	Pond depth		
	Wall freeboard		
Decant Facility and access	Clarity of discharge fluid		
	Structural integrity of decant		
Return water storage	Available capacity		
	Return water pumps		
Tailings Delivery system	Deposition position		
	Condition of pipes and valves		
Monitoring	Damage to instruments		
	Read according to programme		
Gates and fencing	General condition Signage in place and legible		

Pro Forma TMF Checklist for Annual Review

Name/Number of TMF
Audit by:
Company:

Date/Time:
Designation:
Signature:

General items	Specific criteria	Defective? Yes/No	Comments
Roadways and access	Perimeter roads		
	Access ramps		
Effluent and storm water trenches	Vegetation growth		
	Erosion of sides		
	Flow efficiency		
	Animal damage		
	External wet spots		
Drain outlets	Flow efficiency		
	Breakages		
	Animal life		
Outer perimeter	Evidence of spillage		
	Evidence of seepage		
	Presence of wet areas		
	Vegetation growth		
Outer wall and basin	Quality of wall construction		
	Evidence of cracking		
	Slope geometry		
	Deposition tonnage		
	Slurry density		
	Rate of rise		
	Available capacity		
	Pond depth and position		
Freeboard			

General item	Specific criteria	Defective? Yes/No	Comments
Decant facility and access	Adequacy of catwalk/access		
	Structural integrity of decant		
	Pond wall position/integrity		
	Pond control		
Tailings delivery system	Operation and control		
	Condition of pipes and valves		
	System effectiveness		
Monitoring instruments	Obvious damage		
	Abnormal trends		
	Read according to program		
	Interpretation of results (eg stability analyses)		
Return water storage facility	Storage level		
	Degree of siltation		
	Condition of wall		
	Spillway condition		
	Decant facility		
	Pumps, valves and pipes		
Rehab. work	Monitor against program		
	Fertiliser applications		
	Performance of vegetation		
Water quality	Clarity of decant water		
	Water chemistry testing		
	General condition		
Gates and fencing	Security requirements		
	Signage in place and legible		
	Gates		
General	Routine logs completed		
	Monitoring carried out		
	Emergency preparedness		