

---

4 ALBERT EMBANKMENT  
LONDON SE1 7SR  
Telephone: +44 (0)20 7735 7611 Fax: +44 (0)20 7587 3210

MSC.1/Circ.1498  
16 December 2014

**INFORMATIVE MATERIAL RELATED TO THE IMO/ILO/UNECE CODE OF PRACTICE  
FOR PACKING OF CARGO TRANSPORT UNITS (CTU CODE)**

1 The Maritime Safety Committee, at its ninety-fourth session (17 to 21 November 2014), having considered the proposal by the Sub-Committee on Carriage of Cargoes and Containers, at its first session, approved the Informative material related to the IMO/ILO/UNECE Code of Practice for Packing of Cargo Transport Units (CTU Code), attached hereto.

2 The informative material does not form part of the CTU Code, which was approved by MSC 93 and issued as MSC.1/Circ.1497, but provides additional information and is applicable, as is the CTU Code, to transport operations by all surface and water modes of transport and the whole intermodal transport chain.

3 Member States and international organizations concerned are invited to bring the attached informative material to the attention of all parties concerned\*.

\*\*\*

---

\* The text of the CTU Code and the Informative material related to the CTU Code can also be downloaded from the UNECE website at <http://www.unece.org/trans/wp24/guidelinespackingctus/intro.html>

**Informative material related to the  
IMO/ILO/UNECE Code of Practice for Packing of  
Cargo Transport Units (CTU Code)\***

---

\* Available in English only.

---

**TABLE OF CONTENTS**

<b>IM 1</b>	<b>Consequences of improper packing procedures .....</b>	<b>5</b>
<b>IM 2</b>	<b>Typical documents related to transport.....</b>	<b>10</b>
<b>IM 3</b>	<b>Cargo Transport Unit (CTU) types .....</b>	<b>14</b>
<b>IM 4</b>	<b>Species of concern regarding recontamination .....</b>	<b>59</b>
<b>IM 5</b>	<b>QUICK LASHING GUIDE.....</b>	<b>65</b>
<b>IM 6</b>	<b>Intermodal load distribution.....</b>	<b>120</b>
<b>IM 7</b>	<b>Manual handling .....</b>	<b>128</b>
<b>IM 8</b>	<b>Transport of perishable cargo .....</b>	<b>136</b>
<b>IM 9</b>	<b>CTU seals .....</b>	<b>160</b>
<b>IM 10</b>	<b>Testing CTUs for hazardous gases.....</b>	<b>176</b>

## PREPARATION OF THIS DOCUMENT

This document was prepared by the Group of Experts for the revision of the IMO/ILO/UNECE *Guidelines for Packing of Cargo Transport Units*, which met as part of the continuing cooperation between the International Maritime Organization (IMO), International Labour Organization (ILO) and the United Nations Economic Commission for Europe Transport Division (UNECE) and was finalized by the Sub-Committee on Carriage of Cargoes and Containers (CCC), at its first session (8 to 12 September 2014), at the IMO Headquarters.

## PREFACE

The Group of Experts, at its fourth session (Geneva, 4 to 6 November 2013) at the UNECE, finalized the IMO/ILO/UNECE Code of Practice for Packing of Cargo Transport Units (CTU Code) consisting of 13 chapters and supplemented by 10 annexes. The Group of Experts agreed not to include in the CTU Code material which was of an informative nature. This material was identified as Informative Material (IM), which would be useful to some parties in the transport chain, such as trainers and managers. The informative material does not constitute part of the CTU Code, but provides further practical guidance and technical background information. In this context, the CTU Code references it as IM1 to IM10.



## INFORMATIVE MATERIAL 1

### CONSEQUENCES OF IMPROPER PACKING PROCEDURES

#### 1 Consequences of badly packed and secured cargo

1.1 Cargo that has not been properly packed and sufficiently secured in a Cargo Transport Unit (CTU) may move inside the unit when it is exposed to acceleration, e.g. by hard braking of a vehicle on the road or by heavy ship motions at sea. Moving cargo resulting from improper securing may cause accidents, damage to the cargo, to other cargo or to the CTU. In particular, heavy cargo items may develop inertia forces under such traffic accelerations, which may let them break through the CTU boundaries, endangering persons, environment or property of third parties.



Figure 1.1 – Lack of longitudinal securing



Figure 1.2 – Inadequate side wall strength

1.2 Figure 1.1 shows an example where hard braking and a lack of longitudinal securing has resulted in the cargo breaking through the container doors. Figure 1.2 shows a second example where the cargo has been secured against a vehicle side with inadequate strength.

1.3 Cargo breaking out of CTUs is of particular danger on board ro-ro ships, where shifting cargo and CTUs may affect safe operations on the vehicle deck or the stability of the ship (see figures 1.3 and 1.4).



Figure 1.3 – Cargo breaking out of a trailer



Figure 1.4 – Shifted cargo on a ro-ro deck



**Figure 1.5 – Heavily listing ship after cargo has shifted**

1.4 Cargo having broken out of trailers has caused other trailers to shift and the ship to get a heavy list (see figure 1.5)

1.5 Damage to the cargo is always an economic loss. Additionally, in case of dangerous goods, any damage to a receptacle may impair its containment capability and cause spillage of the contents (see figure 1.8), thus endangering persons and affecting the safety of the transport vehicle or ship.



**Figure 1.6 – Unsecured packages**



**Figure 1.7 – Loose packages on rail wagon**

1.6 Spilled cargo may also endanger the environment. Cargo from road or rail transport may cause contamination of the soil and/or water, and marine pollution when released at sea.



**Figure 1.8 – Spilled liquid dangerous goods**



**Figure 1.9 – Broken IBCs**

## 2 Consequences of insufficient control of humidity

2.1 Some CTUs like containers present a closed box with a specific micro climate. During a long distance transport the moisture contained in the goods and in the packaging material including any timber used for blocking and protection may condense on the inner boundaries of the container or on the cargo or even within the cargo. If sensitive goods are packed carelessly into such a closed CTU, mainly box containers for sea transport, metal parts, if not properly protected, may corrode, clean surfaces may be stained and organic materials may suffer from mould or rot or other degradation.



Figure 1.10 – Mould damage



Figure 1.11 – Condensation damage

2.2 In particular hygroscopic cargoes have variable water content. In ambient air of high relative humidity, they absorb water vapour, while in ambient air of low relative humidity, they release water vapour. If packed into a container in a climate of high relative humidity they would bring a considerable amount of water into the container, providing for an internal high relative humidity. This water may be released from the goods during temperature changes and may condense with the above mentioned consequences. If this threat has not been averted by pre-drying the cargo to a so-called "container-dry" state, the high water content may result in mould, rot and biochemical changes. For some products, these phenomena are also associated with self-heating, which may go as far as spontaneous combustion, for example with oil seeds, oil seed expellers and fish meal.

## 3 Consequences of the use of unsuitable CTUs

3.1 A CTU should be suitable for the particular cargo to be packed:

- .1 climatically sensitive cargoes may require ventilated containers or a CTU with controlled atmosphere (reefer or heated container);
- .2 heavy packages or packages with small footprints may require CTUs capable of carrying concentrated loads; and
- .3 dry bulk powders and granules may require CTUs with stronger end walls, in order to avoid structural failure, overloading, serious damages or cargo losses.



3.2 CTUs showing structural deficiencies may fail under normal transport conditions, e.g. the bottom of a damaged container may collapse when the container is lifted, the front wall of a damaged road vehicle may give way upon hard braking or goods in a container with leaking roof may suffer from water ingress. This makes a thorough pre-check of each CTU essential before packing commences.



Figure 1.12 – Ice from leak in door gasket



Figure 1.13 – Overstressed floor

#### 4 Consequences of overloading of CTUs

4.1 A CTU that is overloaded (i.e. where the combined mass of the cargo and the CTU is greater than the maximum permitted gross mass) presents a serious threat to the safety of work of the various persons along the chain of transport, who are in charge of handling, lifting or transporting the CTU. This applies to all modes of transport on road, rail and sea.

4.2 There are many hazards associated with an overloaded CTU:

4.2.1 When loading or unloading the CTU on or off a ship, vehicle or rail-car and handling the CTU by mobile lifting equipment in a terminal area may result in a failure of the lifting equipment.

4.2.2 While attempting to lift an overloaded CTU from a ship, vehicle or rail-car, the lifting equipment may have inadequate lifting capacity and the lift fails (see figure 1.14) or is aborted. An unacceptable delay will occur while a replacement device with greater capacity is sourced.

4.2.3 Where cranes and lifting equipment are equipped with weight limit controls such failures may not occur; however, as these controls are designed to protect the crane from overstressing, they may not detect that the CTU is overloaded. As a consequence, the overloaded CTU will enter the transport chain and may cause an accident where the CTU turns over or falls from the transport equipment.

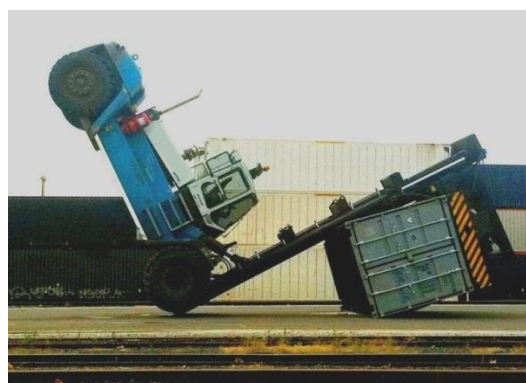

Figure 1.14 – Tipped container handler  
(© abc.net.au)

4.3 A CTU that is not overloaded, may be overweight, i.e. packed with cargo so that the gross mass exceeds the permissible gross mass of the transport vehicle, or that shown on

the transport/shipping documents. This hazard may be aggravated by the road vehicle's driver being unaware of the excess mass, and as a consequence may not adjust his driving habits accordingly. A similar hazard may arise from the specific conditions in intermodal road/rail transport, as rail wagon design does not provide for a sufficient overweight safety margin.

4.4 In view of the above, all efforts should be taken to prevent exceeding the maximum gross mass of the CTU or the capacity of the transport medium. However, if a unit is found to be overloaded or overweight, it should be removed from service until it has been repacked to its maximum gross mass.

4.5 Where there are no facilities for lifting and/or repacking an overloaded or overweight CTU, the CTU operator should arrange transport under the supervision of transport authorities back to the nearest facility where repacking can be undertaken.

## 5 Consequences of improper documentation and misdeclaration

5.1 Missing or incomplete documentation may hamper the proper planning or executing the packing of a CTU. It may also interfere with the further transport and generate delays and, thereby, economic losses. This applies also to the correct and timely communication of non-technical information like the identification number or the seal number.

5.2 Missing information to the carrier identifying extraordinary cargo properties, such as out of gauge packages (over-height, -width or -length), overweight or offset of centre of gravity, may cause damage to the cargo due to inadequate handling methods that could not be adjusted to meet the unusual properties of the packed CTU.

5.3 Missing or incorrect information on dangerous goods may lead to improper stowage of the CTU on the transport vehicle, in particular a ship. In case of an incident such as spillage or fire, missing dangerous goods information will impede emergency response actions.

5.4 Inadequately packed containers or misdeclared container mass may cause container stacks to collapse.



Figure 1.16 – Stack failure

5.5 Incorrect gross mass declared for a CTU could result in overloading of a road vehicle or a rail car, especially if two or more units are loaded on one vehicle or one rail car. In case of sea transport, improper mass declaration of a container may result in an improper stowage position on board the ship and, thereby, in a fatal overstressing of the securing equipment for a stack of containers or the ship's structure.

## INFORMATIVE MATERIAL 2

### TYPICAL DOCUMENTS RELATED TO TRANSPORT

#### 1 The CMR\* note (Road transport)

The CMR note is the consignment note through which the CMR Convention is applied to international road haulage when at least one of the countries is a Contracting Country to the Convention. There are only a very few specific exemptions. Existence of the CMR note confirms that the carrier (i.e. the transport company) has received the goods and that a contract of carriage exists between the consignor/trader and the carrier. If CMR applies to a contract it provides all parties to the contract with the complete regime for the determination of their rights, obligations, liabilities and remedies, in respect of claims for loss, damage or delay to the goods. Unlike a bill of lading, a CMR is not a document of title or a declaration, although some States regard it as such. It does not necessarily give its holder and/or the carrier rights of ownership or possession of the goods, which will be decided by the courts on a case-by-case basis.

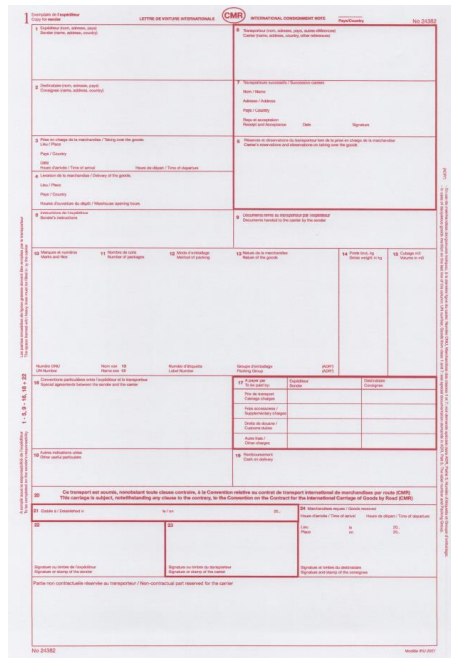

Figure 2.1 – CMR example

#### 2 Forwarders Certificate of Receipt (FCR) (all modes of transport)

2.1 The Forwarders Certificate of Receipt (FCR) was introduced for the use of international freight forwarders. The FCR document enables the freight forwarder to provide the consignor with a special document as an official acknowledgement that he has assumed responsibility of the goods.

2.2 By completing the FCR, the freight forwarder certifies that he is in possession of a specific consignment with irrevocable instructions for despatch to the consignee shown in the document or for keeping it at his disposal. These instructions may only be cancelled if the original FCR document is handed over to the issuing freight forwarder and only if he is in a position to comply with such cancellation or alteration.

2.3 The FCR will primarily be used when the supplier sells the goods ex-works and needs to prove that he has complied with his obligations to the buyer by presenting a FCR. In the case of a Letter of Credit, the seller will, under such conditions, be able to present a FCR issued by a forwarder in order to obtain payment of the sales price placed at his disposal by the buyer under the terms of the Letter of Credit. The seller can no longer dispose of goods handed over to the forwarder once the FCR document has been handed over to the buyer.

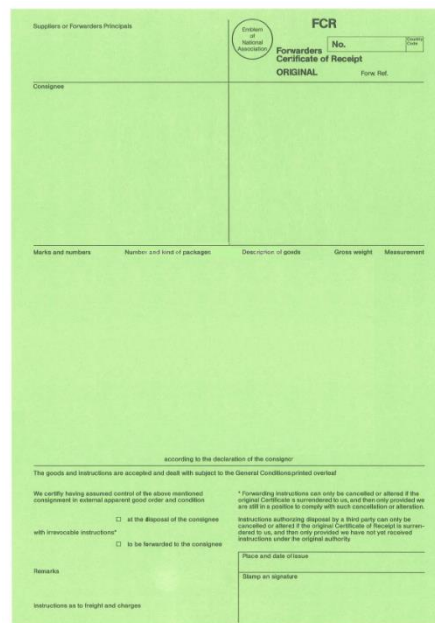

Figure 2.2 – FCR example

\* CMR means the Convention on the Contract for the International Carriage of Goods by Road.

2.4 The FCR is not a negotiable document. As the delivery of the consignment to the consignee does not depend on the handing over of this document, only one original is issued. Should further copies be required, forms specially overprinted with the words "Copy not negotiable" should be used.

2.5 Another similar document, the Forwarders' Certificate of Transport (FCT), is negotiable. This means that the forwarder accepts responsibility to deliver to a destination specified – not to an unchangeable destination as with the FCR.

**3 CIM\* consignment note (Rail transport)**

3.1 This document confirms that the rail carrier has received the goods and that a contract of carriage exists between trader and carrier.

3.2 Unlike a bill of lading, a CIM note is not a document of title. It does not give its holder rights of ownership or possession of the goods.

3.3 Key details to be provided in the note include:

- .1 a description of the goods;
- .2 the number of packages and their weight; and
- .3 the names and addresses of the sender and recipient.

3.4 The consignor is responsible for the accuracy of CIM notes, and is liable for any loss or damage suffered by the carrier due to inaccurate information. Notes are used to calculate compensation if goods are lost or damaged.

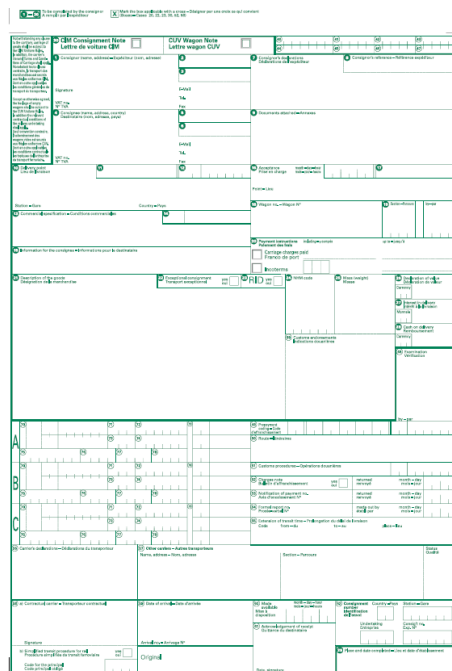

**Figure 2.3 – CIM example**

**4 Export Cargo Shipping Instruction (ECSI) (Sea transport)**

This document may be used to provide the shipping company with details of the goods and set out any specific instructions for the shipment. It follows up on the initial booking, when space will have been confirmed on particular sailings.

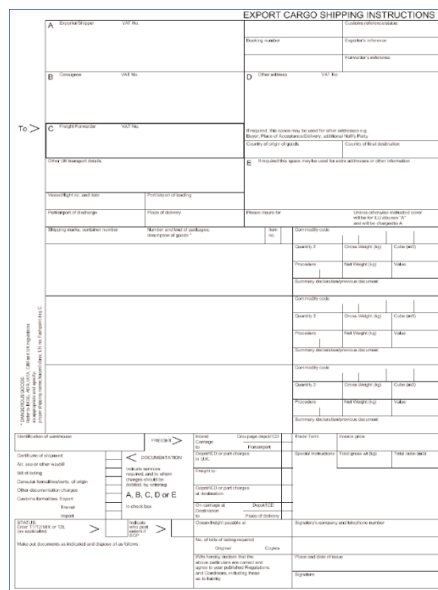

**Figure 2.4 – ECSI example**

\* CIM means Uniform Rules Concerning the Contract of International Carriage of Goods by Rail.



**5 Dangerous Goods Transport Document (Sea transport)**

5.1 If however, the goods are considered to be dangerous as per the IMDG Code, a Dangerous Goods Transport Document will be required. In some countries, this document is also known as Dangerous Goods Note (DGN).

5.2 The Dangerous Goods Transport Document contains a section "Container/vehicle packing certificate". This section must be completed by the person responsible for packing of the dangerous goods into the CTU, who may not necessarily be a representative of the shipper or consignor.

**1 Figure 2.5 – DGN example**

**6 Bill of Lading (BL) (Sea transport)**

The Bill of Lading (BL) is issued by the carrier and serves three purposes:

- .1 it shows that the carrier has received the goods;
- .2 it provides evidence of a contract of carriage; and
- .3 it serves as a document of title to the goods.

**Figure 2.6 – BL example**

**7 Multimodal bill of lading**

7.1 Increasingly, international trade journeys are intermodal, with freight forwarders playing a crucial coordinating role. Many multimodal transports are handled with such a document.



7.2 The Negotiable FIATA\* Multimodal Transport Bill of Lading (FBL) is a carrier-type transport document for the use by freight forwarders acting as Multimodal Transport Operators (MTO).

7.3 A freight forwarder acting as MTO issuing a FBL is responsible for the performance of transport. The freight forwarder does not only assume responsibility for delivery of the goods at the destination, but also for all carriers and third parties engaged by him for the performance of the whole transport.

**8 Sea waybill (SWB) (Sea transport)**

This fulfils the same practical functions as the bill of lading, but does not confer title to the goods and is, therefore, quicker and easier to use. It is often used where there is a well-established trading relationship between commercial parties or in transactions where ownership does not change hands, e.g. between divisions of a single company.

The image shows a standard Sea Waybill (SWB) form. At the top, it is labeled 'SEA WAYBILL No. NOT NEGOTIABLE - COPY'. The form is divided into several sections: 'SHIPPER', 'CONSIGNEE', 'VESSEL & VOYAGE NO.', 'PORT OF LOADING', 'PORT OF DISCHARGE', and 'PLACE OF RECEIPT'. Below these are sections for 'PARTICULARS FURNISHED BY THE SHIPPER' and 'TERMS & CONDITIONS'. A large, diagonal 'SPECIMEN' watermark is overlaid on the entire form.

Figure 2.7 – SWB example

\* FIATA means the International Federation of Freight Forwarders Associations.

**INFORMATIVE MATERIAL 3****CARGO TRANSPORT UNIT (CTU) TYPES**

This informative material provides detailed information on the types of CTU available with the aim of providing packers and shippers with the best possible independent advice.

**1 ISO CONTAINERS****1.1 Containers – General**

1.1.1 A container\* (freight container) is an article of transport equipment which is:

- .1 of a permanent character and accordingly strong enough to be suitable for repeated use;
- .2 specially designed to facilitate the carriage of goods by one or more modes of transport, without intermediate reloading;
- .3 fitted with devices permitting its ready handling, particularly its transfer from one mode of transport to another;
- .4 so designed as to be easy to pack and unpack; and
- .5 having an internal volume of at least 1 m<sup>3</sup> (35.3 ft<sup>3</sup>).

1.1.2 A container is further defined by the CSC†:

- .1 designed to be secured and / or readily handled, having corner fittings for these purposes; and
- .2 of a size such that the area enclosed by the four outer bottom corners is either:
  - .1 at least 14 m<sup>2</sup> (150 ft<sup>2</sup>); or
  - .2 at least 7 m<sup>2</sup> (75 ft<sup>2</sup>), if it is fitted with top corner fittings.

---

\* ISO 830:1999 Freight containers – vocabulary.

† The International Convention for Safe Containers, 1972.

## 1.1.3 ISO container dimensions:

<b>ISO Freight container sizes</b>												
Freight container description		Freight container designation	ISO Size Code	Actual length, <i>L</i>			Width, <i>W</i>			Height, <i>H</i>		
Length	Height			mm	ft	in	mm	ft	in	mm	ft	in
45ft	9ft 6in	1EEE	L5	13,716	45		2,438	8		2,896	9	6
	8ft 6in	1EE	L2							2,591	8	6
40ft	9ft 6in	1AAA	45	12,192	40		2,438	8		2,896	9	6
	8ft 6in	1AA	42							2,591	8	6
	8ft	1A	40							2,438	8	
	Half height	1AX	48							1,295	4	3
30ft	9ft 6in	1BBB	35	9,125	29	11 ¼	2,438	8		2,896	9	6
	8ft 6in	1BB	32							2,591	8	6
	8ft	1B	30							2,438	8	
	Half height	1BX	38							1,295	4	3
20ft	9ft 6in	1CCC	25	6,058	19	10 ½	2,438	8		2,896	9	6
	8ft 6in	1CC	22							2,591	8	6
	8ft	1C	20							2,438	8	
	Half height	1CX	28							1,295	4	3
10ft	8ft	1D	10	12,192	9	9 ¾	2,438	8		2,438	8	
	Half height	1DX	18							1,295	4	3

Figure 3.1 – ISO container sizes

1.1.4 In addition to the standard lengths there are regional / domestic variations, which include 48-foot, 53-foot and longer.

1.1.5 The standard width is 8 ft (2,438 mm), with regional variations of 8ft 6in (United States) and 2.5 m (Europe).

1.1.6 The ISO standard heights are half height (4 ft 3 in / 1,295 mm), 8 ft (2,438 mm), 8 ft 6 in (2,591 mm) and 9 ft 6 in (2,896 mm).

1.1.6.1 There are very few 8-foot high containers left in circulation.

1.1.6.2 Practically all 20-foot long containers are 8 ft 6 in high.

1.1.6.3 Practically all 45-foot long containers are 9 ft 6 in high.

1.1.6.4 Regional heights of 9 ft, 10 ft and 3 m can be found for specific cargoes.

## 1.1.7 Carrying capacity of containers

1.1.7.1 When considering the carrying capacity of containers in terms of mass, three values should be considered:

- .1 Rating (R) or maximum gross mass (MGM). These values refer to the maximum permissible gross mass of the container for which it is designed;
- .2 Tare mass (T) refers to the mass of the container in an empty condition; and

- .3 Maximum payload (P) can be calculated by subtracting the tare from the rating / maximum gross mass ( $P = R - T$ ) and refers to the maximum permissible mass of the cargo carried in the container including the mass of all securing materials and dunnage.

1.1.7.2 Under ISO standards\* all container types and lengths except 10-foot have a maximum rating of 30,480 kg. However, 20-foot, 40-foot and 45-foot long box type containers may be rated at 32,500 kg or 34,000 kg. Platform based containers, including flatracks may be rated up to 55,500 kg. Special containers or those manufactured to previous versions of the standard may have a lesser rating.

1.1.7.3 When planning, the packer may know only the mass of all packages and cargo items. An estimate of the mass of securing materials and dunnage should be made. These values should be added to the tare of the container, which varies from 2,200 kg for a 20-foot general purpose containers to 5,300 kg for a 40-foot folding flatrack. The sum of these three elements produces an estimated gross mass for the container. If this value exceeds 30,480 kg then the packer should contact the CTU operator to see if there are containers with higher ratings available. This estimated gross mass should not be used when providing the verified gross mass of the CTU after packing. For more information concerning verification of the gross mass of containers in international transport, including sea voyage see the *Guidelines regarding the verified gross mass of a container carrying cargo* (MSC.1/Circ.1475).

1.1.7.4 Consideration should be given to local or national road and rail regulations which may limit the permissible gross mass of the packed container.

#### 1.1.8 Floor strengths

1.1.8.1 Floors on freight containers according to the CSC are required to withstand an axle load of 5,460 kg or 2,730 kg per wheel. This value depends on the diameter and width of the wheel and the length of the axle. To achieve this value the wheels are arranged so that all points of contact between each wheel and a flat continuous surface lie within a rectangular envelope measuring 185 mm (in a direction parallel to the axle of the wheel) by 100 mm and that each wheel makes physical contact over an area within this envelope of not more than 142 cm<sup>2</sup>. The wheel width should be nominally 180 mm and the wheel centres should be nominally 760 mm. Using a counterbalance fork lift truck with a front axle in line with these dimensions will permit the movement of 2,000 to 2,500 kg packages.

1.1.8.2 Axle loads may be increased if the wheel diameter or width is increased and the contact area is greater than 142 cm<sup>2</sup>. Conversely, fork trucks with smaller diameter wheels will not be able to move similar mass packages. The CTU operator may be able to provide more precise information.

#### 1.1.9 Fork-lift pockets:

- .1 may be provided on 10-foot and 20-foot containers, but are not generally fitted on 30-foot and longer containers;
- .2 twenty-foot containers are generally fitted with fork-lift pockets with centres of 2,050 mm  $\pm$ 50 mm, which may be used for lifting full containers. Some 20-foot containers may have a second set at 900 mm centres, which should only be used for lifting containers when they are empty. However, this design feature is now almost extinct;

---

\* Standard ISO 668:2013 Series 1 freight containers – Classification, dimensions and ratings.

- .3 according to the ISO standard fork lift pockets may not be fitted on tank containers; and
- .4 when fitted on 30-foot and longer containers, fork-lift pockets should only be used for the lifting of empty containers.

## 1.2 General cargo containers for general purpose (standard ISO 1496, part 1)

Containers built to this international standard include:

- .1 dry freight (box);
- .2 dry freight with bulk capabilities;
- .3 ventilated;
- .4 open top;
- .5 open side; and
- .6 named cargo.

### 1.2.1 Dry freight containers

1.2.1.1 A general purpose container (also known as a GP or dry van) is a container which is totally enclosed and weather-proof. It generally will have a corten steel frame with a rigid roof, rigid side walls, rigid end walls at least one of which is equipped with doors, and a floor. It is intended to be suitable for the transport of cargo in the greatest possible variety.

1.2.1.2 It is not intended for the carriage of a particular category of cargo, such as cargo requiring temperature control, a liquid or gas cargo, dry solids in bulk, cars or livestock or for use in air mode transport.



Figure 3.2 20' GP



Figure 3.3 40' GP



Figure 3.4 45' GP

1.2.1.3 The GP container is by far the largest container type in the intermodal fleet comprising about 90% of the ISO series I (maritime) fleet. The 20ft x 8ft 6in GP container is the largest single container type forming just under half of the GP fleet and about 40% of all container types and sizes.

1.2.1.4 Dimensions and volume:

- .1 there are very few 20-foot long x 9ft 6in high GP containers;
- .2 there are very few 30-foot long GP containers, this length can be considered as obsolete and not available; and
- .3 there are very few 45-foot long GP container that are not 9ft 6in high. GP containers with lower heights can be considered as unavailable.
- .4 minimum internal dimensions and volume:

ISO Freight container internal dimensions													
Freight container description		Freight container designation	Length, L			Width, W			Height, H			Volume, V	
Length	Height		mm	ft	in	mm	ft	in	mm	ft	in	m <sup>3</sup>	ft <sup>3</sup>
45ft	9ft 6in	1EEE	13,522	44	4 ¾	2,330	7	7 ¾	2,655.0	8	9 ½	84	3068
	8ft 6in	1EE							2,350.0	7	9 ½	74	2719
40ft	9ft 6in	1AAA	11,998	39	4 ¾	2,330	7	7 ¾	2,655.0	8	9 ½	74	3043
	8ft 6in	1AA							2,350.0	7	9 ½	66	2697
	8ft	1A							2,197.0	7	2 ½	61	2495
	Half height	1AX							1,054.0	3	6 ¾	29	1236
30ft	9ft 6in	1BBB	8,931	29	3 ¾	2,330	7	7 ¾	2,655.0	8	9 ½	55	2007
	8ft 6in	1BB							2,350.0	7	9 ½	49	1779
	8ft	1B							2,197.0	7	2 ½	46	1646
	Half height	1BX							1,054.0	3	6 ¾	22	809
20ft	9ft 6in	1CCC	5,867	19	3	2,330	7	7 ¾	2,655.0	8	9 ½	36	1220
	8ft 6in	1CC							2,350.0	7	9 ½	32	1081
	8ft	1C							2,197.0	7	2 ½	30	1000
	Half height	1CX							1,054.0	3	6 ¾	14	491
10ft	8ft	1D	2,802	9	2 ⅝ <sub>16</sub>	2,330	7	7 ¾	2,197.0	7	2 ½	14	235
	Half height	1DX							1,054.0	3	6 ¾	7	115

Figure 3.5 – Table of internal dimensions

- .5 minimum door openings:
  - 9 ft 6 in high – 2,566 mm high x 2,286 mm wide;
  - 8 ft 6 in high – 2,261 mm high x 2,286 mm wide; and
  - 8 ft high – 2,134 x 2,286 mm wide.
- .6 load distribution and planning guide:
 

Loads should be evenly distributed across the flooring (see table below). Where the mass of the cargo exceeds either the mass per linear m or per m<sup>2</sup>, the packer should contact the CTU operator for additional advice on concentrated loads.

Length	Tare mass* (kg)	Mass (tonnes) per linear m			Mass (kg) per m <sup>2</sup>		
		30480	32500	34000	30480	32500	34000
45ft	4,400	1.93	2.08	2.19	828	892	939
40ft	4,000	2.21	2.38	2.50	947	1,019	1,073
20ft	2,300	4.80	5.15	5.40	2,061	2,209	2,319

\* Tare Mass value shown above is for planning purposes only

**Figure 3.6 – Guide for load distribution**

1.2.1.5 Strengths:

.1 wall strengths:

- side walls – 0.6P evenly distributed over the entire side wall; and
- front and rear walls – 0.4P evenly distributed over the entire wall.

where P = payload of container; and

Payload is defined as maximum gross mass minus tare mass.

Walls are tested to withstand the above load so that there is no or limited plastic (permanent) deformation. Walls that are tested and found to have a greater plastic deformation will be down rated and this will be marked on the CSC Safety Approval Plate (for more information see the CTU Code, annex 4). Line 7 and/or 8 will be marked with end wall and side wall strength respectively, if it is lesser or greater than the standard load.

.2 cargo securing systems (if provided):

- anchor points are securing devices located in the base structure of the container;
- lashing points are securing devices located in any part of the container other than their base structure;
- they are either fixed, hinged or sliding eyes, rings or bars;

	Number of lashings per side			
	40ft	30ft	20ft	10ft
Anchor points	8	6	5	4
Lashing points	Not specified			

**Figure 3.7 – Table of lashings in ISO container**

- each anchor point should be designed and installed to provide a minimum rated load of 1,000 kg applied in any direction. Many containers have anchor points with a rating of 2,000 kg; and
- each lashing point should be designed and installed to provide a minimum rated load of 500 kg applied in any direction.

1.2.1.6 Typical cargoes:

- .1 the 20-foot long GP container provides the most flexible of all the container types and sizes as it is capable of carrying denser materials and is often used to carry granite, slate and marble blocks;
- .2 the GP container is used for such cargoes as dairy and other "clean" products which require the interior to be "as new" without corrosion and flaking paint. At the other end of the spectrum, the GP container may be used for corrosive materials, such as wet salted hides. It is important that consignors advise the container supplier of the cargo prior to its delivery so that the correct standard of container can be delivered;
- .3 packages can be loaded by hand and stacked across the container, lifted in using a counterbalance or pallet truck, or slid in on skids or slip sheets. When loading using a counterbalance truck, it is important that the axle loads do not exceed the maximum permitted and that the cargo is distributed evenly;



Figure 3.8 – Hand stacking



Figure 3.9 – Using fork truck



Figure 3.10 – Unit load packing

- .4 GP containers are also used to transport cars and small vans either driven and secured to the floor, or secured to specialist racking that can be fitted and removed from the container without any modifications; and



Figure 3.11 – Individual cars



Figure 3.12 – Car racks



Figure 3.13 – Solid bulk



Figure 3.14 – Bulk liquid



- .5 the GP container is also becoming a major transporter of bulk powders, granules and liquids, within dry liner bags or flexitanks.

#### 1.2.1.7 Variations:

- .1 there are a few variations to the basic GP container, some 40-foot GP containers are built with a door at each end. The example shown in figure 3.15 shows the doors above the gooseneck tunnel and fork pockets for handling when empty; and



Figure 3.15 – 40-foot 8ft 6in high double ended container      Figure 3.16 – With doors open

- .2 another variant to the general purpose container is the pallet-wide container. These units have end frames that comply with the requirements of the series-1 ISO freight container, but can accommodate two 1,200 mm wide pallets across the width of the container. This is achieved through a design where the side walls are thinner and moved outside of the ISO envelope.

Pallet-wide containers may not be fitted with anchor points and only have a limited number of lashing points.

### 1.2.2 *Dry freight with bulk capabilities* (see also paragraph 1.5.4)

1.2.2.1 These are dry freight containers fitted with loading hatches in the roof and/or discharge hatches in the end walls.

1.2.2.2 They have the same physical and strength characteristics of the dry freight container.

1.2.2.3 The lashing points along the roof may be fitted with hooks that may only be used to support the bulk liner bag.

### 1.2.3 *Closed vented and ventilated containers*

1.2.3.1 A ventilated container is a closed type of container similar to a general purpose container, but designed to allow air exchange between its interior and the outside atmosphere. It will be totally enclosed and weatherproof, having a rigid roof, rigid side walls, rigid end walls and a floor, at least one of its end walls equipped with doors and that has devices for ventilation, either natural or mechanical (forced).



**Figure 3.17 – 20-foot passive ventilated container**



**Figure 3.18 – Ventilated container inner grill**

1.2.3.2 Vented containers are containers that have passive vents at the upper part of their cargo space. While most containers built now are fitted with two or more vents fitted in the front or side walls, ventilated containers are containers which have a ventilating system designed to accelerate and increase the natural convection of the atmosphere within the container as uniformly as possible, either by non-mechanical vents at both the upper and lower parts of their cargo space, or by internal or external mechanical means.

#### 1.2.3.3 Dimensions and volume

All ventilated containers are 20-foot long and 8 ft 6 in high.

#### 1.2.3.4 Minimum internal dimensions and volume

Similar to the 20-foot GP Container.

#### 1.2.3.5 Minimum door openings

Similar to the 8 ft 6 in high GP containers.

#### 1.2.3.6 load distribution and planning guide

As GP container.

#### 1.2.3.7 Strengths

Similar to the GP container.

#### 1.2.3.8 Typical cargoes

Ventilated containers were developed to carry green coffee beans and other agricultural products. Produce such as melons, oranges, potatoes, sweet potatoes, yams and onions are sometimes carried in ventilated containers.

#### 1.2.3.9 Variations

Most ventilated containers have ventilation grills built into the top and bottom side rails and the front top rail and bottom sill. To further improve the movement of air through the container an electrical fan can be mounted in the door end and connected up to shore and ships' supply. After the cargo has been delivered the fan can be removed and the fan hatch closed so that the container can be used as a GP container. These units are referred to as Fantainers.

## 1.2.4 Open top containers

1.2.4.1 An open top container is similar to a general purpose container in all respects except that it has no permanent rigid roof. It may have a flexible and movable or removable cover, e.g. of canvas, plastic or reinforced plastic material often referred to as a Tarpaulin, "tarp" or "Tilt". The cover is normally supported on movable or removable roof bows. In some cases the removable roof is fabricated from steel that can be fitted to lift off from the top of the container. Containers thus built are known as 'solid top' containers.



Figure 3.19 – 20-foot open (soft) top container



Figure 3.20 – 20-foot open hard top container

1.2.4.2 The open top container is designed to operate with the tarpaulin or hard top fitted or not fitted, therefore to withstand the loads exerted onto the side walls the top side rails are substantially larger than those of a GP container. For the traditional open top container, the top side rail also has to accommodate receptacles for the roof bows and loops for attaching the tarpaulin. It is essential that the tarpaulin is the correct design and the eyelets on the tarpaulin match the eyes on the top side rail, front and back rails and around the corner fittings to ensure the best weather tightness and to permit the TIR wire to be threaded through all of them to maximize security.

1.2.4.3 The open top container was designed for two categories of cargo, those that are too heavy or difficult to load by conventional methods through the doors, or that are too tall for a standard GP container. The hard top, open top container caters for the former but due to the rigid roof, transporting tall cargoes may present problems with moving the roof to the destination.

1.2.4.4 The other feature of the open top container is the ability to pack tall items into the container through the doors, as the header (transverse top rail above the doors) is generally movable or removable (known as 'swing header'). The swinging header either forms a trough into which the tarpaulin is attached or the tarpaulin folds over the front face of the header to prevent water runoff from entering the container. The header is held in place by hinges at each end adjacent to the corner fittings, and each hinge has a removable pin so that the header can be swung out of the way. However, it is advisable to remove both pins and lift the header down using a fork truck rather than leaving the header unsupported at one end.



**Figure 3.21 – 20-foot open top with tilt removed and rear header open**

1.2.4.5 Open tops are generally 20-foot or 40-foot long and 8ft 6in high. There are a few 9 ft 6 in high to cater for some cargoes and which will enable standard tarpaulins or hard tops to be used.

#### 1.2.4.6 Dimensions and volume

With the exception of the removable tarpaulin, roof, the dimensions are generally in line with the GP container.

#### 1.2.4.7 Minimum internal dimensions and volume

Similar to the GP Container.

#### 1.2.4.8 Minimum door openings

Similar to the 8 ft 6 in high GP containers.

#### 1.2.4.9 Load distribution and planning guide

As GP container.

#### 1.2.4.10 Strengths

Similar to the GP container.

#### 1.2.4.11 Typical cargoes

Open top containers carry a variety of tall and heavy, generally project type cargo. Regular cargoes include glass sheets mounted on special A frames often lifted in through the roof and covered using an over height tarpaulin, large diameter tyres for mine vehicles and scrap steel.



**Figure 3.22 – 20-foot open top with scrap steel**



**Figure 3.23 – 20-foot open top with extra large tyres**

#### 1.2.4.12 Variations

There are a few variations from the standard tarpaulin covered open top container. Many designs have been developed to ease the fitting and removal of the tarpaulin roof and roof bows. These include sliding tarpaulins which fold towards the front of the container and captive roof bows that lift out on one side and hang from a bar on the other, thus reducing the risk of loss when an over height cargo is carried.



Figure 3.24 – 20-foot coil carrier



Figure 3.25 – 40-foot ingot and bar carrier

Hard open top containers have been adapted to carry large steel coils or long bars\*. These specialist open top containers may have higher maximum gross mass values.

### 1.2.5 Open side containers

1.2.5.1 The open side container was introduced into the maritime fleet as a GP container variation and as an alternative to the standard curtain sided trailer used in road transport. Original designs had a curtain on one or both sides, a rigid roof and rear doors. Without side walls the base structure had to be self-supporting; therefore required to be more substantial than the GP floor to achieve the same floor strength and load carrying capabilities. In this form the open side container took on some of the characteristics of the platform based container with complete superstructure†. As a consequence of the self-supporting floor the tare generally increased.

1.2.5.2 To improve security some manufacturers offer solid doors in place of the curtains offering doors to one or both sides, with no rear doors, with doors at the rear of the container and with door at the front of the container, offering one, two, three and four side access.

1.2.5.3 The open side container is a specialist item of transport equipment, although the 45-foot long and 2.5 m wide pallet-wide curtain side variation is becoming more popular in Europe. However, the full length side door 20-foot long unit is also becoming popular as a regional variation in other parts of the world.

\* Lanch Ships.

† Platform based container with a permanent fixed longitudinal load carrying structure between ends at the top.



**Figure 3.26 – 45-foot curtain sided swap body**



**Figure 3.27 – 20-foot side door container**

#### 1.2.5.4 Dimensions

As GP container.

#### 1.2.5.5 Minimum internal dimensions and volume

Similar to the GP Container although the internal height is reduced to approximately 2.4 m.

#### 1.2.5.6 Minimum door openings

Reduced height to match the reduction of internal height.

#### 1.2.5.7 load distribution and planning guide

Approximately 10% lower than GP container.

#### 1.2.5.8 Strengths

##### .1 Wall strengths

- side walls – Refer to CSC safety approval plate. Open side containers with tarpaulin sides may have little (0.3P) or no strength; however, some are fitted with removable gates or rigid side doors, which may achieve full side wall strength (0.6P);
- front and rear walls – 0.4P evenly distributed over the entire wall.

##### .2 Cargo securing systems

- Anchor points may be recessed onto the floor but may be rated lower than standard GP containers. Please check with CTU operator.

#### 1.2.5.9 Typical cargoes

Open side containers are designed to carry packages that can be loaded using a fork truck, typically pallets and long packages.



### 1.2.5.10 Variations

Variations are available for specific trades, such as an open side container with a built in half height deck.

Other variations include internal full length or partial length central walls to provide support to the base structure and assist with pallet placement.



Figure 3.28 – 20-foot open side with mezzanine deck

## 1.2.6 Named cargo containers

1.2.6.1 Named cargo types of containers are containers built in general accordance with ISO standards either solely or principally for the carriage of named cargo such as cars or livestock.



Figure 3.29 – Double height car carrier



Figure 3.30 – Single height car carrier



Figure 3.31 – Livestock carrier



Figure 3.32 – Genset container

1.2.6.2 One particular container type is the Power Pack, which can be used to supply 3 phase electricity to reefer containers when carried by rail, to supplement or provide power on board during sea transport or to supplement or provide power in terminals.

1.2.6.3 A power pack would typically consist of a diesel generator set (250kW-00kW) with up to 64 sockets. They can include built in fuel tanks for the generator or use a 20-foot tank container carried in an adjacent slot.

1.2.6.4 Externally it will be the same as a 20-foot GP container.

### 1.3 Thermal containers (ISO 1496, part 2)

1.3.1 A thermal container is a container that has insulating walls, doors, floor and roof. Over the years the thermal container has evolved from a simple insulated container with no device for cooling and/or heating to a refrigerated and insulated container cooled using expendable refrigerants such as ice, "dry ice" (solid carbon dioxide), or liquefied gasses, but again with no external power or fuel supply.

1.3.2 A variation of this design is the porthole container, which is refrigerated by cold air from an external source introduced through a porthole. This design is being phased out.

1.3.3 The most common variant of the thermal container is the integrated refrigerated container, often referred to as the "Reefer". The internal temperature is controlled by a refrigerating appliance such as a mechanical compressor unit or an absorption unit. The Reefer consists of a container body with insulated walls, sides and roof plus insulated doors at the rear. The front of the container body is left open for mounting the refrigeration machinery.



Figure 3.33 – 20-foot refrigerated container



Figure 3.34 – 40-foot refrigerated container

1.3.4 Refrigeration machinery is generally powered by 3-phase electricity supplied by a trailing lead that can be connected to sockets on board ship or in the terminal. Where there is insufficient power capacity freestanding "power packs" can be used. Power packs can also be used to supply power to a number of Reefers being carried by rail. When the Reefer is to be carried by road, unless the journey is relatively short, most cargo owners will require the reefer to be running and for this nose mounted or trailer mounted generator sets are available.

1.3.5 There are some refrigerated containers fitted with integrated power packs, fitted with a diesel generator negating the need for a standalone generator. However, the volume of diesel that these containers can carry is limited and needs to be monitored regularly. These are very specialist pieces of equipment and used on closed loop trades, and are not generally available.

1.3.6 Where Reefers are used to transport chilled or frozen cargo by road, some owners have integral refrigerated containers with the machinery including a diesel generator.

1.3.7 The refrigeration machinery works by passing air through the container from top to bottom. In general, the "warm" air is drawn off from the inside of the container, cooled in the refrigeration unit and then blown back in the container as cold air along the "T" floor grating.



1.3.8 To ensure adequate circulation of the cold air, the floor is provided with "T" section gratings. Pallets form an additional space between container floor and cargo, so also forming a satisfactory air flow channel.

1.3.9 The last form of thermal containers are those that can operate within areas with low or very low ambient temperatures, often servicing areas of extreme cold such as Alaska. The design of these can be based on a thermal as described above except with a heating device, or by the use of a general purpose container fitted with internal insulation and heating filaments.

1.3.10 The mix of Reefer units has changed over the last few years, new purchases of 20-foot and 40-foot long 8ft 6in high Reefer containers has not matched the number of sales of old units, therefore, the fleet size is shrinking. On the other hand the 40-foot 9ft 6in high Reefers have been growing.

1.3.11 Dimensions and volume

Externally the same as 20-foot, 40-foot and 45-foot GP containers.

1.3.12 Typical internal dimensions

ISO Refrigerated container internal dimensions													
Freight container description		Freight container designation	Length, L			Width, W			Height, H			Volume, V	
Length	Height		mm	ft	in	mm	ft	in	mm	ft	in	m <sup>3</sup>	ft <sup>3</sup>
45ft	9ft 6in	1EEE	13,115	43	¼	2,294	7	6½	2,554.0	8	4½	81.5	2,878
40ft	9ft 6in	1AAA	11,590	38		2,294	7	6½	2,554.0	8	4½	67.9	2,398
	8ft 6in	1AA							2,350.0	7	9½	62.5	2,697
20ft	9ft 6in	1CCC	5,468	17	11	2,294	7	6½	2,554.0	8	4½	32.0	1,003
	8ft 6in	1CC							2,350.0	7	9½	29.5	1,081

Figure 3.35 – ISO reefer container dimensions

The dimensions shown above are typical for a steel reefer unit, however, packers are advised to contact the CTU operator for exact internal dimensions.

1.3.13 Door openings

Each thermal container should be provided with a door opening at least at one end.

All door openings and end openings should be as large as possible.

The usable width should correspond with the appropriate minimum internal dimension given in figure 3.35.

The usable height should be as close as practicable to the appropriate minimum internal dimension given in figure 3.35.

1.3.14 Load distribution and planning guide

Length	Tare mass* (kg)	Mass (tonnes) per linear m			Mass (kg) per m <sup>2</sup>		
		30480	32500	34000	30480	32500	34000
40ft	4,700	2.15	2.32	2.44	922	994	1,048
20ft	3,100	4.67	5.01	5.27	2,003	2,151	2,260

\* Tare Mass value shown above is for planning purposes only

### 1.3.14.1 Strengths

#### .1 Wall strengths

- side walls – 0.6P evenly distributed over the entire side wall; and
- front and rear walls – 0.4P evenly distributed over the entire wall.

Walls are tested to withstand the above load so that there is no or limited plastic (permanent) deformation. Walls that are tested and found to have a greater plastic deformation will be down rated and this will be marked on the CSC safety approval plate. Line 7 and/or 8 will be marked with end wall and side wall strength, respectively, if it is lesser or greater than the standard load.

#### .2 Floor

- mechanical handling equipment with narrow wheels may damage the "T" section flooring, and wherever possible the width of the wheels should be greater than twice the distance between centre lines of "T" sections.

#### .3 Cargo securing systems

- there is no requirement for either anchor or lashing points within the ISO standard and very few thermal containers will be fitted with them.

### 1.3.15 Typical cargoes

1.3.15.1 Reefer containers were developed to transport perishable cargoes. A "perishable" may be described as something that is easily damaged or destroyed. Without careful treatment, the time taken to deteriorate to a condition which will either reduce the value or render it unsaleable (shelf life) may become unacceptably short.

1.3.15.2 Careful consideration of the factors affecting the "shelf life" of perishables should be made and applied during their transport.

1.3.15.3 Perishables include frozen produce, meats, seafood, dairy products, fruit and vegetables, horticultural products such as flowering bulbs and fresh flowers plus chemical compounds and photographic materials.

### 1.3.16 Variations

1.3.16.1 Reefers can be fitted with a number of refrigeration units from different suppliers and those can also provide controlled atmosphere provisions.

1.3.16.2 Structurally, special designs have been produced for rail based equipment, 48, 53 and 58-foot long and over wide units (2.6 m).

## 1.4 Tank containers for liquids, gases and pressurized dry bulk (ISO 1496 part 3).

1.4.1 A tank container comprises two basic elements, the tank (barrel) or tanks and the framework and complies with the requirements of ISO 1496-3.\*

1.4.2 In the freight container industry, the term "tank" or "tank container" usually refers to a 20-foot tank container consisting of a stainless steel pressure vessel supported and protected within a steel frame.

1.4.3 The tank container industry has developed a number of containment designs that carry all sorts of bulk liquids, powders, granules and liquefied gases; however, it is important to differentiate bulk liquid and pressurized dry bulk tank containers from non-pressurized dry bulk containers that may look very similar to a tank container.

1.4.4 The majority of the maritime tank container fleet is 20-foot long and 8ft 6in high. The split between the major tank designs is not known although the most current production is generally collar tanks. All the tank designs fulfil the requirements of the ISO standards.

### 1.4.5 Designs

There are three main structural types of tank container used in the international transport of bulk liquids and liquefied gases – beam, frame and collar. All designs have been manufactured since the 1970s.

All designs can be top lifted, must be stackable and the pressure vessel/barrel as well as all valves and other service equipment must remain within the ISO envelope, i.e. no part can protrude past the outer faces of the corner fittings.

#### 1.4.5.1 Frame Tanks

1.4.5.1.1 This design consists of two end frames separated by two main beams at low level forming a support frame. Since there is more material in the support frame than with other designs the tare is relatively high. Often the lower beams are "castellated" a method of lightening the main beams by cutting holes to reduce the tare and therefore to increase the payload. Top rails are often light weight, play little part in the overall structural strength and often there to support the walkway. Top rails in these cases are not usually attached to the pressure vessel. In some designs these rails can be attached using mechanical fasteners (nuts and bolts) but are more often welded in place.

1.4.5.1.2 The pressure vessel is supported from the main beams generally on saddle supports which are in the form of bolted clamps or welded interface supports.



Figure 3.36 – 20,000 l frame tank



Figure 3.37 – 25,000 l frame tank

\* ISO 1496-3, Series 1 freight containers – Specification and testing – Part 3: Tank containers for liquids, gases and pressurized dry bulk.

1.4.5.1.3 The two pictures above show a 20,000 litre (Figure 3.36) and a 25,000 litre design (Figure 3.37). Both are insulated.

#### 1.4.5.2 Beam Tanks

1.4.5.2.1 A beam tank is supported by a series of bearers attached to the end frames which interface with the pressure vessel at various locations on the periphery of the barrel. The interface consists of plates that are welded to the pressure vessel and the bearers to ensure load sharing and a "barrier" between carbon steel and stainless steel components.

1.4.5.2.2 The example shown in Figure 3.38 is a typical beam tank with no top or bottom side rails. The tank is attached using four beams that connect at the four corner fittings of each end frame. The walkway is supported using brackets attached to the pressure vessel.



Figure 3.38 – Beam tank no top rail



Figure 3.39 – Beam tank with top rail

1.4.5.2.3 Figure 3.39 shows a different design where the attachment of the pressure vessel is made using fabricated brackets attached to the corner posts and the end frame corner braces. Top side rails are fitted to the top corner fittings.

1.4.5.2.4 The tank container is also uninsulated. Both examples show 17,500 litre low volume pressure vessels.



Figure 3.40 – Four 10-foot ISO beam tanks

1.4.5.2.5 Figure 3.40 shows four 10-foot ISO International beam tanks, being carried as two 20-foot units. In this example, two 10-foot units are connected using approved horizontal interbox connectors and the design tested in that configuration. They can then be loaded, handled and stowed in the same way as any 20-foot ISO tank container.

### 1.4.5.3 Collar Tanks

1.4.5.3.1 The collar tank is probably the simplest of all the tank designs with a minimum of differing materials in contact with the pressure vessel. Attachment of the pressure vessel to the end frames is by means of a stainless steel collar, which is welded to the pressure vessel end dome at the edge (out-set) or to the crown of the domed ends of the pressure vessel (inset). The collar connects with the side posts, top and bottom rails and the diagonal braces via interface flanges.

1.4.5.3.2 The collar is continuous at the front/non-discharge end. At the rear of the tank container some collar tank designs have a break in the collar where the discharge valve is located.



**Figure 3.41 – 25,000 l collar tank**

1.4.5.3.3 Figure 3.41 shows an insulated 25,000 litre collar tank. Once insulated it is virtually impossible to distinguish between the inset and outset collar design.

### 1.4.6 Dimensions and volume

Practically all maritime tank containers are 20-foot long and 8ft 6in high although there are 30-foot and 40-foot versions.

### 1.4.7 Minimum internal dimensions and volume

Volumes vary from 9,000 to 27,000 litres.

### 1.4.8 Minimum door openings

No doors fitted.

### 1.4.9 Load distribution and planning guide

Tank containers should be filled to minimum of 80% of the total volume. The choice of tank capacity should be taken to achieve this. To accommodate most liquids the maximum gross mass for tank containers varies but is generally 34,000 kg or greater.

### 1.4.10 Typical cargoes

Tank containers can carry practically all liquids, non-regulated, i.e. orange juice, to dangerous goods.

#### 1.4.11 Variations

Tank containers can be supplied uninsulated or insulated, with steam heating, with electrical heating, with refrigerant plants attached, with cooling tubes.

Additionally the tank can be partitioned into two or more discrete compartments or divided with baffle / surge plates.

### 1.5 Non-pressurized containers for dry bulk (ISO 1496 part 4)

1.5.1 Within this type of container, there are a number of variations available. The definition of a non-pressurized dry bulk container is:

*"Container for the transport of dry solids, capable of withstanding the loads resulting from filling, transport motions and discharging of non-packaged dry bulk solids, having filling and discharge apertures and fittings and complying with ISO 1496, part 4."*

1.5.2 Within that standard two sub types are described:

*"Box type – dry bulk non-pressurized container for tipping discharge having a parallelepiped<sup>†</sup> cargo space and a door opening at least at one end, which therefore may be used as a general purpose freight container."*

*"Hopper type – dry bulk non-pressurized container for horizontal discharge having no door opening, which therefore may not be used as a general purpose freight container."*

1.5.3 These are specialized items of equipment and are generally located near companies that are actively involved with the transport of bulk materials. There are a number of specialist companies who provide complete logistics services for bulk dry materials.

#### 1.5.4 Box type

1.5.4.1 Box type bulk containers have the outwards appearance of the GP container with loading and or discharge hatches.

1.5.4.2 Loading hatches are generally round, 600 mm in diameter varying in number from one centrally up to six along the centre line.

1.5.4.3 Discharge hatches come in a number of forms:

- .1 Full width "letterbox" type either in the front wall or in the rear as part of the door structure or "cat flap" type hatches fitted into the rear doors;



Figure 3.42 30-foot dry bulk box container

\* ISO 1496-4:1991, Series 1 freight containers – specification and testing – Part 4: Non-pressurized containers for dry bulk.

† A parallelepiped is a three-dimensional figure formed by six parallelograms. (The term rhomboid is also sometimes used with this meaning).



- .2 In some box type dry bulk containers with full width discharge hatches in the rear (door) end, the hatch can be incorporated into the left hand door, as shown in Figure 3.42, or as shown in Figure 3.44, access is gained to the interior by a smaller right hand door only. Box type bulk containers with this design feature are not available for use as general purpose containers when not being used as bulk containers.



Figure 3.43 – Letterbox type hatch in container front wall



Figure 3.44 – Letterbox type hatch in fixed rear end



Figure 3.45 – Cat flap type hatch in rear doors

1.5.4.4 New type code designations are being introduced for all categories of dry bulk containers.

1.5.4.5 Dimensions and volume

The majority of bulk containers in Europe are 30-foot long and often 2.5 m wide and therefore should be considered as a swap body; however, they have the appearance of an ISO container and are often confused with them.

In other parts of the world the majority of bulk containers are 20-foot long although 40-foot and 45-foot containers have been built for transporting dry bulk materials and cellular friendly pallet-wide containers are also built to the standard ISO 1496, part 4, to increase the internal volume.

1.5.4.6 Minimum internal dimensions and volume

- similar to the GP Container;
- cellular friendly – 2,400 mm internal width.

1.5.4.7 Minimum door openings

For those units with doors, they are broadly similar to 8ft 6in and 9ft 6in high GP containers.

1.5.4.8 Load distribution and planning guide

Dry bulk containers are often built to meet the particular transport requirements of a customer or product. Maximum gross mass can be as high as 38 tonnes which requires specialist road vehicles and handling equipment, but generally the maximum gross mass is higher than for a similar sized GP container.

Thirty-foot dry bulk containers in use in Europe may also be manufactured with reduced stacking capabilities; therefore, are not suitable for stacking more than one fully laden container above it.

#### 1.5.4.9 Strength and rating

##### .1 Wall strengths

- side walls – 0.6P evenly distributed over the entire side wall
- front and rear walls:
  - 40-foot and 30-foot – 0.4P evenly distributed over the entire wall.
  - 20-foot and 10-foot – 0.6P evenly distributed over the entire wall.

##### .2 Cargo securing systems

- there is no requirement for either anchor or lashing points within the ISO standard;
- containers without two opening doors and pallet-wide containers may not have anchor points and may only be fitted with liner support hooks.

#### 1.5.4.10 Typical cargoes

These containers are suitable for all types of dry powder, granules and aggregate generally which are free flowing.

#### 1.5.4.11 Variations

Dry bulk containers for aggregate are generally built with larger loading and/or discharge hatches. They may also be built without a solid top, so blending the dry bulk container with the open top container.

#### 1.5.5 Hopper Type

1.5.5.1 Hopper type dry bulk containers are very specialist items of equipment and are generally built to meet the specific requirements of the cargo to be carried. An example of such a specialist item, shown in figure 3.46, is a 30-foot five compartment silo container with each compartment capable of handling about 6 m<sup>3</sup> of product. When designing silo containers a number of characteristics need to be considered. Firstly the length; 30-foot is associated with European transport and is ideally suited to medium density powders and granules. For higher density cargoes and for deep sea trades, the 20-foot units would be appropriate. For low density cargoes the new internationally approved length of 45-foot is becoming popular. The material, shape and volume of the hopper and discharge will be dictated by the dry cargo being carried and its flowability. Lastly the loading and discharge capabilities will need to be designed to interface with the facilities at origin and destination.



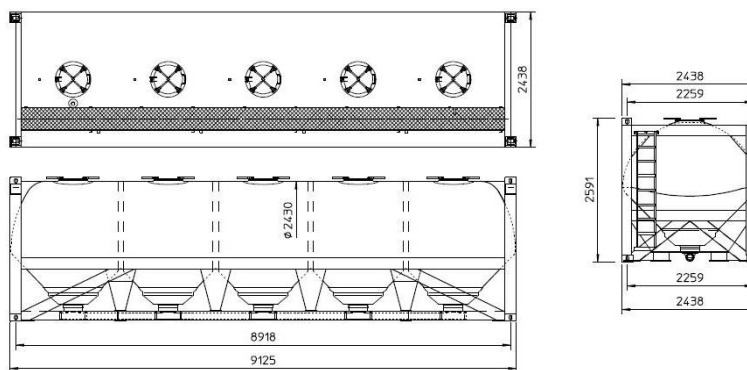

**Figure 3.46 – 30-foot hopper type dry bulk container**

1.5.5.2 In the example shown in figure 3.46, loading is achieved through the top loading hatches and the separate compartments ensure that the container can be evenly loaded and the cargo kept stable from longitudinal movement. Unloading can be either vertical discharge where the container is positioned above receiving hoppers set below the road surface/rail bed or from the rear by horizontal discharge to the rear mounted discharge pipe via an internal conveyor / screw. This type of container would not be tipped.

1.5.5.3 If the cargo is to be discharged vertically by gravity into ground level receiver hoppers then the freight container can either be lifted onto the discharge area or must be mounted on a special trailer/chassis that permits such discharge.

**1.6 Platform and platform based containers (ISO 1496, part 5)**

1.6.1 Platform based containers are specific-purpose containers that have no side walls, but have a base structure. The simplest version is the platform container which has no superstructure whatsoever but is the same length, width, strength requirement and handling and securing features as required for interchange of its size within the ISO series of containers. There are approximately 16,300 platform containers in the maritime fleet.



**Figure 3.47 – 20-foot platforms**



**Figure 3.48 – 40-foot fixed post flatrack**

1.6.2 Since the platform container has no vertical superstructure, it is impossible to load one or more packages on it and then stack another container above it. To do this a platform based container with incomplete superstructure with vertical ends is required. The end structure can consist of posts, posts with transverse rails or complete end walls. The original designs for these were fitted with fixed end walls and were called flatracks.

1.6.3 The next design innovation was to build a platform based container with folding ends which could act as a platform when the end walls/posts were folded down or as a flatrack with the end walls erected.



**Figure 3.49 – 20-foot with portal end frame**



**Figure 3.50 – 40-foot folding flatrack**



**Figure 3.51 – 40-foot folding super rack**

1.6.4 Folding flatracks are now the major project transport equipment with about 151,000 containers in service in the maritime fleet. They can be readily sourced in most locations, although there are areas where concentrations are greater to meet local on-going demand.

#### 1.6.5 Dimensions and volume

1.6.5.1 Platforms and fixed end flatracks are available in 20-foot and 40-foot lengths whereas folding flatracks are available in these two lengths plus a very limited number of 45-foot long containers.

1.6.5.2 Folded flatracks can be stacked using the integral interconnectors for empty transport, forming an 8ft 6in high pile. 20-foot folded flatracks are stacked in groups of 7 and 40-foot in stacks of 4.



**Figure 3.52 – Stack of 40-foot folding end flatracks**

#### 1.6.6 Minimum internal dimensions and volume

1.6.6.1 Flatracks with end walls erected will have internal volume similar to the GP container, although the size of the corner posts will restrict the width at the ends. However, most flatracks are built with end walls that create an 8ft 6in high container so that the distance between the deck and the top of the posts are approximately 1,953 mm (6ft 5in).

1.6.6.2 Owners desiring to fit more or taller cargo "inside" the height of the flatrack walls have started to build some flatracks with higher end walls thus forming a 9ft 6in high container.

1.6.6.3 A progression from that is the flatrack with extendable posts that takes the overall height to 13 ft 6 in high.

1.6.7 Minimum door openings

No doors fitted.

1.6.8 Rating and load distribution

Flatrack maximum gross mass values have increased over the past years, rising from 30,480 kg to 45,000 kg and most 40-foot flatracks are now built to this rating. This means that payloads of approximately 40 tonnes evenly distributed over the deck and supported by the side rails can be lifted and transported by suitable modes. For concentrated loads contact the CTU operator.

1.6.9 Strength and rating

.1 Wall strengths:

- side walls – There is no test for side walls; and
- front and rear walls: Where there is a solid end wall, it must be tested for 0.4P evenly distributed over the entire wall.

.2 Floor strength:

- the flooring material is different from other ISO containers, however, the majority of the load is borne by the main side beams and not the flooring; and
- refer to the CTU operator for more information.

.3 Cargo securing systems

- Anchor points are securing devices located in the base structure of the container.
- Lashing points are securing devices located in any part of the container other than their base structure.

	Number of lashings per side		
	40ft	30ft	20ft
Anchor points	8	6	5
Lashing points	Not specified		

Figure 3.53 – Table for lashings on a flatrack

- Each unit should be fitted with cargo–securing devices complying with the following requirements:
  - The anchor points should be designed and installed along the perimeter of the container base structure in such a way as to provide a total minimum securing capability at least equivalent to:
    - 0.6P transversally; and

- 0.4P longitudinal (for those containers having no end walls or end walls that are not capable of withstanding the full end wall test.
- Such securing capability can be reached either:
  - by a combination of a minimum number of anchor points rated to an appropriate load; or
  - a combination of a higher number of anchor points having a lower individual rated load.
- Each anchor point should be designed and installed to provide a minimum rated load of 3,000 kg applied in any direction.
- Each lashing point should be designed and installed to provide a minimum rated load of 1,000 kg applied in any direction.

#### 1.6.10 Typical cargoes

The platform container and flatrack are used to transport out of gauge packages and items that need special handling. One of the most readily identifiable cargoes carried are road, farm and construction vehicles carried on flatracks or platforms because they are often over-height or width.

#### 1.6.11 Variations

There are a number of variations available from specialist flatrack suppliers, when carrying, for example pipes, coil materials or cars. However, these are generally held for specific trades and are few in number.



**Figure 3.54 – 45-foot car carrying folding flatrack**



**Figure 3.55 – Bin carrier**



**Figure 3.56 – Covered steel coil carrier**



**Figure 3.57 – Open steel coil carrier**

## 2 EUROPEAN SWAP BODY

### 2.1 General

2.1.1 An item of transport equipment having a mechanical strength designed only for rail and road vehicle transport by land or by ferry within Europe and, therefore, not needing to fulfil the same requirements as series 1 ISO containers; having a width and/or a length exceeding those of series 1 ISO containers of equivalent basic size, for better utilisation of the dimensions specified for road traffic.

2.1.2 Swap bodies are generally 2.5 m or 2.55 m wide although thermal swap bodies can be up to 2.6 m wide.

2.1.3 Swap bodies generally fall into three length categories:

Class A: 12.19 (40 ft), 12.5, 13.6 or 13.712 m (45 ft) long

Class B: 30-foot long

Class C: 7.15, 7.45 or 7.8 m long. The most commonly used length in this class is 7.45 m.

2.1.4 Swap bodies are fixed and secured to the vehicles with the same devices as those of series 1 ISO containers: for this reason, such devices are fixed as specified in ISO 668 and ISO 1161, but owing to the size difference are not always located at the swap body corners.

2.1.5 Most swap bodies were originally designed for road and rail transport without the need for stacking and lifting achieved using grapple arms or lowering the swap body onto their own legs (Class C). Class A and B outwardly have the appearance of the ISO container and all sizes are now produced with the ability to top lift and to have limited stacking capability.

### 2.1.6 Stacking

2.1.6.1 All classes of swap body may be stacked if the design permits it and has been subjected to appropriate tests. Such swap bodies will be fitted top fittings. The external faces will be 2.438 m (8 ft) when measured across the unit and 2.259 m between aperture centres.

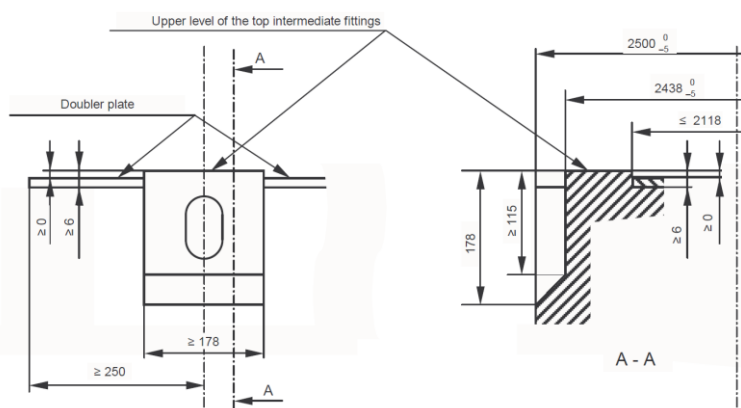

Figure 3.58 – Swap body top fitting detail



**Figure 3.59 – 7.45 Class C stackable swap body with set-back top fittings**

2.1.6.2 The placing of the top corner fittings is such that the swap body can be handled using standard ISO container handling equipment.

2.1.6.3 The stacking capability is generally well below that of the ISO container. Before stacking the swap body, the handler must check the stacking strength shown on the Safety Approval Plate (if fitted) or marks on the swap body to indicate its stacking capability, for example "2 high stacking only".

2.1.6.4 The top fittings will be placed as follows:

- Class A swap bodies will have top fittings at the central 40-foot positions and at the corners;
- Class B will have corner fittings only; and
- Class C box type swap bodies will have corner fittings only. Swap tanks will have the top fittings directly above the lower (at 20-foot positions).

**2.2 Dimensions and rating**

**2.2.1 Swap bodies of Class A (EN 452 and CEN / TS 14993)**

Designation	Length mm)	Length (ft)	Height	Width	Rating (kg)
A 1219	12,192	40	2,670 <sup>1</sup>	2,500 <sup>2</sup>	34,000
A 1250	12,500	41			
A 1360	13,600	44 ft 7 in			
A 1371 <sup>3</sup>	13,716	45	2,900 <sup>4</sup>	2,550	32,000 to 34,000

**Figure 3.60 – Swap body Class A rating**

- 1 The body height of 2,670 mm assures transport without hindrance on the main railway lines of Europe.
- 2 A maximum width of 2,600 mm is permitted for certain thermal bodies according to Council Directive 88/218/EEC. The body width of 2,500 mm assures transport without hindrance throughout Europe.
- 3 Swap bodies for combined transport – stackable swap bodies type A 1371 Technical specification
- 4 Maximum height



## 2.2.2 Swap bodies – non stackable swap bodies of Class C

Designation	Length (mm)	Length (ft)	Height	Width	Rating (kg)
C 745	7,450	24ft 5in	2,750	2,550	16,000
C 782	7,820	25ft 8in			

Figure 3.61 – Swap body Class C rating

## 2.3 Cargo securing devices

Cargo securing devices may be provided in swap bodies as optional features; however, for certain sider swapbodies, cargo securing devices are mandatory.

Where fitted, cargo securing devices should meet the requirements of EN 12640 (Securing of cargo on road vehicles – Lashing points on commercial vehicles for goods transportation – minimum requirements and testing) 2.3.1 Lashing points should be designed so that they transmit the forces they receive into the structural elements of the vehicle. They should be fixed in the loading platform and in the vertical front end wall. In their position of rest they should not project above the horizontal level of the loading platform nor beyond the vertical surface of the front end wall into the loading space.

**NOTE:** The recesses in the loading platform required to accommodate the lashing points should be as small as possible.

2.3.1 Lashing points should be designed to accommodate lashing forces applied from any direction within the conical area determined as follows:

- .1 angle of inclination  $\beta$  from 0° to 60°;
- .2 angle of rotation ( $\alpha$ ) from 0° to 180° for lashing points with a transverse distance from the side wall and the lashing points  $\leq 50$  mm; and
- .3 angle of rotation ( $\alpha$ ) from 0° to 360° for lashing points within a transverse distance from the side wall and the lashing points  $\geq 50$  mm but  $\leq 250$  mm.

2.3.2 Number and layout of the lashing points

2.3.2.1 Lashing points on the floor

The number of lashing points should be determined by the highest result of the following:

- .1 length of the loading platform;
- .2 maximum distance between lashing points; and
- .3 permissible tensile load.

2.3.2.2 Length of the loading platform

For vehicles with an effective cargo loading length greater than 2 200 mm there should be at least 6 lashing points, at least 3 on each side.

## 2.3.2.3 Maximum distance between lashing points

- .1 The lashing points are to be arranged in such a way that:
- with the exception of the area above the rear axle, the distance between two adjacent lashing points on one side should be not more than 1,200 mm. In the area above the rear axle the distance between two adjacent lashing points should be as close to 1,200 mm as practicable but in any case should not be more than 1,500 mm;
  - the distance from front or rear end wall should not be greater than 500 mm;
  - the distance from the side walls of the loading area should be as small as possible and in any case should not be greater than 250 mm.

Loading length (mm)	Number of pairs
7,450	7
7,820	7
9,150 (30 ft)	8
12,190	11
12,500	11
13,600	12
13,719	12

Figure 3.62 Number of lashings based on length

- .2 For vehicles with a maximum authorized total mass greater than 12 tonnes, the number of lashing points  $n$  should be calculated by use of the formula:

$$n = \frac{1.5 \times P}{20}$$

Where  $p$  is the inertial force in KN resulting from the maximum payload

Payload (kg)	Number of lashing points
16,000	12
32,500	24
34,000	25

Figure 3.63 – Number of lashing based on maximum net mass

## 2.3.2.4 Permissible tensile load

Permissible tensile load for lashing points – 20kN.

## 2.4 Strengths

## 2.4.1 End walls

For all designs – 0.4P.

2.4.2 Side walls

Designation	Type	Loading
A 1371	Box	0.6P
Other A Class and C Class	Box	0.3P
	Open sided	0.3P
	Curtain sided	0.24P to 800 mm and 0.06P to remaining upper part (sides may not be used for cargo securing / retaining)
	Drop sided	0.24P on the rigid part and 0.06P to the remaining upper part

Figure 3.64 – Swap body side wall strength by type

2.4.3 Floor strength

Designation	Loading
A 1371	As ISO
Other A Class and C Class	As ISO floor test with test load of 4,400 kg

Figure 3.65 – Swap body floor strength by Class

2.5 Swap body types

2.5.1 Box type swap body

The standard box type swap body will have a rigid roof, side walls and end walls, and a floor and with at least one of its end walls or side walls equipped with doors. There are a number of variations to the basic design that can include units fitted with roller shutter rear door, hinged or roller shutter side doors to one or both sides and garment carriers which are box type swap bodies with single or multiple vertical or horizontal tracks for holding transverse garment rails.



Figure 3.66 – Class C Swap body

2.5.2 Open side swap body

The open side swap body has a number of different variations all designed to provide similar access to that of standard trailer bodies. Each variation will be an enclosed structure with rigid roof and end walls and a floor. The end walls may be fitted with doors.

- .1 Curtain side unit: swap body with movable or removable canvas or plastic material side walls normally supported on movable or removable roof bows.
- .2 Drop side swap bodies: swap bodies with folding or removable partial height side walls and movable or removable canvas or plastic material side walls above normally supported on movable or removable roof bows.
- .3 Tautliner: swap body with flexible, movable side walls (e.g. made of canvas or plastic material normally supported on movable webbing).
- .4 Gated tautliner – swap body fitted with a swinging gate at either end to provide top lift or stacking capability at the 20 or 40-foot positions. A flexible, movable side wall may be fitted between the gates or over the full length of the swap body.
- .5 Full length side door: swap body with full length folding doors to one or both sides.



Figure 3.67 – Class C side door swap body

### **2.5.3 Thermal swap body**

A thermal swap body is a swap body that has insulating walls, doors, floor and roof. Thermal swap bodies may be: insulated – with no device for cooling and/or heating, refrigerated – using expendable refrigerants such as ice, "dry ice" (solid carbon dioxide), or liquefied gasses, and with no external power or fuel supply. Like the ISO container there are variants to this basic design such as the mechanically refrigerated swap reefer.

### **2.5.4 Tank Swap Bodies (Swap Tanks)**

2.5.4.1 There are fewer design variations of swap tanks than for ISO tanks. The most important difference relates to their length, handling and stacking capabilities. All swap tanks have bottom fittings at the ISO 20-foot or 40-foot locations. Generally, the bottom fittings are wider than their ISO counterparts, this is so that the bottom aperture is in the correct ISO position/width while the outer face of the bottom fitting extends to the full width of the unit.

2.5.4.2 Approximately 85% of all swap tanks can be stacked and top lifted. However, the majority of filling and emptying facilities for tanks will leave the tank on its transport equipment thus negating the need for the stacking / lifting capability.



Figure 3.68 – Swap tank showing exposed ends



Figure 3.69 – 30-foot stackable swap tank for powder

2.5.4.3 The swap tank should never be lifted from the side when loaded.

2.5.4.4 There are swap tanks which are not stackable or capable of being lifted using traditional spreaders. The design of these earlier models was similar to the frame tank with the pressure vessel being supported from the bottom side beams. Some non-stackable swap tanks are still built today to meet the particular needs of the industry, particularly intra-European.



Figure 3.70 – Non stackable swap tank

2.5.4.5 A swap tank is a swap body that includes two basic elements, the tank or tanks, and the framework. Unlike the ISO tank container the tank barrel is not always fully enclosed by the frame work which may present a risk of damage.

### 2.5.5 Swap bulker

A swap bulker is a swap body that consists of a cargo carrying structure for the carriage of dry solids in bulk without packaging. It may be fitted with one or more round or rectangular loading hatches in the roof and "cat flap" or "letter box" discharge hatches in the rear and/or front ends. Identical in most ways to the ISO bulk container except that it may have reduced stacking capability. Often 30-foot long.

## 3 REGIONAL, DOMESTIC OR OFFSHORE CONTAINERS

3.1 Regional containers are intended for use within an economic or geographical region and where there are no international maritime legs or where the regional container is not expected to be lifted using standard container handling equipment.

3.2 Domestic or national containers are intended for use within the borders of a nation but may be transported on maritime legs between ports within the national borders.

3.3 Regional or domestic containers may appear to be similar to the ISO container, however, they may:

- .1 have a mechanical strength designed only for rail and road vehicle transport by land or by ferry, and therefore not needing to fulfil the same requirements as series 1 ISO containers;
- .2 can be of any width and/or length to suit national legislation for better utilisation of the dimensions specified for road traffic. In general they will be 2.5 or 2.6 m or 8 ft 6 in wide;
- .3 may have castings at least at each corner and suitable for top lifting;
- .4 may have corner castings that are the same width as the width of the container when measured across the unit to the external faces of the castings;
- .5 may be stacked; and
- .6 Domestic containers may be general cargo containers or specific cargo containers.

### **3.4 Offshore containers**

3.4.1 Offshore containers are intended for use in the transport of goods or equipment handled in open seas to, from and between fixed and/or floating installations and ships. Offshore containers should comply with the provisions of the *Guidelines for the approval of offshore containers handled in open seas* (MSC/Circ.860), as may be amended.

3.4.2 The CSC does not necessarily apply to offshore containers that are handled in open seas. Offshore containers are subject to different design, handling and testing parameters as determined by the Administration. Nonetheless, offshore containers may be approved under the provisions of CSC provided the containers meet all the applicable provisions and requirements of the Convention, in order to undertake international maritime transport.

## **4 ROLL TRAILERS**

4.1 Roll trailers are exclusively used for the transport of goods in RO/RO ships and are loaded or unloaded and moved in port areas only. They present a rigid platform with strong securing points at the sides, and occasionally brackets for the attachment of cargo stanchions. The trailer rests on one or two sets of low solid rubber tyres at about one third of the length and on a solid socket at the other end. This end contains a recess for attaching a heavy adapter, the so-called gooseneck. This adapter has the kingpin for coupling the trailer to the fifth wheel of an articulated truck.

4.2 The packing of a roll trailer with cargo or cargo units must be planned and conducted under the conception that the cargo must be secured entirely by lashings (see CTU Code, annex 7, paragraph 4.3.2). However, roll trailers are available equipped with standardized locking devices for the securing of ISO containers and swap bodies.



## 5 ROAD VEHICLES

### 5.1 Introduction

5.1.1 Vehicles with closed superstructures are the primary choice for cargo that is sensitive to rain, snow, dust, sunlight, theft and other consequences of easy access. Such closed superstructure may consist of a solid van body or a canvas covered framework of roof stanchions and longitudinal battens, occasionally reinforced by side and stern boards of moderate height. In nearly all cases these vehicles have a strong front wall integrated into the closed superstructure. Closed superstructures of road vehicles may be provided with arrangements for applying approved seals.

### 5.2 Road vehicle types

5.2.1 Flatbed – used for almost any kind of cargo, but goods need to be protected from the elements and theft.

5.2.2 Drop side – like a flatbed but with fold down partial height side and rear panels.



Figure 3.71 – Flatbed truck



Figure 3.72 – Drop side truck



Figure 3.73 – Tilt trailer



Figure 3.74 – Curtain side trailer

5.2.3 Tilt – like a flatbed, but with a removable PVC canopy.

5.2.4 Curtain-sider – this has a rigid roof and rear doors. The sides are fabric curtains that can be opened for easy loading.

5.2.5 Open top – similar to the box but with a removable canvas or netting top cover generally used for bulk cargoes. Canvas covered vehicles may be packed or unpacked through the rear doors as well as from the side(s). The side operation is accomplished by forklift trucks operating at the ground level. The option of loading or unloading via the top is limited to vehicles where the canvas structure can be shifted to one or both ends of the vehicle.

5.2.6 Box – a secure option for valuable goods. Solid van superstructures generally have two door wings at the end and will be packed or unpacked by forklift trucks suitable for moving packages inside a CTU.

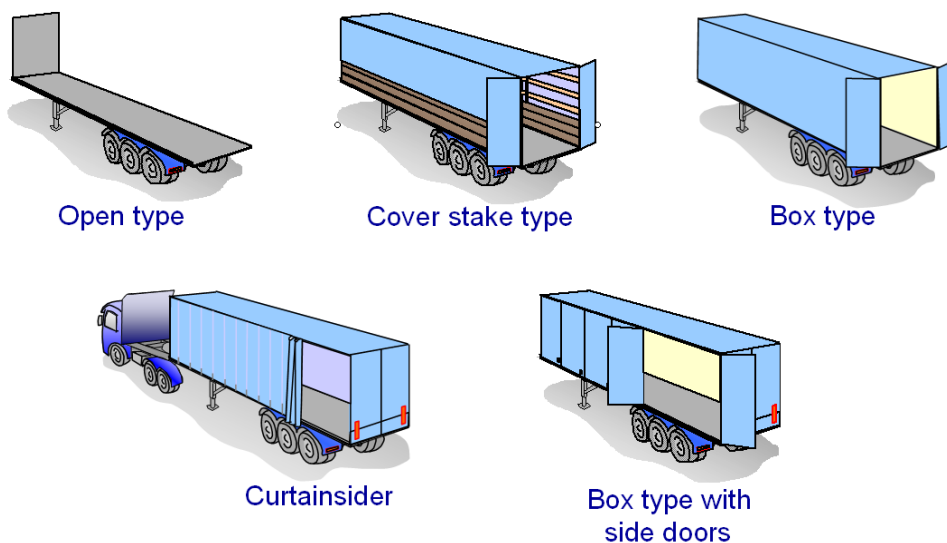

Figure 3.75 – Different types of trailer



Figure 3.76 – Open top trailer



Figure 3.77 – Box trailer



Figure 3.78 – Road train



Figure 3.79 – Low loader



Figure 3.80 – Van

5.2.7 Road train – a rigid vehicle at the front, which pulls a trailer behind it.

5.2.8 Low-loaders – often used for transporting heavy machinery and other outside goods. Set low to the ground for easy loading.

5.2.9 Vans are frequently used to transport smaller cargoes shorter distances.

5.2.10 Semi-trailers suitable for combined road/rail transport may be equipped with standardized recesses for being lifted by suitable cranes, stackers or forklift trucks. This makes a lifting transfer from road to rail or vice versa feasible.

5.3 In addition to the road specific vehicles that are shown above, there are also road vehicles that carry other CTUs:

5.3.1 Container carriers – flatbed, extendable or skeletal trailers designed to carry one or two 20-foot long, or one 30-foot and longer containers.



Figure 3.81 – Container trailer



Figure 3.82 – European swap body train

5.3.2 Swap body system – built to accommodate European swap body units. Allows containers to be swiftly transferred during intermodal transport.

## 5.4 Road vehicle capacity and dimensions

5.4.1 Road vehicles are allocated a specific maximum payload. For road trucks and full trailers the maximum payload is a constant value for a given vehicle and should be documented in the registration papers. However, the maximum allowed gross mass of a semi-trailer may vary to some extent with the carrying capacity of the employed articulated truck as well as in which country it is operating. The total gross combination mass, documented with the articulated truck, should not be exceeded.

5.4.2 The actual permissible payload of any road vehicle depends distinctly on the longitudinal position of the centre of gravity of the cargo carried. In general, the actual payload must be reduced if the centre of gravity of the cargo is conspicuously off the centre of the loading area. The reduction should be determined from the vehicle specific load distribution diagram. Applicable national regulations on this matter should be observed. In particular ISO box containers transported on semi-trailers with the doors at the rear of the vehicle quite often tend to have their centre of gravity forward of the central position. This may lead to an overloading of the articulated truck if the container is loaded toward its full payload.

5.4.3 The boundaries of the loading platform of road vehicles may be designed and made available in a strength that would be sufficient – together with adequate friction – to retain the cargo under the specified external loads of the intended mode of transport. Such advanced boundaries may be specified by national or regional industry standards. However, a large number of road vehicles are equipped with boundaries of less resistivity in longitudinal and transverse direction, so that any loaded cargo should be additionally secured by lashings and/or friction increasing material. The rating of the confinement capacity of such weak boundaries may be improved if the resistance capacity is marked and certified for the distinguished boundary elements of the vehicle.

5.4.4 Road vehicles are generally equipped with securing points along both sides of the loading platform. These points may consist of flush arranged clamps, securing rails or insertable brackets and should be designed for attaching the hooks of web lashings and chains. The lashing capacity of securing points varies with the maximum gross mass of the vehicle. The majority of vehicles is fitted with points of a lashing capacity (LC) or maximum securing load (MSL) of 20 kN. Another type of variable securing device is pluck-in posts, which may be inserted into pockets at certain locations for providing intermediate barriers to the cargo. The rating of the lashing capacity of the securing points may be improved if their capacity is marked and certified.

5.4.5 In Europe, the maximum individual truck length is 12 m, articulated truck and trailer length is 16.5 m and road trains are allowed up to 18.75 m. The maximum width for all is 2.55 m. If a vehicle has an overall height of 3 m or above, a notice is required to be displayed in the cab showing its full height.

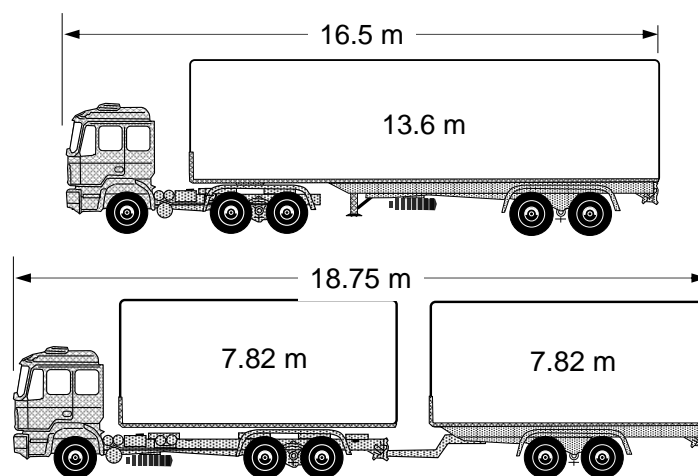

Figure 3.83 – Standard European vehicle length

5.4.6 Other countries set different overall lengths and maximum vehicle masses.

5.4.7 Within Europe trials are currently being undertaken to examine longer and heavier trucks, up to 25 m in the length and 60 tonnes overall gross mass. These sizes may be permitted within regions or areas within Europe.

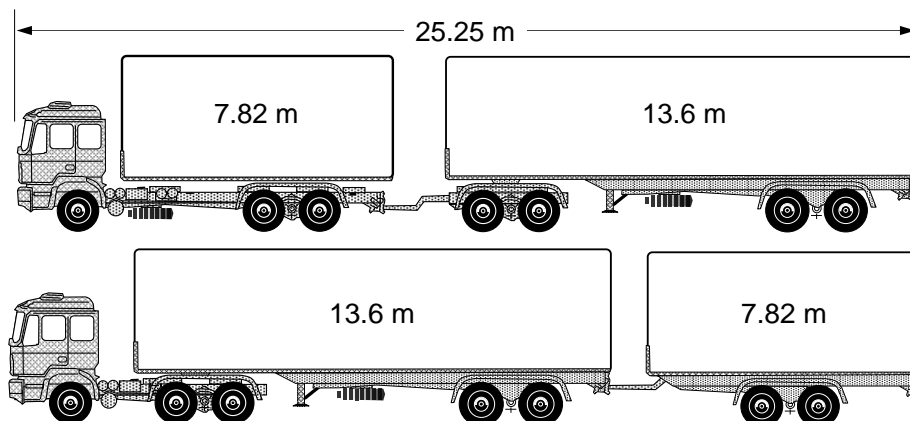

Figure 3.84 European mega trucks

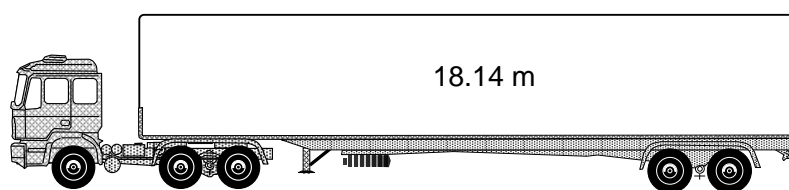

Figure 3.85 – Maximum trailer length in the United States

5.4.8 Within the United States National Highway network, the gross vehicle mass is generally limited to 80,000 lb (36,290 kg) with a maximum overall length varying from 48 ft (14.63 m) to 59 ft 6 in (18.14 m) depending on the state. However, longer combinations vehicles are permitted on specific road routes (corridors).

## 6 RAILWAY WAGONS

### 6.1 General

6.1.1 In intermodal transport, railway wagons are used for two different purposes: First, they may be used as carrier units to transport other CTUs such as containers, swap bodies or semi-trailers. Second, they may be used as CTUs themselves which are packed or loaded with cargo and run by rail or by sea on railway ferries.

6.1.2 The first mentioned purpose is exclusively served by open wagons, which are specifically fitted with locking devices for securing ISO containers, inland containers and swap bodies or have dedicated bedding devices for accommodating road vehicles, in particular semi-trailers. The second mentioned purpose is served by multifunctional closed or open wagons, or wagons which have special equipment for certain cargoes, e.g. coil hutches, pipe stakes or strong lashing points.

6.1.3 On board ferries the shunting twin hooks are normally used for securing the wagon to the ships deck. These twin hooks have a limited strength and some wagons are equipped with additional stronger ferry eyes. These external lashing points should never be used for securing cargo to the wagon.

6.1.4 The maximum payload and concentrated loading marks are described in the CTU Code.

6.1.5 Closed railway wagons are designed for the compact stowage of cargo. The securing of cargo should be accomplished by tight packing or blocking to the boundaries of the wagon. However, wagons equipped with sliding doors should be packed in a way that doors remain operable.

6.1.6 When a railway ferry is operating between railway systems of different gauges, wagons which are capable of changing their wheel sets over from standard gauge to broad gauge or vice versa are employed. Such wagons are identified by the first two figures of the wagon number code.

## 6.2 Intermodal Trains

6.2.1 Intermodal trains come in two forms, unaccompanied and accompanied CTUs.

6.2.2 **Unaccompanied CTUs** (trailers, containers and swap bodies as illustrated in figure 3.86) are lifted on and off rail wagons at terminals using top lift reach stackers or overhead gantries.



Figure 3.86 – Unaccompanied intermodal train



Figure 3.87 – Trailer loading using grapple arms



Figure 3.88 – Container loading using reach stacker

6.2.2.1 The recent trend in container handling equipment being used has been directed towards adjustable spreaders utilising the top lift capabilities of the container and swap body (shown figure 3.88).

6.2.2.2 The introduction of the rolling motorway (RoMo) and trailer on flat car (ToFC) has reinvigorated the used of the grappler arm (shown figure 3.87) originally designed for the swap body.

6.2.3 **Accompanied CTUs** are generally rigid or tractor and trailer units which are driven onto the train wagon. These trains are often point to point services.

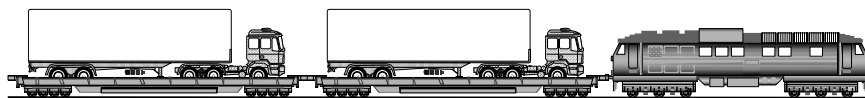

Figure 3.89 – Accompanied intermodal train



Figure 3.90 – Loading road vehicles



6.2.3.1 Accompanied CTU trains will normally have a coach included in the train for the drivers who are accompanying the CTUs.

### 6.3 Wagon Types

6.3.1 The wagons in Europe are divided into thirteen main classes:

#### 6.3.1.1 Open wagons

- Class "E" – Normal open wagon;
- Class "K" – 2 axle flat wagon;
- Class "L" – 2 axle special flat wagon;
- Class "O" – 2 axle flat wagon with sideboards;
- Class "R" – 4 axle flat wagon.



Figure 3.91 – Normal open wagon



Figure 3.92 – 2 axle flat wagon

#### 6.3.1.2 Closed wagons

- Class "G" – Closed wagon;
- Class "H" – Special closed wagon.



Figure 3.93 – Closed wagon



Figure 3.94 – Special closed wagon

#### 6.3.1.3 Special wagons

- Class "F" – Special open wagon;
- Class "I" – Isolated/Refrigerator wagon;

- Class "S" – 4+ axle special flat wagon;
- Class "T" – Wagon with opening roof;
- Class "U" – Special wagon;
- Class "Z" – Tank wagon.



Figure 3.95 – Special open wagon



Figure 3.96 – Special flat wagon

6.3.1.4 Payload limits are often about 25 to 30 tonnes for two axle wagons or 50 tonnes and above for multi axle wagons.

6.3.1.5 The strength requirements according to UIC are described in this chapter for "Covered wagons with fixed or movable roofs and sides conforming to UIC 571–1 and 571–3 and class T wagons" and "High-sided open wagons conforming to UIC 571–1 and 571–2". "Wagons with a fully opening roof complying with UIC 571–3 and wagons with folding roofs" are not described.

## 6.3.2 Wagon types in North America

6.3.2.1 These wagons are divided into nine main classes:

- Class "X" – Box Car Types;
- Class "R" – Refrigerator Car Types;
- Class "V" – Ventilator Car types;
- Class "S" – Stock Car types;
- Class "H" – Hopper Car Types;
- Class "F" – Flat Car types;
- Class "L" – Special Car types;
- Class "T" – Tank Car types;
- Class "G" – Gondola Car types.



Figure 3.97 – Box car



Figure 3.98 – Flat car



Figure 3.99 – Hopper type car



Figure 3.100 – Gondola car

6.3.2.2 In each class the wagons are subdivided depending on payload. The three most common payloads are 50 tonnes, 70 tonnes and 100 tonnes.

## 6.4 Wagon strength guide

This chapter describes the strength of the Box car types and some of the Flat car types. The recommended practices for design and construction also have rules for Hopper Cars and Gondola cars, but it is only the Box car types and Flat car types that are used for general cargo.

### 6.4.1 *European Railways*

#### 6.4.1.1 Covered wagons

- .1 sides with body pillars should be able to withstand a transverse force of 8kN (800 kg) acting at a height of one metre above the wagon floor on a pair of opposite body pillars. A residual deformation of maximum 2 mm is acceptable;
- .2 sides with metal construction should be able to withstand a transverse force of 10kN (1,000 kg) acting at a height of one metre above the wagon floor on the body side at a point located below the end loading hole (or ventilation hole) and in the centre-line of this hole. A residual deformation of maximum 3 mm is acceptable. A 100x100 mm hardwood rod should be used when applying the force.

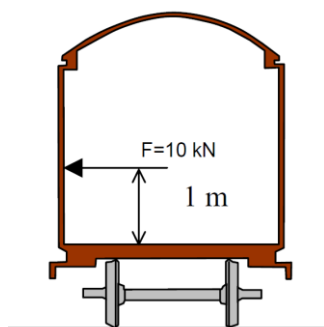

Figure 3.101 – Side wall strength test

#### 6.4.1.2 High-sided open wagons

Sides should be able to withstand a transverse force of 100 kN (10 t) acting at a height of one and a half metre above the wagon floor applied to the four centre pillars. A residual deformation of maximum 1 mm is acceptable.

#### 6.4.2 American Railways

6.4.2.1 For Box car side walls there are no maximum force requirements mentioned in the AAR regulations. There is, however, a maximum force requirement when designing adjustable or fixed side wall fillers in Box cars. Box cars equipped with adjustable side wall fillers at diagonally opposite sides of car, for filling void space crosswise of car, may be used provided such space does not exceed 38 cm. Box cars equipped with full side wall fillers at both sides in both ends of car, for filling void space crosswise of car, may be used provided such space does not exceed 15 cm from each side of car. The wall fillers should be designed to withstand a lateral force equivalent to 25% of the weight of cargo, ( $= 0.25 g$ ). The force should be uniformly distributed over the entire face of the wall filler.







6.4.2.2 Lateral pressure of granular, lump or pulverized bulk material should be considered in the design of wagons in which such pressure may be active. If the weight of the cargo is 4.8 tonnes per metre of length the lateral force from the cargo in a typical closed top 70 tonnes Box car is 10 tonnes per metre of length. The lateral force should be distributed vertically so that it is a maximum at the floor line decreasing uniformly to zero at the top surface of the cargo.

**INFORMATIVE MATERIAL 4**

**SPECIES OF CONCERN REGARDING RECONTAMINATION\***











1 The following table illustrates some of the species of concern ("pests" and/or "invasive alien species") that can be moved internationally within CTUs. Whether or not the species becomes harmful largely depends on the viability of the organism (and/or its reproductive units) upon arrival in a new location, as well as the environmental conditions in the recipient ecosystem.

2 Plants include the seeds and spores.







<b>Plants</b>	
<p><b>Bluestem; Kleberg, Angleton, and yellow</b> <i>Dichanthium annulatum;</i> <i>Dichanthium aristatum;</i> <i>Bothriochloa ischaemum var. songarica</i></p>	
<p><b>Castorbean</b> <i>Ricinus communi</i></p>	
<p><b>Chinese elm</b> <i>Ulmus parvifolia</i></p>	
<p><b>Bushkiller, Java, Javan grape</b> <i>Cayratia japonica</i></p>	
<p><b>Chinaberry, pride of India, Indian lilac, umbrella tree</b> <i>Melia azedarach</i></p>	
<p><b>Chinese wisteria</b> <i>Wisteria sinensis</i></p>	

\* 100 of the World's Worst Invasive Alien Species, owe S., Browne M., Boudjelas S., De Poorter M. (2000) 100 of the World's Worst Invasive Alien Species A selection from the Global Invasive Species Database. Published by The Invasive Species Specialist Group (ISSG) a specialist group of the Species Survival Commission (SSC) of the World Conservation Union (IUCN), 12pp. First published as special lift-out in Aliens 12, December 2000. Updated and reprinted version: November 2004.



<p><b>Cogongrass</b> <i>Imperata cylindrica</i></p> 	<p><b>Elephant ear, coco yam, wild taro</b> <i>Colocasia esculenta</i></p> 
<p><b>Golden bamboo</b> <i>Phyllostachys aurea</i></p> 	<p><b>Japanese climbing fern</b> <i>Lygodium japonicum</i></p> 
<p><b>Japanese honeysuckle</b> <i>Lonicera japonica</i></p> 	<p><b>Johnsongrass</b> <i>Sorghum halepense</i></p> 
<p><b>Lead tree, Leucaena, haole koa</b> <i>Leucaena leucocephala</i></p> 	<p><b>Macartney rose</b> <i>Rosa bracteata</i></p> 
<p><b>Motojo-bobo, childa, alien weed, bitter gingerleaf</b> <i>Lycianthes asarifolia</i></p> 	<p><b>Multiflora rose</b> <i>Rosa multiflora</i></p> 



<p>Old world climbing fern, small leaf climbing fern <i>Lygodium microphyllum</i></p> 	<p>Privet, Chinese <i>Ligustrum sinense</i></p> 
<p>Privet, Japanese <i>Ligustrum japonicum</i></p> 	<p>Russian olive <i>Elaeagnus angustifolia</i></p> 
<p>Silktree mimosa <i>Albizia julibrissin</i></p> 	<p>Tree-of-heaven, Ailanthus, copal tree <i>Ailanthus altissima</i></p> 
<p>Vaseygrass <i>Paspalum urvillei</i></p> 	

## Animals / Insects

**Argentine ant**  
*Linepithema humile*



**Armored catfish, pleco**  
*Hypostomus plecostomus,*  
*Pterygoplichthys anisitsi*

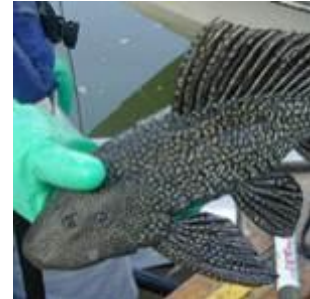

**Asian Gypsy Moth**  
*Lymantria dispar*



**Asian long-horned beetle**  
*Anoplophora glabripennis*



**Asian shore crab**  
*Hemigrapsus sanguineus*



**Asian tiger mosquito**  
*Aedes albopictus*

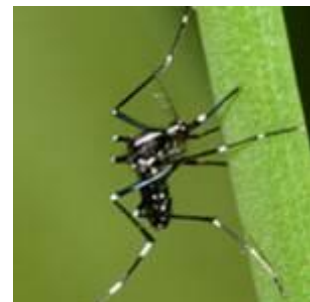











**Australian spotted jellyfish**  
*Phyllorhiza punctata*











**Brown tree snake**  
*Boiga irregularis*



<p><b>Brown/Mexilhao mussel, Green mussel</b> <i>Perna perna, Perna viridis</i></p> 	<p><b>Cactus moth</b> <i>Cactoblastis cactorum</i></p> 
<p><b>Emerald ash borer</b> <i>Agrilus planipennis</i></p> 	<p><b>European green crab, Mediterranean green crab</b> <i>Carcinus maenas, C. aestuarii</i></p> 
<p><b>Indo-Pacific swimming crab</b> <i>Charybdis hellerii</i></p> 	<p><b>Lionfish</b> <i>Pterois volitans</i></p> 
<p><b>Monk parakeet</b> <i>Myiopsitta monachus</i></p> 	<p><b>Muscovy duck</b> <i>Cairina moschata</i></p> 
<p><b>New Zealand mud snail</b> <i>Potamopyrgus antipodarum</i></p> 	<p><b>Pacu, pirapatinga, red-bellied pacu</b> <i>Colossoma sp., Piaractus sp.</i></p> 



<p><b>Red-rim melania</b> <i>Melanoides tuberculatus</i></p> 	<p><b>Red-vented bulbul</b> <i>Pycnonotus cafer</i></p> 
<p><b>Sauerkraut grass, spaghetti Bryozoan</b> <i>Zoobotryon verticillatum</i></p> 	
<p><b>Sirex Wasp</b> <i>Sirex noctilio</i></p> 	<p><b>Sirex wasp larva and tunnel</b></p> 
<p><b>South American cichlids</b> <i>Cichla sp., Cichlasoma sp.</i></p> 	<p><b>Veined rapa whelk</b> <i>Rapana venosa</i></p> 
<p><b>White crust tunicate</b> <i>Didemnum perlucidum</i></p> 	

INFORMATIVE MATERIAL 5

# QUICK LASHING GUIDE

## Cargo securing on CTUs for transports on Road, Combined Rail and in Sea Area A, B & C

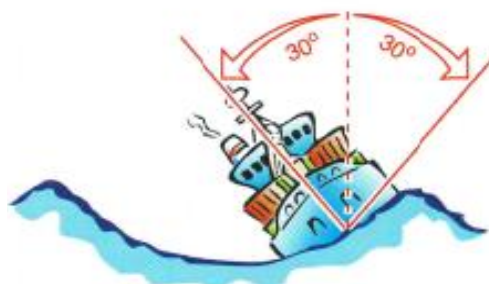
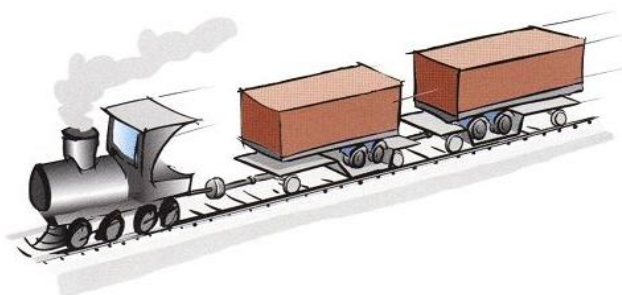

SEA AREAS

A	B	C
$H_s \leq 8 \text{ m}$	$8 \text{ m} < H_s \leq 12 \text{ m}$	$H_s > 12 \text{ m}$
Baltic Sea (incl. Kattegat) Mediterranean Sea Black Sea Red Sea Persian Gulf Coastal or inter-island voyages in following areas: Central Atlantic Ocean (between 30°N and 35°S) Central Indian Ocean (down to 35°S) Central Pacific Ocean (between 30°N and 35°S)	North Sea Skagerak English Channel Sea of Japan Sea of Okhotsk Coastal or inter-island voyages in following areas: South-Central Atlantic Ocean (between 35°S and 40°S) South-Central Indian Ocean (between 35°S and 40°S) South-Central Pacific Ocean (between 35°S and 45°S)	unrestricted

<b>CONTENT</b>	<b>Chapter/Section/Subsection</b>
CARGO SECURING METHODS	1
Blocking and Bracing	1.1
Top-over lashing	1.2
Half-loop lashing	1.3
Straight lashing	1.4
Spring lashing	1.5
BASIC CARGO SECURING REQUIREMENTS	2
Non – rigid goods	2.1
Rolling units	2.2
Bottom blocking	2.3
Supporting edge beam	2.4
Blocking against the doors	2.4
Nailing	2.6
SLIDING - FRICTION	3
TIPPING – DIMENSIONS	4
CARGO SECURING EQUIPMENT	5
Labelling	5.1
Maximum Securing Load (MSL)	5.2
Lashing eyes	5.3
CONVERSION FACTORS FOR OTHER TYPES OF LASHING EQUIPMENT	6
REQUIRED NUMBER OF LASHINGS	7
CARGO STOWED IN MORE THAN ONE LAYER	8
Method 1 (simple)	8.1
Method 2 (advanced)	8.2
ALTERNATIVE METHODS	9
<b>QUICK LASHING GUIDE A</b>	<b>10</b>
GENERAL REMARKS	10.1
WEBBING	10.2
Top-over lashing	10.2.1
Half-loop lashing	10.2.2
Straight lashing	10.2.3
Spring lashing	10.2.4
TAG WASHERS AND NAILS	10.3

<b>QUICK LASHING GUIDE B</b>	<b>11</b>
GENERAL REMARKS	11.1
WEBBING	11.2
Top-over lashing	11.2.1
Half-loop lashing	11.2.2
Straight lashing	11.2.3
Spring lashing	11.2.4
CHAIN	11.3
Top-over lashing	11.3.1
Half-loop lashing	11.3.2
Straight lashing	11.3.3
Spring lashing	11.3.4
STEEL STRAPPING	11.4
Top-over lashing	11.4.1
Half-loop lashing	11.4.2
Straight lashing	11.4.3
Spring lashing	11.4.4
WIRE	11.5
Top-over lashing	11.5.1
Half-loop lashing	11.5.2
Straight lashing	11.5.3
Spring lashing	11.5.4
TAG WASHERS AND NAILS	11.6
<b>QUICK LASHING GUIDE C</b>	<b>12</b>
GENERAL REMARKS	12.1
WEBBING	12.2
Top-over lashing	12.2.1
Half-loop lashing	12.2.2
Straight lashing	12.2.3
Spring lashing	12.2.4
CHAIN	12.3
Top-over lashing	12.3.1
Half-loop lashing	12.3.2
Straight lashing	12.3.3
Spring lashing	12.3.4



STEEL STRAPPING	12.4
Top-over lashing	12.4.1
Half-loop lashing	12.4.2
Straight lashing	12.4.3
Spring lashing	12.4.4
WIRE	12.5
Top-over lashing	12.5.1
Half-loop lashing	12.5.2
Straight lashing	12.5.3
Spring lashing	12.5.4
TAG WASHERS AND NAILS	12.6

## 1 CARGO SECURING METHODS

Goods should be prevented from sliding and tipping in forward, backward and sideways directions by locking, blocking, lashing or a combination of these methods.

### 1.1 Blocking and Bracing

1.1.1 Blocking means that the cargo is stowed against fixed blocking structures and fixtures on the CTU. Clumps, wedges, dunnage, stanchions, inflatable dunnage bags and other devices which are supported directly or indirectly by fixed blocking structures are also considered as blocking.

1.1.2 Blocking is primarily a method to prevent the cargo from sliding, but if the blocking reaches high enough, it also prevents tipping. Blocking is the primary method for cargo securing and should be used as far as possible.

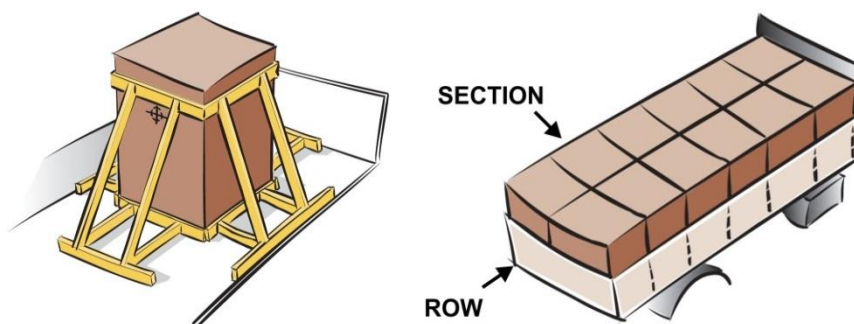

1.1.3 The sum of void spaces in any horizontal direction should not exceed 15 cm. However, between dense rigid cargo items, such as steel, concrete or stone, the void spaces should be further minimized, as far as possible.

### 1.2 Top-over lashing

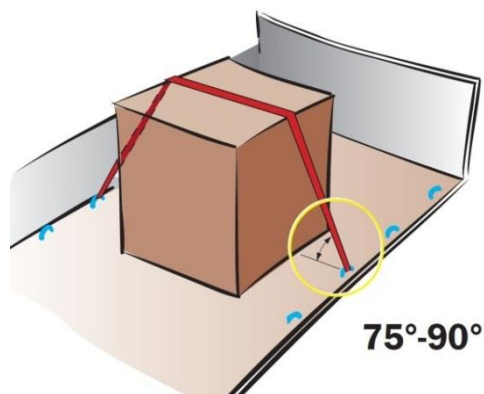

When using the tables for top-over lashing the angle between the lashing and the platform bed is of great importance. The tables are valid for an angle between 75° to 90°. If the angle is between 30° to 75° twice the number of lashings are needed (alternatively the table values are halved). If the angle is less than 30°, another cargo securing method should be used.

Top-over lashings preventing tipping forward **and** backward should be placed symmetrically on the cargo.

### 1.3 Half-loop lashing

A pair of half-loop lashings prevents cargo from sliding and tipping sideways. Minimum one pair of half-loop lashings per section should be used.

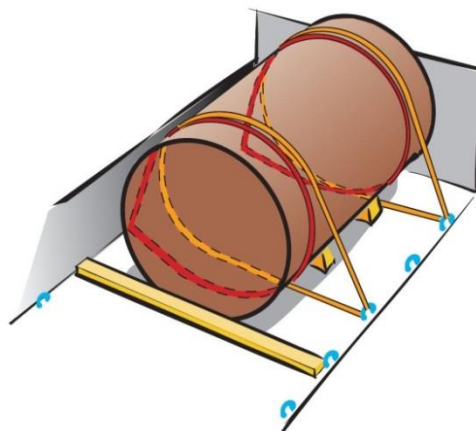
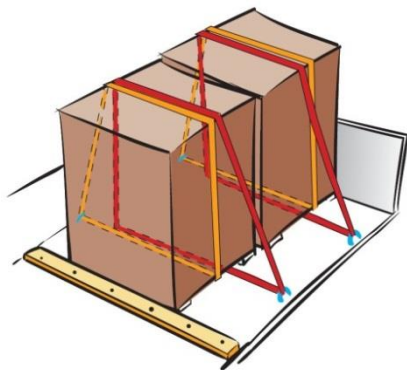

For tipping half the Maximum Securing Load (MSL) value should be used for design purposes.

When long cargo units are secured with half-loop lashings, at least two pairs should be used to prevent the cargo from twisting.

### 1.4 Straight lashing

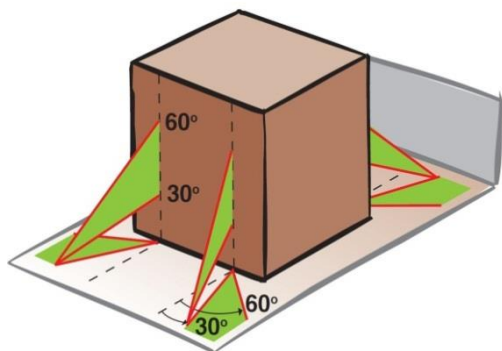

The tables are valid for an angle of 30° to 60° between the lashing and the platform bed.

Sideways and lengthways the lashing angle should also lie between 30° to 60°.

The allowable areas for fixing the lashings on the cargo unit are bounded by straight lines (one for each side), drawn through the centre of gravity in an angle of 45°.

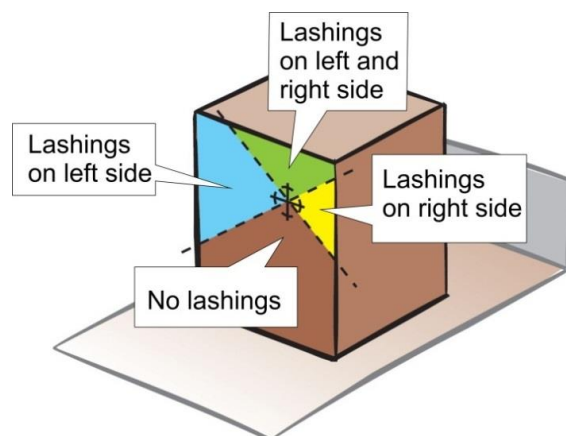

When the lashings are fixed above the centre of gravity, the unit may also have to be blocked at the bottom to prevent sliding.

## 1.5 Spring lashing

1.5.1 A spring lashing is used to prevent cargo from sliding and tipping forward or backward.

1.5.2 The values in the tables for spring lashings are valid when the diagonal parts of the lashing are close to parallel to the long sides of the CTU

1.5.3 The angle between the lashing and the platform bed should be maximum 45°.

1.5.4 There are a number of ways to apply spring lashings, as illustrated below.



A.

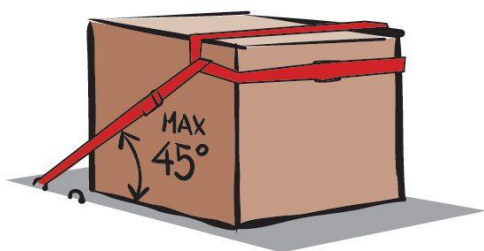

B.

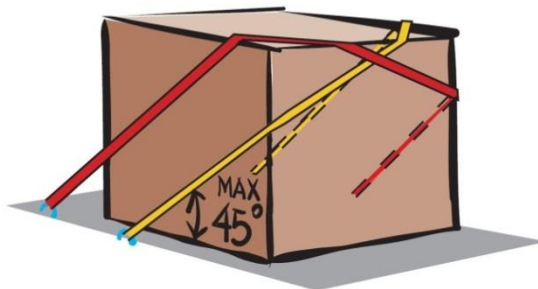

C.

1.5.5 Observe:

- alternative A is not fully effective for tipping avoidance;
- alternative C has two parts per side and thus secures twice the cargo mass given in the lashing tables.

1.5.6 If the spring lashing does not act on the top of the cargo the mass prevented from tipping is decreased, e.g. if the spring lashing acts at half the cargo height, it secures half the cargo mass given in the tipping tables.

1.5.7 For cargo units with the centre of gravity above their half height, the table values for tipping should be halved.

1.5.8 To prevent tipping, the spring lashing should be dimensioned for the mass of the outer section only.

## 2 BASIC CARGO SECURING REQUIREMENTS

### 2.1 Non-rigid goods

If the goods are not rigid in form (bags, bales etc.) more lashings than prescribed in this quick lashing guide may be needed.

### 2.2 Rolling units

If rolling units are not blocked, chocks with a height of at least  $\frac{1}{3}$  of the radius should be used.

If the unit is secured by lashings ensuring that the unit cannot roll over the chocks, the chock height need not to be greater than 20 cm.

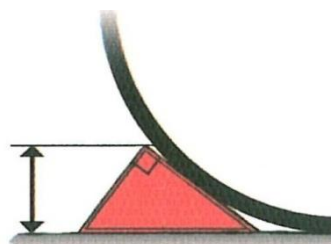

### 2.3 Bottom blocking

Bottom blocking preventing cargo from sliding should have a height of at least 5 cm, if the cargo is not prevented from climbing over the blocking by suitable lashings.

### 2.4 Supporting edge beam

In some cases fewer lashings are needed than the number of sections that are to be secured. Since each unit should be secured, the lashing effect may in these cases be spread out by supporting edge beams. For each end section one lashing should be used as well as at least one lashing per every other section.

These edge beams can be manufactured profiles or deals (minimum 25x100 mm) nailed together.

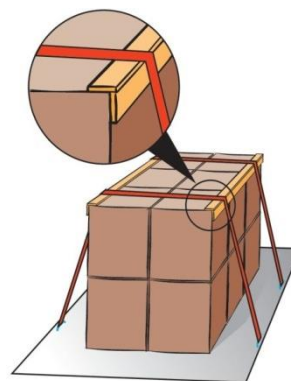

### 2.5 Blocking against the doors

When the door end of a CTU is designed to provide a defined wall resistance (e.g. the doors of a general cargo container) the doors may be considered as a strong cargo space boundary and used for cargo securing, provided the cargo is stowed to avoid impact loads to the door end and to prevent the cargo from falling out when the doors are opened.

### 2.6 Nailing

Nailing to the floor should not be done unless agreed with the CTU supplier.

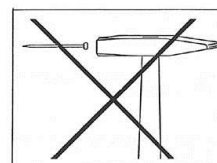

### 3 SLIDING – FRICTION

3.1 Different material contacts have different friction factors ( $\mu$ ). The table below shows recommended values for the friction factor (92.5% of the static friction). The values are valid provided that both contact surfaces are "swept clean" and free from any impurities. In case of direct lashings, where the cargo may move a little before the elongation of the lashings provides the desired restraint force, the dynamic friction applies, which should be taken as 75% of the friction factor. This effect is included in the lashing tables.

Material combination in contact surface	Friction factor $\mu$	
	Dry	Wet
<b>SAWN TIMBER/WOODEN PALLET</b>		
Sawn timber/wooden pallet – fabric base laminate / plywood	0.45	0.45
Sawn timber/wooden pallet – grooved aluminium	0.4	0.4
Sawn timber/wooden pallet – stainless steel sheet	0.3	0.3
Sawn timber/wooden pallet – shrink film	0.3	0.3
<b>PLANED WOOD</b>		
Planed wood – fabric base laminate / plywood	0.3	0.3
Planed wood – grooved aluminium	0.25	0.25
Planed wood – stainless steel sheet	0.2	0.2
<b>PLASTIC PALLETS</b>		
Plastic pallet – fabric base laminate / plywood	0.2	0.2
Plastic pallet – grooved aluminium	0.15	0.15
Plastic pallet – stainless steel sheet	0.15	0.15
<b>CARDBOARD (UNTREATED)</b>		
Cardboard – cardboard	0.5	–
Cardboard – wooden pallet	0.5	–
<b>BIG BAG</b>		
Big bag – wooden pallet	0.4	–
<b>STEEL AND SHEET METAL</b>		
Unpainted metal with rough surface – unpainted rough metal	0.4	–
Painted metal with rough surface – painted rough metal	0.3	–
Unpainted metal with smooth surface – unpainted smooth metal	0.2	–
Painted metal with smooth surface – painted smooth metal	0.2	–
<b>STEEL CRATES</b>		
Steel crate – fabric base laminates / plywood	0.45	0.45
Steel crate – grooved aluminium	0.3	0.3
Steel crate – stainless steel	0.2	0.2

Material combination in contact surface	Friction factor $\mu$	
	Dry	Wet
<b>CONCRETE</b>		
Concrete with rough surface – sawn timber	0.7	0.7
Concrete with smooth surface – sawn timber	0.55	0.55
<b>ANTI-SLIP MATERIAL</b>		
Rubber against other materials when contact surfaces are clean	0.6	0.6
Materials other than rubber against other materials	as certified	

3.2 Friction factors ( $\mu$ ) should be applicable to the actual conditions of transport. When a combination of contact surfaces is missing in the table above or if its friction factor cannot be verified in another way the maximum allowable friction factor of 0.3 should be used. If the surfaces are not swept clean, the maximum allowable friction factor of 0.3 or, when lower, the value in the table should be used. If the surface contacts are not free from frost, ice and snow a static friction factor of 0.2 should be used, unless the table shows a lower value. For oily and greasy surfaces or when slip sheets have been used a friction factor of 0.1 applies.\*

**4 TIPPING – DIMENSIONS**

The dimensions **H**, **B** and **L** as indicated to the right should be used in the tables for tipping for cargo units with centres of gravity close to their geometrical centres.

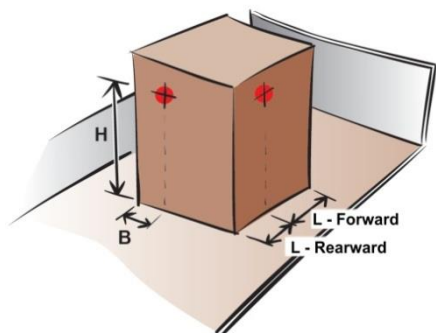
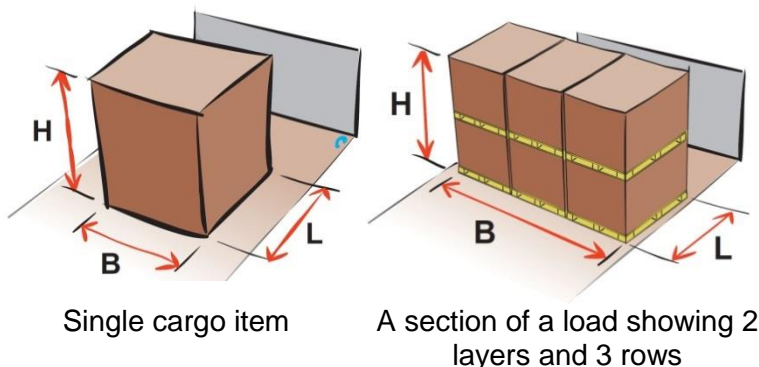

The dimensions **H**, **B** and **L** as indicated to the left should be used in the tables for tipping for cargo units with centres of gravity away from their geometrical centres.

For defining required number of lashings to prevent tipping,  $H/B$  and  $H/L$  should be calculated. The obtained values should be rounded up to the nearest higher value shown in the tables.

\* For sea transport please also see CSS Code Annex 13 sub-section 7.2 *Balance of forces and moments*.



## 5 CARGO SECURING EQUIPMENT

### 5.1 Labelling

5.1.1 Cargo securing equipment may be labelled with one or more of the following quantities:

- **MSL** = Maximum Securing Load
- **LC** = Lashing Capacity (generally used for road transport in Europe)
- **S<sub>TF</sub>** = Standard Tension Force = Pre-tension
- **BS** = Breaking Strength

5.1.2 The unit **daN**, where  $1 \text{ daN} = 1 \text{ kg}$ , is sometimes used to indicate the LC and S<sub>TF</sub> for cargo securing equipment. BS and MSL are usually stated in **kN**, **kg** or **tonnes**.

### 5.2 Maximum Securing Load, MSL

5.2.1 During sea transport the cargo securing arrangements are designed with respect to the **MSL** in the equipment.

5.2.2 If labelling of MSL is missing MSL is primarily taken as LC when dimensioning according to the tables in this Quick Lashing Guide.

5.2.3 Alternatively the MSL for different types of equipment is calculated from the **BS**, according to the table below:

Equipment	MSL
Web lashing, reusable	50% of BS
Web lashing, single use	75% <sup>*)</sup> of BS
Chain lashing (class 8), speed lash, turnbuckle	50% of BS
Wire, new	80% of BS
Wire, used	30% of BS
Steel strapping	70% of BS
Tag washer	50% of BS
Air bag, reusable	50% of BS
Airbag, single use	75% of BS
*) Maximum 9% elongation at MSL	



5.2.4 If labelling of the pre-tension force is missing **10% of BS**, although not more than 1,000 kg, may be used as pre-tension when dimensioning according to the tables in this Quick Lashing Guide.

### 5.3 Lashing eyes

The lashing eyes should have at least the same strength in MSL as the lashings. For a half-loop lashing the lashing eye should have at least the strength of  $1.4 \times \text{MSL}$  of the lashing if both ends of the lashing are fixed to the same eye.

## 6 CONVERSION FACTORS FOR OTHER TYPES OF LASHING EQUIPMENT

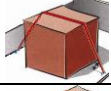
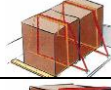
6.1 For lashing equipment with MSL and pre-tension other than those shown in tables in this quick lashing guide, the table values should be multiplied by a conversion factor corresponding to the actual lashing method and type of equipment (see the table below). All values used should be taken in **daN**, where  $1 \text{ daN} \approx 1 \text{ kg}$ .

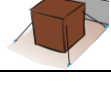
Lashing method		Webbing	Chain	Steel strapping	Wire
Top-over lashing		Pre-tension*/400	Pre-tension*/1,000	Pre-tension*/240	Pre-tension*/1,000
Half-loop lashing		MSL*/2,000	MSL*/5,000	MSL*/1,700	MSL*/9,100
Spring lashing					
Straight lashing					
* Pre-tension and MSL are the values for the lashing equipment intended to be used					

6.2 **Example:** A cargo unit is intended to be transported in Sea Area C. How many tons are prevented from sliding sideways by a pair of half-loop web lashings with MSL 4 ton, if the friction factor is 0.3?

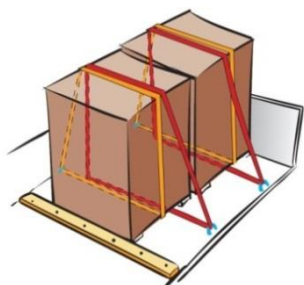

The quick lashing guide shows that a pair of half-loop **web lashings** with MSL 2,000 daN prevents 4.3 tonnes of cargo from sliding sideways in Sea Area C, when the friction factor is 0.3.

MSL for the current web lashing is 4 tonnes  $\approx 4,000 \text{ daN}$ .

6.3 According to the table above, the conversion factor for half-loop lashings is;  $\text{MSL}/2,000 = 4,000/2,000 = 2$ . The cargo mass prevented from sliding according to the lashing table should be multiplied by the conversion factor and each pair of half-loop web lashings thus prevents  $2 \times 4.3 = 8.6$  tonnes of cargo from sliding sideways. This means that the cargo mass is prevented from sliding by a pair of half-loop lashings can be doubled when the MSL value for the lashing is doubled as long as the lashing eyes are strong enough.

## 7 REQUIRED NUMBER OF LASHINGS

7.1 The lashing tables in this quick lashing guide show the cargo mass in tonne (1,000 kg) prevented from sliding or tipping per lashing. The values in the tables are rounded to two significant figures.

7.2 The required number of lashings to prevent sliding and tipping should be calculated by the help of the tables on the following pages according to the following procedure:

- .1 calculate the required number of lashings to prevent sliding;

- .2 calculate the required number of lashings to prevent tipping;
- .3 the largest number of the above should be selected

7.3 "No slide" and "no tip" indicated in the tables means that there is minimal risk of the cargo sliding or tipping respectively. Even if there is neither sliding nor tipping risk, it is recommended to always use at least one top-over lashing per every 4 tonnes of cargo or similar arrangement to avoid wandering for non-blocked cargo due to vibrations.

## **8 CARGO STOWED IN MORE THAN ONE LAYER**

### **8.1 Method 1 (simple)**

- .1 determine the number of lashings to prevent sliding using the mass of the entire section and the lowest friction of any of the layers;
- .2 determine the number of lashings to prevent tipping;
- .3 the largest number of lashings in step 1 and 2 should be used.

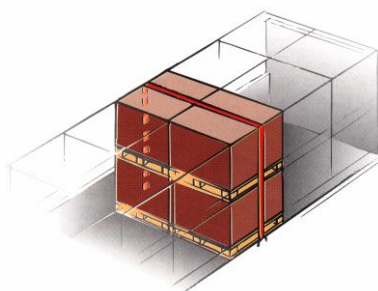

### **8.2 Method 2 (advanced)**

- .1 determine the number of lashings to prevent sliding using the mass of the entire section and the friction for the bottom layer;
- .2 determine the number of lashings to prevent sliding using the mass of the section's upper layer and the friction between the layers;
- .3 determine the number of lashings for the entire section which is required to prevent tipping;
- .4 the largest number of lashings in steps 1 to 3 should be used.

## 9 ALTERNATIVE METHODS

Nothing in the CTU Code should be interpreted as specifying that a particular securing method should be used. Proven alternatives for securing cargo within containers, such as a properly applied adhesive-based fabric restraint system (see figure below) already exist and future innovations and advances in technology may also result in other suitable methods, providing an equivalent means of cargo securing, being developed. In all cases in which patent systems are used, however, it is important to realize that the systems can only be fully effective when properly applied as designed in full conformance with manufacturer's instructions.

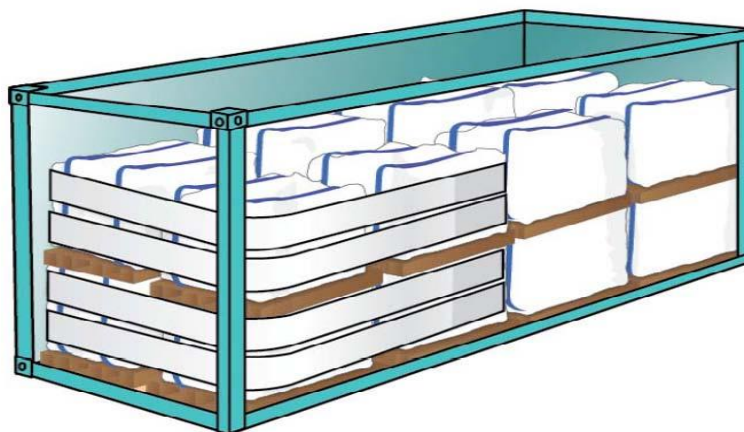

## 10. QUICK LASHING GUIDE A

### Cargo securing on CTUs for transports on Road, Combined Rail and in Sea Area A

#### 10.1 General Remarks

10.1.1 Accelerations to be expected expressed in parts of the gravity acceleration ( $1g = 9.81 \text{ m/s}^2$ ).

Transport mode/ Sea area	Sideways		Forward		Backward	
	S	V	F	V	B	V
Road	0.5	1.0	0.8	1.0	0.5	1.0
Combined Rail	0.5	1.0	0.5	1.0	0.5	1.0
Sea Area A	0.5	1.0	0.3	0.5	0.3	0.5

*V = Vertical acceleration to be used in combination with horizontal accelerations; S Sideways, F Forward and B Backward.*

10.1.2 Goods not rigid in form

If the goods are not rigid in form, more lashings than stipulated in this quick lashing guide could be required.

10.1.3 Sideways, forward and backward refers to a fore-and-aft stowed CTU.

10.2 WEBBING

10.2.1 Top-over lashings



The tables are valid for **webbing** with an MSL of 20 kN or 2,000 daN – (2,000 kg = 2 tonnes) and a pre-tension of minimum 4 kN or 400 daN – (400 kg).

The values in the tables are proportional to the pre-tension in the lashings.

The masses in the tables are valid for one top-over lashing.

TOP-OVER LASHING

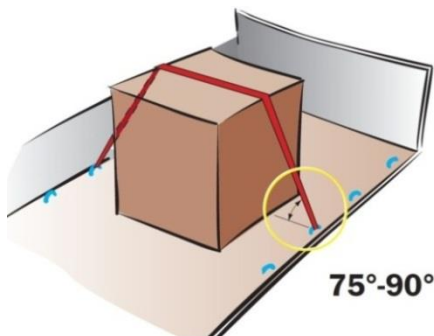

Cargo mass in tonnes prevented from sliding per top-over lashing			
$\mu$	SIDEWAYS	FORWARD	BACKWARD
0.00	0.00	0.00	0.00
0.05	0.08	0.05	0.08
0.10	0.18	0.10	0.18
0.15	0.30	0.16	0.30
0.20	0.47	0.24	0.47
0.25	0.71	0.32	0.71
0.30	1.1	0.43	1.1
0.35	1.7	0.55	1.7
0.40	2.8	0.71	2.8
0.45	6.4	0.91	4.3
0.50	no slide	1.2	7.1
0.55	no slide	1.6	16
0.60	no slide	2.1	no slide
0.65	no slide	3.1	no slide
0.70	no slide	5.0	no slide

Cargo mass in tonnes prevented from tipping per top-over lashing								
H/B	SIDEWAYS					H/L	FORWARD	BACKWARD
	1 row	2 rows	3 rows	4 rows	5 rows		per section	per section
0.6	no tip	no tip	no tip	6.3	2.9	0.6	no tip	no tip
0.8	no tip	no tip	5.4	2.1	1.4	0.8	no tip	no tip
1.0	no tip	no tip	2.2	1.3	0.96	1.0	no tip	no tip
1.2	no tip	4.5	1.3	0.90	0.72	1.2	no tip	no tip
1.4	no tip	2.2	0.98	0.70	0.58	1.4	5.9	no tip
1.6	no tip	1.5	0.77	0.57	0.48	1.6	2.5	no tip
1.8	no tip	1.1	0.63	0.48	0.41	1.8	1.6	18
2.0	no tip	0.89	0.54	0.42	0.36	2.0	1.2	7.1
2.2	7.1	0.74	0.47	0.37	0.32	2.2	0.93	4.4
2.4	3.5	0.64	0.41	0.33	0.29	2.4	0.77	3.2
2.6	2.4	0.56	0.37	0.30	0.26	2.6	0.66	2.4
2.8	1.8	0.50	0.34	0.27	0.24	2.8	0.57	1.8
3.0	1.4	0.45	0.31	0.25	0.22	3.0	0.51	1.4

**10.2 WEBBING**



**10.2.2 Half-loop lashings**

The tables are valid for **webbing** with an MSL of 20 kN or 2,000 daN – (2,000 kg = 2 tonnes) and a pre-tension of minimum 4 kN or 400 daN – (400 kg).

The masses in the tables below are valid for one pair of half-loop lashings.

The values in the tables are proportional to the maximum securing load (MSL) in the lashings.

**HALF-LOOP LASHING**

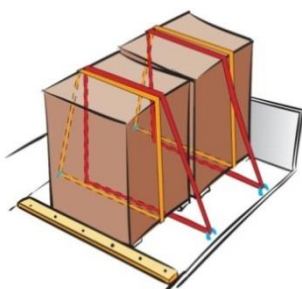

Cargo mass in tonnes prevented from sliding <i>per pair of half-loop lashing</i>	
$\mu$	SIDEWAYS
0.00	4.1
0.05	4.6
0.10	5.2
0.15	5.9
0.20	6.7
0.25	7.7
0.30	9.1
0.35	11
0.40	13
0.45	17
0.50	no slide
0.55	no slide
0.60	no slide
0.65	no slide
0.70	no slide

Cargo mass in tonnes prevented from tipping <i>per pair of half-loop lashing</i>					
SIDEWAYS					
H/B	1 row	2 rows	3 rows	4 rows	5 rows
0.6	no tip	no tip	no tip	18	8.2
0.8	no tip	no tip	15	5.9	4.1
1.0	no tip	no tip	6.1	3.6	2.7
1.2	no tip	13	3.8	2.5	2.0
1.4	no tip	6.4	2.8	2.0	1.6
1.6	no tip	4.2	2.2	1.6	1.4
1.8	no tip	3.2	1.8	1.4	1.2
2.0	no tip	2.5	1.5	1.2	1.0
2.2	20	2.1	1.3	1.0	0.91
2.4	10	1.8	1.2	0.94	0.82
2.6	6.8	1.6	1.1	0.85	0.74
2.8	5.1	1.4	0.96	0.78	0.68
3.0	4.1	1.3	0.87	0.71	0.63



**10.2 WEBBING**



**10.2.3 Straight lashings**

The tables are valid for **webbing** with an MSL of 20 kN or 2,000 daN – (2,000 kg = 2 tonnes) and a pre-tension of minimum 4 kN or 400 daN – (400 kg).

All masses are valid for one straight lashing.

The values in the tables are proportional to the maximum securing load (MSL) in the lashings.

**STRAIGHT LASHING**

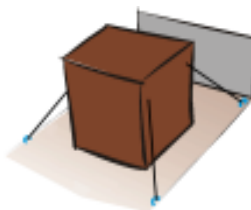

Cargo mass in tonnes prevented from sliding <i>per straight lashing</i>			
$\mu$	SIDEWAYS per side	FORWARD	BACKWARD
0.00	1.0	0.64	1.0
0.05	1.2	0.76	1.2
0.10	1.5	0.89	1.5
0.15	1.8	1.0	1.8
0.20	2.2	1.2	2.2
0.25	2.7	1.4	2.7
0.30	3.3	1.6	3.3
0.35	4.1	1.8	4.1
0.40	5.2	2.1	5.2
0.45	6.8	2.4	6.8
0.50	no slide	2.8	10
0.55	no slide	3.2	13
0.60	no slide	3.7	no slide
0.65	no slide	4.4	no slide
0.70	no slide	5.2	no slide

Cargo mass in tonnes prevented from tipping <i>per straight lashing</i>				
H/B	SIDEWAYS per side	H/L	FORWARD	BACKWARD
0.6	no tip	0.6	no tip	no tip
0.8	no tip	0.8	no tip	no tip
1.0	no tip	1.0	no tip	no tip
1.2	no tip	1.2	no tip	no tip
1.4	no tip	1.4	10	no tip
1.6	no tip	1.6	4.7	no tip
1.8	no tip	1.8	3.2	36
2.0	no tip	2.0	2.5	15
2.2	16	2.2	2.1	10
2.4	8.7	2.4	1.9	7.9
2.6	6.1	2.6	1.7	6.1
2.8	4.8	2.8	1.6	4.8
3.0	4.1	3.0	1.5	4.1

## 10.2 WEBBING



### 10.2.4 Spring lashings

The tables are valid for **webbing** with an MSL of 20 kN or 2,000 daN – (2,000 kg = 2 tonnes) and a pre-tension of minimum 4 kN or 400 daN – (400 kg).

The masses in the tables are valid for one spring lashing.

The values in the tables are proportional to the maximum securing load (MSL) in the lashings.

#### SPRING LASHING



Cargo mass in tonnes prevented from sliding <i>per spring lashing</i>		
$\mu$	FORWARD	BACKWARD
0.00	3.6	5.8
0.05	3.9	6.5
0.10	4.3	7.3
0.15	4.7	8.3
0.20	5.1	9.5
0.25	5.6	11
0.30	6.1	13
0.35	6.8	15
0.40	7.5	19
0.45	8.3	24
0.50	9.3	35
0.55	11	43
0.60	12	no slide
0.65	14	no slide
0.70	16	no slide

Cargo mass in tonnes prevented from tipping <i>per spring lashing</i>		
H/L	FORWARD	BACKWARD
0.6	no tip	no tip
0.8	no tip	no tip
1.0	no tip	no tip
1.2	no tip	no tip
1.4	67	no tip
1.6	33	no tip
1.8	24	259
2.0	19	115
2.2	17	79
2.4	15	63
2.6	14	50
2.8	13	40
3.0	12	35

**10.3 TAG WASHERS AND NAILS**

<b>TAG WASHER</b>							
							
Approximate cargo mass in tonnes prevented from sliding by one tag washer for wood on wood in combination with top-over lashing only							
$\mu^{**}$	<b>SIDEWAYS</b>						
	$\varnothing$ 48	$\varnothing$ 62	$\varnothing$ 75	$\varnothing$ 95	30x57	48x65	130x130
BS(ton)	0.5	0.7	0.9	1.2	0.5	0.7	1.5
0.10	0.31	0.44	0.56	0.75	0.31	0.44	0.94
0.20	0.42	0.58	0.75	1.00	0.42	0.58	1.3
0.30	0.63	0.88	1.1	1.5	0.63	0.88	1.9
<b>FORWARD</b>							
0.10	0.18	0.25	0.32	0.43	0.18	0.25	0.54
0.20	0.21	0.29	0.38	0.50	0.21	0.29	0.63
0.30	0.25	0.35	0.45	0.60	0.25	0.35	0.75
<b>BACKWARD</b>							
0.10	0.31	0.44	0.56	0.75	0.31	0.44	0.94
0.20	0.42	0.58	0.75	1.00	0.42	0.58	1.3
0.30	0.63	0.88	1.1	1.5	0.63	0.88	1.9

\*\* Between tag washer and platform bed/cargo.

<b>4 in (100 mm) – NAIL</b>						
Approximate cargo mass in tonnes prevented from sliding by one nail						
$\mu^{***}$	<b>SIDEWAYS per side</b>		<b>FORWARD</b>		<b>BACKWARD</b>	
	blank	galvanised	blank	galvanised	blank	Galvanised
BS (ton)	0.22	0.32	0.22	0.32	0.22	0.32
0.00	0.22	0.32	0.14	0.20	0.22	0.32
0.05	0.24	0.36	0.15	0.21	0.24	0.36
0.10	0.28	0.40	0.16	0.23	0.28	0.40
0.15	0.31	0.46	0.17	0.25	0.31	0.46
0.20	0.37	0.53	0.18	0.27	0.37	0.53
0.25	0.44	0.64	0.20	0.29	0.44	0.64
0.30	0.55	0.80	0.22	0.32	0.55	0.80
0.35	0.73	1.1	0.24	0.36	0.73	1.1
0.40	1.1	1.6	0.28	0.40	1.1	1.6
0.45	2.2	3.2	0.31	0.46	1.5	2.1
0.50	no slide	no slide	0.37	0.53	2.2	3.2
0.55	no slide	no slide	0.44	0.64	4.4	6.4
0.60	no slide	no slide	0.55	0.80	no slide	no slide
0.65	no slide	no slide	0.73	1.1	no slide	no slide
0.70	no slide	no slide	1.1	1.6	no slide	no slide

\*\*\* Between cargo and platform bed.

## 11. QUICK LASHING GUIDE B

### Cargo securing on CTUs for transports on Road, Combined Rail and in Sea Area B

#### 11.1 General Remarks

11.1.1 Accelerations to be expected expressed in parts of the gravity acceleration ( $1g = 9.81 \text{ m/s}^2$ ).

Transport mode/ Sea area	Sideways		Forward		Backward	
	S	V	F	V	B	V
Road	0.5	1.0	0.8	1.0	0.5	1.0
Combined Rail	0.5	1.0	0.5	1.0	0.5	1.0
Sea Area B	0.7	1.0	0.3	0.3	0.3	0.3

*V = Vertical acceleration to be used in combination with horizontal accelerations; S Sideways, F Forward and B Backward.*

#### 11.1.2 Goods not rigid in form

If the goods are not rigid in form, more lashings than stipulated in this quick lashing guide could be required.

#### 11.1.3 Sideways, forward and backward refers to a fore-and-aft stowed CTU.

**11.2 WEBBING**

**11.2.1 Top-over lashings**



The tables are valid for **webbing** with an MSL of 20 kN or 2,000 daN – (2,000 kg = 2 tonnes) and a pre-tension of minimum 4 kN or 400 daN – (400 kg).

The values in the tables are proportional to the pre-tension in the lashings.

The masses in the tables are valid for one top-over lashing.

**TOP-OVER LASHING**

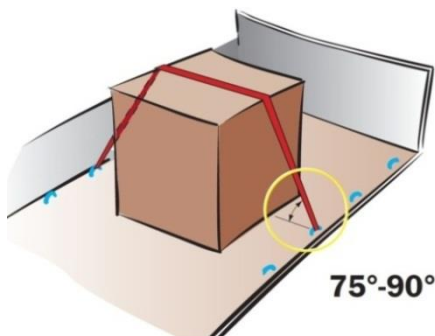

Cargo mass in tonnes prevented from sliding <i>per top-over lashing</i>			
$\mu$	SIDEWAYS	FORWARD	BACKWARD
0.00	0.00	0.00	0.00
0.05	0.05	0.05	0.08
0.10	0.12	0.10	0.18
0.15	0.19	0.16	0.30
0.20	0.28	0.24	0.47
0.25	0.39	0.32	0.71
0.30	0.53	0.43	1.0
0.35	0.71	0.55	1.3
0.40	0.95	0.71	1.6
0.45	1.3	0.91	1.9
0.50	1.8	1.2	2.4
0.55	2.6	1.6	2.9
0.60	4.3	2.1	3.5
0.65	9.2	3.1	4.4
0.70	no slide	5.0	5.5

Cargo mass in tonnes prevented from tipping <i>per top-over lashing</i>								
SIDEWAYS						FORWARD		BACKWARD
H/B	1 row	2 rows	3 rows	4 rows	5 rows	H/L	per section	per section
0.6	no tip	no tip	4.1	1.9	1.3	0.6	no tip	no tip
0.8	no tip	7.4	1.6	1.0	0.80	0.8	no tip	no tip
1.0	no tip	2.2	0.98	0.70	0.58	1.0	no tip	no tip
1.2	no tip	1.3	0.71	0.53	0.45	1.2	12	12
1.4	no tip	0.93	0.55	0.43	0.37	1.4	5.9	5.9
1.6	5.9	0.72	0.46	0.36	0.31	1.6	2.5	3.9
1.8	2.7	0.59	0.39	0.31	0.27	1.8	1.6	3.0
2.0	1.8	0.50	0.34	0.27	0.24	2.0	1.2	2.4
2.2	1.3	0.43	0.30	0.24	0.22	2.2	0.93	2.0
2.4	1.0	0.38	0.27	0.22	0.19	2.4	0.77	1.7
2.6	0.86	0.34	0.24	0.20	0.18	2.6	0.66	1.5
2.8	0.74	0.31	0.22	0.18	0.16	2.8	0.57	1.3
3.0	0.64	0.28	0.20	0.17	0.15	3.0	0.51	1.2

**11.2 WEBBING**

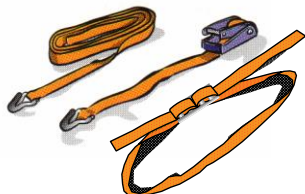

**11.2.2 Half-loop lashings**

The tables are valid for **webbing** with an MSL of 20 kN or 2,000 daN – (2,000 kg = 2 tonnes) and a pre-tension of minimum 4 kN or 400 daN – (400 kg).

The masses in the tables below are valid for one pair of half-loop lashings.

The values in the tables are proportional to the maximum securing load (MSL) in the lashings.

**HALF-LOOP LASHING**

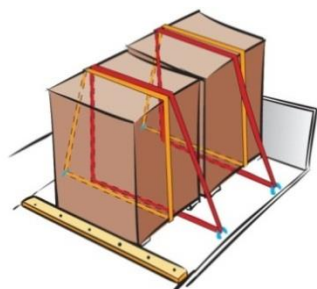

Cargo mass in tonnes prevented from sliding <i>per pair of half-loop lashing</i>	
$\mu$	SIDEWAYS
0.00	2.9
0.05	3.2
0.10	3.5
0.15	3.9
0.20	4.3
0.25	4.7
0.30	5.3
0.35	5.9
0.40	6.6
0.45	7.5
0.50	8.6
0.55	10
0.60	12
0.65	14
0.70	no slide

Cargo mass in tonnes prevented from tipping <i>per pair of half-loop lashing</i>					
SIDEWAYS					
H/B	1 row	2 rows	3 rows	4 rows	5 rows
0.6	no tip	no tip	12	5.2	3.7
0.8	no tip	21	4.5	2.9	2.3
1.0	no tip	6.4	2.8	2.0	1.6
1.2	no tip	3.7	2.0	1.5	1.3
1.4	no tip	2.7	1.6	1.2	1.0
1.6	17	2.1	1.3	1.0	0.89
1.8	7.8	1.7	1.1	0.88	0.77
2.0	5.1	1.4	0.96	0.78	0.68
2.2	3.8	1.2	0.84	0.69	0.61
2.4	3.0	1.1	0.76	0.62	0.55
2.6	2.5	0.97	0.69	0.57	0.50
2.8	2.1	0.87	0.63	0.52	0.46
3.0	1.9	0.80	0.58	0.48	0.43



**11.2 WEBBING**



**11.2.3 Straight lashings**

The tables are valid for **webbing** with an MSL of 20 kN or 2,000 daN – (2,000 kg = 2 tonnes) and a pre-tension of minimum 4 kN or 400 daN – (400 kg).

All masses are valid for one straight lashing.

The values in the tables are proportional to the maximum securing load (MSL) in the lashings.

**STRAIGHT LASHING**

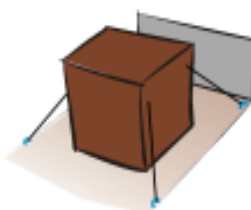

Cargo mass in tonnes prevented from sliding <i>per straight lashing</i>			
$\mu$	SIDEWAYS per side	FORWARD	BACKWARD
0.00	0.73	0.64	1.0
0.05	0.87	0.76	1.2
0.10	1.0	0.89	1.5
0.15	1.2	1.0	1.8
0.20	1.4	1.2	2.2
0.25	1.6	1.4	2.7
0.30	1.9	1.6	3.3
0.35	2.2	1.8	4.1
0.40	2.6	2.1	4.9
0.45	3.0	2.4	5.6
0.50	3.6	2.8	6.2
0.55	4.3	3.2	7.0
0.60	5.2	3.7	7.9
0.65	6.4	4.4	8.9
0.70	no slide	5.2	10.0

Cargo mass in tonnes prevented from tipping <i>per straight lashing</i>				
H/B	SIDEWAYS per side	H/L	FORWARD	BACKWARD
0.6	no tip	0.6	no tip	no tip
0.8	no tip	0.8	no tip	no tip
1.0	no tip	1.0	no tip	no tip
1.2	no tip	1.2	19	19
1.4	no tip	1.4	10	10
1.6	11	1.6	4.7	7.4
1.8	5.5	1.8	3.2	5.9
2.0	3.8	2.0	2.5	5.1
2.2	3.0	2.2	2.1	4.5
2.4	2.5	2.4	1.9	4.1
2.6	2.2	2.6	1.7	3.8
2.8	2.0	2.8	1.6	3.6
3.0	1.9	3.0	1.5	3.4

## 11.2 WEBBING



### 11.2.4 Spring lashings

The tables are valid for **webbing** with an MSL of 20 kN or 2,000 daN – (2,000 kg = 2 tonnes) and a pre-tension of minimum 4 kN or 400 daN – (400 kg).

The masses in the tables are valid for one spring lashing.

The values in the tables are proportional to the maximum securing load (MSL) in the lashings.

#### SPRING LASHING



Cargo mass in tonnes prevented from sliding <i>per spring lashing</i>		
$\mu$	FORWARD	BACKWARD
0.00	3.6	5.8
0.05	3.9	6.5
0.10	4.3	7.3
0.15	4.7	8.3
0.20	5.1	9.5
0.25	5.6	11
0.30	6.1	13
0.35	6.8	15
0.40	7.5	18
0.45	8.3	19
0.50	9.3	21
0.55	11	23
0.60	12	25
0.65	14	28
0.70	16	31

Cargo mass in tonnes prevented from tipping <i>per spring lashing</i>		
H/L	FORWARD	BACKWARD
0.6	no tip	no tip
0.8	no tip	no tip
1.0	no tip	no tip
1.2	115	115
1.4	67	67
1.6	33	51
1.8	24	43
2.0	19	38
2.2	17	35
2.4	15	33
2.6	14	31
2.8	13	30
3.0	12	29

**11.3 CHAIN**

**11.3.1 Top-over lashings**



The tables are valid for **chain (Ø 9 mm, class 8)** with an MSL of 50 kN or 5,000 daN – (5,000 kg = 5 tonnes) and a pre-tension of minimum 10 kN or 1,000 daN – (1,000 kg = 1 tonne).

The values in the tables are proportional to the pre-tension in the lashings.

The masses in the tables are valid for one top-over lashing.

**TOP-OVER LASHING**

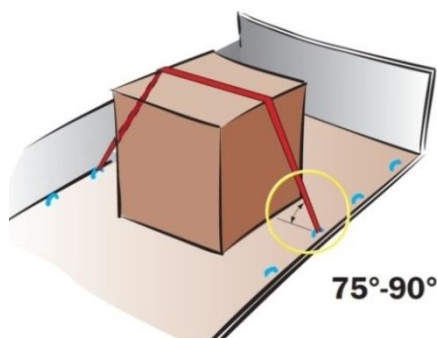

Cargo mass in tonnes prevented from sliding per top-over lashing			
$\mu$	SIDEWAYS	FORWARD	BACKWARD
0.00	0.00	0.00	0.00
0.05	0.14	0.12	0.20
0.10	0.30	0.25	0.44
0.15	0.48	0.41	0.76
0.20	0.71	0.59	1.2
0.25	0.98	0.81	1.8
0.30	1.3	1.1	2.5
0.35	1.8	1.4	3.2
0.40	2.4	1.8	3.9
0.45	3.2	2.3	4.8
0.50	4.4	3.0	5.9
0.55	6.5	3.9	7.2
0.60	11	5.3	8.9
0.65	23	7.7	11
0.70	no slide	12	14

Cargo mass in tonnes prevented from tipping per top-over lashing								
SIDEWAYS						FORWARD		BACKWARD
H/B	1 row	2 rows	3 rows	4 rows	5 rows	H/L	per section	per section
0.6	no tip	no tip	10	4.6	3.3	0.6	no tip	no tip
0.8	no tip	19	4.0	2.5	2.0	0.8	no tip	no tip
1.0	no tip	5.6	2.4	1.7	1.4	1.0	no tip	no tip
1.2	no tip	3.3	1.8	1.3	1.1	1.2	30	30
1.4	no tip	2.3	1.4	1.1	0.92	1.4	15	15
1.6	15	1.8	1.1	0.90	0.78	1.6	6.3	9.8
1.8	6.8	1.5	0.97	0.78	0.68	1.8	4.0	7.4
2.0	4.4	1.2	0.84	0.68	0.60	2.0	3.0	5.9
2.2	3.3	1.1	0.74	0.61	0.54	2.2	2.3	4.9
2.4	2.6	0.95	0.67	0.55	0.49	2.4	1.9	4.2
2.6	2.2	0.85	0.60	0.50	0.45	2.6	1.6	3.7
2.8	1.8	0.76	0.55	0.46	0.41	2.8	1.4	3.3
3.0	1.6	0.70	0.51	0.43	0.38	3.0	1.3	3.0

**11.3 CHAIN**

**11.3.2 Half-loop lashings**



The tables are valid for **chain (Ø 9 mm, class 8)** with an MSL of 50 kN or 5,000 daN – (5,000 kg = 5 tonnes) and a pre-tension of minimum 10 kn or 1,000 daN – (1,000 kg = 1 tonne).

The masses in the tables below are valid for one pair of half-loop lashings.

The values in the tables are proportional to the maximum securing load (MSL) in the lashings.

**HALF-LOOP LASHING**

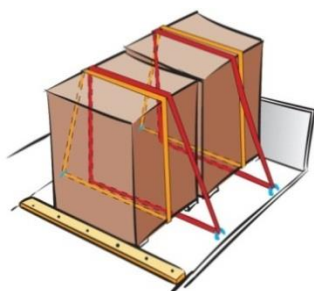

Cargo mass in tonnes prevented from sliding <i>per pair of half-loop lashing</i>	
$\mu$	SIDEWAYS
0.00	7.3
0.05	8.0
0.10	8.8
0.15	9.7
0.20	11
0.25	12
0.30	13
0.35	15
0.40	17
0.45	19
0.50	22
0.55	25
0.60	30
0.65	36
0.70	no slide

Cargo mass in tonnes prevented from tipping <i>per pair of half-loop lashing</i>					
SIDEWAYS					
H/B	1 row	2 rows	3 rows	4 rows	5 rows
0.6	no tip	no tip	29	13	9.3
0.8	no tip	53	11	7.2	5.7
1.0	no tip	16	7.0	5.0	4.1
1.2	no tip	9.4	5.0	3.8	3.2
1.4	no tip	6.6	3.9	3.1	2.6
1.6	42	5.1	3.2	2.6	2.2
1.8	20	4.2	2.8	2.2	1.9
2.0	13	3.5	2.4	1.9	1.7
2.2	9.4	3.1	2.1	1.7	1.5
2.4	7.5	2.7	1.9	1.6	1.4
2.6	6.2	2.4	1.7	1.4	1.3
2.8	5.3	2.2	1.6	1.3	1.2
3.0	4.6	2.0	1.4	1.2	1.1

**11.3 CHAIN**



**11.3.3 Straight lashings**

The tables are valid for **chain (Ø 9 mm, class 8)** with an MSL of 50 kN or 5,000 daN – (5,000 kg = 5 tonnes) and a pre-tension of minimum 10 kN or 1,000 daN – (1,000 kg = 1 tonne).

All masses are valid for one straight lashing.

The values in the tables are proportional to the maximum securing load (MSL) in the lashings.

**STRAIGHT LASHING**

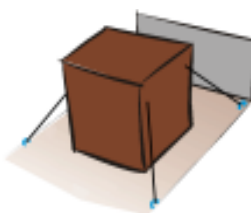

Cargo mass in tonnes prevented from sliding <i>per straight lashing</i>			
$\mu$	SIDEWAYS per side	FORWARD	BACKWARD
0.00	1.8	1.6	2.5
0.05	2.2	1.9	3.1
0.10	2.6	2.2	3.8
0.15	3.0	2.6	4.6
0.20	3.5	3.0	5.5
0.25	4.1	3.4	6.7
0.30	4.8	3.9	8.2
0.35	5.6	4.5	10
0.40	6.5	5.2	12
0.45	7.6	6.0	14
0.50	9.0	6.9	16
0.55	11	8.0	18
0.60	13	9.3	20
0.65	16	11	22
0.70	no slide	13	25

Cargo mass in tonnes prevented from tipping <i>per straight lashing</i>				
H/B	SIDEWAYS per side	H/L	FORWARD	BACKWARD
0.6	no tip	0.6	no tip	no tip
0.8	no tip	0.8	no tip	no tip
1.0	no tip	1.0	no tip	no tip
1.2	no tip	1.2	47	47
1.4	no tip	1.4	25	25
1.6	28	1.6	12	18
1.8	14	1.8	8.1	15
2.0	9.6	2.0	6.4	13
2.2	7.6	2.2	5.4	11
2.4	6.4	2.4	4.7	10
2.6	5.6	2.6	4.2	9.6
2.8	5.0	2.8	3.9	9.0
3.0	4.6	3.0	3.6	8.5

**11.3 CHAIN**



**11.3.4 Spring lashings**

The tables are valid for **chain (Ø 9 mm, class 8)** with an MSL of 50kN or 5,000 daN – (5,000 kg = 5 tonnes) and a pre-tension of minimum 10 kN or 1,000 daN – (1,000 kg = 1 tonne).

The masses in the tables are valid for one spring lashing.

The values in the tables are proportional to the maximum securing load (MSL) in the lashings.

**SPRING LASHING**



Cargo mass in tonnes prevented from sliding <i>per spring lashing</i>		
$\mu$	FORWARD	BACKWARD
0.00	9.0	14
0.05	9.8	16
0.10	11	18
0.15	12	21
0.20	13	24
0.25	14	27
0.30	15	32
0.35	17	38
0.40	19	45
0.45	21	49
0.50	23	53
0.55	26	58
0.60	30	63
0.65	34	70
0.70	40	77

Cargo mass in tonnes prevented from tipping <i>per spring lashing</i>		
H/L	FORWARD	BACKWARD
0.6	no tip	no tip
0.8	no tip	no tip
1.0	no tip	no tip
1.2	288	288
1.4	168	168
1.6	82	128
1.8	59	108
2.0	48	96
2.2	42	88
2.4	38	82
2.6	35	78
2.8	33	75
3.0	31	72



**11.4 STEEL STRAPPING**

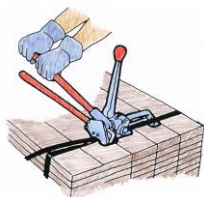

**11.4.1 Top-over lashings**

The tables are valid for **steel strapping (32 × 0.8 mm)** with an MSL of 17 kN or 1,700 daN – (1,700 kg = 1.7 tonnes) and a pre-tension of minimum 2.4 kN or 240 daN – (240 kg).

The values in the tables are proportional to the pre-tension in the lashings.

The masses in the tables are valid for one top-over lashing.

**TOP-OVER LASHING**

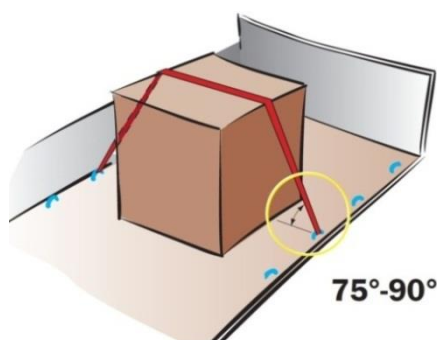

Cargo mass in tonnes prevented from sliding <i>per top-over lashing</i>			
$\mu$	SIDEWAYS	FORWARD	BACKWARD
0.00	0.00	0.00	0.00
0.05	0.03	0.03	0.05
0.10	0.07	0.06	0.11
0.15	0.12	0.10	0.18
0.20	0.17	0.14	0.28
0.25	0.24	0.19	0.43
0.30	0.32	0.26	0.61
0.35	0.43	0.33	0.76
0.40	0.57	0.43	0.95
0.45	0.77	0.55	1.2
0.50	1.1	0.71	1.4
0.55	1.6	0.94	1.7
0.60	2.6	1.3	2.1
0.65	5.5	1.8	2.6
0.70	no slide	3.0	3.3

Cargo mass in tonnes prevented from tipping <i>per top-over lashing</i>								
SIDEWAYS						FORWARD		BACKWARD
H/B	1 row	2 rows	3 rows	4 rows	5 rows	H/L	per section	per section
0.6	no tip	no tip	2.5	1.1	0.79	0.6	no tip	no tip
0.8	no tip	4.5	0.95	0.61	0.48	0.8	no tip	no tip
1.0	no tip	1.3	0.59	0.42	0.35	1.0	no tip	no tip
1.2	no tip	0.79	0.42	0.32	0.27	1.2	7.1	7.1
1.4	no tip	0.56	0.33	0.26	0.22	1.4	3.5	3.5
1.6	3.5	0.43	0.27	0.22	0.19	1.6	1.5	2.4
1.8	1.6	0.35	0.23	0.19	0.16	1.8	0.97	1.8
2.0	1.1	0.30	0.20	0.16	0.14	2.0	0.71	1.4
2.2	0.79	0.26	0.18	0.15	0.13	2.2	0.56	1.2
2.4	0.63	0.23	0.16	0.13	0.12	2.4	0.46	1.0
2.6	0.52	0.20	0.14	0.12	0.11	2.6	0.39	0.89
2.8	0.44	0.18	0.13	0.11	0.10	2.8	0.34	0.79
3.0	0.39	0.17	0.12	0.10	0.09	3.0	0.30	0.71

**11.4 STEEL STRAPPING**

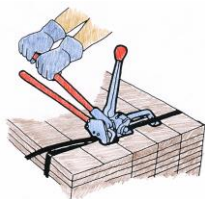

**11.4.2 Half-loop lashings**

The tables are valid for **steel strapping (32 × 0.8 mm)** with an MSL of 17 kN or 1,700 daN – (1,700 kg = 1.7 tonnes) and a pre-tension of minimum 2.4 kN or 240 daN – (240 kg).

The masses in the tables below are valid for one pair of half-loop lashings.

The values in the tables are proportional to the maximum securing load (BS) in the lashings.

**HALF-LOOP LASHING**

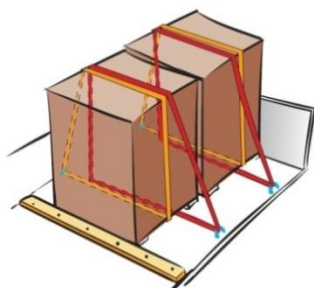

Cargo mass in tonnes prevented from sliding <i>per pair of half-loop lashing</i>	
$\mu$	SIDEWAYS
0.00	2.5
0.05	2.7
0.10	3.0
0.15	3.3
0.20	3.6
0.25	4.0
0.30	4.5
0.35	5.0
0.40	5.6
0.45	6.4
0.50	7.3
0.55	8.5
0.60	10
0.65	12
0.70	no slide

Cargo mass in tonnes prevented from tipping <i>per pair of half-loop lashing</i>					
SIDEWAYS					
H/B	1 row	2 rows	3 rows	4 rows	5 rows
0.6	no tip	no tip	10.0	4.5	3.2
0.8	no tip	18	3.8	2.4	1.9
1.0	no tip	5.4	2.4	1.7	1.4
1.2	no tip	3.2	1.7	1.3	1.1
1.4	no tip	2.3	1.3	1.0	0.89
1.6	14	1.7	1.1	0.87	0.75
1.8	6.7	1.4	0.94	0.75	0.65
2.0	4.3	1.2	0.81	0.66	0.58
2.2	3.2	1.0	0.72	0.59	0.52
2.4	2.5	0.92	0.64	0.53	0.47
2.6	2.1	0.82	0.58	0.48	0.43
2.8	1.8	0.74	0.53	0.44	0.39
3.0	1.6	0.68	0.49	0.41	0.36

**11.4 STEEL STRAPPING**

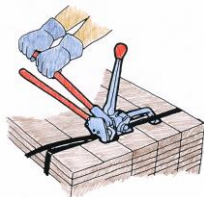

**11.4.3 Straight lashings**

The tables are valid for **steel strapping (32 × 0.8 mm)** with an MSL of 17 kN or 1,700 daN – (1,700 kg = 1.7 tonnes) and a pre-tension of minimum 2.4 kN or 240 daN – (240 kg).

All masses are valid for one straight lashing.

The values in the tables are proportional to the maximum securing load (MSL) in the lashings.

**STRAIGHT LASHING**

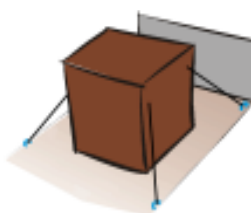

Cargo mass in tonnes prevented from sliding <i>per straight lashing</i>			
$\mu$	SIDEWAYS per side	FORWARD	BACKWARD
0.00	0.62	0.54	0.87
0.05	0.74	0.64	1.1
0.10	0.87	0.75	1.3
0.15	1.0	0.88	1.6
0.20	1.2	1.0	1.9
0.25	1.4	1.2	2.3
0.30	1.6	1.3	2.8
0.35	1.9	1.5	3.5
0.40	2.2	1.8	4.2
0.45	2.6	2.0	4.7
0.50	3.1	2.3	5.3
0.55	3.7	2.7	6.0
0.60	4.4	3.2	6.7
0.65	5.5	3.7	7.6
0.70	no slide	4.4	8.5

Cargo mass in tonnes prevented from tipping <i>per straight lashing</i>				
H/B	SIDEWAYS per side	H/L	FORWARD	BACKWARD
0.6	no tip	0.6	no tip	no tip
0.8	no tip	0.8	no tip	no tip
1.0	no tip	1.0	no tip	no tip
1.2	no tip	1.2	16	16
1.4	no tip	1.4	8.7	8.7
1.6	9.4	1.6	4.0	6.3
1.8	4.7	1.8	2.8	5.1
2.0	3.2	2.0	2.2	4.3
2.2	2.6	2.2	1.8	3.9
2.4	2.2	2.4	1.6	3.5
2.6	1.9	2.6	1.4	3.2
2.8	1.7	2.8	1.3	3.0
3.0	1.6	3.0	1.2	2.9

## 11.4 STEEL STRAPPING

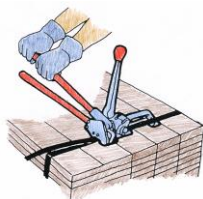

### 11.4.4 Spring lashings

The tables are valid for **steel strapping (32 × 0.8 mm)** with an MSL of 17 kN or 1,700 daN – (1,700 kg = 1.7 tonnes) and a pre-tension of minimum 2.4 kN or 240 daN – (240 kg).

The masses in the tables are valid for one spring lashing.

The values in the tables are proportional to the maximum securing load (MSL) in the lashings.

### SPRING LASHING



Cargo mass in tonnes prevented from sliding <i>per spring lashing</i>		
$\mu$	FORWARD	BACKWARD
0.00	3.1	4.9
0.05	3.3	5.5
0.10	3.6	6.2
0.15	4.0	7.0
0.20	4.3	8.1
0.25	4.8	9.3
0.30	5.2	11
0.35	5.8	13
0.40	6.4	15
0.45	7.1	16
0.50	7.9	18
0.55	8.9	20
0.60	10	22
0.65	12	24
0.70	14	26

Cargo mass in tonnes prevented from tipping <i>per spring lashing</i>		
H/L	FORWARD	BACKWARD
0.6	no tip	no tip
0.8	no tip	no tip
1.0	no tip	no tip
1.2	98	98
1.4	57	57
1.6	28	44
1.8	20	37
2.0	16	33
2.2	14	30
2.4	13	28
2.6	12	27
2.8	11	25
3.0	11	25

**11.5 WIRE**

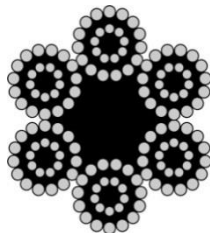

**11.5.1 Top-over lashings**

The tables are valid for **steel wire rope (Ø 16 mm/144 wires)** with an MSL of 91 kN or 9,100 daN – (9,100 kg = 9.1 tonnes) and a pre-tension of minimum 10 kN or 1,000 daN – (1,000 kg = 1 tonne).

The values in the tables are proportional to the pre-tension in the lashings.

The masses in the tables are valid for one top-over lashing.

**TOP-OVER LASHING**

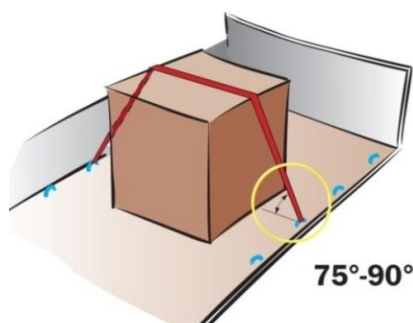

Cargo mass in tonnes prevented from sliding <i>per top-over lashing</i>			
$\mu$	SIDEWAYS	FORWARD	BACKWARD
<b>0.00</b>	0.00	0.00	0.00
<b>0.05</b>	0.14	0.12	0.20
<b>0.10</b>	0.30	0.25	0.44
<b>0.15</b>	0.48	0.41	0.76
<b>0.20</b>	0.71	0.59	1.2
<b>0.25</b>	0.98	0.81	1.8
<b>0.30</b>	1.3	1.1	2.5
<b>0.35</b>	1.8	1.4	3.2
<b>0.40</b>	2.4	1.8	3.9
<b>0.45</b>	3.2	2.3	4.8
<b>0.50</b>	4.4	3.0	5.9
<b>0.55</b>	6.5	3.9	7.2
<b>0.60</b>	11	5.3	8.9
<b>0.65</b>	23	7.7	11
<b>0.70</b>	no slide	12	14

Cargo mass in tonnes prevented from tipping <i>per top-over lashing</i>								
SIDEWAYS						FORWARD		BACKWARD
H/B	1 row	2 rows	3 rows	4 rows	5 rows	H/L	per section	per section
<b>0.6</b>	no tip	no tip	10	4.6	3.3	<b>0.6</b>	no tip	no tip
<b>0.8</b>	no tip	19	4.0	2.5	2.0	<b>0.8</b>	no tip	no tip
<b>1.0</b>	no tip	5.6	2.4	1.7	1.4	<b>1.0</b>	no tip	no tip
<b>1.2</b>	no tip	3.3	1.8	1.3	1.1	<b>1.2</b>	30	30
<b>1.4</b>	no tip	2.3	1.4	1.1	0.92	<b>1.4</b>	15	15
<b>1.6</b>	15	1.8	1.1	0.90	0.78	<b>1.6</b>	6.3	9.8
<b>1.8</b>	6.8	1.5	0.97	0.78	0.68	<b>1.8</b>	4.0	7.4
<b>2.0</b>	4.4	1.2	0.84	0.68	0.60	<b>2.0</b>	3.0	5.9
<b>2.2</b>	3.3	1.1	0.74	0.61	0.54	<b>2.2</b>	2.3	4.9
<b>2.4</b>	2.6	0.95	0.67	0.55	0.49	<b>2.4</b>	1.9	4.2
<b>2.6</b>	2.2	0.85	0.60	0.50	0.45	<b>2.6</b>	1.6	3.7
<b>2.8</b>	1.8	0.76	0.55	0.46	0.41	<b>2.8</b>	1.4	3.3
<b>3.0</b>	1.6	0.70	0.51	0.43	0.38	<b>3.0</b>	1.3	3.0

NOTE: WIRES OF THIS SIZE ARE NOT SUITABLE FOR SECURING CARGO WITHIN CONTAINERS AS STRENGTH OF ANCHOR AND LASHING POINTS ARE LIKELY TO BE EXCEEDED.

**11.5 WIRE**

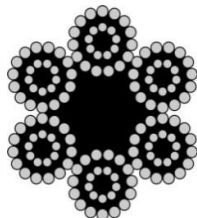

**11.5.2 Half-loop lashings**

The tables are valid for **steel wire rope (Ø 16 mm/144 wires)** with an MSL of 91 kN or 9,100 daN – (9,100 kg = 9.1 tonnes) and a pre-tension of minimum 10 kN or 1,000 daN – (1,000 kg = 1 tonne).

The masses in the tables below are valid for one pair of half-loop lashings.

The values in the tables are proportional to the maximum securing load (MSL) in the lashings.

**HALF-LOOP LASHING**

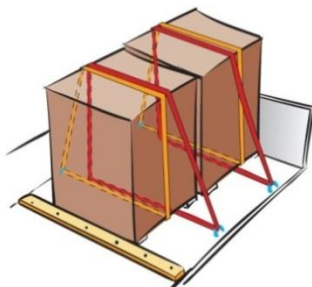

Cargo mass in tonnes prevented from sliding per pair of half-loop lashing	
$\mu$	SIDEWAYS
0.00	13
0.05	15
0.10	16
0.15	18
0.20	19
0.25	21
0.30	24
0.35	27
0.40	30
0.45	34
0.50	39
0.55	46
0.60	54
0.65	65
0.70	no slide

Cargo mass in tonnes prevented from tipping per pair of half-loop lashing					
SIDEWAYS					
H/B	1 row	2 rows	3 rows	4 rows	5 rows
0.6	no tip	no tip	54	24	17
0.8	no tip	97	20	13	10
1.0	no tip	29	13	9.0	7.4
1.2	no tip	17	9.2	6.9	5.8
1.4	no tip	12	7.2	5.6	4.8
1.6	77	9.4	5.9	4.7	4.0
1.8	36	7.6	5.0	4.0	3.5
2.0	23	6.4	4.3	3.5	3.1
2.2	17	5.6	3.8	3.1	2.8
2.4	14	4.9	3.4	2.8	2.5
2.6	11	4.4	3.1	2.6	2.3
2.8	9.7	4.0	2.9	2.4	2.1
3.0	8.4	3.6	2.6	2.2	2.0



**11.5 WIRE**

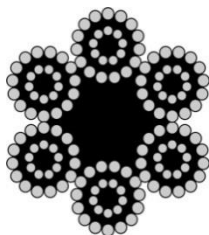

**11.5.3 Straight lashings**

The tables are valid for **steel wire rope (Ø 16 mm/144 wires)** with an MSL of 91 kN or 9,100 daN – (9,100 kg = 9.1 tonnes) and a pre-tension of minimum 10 kN or 1,000 daN – (1,000 kg = 1 tonne).

All masses are valid for one straight lashing.

The values in the tables are proportional to the maximum securing load (MSL) in the lashings.

**STRAIGHT LASHING**

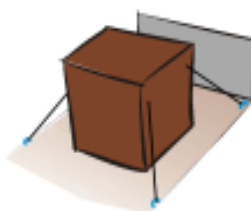

Cargo mass in tonnes prevented from sliding <i>per straight lashing</i>			
$\mu$	SIDEWAYS per side	FORWARD	BACKWARD
0.00	3.3	2.9	4.6
0.05	4.0	3.4	5.7
0.10	4.7	4.0	6.9
0.15	5.5	4.7	8.3
0.20	6.4	5.4	10
0.25	7.5	6.2	12
0.30	8.7	7.2	15
0.35	10	8.2	19
0.40	12	9.5	23
0.45	14	11	25
0.50	16	13	28
0.55	20	15	32
0.60	24	17	36
0.65	29	20	41
0.70	no slide	23	45

Cargo mass in tonnes prevented from tipping <i>per straight lashing</i>				
H/B	SIDEWAYS per side	H/L	FORWARD	BACKWARD
0.6	no tip	0.6	no tip	no tip
0.8	no tip	0.8	no tip	no tip
1.0	no tip	1.0	no tip	no tip
1.2	no tip	1.2	85	85
1.4	no tip	1.4	46	46
1.6	50	1.6	22	33
1.8	25	1.8	15	27
2.0	17	2.0	12	23
2.2	14	2.2	9.8	21
2.4	12	2.4	8.6	19
2.6	10	2.6	7.7	17
2.8	9.2	2.8	7.1	16
3.0	8.4	3.0	6.6	15

## 11.5 WIRE

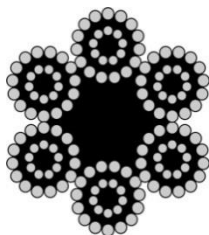

### 11.5.4 Spring lashings

The tables are valid for **steel wire rope (Ø 16 mm/144 wires)** with an MSL of 91 kN or 9,100 daN – (9,100 kg = 9.1 tonnes) and a pre-tension of minimum 10 kN or 1,000 daN – (1,000 kg = 1 tonne).

The masses in the tables are valid for one spring lashing.

The values in the tables are proportional to the maximum securing load (MSL) in the lashings.

#### SPRING LASHING



Cargo mass in tonnes prevented from sliding <i>per spring lashing</i>		
$\mu$	FORWARD	BACKWARD
0.00	16	26
0.05	18	29
0.10	19	33
0.15	21	38
0.20	23	43
0.25	25	50
0.30	28	58
0.35	31	70
0.40	34	81
0.45	38	88
0.50	42	96
0.55	48	105
0.60	54	115
0.65	62	127
0.70	73	140

Cargo mass in tonnes prevented from tipping <i>per spring lashing</i>		
H/L	FORWARD	BACKWARD
0.6	no tip	no tip
0.8	no tip	no tip
1.0	no tip	no tip
1.2	525	525
1.4	306	306
1.6	150	233
1.8	107	197
2.0	87	175
2.2	76	160
2.4	68	150
2.6	63	142
2.8	59	136
3.0	56	131

**11.6 TAG WASHERS AND NAILS**

<b>TAG WASHER</b>							
							
<b>Approximate cargo mass in tonnes prevented from sliding by one tag washer for wood on wood in combination with top-over lashing only</b>							
$\mu^{**}$	<b>SIDEWAYS</b>						
	$\varnothing$ 48	$\varnothing$ 62	$\varnothing$ 75	$\varnothing$ 95	30x57	48x65	130x130
BS (ton)	0.5	0.7	0.9	1.2	0.5	0.7	1.5
<b>0.10</b>	0.21	0.29	0.38	0.50	0.21	0.29	0.63
<b>0.20</b>	0.25	0.35	0.45	0.60	0.25	0.35	0.75
<b>0.30</b>	0.31	0.44	0.56	0.75	0.31	0.44	0.94
<b>FORWARD</b>							
<b>0.10</b>	0.18	0.25	0.32	0.43	0.18	0.25	0.54
<b>0.20</b>	0.21	0.29	0.38	0.50	0.21	0.29	0.63
<b>0.30</b>	0.25	0.35	0.45	0.60	0.25	0.35	0.75
<b>BACKWARD</b>							
<b>0.10</b>	0.31	0.44	0.56	0.75	0.31	0.44	0.94
<b>0.20</b>	0.42	0.58	0.75	1.00	0.42	0.58	1.3
<b>0.30</b>	0.60	0.83	1.1	1.4	0.60	0.83	1.8

<sup>\*\*</sup> Between tag washer and platform bed/cargo.

<b>4 in (100 mm) – NAIL</b>						
<b>Approximate cargo mass in tonnes prevented from sliding by one nail</b>						
$\mu^{***}$	<b>SIDEWAYS per side</b>		<b>FORWARD</b>		<b>BACKWARD</b>	
	blank	galvanised	blank	galvanised	blank	galvanised
BS (ton)	0.22	0.32	0.22	0.32	0.22	0.32
<b>0.00</b>	0.16	0.23	0.14	0.20	0.22	0.32
<b>0.05</b>	0.17	0.25	0.15	0.21	0.24	0.36
<b>0.10</b>	0.18	0.27	0.16	0.23	0.28	0.40
<b>0.15</b>	0.20	0.29	0.17	0.25	0.31	0.46
<b>0.20</b>	0.22	0.32	0.18	0.27	0.37	0.53
<b>0.25</b>	0.24	0.36	0.20	0.29	0.44	0.64
<b>0.30</b>	0.28	0.40	0.22	0.32	0.52	0.76
<b>0.35</b>	0.31	0.46	0.24	0.36	0.56	0.82
<b>0.40</b>	0.37	0.53	0.28	0.40	0.61	0.89
<b>0.45</b>	0.44	0.64	0.31	0.46	0.67	0.97
<b>0.50</b>	0.55	0.80	0.37	0.53	0.73	1.1
<b>0.55</b>	0.73	1.1	0.44	0.64	0.81	1.2
<b>0.60</b>	1.1	1.6	0.55	0.80	0.92	1.3
<b>0.65</b>	2.2	3.2	0.73	1.1	1.0	1.5
<b>0.70</b>	no slide	no slide	1.1	1.6	1.2	1.8

<sup>\*\*\*</sup> Between cargo and platform bed.

## 12. QUICK LASHING GUIDE C

### Cargo securing on CTUs for transports on Road, Combined Rail and in Sea Area C

#### 12.1 General Remarks

12.1.1 Accelerations to be expected expressed in parts of the gravity acceleration ( $1g = 9.81 \text{ m/s}^2$ ).

Transport mode/ Sea area	Sideways		Forward		Backward	
	S	V	F	V	B	V
Road	0.5	1.0	0.8	1.0	0.5	1.0
Combined Rail	0.5	1.0	0.5	1.0	0.5	1.0
Sea Area C	0.8	1.0	0.4	0.2	0.4	0.2

*V = Vertical acceleration to be used in combination with horizontal accelerations; S Sideways, F Forward and B Backward.*

12.1.2 Goods not rigid in form

If the goods are not rigid in form, more lashings than stipulated in this quick lashing guide could be required.

12.1.3 Sideways, forward and backward refers to a fore-and-aft stowed CTU.

## 12.2 WEBBING



### TOP-OVER LASHING

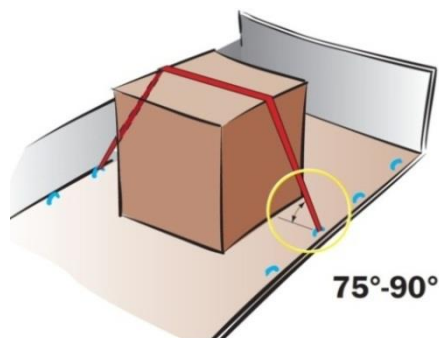

### 12.2.1 Top-over lashings

The tables are valid for **webbing** with an MSL of 20 kN or 2,000 daN – (2,000 kg = 2 tonnes) and a pre-tension of minimum 4 kN or 400 daN – (400 kg).

The values in the tables are proportional to the lashings' pre-tension.

The masses in the tables are valid for one top-over lashing.

Cargo mass in tonnes prevented from sliding <i>per top-over lashing</i>			
$\mu$	SIDEWAYS	FORWARD	BACKWARD
0.00	0.00	0.00	0.00
0.05	0.05	0.05	0.08
0.10	0.10	0.10	0.18
0.15	0.16	0.16	0.29
0.20	0.24	0.24	0.39
0.25	0.32	0.32	0.51
0.30	0.43	0.43	0.63
0.35	0.55	0.55	0.75
0.40	0.71	0.71	0.89
0.45	0.91	0.91	1.0
0.50	1.2	1.2	1.2
0.55	1.6	1.3	1.3
0.60	2.1	1.5	1.5
0.65	3.1	1.7	1.7
0.70	5.0	1.9	1.9

Cargo mass in tonnes prevented from tipping <i>per top-over lashing</i>								
H/B	SIDEWAYS					H/L	FORWARD	BACKWARD
	1 row	2 rows	3 rows	4 rows	5 rows		per section	per section
0.6	no tip	no tip	2.4	1.4	1.0	0.6	18	18
0.8	no tip	3.2	1.2	0.81	0.66	0.8	5.9	5.9
1.0	no tip	1.5	0.77	0.57	0.48	1.0	3.5	3.5
1.2	no tip	0.97	0.57	0.44	0.38	1.2	2.5	2.5
1.4	5.9	0.72	0.46	0.36	0.31	1.4	2.0	2.0
1.6	2.5	0.57	0.38	0.31	0.27	1.6	1.6	1.6
1.8	1.6	0.47	0.32	0.26	0.23	1.8	1.4	1.4
2.0	1.2	0.41	0.28	0.23	0.21	2.0	1.2	1.2
2.2	0.93	0.35	0.25	0.21	0.18	2.2	0.93	1.0
2.4	0.77	0.31	0.23	0.19	0.17	2.4	0.77	0.93
2.6	0.66	0.28	0.21	0.17	0.15	2.6	0.66	0.84
2.8	0.57	0.26	0.19	0.16	0.14	2.8	0.57	0.77
3.0	0.51	0.23	0.17	0.15	0.13	3.0	0.51	0.71

**12.2 WEBBING**

**12.2.2 Half-loop lashings**



The tables are valid for **webbing** with an MSL of 20 kN or 2,000 daN – (2,000 kg = 2 tonnes) and a pre-tension of minimum 4 kN or 400 daN – (400 kg).

The masses in the tables below are valid for one pair of half-loop lashings.

The values in the tables are proportional to the maximum securing load (MSL) in the lashings.

**HALF-LOOP LASHING**

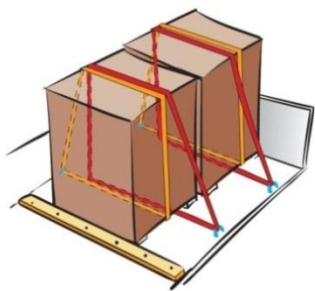

Cargo mass in tonnes prevented from sliding per pair of half-loop lashing	
$\mu$	SIDEWAYS
0.00	2.5
0.05	2.8
0.10	3.0
0.15	3.3
0.20	3.6
0.25	4.0
0.30	4.3
0.35	4.8
0.40	5.3
0.45	5.9
0.50	6.6
0.55	7.4
0.60	8.4
0.65	9.7
0.70	11

Cargo mass in tonnes prevented from tipping per pair of half-loop lashing					
SIDEWAYS					
H/B	1 row	2 rows	3 rows	4 rows	5 rows
0.6	no tip	no tip	7.0	3.9	2.9
0.8	no tip	9.1	3.3	2.3	1.9
1.0	no tip	4.2	2.2	1.6	1.4
1.2	no tip	2.8	1.6	1.3	1.1
1.4	17	2.1	1.3	1.0	0.89
1.6	7.3	1.6	1.1	0.87	0.76
1.8	4.6	1.4	0.92	0.75	0.66
2.0	3.4	1.2	0.80	0.66	0.58
2.2	2.7	1.0	0.71	0.59	0.52
2.4	2.2	0.90	0.64	0.53	0.47
2.6	1.9	0.81	0.58	0.49	0.43
2.8	1.6	0.73	0.53	0.45	0.40
3.0	1.5	0.67	0.49	0.41	0.37

**12.2 WEBBING**

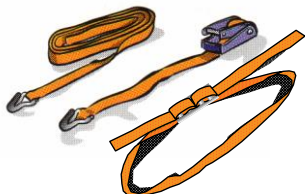

**12.2.3 Straight lashings**

The tables are valid for **webbing** with an MSL of 20 kN or 2,000 daN – (2,000 kg = 2 tonnes) and a pre-tension of minimum 4 kN or 400 daN – (400 kg).

All masses are valid for one straight lashing.

The values in the tables are proportional to the maximum securing load (MSL) in the lashings.

**STRAIGHT LASHING**

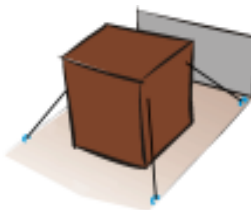

Cargo mass in tonnes prevented from sliding <i>per straight lashing</i>			
$\mu$	SIDEWAYS per side	FORWARD	BACKWARD
0.00	0.64	0.64	1.0
0.05	0.76	0.76	1.2
0.10	0.89	0.89	1.5
0.15	1.0	1.0	1.8
0.20	1.2	1.2	2.1
0.25	1.4	1.4	2.3
0.30	1.6	1.6	2.6
0.35	1.8	1.8	2.8
0.40	2.1	2.1	3.1
0.45	2.4	2.4	3.3
0.50	2.8	2.8	3.6
0.55	3.2	3.2	3.9
0.60	3.7	3.7	4.2
0.65	4.4	4.4	4.5
0.70	5.2	4.8	4.8

Cargo mass in tonnes prevented from tipping <i>per straight lashing</i>				
H/B	SIDEWAYS per side	H/L	FORWARD	BACKWARD
0.6	no tip	0.6	20	20
0.8	no tip	0.8	7.6	7.6
1.0	no tip	1.0	5.1	5.1
1.2	no tip	1.2	4.0	4.0
1.4	10	1.4	3.4	3.4
1.6	4.7	1.6	3.0	3.0
1.8	3.2	1.8	2.7	2.7
2.0	2.5	2.0	2.5	2.5
2.2	2.1	2.2	2.1	2.4
2.4	1.9	2.4	1.9	2.3
2.6	1.7	2.6	1.7	2.2
2.8	1.6	2.8	1.6	2.1
3.0	1.5	3.0	1.5	2.0



## 12.2 WEBBING



### 12.2.4 Spring lashings

The tables are valid for **webbing** with an MSL of 20 kN or 2,000 daN – (2,000 kg = 2 tonnes) and a pre-tension of minimum 4 kN or 400 daN – (400 kg).

The masses in the tables are valid for one spring lashing.

The values in the tables are proportional to the maximum securing load (MSL) in the lashings.

#### SPRING LASHING



Cargo mass in tonnes prevented from sliding <i>per spring lashing</i>		
$\mu$	FORWARD	BACKWARD
0.00	3.6	5.8
0.05	3.9	6.5
0.10	4.3	7.3
0.15	4.7	8.3
0.20	5.1	9.0
0.25	5.6	9.4
0.30	6.1	9.9
0.35	6.8	10
0.40	7.5	11
0.45	8.3	12
0.50	9.3	12
0.55	11	13
0.60	12	13
0.65	14	14
0.70	15	15

Cargo mass in tonnes prevented from tipping <i>per spring lashing</i>		
H/L	FORWARD	BACKWARD
0.6	86	86
0.8	38	38
1.0	29	29
1.2	25	25
1.4	22	22
1.6	21	21
1.8	20	20
2.0	19	19
2.2	17	19
2.4	15	18
2.6	14	18
2.8	13	18
3.0	12	17

12.3 CHAIN

12.3.1 Top-over lashings



The tables are valid for **chain (Ø 9 mm, class 8)** with an MSL of 50 kN or 5,000 daN – (5,000 kg = 5 tonnes) and a pre-tension of minimum 10 kN or 1,000 daN – (1,000 kg = 1 tonne).

The values in the tables are proportional to the pre-tension in the lashings.

The masses in the tables are valid for one top-over lashing.

TOP-OVER LASHING

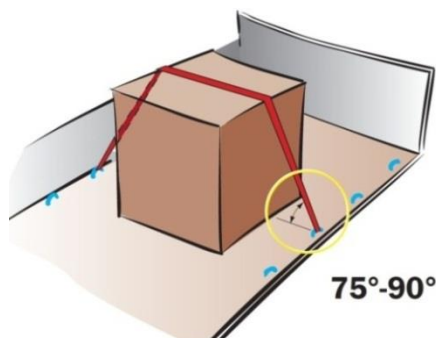

Cargo mass in tonnes prevented from sliding <i>per top-over lashing</i>			
$\mu$	SIDEWAYS	FORWARD	BACKWARD
0.00	0.00	0.00	0.00
0.05	0.12	0.12	0.20
0.10	0.25	0.25	0.44
0.15	0.41	0.41	0.72
0.20	0.59	0.59	0.98
0.25	0.81	0.81	1.3
0.30	1.1	1.1	1.6
0.35	1.4	1.4	1.9
0.40	1.8	1.8	2.2
0.45	2.3	2.3	2.6
0.50	3.0	3.0	3.0
0.55	3.9	3.4	3.4
0.60	5.3	3.8	3.8
0.65	7.7	4.3	4.3
0.70	12	4.8	4.8

Cargo mass in tonnes prevented from tipping <i>per top-over lashing</i>								
SIDEWAYS						FORWARD		BACKWARD
H/B	1 row	2 rows	3 rows	4 rows	5 rows	H/L	per section	per section
0.6	no tip	no tip	6.1	3.4	2.6	0.6	44	44
0.8	no tip	8.0	2.9	2.0	1.6	0.8	15	15
1.0	no tip	3.7	1.9	1.4	1.2	1.0	8.9	8.9
1.2	no tip	2.4	1.4	1.1	0.95	1.2	6.3	6.3
1.4	15	1.8	1.1	0.90	0.78	1.4	4.9	4.9
1.6	6.3	1.4	0.95	0.76	0.67	1.6	4.0	4.0
1.8	4.0	1.2	0.81	0.66	0.58	1.8	3.4	3.4
2.0	3.0	1.0	0.71	0.58	0.52	2.0	3.0	3.0
2.2	2.3	0.89	0.63	0.52	0.46	2.2	2.3	2.6
2.4	1.9	0.79	0.57	0.47	0.42	2.4	1.9	2.3
2.6	1.6	0.71	0.51	0.43	0.38	2.6	1.6	2.1
2.8	1.4	0.64	0.47	0.40	0.35	2.8	1.4	1.9
3.0	1.3	0.59	0.43	0.37	0.33	3.0	1.3	1.8

**12.3 CHAIN**

**12.3.2 Half-loop lashings**



The tables are valid for **chain (Ø 9 mm, class 8)** with an MSL of 50 kN or 5,000 daN – (5,000 kg = 5 tonnes) and a pre-tension of minimum 10 kN or 1,000 daN – (1,000 kg = 1 tonne).

The masses in the tables below are valid for one pair of half-loop lashings.

The values in the tables are proportional to the maximum securing load (MSL) in the lashings.

**HALF-LOOP LASHING**

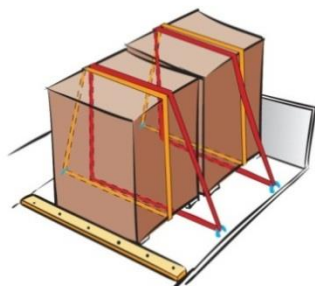

Cargo mass in tonnes prevented from sliding <i>per pair of half-loop lashing</i>	
$\mu$	SIDEWAYS
0.00	6.4
0.05	6.9
0.10	7.6
0.15	8.2
0.20	9.0
0.25	9.9
0.30	11
0.35	12
0.40	13
0.45	15
0.50	16
0.55	19
0.60	21
0.65	24
0.70	28

Cargo mass in tonnes prevented from tipping <i>per pair of half-loop lashing</i>					
SIDEWAYS					
H/B	1 row	2 rows	3 rows	4 rows	5 rows
0.6	no tip	no tip	17	9.7	7.3
0.8	no tip	23	8.3	5.7	4.6
1.0	no tip	11	5.5	4.1	3.4
1.2	no tip	6.9	4.1	3.1	2.7
1.4	42	5.1	3.2	2.6	2.2
1.6	18	4.1	2.7	2.2	1.9
1.8	12	3.4	2.3	1.9	1.6
2.0	8.5	2.9	2.0	1.7	1.5
2.2	6.7	2.5	1.8	1.5	1.3
2.4	5.5	2.2	1.6	1.3	1.2
2.6	4.7	2.0	1.5	1.2	1.1
2.8	4.1	1.8	1.3	1.1	1.00
3.0	3.6	1.7	1.2	1.0	0.93

**12.3 CHAIN**

**12.3.3 Straight lashings**



The tables are valid for **chain (Ø 9 mm, class 8)** with an MSL of 50 kN or 5,000 daN – (5,000 kg = 5 tonnes) and a pre-tension of minimum 10 kN or 1,000 daN – (1,000 kg = 1 tonne).

All masses are valid for one straight lashing.

The values in the tables are proportional to the maximum securing load (MSL) in the lashings.

**STRAIGHT LASHING**

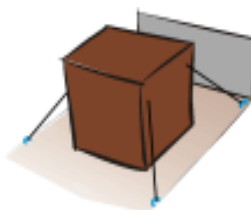

Cargo mass in tonnes prevented from sliding <i>per straight lashing</i>			
$\mu$	SIDEWAYS per side	FORWARD	BACKWARD
0.00	1.6	1.6	2.5
0.05	1.9	1.9	3.1
0.10	2.2	2.2	3.8
0.15	2.6	2.6	4.6
0.20	3.0	3.0	5.2
0.25	3.4	3.4	5.8
0.30	3.9	3.9	6.4
0.35	4.5	4.5	7.0
0.40	5.2	5.2	7.6
0.45	6.0	6.0	8.3
0.50	6.9	6.9	9.0
0.55	8.0	8.0	9.7
0.60	9.3	9.3	11
0.65	11	11	11
0.70	13	12	12

Cargo mass in tonnes prevented from tipping <i>per straight lashing</i>				
H/B	SIDEWAYS per side	H/L	FORWARD	BACKWARD
0.6	no tip	0.6	51	51
0.8	no tip	0.8	19	19
1.0	no tip	1.0	13	13
1.2	no tip	1.2	10	10
1.4	25	1.4	8.5	8.5
1.6	12	1.6	7.5	7.5
1.8	8.1	1.8	6.9	6.9
2.0	6.4	2.0	6.4	6.4
2.2	5.4	2.2	5.4	6.0
2.4	4.7	2.4	4.7	5.7
2.6	4.2	2.6	4.2	5.5
2.8	3.9	2.8	3.9	5.3
3.0	3.6	3.0	3.6	5.1

## 12.3 CHAIN



### 12.3.4 Spring lashings

The tables are valid for **chain (Ø 9 mm, class 8)** with an MSL of 50 kN or 5,000 daN – (5,000 kg = 5 tonnes) and a pre-tension of minimum 10 kN or 1,000 daN – (1,000 kg = 1 tonne).

The masses in the tables are valid for one spring lashing.

The values in the tables are proportional to the maximum securing load (MSL) in the lashings.

#### SPRING LASHING



Cargo mass in tonnes prevented from sliding <i>per spring lashing</i>		
$\mu$	FORWARD	BACKWARD
0.00	9.0	14
0.05	9.8	16
0.10	11	18
0.15	12	21
0.20	13	22
0.25	14	24
0.30	15	25
0.35	17	26
0.40	19	28
0.45	21	29
0.50	23	30
0.55	26	32
0.60	30	34
0.65	34	35
0.70	37	37

Cargo mass in tonnes prevented from tipping <i>per spring lashing</i>		
H/L	FORWARD	BACKWARD
0.6	216	216
0.8	96	96
1.0	72	72
1.2	62	62
1.4	56	56
1.6	52	52
1.8	50	50
2.0	48	48
2.2	42	47
2.4	38	46
2.6	35	45
2.8	33	44
3.0	31	43

**12.4 STEEL STRAPPING**

**12.4.1 Top-over lashings**

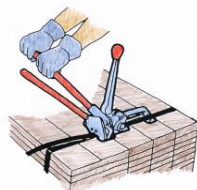

The tables are valid for **steel strapping (32 × 0.8 mm)** with an MSL of 17 kN or 1,700 daN – (1,700 kg = 1.7 tonnes) and a pre-tension of minimum 2.4 kN or 240 daN – (240 kg).

The values in the tables are proportional to the pre-tension in the lashings.

The masses in the tables are valid for one top-over lashing.

**TOP-OVER LASHING**

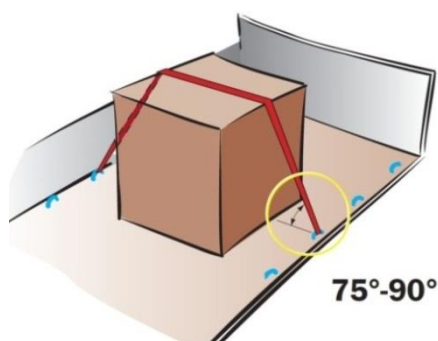

Cargo mass in tonnes prevented from sliding per top-over lashing			
$\mu$	SIDEWAYS	FORWARD	BACKWARD
0.00	0.00	0.00	0.00
0.05	0.03	0.03	0.05
0.10	0.06	0.06	0.11
0.15	0.10	0.10	0.17
0.20	0.14	0.14	0.24
0.25	0.19	0.19	0.30
0.30	0.26	0.26	0.38
0.35	0.33	0.33	0.45
0.40	0.43	0.43	0.53
0.45	0.55	0.55	0.62
0.50	0.71	0.71	0.71
0.55	0.94	0.81	0.81
0.60	1.3	0.91	0.91
0.65	1.8	1.0	1.0
0.70	3.0	1.1	1.1

Cargo mass in tonnes prevented from tipping per top-over lashing								
H/B	SIDEWAYS					H/L	FORWARD	BACKWARD
	1 row	2 rows	3 rows	4 rows	5 rows		per section	per section
0.6	no tip	no tip	1.5	0.82	0.62	0.6	11	11
0.8	no tip	1.9	0.70	0.48	0.39	0.8	3.5	3.5
1.0	no tip	0.89	0.46	0.34	0.29	1.0	2.1	2.1
1.2	no tip	0.58	0.34	0.27	0.23	1.2	1.5	1.5
1.4	3.5	0.43	0.27	0.22	0.19	1.4	1.2	1.2
1.6	1.5	0.34	0.23	0.18	0.16	1.6	0.97	0.97
1.8	0.97	0.28	0.19	0.16	0.14	1.8	0.82	0.82
2.0	0.71	0.24	0.17	0.14	0.12	2.0	0.71	0.71
2.2	0.56	0.21	0.15	0.13	0.11	2.2	0.56	0.63
2.4	0.46	0.19	0.14	0.11	0.10	2.4	0.46	0.56
2.6	0.39	0.17	0.12	0.10	0.09	2.6	0.39	0.51
2.8	0.34	0.15	0.11	0.09	0.08	2.8	0.34	0.46
3.0	0.30	0.14	0.10	0.09	0.08	3.0	0.30	0.43

**12.4 STEEL STRAPPING**

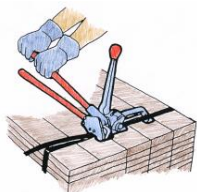

**12.4.2 Half-loop lashings**

The tables are valid for steel strapping (32 × 0.8 mm) with an MSL of 17 kN or 1,700 daN – (1,700 kg = 1.7 tonnes) and a pre-tension of minimum 2.4 kN or 240 daN – (240 kg). The masses in the tables below are valid for one pair of half-loop lashings.

The values in the tables are proportional to the maximum securing load (MSL) in the lashings.

**HALF-LOOP LASHING**

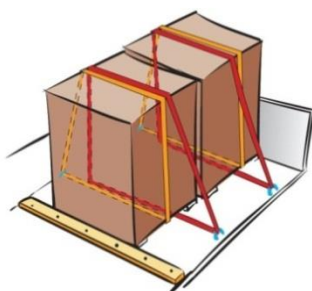

Cargo mass in tonnes prevented from sliding <i>per pair of half-loop lashing</i>	
$\mu$	SIDEWAYS
0.00	2.2
0.05	2.4
0.10	2.6
0.15	2.8
0.20	3.1
0.25	3.4
0.30	3.7
0.35	4.1
0.40	4.5
0.45	5.0
0.50	5.6
0.55	6.3
0.60	7.2
0.65	8.2
0.70	9.6

Cargo mass in tonnes prevented from tipping <i>per pair of half-loop lashing</i>					
SIDEWAYS					
H/B	1 row	2 rows	3 rows	4 rows	5 rows
0.6	no tip	no tip	5.9	3.3	2.5
0.8	no tip	7.7	2.8	1.9	1.6
1.0	no tip	3.6	1.9	1.4	1.2
1.2	no tip	2.4	1.4	1.1	0.91
1.4	1.4	1.7	1.1	0.87	0.75
1.6	6.2	1.4	0.92	0.74	0.64
1.8	3.9	1.2	0.78	0.64	0.56
2.0	2.9	0.98	0.68	0.56	0.50
2.2	2.3	0.86	0.61	0.50	0.44
2.4	1.9	0.76	0.55	0.45	0.40
2.6	1.6	0.69	0.50	0.41	0.37
2.8	1.4	0.62	0.45	0.38	0.34
3.0	1.2	0.57	0.42	0.35	0.32



**12.4 STEEL STRAPPING**

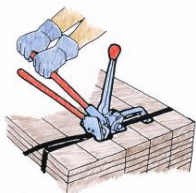

**12.4.3 Straight lashings**

The tables are valid for **steel strapping (32 × 0.8 mm)** with an MSL of 17 kN or 1,700 daN – (1,700 kg = 1.7 tonnes) and a pre-tension of minimum 2.4 kN or 240 daN – (240 kg).

All masses are valid for one straight lashing.

The values in the tables are proportional to the maximum securing load (MSL) in the lashings.

**STRAIGHT LASHING**

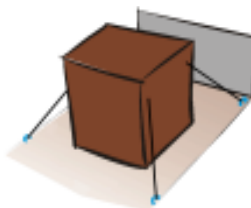

Cargo mass in tonnes prevented from sliding <i>per straight lashing</i>			
$\mu$	SIDEWAYS per side	FORWARD	BACKWARD
0.00	0.54	0.54	0.87
0.05	0.64	0.64	1.1
0.10	0.75	0.75	1.3
0.15	0.88	0.88	1.6
0.20	1.0	1.0	1.8
0.25	1.2	1.2	2.0
0.30	1.3	1.3	2.2
0.35	1.5	1.5	2.4
0.40	1.8	1.8	2.6
0.45	2.0	2.0	2.8
0.50	2.3	2.3	3.1
0.55	2.7	2.7	3.3
0.60	3.2	3.2	3.6
0.65	3.7	3.7	3.9
0.70	4.4	4.1	4.1

Cargo mass in tonnes prevented from tipping <i>per straight lashing</i>				
H/B	SIDEWAYS per side	H/L	FORWARD	BACKWARD
0.6	no tip	0.6	17	17
0.8	no tip	0.8	6.5	6.5
1.0	no tip	1.0	4.3	4.3
1.2	no tip	1.2	3.4	3.4
1.4	8.7	1.4	2.9	2.9
1.6	4.0	1.6	2.6	2.6
1.8	2.8	1.8	2.3	2.3
2.0	2.2	2.0	2.2	2.2
2.2	1.8	2.2	1.8	2.0
2.4	1.6	2.4	1.6	1.9
2.6	1.4	2.6	1.4	1.9
2.8	1.3	2.8	1.3	1.8
3.0	1.2	3.0	1.2	1.7

## 12.4 STEEL STRAPPING

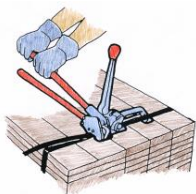

### 12.4.4 Spring lashings

The tables are valid for **steel strapping (32 × 0.8 mm)** with an MSL of 17 kN or 1,700 daN – (1,700 kg = 1.7 tonnes) and a pre-tension of minimum 2.4 kN or 240 daN – (240 kg). The masses in the tables are valid for one spring lashing.

The values in the tables are proportional to the maximum securing load (MSL) in the lashings.

#### SPRING LASHING



Cargo mass in tonnes prevented from sliding <i>per spring lashing</i>		
$\mu$	FORWARD	BACKWARD
0.00	3.1	4.9
0.05	3.3	5.5
0.10	3.6	6.2
0.15	4.0	7.0
0.20	4.3	7.6
0.25	4.8	8.0
0.30	5.2	8.5
0.35	5.8	8.9
0.40	6.4	9.4
0.45	7.1	9.9
0.50	7.9	10
0.55	8.9	11
0.60	10	11
0.65	12	12
0.70	13	13

Cargo mass in tonnes prevented from tipping <i>per spring lashing</i>		
H/L	FORWARD	BACKWARD
0.6	74	74
0.8	33	33
1.0	25	25
1.2	21	21
1.4	19	19
1.6	18	18
1.8	17	17
2.0	16	16
2.2	14	16
2.4	13	15
2.6	12	15
2.8	11	15
3.0	11	15

## 12.5 WIRE

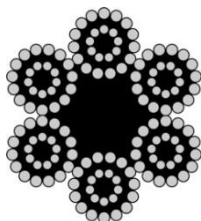

### TOP-OVER LASHING

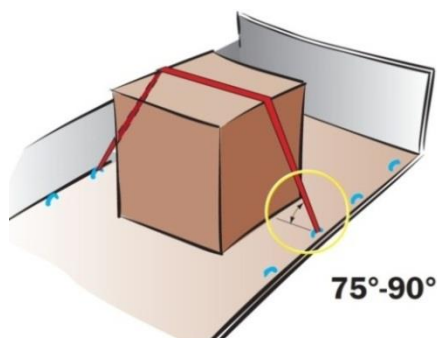

### 12.5.1 Top-over lashings

The tables are valid for **steel wire rope (Ø 16 mm/144 wires)** with an MSL of 91 kN or 9,100 daN – (9,100 kg = 9.1 tonnes) and a pre-tension of minimum 10 kN or 1,000 daN – (1,000 kg = 1 tonne).

The values in the tables are proportional to the pre-tension in the lashings.

The masses in the tables are valid for one top-over lashing.

Cargo mass in tonnes prevented from sliding per top-over lashing			
$\mu$	SIDWAYS	FORWARD	BACKWARD
<b>0.00</b>	0.00	0.00	0.00
<b>0.05</b>	0.12	0.12	0.20
<b>0.10</b>	0.25	0.25	0.44
<b>0.15</b>	0.41	0.41	0.72
<b>0.20</b>	0.59	0.59	0.98
<b>0.25</b>	0.81	0.81	1.3
<b>0.30</b>	1.1	1.1	1.6
<b>0.35</b>	1.4	1.4	1.9
<b>0.40</b>	1.8	1.8	2.2
<b>0.45</b>	2.3	2.3	2.6
<b>0.50</b>	3.0	3.0	3.0
<b>0.55</b>	3.9	3.4	3.4
<b>0.60</b>	5.3	3.8	3.8
<b>0.65</b>	7.7	4.3	4.3
<b>0.70</b>	12	4.8	4.8

Cargo mass in tonnes prevented from tipping per top-over lashing								
SIDWAYS						FORWARD		BACKWARD
H/B	1 row	2 rows	3 rows	4 rows	5 rows	H/L	per section	per section
<b>0.6</b>	no tip	no tip	6.1	3.4	2.6	<b>0.6</b>	44	44
<b>0.8</b>	no tip	8.0	2.9	2.0	1.6	<b>0.8</b>	15	15
<b>1.0</b>	no tip	3.7	1.9	1.4	1.2	<b>1.0</b>	8.9	8.9
<b>1.2</b>	no tip	2.4	1.4	1.1	0.95	<b>1.2</b>	6.3	6.3
<b>1.4</b>	15	1.8	1.1	0.90	0.78	<b>1.4</b>	4.9	4.9
<b>1.6</b>	6.3	1.4	0.95	0.76	0.67	<b>1.6</b>	4.0	4.0
<b>1.8</b>	4.0	1.2	0.81	0.66	0.58	<b>1.8</b>	3.4	3.4
<b>2.0</b>	3.0	1.0	0.71	0.58	0.52	<b>2.0</b>	3.0	3.0
<b>2.2</b>	2.3	0.89	0.63	0.52	0.46	<b>2.2</b>	2.3	2.6
<b>2.4</b>	1.9	0.79	0.57	0.47	0.42	<b>2.4</b>	1.9	2.3
<b>2.6</b>	1.6	0.71	0.51	0.43	0.38	<b>2.6</b>	1.6	2.1
<b>2.8</b>	1.4	0.64	0.47	0.40	0.35	<b>2.8</b>	1.4	1.9
<b>3.0</b>	1.3	0.59	0.43	0.37	0.33	<b>3.0</b>	1.3	1.8

**12.5 WIRE**

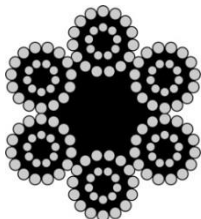

**12.5.2 Half-loop lashings**

The tables are valid for **steel wire rope (Ø 16 mm/144 wires)** with an MSL of 91 kN or 9,100 daN – (9,100 kg = 9.1 tonnes) and a pre-tension of minimum 10 kN or 1,000 daN – (1,000 kg = 1 tonne). The masses in the tables below are valid for one pair of half-loop lashings.

The values in the tables are proportional to the maximum securing load (MSL) in the lashings.

**HALF-LOOP LASHING**

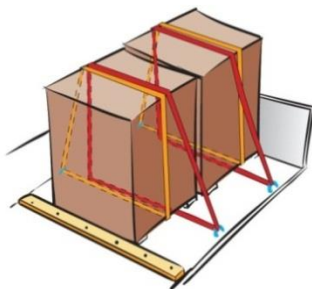

Cargo mass in tonnes prevented from sliding <i>per pair of half-loop lashing</i>	
$\mu$	SIDEWAYS
0.00	12
0.05	13
0.10	14
0.15	15
0.20	16
0.25	18
0.30	20
0.35	22
0.40	24
0.45	27
0.50	30
0.55	34
0.60	38
0.65	44
0.70	51

Cargo mass in tonnes prevented from tipping <i>per pair of half-loop lashing</i>					
SIDEWAYS					
H/B	1 row	2 rows	3 rows	4 rows	5 rows
0.6	no tip	no tip	32	18	13
0.8	no tip	41	15	10	8.4
1.0	no tip	19	9.9	7.4	6.2
1.2	no tip	13	7.4	5.7	4.9
1.4	77	9.4	5.9	4.7	4.0
1.6	33	7.4	4.9	3.9	3.4
1.8	21	6.2	4.2	3.4	3.0
2.0	15	5.3	3.7	3.0	2.7
2.2	12	4.6	3.3	2.7	2.4
2.4	10	4.1	2.9	2.4	2.2
2.6	8.6	3.7	2.7	2.2	2.0
2.8	7.5	3.3	2.4	2.0	1.8
3.0	6.6	3.1	2.2	1.9	1.7

**12.5 WIRE**

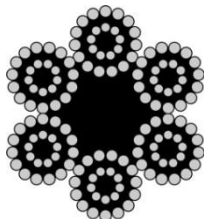

**12.5.3 Straight lashings**

The tables are valid for **steel wire rope (Ø 16 mm/144 wires)** with an MSL of 91 kN or 9,100 daN – (9,100 kg = 9.1 tonnes) and a pre-tension of minimum 10 kN or 1,000 daN – (1,000 kg = 1 tonne).

All masses are valid for one straight lashing.

The values in the tables are proportional to the maximum securing load (MSL) in the lashings.

**STRAIGHT LASHING**

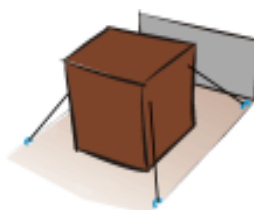

Cargo mass in tonnes prevented from sliding <i>per straight lashing</i>			
$\mu$	SIDEWAYS per side	FORWARD	BACKWARD
0.00	2.9	2.9	4.6
0.05	3.4	3.4	5.7
0.10	4.0	4.0	6.9
0.15	4.7	4.7	8.3
0.20	5.4	5.4	9.5
0.25	6.2	6.2	11
0.30	7.2	7.2	12
0.35	8.2	8.2	13
0.40	9.5	9.5	14
0.45	11	11	15
0.50	13	13	16
0.55	15	15	18
0.60	17	17	19
0.65	20	20	21
0.70	23	22	22

Cargo mass in tonnes prevented from tipping <i>per straight lashing</i>				
H/B	SIDEWAYS per side	H/L	FORWARD	BACKWARD
0.6	no tip	0.6	93	93
0.8	no tip	0.8	35	35
1.0	no tip	1.0	23	23
1.2	no tip	1.2	18	18
1.4	46	1.4	15	15
1.6	22	1.6	14	14
1.8	15	1.8	12	12
2.0	12	2.0	12	12
2.2	9.8	2.2	9.8	11
2.4	8.6	2.4	8.6	10
2.6	7.7	2.6	7.7	9.9
2.8	7.1	2.8	7.1	9.6
3.0	6.6	3.0	6.6	9.3

## 12.5 WIRE

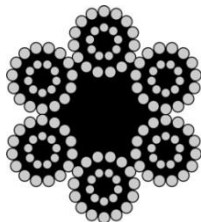

### 12.5.4 Spring lashings

The tables are valid for **steel wire rope (Ø 16 mm/144 wires)** with an MSL of 91 kN or 9,100 daN – (9,100 kg = 9.1 tonnes) and a pre-tension of minimum 10 kN or 1,000 daN – (1,000 kg = 1 tonne).

The masses in the tables are valid for one spring lashing.

The values in the tables are proportional to the maximum securing load (MSL) in the lashings.

#### SPRING LASHING



Cargo mass in tonnes prevented from sliding <i>per spring lashing</i>		
$\mu$	FORWARD	BACKWARD
0.00	16	26
0.05	18	29
0.10	19	33
0.15	21	38
0.20	23	41
0.25	25	43
0.30	28	45
0.35	31	48
0.40	34	50
0.45	38	53
0.50	42	56
0.55	48	58
0.60	54	61
0.65	62	65
0.70	68	68

Cargo mass in tonnes prevented from tipping <i>per spring lashing</i>		
H/L	FORWARD	BACKWARD
0.6	394	394
0.8	175	175
1.0	131	131
1.2	112	112
1.4	102	102
1.6	95	95
1.8	91	91
2.0	87	87
2.2	76	85
2.4	68	83
2.6	63	81
2.8	59	80
3.0	56	79

## 12.6 TAG WASHERS AND NAILS

<b>TAG WASHER</b>							
							
Approximate cargo mass in tonnes prevented from sliding by one tag washer for wood on wood in combination with top-over lashing only							
$\mu^{**}$	<b>SIDEWAYS</b>						
	$\varnothing$ 48	$\varnothing$ 62	$\varnothing$ 75	$\varnothing$ 95	30x57	48x65	130x130
BS (ton)	0.5	0.7	0.9	1.2	0.5	0.7	1.5
0.10	0.18	0.25	0.32	0.43	0.18	0.25	0.54
0.20	0.21	0.29	0.38	0.50	0.21	0.29	0.63
0.30	0.25	0.35	0.45	0.60	0.25	0.35	0.75
<b>FORWARD</b>							
0.10	0.18	0.25	0.32	0.43	0.18	0.25	0.54
0.20	0.21	0.29	0.38	0.50	0.21	0.29	0.63
0.30	0.25	0.35	0.45	0.60	0.25	0.35	0.75
<b>BACKWARD</b>							
0.10	0.31	0.44	0.56	0.75	0.31	0.44	0.94
0.20	0.35	0.49	0.63	0.83	0.35	0.49	1.0
0.30	0.37	0.51	0.66	0.88	0.37	0.51	1.1

<sup>\*\*</sup> Between tag washer and platform bed/cargo.

<b>4 in (100 mm) – NAIL</b>						
Approximate cargo mass in tonnes prevented from sliding by one nail						
$\mu^{***}$	<b>SIDEWAYS</b>		<b>FORWARD</b>		<b>BACKWARD</b>	
	per side		blank	galvanised	blank	galvanised
BS (ton)	blank	galvanised	blank	galvanised	blank	galvanised
0.00	0.14	0.20	0.14	0.20	0.22	0.32
0.05	0.15	0.21	0.15	0.21	0.24	0.36
0.10	0.16	0.23	0.16	0.23	0.28	0.40
0.15	0.17	0.25	0.17	0.25	0.30	0.43
0.20	0.18	0.27	0.18	0.27	0.31	0.44
0.25	0.20	0.29	0.20	0.29	0.31	0.46
0.30	0.22	0.32	0.22	0.32	0.32	0.47
0.35	0.24	0.36	0.24	0.36	0.33	0.48
0.40	0.28	0.40	0.28	0.40	0.34	0.50
0.45	0.31	0.46	0.31	0.46	0.35	0.52
0.50	0.37	0.53	0.37	0.53	0.37	0.53
0.55	0.44	0.64	0.38	0.55	0.38	0.55
0.60	0.55	0.80	0.39	0.57	0.39	0.57
0.65	0.73	1.1	0.41	0.59	0.41	0.59
0.70	1.1	1.6	0.42	0.62	0.42	0.62

<sup>\*\*\*</sup> Between cargo and platform bed.



## INFORMATIVE MATERIAL 6

### INTERMODAL LOAD DISTRIBUTION

The text for this informative material has been drawn from three academic papers and is reproduced with the permission of the author\* † ‡.

#### 1 Introduction

1.1 Construction of load distribution diagrams requires fulfilling not only the technical characteristics of maritime containers, wagons and vehicles but also various requirements defined by legislative measures, guidelines and standards. The informative material focuses on the 40-foot general purpose container as an example of the load distribution diagram generation.

1.2 Cargo centre of gravity is important to know when packing containers. The standard ISO 830, section 8.1.3, defines eccentricity of centre of gravity as follows: "longitudinal and/or lateral horizontal differences between the centre of gravity of any container (empty or loaded, with or without fittings and appliances) and the geometric centre of the diagonals of the centres of the four bottom corner fittings".

1.3 The container payload – P is defined according to section 5.3.3 of the standard ISO 830 as "maximum permitted mass of payload, including such cargo securement arrangements and/or dunnage as are not associated with the container in its normal operating condition". It can be calculated by subtracting the tare mass from the maximum permissible gross mass of the container.

$$P = R - T$$

P = Payload

R = Maximum permitted gross mass

T = Tare mass

---

\* Intermodal load distribution diagram of forty-foot container loaded on two-axle container wagon of Lgs type / Juraj Jagelčák. In: Horizons of Railway Transport: Scientific Papers of the University of Žilina, Faculty of Operation and Economics of Transport and Communications. – ISSN 1338–287X. – No.1 Vol. 2 (2011), pp. 53–59.

† Intermodal load distribution diagram of forty-foot container loaded on container chassis / Juraj Jagelčák – Ján Vrábek – Miroslav Fazekaš. In: CMDTUR 2012: conference proceedings : 6. international scientific conference: Žilina – Stráža, Slovakia, 19.04.–20.04.2012. – Žilina: University of Žilina in EDIS, 2012. – ISBN 978–80–554–0512–4. – p. 1–131–139.

‡ Intermodal road–rail–sea load distribution diagram of forty-foot container / Juraj Jagelčák. In: Perner's Contacts. – ISSN 1801–674X. – 2012. – No. 2 (July 2012), p. 51–62.

## 2 Load distribution diagrams

### 2.1 Load distribution diagram for 40-foot container

2.1.1 The container payload, tare and gross mass as well as maximum allowed eccentricity of container centre of gravity are necessary to construct container load distribution diagram. The diagram limits the position of cargo centre of gravity (CoG) of certain mass to not exceed container gross mass, payload and to meet load distribution requirements. A 40-foot container with a gross mass of 30,480 kg, tare of 4,000 kg and payload of 26,480 kg is used as an example. The container load distribution diagram (LDD(C)) specifies boundaries of cargo CoG when eccentricity of container CoG is 5% and 10%.

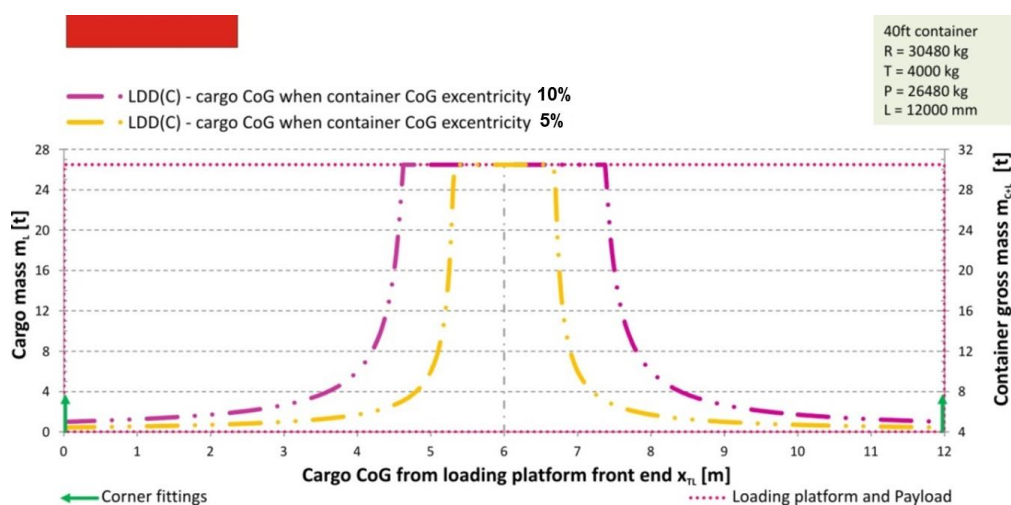

Figure 6.1 – Load distribution diagram for 40-foot container

2.1.2 The result in figure 6.1 shows that these boundaries are smaller (within the maximum container payload) and the centre of gravity of any cargo should be located inside border lines around container centre.

### 2.2 Load distribution diagram of two-axle container wagon

2.2.1 This two-axle wagon is a suitable example because it is possible to load 40-foot container only and wagon payload is lower than container gross mass.

2.2.2 Load distribution diagram for a two axle container wagon is influenced by following parameters:

- wagon tare ( $m_w$ );
- wagon gross mass for different route category (A, B, C, D), train speed (S, SS) and selected rail operators (A – 32t, B – 36t, C – 40t);
- wagon payload for different route category (A, B, C, D), train speed (S, SS) and selected rail operators ( $m_C+L$ );
- maximum authorized axle mass per route category (A – 16t, B – 18t, C – 20t, D – 22.5t) R1max, R2max curves as figure below;
- maximum uneven axle load 2:1 according to UIC Loading guidelines;

- axle tare mass (R1W, R2W);
- wagon wheel base (b);
- distance from the end of the loading platform to neighbouring axle (a);
- length of the loading platform (L); and
- position of wagon container locks.

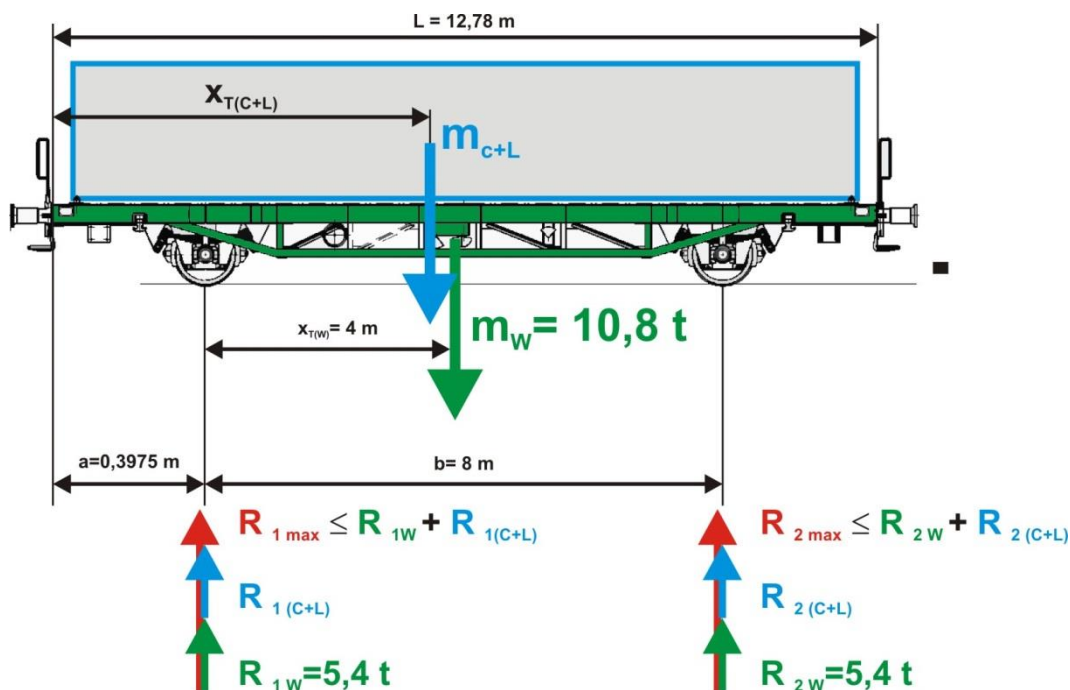

Figure 6.2 – Sample container wagon

2.2.3 Load distribution diagram for the sample rail wagon are defined as:

- maximum axle mass (R1max, R2max) per route category (A, B and C curves for R1max and R2 max);
- maximum payload for route category (mC+L); and
- R1 : R2 < 2 : 1 and R2 : R1 < 2 : 1 curves.

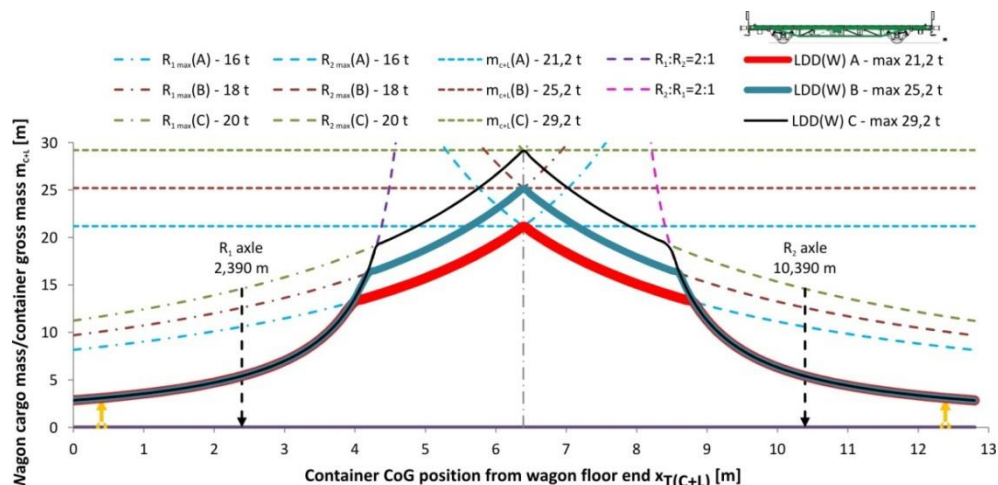

Figure 6.3 Load distribution diagrams (LDD) for container wagon for different route categories

2.2.4 Load distribution diagrams of a typical container wagon show area where cargo centre of gravity for different cargo mass should be located. This area is bounded by maximum axle mass per different route category and by maximum uneven axle load 2:1. The axle curves meet in one point which presents disadvantage because if it is intended to load the cargo with the highest possible mass its centre of gravity should be right in the middle of the wagon. For example if CoG of load of 29.2 tonnes is 6.7 m (6.39 m is central axis) from wagon floor end this creates axle mass  $R_1 = 18.9$  tonnes and  $R_2 = 21.1$  tonnes which is higher than 20 tonnes permitted per route category C.

### 2.3 Load distribution diagram of semi-trailer container trailer

2.3.1 Technical characteristics of typical gooseneck 45-foot extendable trailer are used in this section. Load distribution diagram of semi-trailer is influenced by following parameters:

- container trailer tare ( $m_T$ );
- maximum kingpin load technical suitable for three-axle tractor ( $R1_{max(3)}$ ) and kingpin load influenced by two-axle tractor ( $R1_{max(2)}$ ) –  $R1_{max}$  curves in figure below;
- maximum gross combination mass ( $m_{GCM}$ ) or semi-trailer gross mass ( $m_{GTM}$ );
- kingpin and triple axle tare ( $R1T$ ,  $R2T$ );
- maximum triple axle load ( $R2_{max}$ ) –  $R2_{max}$  curve;
- length of loading platform ( $L$ );
- position of container twist-locks for 40-foot container;
- distance from trailer platform front end to king pin axis ( $a$ );
- distance kingpin to triple axle axis ( $b$ ); and
- minimum kingpin and triple axle load (25% / 25% of maximum semi-trailer mass is chosen) –  $R1_{min}$ ,  $R2_{min}$ .

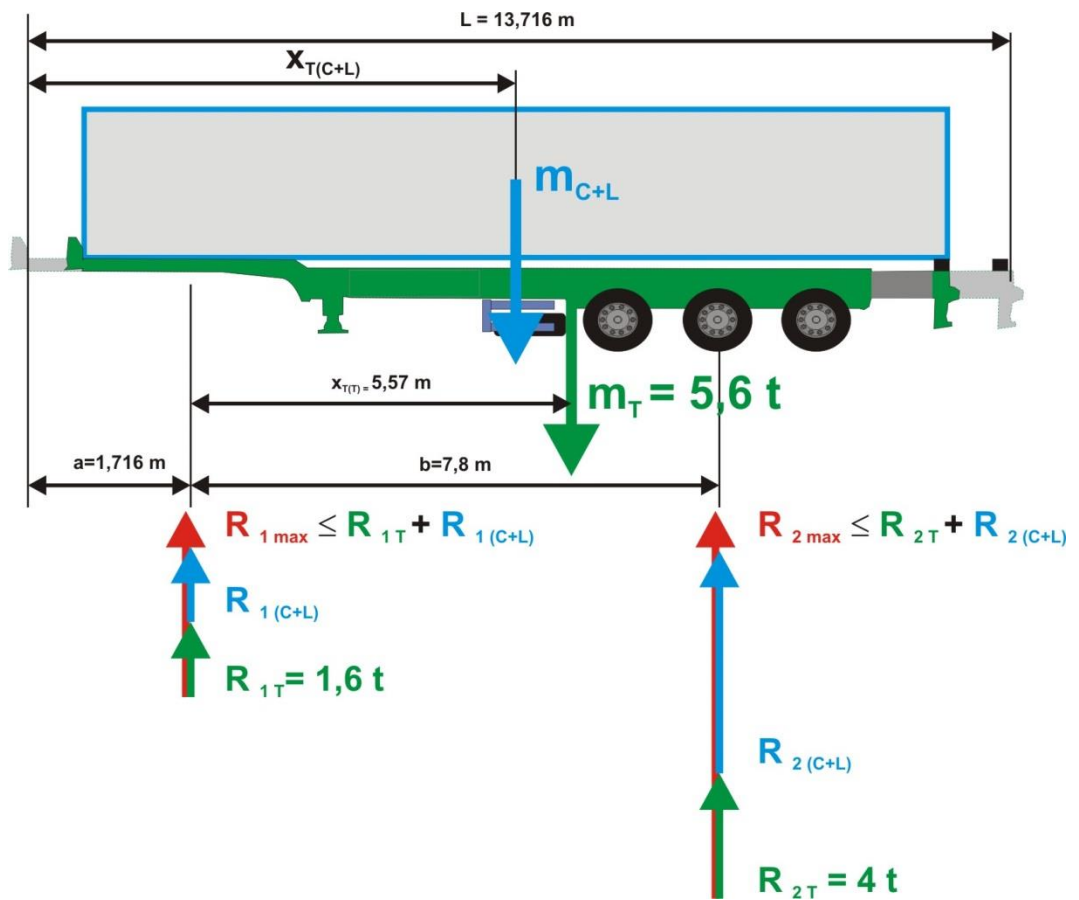

Figure 6.4 – Typical three axle extendable 45-foot container trailer

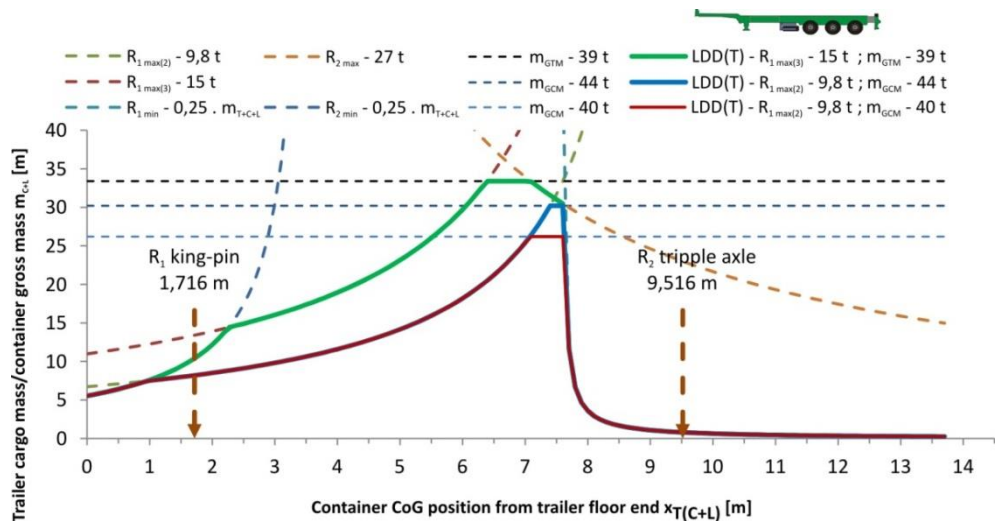

Figure 6.5 – Three alternatives for load distribution diagram for container trailer

2.4 Three alternatives of load distribution diagrams of the example container trailer are shown in the figure above. Permissible load on kingpin determines if it is necessary to use two-axle or three-axle tractor when it is possible to use permissible technical load on kingpin of 15 tonnes. Because of maximum allowed mass of 18 tonnes for two axle tractor limits permissible load on kingpin to 9.8 tonnes (8.2 tonnes tractor tare supposed) when two axle tractor is used. Maximum gross combination masses and maximum semi-trailer gross mass are shown as  $m_{GCM}$  and  $m_{GTM}$  axis respectively and limits the payload of container trailer.

### 3 Intermodal load distribution diagrams

#### 3.1 Intermodal load distribution diagram of a 40-foot container carried on two-axle container wagon

3.1.1 An intermodal load distribution diagram of a 40-foot container loaded on a wagon can be constructed from container and wagon LDDs. Consideration should be given to the container tare because this also represents the cargo for the wagon, therefore the LLD for the wagon is constructed using the container tare as LDD (W + C). The diagram below shows the container GM on right vertical axis and cargo mass on left vertical axis so it is possible to check loading of container as well as wagon with the container simultaneously.

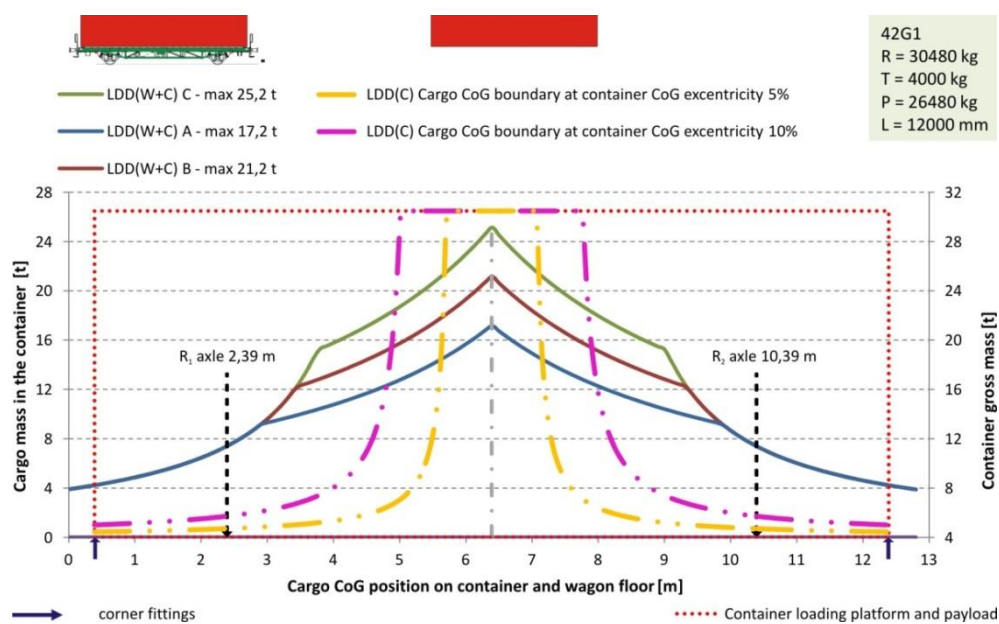

Figure 6.6 – Load distribution diagram of 40-foot container loaded onto a 2 axle wagon

3.1.2 When container LDD (C) and wagon LDD (W + C) are combined then nine areas of position of cargo centre of gravity for different mass are bounded by LDD curves for this type of wagon constructed for route categories A, B, C. LDD (W + C) limits maximum cargo mass and LDD (C) position of CoG around container centre line. Diagram LDD (W + C) for route category C also shows that it is not possible to utilize full container payload.

#### 3.2 Intermodal load distribution diagram of 40-foot container carried on container chassis

3.2.1 An intermodal load distribution diagram of a 40-foot container loaded on a chassis can be constructed from container and chassis LDDs. Consideration should also be given to the container tare mass as LDD (T + C) because this also includes the payload of container



chassis. Again container gross mass is on the right vertical axis and cargo mass on the left vertical axis in the diagram below. Therefore, it is possible to check loading of container as well as chassis with the container.

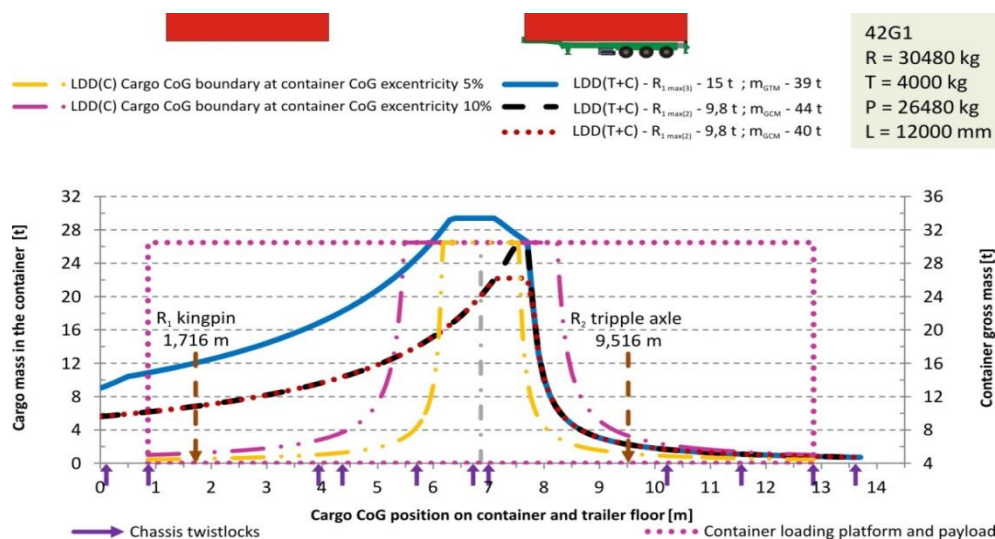

Figure 6.7 Load distribution diagram for 40ft container on container trailer

3.2.2 When container LDD (C) and chassis LDD (T+C) are combined then correct load distribution to maximum payload is possible only when three-axle tractor is used. When maximum kingpin load is limited by two-axle tractor than the centre of gravity should be eccentricly towards container doors and almost on the limits of container load distribution. When lighter two-axle tractor is used the loading situation looks more favourably for gross combination weight 40 tonnes but for GCM 44 tonnes there is not a big difference. In case that the cargo centre of gravity is in first container half (close to front wall where loading with container doors towards back is supposed) then the tractor is overloaded (see figure 6.7).

**3.3 Intermodal load distribution diagram of a 40-foot container carried on two-axle container wagon and container chassis**

3.3.1 Intermodal road-rail-sea load distribution diagram is constructed when LDD (C) of container, container wagon LDD (W+C) and container chassis LDD (T+C) are combined. Here the limitations for loading on wagon and container chassis are again seen.

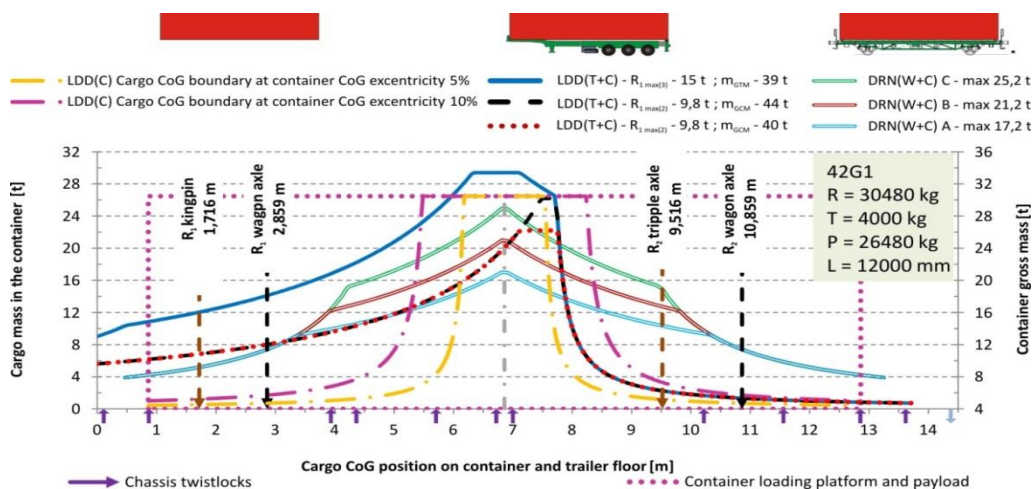

Figure 6.8 – Load distribution diagram for 40-foot container mounted on trailer and wagon



3.3.2 Final diagram specifies cargo mass up to 15 tonnes, where LDD (W+C)s and LDD (T+C)s are not exceeded. When cargo mass is 16 tonnes route category A of railway wagon is exceeded when cargo CoG eccentricity is 5% and on the boundary of allowable mass on kingpin for two-axle tractor and GCM 40 tonnes. With increasing mass the position of CoG must move towards container doors up to 22 tonnes, for GCM 40 tonnes and maximum cargo mass for route category C at 5% cargo CoG eccentricity. If GCM 44 tonnes is allowed then full container payload of 26 tonnes is utilized but such container is not possible to carry onto railway wagon because cargo mass for route category C is exceeded.

3.3.3 Following example shows how to use previous intermodal load distribution diagram. Such a container will be loaded by 44 pallets with a pallet mass of 480 kg, cargo mass of 21.12 tonnes and container gross mass of 25.12 tonnes. Pallets are loaded in two layers, upper layer incomplete. Bottom full layer consists of 30 pallets and upper layer from 6 pallets loaded at container front end and 8 pallets loaded at the doors. Eccentricity of cargo CoG is 1.024% and container CoG is 1.020% towards doors so the pallets are correctly loaded with regard to container LDD(C)'s and also correctly loaded to GCM 40 tonnes and rail route category C.

3.3.4 The figure above shows all LDD's and we can clearly decide that maximum cargo mass in this case is 22 tonnes limited by container chassis and gross combination mass of 40 tonnes. Maximum eccentricity of the cargo centre of gravity will be maximum 3.6% which is limited by maximum axle load of railway wagon for route category C.

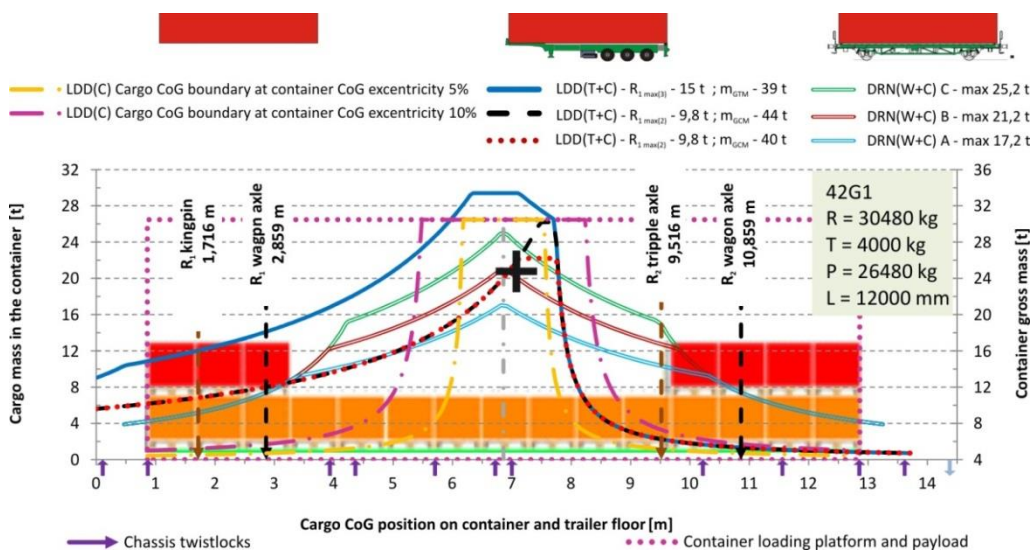

Figure 6.9 – Load distribution diagram for 40-foot container mounted on trailer and wagon with pallet loading and cargo CoG position (black cross)

## INFORMATIVE MATERIAL 7

### MANUAL HANDLING

#### 1 Introduction

1.1 Manual handling relates to the moving of items either by lifting, lowering, carrying, pushing or pulling. But it's not just a case of "pulling something" due to the weight of the item, although this can be a cause of injury. Injuries can be caused because of the amount of times a packer has to pick up or carry an item, the distance the packer carries it, the height the packer has to pick it up from or put it down at (picking it up from the floor, putting it on a shelf above shoulder level) and any twisting, bending stretching or other awkward posture that may be adopted whilst doing a task.

1.2 Manual handling is one of the most common causes of injury at work and causes over a third of all workplace injuries which include work related musculoskeletal disorders such as upper and lower limb pain/disorders, joint and repetitive strain injuries of various types.

1.3 Manual handling injuries can occur almost anywhere in the workplace and heavy manual labour, awkward postures and previous or existing injury can increase the risk. Work related manual handling injuries can have serious implications for both the employer and the person who has been injured. Employers may have to bear substantial costs, through lost production, sickness absence, costs of retraining, wages/overtime to cover for the absent person and potentially compensation payments. The injured person may find that their ability to do their job is affected and there may be an impact on their lifestyle, leisure activities, ability to sleep and future job prospects.

1.4 It is essential that the risk to packers is properly managed. If possible all manual handling should be eliminated, however, this is not always possible and where such handling is necessary, the risk of injury to the packer should be reduced by using mechanical handling devices (MHDs).

1.5 A recent survey of self-reported work-related illness estimated that in 2001/02, 1.1 million people in Great Britain suffered from musculoskeletal disorders (MSDs) caused or made worse by their current or past work. An estimated 12.3 million working days were lost due to these work-related MSDs. On average each sufferer took about 20 days off in that 12-month period.

1.6 Manual handling injuries can occur wherever people are at work. In terms of CTUs, it will be associated with packing and unpacking. Heavy manual labour, awkward postures and previous or existing injury are all risk factors implicated in the development of MSDs.

- consider the risks from manual handling to the health and safety of their employees; and
- consult and involve the workforce. Packers know first-hand what the risks in the workplace are. So they can probably offer practical solutions to controlling them;

Health and safety regulations will generally require employers to:

- avoid the need for hazardous manual handling, so far as is reasonably practicable;

- assess the risk of injury from any hazardous manual handling that can't be avoided; and
- reduce the risk of injury from hazardous manual handling, so far as is reasonably practicable.

1.7 Packers have duties too. They should:

- follow appropriate systems of work laid down for their safety;
- make proper use of equipment provided for their safety;
- cooperate with their employer on health and safety matters;
- inform the employer if they identify hazardous handling activities; and
- take care to ensure that their activities do not put others at risk.

## 2 Manual handling practice

When involved in manual handling the following practical tips should be considered:

2.1 Think before lifting/handling. Plan the lift. Can handling aids be used? Where is the load going to be placed? Will help be needed with the load? Remove obstructions such as discarded wrapping materials. For a long lift, consider resting the load midway on a table or bench to change grip.



2.2 Keep the load close to the waist.

2.3 Keep the load close to the body for as long as possible while lifting. Keep the heaviest side of the load next to the body. If a close approach to the load is not possible, try to slide it towards the body before attempting to lift it.

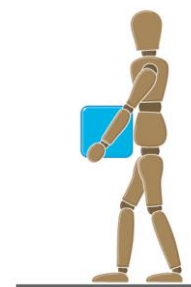

2.4 Adopt a stable position. Workers should be prepared to move their feet during lifting to maintain stability. Avoid tight clothing or unsuitable footwear, which may make this difficult.



2.5 Get a good hold. The load should be hugged as close as possible to the body. This may be better than gripping it tightly with hands only. Maintain balance.

2.6 Start in a good posture. At the start of the lift, slight bending of the back, hips and knees is preferable to fully flexing the back (stooping) or fully flexing the hips and knees (squatting).



2.7 Don't flex the back any further while lifting. This can happen if the legs begin to straighten before starting to raise the load.

2.8 Avoid twisting the back or leaning sideways, especially while the back is bent. Shoulders should be kept level and facing in the same direction as the hips. Turning by moving the feet is better than twisting and lifting at the same time.

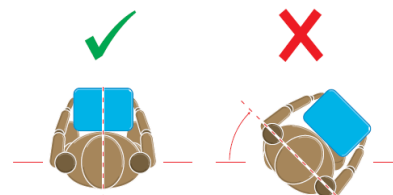

2.9 Keep the head up when handling. Look ahead, not down at the load, once it has been held securely.

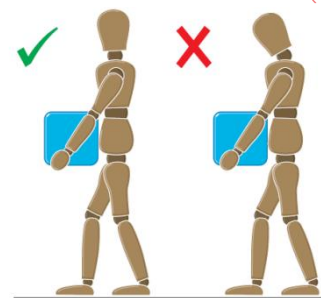

2.10 Move smoothly. The load should not be jerked or snatched as this can make it harder to keep control and can increase the risk of injury.

2.11 Don't lift or handle more than can be easily managed. There is a difference between what people can lift and what they can safely lift.

2.12 Put down, then adjust. If precise positioning of the load is necessary, put it down first, then slide it into the desired position.

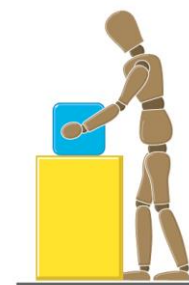

### 3 Mechanical handling

Many packages are placed within cargo transport units manually. However, to assist the packers a number of mechanical handling devices (MHDs) are used.

3.1 Sack truck – heavy and difficult to lift and grasp items can be moved into the CTU by means of a simple sack truck.



3.2 Conveyor – a belt or roller conveyor that can be extended into the length of a CTU can be used to deliver packages to the packers where they are to be stacked. Generally used for light packages

3.3 Pallet truck – with the increase in pallets being used as the platform for a unitized package, a manual or motorized pallet truck can be used to move pallets into their position. Where the CTU cannot be easily connected by a ramp to the loading bay, a pallet truck can be used to reposition pallets delivered by a fork truck.

3.4 Electric or manual hoist – standard pallet trucks may not be able to carry two loaded pallets into the CTU so a hoist truck may be required.

3.5 Lift truck – as an alternative a fork truck can be used to position pallets within the CTU.



## 4 Mechanical handling techniques

Mechanical handling devices should comply with the following guidelines:

4.1 Care should be taken that there is sufficient height in the CTU for the hoist or lift truck when positioning upper pallets and a proper risk assessment carried out for the material handling equipment.

4.2 Ensure that the correct equipment is provided for the task and it is fit for purpose.

4.3 Lack of good handles can increase the amount of undue effort needed to move the load. MHDs should have handle heights that are between the shoulder and waist. Handle height in relation to the different users can be a risk factor for their posture; they may find it uncomfortable and/or unable to apply a suitable grip.

4.4 If the equipment is without brakes it could be difficult to stop. If it has brakes but the brakes are poor/ineffective this could also make it difficult to stop.

4.5 When purchasing new trolleys etc., ensure they are of good quality with large diameter wheels made of suitable material and with castors, bearings etc. which will last with minimum maintenance.

4.6 Ensure that the wheels suit the flooring and environment, e.g. are the wheels on the device suited to the aluminium T floor in a refrigerated CTU.

## 5 Mechanical handling safety

5.1 Material handling devices should be maintained as part of a regular programme and a well promoted fault reporting system.

5.2 The use of mechanical handling devices described above presents packers of CTUs with additional risks and handling issues.

5.3 Wheeled MHDs such as the sack truck or the pallet truck have relatively small diameter wheels, often narrow in width presenting a very small footprint. The small footprint associated with a high mass will increase the risk of a floor failure. Such a failure can result in:

- injuries to the packer as the device jerks or stops suddenly;
- damage to the package if it should fall off the device;
- damage to the device; and / or
- damage to the CTU.

5.4 Mechanical handling devices can be powered, so that a motor or engine propels the device into and out of the CTU or non-powered. Non-powered devices, whether empty or laden, require that the packer move them by either pulling or pushing.

5.5 When people push and pull, for example trollies, there may be risk of other musculoskeletal disorders which are discussed below.

5.6 The UK produced the following statistics on reported incidents related to pushing and pulling:

- 11% of manual handling – reported accidents investigated by HSE involved pushing and pulling;
- the most frequently reported site of injury was the back (44%);
- the second most frequently reported site of injury was the upper limbs (shoulders, arms, wrists and hands), accounting for 28.6% of the total;
- 12% more accidents involved pulling than pushing (where the activity could be identified within the reports); and
- 35% of pushing and pulling accidents involved wheeled objects.

5.7 There are a number of risk factors associated with pushing and pulling of loads. To make it easy to remember, it can be broken down to **TILE**:

#### 5.7.1 Task

- steep slopes and rough surfaces can increase the amount of force required to push/pull a load;
- packers should enlist help from another worker whenever necessary if they have to negotiate a slope or ramp, as pushing and pulling forces can be very high;
- for example, if a load of 400 kg is moved up a slope of 1 in 12 (about 5°), the required force is over 30 kg even in ideal conditions with good wheels and a smooth slope;
- the risk also increases over longer distances and when the frequency of pushing/pulling does not provide sufficient rest/recovery time;

- obstacles can create risks by the worker trying to avoid collision;
- large amounts of effort to start or stop the load moving or even to keep it moving;
- position of the hands is comfortable for the worker. The hands are best positioned between the waist and shoulder height; and
- to make it easier to push or pull, employees should keep their feet well away from the load and go no faster than walking speed. This will stop them becoming too tired too quickly.

#### 5.7.2 Individual

- packers may have different characteristics and capabilities. For example, a tall worker may have to adopt an awkward posture to push a trolley with low handles, while a shorter worker may have difficulty seeing over the load;
- individual concerns such as strains and sprains may temporarily reduce the amount of force a worker can safely handle;
- the task may require unusual capability, if this is so think about how and who should carry out the task;
- specialized training or instruction may be needed for lifting and carting equipment.

#### 5.7.3 Load

- consider the mass of the load and the mass of the equipment being used by the worker;
- ensure the load is not excessive and that it is sufficiently stable for negotiating any slopes, corners or rough surfaces that may be encountered;
- as a rough guide the amount of force that needs to be applied to move a load over a flat, level surface using a well-maintained handling aid is at least 2% of the load mass;
- for example, if the load mass is 400 kg, then the force needed to move the load is 80 N. The force needed will be larger, perhaps a lot larger, if conditions are not perfect (e.g. wheels not in the right position or a device that is poorly maintained);
- moving an object over soft or uneven surfaces requires higher forces. On an uneven surface, the force needed to start the load moving could increase to 10% of the load mass, although this might be offset to some extent by using larger wheels. Soft ground may be even worse;
- operators should try to push rather than pull when moving loads, provided they can see over them and control steering and stopping; and
- plan the route and ensure the worker can safely see over the load.



#### 5.7.4 Environment

- environmental factors such as temperature, lighting and air currents can increase the risk of pushing/pulling;
- hot and humid environments can lead to the early onset of fatigue;
- many CTUs are made of metal and when exposed to constant heat can become very warm inside. Packers working inside can quickly be overcome with heat exhaustion;
- strong air movements can increase pushing forces and reduce the stability of the load;
- very cold environments can also increase the risk.
- environments where there is poor or bright lighting can affect the worker's judgement;
- CTUs generally do not have windows of translucent walls, so the interior can be dark. Often illumination of the interior is poor or provided by a bright light at the door end;
- constant light change when packing (dark going in, bright coming out) can have an adverse effect on the packer if carried out repeatedly;
- floor surfaces that are clean and dry can help reduce the force needed to move a load;
- constraints on posture may cause problems for the worker, which could affect the task and injure the worker;
- constant and repetitive twisting, lifting and / or lowering as a packer places packages into a stack, perhaps from a conveyor can quickly result in back injuries; and
- confined spaces and narrow passages/doorways could provoke a tripping/trapping/abrasions injury.

## 6 Packaging information for manual handling

6.1 Consideration should be given to taking appropriate steps to provide general indications and, where it is reasonably practicable to do so, precise information on the mass of each package, and the heaviest side of any package whose centre of gravity is not positioned centrally.

6.1.1 Consignors should label a load if there is a risk of injury and it is reasonably practicable to do so.

6.1.2 Consignors need not provide this information if the effort involved in doing so would be much greater than any health and safety benefits that might result.

6.1.3 It is much better to reduce risky manual handling operations by providing lifting aids, splitting loads and telling people not to carry several items at once.

6.2 What information should be included?

6.2.1 If it is reasonably practicable to give precise information the consignor should do so.

6.2.2 Giving information that will help to prevent injury does not necessarily require consignors to quote masses to anything more than the nearest kilogram or two.

6.2.3 More detailed information would not help packers avoid risks. This also applies to indications of the heaviest side, unless the load is sufficiently out of balance to take handlers by surprise.

6.2.4 The purpose of providing information about mass is quickly and reliably to warn handlers when a load is heavy. The information should, therefore, be easy to understand and placed where it can best be seen.

## INFORMATIVE MATERIAL 8

### TRANSPORT OF PERISHABLE CARGO

#### 1 What are perishables?

1.1 A "perishable" may be described as something that is easily damaged or destroyed. In the context of this informative material, perishables are usually, but not always, foodstuffs. Without careful treatment, the time taken to deteriorate to a condition which will either reduce the value or render it unsalable (shelf life) may become unacceptably short.

1.2 Careful consideration of the factors affecting the "shelf life" of perishables should be made and transport conditions during the "storage life" of the cargo correctly applied.

1.3 Perishables include frozen produce, meats, seafood, dairy products, fruit and vegetables, horticultural products such as flowering bulbs and fresh flowers plus chemical compounds and photographic materials.

#### 2 General issues

2.1 Shippers and consignees should be aware of the maturity indices for chilled fruit, vegetable and horticultural produce. Whilst there are procedures for retarding the ripening process, it is not possible to reverse it.

2.2 There are various makes and models of refrigerated containers in use. When exporting temperature, atmospheric and time sensitive commodities, exporters should liaise accordingly with the shipping company to ensure a container fit for purpose is supplied that is capable of operating to desired and mutually agreed requirements.

2.3 Maintaining proper conditions during shipment from the packing shed to the overseas market is an important factor in minimising quality loss.

2.4 Problems could occur in the carriage of containerised perishable cargo due to the lack of adequate and accurate carriage instructions issued by shippers. It is extremely important that rational procedural precautions are routinely adopted and instructions are always given in writing to all parties in the transport chain. Shippers should ensure that all documentation shows the Set Point temperature and atmospheric conditions settings. It is recommended that the information contained in the electronic Pre-receival Advice should be made available to all parties in the transport chain.

2.5 The shipper is in the best position to know the optimum temperature and container vent settings (or Fresh Air Exchange rates) for the carriage of his product and his reefer instructions should be followed unless they are obviously wrong or raise a natural uncertainty. In that event, clarification should be sought. Carriage instructions given to a shipping company should be complete, adequate and accurate to avoid the risk of damage to the cargo.

2.6 The successful delivery of fruit, vegetable and horticultural produce from origin to destination in refrigerated containers is also dependent on the maintenance of suitable storage and packing conditions during transport.

2.7 The quality of the produce can be maintained only if each link in the chain continuously maintains the integrity of the chain.

2.8 When packing refrigerated CTUs the perishable cargo should be pre cooled to the required transport temperature (see also section 9).

### **3 Conditions which affect the commodity**

#### **3.1 General**

3.1.1 There are several interrelated factors which affect each type of perishable product during its useful life, either under refrigeration or not. These are briefly dealt with in the ensuing sections.

3.1.2 The CTU owner may contribute to these conditions through equipment purchase and operation. The consignee may be indirectly concerned, through the choice of wrapping material, for the appearance of the product at the retail outlet.

3.1.3 Consignors should ensure that commodities leave their care in prime condition and, in the case of fruit and vegetables, that harvesting was carried out at the correct maturity. Fungicidal or similar treatments are often required for safe carriage over long distances. Occasionally the type of package which the producer or consignor consider to be economically acceptable may have a significant bearing on the condition through the effect on air circulation and cooling.

#### **3.2 Temperature**

##### **3.2.1 General**

3.2.1.1 Temperature is particularly important both for long and short journeys. The object of refrigeration is to prolong the storage life of a perishable food product by lowering the temperature so that metabolic deterioration and decay caused by microorganisms or enzymes are retarded.

3.2.1.2 For a commodity whose storage life is counted in weeks, transport within one or two degrees of the optimum carrying temperature may be satisfactory when the journey time is only a few days. When storage life is counted in days it is essential to transport at the optimum temperature for the particular product. However, for maintaining the goods in their best condition all goods should be carried at their optimum temperature no matter the storage life or the transport time.

3.2.1.3 There are regulations in various countries concerning the transport of certain chilled and frozen produce which limit the maximum product temperature within the transport chain.

3.2.1.4 It should be stressed that the only temperature, which can be controlled is the "Set Point". The Set Point corresponds to air delivery temperature for chilled cargo. The term "carriage temperature" therefore, cannot be used in carriage instructions.

##### **3.2.2 Air delivery temperature**

3.2.2.1 This is the temperature at which air leaves the cooler to be delivered to the interior of the vehicle or container by ducts or through a plenum chamber. The required air delivery temperature is sometimes given in instructions from consignors, generally with the intention of avoiding chilling or freezing injury of the commodity.

3.2.2.2 Air delivery temperature is usually controlled in containers and various machinery suppliers have set their temperature control point between -3°C and -10°C.

3.2.2.3 Many designs of refrigerated road vehicles do not have a means of controlling the delivery air temperature as a single thermometer, generally placed in the return air, is used by the temperature controller. Air entering the cargo space can thus be below the freezing point of the commodity in question.

### 3.2.3 Air return temperature

3.2.3.1 This is the temperature of the air leaving the interior of the CTU before entering the cooler.

3.2.3.2 Air return temperature is generally accepted as representing the average temperature of the commodity within the carriage space.

3.2.3.3 Many road vehicles use this temperature for controlling the operation of the refrigeration plant. In general, containers with their sophisticated control equipment use return air control only for frozen cargoes below -4°C.

### 3.2.4 Space temperature

3.2.4.1 Few, if any, road vehicles monitor the temperature of the commodity, or the air space within the vehicle. In container transport, where in-transit sterilisation (cold treatment) may be required by regulations covering particular destinations, up to four sensors may be placed at locations within the commodity.

3.2.4.2 It is impossible to define a single position within a vehicle or container which is representative of the average commodity temperature. Even with comparatively well designed equipment the maximum commodity temperature is usually greater than the return air temperature.

### 3.2.5 Temperature range

3.2.5.1 The temperature range defines the limits within which all temperatures in the cargo should fall. If a carrying temperature is suggested which is likely to cause the temperature of any part of the cargo to fall outside these limits, it should be a subject of careful enquiry and possible rejection of responsibility.

3.2.5.2 In many cases the lower limit will be the product freezing point. In the case of fresh fruit and vegetables the freezing point is an absolute limit, which if passed, will almost certainly result in irreversible damage. For many tropical and sub-tropical fruit the lower storage temperature is that minimum below which chilling injury can occur and this temperature may be substantially higher than the freezing point.

3.2.5.3 The upper temperature limit is less rigidly defined except in cargoes of fruit that are being subjected to in-transit sterilisation where the upper limit should not be exceeded by any part of the cargo at any time within the stated quarantine period.

3.2.5.4 There are distinct differences between the range of air temperature as indicated by the delivery and return air thermometers, the range of air temperature within the vehicle and the range of the commodity temperature.

3.2.5.5 All three can be kept to a minimum and can be made to converge, by limiting the heat inflow from the outside of the vehicle or by increasing the refrigerated air flow or by a combination of both.

3.2.5.6 The general relationship between the various temperatures is illustrated below.

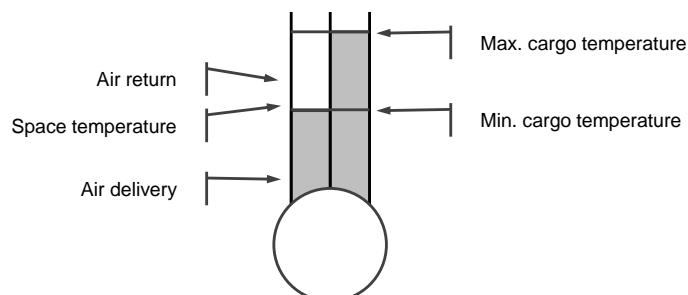

Figure 8.1 Relationship of cargo and air temperature

### 3.3 *Relative humidity*

3.3.1 The relative humidity of the air around the produce is of particular importance both in long and short term storage.

3.3.2 Dry air may cause desiccation of the product which can affect the appearance and will certainly reduce the weight at the point of sale.

3.3.3 Very damp air, with high relative humidity, will encourage the growth of moulds and bacteria on chilled carcass meat and also lead to the development of various fungal disorders on many fruits and vegetables.

3.3.4 When chilled meat is transported, there are significant changes in relative humidity when the refrigeration unit is turned off for any reason.

3.3.5 Typically the relative humidity increases from 85% to nearly 100% and prolonged periods at these levels can have a significant effect on the microbiological spoilage.

3.3.6 Generally levels between 90% and 95% are recommended for fresh vegetables and up to 98% for root crops. For fresh fruit levels vary but are generally between 85% and 95% depending on the fruit and variety.

3.3.7 Relative humidity of the air around the produce is dependent on the water activity at the surface of the product, the rate of fresh air ventilation, the relative humidity of the fresh air and the temperature of the refrigerant coil relative to the dew point of the air in the cargo space. Thus any problems which arise may be related to any of several factors.

### 3.4 *Loss of mass*

3.4.1 This is one of the least understood effects of perishable cargo. Produce loses mass by the transfer of water vapour to the surrounding air. If this air is very dry then the rate of transfer will be increased and hence the rate of mass loss will also be increased.

3.4.2 When warm unwrapped perishables are packed into a refrigerated CTU there is a loss of mass during cooling due to evaporation. In this situation the refrigeration plant may be operating at full rate. The evaporator coil will be at a much lower temperature than the dew point of the air passing over it, from which water will then condense drying the air which will cause further evaporation from the product. For example, carcass quarter beef can lose 2% of its initial mass in cooling from 20°C to 6°C. Under these circumstances the cooling loss will be more significant than the transport loss.

3.4.3 Similar effects apply to fruit and vegetables particularly when loaded above the transport temperature and cooled in transit. Loss of mass can be reduced by effective design of packaging, notably by the use of plastic films, but this can result in condensation on the inside of the film.

3.4.4 The design of refrigeration equipment, particularly the air cooler or evaporator coil, is important as is the need to ensure that the coil temperature does not fall to very low temperatures thus promoting rapid air drying.

### **3.5 Air circulation and distribution**

3.5.1 The need for adequate air circulation and particularly for even distribution is paramount. Poor air distribution can adversely affect localized product temperatures and result in a wide spread of temperature through the load. This together with the effect on localized humidity and loss of mass combine to reduce the quality, storage life and shelf life.

3.5.2 If warm perishables are packed then a good distribution of air is essential for even cooling and a satisfactory product temperature range in the vehicle or container. An adequate volume of air should be circulated to cool it quickly and to maintain the desired range of air temperature (this practice is not recommended except in special circumstances).

3.5.3 Air distribution depends on equipment, packaging design and the way the cargo is packed.

## **4 Packing**

### **4.1 General**

Packing is one of the more important factors in all types of transport and is particularly affected by the packaging of the commodity, whether it be carton, pallet, net bag or hanging meat. The stow should be stable to avoid damage during handling and in transit yet it should permit air to circulate freely through and around the commodity.

### **4.2 Frozen products**

4.2.1 Frozen products should only be accepted for transport when precooled to the correct transport temperature. It is then only necessary for air to circulate around the periphery of the load and a block stow, i.e. one that has no deliberate spacing between any of the packages or pallets, is all that is required. It is of course necessary to ensure that air can circulate under, over and to each side and end of the stow.

4.2.2 The air space between the vehicle wall and the product is often maintained by permanent spacers or battens which are built into the walls. There has been an increasing trend for side walls to be smooth and concern has been expressed about the possibility of elevated temperatures in these areas. Several trials with frozen product in smooth sided containers have failed to demonstrate a significant problem as there is invariably space for air to flow as a result of slightly loose stowage. Problems would arise where boxes fit tightly across the space.

### **4.3 Chilled product**

4.3.1 Chilled products such as fruit and vegetables are living organisms and produce heat as they respire (or breathe). The quantity of heat generated depends on the variety of fruit or vegetable and usually varies with the product temperature. To ensure that this heat is removed it is essential that a large proportion of the circulating air passes through, rather than around the stow, to give good contact with all parts of the load.



#### **4.4      *Cartons for fruit***

4.4.1      If the dimensions of the package are suitable, a block stow can be used with cartons stowed one on top of the other preferably aligned vertically. Brick stows, whilst giving good stability, do not allow free passage of air between the cartons and may give rise to local hot spots. Ventilated cartons generally give better results than enclosed cartons and are used, for example, for bananas which have high respiration rates and are accepted for carriage within a few hours of cutting to be cooled in transit.

4.4.2      Deciduous fruit such as apples and pears, when precooled to storage temperatures, can be transported satisfactorily in closed cartons of either the tray pack or cell pack types.

4.4.3      Stone fruits are susceptible to problems arising from respiratory heat and without good air circulation have been found to rise in temperature, particularly when block stowed on pallets.

4.4.4      Where fruit is not properly precooled, spacing between packages will facilitate air distribution which can be achieved by the use of dunnage where this is found to be practicable. To achieve adequate cooling rates the whole of the floor area should be covered without leaving any large gaps between adjacent cartons, preferably not greater than 10mm, so that a uniform distribution of the air flow between the cartons will occur.

4.4.5      It should be recognized that most refrigerated CTUs are designed to maintain perishables at the transport temperature, their use for cooling should only take place after careful consideration of all the factors involved. It is a recognized practice to cool bananas in containers but in-transit cooling is an accepted part of the banana delivery chain from cutting to point of sale.

4.4.6      For most products, a CTU is unlikely to cool cargo from ambient levels of 20 to 25°C down to carrying temperatures close to 0°C in much less than 5 to 7 days.

4.4.7      Cooling rates are dictated by the need to avoid over cooling the cargo and by the rate of heat transfer from the cargo in addition to any limitations in the refrigeration capacity of the equipment.

#### **4.5      *Vegetables***

4.5.1      The heat of respiration of many vegetables is higher than for fruit and for journeys under refrigeration these commodities should be precooled to the carriage / set point temperature.

4.5.2      Certain leafy vegetables, salad crops etc. are precooled by vacuum coolers or hydrocoolers, wrapped in polyethylene bags and then placed in cardboard cartons. At storage temperatures these commodities can be carried safely with a block stow, preferably with the cartons in vertical alignment.

4.5.3      For commodities stowed in net bags, for example onions, potatoes, carrots and melons, whether carried under refrigeration or forced ventilation, it is advisable to break the stow with dunnage when the size of the commodity is particularly small. For example, onions for pickling present a much higher resistance to air flow than those used for other culinary purposes.

4.5.4 Carrots are a further example where product density under some circumstances can impede air flow. With commodities in nets or sacks, the bottom tier should be vertical with alternate layers stowed horizontally.

4.5.5 When commodities are carried without refrigeration it is essential to break the stow by using pallets turned on end, particularly in periods of hot weather. All fruit and vegetables produce heat which will, unless vented to the atmosphere, raise the product temperature as will the ventilation fans.

**4.6 Chilled meat**

4.6.1 Hanging meat carcasses should be arranged to allow adequate air circulation to all parts of the load. Care should be taken with stowage to minimize possible product damage. It is prudent to load meat to meat and bone to bone always placing bone against the side walls of the vehicle or container.

4.6.2 Effect of stowage on air and temperature distributions

4.6.3 In order to ensure good temperature distribution it is essential to have air uniformly distributed throughout the load. This can be brought about by having the cargo uniformly stowed over the floor of the vehicle or container. Poor stowage results in poor air distribution which gives rise to slow cooling when produce is not fully precooled. A large spread of temperature throughout the load may also result.

4.6.4 The major principles to adopt are:

4.6.4.1 Stow as uniformly as the product will allow. Do not leave large gaps between pallets or at the ends of the vehicle. Avoid alternating areas of very tight and loose stowage which may lead to local hot spots building up over a period of time.

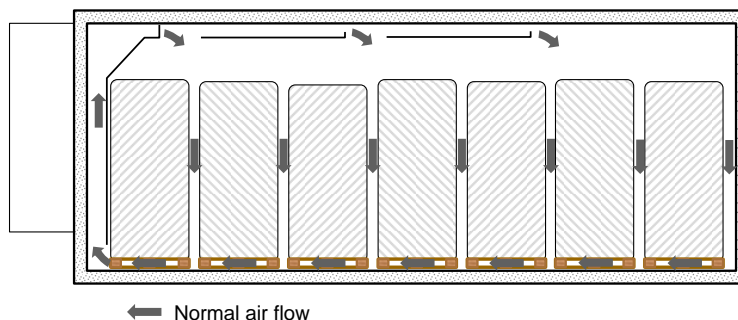

**Figure 8.2 Ideal packing pattern for pallets**

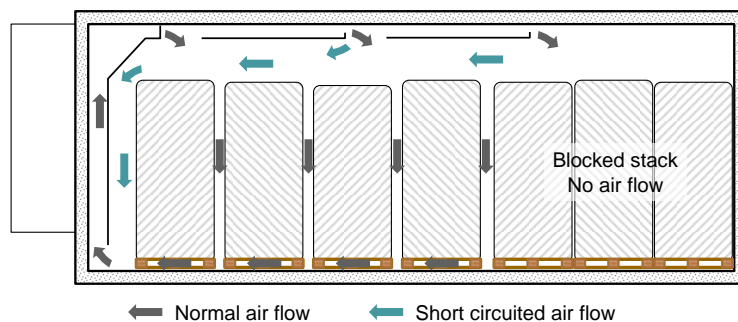

**Figure 8.3 Irregular packing pattern**

4.6.4.2 With break bulk stows, empty cartons or timber should be used to fill the gap between the end of the load and the doors. If the cargo is on pallets the floor should be covered wherever there are blank spaces.

4.6.4.3 Always leave an air gap between the top of the load and the roof of the vehicle. This is usually 10 cm on long vehicles and 7.5 cm on 20 ft. containers. Good air circulation is not possible if there is no gap. Some vehicles have canvas ducts to distribute air – these should not be distorted with too high a load.

4.6.5 With loose cartons it is possible to have a load uniformly spaced over the floor area when the dimensions of the cartons are compatible with the internal dimensions of the container or vehicle.

4.6.6 Vertical separations (dunnage) are useful with cartons, particularly with warm or respiring cargoes, but it is better to use ventilated cartons to allow a through flow of air. Some cargoes have a higher resistance to air flow than others and this will have an effect on both the volume of air circulated by the fan and as a consequence the temperature distribution.

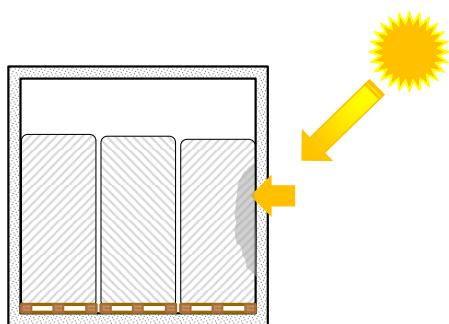

Figure 8.4 block stacked to side wall

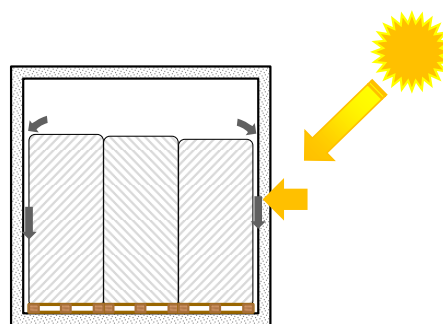

Figure 8.5 Blocked stacked with air passage

4.6.7 Direct sunlight on the exterior of a refrigerated CTU may, over time, cause parts of the side wall to heat up locally and without the cooling effect of moving air over the inner face, penetrate into the cargo. This is caused by the cargo being stacked directly against the side wall of the CTU.

## 5 Packaging

### 5.1 Temperature considerations

Temperature is considered to be measured and stated in Degrees Celsius [°C], while Fresh Air Exchange rates should be stated in cubic metres per hour (CMH) for the purpose of this informative material. Any variance from this practice should be highlighted to all parties in the chain to ensure that there is no misunderstanding.

### 5.2 Carton design

5.2.1 Many perishable commodities are transported in some form of carton. The quality of the carton tends to depend on the value of the product and occasionally on the length of the journey. Practically all fibreboard has a poor wet strength so there is a limit to the height to which cartons of fruit can be stowed without the load gradually compressing. A good quality tray pack carton can be stowed about nine high for a period of six weeks without collapsing. The effect of carton collapse, apart from possible bruising of the contents, is to reduce the air gaps, making dunnage battens ineffective and leading to an increase in the pressure drop through the load with a reduction in the volume of air being circulated.

5.2.2 Package designs facilitating good cooling rates and the maintenance of small temperature gradients in the load usually have perforations to allow air to move freely through the cartons.

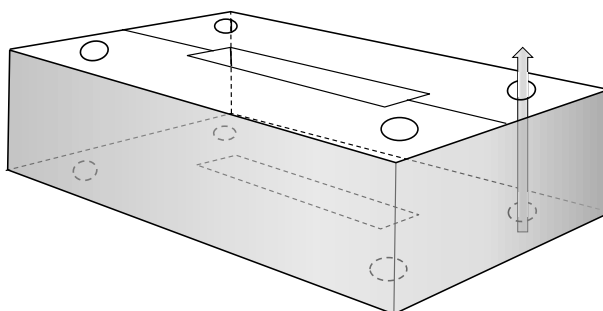

Figure 8.6 Ventilated carton

### 5.3 Packaging Design and Heat Transfer

5.3.1 Package design plays an important part in transferring heat from the product to the cooling air and the two examples given below typify two extremes.

5.3.2 Maximum cooling (and heating) rates are achieved with unwrapped fruit in ventilated cartons, e.g. citrus fruit (these are sometimes individually tissue wrapped). At the other extreme, wrapped pears in telescopic cartons with polyethylene liners have a very slow rate of cooling.

5.3.3 The rate of air circulation within the CTU also has an effect on the heat transfer from the package. It is possible to obtain improvements in cooling of cartons up to a maximum rate of air circulation of 90 times the empty volume of the storage space per hour. Above this level returns are small as the increase in heat transfer coefficient between the surface and the air is offset by the insulating effect of the carton material.

5.3.4 Cooling rates decrease with lower air circulation rates and at very low rates, probably less than around 10 changes per hour, the air volume flowing past the individual packages may be insufficient to remove respiratory heat with a resulting rise in product temperature.

5.3.5 Some figures for cooling at different rates of air circulation are as follows:

Average $\frac{1}{2}$ cooling times	60 air changes	90 air changes
Non ventilated cartons	69.1 hours	54.6 hours
Ventilated cartons	26.6 hours	24.5 hours

5.3.6 However, when stacking ventilated cartons, it is important to ensure that ventilation holes line up. If using an interlocked stack, the ventilation holes may not align when the carton is designed for vertical stacking. Where the air passage through the cartons is blocked there is a risk of the contents deteriorating.

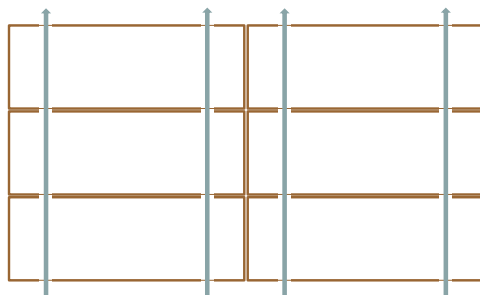

Figure 8.7 Free passage of air

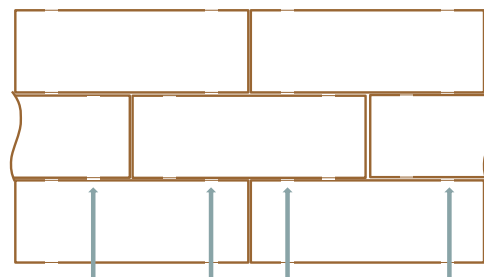

Figure 8.8 Blocked air passage

5.3.7 Generally, fruit and vegetables which have a high metabolic heat production rate should always be carried in packages which have a high rate of heat transfer to the surrounding air.

## 6 Ventilation

6.1 Many cargoes, particularly fruit and vegetables carried in the chilled condition, require some form of fresh air ventilation. This can be indicated by the measurement of the concentration of carbon dioxide in the cargo air. Outside marine operations little if anything is done to monitor this gas.

6.2 With CTUs, which are independent of a central monitoring system, it is usual to ventilate continuously even though the amount of ventilation may exceed requirements. Commodities that are known to be sensitive to the effects of ethylene are generally ventilated at a high rate.

6.3 Several manufacturers of transport refrigeration equipment are now fitting adjustable venting ports which allow the operator to set the vent to allow fresh air exchanges in accordance with the requirements of the commodity being carried and with reference to the ambient conditions in the operational area. For a typical 40 ft CTU air exchange rates in the range 30-250 m<sup>3</sup>/hr equivalent would be equivalent to 0.5-4.5 changes/hr.\*



Figure 8.9 Ventilation port

## 7 Atmospheres – effects on quality and storage

7.1 The gases which affect the storage life of fruit and vegetables are oxygen, carbon dioxide, and ethylene. Carbon dioxide is a product of the normal metabolism where oxygen is absorbed from the atmosphere and carbon dioxide is given back to the atmosphere.

\* Based on empty CTU.

7.2 Uncontrolled levels of carbon dioxide can be harmful to fruit and vegetables during transport and storage. It can normally be replaced by ventilating the storage space with fresh air. Approximately one air change of the empty space (CTU) per hour is sufficient to maintain carbon dioxide at tolerable levels for most fruit. Higher rates of ventilation may be specified for other reasons e.g. ethylene removal.

7.3 Low levels of oxygen, usually brought about by the use of liquid nitrogen as the refrigerant, may have an undesirable effect on product quality. Consequently liquid nitrogen should only be used with caution, as a total loss refrigerant for chilled produce.

7.4 All fruit and vegetables produce ethylene, at varying rates depending on commodity. Ethylene stimulates ripening and accelerates senescence to a varying degree in all fruit and vegetables but the effects are sufficiently severe to cause problems in only a proportion of commodities. It is also a by-product from internal combustion engines and may be present in the atmosphere where these are operated in enclosed spaces. For example, diesel or LPG powered fork lift trucks should never be used for packing CTUs with fruit, cut flowers or shrubs.

7.5 As with carbon dioxide the effects of ethylene can be reduced by ventilation with fresh air or absorbing material. Concentrations of ethylene gas at or below one part per million can cause problems and measurement of such small amounts can prove difficult. The use of sophisticated and expensive equipment such as a gas chromatograph can only be carried out for test purposes rather than regular monitoring. Consignors of commodities known to be sensitive to ethylene should ensure that the packer is aware and that ventilation of the CTU is between two and three air changes, of the empty volume, per hour. For less sensitive commodities about one air change per hour is usually sufficient.

7.6 Various methods of absorbing ethylene from the atmosphere are available. These include:

- potassium permanganate, sometimes used as a coating or with silica gel (absorbent pads);
- activated charcoal filters;
- brominated charcoal filters;
- catalytic filters;
- combination with ozone. Ozone generators are available but are probably better suited to use in large storage spaces. However, some CTU refrigeration units do now have this facility.

7.7 In the transport field fresh air provides the most convenient and reliable method of maintaining low ethylene levels.

## **8 Controlled atmosphere (CA) and modified atmosphere (MA)**

8.1 The principles of atmosphere control have been known for many years and have been applied successfully to long term storage, in cold stores, of apples and pears. The techniques are now being applied to transport and packaging, not as a replacement, but as an enhancement of good temperature control.

8.2 CA or MA does not eliminate the need for good temperature control. CA or MA with reduced oxygen content and increased carbon dioxide content, with appropriate temperature control, can retard deterioration and maintain the quality or increase the storage life of various fruit and vegetables.

8.3 The beneficial effects of CA and MA include:

- retarding fruit ripening;
- retarding leaf senescence (ageing);
- control of fungal and bacterial spoilage and insects;
- control of physiological disorders e.g. spotting in leaf crops and bitter pit in apples;
- reduction of ethylene production;
- reduction of sensitivity to ethylene;

8.4 MA in CTUs

A packed CTU is purged with a tailored gaseous nitrogen mix immediately after packing and just before final sealing.

8.5 CA in CTUs

CA CTUs for marine applications control the oxygen level either using liquid nitrogen or by use of a continuous nitrogen generator in which air is pumped through a membrane to produce a gas mixture of 98% nitrogen and 2% oxygen. For some applications the commodity produces carbon dioxide at a sufficient rate to maintain the required level which can then be limited by scrubbing. Higher levels for the carriage of meat require a supply from either a cylinder or from blocks of dry ice.

8.6 CTUs where gases are introduced for conditioning purposes may be subject to additional provisions relevant to the transport of dangerous goods. However, gases which are used in refrigeration equipment are not regulated by the aforementioned provisions.

## **9 Precooling**

9.1 Why is it necessary?

9.1.1 In the first place to maintain the quality of products. Prompt cooling of fruit and vegetables, immediately after harvesting, will lengthen the potential storage life.

9.1.2 Secondly and more importantly, CTUs are not designed to cool products as they are designed only to maintain the product at the transport temperature. CTUs, in general, do not have sufficient capacity to cool the product quickly to maintain its condition, whereas cold stores, cooling tunnels and pressure cooling systems are designed for this task.

9.1.3 Fruit and vegetables are living organisms, consuming oxygen from the atmosphere and giving off carbon dioxide and water vapour and heat. This heat of respiration can add a significant load to the cooling system. The higher the temperature of the product, the greater the heat of respiration.



9.1.4 The level of heat of respiration can have a very significant effect on the time taken to cool the product to the transport temperature.

9.1.5 Tight stows of cartons on pallets are prone to slow cooling when warm product is packed (see figure 8.10).

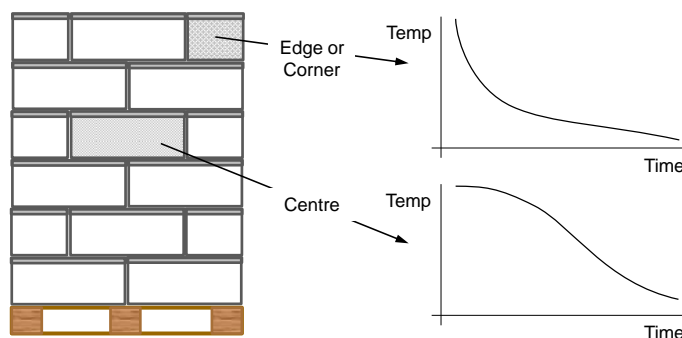

Figure 8.10 – Cooling on a pallet

## 9.2 Vacuum damage

9.2.1 The consequence of cooling air is that the volume decreases in proportion to its temperature. Therefore, a CTU opened and left with the doors open so that the inside temperature is the same as ambient can cause problems when pre-cooling. If the ambient temperature is high and the internal temperature is permitted to rise towards that temperature, then the doors are closed and the machinery activated with a low set point the volume of air inside will substantially decrease.

9.2.2 Refrigerated CTUs are designed with low air leakage so that the cold air cannot escape and air drawn in by the ventilation port can be properly controlled, the consequence of which is that when the doors and ventilation port are closed there can be very little air movement between the exterior and the interior. In such circumstances cooling the internal air will result in the internal pressure of the cargo space dropping. This can result in a vacuum that prevents the doors from being opened and in severe cases can result in the CTU imploding.

9.2.3 It is essential therefore that the ventilation port is opened when pre-cooling and set once the interior has been cooled to the required temperature. Thereafter packers should endeavour to keep the internal temperature as low as possible.

## 10 Equipment

### 10.1 Types of refrigerated CTUs

10.1.1 Descriptions of refrigerated CTUs can be found in informative material 3, section 1.3.

10.1.2 For land transport, the refrigerated semi-trailer is the most popular form of vehicle although for local deliveries and short haul operations rigid vehicles are also used. The external dimensions of European semi-trailers can be as large as 13.6m (long) x 2.6m (wide) x 2.7m (high) although in other countries they may be larger.

10.1.3 For marine use the most common type of container is the 40ft high cube integral refrigerated container, which has an inbuilt refrigeration unit similar to the refrigerated semi-trailer. The smaller 20 foot version is available but only constitutes 7% of the world's refrigerated fleet.

10.1.4 As with all types of transport equipment, there are mass restrictions which may limit the volume of the more dense product which can be carried. This is more often found with frozen cargo.

10.2 How does a mechanically refrigerated CTU work?

The refrigeration unit fans cause temperature controlled air to circulate around the inside of the vehicle floor, walls, doors and roof to remove heat which is conducted from the outside. Some of the air should also flow through and between the cargo, particularly when carrying fruit and vegetables, where heat of respiration may be a significant proportion of the heat load. The various components of the heat load of a refrigerated CTU are given in figure 8.11.

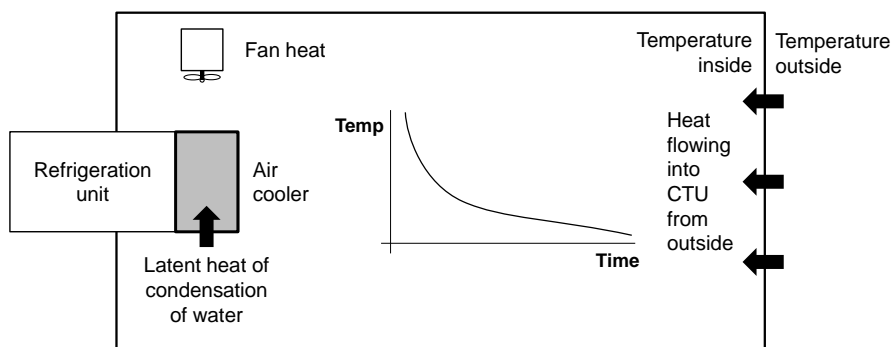

Figure 8.11 Heat load of a refrigerated CTU

10.3 Top air delivery systems

Top air delivery is used predominately on refrigerated semi-trailers. Air is ducted from the refrigeration unit to the end of the vehicle or passes through and around the load returning via the floor or space under pallets. For chilled cargoes horizontal channels are required between rows of cartons to allow good return airflow through the load, whereas block stows are recommended for hard frozen cargoes that have been fully precooled. Some trailers are fitted with a false bulkhead wall with metal grill or holes in the lower part for return air passage. The cargo may be stacked against this bulkhead. Where return air bulkheads are not used it is a common practice to set wooden pallets on end between the front wall and the front of the load thus creating a return air channel.

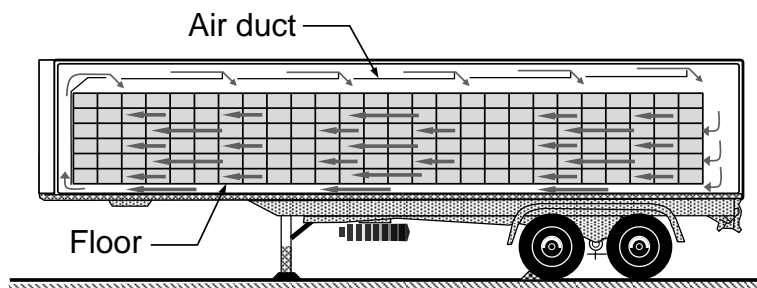

Figure 8.12 Top air delivery reefer

## 10.4 Bottom air delivery systems

10.4.1 Bottom air delivery is generally used in marine containers. Air is blown through the evaporator into a plenum chamber, which distributes the flow evenly across the width of the floor. Depending on the stowage pattern the air passes along the floor to be circulated up through and around the stow returning via the roof space. With respiring cargoes, the most even temperature distribution is attained if the load completely covers the floor and the packaging or dunnage has been designed to allow a high proportion of the air to circulate through the load as well as around it. Where precooled frozen cargoes are concerned, a block stow is acceptable as only the heat from the container body has to be removed.

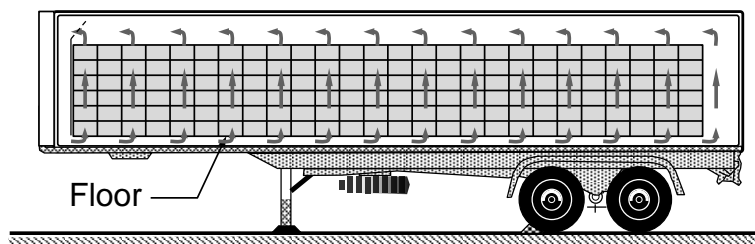

Figure 8.13 Bottom air delivery reefer

10.4.2 The heat, gained by the air as it circulates around the CTU, is removed in the evaporator section. The air also picks up moisture from the produce and also from air from the refreshing vents when in use in ambient conditions with high humidity. This is deposited on the evaporator as water or ice, depending on the coil temperature. When ice is formed the air flow through the evaporator becomes restricted and defrosting becomes necessary when the flow falls to 75% of the frost free rate.

10.4.3 The rate of air circulation within the CTU is equivalent to 60 to 90 air changes per hour of the empty volume. Some container operators are increasing the rate to 120 for chilled cargoes. Under maximum summer temperatures of 30°C and 0°C set point, for example, the range of air temperatures would be about 1.5°C at full speed and 2.5°C at half speed on 40ft semi-trailers. Tighter tolerances are achieved on marine containers where a 1°C spread would not generally be exceeded.

## 10.5 Floor designs

10.5.1 There are generally four alternatives available, a T-bar section floor, a castellated section floor, a perforated floor or the pallet.

10.5.2 T-bar section floors – cause minimum obstruction to air flow, but can be damaged by fork lift trucks and are difficult to keep clean.

10.5.3 Castellated floors – some obstruction to flow of air and increased pressure drop, very strong and easy to clean.

10.5.4 Perforated floors – used traditionally in refrigerated ships and have been modified for use in containers. Give less obstruction to air flow and better distribution in the container than castellated. Difficult to clean unless removable.

10.5.5 Pallets – may be used with flat floors which are easily cleaned.

10.5.6 Road vehicles generally use flat checker plate or glass reinforced plastic (GRP) floors and marine containers are fitted with T-bar section floors.

## 11 Capacity of the refrigeration unit

11.1 Most vehicle refrigeration units are fitted with compressors which will maintain internal temperatures of  $-20^{\circ}\text{C}$  in ambient temperatures of up to  $40^{\circ}\text{C}$ . When running in the chill mode at maximum speed the cooling capacity is approximately double that at low temperature. Reducing compressor speed to 50% will reduce the cooling capacity by 35% to 40% but the net capacity may still exceed the refrigeration load.

11.1.1 All marine containers are capable of maintaining at least  $-25^{\circ}\text{C}$  internal temperature in ambient temperatures of up to  $40^{\circ}\text{C}$ . Requirements for trade in desert regions have led to the development of units that will hold  $-25^{\circ}\text{C}$  in  $50^{\circ}\text{C}$  ambient. Cooling capacities on marine containers and other units are reduced by various methods to give precise temperature control and heating is available for higher temperature products during carriage in cold ambient conditions.

### 11.2 Temperature control

11.2.1 This is a function of refrigeration plant capacity and the load demand on the refrigeration unit. Systems vary from simple ON/OFF which is used on many road vehicles at all temperatures and for frozen control on marine containers, to sophisticated capacity regulation using electronic control of chill temperatures on marine containers.

#### 11.2.2 Road vehicle control

11.2.2.1 The typical road vehicle temperature control for a unit on diesel drive would be:

- Return Air  $>$  (Set Point +  $2^{\circ}\text{C}$ ) High Speed Cool
- Return Air  $<$  (Set Point +  $1^{\circ}\text{C}$ ) Low Speed Cool
- Return Air  $>$  (Set Point –  $1^{\circ}\text{C}$ ) Low Speed Heat
- Return Air  $<$  (Set Point –  $2^{\circ}\text{C}$ ) High Speed Heat

In practice these tolerances may vary or be subject to proportional-integral-derivative (PID) control.

11.2.2.2 On many diesel driven units, the compressor, condenser fan and evaporator fan are connected to a common drive train, consequently the evaporator fan speed is reduced when the compressor goes on to low speed and the reduced air flow allows the temperature gradient across the load to increase.

11.2.2.3 Typical air temperature variations under on/off control and two speed control are as follows:



Figure 8.14 Variations of air temperature under thermostatic control

11.2.2.4 Control cycles of this type are known to cause chilling and freezing damage to sensitive fruits and vegetables. The main problem is the practice of controlling the return air temperature combined with relatively wide control swings.

11.2.2.5 Where parts of a load are several degrees above set point the thermostat may cause the compressor to run on full cool and thus freeze other parts of the load near to the air delivery location. This problem can be eliminated by controlling the delivery air temperature.

11.2.2.6 The variation between delivery and return air temperatures will tend to increase when the fan runs at low speed.

### 11.2.3 Continuous temperature control

11.2.3.1 The marine container industry has made significant improvements in temperature control which are of particular importance for the carriage of chilled product over long distances involving total time spans of 6 to 8 weeks.

11.2.3.2 Temperatures are controlled to within  $-0.25^{\circ}\text{C}$  of set point whilst the differential between supply and return air temperatures is minimized by high continuous rates of air circulation.

11.2.3.3 Precise control has been achieved by running the compressor continuously and reducing the cooling capacity to exactly balance the heat load at the required carriage temperature. The cooling capacity can be reduced in a variety of ways including the following:

11.2.3.3.1 Discharge gas bypass – hot gas from the compressor discharge is redirected to the evaporator. The flow rate is controlled either by a diverting valve or a combination of solenoid valves. This system has the advantage of precise temperature control over a very wide range of carriage temperatures, regardless of the ambient temperature, with stepless change between heating and cooling. However, the system is not energy efficient and uses more power to hold a load at say  $+5^{\circ}\text{C}$  in an ambient of  $+5^{\circ}\text{C}$  than to hold the same load at  $-20^{\circ}\text{C}$  using on/off control.

11.2.3.3.2 Reduction of Refrigerant Flow – the volume of gas pumped by the compressor may be reduced by either unloading compressor cylinders (by lifting valves), by increasing the cylinder head space volume or by throttling the flow with a valve placed in the suction line. These systems reduce power draw and work well in fairly high ambient temperatures but may give too much cooling power in low ambient temperatures leading to compressor cycling.

11.2.3.4 CTU temperature can be controlled using sophisticated energy saving software. With this software the compressor is not running all the time and allows the temperature of the delivered air to be lower than the set point temperature (during short periods of time). During the compressor stop periods the air circulation fans are running at low/half speed.

## **12 Factors affecting the relative humidity of air in the refrigerated space**

12.1 The level of humidity in the air circulating in a temperature controlled CTU largely depends on the following:

- surface area of the cooler;
- minimum temperature of the cooler;
- rate of moisture transfer between the air and the commodity;
- fresh air ventilation rate; and
- relative humidity of the fresh air.

12.2 Container refrigeration units that offer some degree of dehumidification control as an option are now available. The relative humidity may be controlled in the range 50% to 95%, with the refrigeration unit operating in the chill temperature range.

12.3 The circulation of dry air causes water loss from the product with consequent loss of mass and reduction in quality. Modern packaging, particularly films, has reduced the rate of moisture transfer from the commodity to the circulating air. Vacuum packaging is used for the transport of fresh and chilled meats.

12.4 Films are increasingly being used for most fruits and vegetables, often with perforations or of permeable quality to limit moisture build up and avoid condensation within the package.

12.5 Some films are specifically designed to maintain a specific atmosphere mix within the package. The technique has been applied commercially and is dealt with in the section on controlled and modified atmospheres.

## **13 Ventilated transport**

13.1 Ventilated CTUs were developed for the carriage of respiring cargoes that do not require refrigeration and goods that may suffer condensation damage when carried in dry freight units. Ventilation removes the products of respiration and allows the product and container interior temperatures to closely follow the ambient temperature thus minimizing condensation which will occur where the product is several degrees colder than the ambient air.

13.2 Passive ventilated CTUs rely on thermal convection within the units achieved by the natural convection of the atmosphere within the container by non-mechanical vents at both the upper and lower parts of their cargo space.

13.3 A mechanically ventilated CTU is fitted with an exhaust fan mounted either in a door or on the front bulkhead. Fresh air exchange rates of between 30 to 40 volumes per hour are attained.

13.4 Passive ventilated CTUs are used for the carriage of coffee and cocoa beans, chemicals and canned product where even temperatures are necessary to limit condensation. Respiring products might be carried in mechanically ventilated CTUs.

## **14 Commodities**

### **14.1 Chilled products**

#### 14.1.1 Compatibility of cargoes in store

14.1.1.1 The mixing of several commodities in a single load, a common cold store practice, often appears to be economically advantageous where a common transport temperature is to be used.

14.1.1.2 To a long distance shipper a mixed load may mean two or more fruits or vegetables, to a meat shipper mixed carcasses and boxes of cuts or cryovac packs and to a grocer or ship's chandler a mixture of meats, dairy products, fruit, vegetables and non-food products.

14.1.1.3 It is essential not to mix any commodity in a mixed load that will impair the quality of any other product within the load. With this aim in view the following factors must be studied to discern the compatibility of products:

- carriage temperature;
- transit time;
- packaging and stowage patterns. -ethylene production rate. -sensitivity to ethylene;
- emission of objectionable odours; and
- sensitivity to odours of other product, e.g. odours given off by apples, citrus fruits, onions, pineapples and fish are absorbed by dairy products, eggs, meats and nuts;

14.1.1.4 Film packaging of products can reduce the risk of taint but too much reliance should not be placed on the method.

14.1.1.5 The problems of ethylene have been mentioned in the section on atmospheres and solutions suggested. There are obvious combinations where it is inadvisable to mix cargoes: as a general rule, bananas, avocado pears and kiwi fruit are among those fruit which should not be stored with other fruit producing ethylene.

#### 14.1.2 Fruit

14.1.2.1 Transport temperatures for fruit fall into two groups. Fruit which are essentially tolerant of low temperatures are carried at temperatures in the range -0.5 to 0°C. The aim is to carry at or as near to the freezing point of the particular fruit as possible, taking into account control temperature variations to avoid freezing any of the cargo.



14.1.2.2 More sensitive fruit are carried at higher temperatures which are a compromise between the harmful effects of low temperature, which may result in chilling damage and the benefit from low temperatures of slow ripening and retarded development of rots. Chilling damage is the physiological damage which results from exposure of fruit and vegetables to temperatures below a critical level for each variety and causes most problems with fruit and vegetables from tropical and sub-tropical areas.

#### 14.1.3 Vegetables

14.1.3.1 Most temperate vegetables are tolerant of low temperatures and are carried close to 0°C, but as most tend to have a higher freezing point than fruit the delivery air temperature should not go below 0°C.

14.1.3.2 A higher range of temperatures are specified for certain vegetables which would otherwise suffer from chilling damage (see section on fruit). These include aubergines, cucumbers, marrows and most tropical vegetables.

14.1.3.3 Transport temperatures are given for some vegetables, which may be carried using fresh air ventilation without refrigeration. The method used would depend on the distances involved, ambient conditions and required storage / shelf life. Two good examples are onions and potatoes.

#### 14.1.4 Meat and dairy products

14.1.4.1 Chilled foods must be carried at temperatures between about -1.5°C and +5°C. For some products an upper maximum temperature of not more than +2°C may be specified, e.g. for chilled beef an upper limit of 0°C is recommended.

14.1.4.2 Difficulties may arise when transporting chilled meat with a specified return air temperature of between -1 and 0°C in high ambient temperatures. To maintain this level the delivery air temperature may have to fall to below the temperature at which the meat starts to freeze. For short journeys the problem should not arise as carriage temperatures of +1°C are usual.

14.1.4.3 High levels of carbon dioxide may be used for the carriage of chilled meat when the transport time is about 28 days and some figures are given below:

- Beef            10%-20% CO<sub>2</sub>    RH 90% +/-5%
- Horse meat   20% CO<sub>2</sub>            RH 90% +/-5%
- Lamb            25%-30% CO<sub>2</sub>    RH 90% +/-5%

14.1.4.4 Most beef and lamb for transport over long distances is either vacuum packaged or modified atmosphere packaging is employed. A gas mixture of 50/50 carbon dioxide and nitrogen is sometimes used, although as few films are totally impermeable the mixture is likely to change after sealing.

14.1.4.5 Vacuum packaging, which is difficult to apply to whole carcasses, is generally used for individual cuts of meat. Similar packaging containing a high carbon dioxide content rather than a vacuum is sometimes used for lamb carcasses.

## **14.2 Frozen product**

14.2.1 There are several important levels of temperature in the carriage of frozen product:

14.2.1.1 Final thaw temperature around  $-1.5^{\circ}\text{C}$  which should never be encountered during transport and storage.

14.2.1.2 Softening temperature at about  $-4.5^{\circ}\text{C}$ . Surface temperatures may occasionally reach this whilst loading carcass meat. Surfaces of outer packages or carcasses in CTUs moving without refrigeration may also reach this figure.

14.2.1.3 The lower limit for mould development is  $-8.5^{\circ}\text{C}$ . Considerable time is needed for mould to grow at these temperatures.

14.2.1.4 Additional constraints, such as temperature, may be contained in legislation of the exporting, transiting or importing countries.

14.2.2 Frozen foods continue to deteriorate, very slowly, and the lower the temperature the lower the rate of deterioration and consequent increase in storage / shelf life. Deterioration appears as a loss of quality rather than any dramatic change and is the result of chemical activity such as oxidation and physical changes resulting from evaporation and the growth of ice crystals. The rate of change is also influenced by the exposed surface area of the cargo in relation to its mass and by the presence and nature of any packaging which can limit loss of mass. For the small unit such as frozen fish, fruit and vegetables, packaging is essential.

### 14.2.3 Dried Products

Milk powder and similar products, having been dried during manufacture, tend to absorb moisture / water and taint odours. These are best transported in sealed insulated CTUs and should be kept dry.

### 14.2.4 Coffee and cocoa beans

See section 13 (Ventilated transport).

### 14.2.5 Chemicals

Many chemicals, films, industrial and biological non-food products are shipped in refrigerated or ventilated CTUs. Specific instructions, including dangerous goods regulations, as regards handling, packaging, packing and temperature for each product should be strictly observed.

## **15 Condensation**

15.1 Condensation damage is a collective term for damage to cargo in a CTU from internal humidity especially in freight containers on long voyages. This damage may materialize in form of corrosion, mildew, rot, fermentation, breakdown of cardboard packaging, leakage, staining, chemical reaction including self-heating, gassing and auto-ignition. The source of this humidity is generally the cargo itself and to some extent timber bracings, pallets, porous packaging and moisture introduced by packing the CTU during rain or snow or packing in an atmospheric condition of high humidity and high temperature. It is, therefore, of utmost importance to control the moisture content of cargo to be packed and of any dunnage used, taking into consideration the foreseeable climatic impacts of the intended transport.

15.2 There may be instances where the ingress of humid air could result in internal condensation.

15.3 The nature of perishable cargoes makes them particularly susceptible to the risk of condensation. The CTU operator should be consulted regarding feasible measures to eliminate or reduce the effect of condensation.

15.4 Many condensation problems can be avoided by ensuring packaging materials are dry at loading. Film wraps can also be of benefit.

15.5 For many products the use of ventilated CTUs has proved to be a solution to condensation problems (see section 13 (Ventilated transport)).

## **16 Miscellaneous**

### **16.1 Taint**

16.1.1 Care should be taken to avoid mixing incompatible cargoes and with packaging to protect the product from odour problems.

16.1.2 Some sources of taint are:

- materials, generally sulphur compounds or of petrochemical origin, used in the manufacture of plastics, paint and sealants;
- previous cargoes which have persistent odours, e.g. citrus fruit, potatoes, various chemicals; particular care should be taken when transporting chemicals in CTUs that are used for foodstuffs;
- odours absorbed by the insulation of the CTU;

16.1.3 Taint can be removed by:

- CTU cleansing to remove odours;
- washing with detergent, rinsing with clean water, then ventilating;
- with particularly severe or persistent odours steam cleaning may be necessary, again followed by ventilation;
- some odours can be eliminated by alternate heating and ventilation.

### **16.2 Hygiene**

16.2.1 Washing, as outlined above, should be carried out prior to carrying food. Fumigation may be necessary before loading such cargoes as chilled meat. A number of proprietary sprays are available for this purpose.

16.2.2 The use of fumigants, such as methyl bromide may be restricted by national or regional legislation.

## **17 Points to consider when packing perishable products in CTUs**

### **17.1 Before packing**

17.1.1 Ensure that the refrigeration unit is set correctly for the load, functioning properly and controlling the temperature at the required level.

17.1.2 A pre-trip service inspection procedure is strongly recommended for all transport refrigeration equipment.

17.1.3 The CTU should be clean, dry and free from odour particularly before packing products that are susceptible to taint.

### **17.2 Packing**

17.2.1 Precooling of CTUs should not be undertaken unless the CTU is tightly sealed against a temperature controlled warehouse. When this is possible the internal temperature of the CTU should be equalized with that of the warehouse before packing.

17.2.2 Where it is not possible to connect the CTU to the warehouse, the CTU should not be pre-cooled or the refrigeration unit run during packing. Only pre-cooled cargo should be packed. If packing is interrupted, the doors should be closed and the refrigeration unit run.

17.2.3 Check the temperature of the product with a thermometer of an accuracy complying with any relevant standards. Take several product temperatures at random and write them down on the loading sheet.

17.2.4 Take note of any defects: broken cartons or cases or other mechanical damage to the product. Any peculiar odours or moulds on product or packages should be noted.

17.2.5 Stow the commodity uniformly in accordance with the shippers instructions remembering that air should flow between the packages when respiring products are carried. A space of not less than 10 cm (4 in) between the top of the load and the roof should always be left. With top air delivery using canvas ducts, avoid distorting the ducts. Do not stow cartons tight up against the side walls. If they do not fit across the width, stagger from one side to another, e.g. row 1 to left hand side and row 2 to right hand side.

17.2.6 During the usual practise of loading pallets unavoidable voids may remain. This may be useful for ventilation. Large voids should be avoided.

17.2.7 Whenever possible, the cargo should be evenly distributed across the entire floor of the CTU. When this is not possible, additional cargo securing measures should be applied to prevent movement during transport.

17.2.8 When bottom air delivery is used and there are only sufficient goods to partially cover the floor, the exposed floor should be covered with flattened cartons or similar so that air is forced through the load instead of bypassing it.

17.2.9 When carrying a mixed load of fruit or vegetables, the higher of the temperatures recommended for the transport of each of the products should be chosen.

17.2.10 Cargoes should not be permitted to cool down in transit without specific clearance from the consignor and consignee.

**17.3 In transit**

17.3.1 Run the refrigeration unit continuously unless restrictions apply as on a ferry or in a noise abatement area. Where switching off is unavoidable try to park in the shade.

17.3.2 Check the thermostat setting at the start and after any lengthy interruptions in the journey.

17.3.3 Keep an eye on the indicated temperature, alarm lamps and defrost operation.

**17.4 Unpacking**

17.4.1 Run the unit until the doors are about to be opened.

17.4.2 If there is any damaged cargo, make sure that the position of the goods is noted as this may help identify the cause of the damage.

17.4.3 Check temperatures of packages from various sections of the load.

## INFORMATIVE MATERIAL 9

### CTU SEALS

#### 1 Introduction

1.1 Many CTU types all have facilities for sealing them and packers and shippers may elect to seal them to protect the cargo against theft. That decision will depend on the mode of transport, the route that it follows and the cargo carried. However, CTUs in international transport should be sealed by the shipper upon completion of the packing. Countries may require that such seals should meet the standard of ISO 17712.

1.2 In this informative material the responsibilities of parties within supply chain<sup>\*</sup>, the types of seal available and the methods of fixing and removal of the seals are discussed.

#### 2 Responsibilities along the chain of custody

##### 2.1 *Cross-cutting responsibilities*

2.1.1 There are responsibilities and principles that apply throughout the life cycle of a shipment of goods. The emphasis is on the relationships among parties upon changes in the custody or possession of the CTU. That emphasis does not reduce and should not obscure the fundamental responsibility of the shipper for the safe and secure stuffing and sealing of the CTU. Each party in possession of the CTU has security responsibilities while cargo is entrusted to them, whether at rest at a terminal or while moving between terminals.

2.1.2 Those responsibilities include:

- protecting the physical goods from tampering, theft, and damage;
- preventing illegal entry to guard against carriage of illicit goods and migrants;
- providing appropriate information to government authorities in a timely and accurate manner for security screening purposes<sup>†</sup>; and
- protecting the information related to the goods from tampering and unauthorized access. This responsibility applies equally to times before, during and after having custody of the goods.

2.1.3 Seals are an integral part of the chain of custody. The proper grade and application of the seal is addressed below. Where fitted, seals should be inspected by the receiving party at each change of custody for a packed CTU.

2.1.4 Inspecting a seal requires visual check for signs of tampering, comparison of the seal's identification number with the cargo documentation, and noting the inspection in the appropriate documentation. If the seal is missing, or shows signs of tampering, or shows a different identification number than the cargo documentation, then a number of actions are necessary:

---

\* As described in the WCO SAFE Framework of Standards, June 2011.

† This responsibility only refers to CTUs engaged in international transport.

2.1.4.1 The consignee should bring the discrepancy to the attention of the carrier and the shipper. The consignee should also note the discrepancy on the cargo documentation and notify Customs or law enforcement agencies, in accordance with national legislation. Where no such notification requirements exist, the consignee should refuse custody of the CTU pending communication with the carrier until such discrepancies can be resolved.

2.1.4.2 Seals may be changed on a CTU for legitimate reasons. Examples include inspections by: an exporting Customs administration to verify compliance with export regulations; by a carrier to ensure safe blocking and bracing of the shipment; by an importing Customs administration to confirm cargo declarations; and by law enforcement officials concerned with other regulatory or criminal issues.

2.1.4.3 If public or private personnel duly authorized remove a seal to inspect the shipment, they should install a replacement that is of the same or higher seal classification as defined in the standard ISO 17712 as the removed seal, and note the particulars of the action, including the new seal number, on the cargo documentation.

## **2.2     *Packing facility***

2.2.1 The shipper is responsible for packing and securing the cargo within the CTU, for the accurate and complete description of the cargo and for verifying the mass of the packed CTU. Where required, the shipper is also responsible for affixing the cargo seal immediately upon the conclusion of the packing process, and for preparing documentation for the shipment, including the seal number.

2.2.2 Where required for international transport, the seal should be compliant with the definition of high-security mechanical seals in the standard ISO 17712. The seal should be applied to the CTU in a manner that avoids the vulnerability of the CTU door handle seal location to surreptitious tampering. Among the acceptable ways to do this are alternative seal locations that prevent swivelling of an outer door locking cam or the use of equivalent tamper evident measures, such as cable seals across the door locking bars.

2.2.3 The land transport operator picks up the CTU. The transport operator receives the documentation, inspects the seal and notes the condition on the documentation, and departs with the CTU.

## **2.3     *Intermediate terminal***

If the CTU movement is via an intermediate terminal, then the land transport operator transfers custody of the CTU to the terminal operator. The terminal operator receives the documentation and should inspect the seal and note its condition on the documentation. The terminal operator may send an electronic notification of receipt (status report) to other private parties to the shipment. The terminal operator prepares or stages the CTU for its next movement, which could be by road, rail or barge. Similar verification and documentation processes take place upon pickup or departure of the CTU from the intermediate terminal. It is rare that public sector agencies are involved in or informed about intermodal transfers at intermediate terminals.

## **2.4     *Marine terminal***

2.4.1 Upon arrival at the loading ocean terminal, the land transport operator transfers custody of the CTU to the terminal operator. The terminal operator receives the documentation and may send an electronic notification of receipt (status report) to other private parties to the shipment. The terminal operator prepares or stages the CTU for loading upon the ocean vessel.

2.4.2 The carrier or the marine terminal as agent for the carrier should inspect the condition of the seal, and note it accordingly; this may be done at the ocean terminal gate or after entry to the terminal but before the CTU is loaded on the ship. Public agencies in the exporting nation review export documentation and undertake necessary export control and provide safety certifications. The Customs administrations that require advance information receive that information, review it, and either approve the CTU for loading (explicitly or tacitly) or issue "do not load" messages for CTUs that cannot be loaded pending further screening, including possible inspection.

2.4.3 For those countries that have export declaration and screening requirements, the carrier should require from the shipper documentation that the shipper has complied with the relevant requirements before loading the cargo for export (the shipper is, however, responsible for compliance with all prevailing documentation and other pertinent export requirements). Where applicable, the ocean carrier should file its manifest information to those importing Customs agencies that require such information. Shipments for which "do-not-load" messages have been issued should not be loaded on board the vessel pending further screening.

## **2.5 *Transshipment terminal***

The transshipment terminal operator should inspect the seal between the off-loading and reloading of the CTUs. This requirement may be waived for transshipment terminals which have security plans that conform to the International Ship and Port Facility Security Code (ISPS Code).

## **2.6 *Off-loading marine terminal***

2.6.1 The consignee usually arranges for a Customs broker to facilitate clearance of the shipment in the off-loading ocean terminal. Generally, this requires that the cargo owner provide documentation to the broker in advance of arrival.

2.6.2 The ocean carrier may provide advance electronic cargo manifest information to the terminal operator and to the importing Customs administration as required. Customs may select CTUs for different levels of inspection immediately upon off-loading or later. Customs may inspect the condition of the seal and related documentation in addition to the cargo itself. If the CTU is to travel under Customs control to another location for clearance, then Customs at the off-loading terminal should affix a Customs seal to the CTU and note the documentation accordingly.

2.6.3 The consignee or Customs broker pays any duties and taxes due to Customs and arranges the Customs release of the shipment. Upon pickup for departure from the ocean terminal, the land transport operator inspects and notes the condition of the seal, and receives documentation from the terminal operator.

## **2.7 *Intermediate terminal***

The processes in intermediate terminals in the importing country are analogous to those in intermediate terminals in exporting countries.

## **2.8 *Unpacking facility***

2.8.1 Upon receipt of the CTU, the consignee inspects the seal and notes any discrepancy on the documentation. The consignee unpacks the CTU and verifies the count and condition of the cargo against the documentation.



2.8.2 If there is a shortage, damage, or an overage discrepancy, it is noted for claims or insurance purposes, and the shipment and its documentation are subject to audit and review. If there is an anomaly related to narcotics, contraband, stowaways or suspicious materials, the consignee Customs or another law enforcement agency should be informed.

### **3 Seal types**

#### **3.1 Mechanical seals\***

##### **3.1.1 Introduction**

3.1.1.1 The choice of seal for a specific requirement will depend on many factors. It should be selected after full consideration of the user's performance requirements. The first decision is the appropriate seal classification (indicative, security or high security), followed by a decision on a particular type, make and model.<sup>†</sup> The seal purchaser should require from the seal vendor a certification of the seal's classification in accordance with the standard ISO 17712.

3.1.1.2 In general terms, a low strength indicative seal should be used where only indication of entry is desired. Where a physical barrier is a definitive requirement either a security or high-security seal should be used.

3.1.1.3 All seals should be easy to fit correctly on the item to be sealed and once in situ be easy to check for positive engagement of the locking mechanism(s). Correct handling and fitting of seals is at least equal if not greater in importance than selection of the correct seal. A poorly chosen but correctly fitted seal may provide security; however, a well\chosen but incorrectly fitted seal will provide no security.

3.1.1.4 Security and high-security seals should be sufficiently durable, strong and reliable so as to prevent accidental breakage and early deterioration (due to weather conditions, chemical action, vibration, shock, etc.) in normal use.

##### **3.1.2 Marking**

3.1.2.1 Seals should be identified by unique marks (such as a logotype) and unique numbers that are readily legible; markings intended for unique identification of the seal should be considered permanent. All seals should be uniquely numbered and identified. The name or logo of the manufacturer or private label holder should be evident on every seal.

3.1.2.2 Seals meeting the relevant criteria should be marked or stamped in a readily legible way to identify their classification as indicative ("I"), security ("S"), or high-security ("H") seals. Any modification of markings should require obvious irreversible physical, chemical, heat or other damage to or destruction of the seal.

---

\* ISO 17712 Freight Containers – Mechanical Seals.

† Selection of a seal presumes the user has already considered the condition of the item to be sealed; some items, such as open flat or flat rack CTUs, are not suitable for any seal on the CTU itself. A seal is only one element in a security system; any seal will only be as good as the system into which it is introduced.

### 3.1.3 Identification marks

3.1.3.1 Regulatory authorities and private customers may require identifiers that go beyond the requirements of the International Standard, such as in the following cases:

- seals intended for use on CTUs moving under customs laws should be approved or accepted and individually marked as determined by the relevant customs organization or competent authority;
- if the seal is to be purchased and used by customs, the seal or fastening, as appropriate, should be marked to show that it is a customs seal by application of unique words or markings designated by the Customs organization in question and a unique identification number;
- if the seal is to be used by private industry (i.e. a shipper, manufacturer or carrier), it should be clearly and legibly marked and uniquely numbered and identified. It may also be marked with a company name or logo.

### 3.1.4 Evidence of tampering

Seals may be designed and constructed so that tamper attempts create and leave evidence of that tampering. More specifically, seals may be designed and manufactured to prevent removal or undoing the seal without breaking, or tampering without leaving clear visible evidence, or undetectable reapplication of seals designed for single use. This is a requirement for high-security seals in the standard ISO 17712.

### 3.1.5 Testing for seal classification

3.1.5.1 There are four physical test procedures, tensile, shear, bending, and impact. The impact procedure is performed twice at different temperatures.







3.1.5.2 The lowest classification for any sample on any test should define the classification for the seal being evaluated. To achieve a given classification, all samples should meet the requirements for that classification in all five tests.\*



Test	Test Criteria	Seal Classification		High Security	Security	Indicative
			Units	'H'	'S'	'I'
<b>Tensile</b>	Load to failure		kN	10.00	2.27	<2.27
<b>Shear</b>	Load to failure		kN	3.336	2.224	<2.224
<b>Bending</b>	Cycles to failure	Flexible Seals		501	251	<251
	Bending moment to failure	Rigid Seals	Nm	50	22	<22
<b>Impact</b>	Impact load	Low Temperature	J	40.68	27.12	<27.12
	Impact load	High Temperature	J	40.68	27.12	<27.12
	Drop height	Dead blow mass	m	1.034	0.691	0.346

\* The terms indicative, security and high security refer to the barrier capabilities of the seal (respectively, minimal, medium and meaningful barrier strength).

3.1.6 Types of mechanical seal

The diagram below show examples of the types of seals, however, it does not provide information regarding the classification of the seals. The seal purchaser should contact the seal vendor for information on the seal's classification in accordance with the standard ISO 17712.

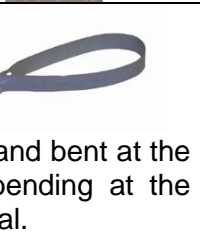
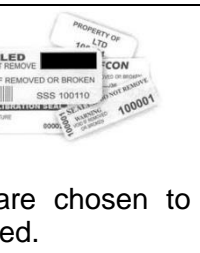
<p>Wire seal</p>	<p>Length of wire secured in a loop by some type of seizing device</p> <p>Wire seals include: crimp wire, fold wire and cup wire seals.</p> <p>NOTE The seizing device can be plastic or metal and its deformation is one indication of tampering.</p>	
<p>Padlock seal locking body with a bail attached</p>	<p>Padlock seals include: wire shackle padlock (metal or plastic body), plastic padlock and keyless padlock seals.</p> <p>NOTE The padlock itself is not an integral part of the CTU.</p>	
<p>Strap seal</p>	<p>Metal or plastic strap secured in a loop by inserting one end into or through a protected (covered) locking mechanism on the other end</p> <p>NOTE The seizing device can be plastic or metal and its deformation is one indication of tampering.</p>	
<p>Cable seal</p>	<p>Cable and a locking mechanism</p> <p>On a one-piece seal, the locking or seizing mechanism is permanently attached to one end of the cable.</p> <p>A two-piece cable seal has a separate locking mechanism which slips onto the cable or prefabricated cable end.</p>	
<p>Bolt seal</p>	<p>Metal rod, threaded or unthreaded, flexible or rigid, with a formed head, secured with a separate locking mechanism</p>	
<p>Cinch seal Pull-up seal</p>	<p>Indicative seal consisting of a thin strip of material, serrated or non-serrated, with a locking mechanism attached to one end</p> <p>NOTE The free end is pulled through a hole in the locking mechanism and drawn up to the necessary tightness. Cinch or pull-up type seals can have multiple lock positions. These seals are generally made of synthetic materials such as nylon or plastic. They can resemble, but are significantly different from, simple electrical ties.</p>	

Twist seal	Steel rod or heavy-gauge wire of various diameters, which is inserted through the locking fixture and twisted around itself by use of a special tool.	
Scored seal	Metal strip which is scored perpendicular to the length of the strip  NOTE The strip is passed through the locking fixture and bent at the score mark. Removal of the seal requires bending at the score mark which results in breakage of the seal.	
Label seal	Frangible seal consisting of a paper or plastic backing with adhesive  NOTE The combination of backing and adhesive are chosen to cause the seal to tear when removal is attempted.	
Barrier seal	Designed to provide a significant barrier to CTU entry  NOTE 1 A barrier seal can enclose a portion of the inner locking rods on a container. NOTE 2 Barrier seals can be designed to be reusable.	

**3.2 Electronic seals**

3.2.1 An electronic seal\* is described† as a read-only, non-reusable freight container seal conforming to the high-security seal defined in ISO 17712 and conforming to ISO 18185 or revision thereof that electronically evidences tampering or intrusion through the container doors.

3.2.2 Electronic seals can communicate either passively or actively with readers and other communication devices. The passive electronic seal relies on a signal from a reader to activate a response from the electronic seal while an active electronic seal is fitted with a battery and transmits a signal that can be interrogated by a reader or a communication device.



Figure 9.1  
Electronic Seal

**3.3 Other devices**

3.3.1 Other devices such as sensors can report on the location of the CTU, condition of the cargo, and whether the CTU has been opened. This can be done in real time, when the CTU passes a communication portal or when the device data is downloaded.

3.3.2 Such devices are usually fitted by shippers on their, or the consignee's, behalf.

\* Also known as eSeals, and RFID tags.

† ISO 18185-1:2007 Freight containers – Electronic seals – Part 1 communication protocol.

### 3.4 Sealing CTUs

#### 3.4.1 Introduction

3.4.1.1 Closed units used in each of the transport modes have similar securing methods. Box type CTUs with doors at the rear will have either vertically hinged swing doors, sliding, drop down door / ramp, or roller shutter doors.



Figure 9.2 Swing door (Road vehicle)



Figure 9.3 Sliding door (Rail Wagon)



Figure 9.4 Roller Shutter (Swap Body)

3.4.1.2 The different types of CTUs offer different door closing gear, swing doors can be fitted with two or one locking bars per door which can be surface mounted or enclosed in the door structure and the locking handle can be in the bottom quarter of the door or below the doors.

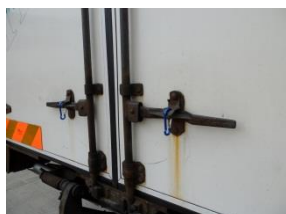

Figure 9.5 Surface mounted handles



Figure 9.6 Roller shutter lock



Figure 9.7 Recessed handled with protruding eyes

3.4.1.3 All the door locking devices work on two principles. A seal can either:

- be passed through the handle and secured against a fixed item on the CTU (see figures 9.5 and 9.6); or
- be passed through a fixed eye protruding from the CTU and projecting through the handle (see figure 9.7).

3.4.1.4 Very often the choice for fixing the seal is obvious and where there are two or more handles generally the one that operates the inner lock rod of the right hand door should be sealed. Some handles do not have apertures for seals,\* while some CTUs will have multiple apertures suitable for seals.



Figure 9.8 Handle without aperture

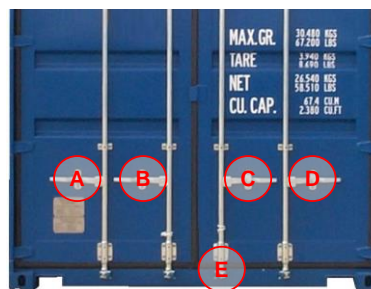

Figure 9.9 Multiple apertures

\* Generally left hand door handles.

3.4.1.5 In figure 9.9 the first choice should be at 'E' or 'C' (inner lock rod right hand door) and for additional security position 'B' (Inner lock rod left hand door). Where the CTU is involved in international transport, a high-security bolt seal fitted at position 'E' provides the most secure solution especially for fitting and removal when a container is on a trailer.

3.4.1.6 The decision whether to seal the CTU and the choice of seal to be used will depend on the shipper, the value of the cargo, the type of CTU and the route. For CTUs that are making a number of stops to unpack one or more packages a clip may be sufficient. Single drop off trips may require an indicative seal. However, CTUs destined for international transport should be sealed with a high-security seal.

### 3.4.2 Dry bulk CTUs

3.4.2.1 Units designed to carry a dry bulk cargo may have a number of loading and discharge hatches. Depending on the design there may be many loading hatches in the roof and one or more discharge hatches incorporated into the rear doors or in the front wall.

3.4.2.2 Each of the arrowed locations in figure 9.10 will require sealing. Figures 9.12 and 9.13 show discharge hatch sealing points. Figure 9.11 shows an internal slide bolt to a loading hatch in the roof of the CTU that can lock the hatch closed when the CTU is not being used to transport a cargo that requires loading from above.



Figure 9.10 Dry bulk sealing points



Figure 9.11 Roof hatch internal lock



Figure 9.12 Dry bulk discharge hatch (rear)



Figure 9.13 Dry bulk discharge hatch (front)

### 3.4.3 Tank CTUs

3.4.3.1 Like CTUs for dry bulk cargoes, tank containers and trailers may have multiple openings for loading and discharging.

\* The security cam type fitting is not fitted to all CTU.



3.4.3.2 The loading hatches in tank containers are generally secured using a number of wing nuts tightening round the manway hatch. The seal is fitted through a tang fitted to the rim plate and the hatch seal fitting.



Figure 9.14 Manway hatch seal

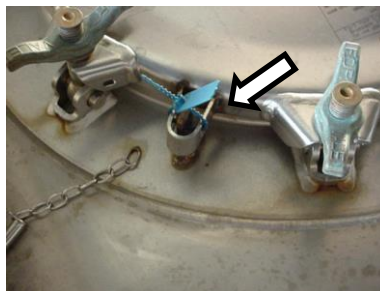

Figure 9.15 Seal tab

3.4.3.3 Top valves in tank containers may also need to be sealed, some have wires welded to the fixing nuts, while others will be sealed in the closed position.



Figure 9.16 Top valve seal



Figure 9.17 Discharge valve seal

3.4.3.4 The discharge valve on many tanks may have one or two valves plus a closing cap. It is possible to seal all of these, however, the best sealing position is the main butterfly type valve. There the handle is sealed to the adjacent tank.

#### 3.4.4 Open sided units

3.4.4.1 The World Customs Organization defines all sheeted CTUs as open units.

3.4.4.2 There are two basic designs of sheeted attachment:

- "Tautliner" where there are buckles used to tension the straps and the side sheet. Each buckle will have a hole through which the TIR cord will be passed (see figure 9.18); the TIR cord may be secured with a sealing device at each end;
- the second design has eyes that are placed over rings and the TIR cord is passed through the rings (see figure 9.19); this design is most often used with open sided and open top containers.



Figure 9.18 Tautliner clip

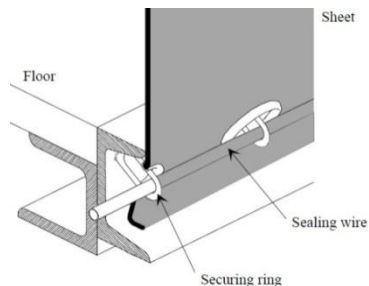

Figure 9.19 TIR wire fitting

3.4.4.3 The tautliner buckles do not require the TIR cord to be in place to close the curtain, whereas the ring and eye design requires the cord or else the curtain or top tarpaulin/tilt may easily detach.

### 3.4.5 Open Top CTUs

3.4.5.1 In addition to the doors of an open top container the flexible top covering, when required and upon the completion of packing, should be sealed.

3.4.5.2 On arrival of the open top CTU, the packer should check that the top sheet appears to be in good condition with no holes or tears in the material. Patches are permitted so long as there are two visible seams attaching the patch to the sheet and there are no cut edges visible on the patch material and the sheet under the patch.



Figure 9.20 Open Top CTU

3.4.5.3 There should be removable or re-locatable roof bows fitted to all the sockets or pins to support the sheet when in place.

3.4.5.4 The TIR Convention requires that sheeted vehicles (including open top containers) be fitted with a strong canvas or plastic-covered or rubberized cloth\*, of sufficient strength, in good condition and made up in such a way that once the closing devices has been secured, it is impossible to gain access to the load compartment without leaving obvious traces.

3.4.5.5 The sheet should be affixed to the CTU by the following system:

- .1 metal rings fixed to the CTU;
- .2 eyelets let into the edge of the sheet; and
- .3 a fastening passing through the rings above the sheet and visible from the outside for its entire length.†

3.4.5.6 The fastening may be of the following specification:

- .1 steel wire rope of at least 3 mm diameter;
- .2 ropes of hemp or sisal of at least 8 mm diameter encased in a transparent sheath or un-stretchable plastic; or
- .3 rope consisting of batches of fibre-optic lines inside a spirally wound steel housing encased in a transparent sheath of un-stretchable plastic; or

\* Often referred to as a "Tilt"

† On open top containers the design of the rear frame may prevent the sheet from being passed over onto the vertical rear face of the header, therefore the requirement for the rings to be visible is not possible.



- .4 ropes comprising a textile cord surrounded by at least four strands consisting solely of a steel wire and completely covering the core, under the condition that the ropes (without taking account the transparent sheath, if any) are not less than 3 mm in diameter.

3.4.5.7 In practice most open top containers are supplied with a steel wire rope encased in an un-stretchable plastic sheath.

3.4.5.8 Each type of fastening rope should be in one piece and should have a hard metal end-piece at each end. Each metal end-piece should allow the introduction of the thread or strap of a customs seal (see figure 9.21 below).

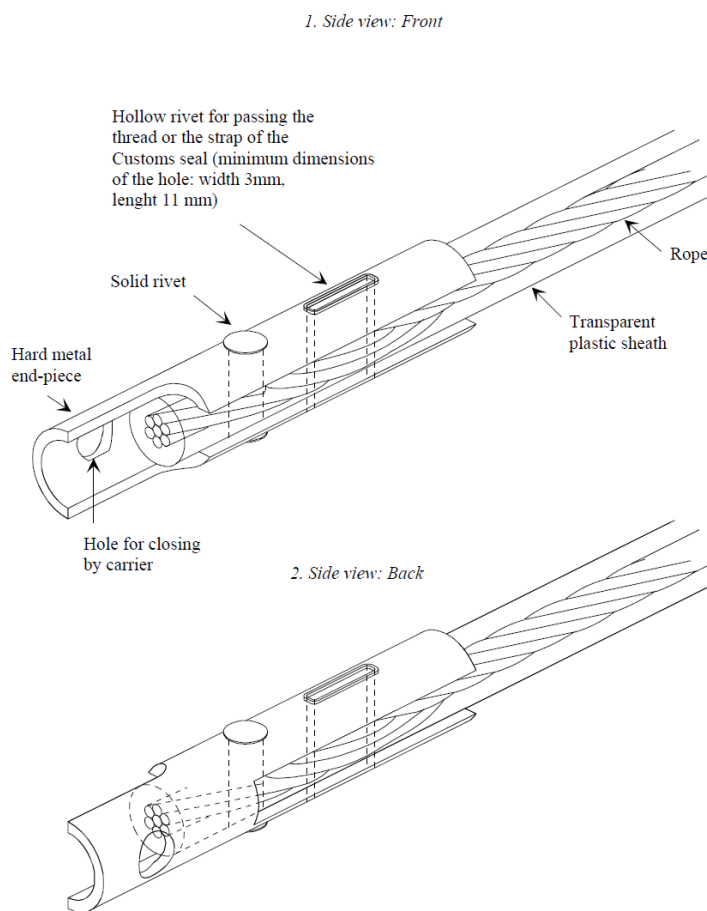

3.4.5.9 On completion of packing the roof bows should be refitted and the sheet placed over the container making sure that all eyelets in the sheet are placed over a ring fitted on the CTU.

3.4.5.10 The fastening rope should then be passed through every ring on the outside of the sheet starting above the fastening rope retaining bracket or brackets, often found on the right side of the container towards the rear end. The fastening rope should be long enough so that the hard metal end-piece can be brought back to the retaining bracket.



Figure 9.22 Fastening rope threading on Open Top CTU

3.4.5.11 The fastening rope should be tight to prevent edges of the sheet from being lifted.

3.4.5.12 Any additional length of the fastening rope should be restrained so that it cannot be slid out to loosen the securing of the sheet.

3.4.5.13 A seal should be inserted through both hollow rivets of the metal end-pieces. Additional closures may be used to connect the two end-pieces through the round holes.

### 3.4.6 Fitting seals

3.4.6.1 There have been a number of designs for the handle retainers and catches, but generally there are two generic designs in use illustrated in figures 9.23 and 9.24.

3.4.6.2 Figure 9.23 shows a design where the lock rod handle is attached to the catch which in turn is attached to the container using a rivet. As the catch has to rotate there is always a small gap between the catch and the retainer.

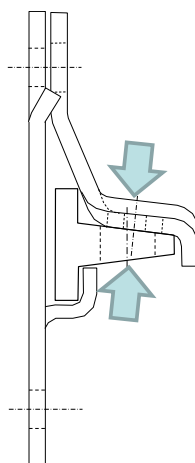

Figure 9.23 2 point seal

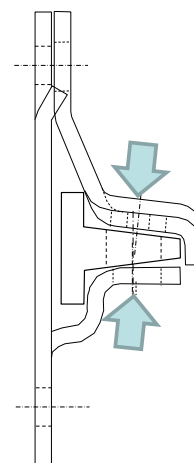

Figure 9.24 3 point seal

3.4.6.3 Figure 9.24 has the seal passing through the catch, the handle and a fixed arm on the retainer. This design means that there the seal is directly attached to the retainer and to remove the seal would require the seal or the retainer to be damaged. The type of handle, handle retainer and catch can also affect the security of the doors.

3.4.6.4 Before fitting the seal record the number of the CTU and the number(s) of the seal(s) to be fitted and where each is used (Right hand door inner cam keeper, rear hatch etc.).

3.4.6.5 Push the seal through all elements of the retainer, handle and clip and snap the two halves together.



Figure 9.25 Fitting a bolt seal

3.4.6.6 Once the seal has been fitted, give the bottom a number of sharp tugs and twist the two components to confirm that the seal is fully and properly engaged.

### 3.4.7 Cutting seals

3.4.7.1 The following four pictures show various seals and the tools normally associated with cutting them. Indicative and security cable seals (figure 9.26) can be generally cut with cable cutters or small bolt cutters. High security cable seals (figure 9.27) and twist seals (figure 9.29) generally require 24 in (600 mm) cable or bolt cutters.



Figure 9.26 Cable seals



Figure 9.27 High-security Cable seals



Figure 9.28 Cutters for cable seal



Figure 9.29 Cutters for twist seal

3.4.7.2 The design of cable cutters shearing edges (figure 9.28) are such that the cable seal strands are captured during the cutting process which prevents strands from becoming separated from the cable.

3.4.7.3 Cable seals use Non Preformed Cable, that frays wildly when cut. Figure 9.30 shows two examples where cable seals have been cut, both have frayed. Cable seals are supplied with the cable permanently attached to one lug, in the case of the picture they are the lower lugs in both examples. The loose end of the cable is passed through the upper lug and crimped closed.

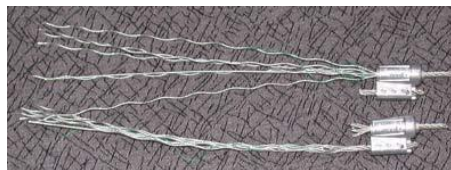

Figure 9.30 Cut cable seals

3.4.7.4 In the top example the cable has been cut correctly, only a small length of cable remains staked (permanently attached) to the seal, whereas the bottom example has been cut too close to the bottom lug.

3.4.7.5 Bolts should be cut as close to the lock body as possible. The left hand bolt in figure 9.31 was cut close to the lock body and is unlikely to present a risk to walkers or vehicles as it is not likely to roll point upwards.



Figure 9.31 Cut bolt seal – stems



Figure 9.32 Cut bolt seals – head

### 3.4.8 Cutting tools

3.4.8.1 High-security bolt seals (figure 9.33) are generally the hardest to cut and will often require 36 in (900 mm) cutters. 42 in bolt cutters are considered too heavy\* for this operation and should not be used.



Figure 9.33 Typical bolt seal



Figure 9.34 Bolt cutters



Figure 9.35 42in bolt cutter

\* In general hand held tools should not exceed 2 kg if operated by one hand and 5 kg for two hands. Bolt cutters with long handles also exert considerable strain on wrists. 42 in bolt cutters can easily weigh 8 kg or higher and some 36 in cutters may weigh up to 7 kg.



3.4.8.2 Figure 9.36 shows a version of the bolt seal seen previously. It satisfies all the minimum test requirements for the seal to be designated as "High Security". However, the shear strength is very high and cannot normally be cut with a bolt cutter.



Figure 9.36 Rail car bolt seal and breaking tool

3.4.8.3 Bolt cutters are assemblies of four or five linked levers which magnify the force applied at the handles via the fulcrum and into the shearing blades that cuts through the seal

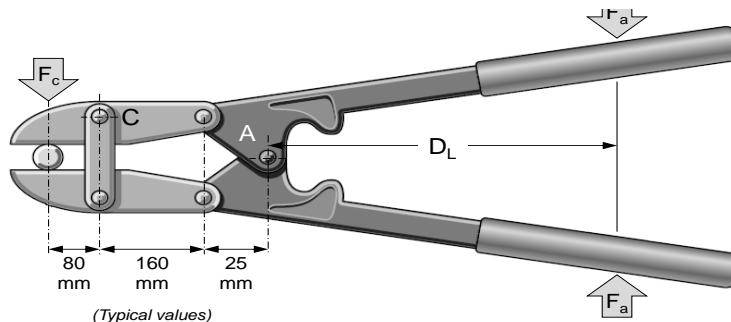

Figure 9.37 Bolt cutter schematic

shaft. The fulcrum is point A in figure 9.37 with a lever length  $D_L$ .

3.4.8.4 The length shown as  $D_L$  in the diagram below dictates the force that can be applied ( $F_c$ ). Bolt cutters with 900 mm long handles would need an applied force of 46 N to cut a bolt seal with shear value of 3.336 kN. Cutters with 600 mm long handles would require a force of 70 N to cut the same bolt.

3.4.8.5 As an indication, the force that can be applied by an average fit man "squeezing" the arms inwards is approximately 70 N. Therefore, many people may find attempting to cut a high-security bolt seal with cutters with handles 600 mm or shorter will not be able to cut through solid bolts without excessive force applied at the handles which may result in injury.

3.4.8.6 Operators who open CTUs with high security seals regularly may wish to use a mechanical bolt cutter. Figures 9.38 and 9.39 show the hydraulic cutting head and pump of a high volume bolt cutter. Figure 9.40 shows a battery operated hand held cutter. Similar designs are available.



Figure 9.38 Hydraulic cutting head



Figure 9.39 Hydraulic pump and controller



Figure 9.40 Battery operated bolt cutter

3.4.8.7 When cutting seals, an operator should be standing on a level stable surface and using appropriate personal protective equipment (PPE).

**INFORMATIVE MATERIAL 10****TESTING CTUS FOR HAZARDOUS GASES****1 Introduction**

1.1 The risk of "hazardous gases in CTUs" is relevant to all companies that handle CTUs, such as distributors, warehouses, wholesalers, transport companies, importers, retailers and manufacturing companies. It includes both acts that fall within the internal business processes (manufacturing), and actions performed on behalf of third parties (service providers and logistics companies).

1.2 Hazardous gases in CTUs can come from:

- .1 deliberately adding gases to prevent decay and deterioration of the load or CTUs by pests;
- .2 the evaporation of substances used in the manufacture of products or dunnage;
- .3 (chemical) processes in the cargo.

1.3 In addition, incidents can occur through leakage of CTUs with hazardous substances. Several substances are often found simultaneously in CTUs.

**2 An example of a possible action plan for checking for hazardous gases\***

2.1 This action plan focuses on employees of companies, involved in opening and unpacking of CTUs. Wherever this action plan refers to 'the company', it refers to the company, not necessarily the ultimate consignee, with responsibility and authorization for opening and unpacking the CTU, which can occur at different points in the supply chain.

2.2 The action plan "Safe handling of gases in CTUs" includes a policy process and an operational process. The policy process indicates how a company can design a policy to deal safely with gases in CTUs. The operational process leads to the "safe" opening and entering of CTUs.

2.3 At the end of the description of the process steps, the activities, the moments of choice and the required information may be presented in flowcharts.

2.4 The action plan consists of the following steps:

- the drawing up of a company policy;
- taking delivery of CTUs;
- measurement survey;
- measures;
- safe opening and entering of CTUs;
- registration.

---

\* Any action plan should be developed in accordance with the company's business model and its role in the supply chain.

### **3 Possible action plan structure**

#### **3.1 Step 1 – Drawing up of a company policy**

3.1.1 The company should gather information about the CTU issue and the chain approach. Then an inventory of the CTUs to be received, their cargo and origin should be made. These are referred to as CTU flows. Finally the company should draw up a risk profile for every CTU flow.

3.1.2 Based on this preliminary examination, the CTUs should be assigned to one of the following categories. This category classification determines the further processing of the CTU (flow):

3.1.2.1 Category A: The CTU contains hazardous gases. The gases in question and their expected concentration are known.

A CTU falls into category A if, based on available information, e.g. a previous measurement survey, analysis of the CTU flow and the shipping documents – it has been determined which harmful substances are to be found. In such a case, there is a homogenous CTU flow. Upon receipt of the CTUs, random controls (incl. measurement survey) should be carried out to determine that no changes have occurred in the supply chain.

3.1.2.2 Category B: It is not known if the CTU contains hazardous gases.

A CTU falls into category B if it is not known whether the CTU contains hazardous gases. That would apply for every CTU that is not part of a homogeneous CTU flow and that cannot be shown to belong to category A or C.

3.1.2.3 Category C: The CTU does not contain any hazardous gases.

A CTU falls into category C if the following four conditions are met:

- the preliminary examination shows that the container flow cannot contain hazardous substances;
- there is a homogenous container flow;
- previous measurement research shows that no measurable hazardous gases have been found in this container flow and the data are statistically sound;
- upon receipt of the CTUs, random controls (incl. gas measurements) confirm that no changes have occurred in the chain.

Based on the preliminary examination, the company should draw up a company policy regarding container gases, a company procedure and an employee-training programme. Where possible, the company should arrange with other companies that are part of the same logistics chain to limit or manage the risks when opening and entering the CTUs.

The company should periodically evaluate its policy "Safe handling of gases in CTUs". Reasons for adjustment of the policy may include:

- (abnormal) readings;
- incidents;

- changes in current knowledge and legislation;
- changed agreements with chain partners.

### **3.2 Step 2 – Receiving CTUs**

A company that receives CTUs should have verified in step 1 to which category a CTU belongs. Once the category has been determined, the CTU should be dealt with according to the corresponding procedure:

- Operational Process: category A CTUs;
- Operational Process: category B CTUs;
- Operational Process: category C CTUs.

The action plan and the procedures described in the operational process should not distinguish between different origins of the hazardous substances that are present.

### **3.3 Step 3 – Measurement survey**

3.3.1 A gas measurement expert should set up a measuring strategy and carry out the measurement survey. The company may outsource the measurement. The gas measurement expert should be properly trained and keep his or her knowledge and skills up to date. The gas measurement expert should record the measurement results, the findings (in relation to the acceptable limit<sup>\*</sup>) and the recommendations in a measurement report. The recommendations should focus on:

- release of CTU, with or without conditions<sup>†</sup>;
- ventilation / degassing of the CTU.

#### **3.3.1.1 Category A CTUs:**

The first consideration should be to check whether a limited or an extensive measurement survey should take place. In a limited survey only the hazardous substances are measured on the basis of a previous measurement survey. However, the company should be able to demonstrate its assumptions. If the assumptions are not correct, the CTU flow should no longer belong to category A, but to category B.

For a category A CTU, based on available data, it may be decided to carry out the measurement before or after ventilation.

The reading can lead to the following findings:

- The expected gases are not detected. Based on the preliminary examination, it should be assessed whether the classification in category A is correct;

---

<sup>\*</sup> The evaporation problem rarely concerns one single substance. Whoever carries out the measurement survey (gas measurement expert), applies the additional rule if necessary.

<sup>†</sup> One of these conditions can be the carrying out of repeat measurements during the entering of the shipping container.



- The expected gases are detected and the concentrations are below the limits. The concentration further within the CTU may be higher. A gas measurement expert should advise the company whether the CTU may be released or what additional measures, if any, should be taken (via step 4 to 5 described below);
- The expected gases are detected and the concentrations exceed the limits. The CTU should not be entered. Additional measures should be applied (via step 4 to 5 described below).

### 3.3.1.2 Category B CTUs:

A measurement survey should always be carried out on a CTU of category B. The reading may lead to the following findings:

- No gases are detected. The CTU may be released and may be opened and entered (via step 5 below);
- Gases are detected but the concentrations are below the limits. The concentration further within the CTU may be higher. A gas measurement expert should advise the company on whether the CTU may be released or what additional measures, if any, should be taken (via steps 4 and 5 below);
- The expected gases are detected and the concentrations exceed the limits. The CTU should not be entered. Additional measures should be applied (via step 4 to 5 described below).

### 3.3.1.3 Category C CTUs:

It is highly unlikely that the CTU from category C contains hazardous gases. However, the company should demonstrate this by randomly carrying out a measurement. If the spot check shows that the assumptions are correct, the procedure for a category C container is followed (step 5 below). If the assumptions are not correct, the container flow no longer belongs to category C but to category B.

## **3.4 Step 4 – Measures**

3.4.1 The company should take measures based on the results of step 3. Examples of such measures are:

- ventilation followed by new measurements;
- the removal of fumigant residues by trained personnel wearing appropriate personal protective equipment;
- unpacking by a specialized company.

## **3.5 Step 5 – Safe opening and entering of CTUs**

3.5.1 The company may release the CTU and it may be opened and entered if:

- .1 previous research shows the CTU is safe to enter (category C);

- .2 the gas measurement expert indicates in his recommendations that employees can safely open and enter the CTU (category A, B and C (spot check)); and
- .3 the history and knowledge of the CTU flow corresponds with the measurement results and the recommendations of the gas measurement expert (category A and C (spot check));

3.5.2 If a company releases a CTU, it should be able to demonstrate that it has done so on the basis of a documented action plan. At this stage, the company also should decide, after the gas measurement expert has submitted a recommendation, whether additional measures are needed during the unpacking process. The CTU may then be released subject to conditions defined by the expert.

3.5.3 The company should also carry out repeat measurements if the following situations have arisen or may arise:

- .1 intentionally fumigated CTUs where residues of pesticides or herbicides, such as magnesium or aluminium phosphide powder, are still present in the CTU;
- .2 if measurements taken through the door gaskets indicate the presence of hazardous substances at concentrations below the permissible limit(s). Practical experience has shown that, in such cases, the concentration inside the CTU can be higher;
- .3 if there is a possibility that the gas may concentrate beneath and/or inside the packages and may be released at a later stage;
- .4 if the CTU consists of more than one compartment;
- .5 if there is a possibility that a hazardous substance will be released as a result of damage to the packaging;
- .6 if a gas may evolve from the goods;
- .7 if the nature of the goods is such that it is difficult or impossible to degas them; and
- .8 if the gas measurement expert submits a recommendation to that effect.

3.5.4 Whenever a dangerous work situation arises all personnel should be withdrawn, the CTU closed and the adjacent area cordoned off. The company should determine the next steps which could be (see step 4):

- .1 (Renewed) Ventilation/degassing of the CTU;
- .2 Have the CTU unpacked by a specialized company. This can be at a specifically designed degassing location and/or unloading by specialized personnel; and
- .3 Continuous measuring during unloading and if necessary active ventilation.

**3.6 Step 6 – Registration**

3.6.1 The company should retain the data collected. These are:

- .1 registration of container flows and assignment to categories;
  - .2 measurement records; and
  - .3 measures taken.
-